

# RVH8633

UNDERMOUNT WORKSTATION SINK

**RUVATI**<sup>®</sup>  
SPECIFICATION SHEET

## MATERIAL

- True 16 Gauge Thickness
- Premium T304 Grade Stainless Steel
- Nano-PVD colored finish: easy to clean, and long lasting

## FEATURES

- Heavy duty sound guard padding and undercoating
- Embossed stainless steel with a hexagonal pattern and matte finish
- Single-Tier Ledge for Accessories



## IN THE BOX



Basket Strainer  
[RVA1025]

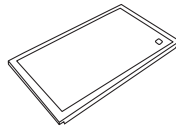

Cutting Board  
[RVA1217BWC]

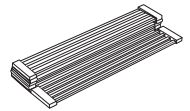

Folding Rack  
[RVA1397]



Cut-out  
Template



Drain Cover  
[RVA1035]

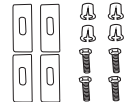

Mounting Clips  
[RVA11031]

## NOMINAL DIMENSIONS

Exterior: 33" (wide) x 19" (front-to-back)  
Interior Bowl: 31-3/8" (wide) x 16" (front-to-back)  
Bowl Depth: 10"  
Minimum Cabinet Size: 36" wide  
Drain Hole Size: 3 1/2"

**Installation Type:**  
Undermount

**Inside Corners:**  
Rounded

**Drain Location:**  
Rear Center

**RUVATI USA**

www.ruvati.com

Phone: 1.855.478.8284  
Email: support@ruvati.com

## OPTIONAL ACCESSORIES (SOLD SEPARATELY)



Deep Basket  
Disposal Flange  
[RVA1049ST]

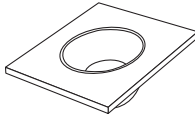

Mixing Bowl  
and Platform  
[RVA1288]

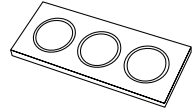

Condiment  
Serving Tray  
[RVA1377]

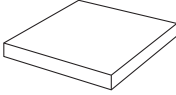

Butcher Block  
[RVA2445ACA]

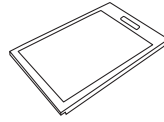

Black Plastic  
Cutting Board  
[RVA1217BLK]

## DIMENSIONS

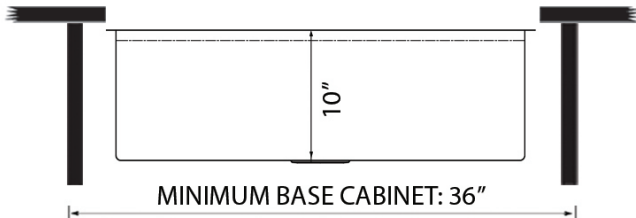
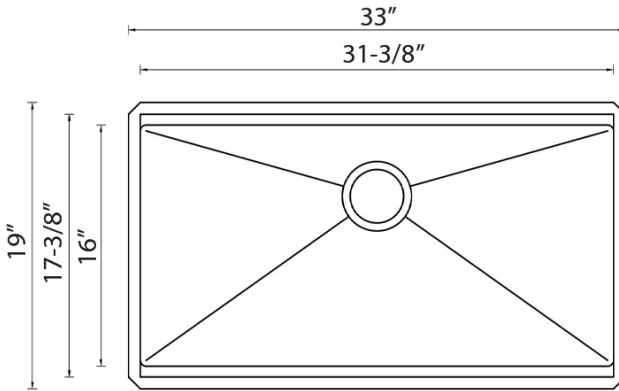

Register your product at [www.ruvati.com/register](http://www.ruvati.com/register).