

## Automotive Technology

### Module 1: Introduction to Automotive Technology

#### Student Reference

Technical  
Consultants:  
Ken Estes  
Robin Ferguson  
Steve Reese

Project  
Coordinator:  
Erica Kassel

Editor:  
Janis Levensen



Produced by the Instructional Materials Laboratory  
1400 Rock Quarry Center  
University of Missouri-Columbia  
Columbia, MO 65211  
(800) 669-2465

2006 Edition

Catalog no. 70-1801-S  
© 2006. The Curators of the University of Missouri.  
All Rights Reserved.

Graphic  
Artists:  
Chris Benedict  
Jacqueline Craig

---



# INTRODUCTION TO AUTOMOTIVE TECHNOLOGY

---

## ACKNOWLEDGMENTS

The 2006 revision of *Introduction to Automotive Technology* represents the Instructional Materials Laboratory's commitment to the continual improvement of the Automotive Technology Curriculum. *Introduction to Automotive Technology* is the first in the nine-module series. The other modules are as follows:

- Module 2     *Electrical Systems*
- Module 3     *Engine Performance, Section 1: Ignition Systems*
- Module 3     *Engine Performance, Section 2: Fuel and Exhaust Systems*
- Module 3     *Engine Performance, Section 3: Emission Control Systems*
- Module 4     *Engine Repair*
- Module 5     *Steering and Suspension Systems*
- Module 6     *Brakes*
- Module 7     *Manual Drive Train and Axles*
- Module 8     *Automatic Transmissions and Transaxles*
- Module 9     *Heating and Air Conditioning*

All modules are based on the National Automotive Technicians Education Foundation (NATEF) task list. For years the National Institute for Automotive Service Excellence (ASE) has set the professional standards for automotive technicians. A strong NATEF orientation makes the nine curriculum guides an effective tool for preparing students to enter the technologically advanced field of automotive technology.

IML gratefully acknowledges the important contribution of the advisory committee:

Roger Donovan, Illinois Central College, East Peoria, IL  
Ken Estes, Grand River Technical School, Chillicothe, MO  
Robin Ferguson, Kirksville Vocational Technical School, Kirksville, MO  
Sam Jeanrenaud, Lee's Summit, MO  
Keith Kendrick, John A. Logan College, Carterville, IL  
Steve Reese, Lewis and Clark Vocational Technical School, St. Charles, MO  
Ron Tuetken, Lewis and Clark Community College, Godfrey, IL  
John Walker, Hannibal Area Vocational Technical School, Hannibal, MO  
Rodney Wolken, Eldon Career Center, Eldon, MO



# INTRODUCTION TO AUTOMOTIVE TECHNOLOGY

---

## TABLE OF CONTENTS

Introduction .....	i
Title Page.....	i
Acknowledgments.....	iii
Components.....	vii
References .....	viii
<b>Unit I</b> <b>Careers in the Automotive Field.....</b>	<b>S 1</b>
Lesson 1: The Automotive Technology Career .....	S 5
<b>Unit II</b> <b>Safety.....</b>	<b>S 11</b>
Lesson 1: Protecting Yourself and Others in the Shop .....	S 15
Lesson 2: Shop Safety Features and Emergency Procedures .....	S 35
Lesson 3: Raising and Supporting Vehicles Safely .....	S 41
Lesson 4: Federal and State Hazardous Material Regulations .....	S 49
<b>Unit III</b> <b>Chemicals and Their Use .....</b>	<b>S 59</b>
Lesson 1: Solvents, Soaps, and Cleaning Solutions .....	S 63
Lesson 2: Lubricants and Specialty Chemicals.....	S 71
Lesson 3: Gases, Asbestos Dust, and Battery Acid .....	S 79
<b>Unit IV</b> <b>Basic Hand Tools .....</b>	<b>S 85</b>
Lesson 1: Types of Wrenches .....	S 89
Lesson 2: Types of Screwdrivers and Pliers.....	S 97
Lesson 3: Types of Hammers, Punches, and Chisels.....	S 103

---

# AUTOMOTIVE TECHNOLOGY

---

<b>Unit V</b>	<b>Specialty Tools, Fasteners, and Measuring Tools .....</b>	<b>S 107</b>
	Lesson 1: Specialty Tools .....	S 111
	Lesson 2: Fasteners .....	S 119
	Lesson 3: Measuring Tools .....	S 129
<b>Unit VI</b>	<b>Power Tools and Shop Equipment.....</b>	<b>S 135</b>
	Lesson 1: Power Tools .....	S 139
	Lesson 2: Shop Equipment .....	S 151
<b>Unit VII</b>	<b>Vehicle Information .....</b>	<b>S 161</b>
	Lesson 1: Service Information and Vehicle Identification.....	S 165
<b>Unit VIII</b>	<b>Customer Service .....</b>	<b>S 169</b>
	Lesson 1: Customer Service, Work Orders, and Vehicle Preparation .....	S 173

# INTRODUCTION TO AUTOMOTIVE TECHNOLOGY

---

## COMPONENTS

- I. **Objectives** – Each unit is based on objectives that state the measurable unit and specific behavioral or performance objectives that the student is expected to achieve. Because the objectives of the unit provide direction for the teaching-learning process, the teacher and student need a common understanding of the intent of the objectives.
- II. **Information Sheets** – Presented in outline format, the information sheets provide content essential for meeting the cognitive (knowledge) objectives in the unit. The student should study the information sheets before any class discussion or completion of the assignment sheets. The corresponding Student Reference page numbers appear in the upper corner of the Instructor Guide.
- III. **Assignment Sheets** – The assignment sheets allow the student to respond to cognitive questions in writing.
- IV. **Job Sheets** – The job sheets are designed to guide the student through various key tasks and provide a means for the instructor to evaluate a student's performance of the task.
- V. **Unit Tests** – The unit tests evaluate the student's knowledge of the material.
- VI. **Student Workbook and Student Test Packet Tracking Sheets** – These provide the instructor with an effective way to track student progress on the assignment sheets, job sheets, and unit tests.

## REFERENCES

Alliance of Automobile Manufacturers. [www.autoalliance.org](http://www.autoalliance.org).

"Aqueous Parts Cleaning." *Best Environmental Practices for Auto Repair*, November 1999. Environmental Protection Agency.

Automotive Lift Institute. [www.autolift.org](http://www.autolift.org)

"Battery Safety." National Ag Safety Database (NASD). [www.cdc.gov/nasd](http://www.cdc.gov/nasd).

Chrysler. [www.chrysler.com](http://www.chrysler.com).

Dodge. [www.dodge.com](http://www.dodge.com).

Duffy, James E. *Modern Automotive Technology*. Tinley Park, IL: The Goodheart-Willcox Company, Inc., 2000.

"Floor Cleanup." *Best Environmental Practices for Auto Repair*, November 1999. Environmental Protection Agency.

Ford Motor Company. [www.ford.com](http://www.ford.com).

General Motors. [www.gm.com](http://www.gm.com).

National Automotive Technicians Education Foundation (NATEF). [www.natef.org](http://www.natef.org).

National Institute for Automotive Service Excellence (ASE). [www.asecert.org](http://www.asecert.org).

*Occupational Outlook Handbook, 2006–07 Edition*. United States Department of Labor. Bureau of Labor Statistics. [www.bls.gov/oco](http://www.bls.gov/oco).

Screw Drive Systems. Sizes.com. [www.sizes.com](http://www.sizes.com).

Sunkin, Ed. "Trends and Traits of Today's Technicians: The 2001 Professional Automotive Technicians Survey." *Underhood Service*, March 2001.

Tobolt, William K, Larry Johnson, and W. Scott Gauthier. *Automotive Encyclopedia*. Tinley Park, IL: The Goodheart-Willcox Company, Inc., 2000.

United States Department of Labor, Occupational Safety and Health Administration. [www.osha.gov](http://www.osha.gov).

United States Environmental Protection Agency. [www.epa.gov](http://www.epa.gov).



# INTRODUCTION TO AUTOMOTIVE TECHNOLOGY

---

## UNIT I: CAREERS IN THE AUTOMOTIVE FIELD

### CONTENTS OF THIS UNIT

- I. Unit objective
- II. Lesson plan
  - A. Lesson 1: The Automotive Technology Career
    - 1. Information outline
    - 2. Assignment Sheet
      - a. AS1-L1-UI: Automotive Technology Field
- III. Unit I Test



# INTRODUCTION TO AUTOMOTIVE TECHNOLOGY

---

## UNIT I: CAREERS IN THE AUTOMOTIVE FIELD

After completing this unit, students will be able to identify some of the opportunities in the automotive field and various facts about the automotive technology career. Students will demonstrate mastery of the material by completing the assignment sheet and achieving a score of \_\_\_\_\_ on the Unit I Test.

### SPECIFIC OBJECTIVES

After completing the lesson in this unit, students should be able to:

#### Lesson 1

- I. Identify some of the opportunities in the automotive field.
- II. Identify the importance of training and how automotive technicians and training programs are certified.
- III. Identify job prospects in the automotive technology field.
- IV. Identify common methods used to pay automotive technicians.
- V. Identify other facts about working as an automotive technician.
- VI. Complete the assignment sheet on the automotive technology field (AS1-L1-UI).



# INTRODUCTION TO AUTOMOTIVE TECHNOLOGY

---

## UNIT I: CAREERS IN THE AUTOMOTIVE FIELD

### LESSON 1: THE AUTOMOTIVE TECHNOLOGY CAREER

- I. Opportunities in the automotive field
  - A. According to statistics from the U.S. Department of Labor, over 800,000 people in the United States are employed as automotive service technicians and mechanics.
    1. Most are employed in the following businesses:
      - a. Automotive repair and maintenance shops
      - b. Automobile dealers
      - c. Retailers and wholesalers of automotive parts, accessories, and supplies
    2. Others work in the following businesses or organizations:
      - a. Gas stations
      - b. Home and automotive supply stores
      - c. Automotive equipment rental and leasing companies
      - d. Federal, state, and local governments
    3. Over 16% own their own their own business.
  - B. Many job opportunities are available that relate directly and indirectly to the automotive technology field.



1. Opportunities directly related to automotive technology

- a. Automotive technician
- b. Automotive technician's apprentice
- c. Repair shop supervisor
- d. Exhaust and emissions technician
- e. Tune-up technician
- f. Service writer
- g. Mechanical unit repairer
- h. Technician in automotive manufacturing plants
- i. Air conditioning technician
- j. Engine technician
- k. Teacher or trainer

**NOTE:** Many graduates of automotive technology programs qualify to pursue a career as a teacher or trainer with little or no extra training required for an entry-level position.

- l. Diesel technician
- m. Bus inspector
- n. Tractor technician
- o. Parts salvager

2. Opportunities indirectly related to automotive technology

- a. Farm equipment technician
- b. Aircraft technician
- c. Office equipment service technician/service representative
- d. Machinist apprentice



# INTRODUCTION TO AUTOMOTIVE TECHNOLOGY

---

- e. Air conditioning and heating service apprentice
- f. Industrial machine maintenance technician
- g. Small engine technician
- h. Marine equipment technician
- i. Motorcycle technician

## II. Training and certification

A. Repairing and maintaining today's sophisticated vehicles requires knowledge in many diverse systems and technologically advanced areas.

1. The days of getting a job based on performing automotive repair as a hobby or tinkering in the garage are gone.
2. Most job opportunities require formal training in automotive technology in high school or a postsecondary school or college.

### B. Certifying organizations

1. As stated on their Web site, the National Institute for Automotive Service Excellence (ASE) is a nonprofit organization that aims to "improve the quality of vehicle repair and service through the testing and certification of repair and service professionals. "

- a. Automotive technicians can be certified in one or more of the eight areas below.
  - Brakes
  - Electrical/electrical systems
  - Engine performance
  - Suspension and steering
  - Automatic transmission and transaxle
  - Engine repair
  - Heating and air conditioning

- Manual drive train and axles
- b. To be certified, technicians must have at least 2 years of experience and pass an ASE written examination. They must retake the exam every 5 years to maintain their certification.
2. The National Automotive Technicians Education Foundation (NATEF), an arm of ASE, reviews training programs to ensure they are meeting ASE standards and staying up-to-date with the continuously changing automotive technology and repair methods.

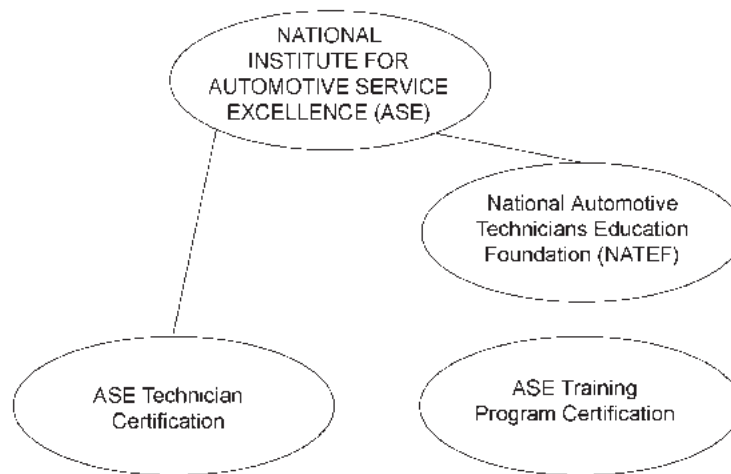

Source. [www.natef.org](http://www.natef.org)

- a. Training programs request the review process on a voluntary basis. If a program passes the review, NATEF recommends it to ASE for certification. Programs must be reviewed again every 5 years to be recertified.
  - b. In ASE's automobile specialty, training programs can be certified in the eight areas listed in 1a.
- C. To stay current with changes and advancements in the field, automotive technicians will need to attend training classes throughout their careers. Technicians may receive training at their workplace or may need to attend classes at a technical school or college.



# INTRODUCTION TO AUTOMOTIVE TECHNOLOGY

---

## III. Job prospects in the automotive technology field

- A. Prospects are very good for individuals with training and skills in diagnosis, problem solving, electronics, and mathematics. Knowledge in electronics has become crucial because most vehicle concerns involve working with or analyzing the electrical system. According to the Alliance of Automobile Manufacturers, “electronics now control more than 86% of all systems in a typical vehicle.”
- B. Many employers in the industry have reported that there is a shortage of automotive technicians and they have difficulty hiring individuals with education and experience in the areas desired.
- C. According to the *Occupational Outlook Handbook*, published by the U.S. Department of Labor, job opportunities for automotive technicians are expected to increase 9% to 17% through the year 2014. The growth will be due to the increased number of vehicles on the road and the loss of technicians because of retirement or advancement to specialized positions.
- D. Work for automotive technicians is generally steady throughout the year and not very sensitive to changes in economic conditions. Therefore, layoffs are not a big concern.

## IV. Common methods used to pay automotive technicians

- A. Hourly—The technician is paid for the time he or she puts in.
- B. Salary—A salary is a set amount of money, usually 40 hours per week, regardless of the volume of work performed.
- C. Flat rate—The technician is paid his or her hourly wage multiplied by the time listed for a specific job in a factory flat-rate manual or an aftermarket labor time guide. These guides are sometimes called parts and labor estimating guides. Technicians refer to these as “book hours.” The technician is paid this flat rate regardless of the time spent on a job.
- D. Hourly plus a percentage of labor and parts

## V. Other facts about working as an automotive technician

- A. Automotive technician’s use many different tools and equipment, including those in the following list. Technicians usually purchase their own hand tools, whereas the shop provides the more expensive power tools and equipment.

1. Common hand tools
  2. Power tools
  3. Machine tools
  4. Welding and oxyfuel cutting equipment
  5. Lifts and jacks
  6. Computers to perform administrative tasks and access service information
  7. Computerized diagnostic equipment
  8. Measuring tools
  9. Test instruments
  10. Other specialty tools, depending on the automotive technology area
- B. Some shops are unionized, which means that technicians employed there are subject to union rules regarding pay and other issues. For example, the technician may be required to work for 2 years as an apprentice before advancing to the journey level. The union also functions to help employees negotiate with their employers regarding salaries and working conditions.

# INTRODUCTION TO AUTOMOTIVE TECHNOLOGY

---

## UNIT II: SAFETY

### CONTENTS OF THIS UNIT

- I. Unit objective
- II. Lesson plans
  - A. Lesson 1: Protecting Yourself and Others in the Shop
    1. Information outline
    2. Assignment sheet
      - a. AS1-L1-UII: Work Safety in the Shop
    3. Job sheet
      - a. JS1-L1-UII: Identify Vehicles Equipped With a Supplemental Restraint System (SRS) and Antilock Brake System (ABS)
  - B. Lesson 2: Shop Safety Features and Emergency Procedures
    1. Information outline
    2. Assignment sheets
      - a. AS1-L2-UII: Safety Features and Emergency Procedures in the Shop
      - b. AS2-L2-UII: Shop Safety Inspection Checklist
  - C. Lesson 3: Raising and Supporting Vehicles Safely
    1. Information outline
    2. Assignment sheet
      - a. AS1-L3-UII: Lift and Support Vehicles
    3. Job sheet
      - a. JS1-L3-UII: Lift a Vehicle

D. Lesson 4: Federal and State Hazardous Material Regulations

1. Information outline

2. Assignment sheet

a. AS1-L4-UII: Hazardous Material Regulations

III. Unit II Test

# INTRODUCTION TO AUTOMOTIVE TECHNOLOGY

---

## UNIT II: SAFETY

### UNIT OBJECTIVE

After completing this unit, students should be able to identify various safety rules for personal safety in the shop, lifting and supporting a vehicle, and working with hazardous materials. They should also be able to identify safety features and emergency procedures in the shop. Students will demonstrate mastery of the material by completing the assignment sheets, successfully performing specific tasks on the job sheets, and achieving a score of \_\_\_\_\_ on the Unit II Test.

### SPECIFIC OBJECTIVES

After completing the lessons in this unit, students should be able to:

#### Lesson 1

- I. Identify who is responsible for safety in the shop.
- II. Identify federal agencies and guidelines for safe practices.
- III. Identify general shop safety rules.
- IV. Identify general safety rules for handling tools and equipment.
- V. Identify rules for electric welding safety.
- VI. Identify rules for oxyacetylene welding and cutting safety.
- VII. Identify rules for lifting heavy objects safely.
- VIII. Identify the personal protective clothing and equipment that is used in the shop.
- IX. Identify the importance of proper grooming and hygiene.
- X. Identify rules for using hazardous materials safely.
- XI. Identify safety precautions for supplemental restraint systems (SRSs) and antilock brake systems (ABSs).
- XII. Complete the assignment sheet on work safety in the shop (AS1-L1-UII).

XIII. Demonstrate the ability to:

- A. Identify vehicles equipped with a supplemental restraint system and antilock brake system (ABS) (JS1-L1-UII).

## **Lesson 2**

- I. Identify the safety features and equipment in the shop.
- II. Identify the importance of maintaining cleanliness and order in the shop.
- III. Identify emergency procedures used in the shop.
- IV. Complete the assignment sheet on safety features and emergency procedures in the shop (AS1-L2-UII).
- V. Complete the assignment sheet on a shop safety inspection checklist (AS2-L2-UII).

## **Lesson 3**

- I. Identify terms and definitions associated with lifting vehicles.
- II. Identify common lifting devices.
- III. Identify common support devices.
- IV. Identify principles of lifting and supporting vehicles.
- V. Complete the assignment sheet on lifting and supporting vehicles (AS1-L3-UII).
- VI. Demonstrate the ability to:
  - A. Lift a vehicle (JS1-L3-UII).

## **Lesson 4**

- I. Identify the requirements in OSHA's hazardous material regulations.
- II. Identify the requirements in the EPA's hazardous material regulations.
- III. Complete the assignment sheet on hazardous material regulations (AS1-L4-UII).

# INTRODUCTION TO AUTOMOTIVE TECHNOLOGY

---

## UNIT II: SAFETY

### LESSON 1: PROTECTING YOURSELF AND OTHERS IN THE SHOP

- I. Responsibility for safety
  - A. Safety in the automotive shop is the responsibility of everyone. Safety means protecting yourself and others from injury at all times. Working in the shop requires the use of a large variety of tools, materials, and equipment that can injure the worker and others in the shop if not properly handled.
  - B. Safety in the shop includes the items listed below.
    1. Following federal guidelines for safe practices
    2. Keeping the shop free of hazards
    3. Using protective clothing and equipment
    4. Handling and using materials containing potentially harmful chemicals correctly
    5. Using hand tools, power tools, and equipment correctly
    6. Following welding safety rules
- II. Federal guidelines for safe practices
  - A. Two federal agencies issue guidelines and oversee safety in the workplace.
    1. OSHA (Occupational Safety and Health Administration) issues guidelines concerning safety for the worker.
    2. The EPA (Environmental Protection Agency) issues guidelines concerning safety for the environment.
  - B. OSHA guidelines and EPA guidelines
    1. Each school will have a copy of OSHA and EPA guidelines that must be followed. Due to the changing nature of OSHA and EPA guidelines, the instructor will go over current guidelines with students. All students are required to follow OSHA and EPA guidelines.

2. OSHA guidelines concern the correct labeling of hazardous components of equipment, the correct storage of equipment and materials, the use of protective clothing and equipment, the placement of warning and safety signs, and general safety practices.
3. EPA guidelines concern proper handling, storage, and disposal of hazardous materials. They cover any materials that may be hazardous if released into the environment, including the environment of the shop.
4. See Lesson 4 for more information about these agencies.

### III. General shop safety rules

- A. During the course of working in the shop, an automotive technician moves from one area of the shop to another, moving parts and equipment around the shop and performing varied tasks. It is important that the shop floor be free of hazards that could cause technicians to slip or trip.
- B. In a wide variety of shop tasks, waste materials are produced that can cause dangerous situations unless the waste materials are disposed of or stored properly.
- C. Always be sure that shop exits are well-marked with an "EXIT" sign and are clear of obstructions.
- D. For personal safety and to help keep the shop free of hazards, always comply with the following safety rules.
  1. Work quietly and focus solely on the job at hand.
  2. Do not leave creepers laying on the floor. Always stand them against the wall, wheels outward, when not in use.
  3. Do not indulge in horseplay in the shop. Immature and improper behavior in the shop can cause serious accidents.
  4. Before performing a task, consider the relevant safety precautions related to the task and formulate a prevention plan for each hazard.
  5. Always wear protective clothing and equipment in any situation where it is necessary.



# INTRODUCTION TO AUTOMOTIVE TECHNOLOGY

---

6. Wear protective eyewear at all times in the shop area.

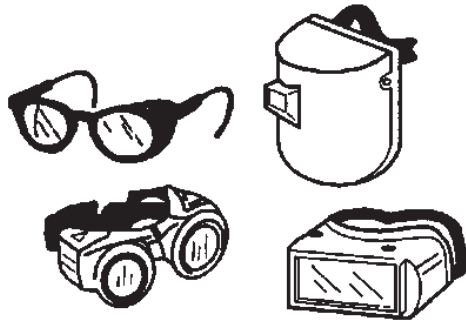

**NOTE:** The law requires that protective eyewear be available and worn in career and technical education courses where there is a reasonable probability of injury.



7. Do not wear rings, bracelets, watches, or necklaces when working around moving machinery or electrical equipment.
- Jewelry can catch in moving machinery with serious consequences.
    - A necklace can become entangled in running machinery, which could pull the technician into the machinery and cause great bodily harm.
    - If a ring or bracelet becomes entangled or caught, it could result in a severed finger or serious injury to the head or neck.
  - If a ring or bracelet should accidentally create a short circuit of a vehicle battery, the metal of the ring or bracelet could become white-hot in an instant, causing a serious burn.
8. Do not put sharp objects into the pockets of work clothes. They could cause personal injury or damage to a vehicle's interior.
9. Keep hands free from oil and grease.
10. Wipe up grease and other spills from the shop floor immediately, or at least put an oil-absorbing compound over them.
11. When cleaning up flammable liquids, always dispose of the rags in a metal container with a tight-fitting lid.

12. Do not look in the direction of another person who is welding.
13. Do not run a vehicle engine inside a closed garage unless the vehicle exhaust is hooked up to exhaust ventilation equipment. A deadly amount of carbon monoxide, which is present in the exhaust, can collect in a very short time.

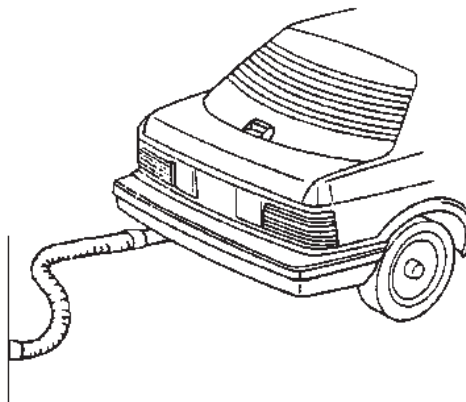

14. Do not smoke in the shop, except in an area designated for smoking.
15. When pumping a flammable liquid from a large container into a small one, be sure to first attach a ground wire between both containers.
16. Always be alert for hazardous situations in the shop. Promptly correct them, if possible, and inform the instructor of the situation.
17. If road testing a vehicle, always use seat belts, even if only going a short distance.
18. Disconnect the battery as appropriate. This eliminates hazards from shorts that could occur during repair procedures.



**CAUTION: The vehicle manufacturer's recommendations must be followed for disconnecting batteries. Some onboard vehicle computer systems can be damaged if the battery is incorrectly disconnected.**

19. When parts are removed from a vehicle, they should be stored away from the work area (on a bench or, if large parts, against a wall).

# INTRODUCTION TO AUTOMOTIVE TECHNOLOGY

---

20. Asbestos particles can cause cancer. Asbestos is found in brake shoes and clutches. Therefore, wear a particle mask when doing any cleaning work on brake or clutch parts. Do not use compressed air to clean brake or clutch parts.
  21. Do not let the leads on testing equipment fall into the fan of a vehicle while the engine is running. Electric fan motors can turn on even with the ignition off.
  22. Do not play with fire extinguishers. Use fire extinguishers only to extinguish fires.
  23. Always read the labels on chemicals and materials and follow the instructions.
- IV. General safety rules for handling tools and equipment
- A. Do not operate any piece of equipment unless trained in the use of the equipment.
  - B. Even if instructed in the use of a piece of equipment, do not use it unless given specific permission by the instructor.
  - C. Select the tool or piece of equipment that will handle the job in the safest and most efficient manner. Use tools or equipment only as recommended by the manufacturer.
  - D. Before using a tool or piece of equipment, inspect it for defects, missing or improperly adjusted safety guards, and any other missing or malfunctioning parts.
  - E. Maintain and store tools and equipment properly. Develop a regular maintenance schedule for shop equipment. Discard, repair, or replace worn tools because worn tools can be a safety hazard and adversely affect work quality.
  - F. Do not use compressed air to blow dirt from clothes and do not point a compressed-air hose at another person.
  - G. When using compressed air for cleaning objects in the shop, the air pressure must not be more than 30 pounds per square inch (psi).
  - H. Keep tools, especially tool handles, free from oil and grease.
  - I. Before using a tool, check the handle to make sure it is secure. For example, a hammer with a loose handle is unsafe because the head may fly off during use.

J. When operating electric tools, use the proper precautions to avoid electric shock.

K. Before inspecting or making adjustments to pneumatic or electric tools, always disconnect them from the air or power supply.

V. Electric welding safety

A. Protection from electric shock

1. Make sure the welder is installed and hooked up properly.
2. Do not use equipment that is damaged or defective, such as an electrode holder with damaged insulation.
3. Do not put the electrode holder in water to cool it.
4. Do not use water to extinguish an electrical fire or any fire near the welder.
5. Keep the work area, equipment, and clothing dry when using electric welders because even a slight amount of moisture can conduct enough electricity to cause a severe shock.

B. Protection from burns and fire

1. Make sure the work area is as fire resistant as possible.
2. Do not drag welding cables or hoses through dirt or oil, and do not pull on a cable to force it over an obstruction.
3. Take precautions when handling hot work pieces. Use tongs or pliers, not hands, to pick up hot metal.
4. Radiation from a welding arc is strong enough to sunburn or sometimes blister bare skin if the exposure is intense or for an extended period, so the arms, legs, and torso should be covered with durable, flame-resistant clothing.
5. Keep the work area clean and free of trash, grease, oil, and other flammable materials.
6. Keep a fire extinguisher, first-aid kit, and safety equipment within easy reach.
7. Do not drape an electric welding cable over any type of gas cylinder, and do not strike an arc on a gas cylinder.

# INTRODUCTION TO AUTOMOTIVE TECHNOLOGY

---

## C. Protection from arc rays

1. A welding arc produces ultraviolet and infrared radiation that can severely burn eyes that are unprotected with a proper shade of protective lens.

**NOTE:** A welding hood or helmet protects the head from flying sparks and the shaded lens protects the eyes.

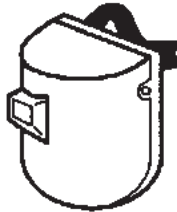

2. Make sure all others in the welding area are wearing eye protection as well.
3. When using a welder, enclose the welding area to protect others from the dangers of arc rays.

## D. Protection from toxic fumes and vapors

1. Many welding activities produce toxic fumes and vapors that are hazardous to breathe, and every work station should be equipped with a ventilation or exhaust system capable of safely removing dangerous and irritating smoke and contaminants.

**CAUTION:** Always position the head to the side of rising fumes.

2. In confined areas where the hazard of toxic fumes is increased, a welder should wear an air-supplied respirator or a self-contained breathing apparatus, not a filter-type mask that cannot compensate for oxygen displacement.
3. Clean the metal before welding. Cleaning the metal helps remove any chemical that might mix with the fumes produced by welding.

## VI. Oxyacetylene welding and cutting safety

### A. Protection from burns (from heat or light rays), fire, and explosions

1. Do not allow oil or grease to come in contact with oxygen under pressure.





**NOTE:** No lubrication of the apparatus is necessary.

2. Do not use oxygen as a substitute for compressed air.
3. Before starting to weld or cut, make certain there is no flammable material nearby.
4. Always wear welding goggles and heavy gloves when working with a lighted torch.
5. Wear welding goggles and protective clothing that blocks harmful light from the acetylene flame.
6. When using a welder, enclose the welding area to protect others from the dangers of acetylene flames.
7. Do not use matches for lighting acetylene torches. A spark lighter, held at an angle, should be used to light a torch.
8. Do not relight oxyacetylene flames on a hot work section in a small confined space.



**CAUTION: Acetylene gas gathers in one spot.**

9. Do not use acetylene at a pressure above 15 psi.

**CAUTION: Using acetylene at a pressure above 15 psi may result in hand burns.**

10. Use particular caution when welding or cutting in dusty or dirty locations.



**CAUTION: Dust can explode.**

B. Protection from toxic fumes and vapors

1. Many welding or cutting activities produce toxic fumes and vapors that are hazardous to breathe, and every work station should be equipped with a ventilation or exhaust system capable of safely removing dangerous and irritating smoke and contaminants.



**CAUTION: Always position the head to the side of rising fumes.**

# INTRODUCTION TO AUTOMOTIVE TECHNOLOGY

---

2. In confined areas where the hazard of toxic fumes is increased, a welder should wear an air-supplied respirator or a self-contained breathing apparatus, not a filter-type mask that cannot compensate for oxygen displacement.

**CAUTION: Argon is much heavier than air and quickly displaces oxygen, so be especially careful using the MIG process in a confined area, even though the area appears to have adequate ventilation.**

3. Clean the metal before welding or cutting. Cleaning the metal helps remove any chemical that might mix with the fumes produced by the process.
4. Some of the materials that give off especially toxic fumes are brass, bronze, galvanized materials, iron or steel coated with lead, or paint containing lead.

C. Safe handling of gas cylinders

**CAUTION: The acetylene and oxygen cylinders are highly pressurized and may explode if not handled properly.**

1. Oxygen and acetylene cylinders must be stored in a ventilated area and must be kept separate. Allow at least 20 ft between oxygen cylinders and acetylene cylinders.
2. All gas cylinders must be secured in both the storage area and on the wheeled cart with a safety chain or approved lashing.
3. The protective caps must be in place any time the cylinders are not in use.
4. Do not move the cylinders without protective caps in place.
5. Do not drop or knock cylinders around.
6. Do not tamper with safety devices or markings on a cylinder.
7. Do not use a hammer or wrench to open a cylinder valve.
8. Do not move a cylinder unless confident in handling it.



9. Always move a gas cylinder by using a hand truck with a safety chain or by tilting it slightly and rolling it on its bottom edge with one hand on the protective cap.



**CAUTION:** Do not tilt the cylinder too far over center; it may cause the cylinder to drop.

### VII. Lifting safety

- A. The technician will encounter many situations in which heavy objects must be lifted from the floor. Back injuries are common if lifting is not done properly.
- B. Alternatives to lifting heavy objects
  1. Avoid lifting, if possible.
  2. Move heavy objects by pushing, pulling, rolling, or sliding.
  3. Use hoists, jacks, carts, and wheel trucks when possible.
- C. To avoid injury when lifting a heavy object, use a mechanical device or get the assistance of another person.



# INTRODUCTION TO AUTOMOTIVE TECHNOLOGY

---

## D. Steps of procedure to lift an object

**CAUTION:** Do not lift in an area where the floor is wet or greasy.

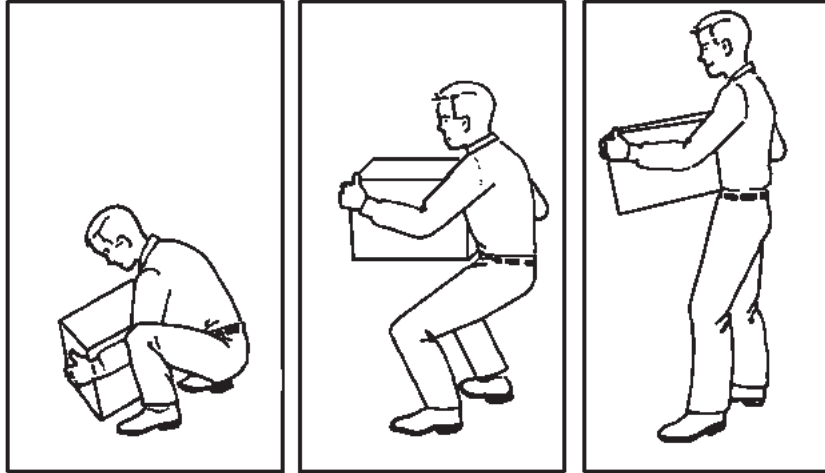

1. Spread the feet slightly, until comfortable, with one foot slightly ahead of the other and along side of the object.
2. Bend the knees, kneel, or squat; do not bend the back.
3. Use blocking under objects to get a hand hold.
4. Get a good grip and use gloves if the object has sharp or jagged surfaces.
5. Lift with the leg, arm, and shoulder muscles, straightening the legs and coming to a standing position.
6. Shift the feet to turn; do not twist.
7. Lower the load by bending the knees, keeping the back straight and using leg and arm muscles, and keep fingers and toes clear of objects.
8. Use blocking to keep from pinching the fingers when setting the object down.

## VIII. Personal protective clothing and equipment

**CAUTION:** Personal protective clothing and equipment should not be considered the first line of defense against injury but rather as backup protection.



- A. Wear protective eyewear at all times in the shop area.

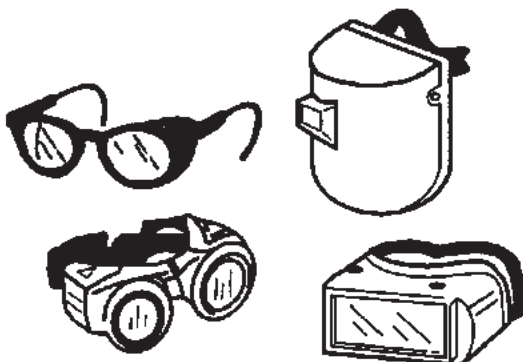

**NOTE:** The law requires that protective eyewear be available and worn in career and technical education courses where there is a reasonable probability of injury.

1. Special splash-resistant goggles are worn when there is a potential chemical hazard.

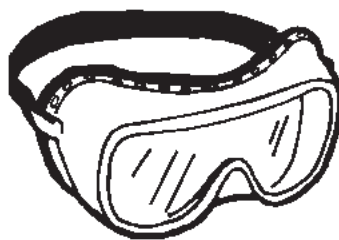

2. When welding, a welding hood or helmet must be worn to protect the head from flying sparks and protect the eyes from burns.
3. Tinted goggles may be required if welding is being performed close to the work area. Consult the instructor for the appropriate tinted goggles for the welding operation.
4. Proper glasses and wire mesh goggles or plastic spectacles with side shields are required in impact hazard areas, such as grinding areas.
5. Every person, including visitors, must wear industrial-quality protective eyewear at all times in the shop area.

# INTRODUCTION TO AUTOMOTIVE TECHNOLOGY

---

- B. Wear a full face shield in situations where sharp flying objects could injure the face.

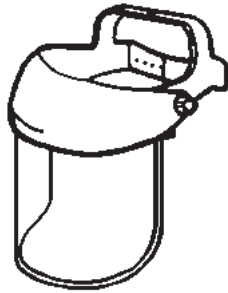

- C. Respiratory protection is sometimes necessary. Respiratory devices consist of a mesh that covers the nose and mouth. Wear a respiratory mask when doing tasks that can create dust.

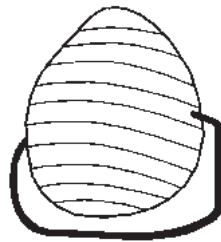

- D. Noise in the shop can cause hearing damage, depending on the level and duration. Wearing ear plugs and ear muffs helps protect the ears from noise created by equipment such as pneumatic tools, grinders, and engines.



- E. Adequate footwear should be worn in the shop area. Feet can easily be crushed, cut, or punctured if not properly protected.

1. Footwear should have leather or rubber oil-resistant soles.
2. Footwear should provide a full leather or strong fabric cover for the entire foot up to the ankles.

**NOTE:** Footwear with steel-reinforced toes provides even more protection.

3. High-top leather boots are recommended for welding operations.





- F. Protective clothing for the body and hands reduces the hazard of injury and protects street clothing.
1. Gloves and hand leathers are important pieces of protective clothing. Different tasks require different materials (e.g., rubber gloves are worn when handling caustic chemicals and heavy leather gloves with gauntlets are worn when welding).

**CAUTION: If operating machinery and wearing gloves, the gloves may become entangled in the moving parts.**

2. Aprons are used to protect from sparks, hot metal splashes, and splashing liquids. The material should be suitable for the intended use.

**CAUTION: Never wear loose aprons around revolving or reciprocating machinery.**

3. Coveralls protect the body. Overalls, a variation of coveralls, do not have sleeves. Fire-resistant coveralls made of cotton or wool are recommended for welding operations.
4. Shop coats provide protection against dirt and grease that soil street clothing. These also offer some protection against chemicals and hot substances.

IX. The importance of proper grooming and hygiene

- A. Long hair can become caught in moving machinery, which can result in a portion of scalp being lost or pulled into the machinery. Keep long hair out of machinery by pinning it up or wearing a cap.
- B. Jewelry should not be worn in the shop. See section III in this lesson for the specific hazards related to jewelry.
- C. Having greasy hands can cause slippage when working with hand tools. Grease also soils interiors and paint.
- D. Having grease on work shoes can spread grease across the shop floor, which increases the risk of slipping and falling. Dirty, greasy coveralls/overalls and shoes can ruin vehicle interiors.
- E. Having brake fluid and other chemicals on the hands could allow accidental transfer to painted surfaces and cause expensive repairs.

# INTRODUCTION TO AUTOMOTIVE TECHNOLOGY

---

- F. Protective eyewear that is dirty and scratched is difficult to see through. Protective eyewear should be kept clean. Do not place the lenses down on the floor or table. The soft, plastic coating can easily be scratched.

- X. Hazardous materials safety

- A. Five general safety rules

**CAUTION: Consult the instructor before using an unfamiliar product.**

1. Follow the manufacturer's recommendations. Refer to material safety data sheets (MSDSs). See Lesson 4 for information about MSDSs.
2. Carefully read the product label for correct uses and hazards.
3. Be careful to prevent spills, damage to the vehicle, or unsafe situations/conditions.
4. Properly store chemicals and used rags.
5. Use chemicals only for their intended purposes.

- B. Hazardous materials include the following:

**NOTE:** The following list includes some of the more common chemicals found in the shop and is not meant to be all-inclusive. See Unit III for the safety precautions and uses of these chemicals.

1. Solvents and acids – Part-washing solvents, choke and carburetor cleaner, brake cleaner, gasket remover, digestive-type carburetor cleaner, and vehicle battery acid
2. Lubricants – Rust-penetrating oil, silicone lubricant, liquid graphite, motor oil, automatic transmission fluid, power steering fluid, gear lube, hydraulic fluids, various greases, and specialty additives (e.g., oil treatment and gas treatment)
3. Gases and dust – Gases in engine exhaust, vapors from gasoline, refrigerant gas, and asbestos dust from brake and clutch linings



C. Safety from skin damage and fire

1. Many chemicals in the shop pose a hazard to the skin and eyes. Follow the safety precautions on the product label.
2. Keep electrical devices, sparks, and any hot material away from flammable chemicals.

D. Safety from toxic fumes

**CAUTION: Breathing toxic fumes can cause dizziness, nausea, headaches, unconsciousness, and can even lead to death.**

1. A common source of toxic fumes in the shop is the exhaust from a running engine. Each time a vehicle's engine is run in the shop, exhaust ventilation equipment should be attached to the vehicle to properly vent the carbon monoxide, a poisonous gas emitted in the exhaust.

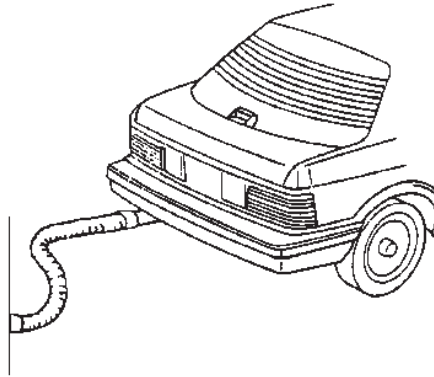

**CAUTION: Be sure to use approved exhaust ventilation equipment when operating a vehicle in an enclosed area.**

2. Whenever fumes or vapors are present, be sure to turn on the shop's ventilation system as soon as possible to remove them.



# INTRODUCTION TO AUTOMOTIVE TECHNOLOGY

---

3. Use breathing protection, such as a respirator, when working with any materials or chemicals that could be hazardous if inhaled.

Respirator With Removable Filters

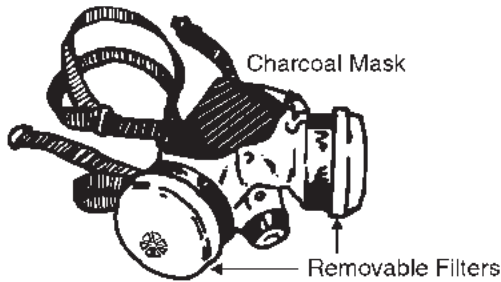

Air-Supplied Respirator

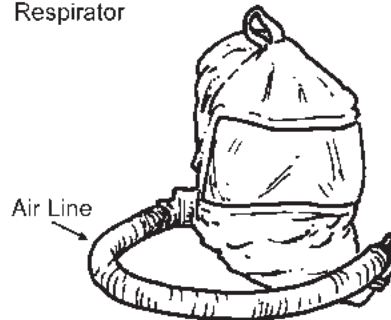

## XI. Safety precautions for supplemental restraint systems (SRSs) and antilock brake systems (ABSs)

**NOTE:** Technicians need to be aware of special safety considerations when working on or around these systems.

### A. SRS or air bag system

1. First appearing in a few 1985-model vehicles, air bag systems are standard equipment on most vehicles on the road today. A ruling by the National Highway Traffic Safety Administration required all new passenger cars to have dual air bags (one on the driver's side and one on the passenger's side) by 1998 and all new light trucks to have dual air bags by 1999.
2. The SRS is designed to inflate when a vehicle collides head-on with an object at a speed of more than 14 mph. During the collision, the driver and passenger impact the air bag rather than the steering column or dashboard.
3. In addition to driver-side and passenger-side air bags, some vehicles may be equipped with side-impact, window, and rear-seat air bags.
4. Air bags are relatively new devices. New safety issues regarding air bags are continually being recognized and studied.
5. Air bags must be used with seat belts, shoulder harnesses, and the proper headrests to provide maximum protection.





**NOTE:** It is important for everyone in the automotive industry, including automotive technicians, to explain to the public that the SRS alone does not provide maximum protection in a collision.

6. Before working near a vehicle's air bags, be sure they are disabled.

**CAUTION:** The force of an air bag can break bones and cause other serious injuries.

7. Even if an air bag has been disabled, the air bag may deploy if the diagnostic module's reserve power has not been depleted.

**CAUTION:** The diagnostic module keeps the air bag activated for some time after the negative battery cable has been disconnected. Wait until the diagnostic module's reserve power has depleted before working on or around the SRS. The time can vary from a few seconds to over 30 minutes.

### B. ABS

1. An ABS helps the driver maintain control of the vehicle when braking. If the wheels lock during braking, the vehicle may slide out of control. The antilock system prevents the brakes from being applied hard enough to lock the wheels.
2. Even when the antilock system closes down, normal power-assisted braking remains. A warning light located in the instrument panel indicates problems.
3. Listed below are general precautions to observe when servicing the ABS.

**CAUTION:** Failure to observe these precautions may result in personal injury and damage to the ABS.

- a. Follow the service information carefully. Use the proper service information for the vehicle. Using the wrong sequence of service steps, skipping steps, or using the wrong information leads to unnecessary replacement of parts.
- b. Some brake parts contain asbestos fibers that can become airborne as dust during brake service. Follow the latest federal procedures when working with asbestos.



# INTRODUCTION TO AUTOMOTIVE TECHNOLOGY

---

**CAUTION: Asbestos is a cancer-causing substance. Do not breathe asbestos dust or allow it to escape into the air.**



- c. Many components of an ABS are not serviceable; replace them as an assembly. Disassembling an ABS component that is not designed to be serviced may cause personal injury or system malfunction.
  - d. There is no one bleeding procedure that applies to all ABSs. Procedures vary greatly from system to system. To bleed a vehicle with an ABS, use the manufacturer's specific bleeding method for the vehicle being serviced.
  - e. If using electric arc welding equipment on a vehicle with an ABS, disconnect the battery and powertrain control module (PCM).
  - f. An ABS operates at very high pressures. Always depressurize the accumulator before servicing the ABS.
  - g. To protect the control module, never disconnect or connect any ABS connector while the ignition switch is on.
  - h. Portions of an ABS operate at very low system voltages; therefore, never use a conventional 12-volt test light to probe circuits. A conventional 12-volt test light can damage the antilock components. Always use a high-impedance digital multimeter (DMM) to probe the circuits.
  - i. When working with wiring on an ABS, never touch the electrical connections or pins or allow them to contact the brake fluid. This kind of contact damages the PCM.
  - j. Before test driving a vehicle with a brake problem, test the brakes at a low speed to be sure that the car stops normally.
- C. Procedures for identifying vehicles equipped with an SRS and ABS
- 1. On some vehicles, the vehicle identification number (VIN) indicates that the vehicle is equipped with an SRS and ABS. Check the manufacturer's service information to determine what digits indicate that the vehicle is equipped with an SRS and ABS.

2. The schematics may also come with various warnings that the vehicle is equipped with an SRS and ABS.
3. Some vehicles have a mark on the steering wheel cover to indicate an SRS.

# INTRODUCTION TO AUTOMOTIVE TECHNOLOGY

---

## UNIT II: SAFETY

### LESSON 2: SHOP SAFETY FEATURES AND EMERGENCY PROCEDURES

- I. Observe the following guidelines about safety features and equipment in a shop.
  - A. Walk around the shop to become familiar with the various areas (e.g., work bays, management offices, parts department, customer waiting area) and the traffic flow of vehicles coming in and out of the shop.
  - B. Note the location of shop exits, which should be well-marked with an "EXIT" sign. Keep the area around the exits free of obstructions.
  - C. Be familiar with the shop's evacuation routes and procedures in case of fire or other emergencies.
  - D. Note the location of specific work areas, such as those for welding, painting, and grinding, which should be clearly marked.
  - E. Know the location and how to operate the eye wash station, which is used to flush the eyes in case of a chemical splash.
  - F. Know where the first-aid supplies are kept and be familiar with the supplies available and how to use them.
  - G. Locate the telephones that can be used for emergencies and where emergency numbers are posted.
  - H. Note the location of storage containers for hazardous wastes and materials.
  - I. Know the location of the shop's fire blanket. Every shop must have a 100% wool fire blanket. The fire blanket can be wrapped tightly around a person who is on fire to smother the flames.
    1. Avoid using a fire blanket on a burning person wearing synthetic clothing. Doing so can cause serious skin damage. Use water to extinguish burning synthetic clothing.
    2. Work coveralls and shop clothing should be made of cotton.

**CAUTION: Do not allow a person on fire to run.**



- J. Know where the fire alarm is and how to activate it at the first sign of a fire that has any possibility of getting out of control.
- K. Know where fire extinguishers are located and how to use them. It is critical to be familiar with how the fire extinguishers in the shop operate to be prepared if a fire should start.



1. Types of fire extinguishers
  - a. Class A – Plain water
  - b. Class BC – May be carbon dioxide, ordinary dry chemical, or halon
  - c. Class ABC – Multipurpose dry chemical
  - d. Class D – Dry powder
2. Classes of fires and the appropriate extinguisher for each
  - a. Class A fires include burning paper, wood, rubber, cloth, and other materials commonly found in classrooms and offices. These fires may be effectively handled with either a dry-chemical or water fire extinguisher.

# INTRODUCTION TO AUTOMOTIVE TECHNOLOGY

---

- b. Class B fires include burning liquids, gases, grease, and oil. Use only dry-chemical fire extinguishers. Water fire extinguishers cause the burning liquid to spread.
- c. Class C fires are electrical fires. Use only a Class C fire extinguisher that contains dry chemicals and carbon dioxide. Water or foam-type fire extinguishers can electrocute people in the area.
- d. Class D fires include burning metals, such as magnesium or sodium. Use only Class D fire extinguishers that contain the appropriate dry powder and are identified by a 5-point star with the letter "D" printed within the star.

**NOTE:** Most shops use multiple-class fire extinguishers that can be used on Class A, B, and C fires.



### 3. Universal symbols for fire extinguishers

GREEN	RED	BLUE	YELLOW
Ordinary Combustibles	Flammable Liquids	Electrical Equipment	Combustible Metals

### 4. General procedure for using a fire extinguisher

**CAUTION:** Do not operate a fire extinguisher if not trained to do so, if the flames are large or progress beyond their initial stage, or if the fire becomes too hot or smoky. If there is any doubt about being able to extinguish the fire, evacuate the building immediately.

**CAUTION:** Before attempting to put out a fire with a fire extinguisher, be sure to identify a safe evacuation route.

**NOTE:** The instructor will demonstrate the proper operation of the fire protection equipment available in the shop. Most fire extinguishers operate using the P.A.S.S. method, which is included below.

- a. **Pull** – Pull the pin, ring, clip, etc. from the extinguisher's handle. This action will break the tamper seal.



- b. **Aim** – Aim the extinguisher nozzle at the base of the flames.
- c. **Squeeze** – Squeeze the extinguisher handle to release the contents.
- d. **Sweep** – Sweep from side to side at the base of the flames, discharging the extinguishing agent until the fire is out.



- II. The importance of maintaining cleanliness and order in the shop
  - A. A clean shop environment reduces the hazards of slipping and soiling clothing. It also protects vehicles from grease or paint damage.
  - B. An orderly shop with clear pathways allows employees easy access to exits. Regulations from the EPA and local fire codes empower the local fire marshal to insist on an orderly, uncluttered, and safe shop area.
  - C. Keep tools, equipment, and supplies organized to allow greater efficiency. Store tools, equipment, and supplies in their proper place when not in use.
  - D. A clean and orderly shop is the mark of competent professionals and promotes business growth.
- III. Emergency procedures
  - A. If someone is injured in the shop, notify the instructor at once.

# INTRODUCTION TO AUTOMOTIVE TECHNOLOGY

---

- B. Do not give first aid to a victim unless trained to do so. However, if properly trained, do not hesitate to give first aid.
- C. If someone comes into contact with electrical current and receives an immobilizing shock, do not try to move him or her if the current is still on and the person is still in contact with it. Shut off the main circuit to the shop. Electrical current will flow through whoever touches the person being shocked. Notify the instructor at once.
- D. General fire emergency procedure

**NOTE:** Specific procedures for dealing with fire emergencies vary. It is important to know the specific procedures for your shop.

1. If a person is on fire, immediately wrap the person in a fire blanket to smother the flames.
2. For other fires, turn on the fire alarm.
3. Notify the instructor as soon as possible. The instructor will decide whether or not to attempt to extinguish the fire or to wait for emergency personnel.
4. Turn off any machines and power in the event of an alarm if time or circumstances allow.
5. Follow building evacuation procedures as required.







# INTRODUCTION TO AUTOMOTIVE TECHNOLOGY

---

## UNIT II: SAFETY

### LESSON 3: RAISING AND SUPPORTING VEHICLES SAFELY

- I. Terms and definitions
  - A. **Jack** – A device, such as a hydraulic floor jack, that raises the front, rear, or side of a vehicle off the ground.
  - B. **Lift** – A piece of hydraulic equipment used to lift the whole vehicle off the ground.
  - C. **Lifting** – Using a device to raise a vehicle off the ground for the purpose of inspection, service, or repair.
  - D. **Safety stands** – Lightweight frames used to support a vehicle after being lifted by a jack.
  - E. **Torque box areas** – The four corners of the passenger compartment regardless of whether the vehicle actually has torque boxes.
  - F. **Torque boxes** – Located in each corner of the passenger compartment and designed to minimize damage to the compartment in a collision.
  - G. **Wheel blocks or wheel chocks** – Blocks that are placed on one or more wheels before lifting to keep the vehicle from rolling.
- II. Common lifting devices
  - A. In order to inspect or repair a vehicle, it is frequently necessary to get the vehicle off the ground to provide access to the underside.
  - B. A wide variety of equipment is available for lifting vehicles, such as lifts and hydraulic floor jacks. Most equipment is hydraulic, but there are also pneumatic lifts.

## C. Hydraulic lift

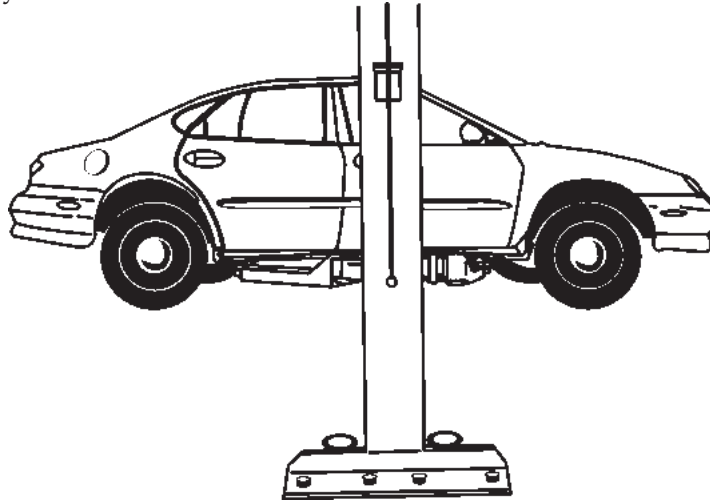

1. Functions hydraulically to raise the whole vehicle off the floor
2. Allows for inspection under the vehicle
3. Allows repairs to be done at a more comfortable height for the technician
4. Safety
  - a. Refer to service information for positioning the vehicle on the lift and follow all safety precautions for operating the lift.
  - b. Before lifting the vehicle, check for proper clearance on all sides of the vehicle in the lift area so that the vehicle does not hit other objects.
  - c. Do not lift vehicles with passengers inside or with the doors, hood, or luggage lid open.
  - d. Be sure that the lift's locking mechanism is in the locked position before walking under the lift.
  - e. Be familiar with safety lock release mechanisms for safe lowering of vehicles.

# INTRODUCTION TO AUTOMOTIVE TECHNOLOGY

---

## D. Hydraulic floor jack

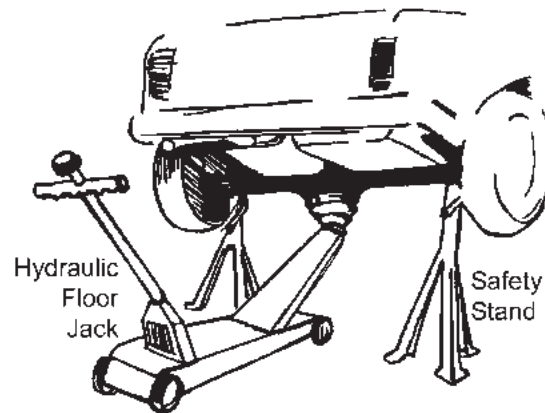

1. Uses mechanical force, with the operator using a lever to pump up the jack
2. Is mounted on four wheels for portability
3. Used often in raising the front, rear, or side of a vehicle for placement on safety stands
4. Safety
  - a. Ensure the vehicle being lifted is on a level, solid surface.
  - b. Always be sure the release valve is completely closed before attempting to lift a vehicle.
  - c. Refer to service information to find the correct lift point on the vehicle to position the saddle of the jack.
  - d. Never crawl under a vehicle held up only by a jack, either hydraulic or pneumatic. Always use safety stands to support the vehicle.
  - e. Be sure that the load-capacity rating for the safety stands is sufficient to safely support the vehicle.
  - f. After positioning the safety stands under the vehicle, shake the body of the vehicle to make sure it is stable.
  - g. After raising a vehicle with a floor jack, be sure the handle of the jack is pointed straight up.
  - h. Do not operate hydraulic jacks if they are leaking because they may fail.



- i. Do not lift vehicles with passengers inside or with the doors, hood, or luggage lid open.
- j. Make sure everyone in the vicinity is standing well away from a raised vehicle before opening the release valve to lower it. When lowering a vehicle, the release mechanism should be opened a little at a time, and then closed, to lower the vehicle a little at a time.

**CAUTION:** If the release mechanism is opened all the way, it will drop the vehicle to the floor instantly. This may cause injury to the operator and others in the area as well as damage to vehicle.

### III. Common support devices

#### A. Safety stands

1. Sturdy metal devices that support the vehicle after being lifted by a jack

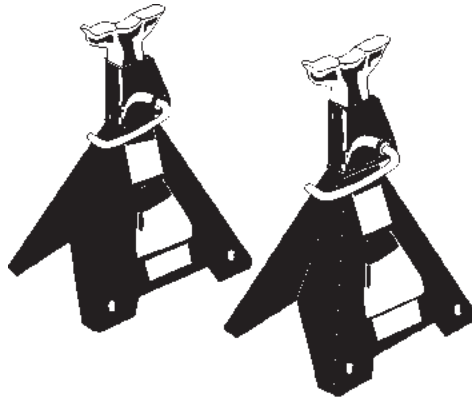

2. Available in different heights and load capacities
3. Placed under secure points on the vehicle such as the frame and axle housing



**NOTE:** Refer to service information and the manufacturer's instructions for the correct points to place safety stands.

# INTRODUCTION TO AUTOMOTIVE TECHNOLOGY

---

- B. Wheel blocks, also known as wheel chocks
  - 1. Wedge-shaped blocks used as a safety measure, in addition to safety stands, to keep the vehicle from rolling after being lifted

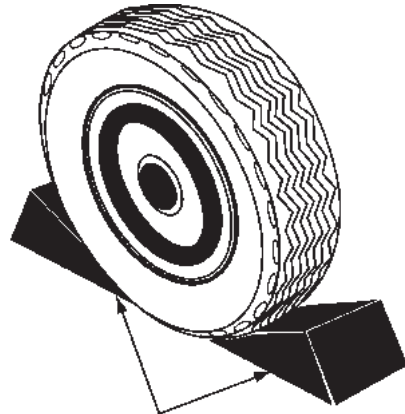

Wheel Blocks

- 2. Used before lifting the vehicle with a jack
    - 3. Placed in the front and rear of a wheel that will remain on the ground after lifting
- IV. Principles of lifting and supporting vehicles

- A. Each vehicle has specific lifting points. Consult current service information or the owner's manual for each model to determine proper lifting points.

**CAUTION: Identification of proper lifting points is extremely important. Damage caused by improper lifting can be severe. Common sense, along with an understanding of vehicle construction and vehicle supporting techniques, must be used in each repair instance.**

- B. The purpose of raising the vehicle is to get the vehicle high enough in the air to safely inspect, service, or repair the underside.
- C. Before lifting a vehicle, check both the vehicle and equipment manufacturer's recommendations.
- D. In getting the vehicle off the ground, there are two separate points to be considered as follows:
  - 1. Proper lifting methods





## 2. Proper supporting methods

### E. Lift and support points

**NOTE:** The correct lift and support points depend on the model of the vehicle and the type of lift equipment being used. Refer to service information and the manufacturer's instructions.

#### 1. Torque box areas are generally acceptable lift points.

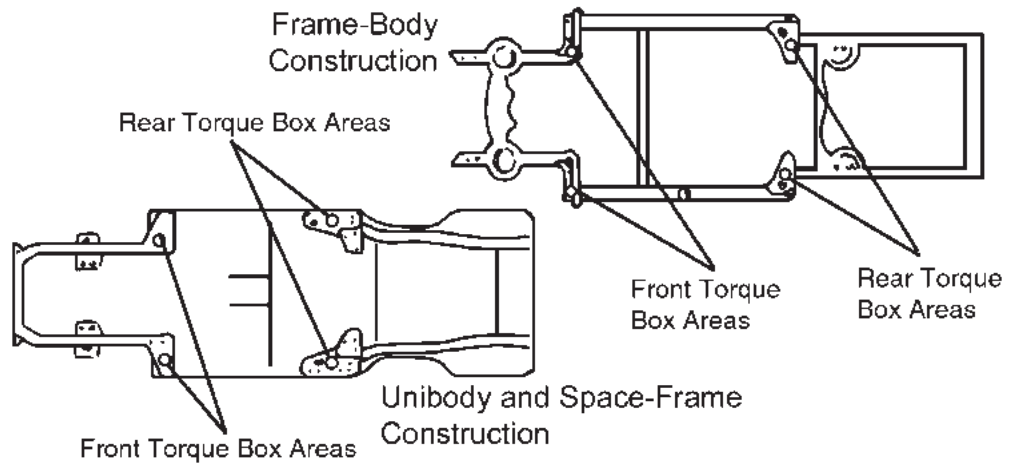

- a. These areas are designed to absorb twisting (torque) force caused by a collision and route damage away from the passenger compartment.
- b. The four torque box areas are located at the corners of the passenger section.
- c. Even if the vehicle does not have actual torque boxes, the four corners of the passenger compartment are referred to as torque box areas.
- d. Torque box areas are generally the strongest areas of the vehicle for lifting and supporting.

## INTRODUCTION TO AUTOMOTIVE TECHNOLOGY

---

2. The pinchweld area of the rocker panel, which is the factory weld that fuses the bottom flange of the outer rocker panel to the inner rocker panel, is a strong support area on unibody vehicles.

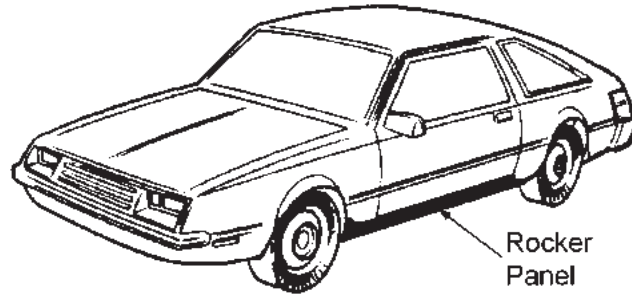





# INTRODUCTION TO AUTOMOTIVE TECHNOLOGY

---

## UNIT II: SAFETY

### LESSON 4: FEDERAL AND STATE HAZARDOUS MATERIAL REGULATIONS

- I. Occupational Safety and Health Administration (OSHA) regulations
  - A. OSHA is a federal organization that sets and enforces work environment standards to protect the health and safety of the individual worker. Any employer or institution that does not adhere to OSHA standards is subject to prosecution.
    1. If employees provide their own eye and face protective equipment, OSHA requires that the employer make sure the equipment meets specific safety standards.
    2. OSHA requires the employer to provide a ventilation system, masks, and any other such devices needed to provide reasonable protection against harmful dusts, fogs, fumes, mists, gases, smokes, sprays, and vapors.
    3. OSHA requires that flammable liquids like gasoline and solvents that are packaged or kept in small containers be stored in an approved metal cabinet in quantities of less than 60 gal.  
  
**NOTE:** The metal cabinets must be approved by the Underwriters Laboratories Inc. (UL).
    4. OSHA requires that potentially hazardous chemicals stored on site be clearly labeled. Safety training for employees should address the correct procedures for chemical handling, storage, and disposal.
    5. OSHA requires that employers provide adequate ear protection for all workers exposed to noise levels deemed harmful.
  - B. The Hazardous Communication Standard or Right-to-Know law informs employees about the hazardous substances that are available in their shop.
    1. Requirements of the Right-to-Know law
      - a. A specific person or group is responsible for the operation of the company's Right-to-Know program.



- b. All hazardous substances and harmful physical agents must be identified.
  - c. A written program describes training activities, chemical identities, and waste disposal.
  - d. All containers of hazardous substance must be labeled with the necessary health and safety information.
  - e. Employers must obtain written information on each hazardous substance and provide them to employees in the form of material safety data sheets (MSDS).
  - f. All employees must be trained in the details of the Right-to-Know requirements.
- C. OSHA uses certain basic characteristics to determine which materials are included on its hazardous substance list.
- 1. A hazardous material is any substance that could cause injury or death to people or could damage and pollute land, air, or water.
  - 2. To be considered hazardous a substance must be either toxic, flammable, corrosive, reactive, or come into contact with the skin.
    - a. "Toxic" is the term used to describe a material that can cause illness or death after being inhaled or coming into contact with the skin. OSHA and the Environmental Protection Agency (EPA) have lists that include hundreds of different toxic chemicals.
    - b. "Flammable" is used for an ignitable substance that can easily catch fire or any material that has a flash point below 200°F.
    - c. "Corrosive" is used for a substance strong enough to dissolve metal, burn skin, or cause eye damage. Acids and bases are examples of corrosive materials.
    - d. "Reactive" is used for a material that can become unstable, burn, explode, or give off toxic vapors if mixed with air, water, heat, or other materials.

# INTRODUCTION TO AUTOMOTIVE TECHNOLOGY

---

- D. Employee training is required.
  - 1. Employers are required to train the following people.
    - a. Workers who are routinely exposed to hazardous chemicals or hazardous waste.
    - b. Workers who handle packages containing hazardous materials.
    - c. Anyone that could be exposed to hazardous materials in a foreseeable emergency or could be involved if an accident occurs.
    - d. New employees that meet the above examples must be trained before they begin work where they could be exposed to hazardous materials.
    - e. Office workers that only encounter hazardous chemicals in isolated cases do not require training.
  - 2. The following must be included in the training.
    - a. Employees must be trained to recognize hazardous materials and how to gather information about those hazardous materials.
    - b. Employees must be trained in the basic ways to protect themselves from harmful exposure.
    - c. Employees must be trained in the proper use of levels and MSDS materials.
    - d. Employees must be trained in what to do in an emergency and how to use equipment.
    - e. Employers must educate employees on the details of the Right-to-Know program.
  - 3. Federal regulations do not include annual Right-to-Know training, but many states now require safety training be repeated on an annual basis.
- E. Employers have certain responsibilities.
  - 1. There must be at least one person appointed to administer the Right-to-Know program.

2. Hazardous materials in the workplace must be identified and listed.
  3. An MSDS must be obtained and kept for each hazardous chemical on site.
  4. A written plan must be developed that outlines the requirements of the Right-to-Know program.
  5. Employees must be trained to understand the physical and health hazards of the chemicals.
  6. The information on container labels must be explained and maintained.
  7. Workers must be shown how to protect themselves from chemical hazards.
  8. There must be instructions on what to do in an emergency and how to use protective equipment.
- F. Employees have certain responsibilities.
1. They must know where the MSDSs are kept.
  2. They must know how to read labels and MSDS information and how to follow the manufacturer's instructions and warnings.
  3. They must know how to obtain information and ask questions.
  4. They must know the proper procedures for dealing with hazardous materials.
  5. They must know the proper procedures for dealing with an emergency that involves hazardous materials.
- G. MSDS requirements include the following:
1. Per OSHA requirements, chemical manufacturers and material importers must obtain or develop an MSDS for each hazardous material they produce or import. A sample MSDS appears after the next page.
  2. Employers must have an MSDS in the workplace for each hazardous material they use.
  3. Each MSDS must be in English.

# INTRODUCTION TO AUTOMOTIVE TECHNOLOGY

---

**NOTE:** The employer may maintain copies in other languages.



4. Chemical manufacturers and importers can use any form for a MSDS as long as it is in compliance with OSHA standards and contains the specific following information.
  - a. The name, common name, and common name of any chemicals used in the mix
  - b. The physical and chemical characteristics
  - c. Physical hazards including the potential for fire, explosion, and reactivity
  - d. Health hazards including the signs and symptoms of exposure and any medical conditions that are generally recognized as being aggravated by exposure
  - e. Primary routes of entry on the body, such as inhalation and skin absorption
  - f. The OSHA-permissible exposure limit, the American Conference of Governmental Industrial Hygienists (ACGIH) threshold limit, and any other exposure limits that are used or recommended
  - g. Whether or not the chemical is listed by OSHA and the National Toxicology Program (NTP) annual report on carcinogens or is considered to be a potential carcinogen in the International Agency for Research on Cancer (IARC) monographs
  - h. Any applicable precautions for safe handling and use that are known
  - i. Any applicable control measures that are known
  - j. Emergency and first aid procedures
  - k. Date of preparation of the MSDS or the date of the last change to the MSDS
  - l. Name, address, and telephone number of the chemical manufacturer, importer, or employer that prepared the MSDS
5. Each manufacturer will have specific information about how to read an MSDS.

**MSDS 19-3**  
January 1, 2001

## DuPont Performance Coatings MATERIAL SAFETY DATA SHEET CHROMASYSTEM® BINDERS AND BASEMAKERS

\*\*\*\*\* SECTION 1 - Product and Company Identification \*\*\*\*\*

Manufacturer:	E.I. DuPont de Nemours & Co. DuPont Performance Coatings Wilmington, DE, 19898	BUTYL ACETATE	123-86-4	8.0	A 200.0 ppm 15 min STEL A 150.0 ppm O 150.0 ppm
Telephone:	Product Information: (800) 441-7515 Medical Emergency: (800) 441-3637 Transportation Emergency: (800) 424-9300 (CHEMTREC)	CELLULOSE ACETATE BUTYRATE	9004-36-8	None	A None O None
Product:	<b>CHROMASYSTEM® BINDERS &amp; BASEMAKERS</b>	DIISOBUTYL KETONE	108-83-8	1.7	A 25.0 ppm O 50.0 ppm
DOT Shipping Name:	See DOT addendum.	ETHYL ACETATE	141-78-6	76.0	A 400.0 ppm O 400.0 ppm
Hazardous Materials Information:	See Section 10.	ETHYL 3-ETHOXY PROPIONATE	763-69-9	None	O None A None

\*\*\*\*\* SECTION 2 - Composition, Information on Ingredients \*\*\*\*\*

INGREDIENTS	CAS #	VAPOR PRESSURE	EXPOSURE LIMITS				
ACETIC ACID ESTER	90438-79-2	None	O None A None	ETHYLBENZENE	100-41-4	7.0	A 125.0 ppm 15 min STEL A 100.0 ppm O 100.0 ppm D 25.0 ppm 8 & 12 hour TWA
ACETIC ANHYDRIDE	108-24-7	1.0 @ 36.0 Deg C	A 5.0 ppm CEIL O 5.0 ppm CEIL	HEXYL ACETATE ISOMERS	88230-35-7	0.7	O None A 50.0 ppm hexyl acetate
ACETONE	67-64-1	180.0 @ 68.0 Deg F	A 750.0 ppm 15 min STEL A 500.0 ppm O 1000.0 ppm D 500.0 ppm 8 & 12 hour TWA	ISOBUTYL ACETATE	110-19-0	12.5	A 150.0 ppm O 150.0 ppm
ACRYLIC POLYMER-A	Not Available	None	A None O None	ISOPROPYL ALCOHOL	67-63-0	33.0	A 500.0 ppm 15 min STEL A 400.0 ppm O 400.0 ppm D 400.0 ppm B & 12 hour TWA
ACRYLIC POLYMER-B	25133-97-5	None	A None O None	KETONE SOLVENT	71808-49-6	5.8 @ 100.0 Deg C	A None O None
ACRYLIC POLYMER-C	96591-17-2	None	A None O None	MEDIUM MINERAL SPIRITS	64742-88-7	7.5 @ 37.8 Deg C	D 100.0 ppm A None O None
ACRYLIC POLYMER-D	124993-76-6	None	A None O None	METHYL AMYL KETONE	110-43-0	2.2	A 50.0 ppm O 100.0 ppm
AROMATIC HYDROCARBON	64742-95-6	10.0 @ 25.0 Deg C	D 50.0 ppm A None O None	METHYL ETHYL KETONE	78-93-3	71.0 @ 0.0	A 300.0 ppm 15 min STEL

Reprinted with permission from  
DuPont Automotive Finishes

**MSDS 19-3**  
January 1, 2001

# INTRODUCTION TO AUTOMOTIVE TECHNOLOGY

---

## II. EPA regulations

- A. The EPA is a federal agency that writes and enforces regulations on hazardous waste and is responsible for how the health of the population is affected by the environment.
- B. Federal laws define three categories of hazardous waste generators.
  - 1. A Conditionally Exempt Small Quantity Generator generates 100 kg or less of hazardous waste per month and never stores more than 1,000 kg at the business.
  - 2. A Small Quantity Generator generates between 100 kg and 1,000 kg of hazardous waste per month. The amount of hazardous waste stored on site must never exceeds 6,000 kg.  
  
**NOTE:** The typical shop is classified by the EPA as a Small Quantity Generator.
  - 3. A Large Quantity Generator generates 1,000 kg or more per month of hazardous waste. This type of generator does not have a hazardous waste storage limit but cannot store waste on site for more than 90 days.
- C. All categories of generators are subject to the following requirements.
  - 1. A generator must determine which materials are hazardous.
  - 2. A generator must obtain an EPA ID number.
  - 3. A generator must prepare and store hazardous waste as required by law.
  - 4. A generator must ship wastes for treatment and disposal only to companies with proper EPA ID numbers.
  - 5. A generator must follow the proper hazardous waste storage rules for tanks and drums.
    - a. Drums must be marked with the date the waste was first placed in the drum.
    - b. The correct labels must be used.
    - c. There must be a secure storage area to prevent unauthorized access.





- d. Outdoor storage must be shaded from sunlight if the wastes are ignitable.
  - e. The floor in the outdoor storage area must be curbed and impermeable to catch and contain leaks of the waste.
6. A generator must keep manifests for at least 3 years. Exception reports are filed if a waste shipment is lost.
7. The facility must be operated to minimize accidents and be equipped with internal and external communication equipment. Local authorities, fire, police, and emergency medical must be familiar with the layout, entrance routes, access routes, and the list of wastes at the facility and related locations.
- NOTE:** Any refusal by the local authorities to respond should be documented.
8. A generator must inspect waste containers on a weekly basis. Containers must be kept closed between use. If the facility is ever closed, all waste must be removed.
- D. Additional requirements for category 2 and 3 generators are as follows:
- 1. An emergency coordinator must be designated for the site. This person is on call 24 hours a day to respond to any emergency.
  - 2. The name and phone number of the emergency coordinator, the location of the fire extinguishers, the location of the spill control equipment, and the fire department phone number must be posted by the telephone.
  - 3. The generator must ensure and document that employees have been trained in emergency operations and communications systems.
  - 4. The emergency coordinator must respond to any emergency and follow the emergency response plan.
- E. Hazardous wastes must be stored properly.
- 1. When wastes are generated, a label is created with the start date, facility address, EPA ID number, the words "Hazardous Waste," waste information, and shipping information.



# INTRODUCTION TO AUTOMOTIVE TECHNOLOGY

---

2. A warning sticker may also be necessary. Some wastes have more than one hazard and require a warning label for each hazard.
  3. Container management requires that a log must be kept to record weekly inspections of drums during storage. Drum inspections require the date and initials of the inspector. See Section II, C, 5 for other requirements.
- F. EPA regulations related to the storage of hazardous wastes include the following:
1. The different types of hazardous wastes cannot be mixed.
  2. Storage containers must be in sound condition and have the proper design and characteristics for the type of material.
  3. Containers must be clearly marked and stored away from the shop area. The EPA and Department of Transportation (DOT) require specific labels to indicate various types of wastes.
- G. EPA regulations related to the handling of hazardous wastes include the following:
1. Employees must be trained in the proper use and disposal of hazardous wastes.
  2. Signs and charts identifying and describing the hazardous materials must be displayed in the shop.
    - a. Emergency procedures for dealing with hazardous waste accidents must be displayed in the shop.
    - b. The phone numbers of the emergency coordinator, fire department, police, health center, and the national response center must be posted by the telephone.
  3. The shop area must be uncluttered and exits easily accessible. The local fire marshal determines if the shop is meeting these requirements.
  4. The shop operator must have on file precise information on the chemicals contained in each product in the shop. The operator should also have on file first aid procedures relating to exposure to these chemicals.

- H. EPA regulations related to the disposal of hazardous wastes include the following:
1. Hazardous wastes must be collected by an approved waste hauler.
  2. A shop representative must complete a waste manifest each time a waste hauler picks up hazardous material. The hauler cannot accept waste without the correct forms.
- NOTE:** An exception to this rule involves the use of solvents that will be recycled by the waste hauler. In this case, the paperwork is handled by the hauler.
3. The shop must obtain a twelve-digit code number from the EPA. This number registers the shop as a Small Quantity Generator. A waste hauler must have this code.
  4. Each type of waste must be in a suitable package or container and identified with a code name as specified by the DOT.
  5. Failure to observe EPA regulations results in criminal liability to the shop or waste hauler.
- I. Chemicals or products that are designated as hazardous waste can change. The following are two ways a material is judged "hazardous" and subject to EPA regulations.
1. The EPA has a published list of specific chemicals deemed to be hazardous to health and the environment.
  2. If an operator believes a material is flammable or corrosive, will react chemically with other materials, or will release hazardous materials, the material can be deemed hazardous.
- J. The following are ways in which a shop can reduce the production of hazardous waste and the cost of disposing of it.
1. Encourage the conservative use of solvents to reduce waste disposal costs as well as the replacement costs of solvent.
  2. Use heaters that burn oil, which saves on heating bills as well as waste disposal costs.
  3. Ship the hazardous waste directly to a recycling plant that will pick the waste up at no charge and usually not require a waste manifest.



# INTRODUCTION TO AUTOMOTIVE TECHNOLOGY

---

## UNIT III: CHEMICALS AND THEIR USE

### CONTENTS OF THIS UNIT

- I. Unit objective
- II. Lesson plans
  - A. Lesson 1: Solvents, Soaps, and Cleaning Solutions
    - 1. Information outline
    - 2. Assignment Sheet
      - a. AS1-L1-UIII: Solvents and Soaps
  - B. Lesson 2: Lubricants and Specialty Chemicals
    - 1. Information outline
    - 2. Assignment Sheet
      - a. AS1-L2-UIII: Lubricants and Specialty Chemicals
  - C. Lesson 3: Gases, Asbestos Dust, and Battery Acid
    - 1. Information outline
    - 2. Assignment Sheet
      - a. AS1-L3-UIII: Gases, Dust, and Acid
- III. Unit III Test



# INTRODUCTION TO AUTOMOTIVE TECHNOLOGY

---

## UNIT III: CHEMICALS AND THEIR USE

### UNIT OBJECTIVE

After completing this unit, students will be able to identify common chemicals used in the shop, their purpose, and how to use them safely. The students will demonstrate mastery of the material by completing the assignment sheets and achieving a score of \_\_\_\_\_ on the Unit III Test.

### SPECIFIC OBJECTIVES

After completing the lessons in this unit, students should be able to:

#### Lesson 1

- I. Describe the five general rules for using automotive chemicals.
- II. Identify the types and uses of solvents.
- III. Identify the types and uses of soaps and cleaning solutions.
- IV. Complete the assignment sheet on solvents and soaps (AS1-L1-UIII).

#### Lesson 2

- I. Identify the types and uses of oils.
- II. Identify the types and uses of greases.
- III. Identify the types and uses of specialty additives.
- IV. Identify the types and uses of specialty chemicals.
- V. Complete the assignment sheet on lubricants and specialty chemicals (AS1-L2-UIII).

#### Lesson 3

- I. Identify gases and the hazards they present.
- II. Identify the hazards of asbestos dust.
- III. Identify the hazards of battery acid.
- IV. Complete the assignment sheet on gases, dust, and acid (AS1-L3-UIII).



# INTRODUCTION TO AUTOMOTIVE TECHNOLOGY

---

## UNIT III: CHEMICALS AND THEIR USE

### LESSON 1: SOLVENTS, SOAPS, AND CLEANING SOLUTIONS

#### I. Five general rules for using chemicals

**CAUTION: Consult the instructor before using an unfamiliar product.**

- A. Follow the manufacturer's recommendations.
- B. Carefully read the product label for correct uses and hazards.
- C. Work to prevent spills, damage to the vehicle, or unsafe situations/conditions.
- D. Properly store chemicals and used rags.
- E. Use chemicals only for the intended purposes.

#### II. Types and uses of solvents

- A. Parts-washing solvent (petroleum based)
  - 1. This type of solvent dissolves oil, grease, and varnish from engine components and other parts of the vehicle. It is usually dispensed in a parts-washing tank that filters and recycles the solvent.
  - 2. This solvent contains volatile organic compounds (VOCs) that give off toxic vapors and must be managed as a hazardous waste. Parts-washing solvent is not as flammable as some other solvents, but can burn and does present a fire hazard.
    - a. Keep electrical devices, sparks, and any hot material away from the parts-washing tank.
    - b. The solvent tank should be equipped with a safety link, which will melt should the solvent ignite. When the safety link melts, the lid on the washer tank will close and smother the fire.
    - c. Parts-washing solvent presents a hazard to the eyes and skin, especially when the solvent is fresh. Breathing solvent vapors is also a health risk. Wear personal protective equipment (PPE) when working with the solvent.





**CAUTION:** Some technicians may have a severe allergic reaction to the parts-washing solvent.

3. Petroleum-based parts-washing solvent can melt some shoe rubber and should never be splashed or poured on the shop floor. If a solvent spill is not immediately wiped up from the floor, it can cause people to slip and fall.
  4. Never put units such as electric motors in the solvent tank. Such units may sustain insulation damage; they may also be hard to dry on the inside.
  5. To extend the usable life of the solvent and to prevent clogging the tank, remove most of the grease, gasket material, and dirt from parts before washing. Never pour other liquids into the solvent tank.
- B. Parts-washing solvent (aqueous based)
1. This type of solvent is used for the same purposes as the petroleum-based solvents, but it is typically nonflammable and contains less than 5% VOCs. Besides water, the ingredients in aqueous-based solvents generally include a detergent, corrosive substance, or alkaline agent and a rust inhibitor.
  2. Rather than dissolving grease and solids with chemicals, aqueous solvents use heat, agitation, and detergents to clean automotive parts.
  3. Special cleaning equipment is required that heats the aqueous solvent and sprays it with great force.
    - a. Spray cabinets, which are totally enclosed, are best for cleaning heavily soiled parts or a large number of parts.
    - b. Sink-top units are used for more lightly soiled parts or fewer parts.
  4. The life of the solvent can be prolonged by using filters, maintaining the solvent's concentration, and skimming grease from the solution.
  5. Aqueous solvent may become hazardous waste through use. Waste disposal professionals must analyze the solution to determine how to dispose of it safely.



# INTRODUCTION TO AUTOMOTIVE TECHNOLOGY

---

- C. Choke and throttle body cleaner is an aerosol product that is more aggressive than parts-washing solvent in the cleaning of oil, grease, and varnish from carburetor components and other small precision-machined parts. It is a petroleum-based product.
  - 1. Choke and throttle body cleaner is extremely flammable and presents a dangerous fire hazard. Never spray the cleaner on hot engine parts or around sparks or fire.
  - 2. The cleaner can damage paint. Do not spray the cleaner near the body of the vehicle or other painted components.
  - 3. The cleaner can damage eyes and irritate skin. Breathing its vapors is also hazardous. Always wear PPE. Spray the cleaner away from the body so that vapors are not inhaled and the cleaner does not contact the skin.
  - 4. Observe the safety warnings on the cleaner can. Do not expose the cleaner can to heat under any circumstances because heat will cause the cleaner can to explode.
  
- D. Brake cleaner is an aerosol product that is extremely effective in removing grease and oil from brake drums, rotors, and engine flywheels.
  - 1. Brake cleaner is extremely flammable and presents a severe fire hazard because the cleaner is sprayed from an aerosol can.
  - 2. Brake cleaner can damage paint. Do not spray the cleaner near the body of the vehicle or other painted components.
  - 3. Brake cleaner can damage eyes and irritate skin. Breathing its vapors is also hazardous. Always wear PPE. Spray the cleaner away from the body so that vapors are not inhaled and the cleaner does not contact the skin.
  - 4. Observe the safety warnings on the cleaner can. Do not store brake cleaner in a hot area. Do not expose the can to heat under any circumstances because heat will cause the cleaner can to explode.
  
- E. Gasket remover is an aerosol product that loosens gasket material that may be tightly stuck to engine components with sealers or glue.
  - 1. Gasket remover is extremely flammable and presents a serious fire hazard because the gasket cleaner is sprayed from an aerosol can.

2. Gasket remover can damage paint. Do not spray the remover near the body of the vehicle or other painted components.
  3. Gasket remover can damage eyes and irritate skin. Breathing its vapors is also hazardous. Always wear PPE. Spray the cleaner away from the body so that vapors are not inhaled and the cleaner does not contact the skin.
  4. Observe the safety warnings on the gasket remover can. Do not store gasket remover in a hot area. Do not expose the can to heat under any circumstances because heat will cause the gasket remover can to explode.
- F. Digestive-type carburetor cleaner is an aggressive chemical agent that is usually stored in a 1- or 5-gallon container. The chemical dissolves organic material, leaving only clean metal that is then rinsed with water.

1. Digestive-type carburetor cleaner reacts vigorously with organic material. It presents severe hazards to the eyes and skin. Always wear PPE.
2. Do not splash digestive-type carburetor cleaner.

**CAUTION: Digestive-type carburetor cleaner will quickly burn skin that it contacts, so flush afflicted areas immediately with water.**

3. To clean parts, gently submerge the basket of parts into the can. When the solvent has finished cleaning, carry the basket with lid in place to the sink. The basket of clean parts should be placed in the sink and the parts rinsed in a gentle stream of water.
4. Any spills must be cleaned up immediately. Rags or towels used in the cleanup should be discarded.
5. Because digestive-type cleaner reacts with organic and some nonorganic substances, use it only on metallic parts.
  - a. Parts made of rubber, fiber, or plastic may be ruined by digestive-type carburetor cleaner. The cleaner may even remove anodized coatings along with paint and varnish.
  - b. Never use any of these chemicals for purposes other than those listed on the product can or container.



# INTRODUCTION TO AUTOMOTIVE TECHNOLOGY

---

6. To keep fumes and evaporation to a minimum, add a 1-in layer of water on top of the cleaner and cover the can with a lid.
  7. Digestive-type carburetor cleaner is an expensive chemical and should be used only to clean small, precision components. Larger components can be cleaned with other solvents.
- G. Safety warning about gasoline
1. Do not use gasoline as a solvent. Gasoline is intended for use as a fuel not as a cleaner for automotive parts.

**CAUTION: Never use gasoline or other chemicals for purposes other than those listed on the product can or container. Consult with the instructor before using any solvent or chemical.**

2. Gasoline fumes can cause similar health problems as cleaning solvents and contribute to hydrocarbon emissions. The fumes are also extremely flammable and, if ignited, can cause severe burns or death.
3. Prolonged exposure to liquid gasoline has been shown to cause cancer in laboratory animals.
4. Gasoline additives can leave harmful deposits on important engine components.

### III. Types and uses of soaps and cleaning solutions

- A. Soaps and cleaning solutions are water-soluble agents used for cleaning dirt and grease.
- B. Liquid detergent, or dishwashing liquid, is a mild detergent that is convenient to use. Liquid detergent is suitable for washing engine blocks after honing or glaze breaking.
- C. Glass cleaner and windshield washer fluid are available in aerosol, pump spray, or liquid form. The best results are obtained when glass cleaner is used with paper towels rather than shop towels. Shop towels almost always retain grease and leave lint.

**CAUTION: When filling the windshield washer fluid reservoir in the winter time, read the label on the solution to see if it contains the necessary antifreeze. Freezing can result in a cracked reservoir tank due to expansion.**





- D. Hand soaps that are typically used contain an abrasive to help clean ground-in grease. These soaps can cause rawness or cracking of the skin.

**CAUTION: Never use abrasive hand soaps on vehicle finishes or plastics because scratches can occur.**

- E. Hand-cleaning creams are more effective than ordinary hand soaps on grease and dirt. Hand-cleaning creams are also available with abrasives for tough cleaning jobs. These can be used in conjunction with hand soaps.
- F. Hand-protecting creams that are applied before work are effective in preventing dirt and grease from staining the hands and arms. Use of ordinary hand soap will remove the hand-protecting cream.
- G. Cleaning methods for shop floors should be as dry as possible to help prevent water pollution.
1. According to EPA guidelines, shop workers should keep the shop floor as dry as possible to minimize the amount of wastewater that is generated.
  2. Ways to keep the floor dry and clean include the following:
    - a. Keep spills off the floor by using dedicated containers for substances like used oil and antifreeze.
    - b. Clean up spills immediately to prevent workers from slipping in the substance and tracking it to other areas.
    - c. Use rags to clean up small spills and dispose of the soiled rags properly.
    - d. Use absorbent pads or mops to clean large spills and wring the substance from the pads or mops into a dedicated container for recycling or disposal.
    - e. Use floor sweep (granules that absorb liquids) only when cleaning up hazardous waste spills such as gasoline or solvents.
    - f. Sweep the floor with a broom every day to prevent the buildup of dirt and contaminants.

# INTRODUCTION TO AUTOMOTIVE TECHNOLOGY

---

- g. Do not hose down the floor with water or dump mop water because the contaminants will go into the storm drain or sewer, causing pollution.
  - h. Use water, a mop, and a mild detergent only if necessary after the spill has been removed. Check with local authorities for the proper disposal procedure.
- H. Examples of specialty cleaning agents
- 1. Spot remover
  - 2. Bug and tar remover
  - 3. Velour upholstery cleaner
  - 4. Carpet cleaner
  - 5. Vinyl cleaner and conditioner
  - 6. Battery cleaner
  - 7. Wire wheel cleaner
  - 8. White sidewall cleaner



# INTRODUCTION TO AUTOMOTIVE TECHNOLOGY

---

## UNIT III: CHEMICALS AND THEIR USE

### LESSON 2: LUBRICANTS AND SPECIALTY CHEMICALS

#### I. Types and uses of oils

- A. Oil is a petroleum-based or synthetic product that lubricates parts or acts as a hydraulic fluid. When using oil, follow the safety precautions below.

**CAUTION: Wear personal protective equipment (PPE) when working with oils.**



1. All types of oils can represent a significant fire hazard. Spontaneous combustion, fire initiated without flame, can and does occur with rags soaked in any type of oil. Oil must be stored in a designated area away from heat, flame, or sparks.
  - a. Oily rags must be stored in a metal safety container with an airtight lid built for this purpose.
  - b. Oil can ignite at any temperature above 0° when mixed with pure oxygen. Oil must never be applied to oxyacetylene welding equipment.
  - c. Immediately use or discard bottles and cans that are leaking oil.
2. If oil is dripped or spilled on the shop floor, clean it immediately to prevent slipping.
  - a. Wipe up small spills or drips with a towel.
  - b. Larger spills may need to be absorbed with sawdust or oil absorbent granules and then swept up and discarded. If necessary, scrub remaining slickness with soap and water.
  - c. Drain pans help to prevent oil spills.
3. Avoid prolonged contact with oils.
  - a. Short-term contact can cause irritation, chapping, or drying of the skin.
  - b. Long-term contact can cause a variety of skin diseases that includes cancer.



- B. Light or penetrating oils are aerosol products that include rust-penetrating oil, silicone lubricant, liquid graphite, and belt dressing.
1. Light oils are used to lubricate precision parts because the lubricant gets into tight clearances and does not attract as much dust and dirt as heavier oils.
  2. Because they can dissolve some rust, rust-penetrating oils are used to aid in the removal of rusty bolts and fasteners.
  3. Liquid graphite dries to a slick, black coating that does not attract any dust or dirt. This makes it desirable for components with tiny moving parts, such as locks.
  4. Belt dressing is sprayed on drive belts to prevent slippage and quiet belts that dry out and get noisy.

**CAUTION: Aerosol cans are pressurized. The can must not be punctured or crushed, even when empty. The can should not be stored near heat or sparks. Never spray these products towards the body.**

- C. Standard and heavy oils are motor oil, automatic transmission fluid, power steering fluid, and gear lube.
1. Motor oils are used in vehicle engines and classified by viscosity or weight (e.g., 10W-30) and a two-letter grade (e.g., SJ and SL).
    - a. Refer to the manufacturer's recommendation for the correct viscosity and service classification for the vehicle being serviced.
    - b. Refer to the vehicle service information for the proper interval for changing the motor oil.
  2. Automatic transmission fluid (ATF) is available in three main types: Type F, Dexron II, and Dexron III.
    - a. ATF is used in all automatic transmissions and some manual-shift, front-wheel-drive transaxles.
    - b. Some vehicle manufacturers recommend using only their products that include specific additives. Refer to the manufacturer's recommendation when selecting and using ATF.



# INTRODUCTION TO AUTOMOTIVE TECHNOLOGY

---

3. Power steering fluid is similar to ATF. Refer to the manufacturer's recommendation when selecting and using power steering fluid.
  4. Gear lube is thicker than motor oil or ATF and provides superior lubrication between the large and highly stressed gears of manual gear boxes and differentials.
- D. Hydraulic fluids include hydraulic jack oil and brake fluid.
1. Hydraulic jack oil is used in shop equipment that has a hydraulic cylinder, such as jacks, engine hoists, lift racks, and forklifts.

**CAUTION: Do not add hydraulic jack oil to shop equipment without the permission and supervision of the instructor.**



2. Brake fluid is added to the master cylinder reservoir and clutch master cylinder in a hydraulic clutch system.
  - a. In America, brake fluids must be rated at least DOT-3 (Department of Transportation Specification #3).
  - b. Using the incorrect brake fluid can result in brake fade, the deterioration of rubber seals, or complete brake failure.
3. Most hydraulic fluids, especially brake fluid, attack and dissolve paint.

**NOTE:** If you suspect that brake fluid has contacted a painted surface, immediately wash that surface with soap and water.



- a. Cover fenders when adding brake fluid.
  - b. Thoroughly wash hands immediately after contact with brake fluid.
4. Hydraulic fluids, especially brake fluid, must be capped tightly to prevent dirt and moisture from contaminating the fluid.
    - a. Small amounts of moisture can turn to steam when brake fluid becomes hot during brake application. The steam reduces the effectiveness of the brakes.
    - b. Hydraulic fluids must be stored in a designated area away from heat, flame, or sparks.

- c. Never substitute other types of oil for hydraulic oil. Nonhydraulic oil may harm rubber seals or fail under the heat generated by the brake system.

## II. Types and uses of greases

- A. Grease is used when a lubricant must stay on parts for a long period of time and endure high pressure. When working with grease, follow the safety precautions below.



### **CAUTION: Wear PPE when working with greases.**

1. Greasy rags are also subject to spontaneous combustion. Greasy rags must be stored in a metal safety container with an airtight lid built for this purpose.
  2. Grease products must be stored in a designated area away from heat, flame, or sparks. Wipe up grease spills and clean the area immediately with soap and water.
  3. Avoid prolonged contact with greases.
    - a. Short-term contact can cause skin irritation, chapping, or drying of the skin.
    - b. Long-term contact can cause a variety of skin diseases that includes cancer.
- B. Multipurpose grease is suitable for lubricating such items as steering linkage components and wheel bearings.
    1. Multipurpose grease can also be used as an assembly glue when packing bearings into a manual-shift transmission.
    2. Read the information on the lubrication label before using multipurpose grease to be sure that it is recommended for the planned application.
  - C. Wheel bearing grease is suitable for steering linkage components as well as wheel bearings. If packing wheel bearings in a disc brake or high heat application, use an extreme-pressure (EP) wheel bearing grease compatible with the disc brakes.
  - D. Brake grease is applied in small amounts to the backing plate on vehicles equipped with drum brakes.

# INTRODUCTION TO AUTOMOTIVE TECHNOLOGY

---

- E. Cam lubricant is sometimes included with a new camshaft. The lubricant can help with breaking in the camshaft.
- F. White lithium grease is a general-purpose lubricant available in a tube or aerosol can. Uses of white lithium grease include hood hinges, door hinges, cables, linkage, and shop equipment maintenance.
- G. Stick lubricants are used on door strikers because they do not stain clothes.
- H. Some light-colored greases, such as white lithium grease, are not compatible with ATF and should not be used as an assembly glue or as a prelube for internal transmission parts.

**CAUTION: If noncompatible grease is used during automatic transmission assembly, components in the valve body of the transmission can become stuck, resulting in shifting problems.**

- I. Dielectric grease, available in a tube, is used to seal electrical connections to prevent voltage leakage and keep out dirt, corrosion, and moisture.
- J. Brake system silicone compound is a greaselike lubricant that comes in a tube. It is used to lubricate sliders, rubber parts, or plastic parts on brake systems.

### III. Types and uses of specialty additives

- A. Specialty additives include oil treatment, gas treatment, transmission conditioner, and starting ether. Refer to the container label for hazard warnings and handling procedures.

**CAUTION: Wear PPE when working with specialty additives.**

- B. Oil treatments are used to raise motor oil viscosity or to free sticking valves or lifters. Raising the motor oil viscosity can extend engine life by increasing oil pressure.

**NOTE:** Adding too much oil treatment can result in poor lubricating properties or oil that exceeds the proper viscosity, especially in cold weather.

- C. Gas treatment is used to help reduce moisture in gasoline and eliminate buildup of carbon, gum, and varnish in fuel lines. Gas treatment usually contains alcohol. Excessive amounts of methanol can destroy rubber carburetor or fuel system components and damage the lining of the fuel tank.





- D. Transmission conditioner is added to automatic transmission fluid to prolong the life of the fluid and improve the shifting performance of worn transmissions.
- E. Starting ether is sometimes used to start an engine in extreme cold. The directions for using starting ether must be followed carefully.

**CAUTION: Starting ether is extremely flammable and can create an explosion if the engine backfires.**

#### IV. Types and uses of specialty chemicals

**CAUTION: Wear PPE when working with specialty chemicals.**

- A. The two types of sealers are hardening and nonhardening.
  - 1. Hardening sealers form a hard seal between components. They are used to seal permanent assemblies and to fill gaps in irregular surfaces.
  - 2. Nonhardening sealers remain pliable. They are used in areas that are exposed to vibration, expansion, and contraction.
    - a. Room temperature vulcanizing sealer (RTV), typically available in a tube, is a special rubber that sets up at room temperature and forms a seal between components. RTV is used instead of a rubber or fiber gasket. It is aerobic, which means it cures when exposed to air.

**NOTE:** Some RTVs cannot be used on engines in vehicles equipped with components such as oxygen sensors or automatic transmissions.
    - b. Gasket sealers, applied with a brush or from a tube, help to ensure a good seal between gaskets and irregular surfaces. These sealers are anaerobic, which means they will cure only in the absence of air.
    - c. Thread sealant is used to seal threads and bolts that are exposed to liquids, usually either lubricating oil or coolant.
- B. Locking and antiseize compounds
  - 1. Locking compounds prevent a fastener from loosening by acting as a lock washer. Locking compounds have various strengths that range from “wrench removal” to “permanently bonded.”



## INTRODUCTION TO AUTOMOTIVE TECHNOLOGY

---

2. Antiseize compounds prevent threaded fasteners from becoming permanently bonded to another component and are used when the fastener is made of a different type of metal from the component to which it is attached.
- D. Two common adhesives are weather strip and gasket adhesive and rearview mirror adhesive.
1. Weather strip and gasket adhesive is used to glue gaskets to metal and weather strips to the vehicle's doors and trunk.
  2. Rearview mirror adhesive is used to glue inside rearview mirrors to the windshield.



# INTRODUCTION TO AUTOMOTIVE TECHNOLOGY

---

## UNIT III: CHEMICALS AND THEIR USE

### LESSON 3: GASES, ASBESTOS DUST, AND BATTERY ACID

#### I. Gases and the hazards they present

**NOTE:** Gases include those emitted from engine exhaust, vapors resulting from evaporating fuel, and gases stored in pressurized containers.



A. Internal-combustion gasoline engines emit a variety of gases. Carbon dioxide ( $\text{CO}_2$ ), water vapor, and sulfur dioxide ( $\text{SO}_2$ ) present few, if any, health risks. Gases in the exhaust that present the most serious health risks are carbon monoxide (CO), hydrocarbons (HCs), and oxides of nitrogen ( $\text{NO}_x$ ).

1. CO results from incomplete combustion of fuel and air in the engine.
  - a. When inhaled, it displaces oxygen in the blood that causes asphyxiation and death. CO has no noticeable odor, which makes it particularly dangerous.
  - b. To avoid CO poisoning, exhaust fumes must always be ventilated to the outside. Consult the instructor for the proper use of exhaust ventilation equipment.

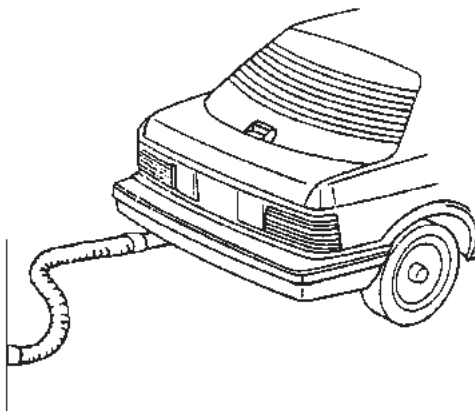

2. HCs contain hydrogen and carbon. Raw unburned gasoline is a HC. Exhaust gas contains small amounts of HCs.
  - a. Excessive levels of HCs causes nausea, vomiting, and possibly even cancer.

- b. To avoid inhaling HCs, exhaust fumes must always be ventilated to the outside. Consult the instructor for the proper use of exhaust ventilation equipment.
  3. NOx are produced during high combustion temperatures. NOx has a pungent odor and must be ventilated to the outside. Consult the instructor for the proper use of exhaust ventilation equipment.
- B. Fuel vapors, such as gasoline vapors, are extremely flammable and toxic. Gasoline vapors can be released from the fuel tank or other storage tanks and the engine carburetor. To avoid the risks of fire and explosion of fuel vapors, the following steps must be taken.
  1. Gasoline destroys many types of containers and must be stored in Underwriters Laboratory (UL) approved containers. These containers must then be stored in a metal safety cabinet away from sparks and heat.



**CAUTION: Never leave gasoline cans open or uncapped in the shop area. Fumes can collect and explode.**

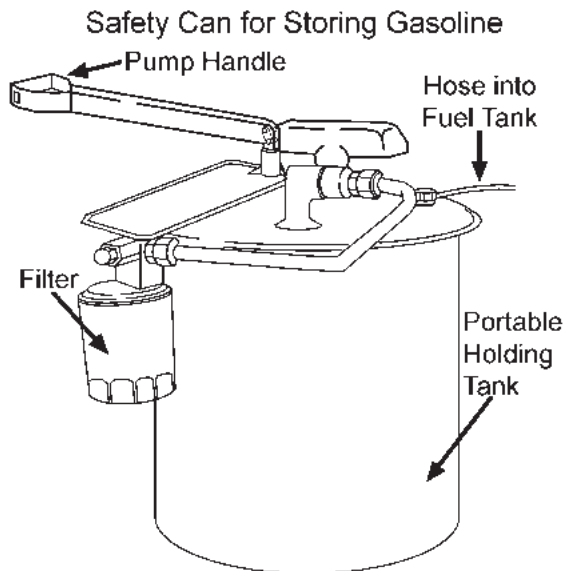

2. Avoid gasoline spills. Wipe up spills immediately. Disconnect and plug the fuel lines. Drain or siphon the fuel tank before removing from the vehicle.
      3. An empty fuel tank is dangerous because of gasoline fumes. Never attempt to weld a fuel tank. This must be done only by experienced professionals.



# INTRODUCTION TO AUTOMOTIVE TECHNOLOGY

---

4. Sparks and heat must be kept away from engine carburetors. Even empty carburetors may contain gasoline residue and fumes. Never make electrical ground connections to the carburetor.
  5. Consult the instructor for the proper disposal procedure in the shop. Never pour gasoline down a sink or into the sewer. Doing so is a serious violation of federal regulations.
- C. Gases from the vehicle's battery
1. Batteries produce hydrogen gas that can collect at the top of the battery. The gas can explode if exposed to a spark or flame.
  2. Keep sparks and flames away from the battery.
    - a. Inspect the battery in daylight, not with a lamp.
    - b. Do not wear jewelry that could contact the battery and create a spark.
    - c. Do not smoke or have open flames around the battery.
    - d. Connect battery cables properly and use tools carefully around the battery to prevent sparks.
- D. Stored gases
1. Propane is hydrocarbon gas that is usually stored in metal containers under pressure.
    - a. Propane is used in torches during some carburetor adjustments, vacuum leak detection, and catalytic converter tests.
    - b. Propane tanks must be stored away from heat and sparks. The tank must never be punctured. Never discard a propane tank that still contains pressure.

2. Acetylene is a synthetic hydrocarbon gas commonly used for the cutting and welding of metal.

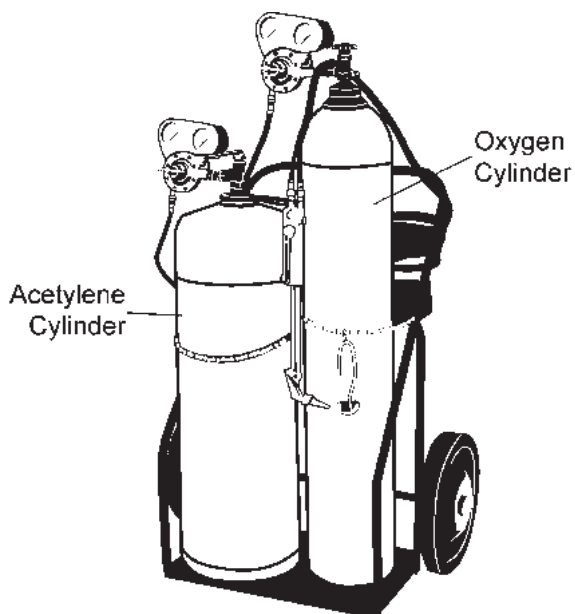

- a. Acetylene gas is extremely flammable and chemically unstable. Acetylene, in conjunction with oxygen, presents grave and unusual hazards.
- b. Only experienced technicians, who have had extensive safety training, should use an oxyacetylene torch set.
- c. Oil presents the most prominent danger because it can create an explosion in the presence of pure oxygen.

**CAUTION: Never allow oil to contact any part of an oxyacetylene torch set or use oxygen or acetylene as compressed air.**



- E. R-12, or Freon, is a refrigerant gas used in air conditioning systems prior to 1995. Since 1995, the environmentally safe R-134a has been used.
  1. Refrigerant should not be directly inhaled or exposed to open flame. Refrigerant is stored under pressure and creates extreme cold when released.
  2. Blindness can result if refrigerant contacts the eyes.

# INTRODUCTION TO AUTOMOTIVE TECHNOLOGY

---

3. The area should be well ventilated and personal protective equipment (PPE) must be worn.
4. Never allow a refrigerant container to be punctured or stored near heat.

Sample of a Refrigerant Container

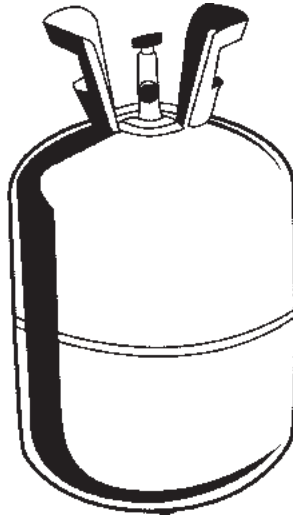

## II. The hazards of asbestos dust

**CAUTION: Asbestos dust from brake linings and clutch discs is a hazardous material that requires special precautions.**

- A. Until recently nearly all brake and clutch linings contained asbestos, a material that can withstand extremely high temperatures. Asbestos dust has been shown to cause lung cancer, even in minute quantities. For this reason, special care must be exercised during brake and clutch work.

**CAUTION: Some imported brake products may still contain asbestos.**

1. Never use compressed air to blow out brakes or clutches.
2. Wear a dust mask and use the proper dust evacuation system when working on brake systems.
3. All old brake linings and clutch discs must be returned to a tight-sealing box. Never leave these parts lying around the shop.



### III. The hazards of battery acid

- A. Vehicle batteries contain battery acid, also called electrolyte, which is a solution of 40% sulfuric acid and 60% distilled water. Sulfuric acid, made from sulfur dioxide, is a highly corrosive acid.
- B. Observe the following safety precautions when cleaning and handling a battery.
  - 1. Wear PPE (goggles, face shield, apron, and gloves) when inspecting, cleaning, or handling a battery.



**CAUTION: Do not allow battery acid to contact the skin or eyes because it causes serious burns and damage. The acid will burn holes in clothing as well.**

- 2. If battery acid contacts the skin, flush the area immediately with plenty of water.
- 3. If battery acid contacts the eyes, flush the eyes with water immediately for 30 minutes and seek medical attention.
- 4. Avoid rubbing the eyes or unprotected skin while working with a battery to prevent contact with the acid.
- 5. Wash hands immediately after working with a battery.
- 6. If acid spills in the shop, neutralize the acid with a mixture of baking soda and water, wipe up the spill, and rinse the area with clear water. If acid gets on clothing, flush the clothing with the baking soda and water mixture.

# INTRODUCTION TO AUTOMOTIVE TECHNOLOGY

---

## UNIT IV: BASIC HAND TOOLS

### CONTENTS OF THIS UNIT

- I. Unit objective
- II. Lesson plans
  - A. Lesson 1: Types of Wrenches
    - 1. Information outline
    - 2. Assignment Sheet
      - a. AS1-L1-UIV: Wrenches
  - B. Lesson 2: Types of Screwdrivers and Pliers
    - 1. Information outline
    - 2. Assignment Sheet
      - a. AS1-L2-UIV: Screwdrivers and Pliers
  - C. Lesson 3: Types of Hammers, Punches, and Chisels
    - 1. Information outline
    - 2. Assignment Sheet
      - a. AS1-L3-UIV: Hammers, Punches, and Chisels
- III. Unit IV Test



# INTRODUCTION TO AUTOMOTIVE TECHNOLOGY

---

## UNIT IV: BASIC HAND TOOLS

### UNIT OBJECTIVE

After completing this unit, students should be able to identify basic hand tools and their uses. Students will demonstrate mastery of the material by completing the assignment sheets and achieving a score of \_\_\_\_\_ on the Unit IV Test.

### SPECIFIC OBJECTIVES

After completing the lessons in this unit, students should be able to:

#### Lesson 1

- I. Identify the differences between metric and USCS wrenches.
- II. Identify the types and uses of common wrenches.
- III. Identify the types and uses of socket wrenches.
- IV. Identify the types and uses of other wrenches.
- V. Complete the assignment sheet on wrenches (AS1-L1-UIV).

#### Lesson 2

- I. Identify the types and uses of screwdrivers.
- II. Identify the types and uses of pliers.
- III. Complete the assignment sheet on screwdrivers and pliers (AS1-L2-UIV).

#### Lesson 3

- I. Identify the types and uses of hammers.
- II. Identify the types and uses of punches and chisels.
- III. Complete the assignment sheet on hammers, punches, and chisels (AS1-L3-UIV).





# INTRODUCTION TO AUTOMOTIVE TECHNOLOGY

---

## UNIT IV: BASIC HAND TOOLS

### LESSON 1: TYPES OF WRENCHES

#### I. Metric and U.S. Customary System (USCS) wrenches

A. All technicians should have a set of both metric and USCS (also called SAE) wrenches for loosening and tightening bolts and nuts.

1. Metric wrenches are sized per the measurement in millimeters (mm) of the jaw opening, from face to face. The jaw size is actually a little larger than the bolt or nut of the same size to allow the jaw to fit around the bolt or nut.

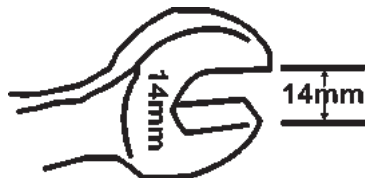

2. USCS wrenches are sized per the measurement in fractions of an inch of the jaw opening, from face to face. The jaw size is actually a little larger than the bolt or nut of the same size to allow the jaw to fit around the bolt or nut.



B. Metric and USCS wrenches are not interchangeable. For example, if removing a 14-mm nut, a 9/16-in wrench is close in size but is not the proper size to effectively remove the nut. The 9/16-in wrench may slip and round off the sides of the nut. A 14-mm wrench should be used.

#### II. Common wrenches

A. The open-end wrench turns nuts and bolts that have already been loosened. If too much torque or turning action is applied, it can round off the corners of nuts or bolts. The ends of the wrench are set at a 15° angle to reduce the distance the wrench is moved to grip the next side of the hex head.



- B. The box wrench completely encircles the nut or bolt to grip all the corners, which allows considerably more torque to be applied without stripping the nut or bolt. This wrench is particularly useful for loosening tight bolts and nuts. More time is required to turn loose bolts with the box wrench.



- C. The combination-end wrench is a combination open-end and box wrench. It is a favorite of technicians because of its multiple uses.



- D. A tubing wrench, or flare nut wrench, has ends with a portion of one side cut away so that the wrench may be slipped over a steel line. Each end partially encircles the hex head of a nut or bolt. Steel line fittings are usually brass and require this type of wrench to loosen a tight fitting without causing damage.



**NOTE:** In addition to the tubing wrench, an open-end wrench is used to firmly hold the fitting while attaching it to the steel line. Do not allow the steel line to become twisted.

- E. Maintenance

1. Wrenches should be kept free of dirt and grease and stored in a dry place to prevent rust.
2. Wrenches with distorted jaws should be discarded.

- F. Safety

1. Always use the proper size wrench. Do not use metric wrenches on USCS bolts or vice versa.
2. Do not use a wrench as a hammer or pry bar.

### III. Socket wrenches

- A. This wrench is so named because it has a cylindrical socket (in the size of the bolt) that fits down over the bolt, much like a box-end wrench.



# INTRODUCTION TO AUTOMOTIVE TECHNOLOGY

---

- B. The socket wrench is the preferred tool of most technicians when they work with nuts and bolts. Socket wrenches can be used in places that are inaccessible to common wrenches and are faster at removing bolts.
- C. The two basic parts of a socket wrench are the socket and bar or handle.
  - 1. Sockets come in metric and USCS sizes and are sized according to the size of the bolt head they fit and the size of the bar they take. They are available in four point types: 4 point, 8 point, 6 point, and 12 point, with the 6-point and 12-point sockets being the most commonly used.

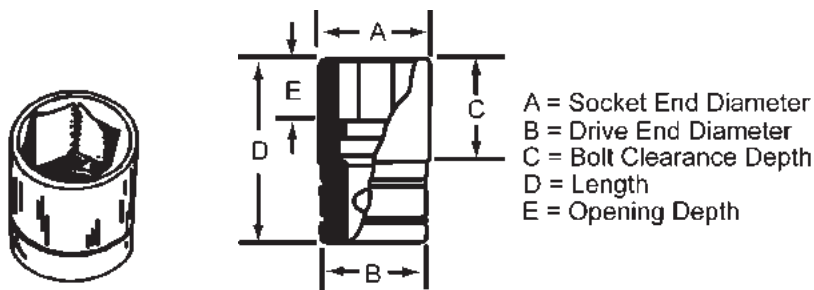

- a. A shallow 12-point socket is used for turning hexagonal bolt heads in tight places because it offers twice as many starting positions.
- b. A shallow 6-point socket is used for turning hexagonal bolt heads because it offers better grip and less chance of rounding off the bolt head when excess torque is used.
- c. A deep-well 12-point socket is used to turn nuts when a bolt or stud protrudes through the nut enough to prohibit the use of the shallow socket.
- d. A deep-well 6-point socket is used in the same situation as described above. It is particularly useful when there is a risk of rounding off tight nuts.
- e. Swivel sockets, or universal sockets, have a universal joint built into the socket drive end that allows bolts and nuts to be turned when it is not possible to get straight onto the head.



- f. Impact sockets are designed to withstand the great torque and impact delivered by air impact tools. An impact socket has thicker construction than a standard socket.

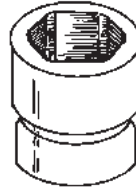

**CAUTION:** Do not use standard sockets on air impact guns because the socket may shatter.

2. Bars and handles are used to turn the sockets. The drive end is square and available in 1/4-in, 3/8-in, 1/2-in, and 3/4-in sizes.

**NOTE:** The 3/4-in size is used for large, heavy-duty bolts that are found in trucks. The 1/2-in size is used on large automotive bolts. The 3/8-in size is the most commonly used by technicians. For very small work, the 1/4-in size is used because of its compactness.

- a. The breaker bar is a sturdy handle that is used when great torque is required to loosen bolts and nuts. The end of the breaker bar can swing to allow clearance.

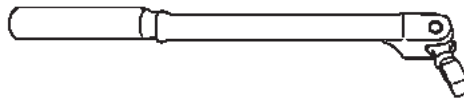

**NOTE:** The length of the handle on the breaker bar provides superior leverage for tight nuts and bolts.

- b. The ratchet is the most commonly used handle for turning sockets. By rotating back and forth, the ratchet turns nuts and bolts in areas of limited access without being removed after each partial turn.

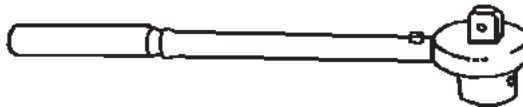

- The ratchet is not intended for use under extreme torque because the teeth on the ratchet mechanism may strip.
- Some ratchets have heads that swivel, which allows clearance while turning.



# INTRODUCTION TO AUTOMOTIVE TECHNOLOGY

---

- c. Extension bars aid in reaching recessed bolts and nuts by extending the ratchet drive end. Common extension lengths include 3 in, 6 in, and 12 in. Many other lengths are also available.



- d. Speed handles and T-handles are occasionally used to speed assembly. One advantage of these handles is they do not place side stress on the extension and socket. These handles are not used for the final tightening.

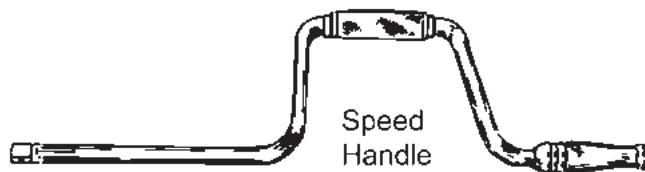

- e. A torque wrench is a special handle that indicates the amount of twisting force (torque) that is being applied in tightening a bolt.

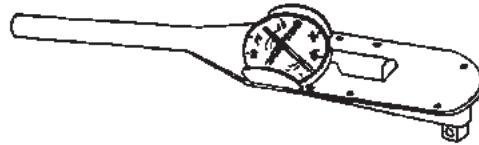

- This wrench is necessary when the torque of bolts must meet manufacturer's specifications.
- Some models have a scale or dial to indicate torque.
- Others click or release momentarily when the preset torque is reached.
- Most recently, electronic versions are available that have easily programmable and accessible torque settings and indicate torque by vibrating, producing an audible signal, and providing a digital display.

**NOTE:** Specifications for the torque of bolts are extremely important. If too much torque is applied, the surfaces being joined or the bolt/nut will be damaged. If too little torque is applied, the bolt may work loose.





- D. Occasionally, the technician must use a socket adapter on a socket to ease bolt removal.

**NOTE:** The torque capacity of the socket and ratchet must be considered so that the tool is not damaged or broken.

1. A size adapter allows the technician to use a different drive size socket on the ratchet or torque wrench.

**NOTE:** Care must be exercised when adapting large breaker bars down to smaller drive sockets because the torque capacity of the small socket may be exceeded.

2. A universal adapter operates best when a socket has limited access that prevents the ratchet and extension from engaging straight onto the socket. These adapters cannot withstand great amounts of torque.

E. Maintenance

1. Sockets and handles should be kept free of dirt and grease and stored in a dry place to avoid rust.
2. Ratchet handles can become worn and should be reconditioned if the ratchet starts to slip.

F. Safety

1. Ratchet handles can turn both counterclockwise and clockwise and the lever that switches the direction should be firmly and fully placed into its proper position.

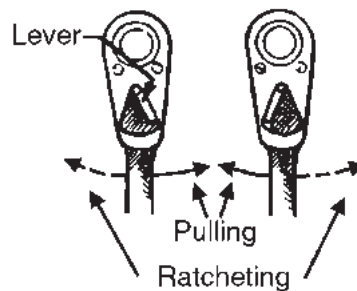

2. Do not use a ratchet handle as a hammer or pry bar.
3. The exact size socket must always be used. Damaged sockets should be discarded, because they can slip off a bolt.

# INTRODUCTION TO AUTOMOTIVE TECHNOLOGY

---

- a. When using a socket on a damaged bolt head, be especially careful so the wrench does not slip off and cause an injury to the knuckle or hand.
- b. Always be sure the socket is completely over the bolt head. If the bolt head is so damaged that the socket cannot fit completely over the head, use another method of removal.

## IV. Other wrenches

- A. An Allen wrench is used on hex head fasteners, which contain a cavity with six sides. A torx wrench is used on torx bolts, which contain a cavity of six rounded points. This design reduces the risk of stripping or disengaging the threads of small fasteners.

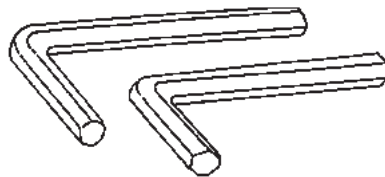

Allen Wrenches

- B. An adjustable wrench has a screw that allows the jaw to adjust to different sizes. Under normal circumstances, technicians do not use an adjustable wrench for turning nuts and bolts.

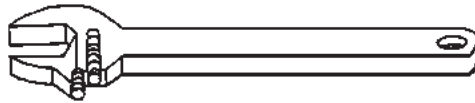

1. It has the disadvantage of not gripping as solidly as box-end wrenches, and unless properly adjusted and in good condition, may not grip as solidly as open-end wrenches.
  2. An adjustable wrench may be used if the technician does not have immediate access to the proper wrench and if torque requirements are not too high.
- C. Standard wrenches cannot be used on pipes because of the round shape of pipes. The pipe wrench has teeth that dig in as the wrench turns the pipe. The risk of scarring the pipe can be reduced by placing a leather strap between the pipe and the wrench teeth.

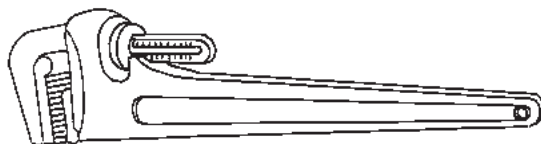





# INTRODUCTION TO AUTOMOTIVE TECHNOLOGY

---

## UNIT IV: BASIC HAND TOOLS

### LESSON 2: TYPES OF SCREWDRIVERS AND PLIERS

#### I. Screwdrivers

- A. The standard screwdriver has a straight blade for turning screws with a slot that is the same width and length as the screwdriver blade.

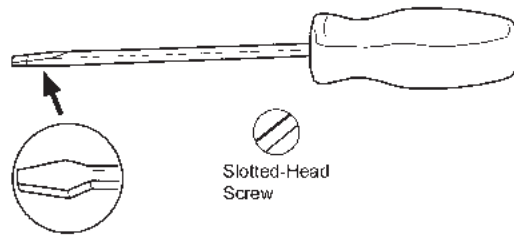

**CAUTION: The standard screwdriver is not intended for use as a pry bar, chisel, or gasket scraper. These misuses of the screwdriver can damage the tool and injure the technician.**



- B. The Phillips screwdriver fits the crossed slot of a Phillips screw. One advantage this screwdriver has over the standard one is when it is inserted in the slot, it is self-centering.

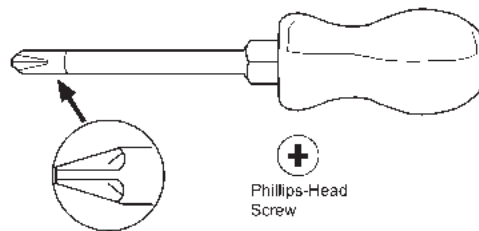

1. Phillips screwdrivers are available in various tip sizes (e.g., #0, #1, #2, #3, #4) with the lower number being the smallest.
2. A technician should not attempt to use a standard screwdriver to turn a Phillips screw.
3. A good deal of pressure must be applied when using a Phillips screwdriver or the tip may disengage the slot, damaging the screw or the tool.
4. If the slot of a Phillips screw is stripped, it will have to be drilled out.

- C. The Pozidriv screwdriver is similar to the Phillips in that it is used on a cross-slotted screw. However, the Pozidriv screwdriver and screw head have four additional points of contact.

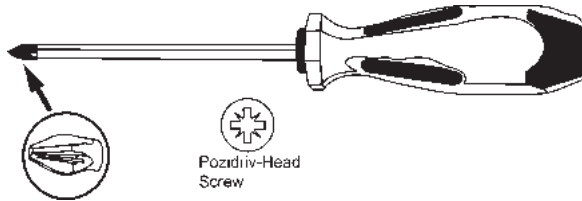

1. More torque can be applied with the Pozidriv screwdriver because the blade will not slip out of the screw head as easily as the Phillips screwdriver will.
  2. Although not recommended because of improper fit, a Phillips screwdriver will turn a Pozidriv screw. A Pozidriv screwdriver, however, will not turn a Phillips screw.
- D. The torx screwdriver has a 6-point tip that is used on torx-head screws.

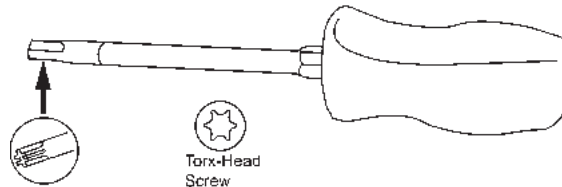

- E. Nut drivers have a handle and shaft like a screwdriver but have a socket at the end of the shaft that is not removable. Because nut drivers can be operated with greater speed than socket wrenches, they are ideal for loosening and tightening the small nuts and bolts found on vehicles.



- F. Maintenance
1. Keep screwdrivers free of dirt and grease and store them in a dry place to prevent rust.
  2. Keep the heads in good condition, free from nicks.
- G. Safety
1. The right size screwdriver should be used for each job.
    - a. The screwdriver should be the right length for access to leverage.

# INTRODUCTION TO AUTOMOTIVE TECHNOLOGY

---

- b. The head of the screwdriver should match the head of the screw (both type and size of the screw).
2. Do not try to use another tool, such as locking pliers, to grab the handle of the screwdriver and get more leverage. If it cannot be turned by hand, another tool is needed.
3. Use screwdrivers with insulated handles to prevent electric shock.
4. Do not use a screwdriver as a punch or chisel.

## II. Pliers

- A. Standard slip-joint pliers are one of the most common types of pliers used by technicians. These grip irregular parts and hold work during drilling.



- B. Locking pliers are very similar to standard slip-joint pliers. By turning a knob and then clamping the handles in place, the locking pliers hold work securely.



**CAUTION:** When clamping or removing locking pliers, keep a proper grip on the handles. The handles snap together and snap apart with considerable force.

- C. Adjustable-joint pliers have a long slot with a wide variety of adjustment positions. The offset jaws of the adjustable-joint pliers offer a reach advantage.

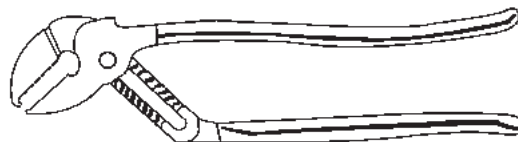

- D. Long-nose pliers, or needle-nose pliers, are useful for gripping tiny pins and parts during the service of carburetors and other small assemblies.



- E. Diagonal-cutting pliers are used to cut electrical wire and tape as well as a variety of other material. Diagonal-cutting pliers are well-suited for removing cotter pins on front-end components.

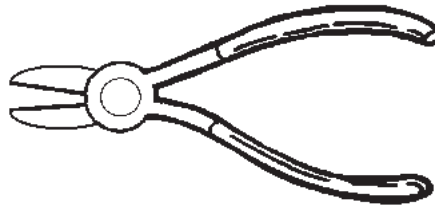

**CAUTION: Do not use on live electrical circuits.**

**CAUTION: Do not cut spring steel with diagonal-cutting pliers because the pliers will be nicked and ruined.**

- F. Snap-ring pliers come in many styles and types. Snap-ring pliers are required for spreading or compressing springy snap rings found in transmissions. Snap-ring pliers are available that can remove internal snap rings, external snap rings, or both.

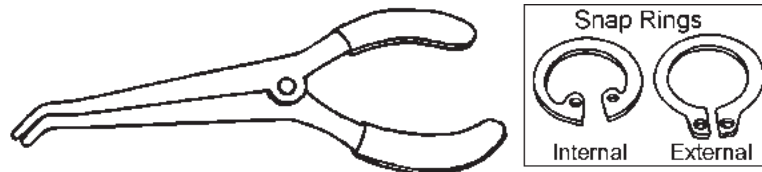

- G. Maintenance
1. Pliers should be kept free of dirt and grease and stored in a dry place to prevent rust.
  2. If the jaws of the pliers are held by a screw, the screw should be kept snug.



# INTRODUCTION To AUTOMOTIVE TECHNOLOGY

---

## H. Safety

1. When working near electrical equipment, use pliers with insulated handles.
2. Do not use pliers as a hammer.
3. Do not hammer on the handles.



# INTRODUCTION TO AUTOMOTIVE TECHNOLOGY

---

## UNIT IV: BASIC HAND TOOLS

### LESSON 3: TYPES OF HAMMERS, PUNCHES, AND CHISELS

**CAUTION:** Wear protective eyewear at all times when using a hammer, punch, or chisel to protect the eyes from flying metal chips. Never strike one hammer with another, because hammer heads are very brittle and metal chips can fly off.



#### I. Hammers

- A. The ball peen hammer is the most common hammer used for driving punches and chisels. It has a domed head on one side and a flat head on the other.



- B. A hand-held sledgehammer can be used when a great deal of driving power is required.

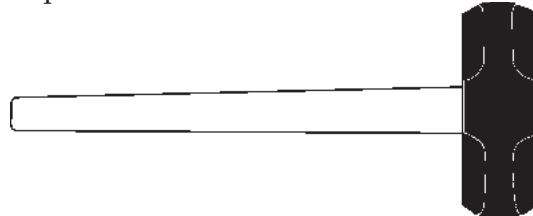

- C. A soft-faced hammer can be used to avoid damage to the work being driven. The head can be made of brass, bronze, rubber, or rawhide as these materials do minimal damage to iron and steel components.

- D. A plastic-tip hammer is used when light driving power is needed and a brass hammer could cause damage.

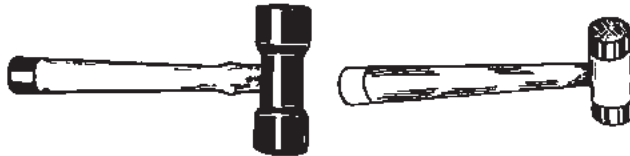

**CAUTION:** Do not use this hammer to drive punches and chisels. It will destroy the plastic tip.



- E. A rubber mallet is useful for installing wheel covers. Always strike the wheel cover evenly around the perimeter.

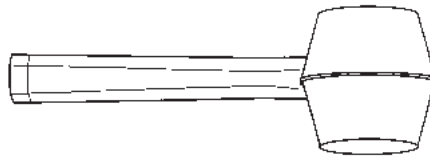

- F. Maintenance

1. Hammers should be kept free of dirt and grease, with the faces smooth and free of all foreign matter.
2. Hammers should be stored in a dry place to prevent rust.

- G. Safety

1. Always be sure the head is secured firmly on the handle.
2. Be sure the handle is in good condition.
3. Strike a flat-surfaced hammer flat against the object being struck, not at an angle.

## II. Punches and chisels

- A. Punches

1. A taper or starting punch is the most commonly used punch. This punch is designed to drive out rivets after the heads have been removed. It is also used to punch out straight and tapered pins.



2. A pin punch is used when a small roll pin must be driven through a hole.



3. The center punch is used to make a small dimple in metal prior to drilling. This mark helps ensure that the hole will be drilled in the proper place and that the drill bit will not move.





# INTRODUCTION TO AUTOMOTIVE TECHNOLOGY

---

4. A brass or bronze punch is used when in an area where flammable liquid or gasoline is present. This ensures that no sparks will be created.



## B. Chisels

1. The standard cold chisel is used to cut and remove metal. The end of the chisel should be ground to a sharp point on a 60° angle.



2. Different chisel shapes are available for particular jobs. The shapes include the round nose, diamond point, and half round. These chisels are used to cut or chip metal.



Round Nose



Diamond Point



Half Round

## C. Maintenance for punches and chisels

1. When the head of the punch or chisel mushrooms, the mushrooming must be ground off with a grinding wheel.
2. When the cutting edge of the punch or chisel becomes dull and chipped, it must be sharpened with a grinding wheel.
3. After a certain amount of maintenance with the grinding wheel, the punch or chisel becomes too short or the edge becomes too blunt. When this happens, it should be discarded.
4. Punches and chisels should be kept free of dirt and grease and should be stored in a dry place to prevent rust.

## D. Safety for punches and chisels

1. Always wear heavy gloves and safety glasses when working with punches and chisels.

2. Grind down a mushroomed head immediately. The mushroomed metal may fly off and cause injury. Also, the hammer slips off of a mushroomed head more easily.
3. Punches should be tapped gently rather than with brute force. Usually several light hits on the head work better for all purposes than a heavy hit.
4. Use a chisel holder to minimize the risk of missing the chisel and hitting a hand.

# INTRODUCTION TO AUTOMOTIVE TECHNOLOGY

---

## UNIT V: SPECIALTY TOOLS, FASTENERS, AND MEASURING TOOLS

### CONTENTS OF THIS UNIT

- I. Unit objective
- II. Lesson plans
  - A. Lesson 1: Specialty Tools
    - 1. Information outline
    - 2. Assignment sheet
      - a. AS1-L1-UV: Specialty Tool Uses
  - B. Lesson 2: Fasteners
    - 1. Information outline
    - 2. Assignment sheet
      - a. AS1-L2-UV: Common Vehicle Fasteners
  - C. Lesson 3: Measuring Tools
    - 1. Information outline
    - 2. Assignment sheet
      - a. AS1-L3-UV: Use and Care of Measuring Tools
- III. Unit V Test



# INTRODUCTION TO AUTOMOTIVE TECHNOLOGY

---

## UNIT V: SPECIALTY TOOLS, FASTENERS, AND MEASURING TOOLS

### UNIT OBJECTIVE

After completing this unit, students should be able to identify the types and uses of specialty tools, fasteners, and precision measuring tools. Students will demonstrate mastery of the material by completing the assignment sheets and achieving a score of \_\_\_\_\_ on the Unit V Test.

### SPECIFIC OBJECTIVES

After completing the lessons in this unit, students should be able to:

#### Lesson 1

- I. Identify the types and uses of specialty tools.
- II. Complete the assignment sheet on specialty tool uses (AS1-L1-UV).

#### Lesson 2

- I. Identify common fasteners used on vehicles.
- II. Identify tools and methods for cutting threads, repairing damaged threads, and removing broken bolts.
- III. Complete the assignment sheet on common vehicle fasteners (AS1-L2-UV).

#### Lesson 3

- I. Identify the types and uses of measuring tools.
- II. Identify the procedures for the use and care of measuring tools.
- III. Complete the assignment sheet on the use and care of measuring tools (AS1-L3-UV).



# INTRODUCTION TO AUTOMOTIVE TECHNOLOGY

---

## UNIT V: SPECIALTY TOOLS, FASTENERS, AND MEASURING TOOLS

### LESSON 1: SPECIALTY TOOLS

#### I. Types and uses of specialty tools

##### A. Special cutting tools

1. Hacksaws cut metal parts to size or shape and remove damaged fasteners.
  - a. The hacksaw cuts on the forward stroke only and is lifted on the return stroke.



- b. Hacksaws are sized according to blade length. When installing the blade, point the teeth away from the handle and tightly secure the blade.

**CAUTION:** Always wear safety glasses and heavy gloves when using a hacksaw. The blade can break. In addition, be sure to firmly secure the object being sawed.



2. Tubing cutters cut without bending, kinking, or scarring the tubing.

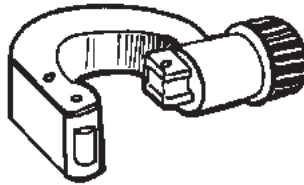

- a. The cutter is placed on a piece of tubing and tightened as it is rotated.
  - b. Tubing cutters vary in size according to the diameter of the tube they are designed to cut.

3. A hand reamer smooths or enlarges holes. Both straight and tapered reamers are used. Straight reamers may be either fixed in size or adjustable through a specific cutting range.



4. Files smooth or shape metal. Files are designed in various shapes for different tasks and have different teeth designs for fine or rough work.

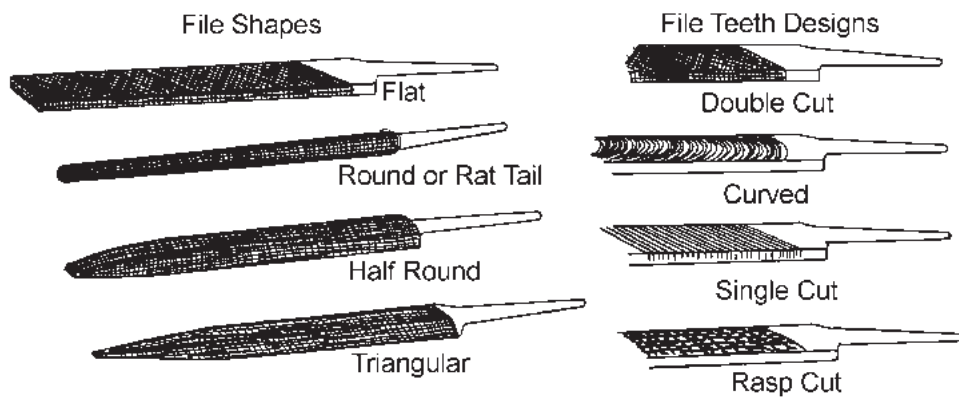

**CAUTION:** Use a handle on the file to prevent hand injury. Never hammer on or use a file as a pry bar. Files are brittle and can shatter with dangerous results.



**CAUTION:** Always wear safety goggles and heavy gloves when working with a file.



# INTRODUCTION TO AUTOMOTIVE TECHNOLOGY

---

## B. Electrical system tools

1. The digital multimeter (DMM) checks the condition of electrical system components.

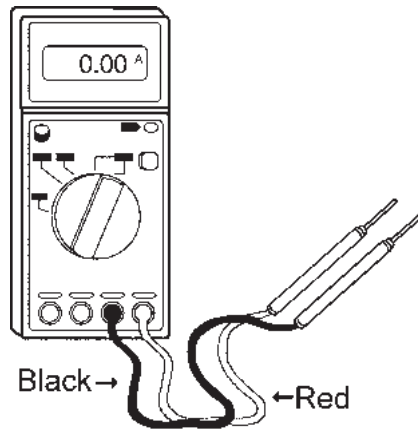

- a. This test device is a voltmeter, ohmmeter, and ammeter all in one.
  - b. A DMM has two leads, one black and one red. One end of the lead is plugged into the DMM. The other end is a probe.
2. A scan tool is used to diagnose electrical problems. The tool is connected to the vehicle's data link connector (DLC) to retrieve diagnostic trouble codes (DTCs) and engine sensor information that are generated by the vehicle's on-board diagnostics system.

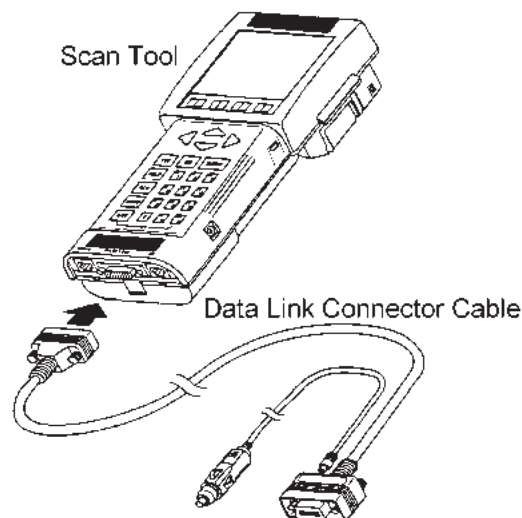

3. An oscilloscope, or scope, is a voltmeter that displays voltage in relation to time, showing voltage vertically and time horizontally. Its connections are similar to a DMM.

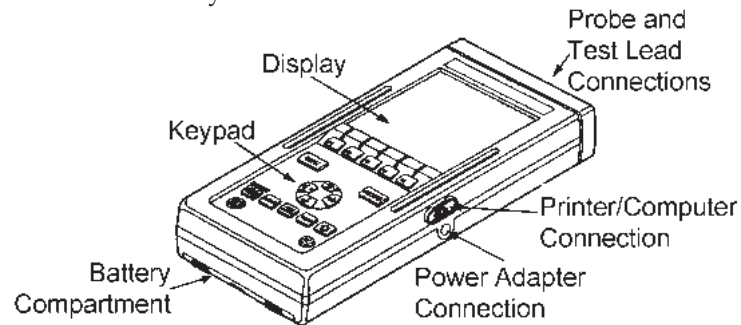

- a. It produces a line on a cathode ray tube (CRT) or liquid crystal display (LCD) when connected to circuit voltage.
- b. A circuit problem can be found by comparing the line "pattern" to a known good pattern.
4. The continuity light checks power in various circuits. One end of the light is grounded and the other end is pressed into the electrical device.

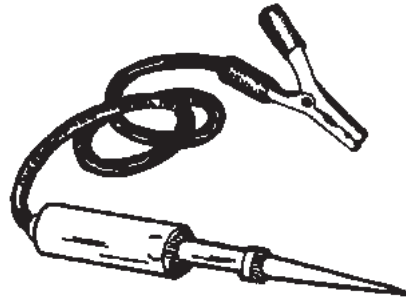

**NOTE:** The continuity light should never be used to check the power supply of electronic components.

5. A timing light determines if the ignition system is delivering electric charge to the spark plugs at the correct time.

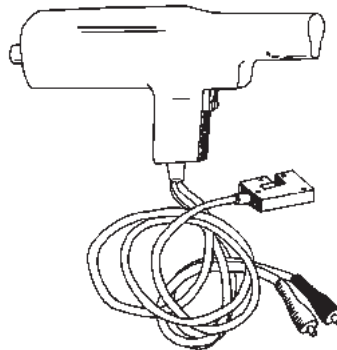

Note...

# INTRODUCTION TO AUTOMOTIVE TECHNOLOGY

---

6. The remote starter switch allows the technician to use the starter to crank the engine without actually being in the vehicle.

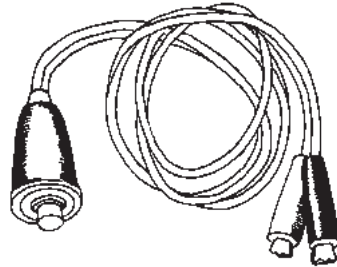

## C. Battery specialty tools

1. A cable puller removes the cable from the battery terminal without breaking the cable or battery posts.

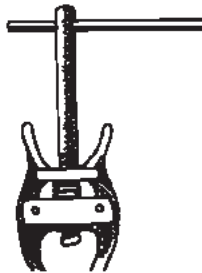

2. Terminal and post cleaners clean the posts and terminal ends.

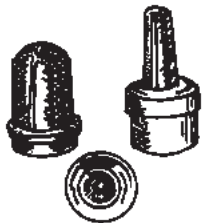

3. A battery lifting tool and carrying strap lifts and transports the battery safely.

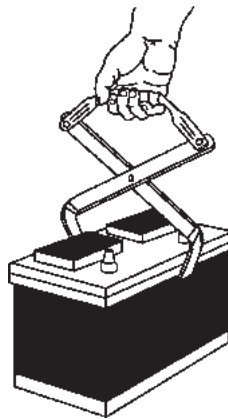

## D. Lubrication specialty tools

1. A transmission funnel is a funnel with a long, small, flexible neck that is ideal for adding transmission fluid.

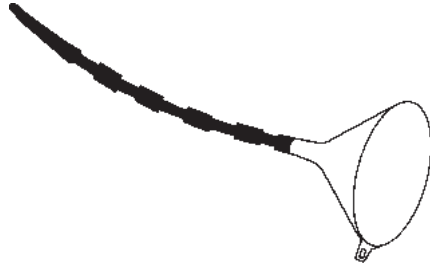

2. An oil filter removing tool is a wrench or socket adapter that fits around an oil filter to remove it.

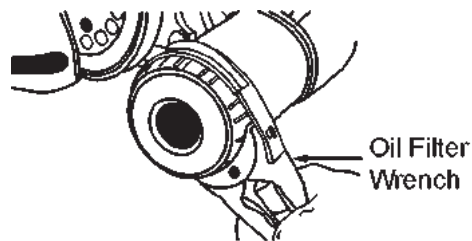

3. A grease gun forces grease into fittings. Pressure is created by hand action on the gun's lever.

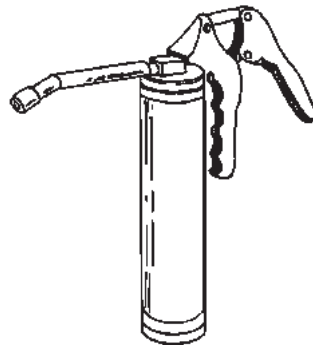

## E. Miscellaneous specialty tools

1. A blowgun uses compressed air to clean or dry various items in the shop.



# INTRODUCTION TO AUTOMOTIVE TECHNOLOGY

---

2. The C-clamp is a holding device that is commonly used to compress the calipers on floating caliper disc brake systems.

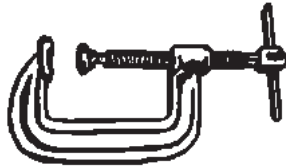

3. A puller set functions to remove objects (e.g., gears, bearings) that are pressed onto a shaft, pull objects (e.g., retainers, oil seals) from various openings, and remove shafts (e.g., pinion shafts, transmission shafts) from another object.
4. Pressure gauges test the air and fluid pressure in various components such as the tires, oil pump, and fuel pump.
5. Vacuum gauges check the condition of the engine and various vacuum-operated components. Gauges compare the pressure in a component to atmospheric pressure at sea level.

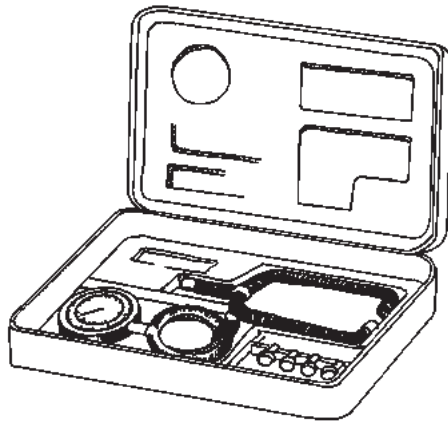



# INTRODUCTION TO AUTOMOTIVE TECHNOLOGY

## UNIT V: SPECIALTY TOOLS, FASTENERS, AND MEASURING TOOLS

### LESSON 2: FASTENERS

#### I. Common vehicle fasteners

**NOTE:** Vehicles use many types of fasteners to hold various components together and technicians need to be familiar with each type. Some of the more common types of threaded fasteners include nuts and bolts, washers, screws, and studs. Other common fasteners include snap rings, rivets, and adhesives.

**NOTE:** American automobile manufacturers have largely switched to the metric system of sizing fasteners and threads.

#### A. Nuts and bolts in the U.S. Customary System (USCS)

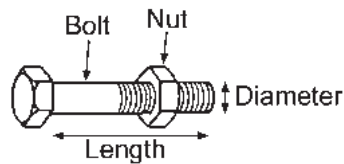

1. Bolt diameters come in increments of  $1/16$  in, starting with  $1/4$  in. The measurement is the overall diameter of the bolt threads.

**NOTE:** It is easiest to measure the unthreaded or shank portion of the bolt.

2. The length of a bolt is its effective length measured from under the head to the end of the threads. Bolt lengths usually come in  $1/4$ -in increments, starting from  $1/2$  in. The longest bolts normally used in the field are 6 in.
3. Thread type is either fine or coarse. Do not thread fine-threaded bolts into coarse threads or vice versa.

**NOTE:** Nuts are very difficult to measure for diameter, so it is usually best to trial fit the nut onto a bolt and then measure the bolt.



4. Thread size is determined by measuring the number of threads per inch. A thread gauge, available in both metric and USCS, can be used to determine the thread size of bolts.

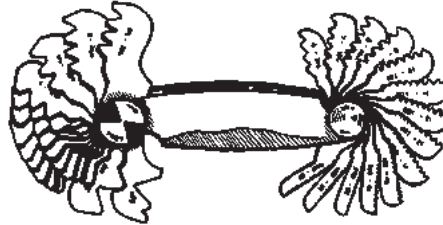

5. The strength of a bolt is important. A bolt that is not strong enough can break. The strength or hardness of a bolt is determined by counting the points or slashes on the head of the bolt.



**CAUTION: Never substitute a bolt with one of less strength. A lower strength bolt may break and cause injury and system failure.**

- a. Grade 1 or 2 bolts have no points and are unsuitable for automobile assembly due to their unknown and possibly low strength.
- b. Grade 5, or 3-point, bolts have three points on the head. These bolts are the most common in automobile assembly.
- c. Grade 8, or 6-point, bolts have six points on the head. These bolts are expensive but very strong and are used in high-stress conditions. Examples of grade 8 bolts include harmonic balancer bolts, flywheel bolts, and steering linkage bolts. Never substitute a lower grade bolt for a grade 8.



Grade 1 or 2



Grade 5



Grade 8

6. Right-hand thread nuts and bolts are the most common and turn clockwise to tighten. Left-hand thread nuts and bolts also are available that turn the opposite way. Left-hand nuts and bolts have notches cut at the corners of the hex head or the letter "L" stamped on them.



# INTRODUCTION TO AUTOMOTIVE TECHNOLOGY

---

**NOTE:** Very old automobiles (built before 1960), Chrysler products up until the early 1970s, and Ford vans up through the mid 1980s have left-hand thread wheel lugs only on the driver's side.



## B. Nuts and bolts in the metric system

1. The diameter of a metric bolt or nut is measured in the same way as in the USCS; however, the diameter of a metric bolt is expressed in millimeters.
2. The bolt is measured for its effective length from under the head to the end of the threads.
3. Thread size in the metric system is determined by measuring the distance from the crest of one thread in millimeters to the crest of the next thread.
4. Metric bolt strength is indicated by a number stamped on the bolt head. This number is called the property class. Examples of property class numbers include 4.6, 4.8, 5.8, 8.8, 9.8, and 10.9. The higher the number, the stronger the bolt.

**CAUTION:** Never substitute a bolt with one of less strength. A lower strength bolt may break and cause injury and system failure.

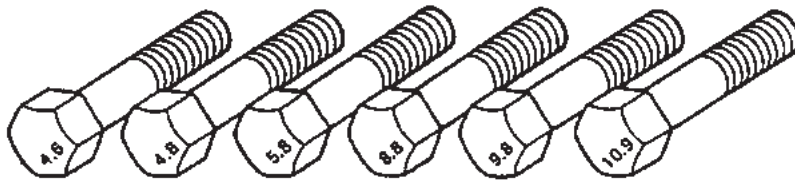

## C. Washers are frequently used with threaded fasteners.

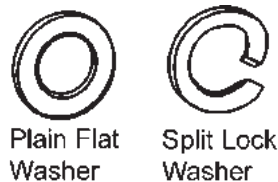

1. They fit onto a bolt or screw between the surface being fastened and the nut, or under the bolt or screw head.
2. They have two main functions.
  - a. Improve the fastening ability by increasing the area that is clamped

b. Prevent the bolt or nut from damaging the part surface

D. Many sizes and types of screws are used to fasten automotive parts. Two of the more common types are the following:

1. Machine screws are used in threaded holes to clamp small parts together.

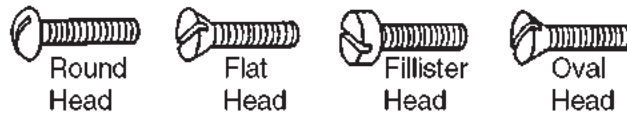

2. Self-tapping screws (also called sheet metal screws) have hard, tapering threads that make their own threads when driven into a surface.



E. Studs have threads on each end and no head. Some studs have threads throughout their length.



1. Fastening with studs is accomplished by threading one end of the stud into a part, placing another part over the stud, and fastening the other end of the stud with a nut.

2. Studs are useful for achieving accurate alignment of parts.

F. Snap rings (also called retaining rings) are used to hold components such as shafts, bearings, and gears in place.

1. Internal snap rings fit in a groove inside an opening and external snap rings fit in a groove on the outside of a part.

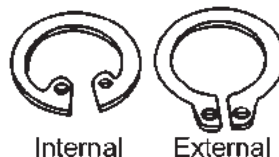

2. Snap-ring pliers are required for installing and removing snap rings.

# INTRODUCTION TO AUTOMOTIVE TECHNOLOGY

---

- G. A rivet is a nonthreaded metal pin with a head on one end. Rivets are available in different designs and are typically made of copper, steel, or aluminum.

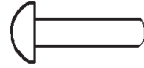

1. Rivets are used to fasten parts that are not usually taken apart.
  2. Parts are joined together with a rivet by putting the rivet through a hole in the parts and hammering the headless end with a ball peen hammer or hammer and rivet set until the end is rounded.
  3. Rivets are removed by cutting off the head with a chisel and driving out the pin with a punch.
- H. Various types of adhesives, or glues, are used to bond parts together. Parts that may be glued include trim, moldings, and various plastic and rubber parts.

**CAUTION: When using adhesives, it is important to follow the manufacturer's specifications because some adhesives are toxic, flammable, and harmful if inhaled.**



- II. Cutting threads, repairing damaged threads, and removing broken bolts
- A. Using a tap to cut threads into a hole
1. Types of taps
    - a. The taper tap is the most commonly used tap because the taper allows easy starting. It cannot cut threads to the bottom of a blind hole, a hole that does not go completely through the metal.
    - b. The plug tap cuts threads part of the way to the bottom of a blind hole.
    - c. A bottoming tap cuts threads all the way to the bottom of a blind hole but cannot start the cutting process. A taper tap must be used before the bottoming tap.

- d. The machine screw tap cuts the small-diameter threads of numbered screw sizes.

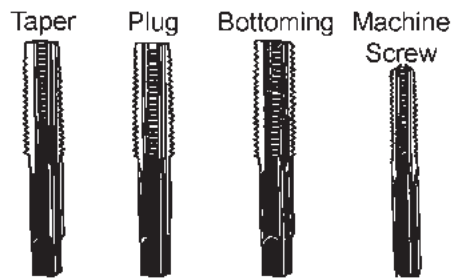

2. The sequence for cutting threads with a tap is shown below.

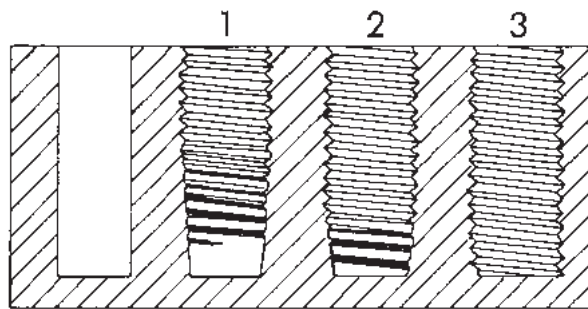

3. General procedure for using a tap

**CAUTION:** Before drilling a hole to cut threads, choose the correct drill bit size for the thread size. Failure to use the correct drill bit size can result in a broken tap or inadequate thread depth.

- a. First apply a thread cutting oil.  
b. Start the handle with the tap straight and then make a half turn.

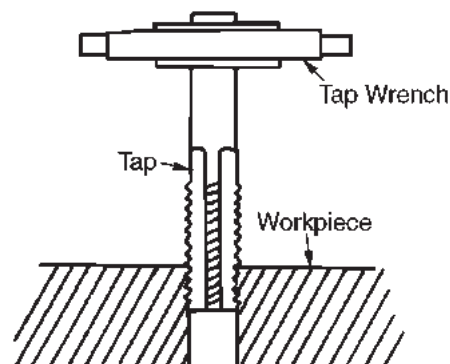

# INTRODUCTION TO AUTOMOTIVE TECHNOLOGY

---

- c. After each partial turn, back the tap off until the metal chips begin to break loose.
- d. Repeat this process until all of the needed threads are cut. Add oil as needed during the process.

## B. Using a die to cut threads onto a rod

1. A special die stock holds the die for the cutting process.

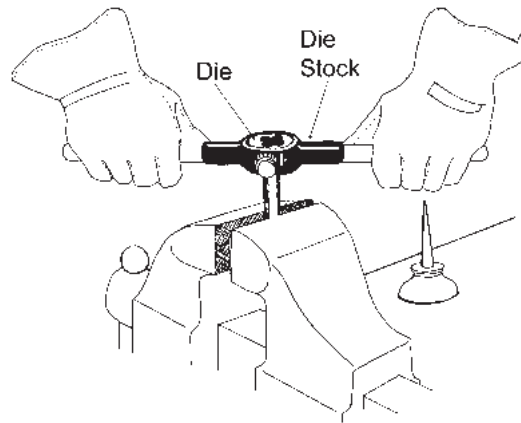

2. Dies are selected in the same manner as taps, but the die can be improperly placed in the die stock. The die should be positioned in the die stock so that the tapered end engages the rod first.
3. General procedure for using a die
  - a. First apply a thread cutting oil.
  - b. Put the tapered side of the die on the rod.
  - c. Start the die stock with the die straight and then make a half turn.
  - d. After each partial turn, back the die off until the metal chips begin to break loose.
  - e. Repeat this process until all of the needed threads are cut. Add oil as needed during the process.

## C. Procedures for repairing damaged or stripped threads

1. Chasing threads involves using a standard tap or die to run through existing threads of the same size. The purpose of this procedure is to correct small imperfections that interfere with the threading of the nut or bolt.



**NOTE:** Use a thread cutting oil during this procedure.

2. When threads in a hole are so severely damaged that they cannot be adequately repaired by chasing, a helicoil can be installed to restore the threads back to their original sizes. The basic steps for this procedure are as follows:
    - a. Completely drill out the old, damaged threads with a drill bit supplied in the helicoil kit.
    - b. Tap with a special tap from the kit.
    - c. With a special handle, screw in an insert that looks like a spring or coil. The inside of this coil is the same as the original thread of the hole.
  3. A thread insert can also be used to repair damaged threads. The insert is almost identical to the helicoil but is somewhat larger. It is retained in place by driving down four pins around the insert.
  4. Thread repair cement can be used on low-torque applications. The cement is applied to the bolt, and the bolt is then placed back into the damaged hole. New threads are molded as the glue-like substance hardens.
- D. Procedures for removing a bolt that is broken off in a threaded hole because of overtightening
1. A screw extractor can be used to remove bolts. The screw extractor has flutes or grooves that spiral in a counterclockwise direction.
    - a. Drill a hole in the center of the broken bolt.
    - b. Insert a screw extractor in the hole.
    - c. Use the tap handle to rotate the extractor and bolt counterclockwise and remove them as a unit from the bolt hole.
  2. Remove a bolt that is not bound to the threaded hole.
    - a. Drive a sharp punch into the center of the bolt.
    - b. Use pliers to retrieve the bolt.

# INTRODUCTION TO AUTOMOTIVE TECHNOLOGY

---

**NOTE:** Breakage due to the wrong thread design, a cross-threaded bolt, or a bolt that is bottomed out in the hole can make removal difficult. Drill out the bolt and retap the hole. Use the correct bolt and start it into the hole with the fingers.







# INTRODUCTION TO AUTOMOTIVE TECHNOLOGY

## UNIT V: SPECIALTY TOOLS, FASTENERS, AND MEASURING TOOLS

### LESSON 3: MEASURING TOOLS

#### I. Types and uses of common measuring tools

**NOTE:** Some vehicle components, particularly in the engine and transmission, contain precision machined parts that require precise measurements for inspection or replacement.



- A. The outside micrometer is used when an outside measurement must be accurate to .001 in or less. Parts requiring these measurements include crankshafts, pistons, valves, and camshafts.

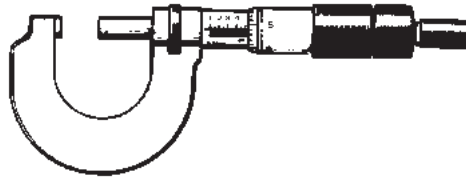

- B. The inside micrometer is used when a measurement of the diameter of a hole must be accurate to less than .001 in. Examples of such holes are cylinder bores and main bearing bores.

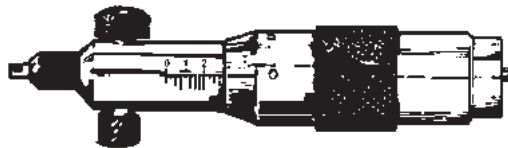

- C. The depth micrometer makes precise depth measurements of holes or cavities. For example, it can be used to measure the distance from the center of the crankshaft to the top of the engine block (deck height) and the distance from the top of the piston to the top of the engine block (piston deck clearance).

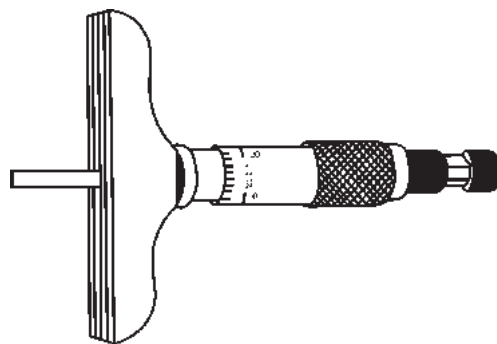

- D. The dial indicator tool measures thrust, back-and-forth movement, and runout (side-to-side play). These measurements are made on valves, crankshafts, and flywheels. The dial indicator can also measure the backlash or movement between gear teeth.

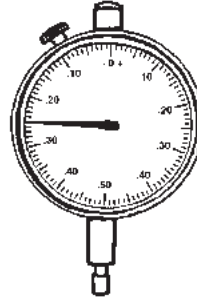

- E. A feeler gauge measures air gaps and clearance between moving parts and has numerous flat leaves of different specific thicknesses.

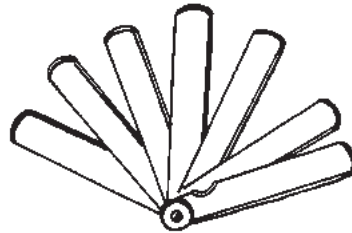

- F. A dial caliper is used for inside, outside, and depth measurements. One application is measuring bolts and small machined parts.

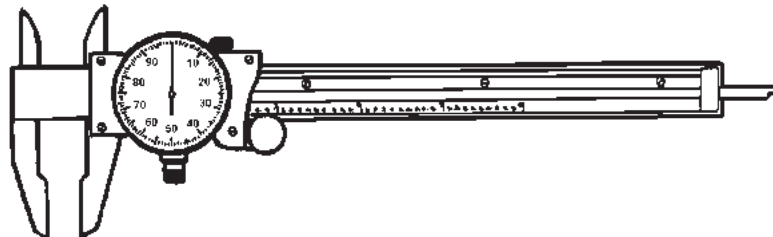

- G. Plastigage is a tiny strip of clay-like material that measures clearances such as between engine bearings and their journals and main bearings and connecting rod bearings. The strips are color coded according to the clearance range.

### II. Procedures for the use and care of measuring tools



**CAUTION:** The proper care and use of precision measuring tools are critical to the accuracy and long life of the tool. An incorrect measurement can result in expensive component failure.

# INTRODUCTION TO AUTOMOTIVE TECHNOLOGY

## A. Use an outside micrometer.

1. Before using an outside micrometer, become familiar with its parts. See the illustration below.

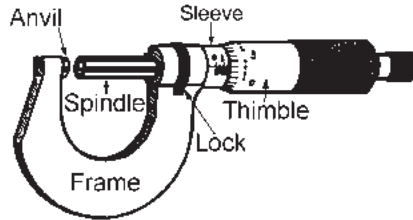

2. Read the outside micrometer.

**NOTE:** The outside micrometer does not readily display the measurement. Some addition is required in order to arrive at the micrometer reading. The technician must develop a feel for the outside micrometer in order to achieve accurate results.



- a. Place the object to be measured between the anvil and spindle and turn the thimble until the object is lightly contacted by the anvil and spindle. Lock the spindle and remove the micrometer from the object.
- b. Read the number indicated on the micrometer sleeve (upper scale). Each number represents one tenth (.100) of an inch.
- c. Add 25 thousandths (.025) of an inch for each additional line showing on the sleeve (lower scale) past the number.
- d. Add the number of thousandths (.001) of an inch indicated on the thimble.
- e. Add the number of inches of the minimum dimension that the micrometer can read 0 in through 5 in.

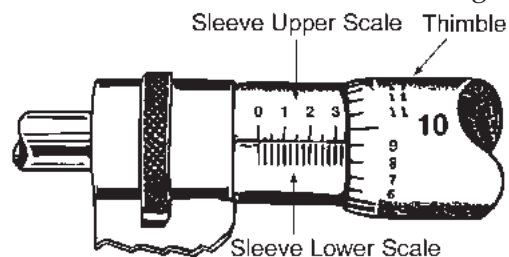

- ## B. Reading an inside micrometer and depth micrometer is similar to reading an outside micrometer. Be sure to add the correct figure for the minimum measurement.

- C. Use the dial indicator.
1. Securely attach the dial indicator so it will not move and give inaccurate readings. The dial indicator is positioned with a clamp-on base or with a magnetic base.
  2. Position the plunger against the part being measured.

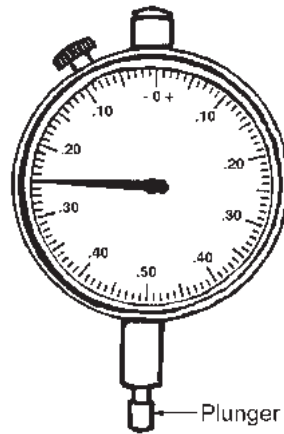

3. Rotate the indicator until the needle is on zero. If making a thrust measurement, the shaft or gear that is to be measured must first be pried one way.
  4. Rotate the part for runout measurements or pry the gear or shaft for thrust measurements, and note the reading in thousandths of an inch on the dial.
- D. Use the feeler gauge.

1. Select a sample leaf and make a trial fit between the two surfaces.

**NOTE:** The thickness of the leaf is printed on the leaf.

2. If the leaf is too loose or too tight, try another leaf.
3. When there is a slight, smooth drag as the feeler gauge is removed, the correct leaf has been found. The size printed on the feeler gauge is the clearance.
4. After use, put a little oil on the leaves to prevent rust.

- E. Use a dial caliper.

**NOTE:** A dial caliper is accurate to approximately + or - 0.002 in. When more precision is required, use a micrometer.



# INTRODUCTION TO AUTOMOTIVE TECHNOLOGY

---

1. Before using a dial caliper, become familiar with its parts. See the illustration below.

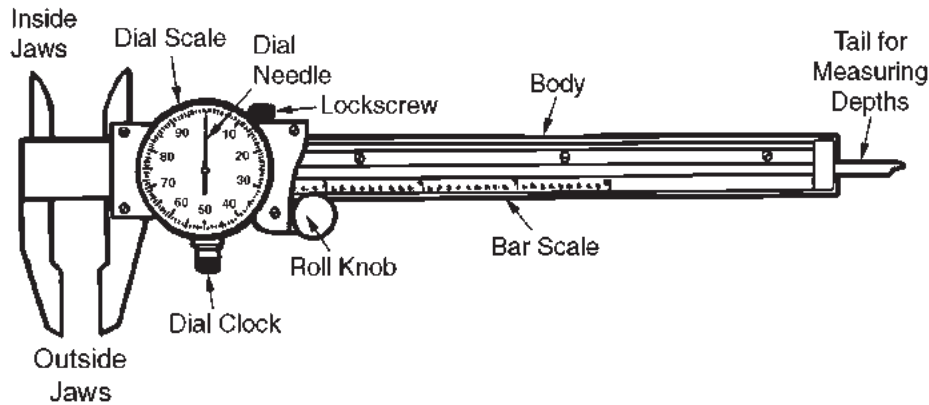

2. Adjust the dial caliper with the roll knob until the jaws lightly contact the work.
  3. Read the measurement on the linear scale and add the reading on the dial.
- F. Use Plastigage.
1. Select a small piece of Plastigage material.
  2. Place the Plastigage material on the crankshaft journal. The Plastigage piece must span the full width of the journal and be centered with the bearing cap.
  3. Install the bearing cap and tighten to the proper torque.
  4. Remove the bearing cap and inspect the Plastigage. It should appear somewhat smashed. Compare the width to the paper gauge on the Plastigage package.
- G. Care of measuring tools
1. Adjust precision measuring tools carefully. For example, only very slight pressure is needed to tighten the thimble on a micrometer. Overtightening can destroy the adjustment.
  2. Do not attempt to adjust measuring tools with the lock on.
  3. Always store measuring tools in their case or in a safe place to protect them from damage, grease, dirt, and moisture.

4. Check the calibration of precision measuring tools frequently. Consult the manufacturer's instructions for the proper procedure.

# INTRODUCTION TO AUTOMOTIVE TECHNOLOGY

---

## UNIT VI: POWER TOOLS AND SHOP EQUIPMENT

### CONTENTS OF THIS UNIT

- I. Unit objective
- II. Lesson plans
  - A. Lesson 1: Power Tools
    - 1. Information outline
    - 2. Assignment sheet
      - a. AS1-L1-UVI: Power Tools and Their Uses
  - B. Lesson 2: Shop Equipment
    - 1. Information outline
    - 2. Assignment sheet
      - a. AS1-L2-UVI: Shop Equipment Use
- III. Unit VI Test





# INTRODUCTION TO AUTOMOTIVE TECHNOLOGY

---

## UNIT VI: POWER TOOLS AND SHOP EQUIPMENT

### UNIT OBJECTIVE

After completing this unit, students should be able to identify characteristics and the proper use of power tools and equipment used in the automotive field. Students will demonstrate mastery by completing the assignment sheets and achieving a score of \_\_\_\_ on the Unit VI Test.

### SPECIFIC OBJECTIVES

After completing the lessons in this unit, students should be able to:

#### Lesson 1

- I. Identify the principles of using various types of power tools.
- II. Identify the characteristics and safe use of power drills.
- III. Identify the characteristics and safe use of power wrenches.
- IV. Identify the characteristics of miscellaneous power tools.
- V. Complete the assignment sheet on power tools and their uses (AS1-L1-UVI).

#### Lesson 2

- I. Identify the characteristics and safe use of electrical equipment.
- II. Identify the characteristics and safe use of pneumatic equipment.
- III. Identify the characteristics and safe use of hydraulic equipment.
- IV. Complete the assignment sheet on shop equipment use (AS1-L2-UVI).



# INTRODUCTION TO AUTOMOTIVE TECHNOLOGY

---

## UNIT VI: POWER TOOLS AND SHOP EQUIPMENT

### LESSON 1: POWER TOOLS

#### I. Principles of using power tools

##### A. Electric tools

**NOTE:** Electric hand tools are still in use in shops, but some have been replaced by pneumatic (air-operated) equipment, which is usually lighter.



1. Electric tools are driven by an electric motor.
2. Using electrical equipment is a matter of common sense and using good safety practices.
3. Safety
  - a. As with any electrical devices, be aware of the dangers of electric shock.
  - b. Do not stand on wet ground or a wet surface when operating an electric tool.
  - c. Always check that the power cord will not be damaged by the operation of the equipment and do not run over power cords with any heavy object.
  - d. Always check that the power cord is not frayed or worn.
  - e. All electric tools must have a three-pronged plug unless the tool is double insulated. Double-insulated tools cannot short to the outside case and require only a two-prong plug.

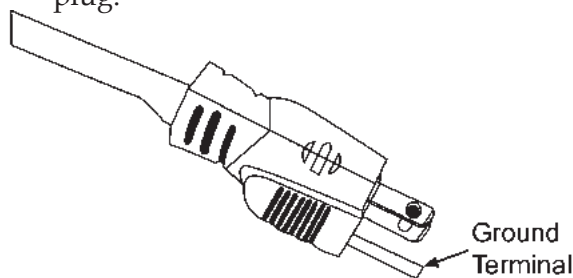

- f. Do not eliminate the ground terminal of a three-prong plug by using an adapter or clipping the terminal.

- g. Do not put cords in water or across moving machinery.
- h. Wrap up cords carefully after use and store them properly.
- i. Keep hands and clothing away from the moving parts of electrical equipment.
- j. When inspecting or making adjustments to electric tools, always disconnect them from the power supply.

#### 4. Maintenance

- a. Check the service manual for the equipment being used.
- b. Electrical equipment should be kept free of dirt and grease and should be stored in an area that is dry and free of dust.

#### B. Pneumatic tools

- 1. Pneumatic tools are powered by compressed air.
- 2. Pneumatic tools have advantages over electric tools. They are lighter and, unlike electric tools, are not damaged by overloading or stalling.
- 3. Although there are dangers associated with compressed air, the dangers are not as great as those associated with electricity.
- 4. Safety
  - a. Operate air tools only for their intended purpose.
  - b. Air impact guns, air hammers, and air drills can create flying metal chips that are dangerous to the eyes. Wear protective eyewear at all times when working with or around air tools.



**CAUTION: Wear personal protective equipment (PPE) when flying metal chips are possible.**

- c. Pneumatic tools produce a great deal of power. Using an improper attachment or placing the attachment on the tool incorrectly can result in breakage. Use only impact sockets on air impact guns.

# INTRODUCTION TO AUTOMOTIVE TECHNOLOGY

---

- d. Water and oil can accumulate in air compressors. These should be drained daily. It is possible for compressed air to carry infection even with daily draining.

**CAUTION: Do not play with compressed air blowguns or hoses. The high-pressure air stream on the skin can cause severe infection, require the amputation of a limb, and cause death.**



- e. Pneumatic tools create a great deal of noise. Wear ear plugs, ear muffs, or other types of ear protection.
  - f. Do not look into the air-outlet valve or nozzle on any piece of air-powered equipment.
  - g. Do not grab the movable portion of an air-powered tool with the hand when it is hooked up to the air line.
  - h. When inspecting or making adjustments to pneumatic tools, always disconnect them from the air supply.
5. Maintenance of pneumatic equipment
- a. Before any new air tool is used, three or four squirts of flushing oil should be applied to the air inlet to flush any dirt or moisture from the rotor and to lubricate the moving parts. Do not use flushing oil around an open flame – the flushing oil is flammable.
  - b. Oil pneumatic tools regularly according to manufacturer recommendations.
  - c. Pneumatic equipment should be kept free of dirt and grease and should be stored in an area that is dry and free of dust.
  - d. Care should be taken that no foreign matter enters the nipple opening of the couplings on pneumatic equipment.
6. Basic designs of pneumatic tools
- a. Rotary – The air drives a rotor (turbine) that spins a shaft and provides the power.
  - b. Reciprocating – The air drives a piston that is forced back and forth by the compressed air.



**NOTE:** The exceptions to the above two kinds are blowguns and paint-spraying equipment, which use a direct stream of air.

7. Pneumatic couplings
  - a. Pneumatic equipment is connected to air supply equipment through quick couplers.
  - b. The quick coupler is on the end of the air supply hose and connects into a nipple on the equipment.
  - c. On some tools, the manufacturer recommends attaching a short leader hose to the tool and installing the nipple at the end of the leader hose.
  - d. The quick coupler operates by pulling back a collar on the coupler, which allows the nipple to be inserted into the coupler. When the collar is released, it locks the nipple into the coupler.

## C. Cordless tools

1. These tools use a battery cell as the power supply, instead of electricity from a wall outlet.
2. They are convenient in shops due to portability and the absence of power cords; however, frequent recharging is necessary.
3. Safety
  - a. Always disconnect a cordless tool from its battery before inspecting it and making adjustments to it.
  - b. Use only the battery specified by the manufacturer for the tool being used.
  - c. Always store battery packs safely so that no metal can come in contact with the terminals. Contacting the terminal can short-circuit the battery and cause sparks, fire, or burns.

# INTRODUCTION TO AUTOMOTIVE TECHNOLOGY

---

## D. Hydraulic tools

**NOTE:** Most hydraulic tools fit in the category of shop equipment, which is discussed in the next lesson.



1. Hydraulic tools use pressurized fluid within a cylinder to create great pressure.
2. The fluid is hydraulic fluid, a petroleum product that is much like oil.
3. The hydraulic pressure within the tool is created by air pressure or the manual pumping of a handle.
4. Common hydraulic tools and equipment used in the shop include jacks, lifts, hoists, and presses.
5. Safety
  - a. Before operating a hydraulic tool, inspect its parts to make sure none are damaged or deteriorated.
  - b. Keep hydraulic hoses away from potential damage such as grease, oil, sharp objects, and hot surfaces.
  - c. Before using a hydraulic tool, consult the manufacturer's information to be sure it is appropriate for the task and that the task will not exceed the tool's load limit.
  - d. Check hydraulic tools frequently for leaks. Leaks can cause the tool to fail, with dangerous results.
6. Maintenance
  - a. Check the service manual for the tool being used.
  - b. Inspect tool components and report any damage, leaks, or deterioration to the instructor.

## II. Power drills

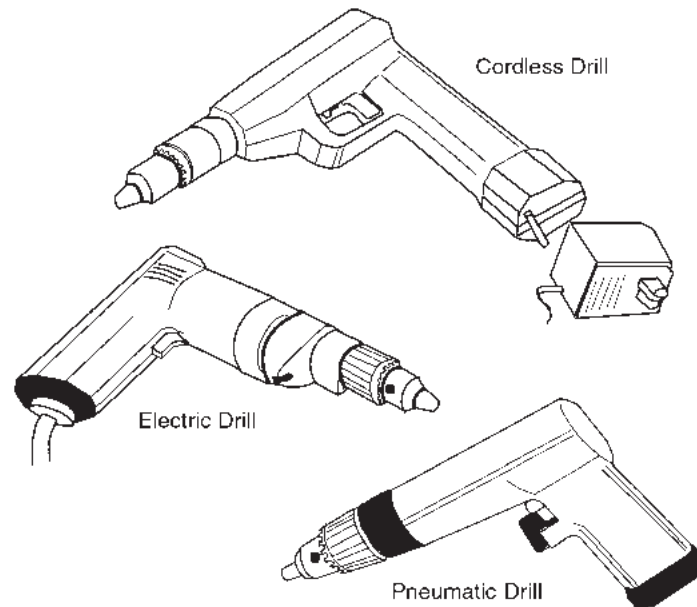

- A. Electric drills can be used interchangeably with pneumatic drills.
- B. Drills are used with drill bits to drill holes or with special attachments to remove rust or gasket material.
- C. Electric drills use an electric motor to drive a chuck, a device that holds the drill bit in place and aligns it properly. Pneumatic tools use a rotor, which drives the chuck.
- D. A chuck key is used to loosen and tighten the chuck. Drills are also available with keyless chucks.

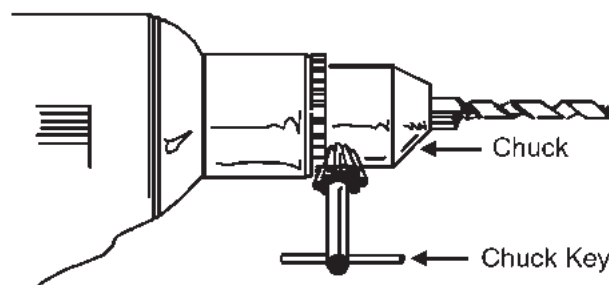

- E. The size of the drill is determined by the maximum diameter of the drill bit shaft that the chuck holds. For example, a 1/4-in drill holds a drill bit with a shaft diameter no larger than 1/4 in. The most popular sizes are 1/4 in, 3/8 in, and 1/2 in.



# INTRODUCTION TO AUTOMOTIVE TECHNOLOGY

---

## F. Drill bits

1. Drill bits come in various sizes and lengths and are interchangeable between electric and pneumatic drills. When looking for a particular size of drill bit, use a drill gauge.
2. Drill bits are made of high-grade steel and, if used properly, they seldom need sharpening.
3. Drill bits are sized according to the size of hole they drill. Do not use metric drills in place of United States Customary System (USCS) drills or vice versa. If a 12-mm hole is required, use a 12-mm bit.

## G. Safety for power drills

1. Make sure the bit is tightly seated in the chuck, securing it by turning the chuck key in each hole. Be sure to remove the chuck key before starting the drill.
2. Make sure the work is firmly secured before starting to drill.
3. Keep a firm grip on the drill and be ready to shut it off if it jams. Drills often jam just as they are about to penetrate what they are cutting.
4. If an electric drill jams, turn the drill off and pull it back out, then start it and continue to drill the hole. The same procedure should be performed for restarting a pneumatic drill. Such jamming may damage an electric drill.
5. Remove the bit from the drill when the work is completed.

## III. Power wrenches

### A. Impact wrenches

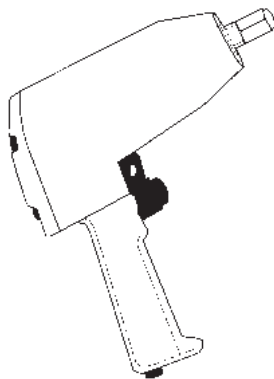

1. These tools can be either pneumatic or electric and are used to drive impact sockets to loosen or tighten nuts and bolts.
2. They use sockets that are specially made to have greater strength than standard sockets.
3. The wheel torque socket, also called torque stick, is a type of socket commonly used with impact wrenches.

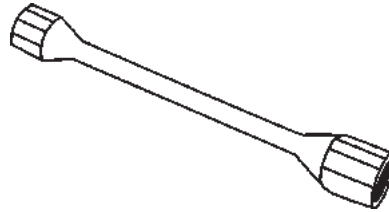

- a. Torque sticks are long-shafted sockets that work in combination with an impact wrench to install lug nuts on wheels.
- b. They are designed to flex when the proper torque is reached, helping to prevent the damage that can result from overtightening.
- c. The sticks are color coded per socket diameter and torque limit.

**CAUTION: Torque sticks are designed for tightening lug nuts, not loosening them; using torque sticks to loosen lug nuts will damage the sticks.**

4. Using impact wrenches
  - a. A built-in regulator allows for adjustments in speed and torque. However, do not rely on the regulator to adjust the amount of torque accurately. Final tightening should be done with a torque wrench.
  - b. Hold the wrench with a slight forward pressure on the bolt or nut.
  - c. Soak rusty bolts and nuts with penetrating oil before using an impact wrench to loosen them.
  - d. A switch can change the impact wrench from counterclockwise to clockwise operation.



# INTRODUCTION TO AUTOMOTIVE TECHNOLOGY

---

## B. Air ratchet

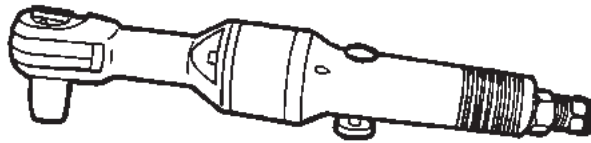

1. Is a smaller version of the impact wrench and usually uses a 1/4-in or 3/8-in drive lug
2. Delivers less force than the impact wrench and standard sockets may be used with it
3. Has a switch to change it from clockwise to counterclockwise rotation

**NOTE:** An air ratchet should be used only to snug a bolt. A conventional ratchet or torque wrench should be used to complete the tightening of a bolt.



## C. Air chisel (air hammer)

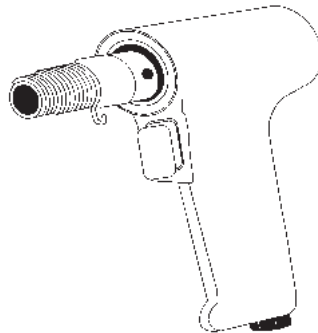

1. Uses reciprocating motion to provide rapid impact force, much like a rapid series of short hammer blows
2. Attachments available include cutters, chisels, and punches
3. Often used to break welds loose, cut rivets, punch holes, and shear sheet metal

## D. Safety for power wrenches

1. Always wear PPE when using power wrenches.
2. When operating an impact wrench, only use sockets that are made for impact wrenches. If a standard socket is used, it may break or be damaged and fly off of the tool.

3. Be sure that the chisel in the air chisel is firmly secured and that the cutting edge is sharp.

#### IV. Miscellaneous power tools

##### A. Heat guns

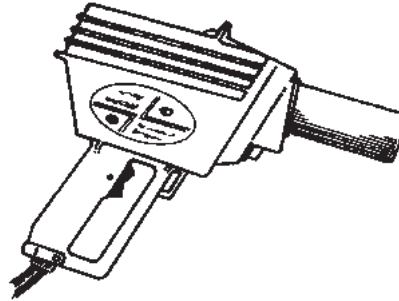

1. Heat guns are hand-held heaters that use forced air passing through heated coils.
2. They are used in various repair procedures to soften, loosen, and thaw vehicle components. Specific uses include softening vinyl; loosening sleeves/trim and adhesives; thawing frozen locks, wipers, and weather strips; and heating decals for easy removal.

##### B. Tire burnishing tool

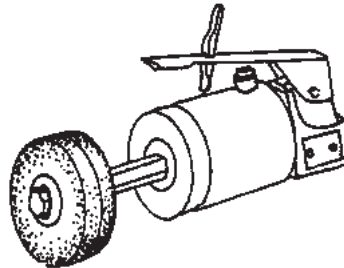

1. The tire burnishing tool is used for tire repair.
2. The wheel makes the rubber on the inside of the tire rough. This prepares the rubber for the application of a tire patch.

# INTRODUCTION TO AUTOMOTIVE TECHNOLOGY

---

## C. Mini die grinder

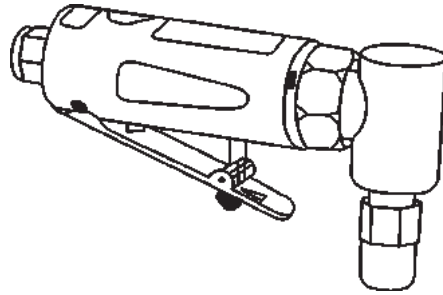

1. A mini die grinder is used for cutting metal; removing gasket material; and cleaning brake rotors, backing plates, and pad mounts.
2. The grinder illustrated has a head angled at 90° for easy access and handling.

## D. Blowguns

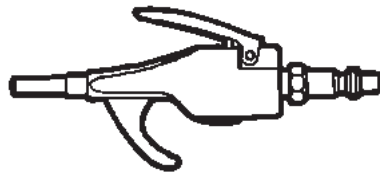

1. A blowgun is a pneumatic attachment that directs a small, powerful stream of air.
2. A blowgun is used to clean and dry surfaces to be painted and to clean dust from shop equipment.

**CAUTION:** Only blowguns that have an approved pressure limiter should be used in the shop. A proper blowgun attachment limits the maximum pressure to 30 pounds per square inch (psi).





# INTRODUCTION TO AUTOMOTIVE TECHNOLOGY

---

## UNIT VI: POWER TOOLS AND SHOP EQUIPMENT

### LESSON 2: SHOP EQUIPMENT

**NOTE:** The term “shop equipment” refers to large or expensive pieces of equipment or tools, which are generally provided by the shop owner.



#### I. Electrical equipment

##### A. Shops equipped to mount tires have a wheel balancer.

1. Many shops now use computerized wheel balancers. Wheel balancers are used to equally distribute weight around the wheel's centerline.

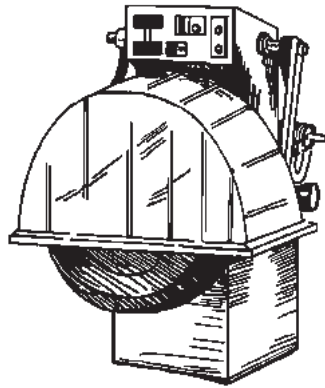

2. Safety
  - a. Consult the instructor before using the wheel balancer.
  - b. As with any electrical devices, be aware of the dangers of electric shock.
  - c. Do not stand on wet ground or a wet surface when operating electrical equipment.
  - d. Ensure the guards are in place before operating the wheel balancer. Be aware of the rotating mass that could cause injury if contact is made.

B. A bench grinder is a common piece of shop equipment.

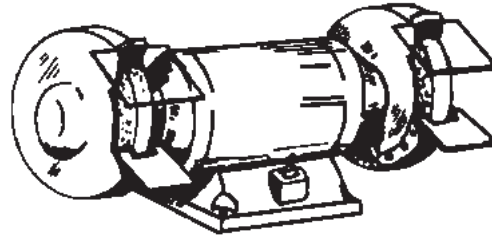

1. A bench grinder is generally used to maintain tools that have become dull and to grind sharp edges from metal pieces.
2. The grinder is mounted to a bench and is powered by an electric motor.
3. In addition to the grinding wheel, the grinder can be used with a wire wheel that cleans rust and dirt off parts.
4. Safety
  - a. As with any electrical devices, be aware of the dangers of electric shock.
  - b. Always wear safety glasses and a particle mask when working with a bench grinder. Wear a respirator, as needed, for grinding certain materials.
  - c. Be sure that clothing, hair, and other combustibles in the area are protected from the sparks given off by the grinder.
  - d. The bench grinder should have a tool rest platform in front of each abrasive wheel, in addition to a wheel guard and an eye shield.
  - e. Do not put excessive pressure on the wheel because it could break apart. Do not use wheels that are broken or worn.
  - f. Follow the bench grinder manufacturer's recommendations for removing and replacing grinding wheels. Do not overtighten the spindle nut.
  - g. When grinding small parts, never hold the parts by hand. The parts can be very hot and easily propelled through the air by the wheel. Use standard slip-joint pliers to hold small parts.



# INTRODUCTION TO AUTOMOTIVE TECHNOLOGY

---

- h. Abrasive wheels are designed for specific types of metals. Do not grind aluminum on grinding wheels designed for steel. Aluminum chips will clog the wheel's surface.
- C. Some shops have a drill press for drilling holes in metal parts.

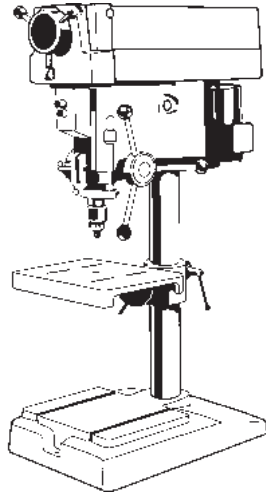

- 1. Maintenance
    - a. Inspect bits regularly. Sharp bits cut better and are less likely to break.
    - b. Oil the bit as needed to prevent binding.
  - 2. Safety
    - a. As with any electrical devices, be aware of the dangers of electric shock.
    - b. A full face shield and protective eyewear should be worn.
    - c. Parts drilled by the press must be securely held by a vise or standard slip-joint pliers. This prevents the work from spinning out of control and cutting hands.
    - d. When using the drill press, do not wear loose clothing or jewelry. Do not allow long hair to hang freely.
- D. A variety of electrical test and service equipment can be found in the shop. Each piece of equipment has its unique safety considerations. Consult the instructor before using a new piece of equipment.

- E. General maintenance guidelines for electrical equipment
  - 1. Check the service manual for the equipment being used.
  - 2. Electrical equipment should be kept free of dirt and grease and should be stored in an area that is dry and free of dust.
- II. Pneumatic equipment can be permanently attached to the shop air compressor or temporarily attached to the compressor by rubber hoses.
  - A. An air compressor provides the compressed air needed to operate pneumatic hand tools and equipment in the shop.

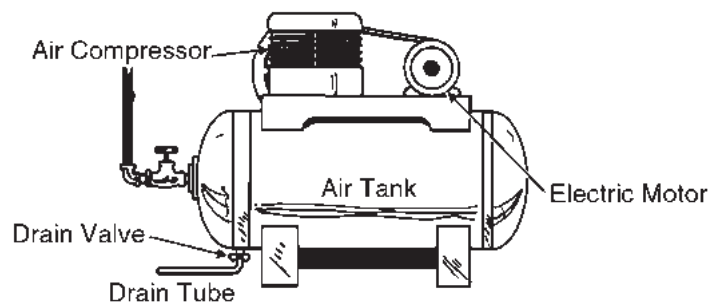

- 1. Compressors are usually operated by an electric motor and are composed of the following three main parts.
  - a. Motor
  - b. Compressor
  - c. Storage tank
- 2. The motor drives a compressor that takes in the air around it, compresses it into a smaller volume (thus increasing pressure), and then stores the compressed air in a large storage tank.
- 3. Maintenance
  - a. Check the oil each week and maintain the oil at the proper level.
  - b. Drain water from the tank and check the air-safety valve each day.
  - c. Change the oil, check the belt condition and tension, and clean the air-intake breather per manufacturer's recommendations.

# INTRODUCTION TO AUTOMOTIVE TECHNOLOGY

---

4. Safety
  - a. Always disconnect an air compressor from the power before inspecting or making adjustments to it.
  - b. Before operating an air compressor, inspect its parts to make sure none are damaged.
  - c. Make sure the electrical outlet for the air compressor is properly grounded.
  - d. Water and oil can accumulate in air compressors. These should be drained daily. It is possible for compressed air to carry infection even with daily draining.

**CAUTION: Do not play with compressed air blowguns or hoses. The high-pressure air stream on the skin can cause severe infection, require the amputation of a limb, and cause death.**



- e. Air hoses should not be run over with vehicles or equipment and should not be used to pull tools across the shop floor.
  - f. Air hoses should be kept free of grease and oil and neatly coiled for storage at the end of the workday.
- B. The tire machine uses great force to manipulate tires.

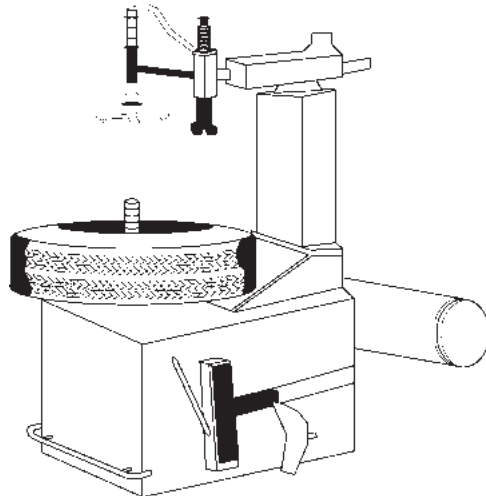

1. Its uses include removing and reinstalling the tire onto the wheel and inflating the tire to the proper pressure.

## 2. Safety

- a. The tire machine is one of the most dangerous pieces of shop equipment. Do not use the tire machine without proper training.
- b. Truck tires that use the split rim type of mounting are very dangerous. These must be inflated in a special cage. Consult the instructor before attempting to mount a truck tire or any type of tire.
- c. Wear protective eyewear when working with a tire machine.

## C. A pneumatic jack can raise a vehicle by the bumper or axle.

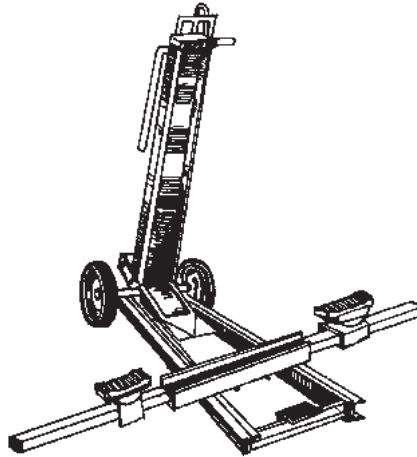

1. Special instruction is required to use a pneumatic jack.
2. The vehicle must be lowered onto safety stands before a technician can work under a vehicle supported by a jack.
3. Safety
  - a. Never work under a vehicle supported only by a jack.
  - b. Consult the instructor and repair manual when placing safety stands for the proper locations of the stands.
  - c. Be sure that the load-capacity rating for the safety stands is sufficient to safely support the vehicle.
  - d. Do not lift vehicles with passengers inside or with the doors, hood, or luggage lid open.

# INTRODUCTION TO AUTOMOTIVE TECHNOLOGY

---

- D. General maintenance guidelines for pneumatic equipment
  - 1. Consult the maintenance instructions provided by the equipment manufacturer.
  - 2. Keep the piece of equipment free of dirt and grease and store it in an area that is dry and free of dust.
  - 3. Care should be taken that no foreign matter enters the nipple opening of the couplings on pneumatic equipment.

III. Hydraulic equipment develops pressure as a result of the closing of a valve and the pumping of a handle or as a result of a combination of air pressure over hydraulic fluid.

- A. The hydraulic floor jack has a cylinder that raises the front, rear, or side of a vehicle by pumping a handle.
  - 1. A floor jack is mounted on four wheels for portability.
  - 2. It should only be used after thorough instruction. The vehicle must also be supported by safety stands.

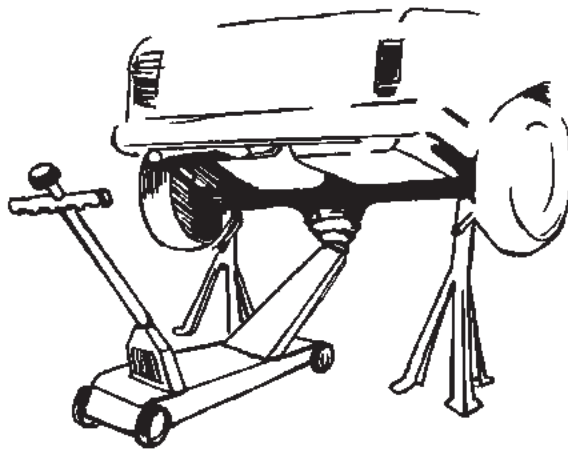

- 3. Refer to Unit II, Lesson 3 for safety guidelines.

- B. A lift raises the entire vehicle off the ground.

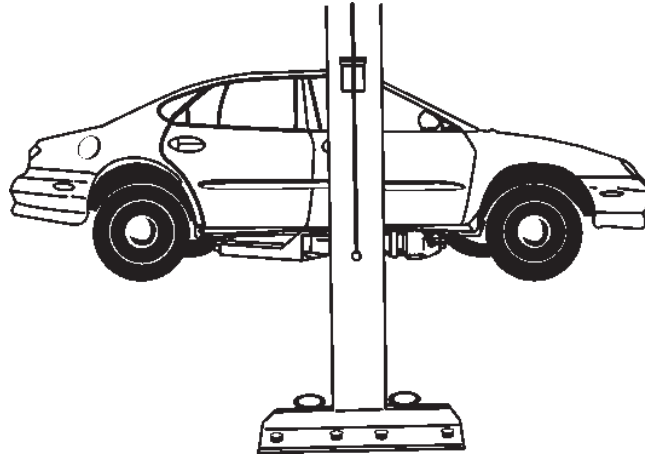

1. Most lifts use air pressure to pressurize hydraulic fluid, which is then pumped into one or more large cylinders.
  2. Refer to Unit II, Lesson 3 for safety guidelines.
- C. A hydraulic press is found in most shops. It uses a powerful pushing force to press bearings and gears onto and off of shafts.

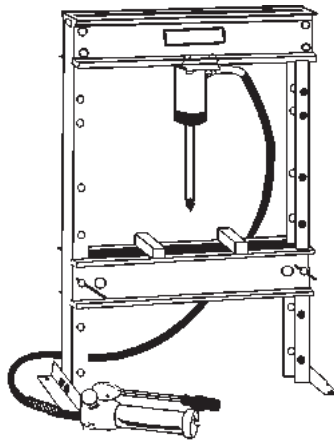

1. Pulling a handle on the press raises or lowers a ram. The ram presses the part against a table.
2. Safety
  - a. Consult the instructor for the procedure for properly setting up and using the hydraulic press.
  - b. Wear personal protective equipment (PPE) while using a hydraulic press.

# INTRODUCTION TO AUTOMOTIVE TECHNOLOGY

---

- D. The engine hoist, or portable engine crane, is used to raise heavy engines and transmissions. After turning a valve, a handle is pumped to raise the hoist.

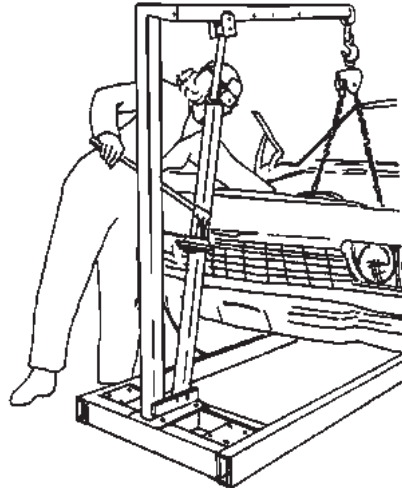

1. A hoist is simply a hydraulic jack that is designed for attaching onto the top of an object and pulling it upward, instead of getting underneath of an object and pushing it upward.
2. The engine hoist is not intended to support an engine while it is being serviced. The engine should be mounted on an engine stand during service.

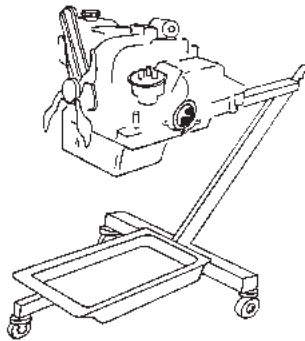

3. Safety
  - a. Consult the instructor before using the engine hoist.
  - b. Stand clear of any object being raised in case the hoist fails or topples, or the object being lifted comes loose.
  - c. When moving an object that is suspended from the crane, move the crane very slowly.

- d. Do not work on any object while it is suspended from the crane. Lower it to a workbench or the floor (or into an engine stand for a motor).
- E. General maintenance guidelines for hydraulic equipment
  - 1. Consult the maintenance instructions provided by the equipment manufacturer.
  - 2. Inspect equipment components and report any damage, leaks, or deterioration to the instructor.



# INTRODUCTION To AUTOMOTIVE TECHNOLOGY

---

## UNIT VII: VEHICLE INFORMATION

### CONTENTS OF THIS UNIT

- I. Unit objective
- II. Lesson plan
  - A. Lesson 1: Service Information and Vehicle Identification
    - 1. Information outline
    - 2. Assignment sheet
      - a. AS1-L1-UVII: Vehicle Information and Identification
- III. Unit VII Test



# INTRODUCTION TO AUTOMOTIVE TECHNOLOGY

---

## UNIT VII: VEHICLE INFORMATION

### UNIT OBJECTIVE

After completing this unit, students should be able to identify the different types of service information and vehicle identification. Students will demonstrate mastery of the material by completing the assignment sheet and achieving a score of \_\_\_\_\_ on the Unit VII Test.

### SPECIFIC OBJECTIVES

After completing the lesson in this unit, students should be able to:

#### Lesson 1

- I. Identify the different sources and formats of vehicle service information.
- II. Identify guidelines for using a manufacturer's service information.
- III. Identify the common locations of vehicle codes and how to read the codes.
- IV. Complete the assignment sheet on vehicle information and identification (AS1-L1-UVII).



# INTRODUCTION TO AUTOMOTIVE TECHNOLOGY

---

## UNIT VII: VEHICLE INFORMATION

### LESSON 1: SERVICE INFORMATION AND VEHICLE IDENTIFICATION

#### I. Vehicle service information

##### A. Sources

**NOTE:** Vehicles have become so technologically advanced that service information is used on every job. This information contains diagnosis procedures, specifications, and service procedures. Technicians must know how to locate and use the information that is available.



1. Vehicle manufacturers publish service information for each model year of the vehicles they manufacture.
  - a. This service information is the most comprehensive and the best source of information for a specific vehicle.
  - b. It includes vehicle specifications, diagnostic and repair procedures, parts diagrams, and special tools required.
  - c. Because many technical changes occur after the service information is published, manufacturers provide technical service bulletins (TSBs) to update the information. The information in the TSBs also appears in the next edition of the service information.
2. Professional general service manuals are used by independent repair shops because one manual can contain information for many domestic or foreign cars produced over several years. These books summarize the most important information and do not include all the specifics.
3. Aftermarket specialty manuals are often sold at bookstores and may cover one model of vehicle produced over several years. These manuals are written for individuals with and without experience in the automotive repair profession and are popular with the "do-it-yourself" individual.
4. An owner's manual, prepared by the vehicle manufacturer, is provided to the purchaser of the vehicle and is usually stored in the glove compartment. It includes basic information about the location and function of vehicle accessories, starting the vehicle, and maintaining the vehicle.

5. Sites on the Internet are available to find information that a shop may not have in its library, such as more up-to-date information, recall information, or information about a hard-to-diagnose repair issue.

## B. Formats

1. Besides printed manuals, service information is available for use on computer hard drives, networks, and CD-ROMs.

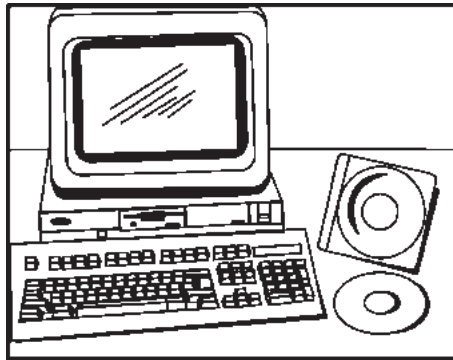

2. Using computerized information rather than printed materials saves space. In addition, accessing the information on a computer is easier and saves time.

## II. Using the manufacturer's service information

- ### A. Get familiar with the components of the service information and how they are organized. Doing so will help in finding information quickly.

1. The general information section includes vehicle information such as identification (e.g., reading the vehicle identification number (VIN) to get data about the vehicle), basic maintenance, and lubrication.
2. The repair sections, which cover each system of the vehicle, have detailed procedures for diagnosing, inspecting, testing, and repairing the systems. These sections also include the following features:
  - a. Illustrations of exploded views of parts or steps in the procedure
  - b. Diagrams showing the layout of hoses or circuits
  - c. Diagnostic or troubleshooting charts for systematically finding the source of a problem

# INTRODUCTION TO AUTOMOTIVE TECHNOLOGY

---

- B. Before performing a procedure, read it through once to get an understanding and overview of what is required.
- C. Be careful to do all steps in a procedure and perform them in the correct order. Missing steps or performing them out of order may cause unsuccessful results.

## III. Locating and reading the vehicle codes

- A. In the early 1980s, the National Highway Traffic Safety Administration began requiring vehicle manufacturers to identify each vehicle made for highway use with a VIN.
  - 1. A vehicle's VIN is a code with 17 characters (letters and numbers) that is permanently affixed to the vehicle.
  - 2. The VIN is typically found in several locations on a vehicle. Some of the more common locations are listed below.
    - a. Dashboard near the lower part of the windshield on the driver's side
    - b. Certification label on the driver's door frame
    - c. Engine compartment
  - 3. The VIN uniquely identifies a vehicle and provides a great deal of information about the vehicle's origin and features. See the sample VIN below for a breakdown of the code.

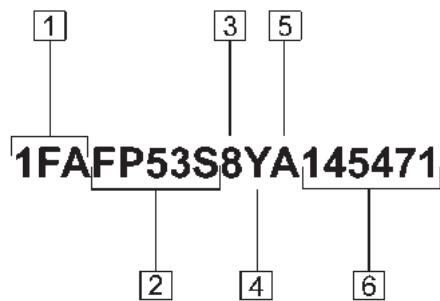

- 1 — Country and Manufacturer Identifier
- 2 — Line, Series, Body Type, Engine Type, Restraint System Type
- 3 — Check Digit
- 4 — Model Year
- 5 — Plant of Manufacture
- 6 — Production Sequence Number

4. For help in reading the VIN for a specific vehicle, check the general service information section of the service information for that vehicle.
- B. An engine serial number and identification number or code is generally stamped on the engine block.
1. The exact location of these numbers depends on the manufacturer.
  2. Engine codes provide technicians with specifications for the vehicle's engine, such as the horsepower rating and whether the engine was designed for a manual or automatic transmission.



# INTRODUCTION TO AUTOMOTIVE TECHNOLOGY

---

## UNIT VIII: CUSTOMER SERVICE

### CONTENTS OF THIS UNIT

- I. Unit objective
- II. Lesson plan
  - A. Lesson 1: Customer Service, Work Orders, and Vehicle Preparation
    - 1. Information outline
    - 2. Assignment sheet
      - a. AS1-L1-UVIII: Customer Service, Work Orders, and Vehicle Preparation
    - 3. Job sheets
      - a. JS1-L1-UVIII: Complete a Work Order With Concern, Cause, and Correction
      - b. JS2-L1-UVIII: Perform a General Diagnosis
- III. Unit VIII Test



# INTRODUCTION TO AUTOMOTIVE TECHNOLOGY

---

## UNIT VIII: CUSTOMER SERVICE

### UNIT OBJECTIVE

After completing this unit, students should be able to identify principles of good customer service, components and functions of work orders, and how to prepare a vehicle before and after service. Students will demonstrate mastery of the material by completing the assignment sheets, successfully performing specific tasks in the job sheet, and achieving a score of \_\_\_\_\_ on the Unit VIII Test.

### SPECIFIC OBJECTIVES

After completing the lesson in this unit, students should be able to:

#### Lesson 1

- I. Identify proper customer relation procedures.
- II. Identify the procedures for preparing a vehicle before and after service.
- III. Identify the functions and components of a work order.
- IV. Identify the three C's and how to use them to diagnose a vehicle problem.
- V. Complete the assignment sheet on customer service, work orders, and vehicle preparation (AS1-L1-UVIII).
- VI. Demonstrate the ability to:
  - A. Complete a work order with concern, cause, and correction (JS1-L1-UVIII).
  - B. Perform a general diagnosis (JS2-L1-UVIII).



# INTRODUCTION TO AUTOMOTIVE TECHNOLOGY

---

## UNIT VIII: CUSTOMER SERVICE

### LESSON 1: CUSTOMER SERVICE, WORK ORDERS, AND VEHICLE PREPARATION

#### I. Proper customer relation procedures

**NOTE:** Studies have shown that more people are fired for their inability to get along with others than for a lack of technical expertise. The behavior of the technician and other workers can jeopardize the financial stability of the shop.

**NOTE:** The amount and degree of customer contact required in an automotive technician position will vary depending on shop organization and policy.

- A. All employees in the shop should greet the customer when appropriate and act in a friendly, courteous manner. Refer to the customer by using "Mr." or "Ms." and the person's surname.
- B. Listen carefully and patiently. After the customer has explained the problem, ask questions that may help in the diagnosis. People communicate at different paces and in different styles.

**NOTE:** The customer is likely to be upset that the vehicle he or she depends on is unavailable and that the repair may be expensive.

- C. It is important to verify the complaint. Some customers unknowingly give a false diagnosis.
- D. Give the customer an estimate. A customer will likely be very upset if presented with a large repair that was not expected. Obtain the customer's phone number and call the customer before beginning the repairs.
- E. Look for potential problems other than those described by the customer. Explain any new problems to the customer in a professional manner.

**NOTE:** In most shops, the service manager/writer usually has the responsibility of calling the customer.

- F. Perform the repair in a professional manner. Remember that the customer is paying for a repair. The outcome of the job performed makes a statement to the customer and employer about the technician's skills and professionalism.



G. Verify the repair. One of the most common complaints of vehicle owners is that they paid to have a repair performed only to experience the same problem after the repair was to have been made.

### II. Preparing a vehicle before and after service

A. Another important part of customer service is making sure each customer's vehicle stays clean and free of damage during its time in the shop.

1. Place fender covers on the fenders, front grille, and other areas as needed to protect the vehicle from grease, scratches, and dents.
2. Use floor protectors to ensure dirt and grease from technicians' shoes do not soil the carpet.
3. Use seat covers to ensure that dirty or greasy hands and clothing do not soil the seats.
4. Cover the steering wheel with a steering wheel cover to protect it from greasy hands and fingerprints.

B. After service, follow the shop's policy on preparing the vehicle to return it to the customer.

1. Some shops may require that all protective covers are removed, whereas others may want covers such as the floor protectors left in.
2. Ensure that the customer's vehicle is as clean as when he or she dropped it off. Clean off any dirt or grease that may have gotten on the vehicle's exterior or interior.

III. The automotive technician should be familiar with the functions and components of a work order.

**NOTE:** A sample work order appears in this section.

A. The work order serves several functions.

1. Itemizes the repairs by listing the cost of parts and labor
2. Can be used to authorize the repair
3. Has the necessary information on how to contact the owner and serves as documentation for future reference



# INTRODUCTION TO AUTOMOTIVE TECHNOLOGY

---

4. May also specify limited warranties and liabilities of the shop
  5. May serve as a reference for recent service history for warranty or legal purposes
- B. A work order typically has the following components.
1. Customer name, address, and phone number (home or work with extension number)
  2. Date
  3. Invoice number
  4. Year, make, model, vehicle identification number (VIN), and mileage of the vehicle
  5. Name/initials of the service writer and technician
  6. Customer authorization signature to allow repairs
  7. Description of customer concern
  8. Vehicle service history information
  9. Related technical service bulletins (TSB)
  10. Technician's notes that includes diagnostic procedures performed, the results of diagnosis, and any important observations or remarks
  11. Component or system defect responsible for the concern
  12. Service performed to successfully correct the concern
  13. Labor procedures and costs based on the parts and labor estimation guides
  14. Outside labor procedures and costs that include if a shop sent a particular part out to another shop for repairs
  15. Listing of each part that includes name, description, and cost
  16. Sales tax, which is usually calculated on parts only
  17. Total that represents the final price that the customer will pay for all charges related to the repair

# AUTOMOTIVE TECHNOLOGY

## Smith's Automotive Repair

Customer's Name: Tom Steffensmeier Date: 3/24/2006 Invoice #: 5463874093  
 Address: 601 N. Ann St., Macon, MO 63552 Phone: (660) 442-1577  
 Year/Make: 2000 Ford Model: Taurus VIN: 1FAFP538BYA145471 Mileage: 67, 349  
 Service Writer: J. Smith Technician: J. Smith

Customer Authorization Signature: Tom Steffensmeier  
 Customer Concern: Front brakes are making grinding noise

Vehicle Service History Information: Routine maintenance performed 12/14/05

Related Technical Service Bulletins: \_\_\_\_\_

Diagnostic Procedures Performed: Inspected front brakes and rotors and rear drums

Cause: Worn brake pads

Correction: Replaced front brake pads, machined front rotors, and adjusted rear drums

Labor Procedures and Costs			Estimated	Actual
Brake Repair			85.00	70.00
Drum Repair			10.00	10.00
<i>Outside Labor Procedures and Costs</i>				
<b>Total Labor Costs</b>			<b>95.00</b>	<b>80.00</b>
<i>Parts Costs</i>				
Quantity	Part #	Description		
1	1U2-5680	Kit - Brk Friction	49.95	49.95
Total Parts Costs			49.95	49.95
Labor Total			95.00	80.00
Parts Total			49.95	49.95
Sales Tax			11.16	10.01
<b>GRAND TOTAL</b>			<b>\$156.11</b>	<b>\$139.96</b>



# INTRODUCTION TO AUTOMOTIVE TECHNOLOGY

---

- C. Work orders may be handwritten or prepared by entering codes in a computer terminal and then printed.
  - D. Depending on the part, the following information may be required for ordering repair parts.
    - 1. Make, model, and model year (found on the driver's side door jamb) of the vehicle
    - 2. VIN
    - 3. Engine information that includes engine size, in cubic inches or liters, the number of cylinders, and the type of fuel system
    - 4. Wheelbase
    - 5. Number of doors
- IV. Use the three Cs (concern, cause, and correction) to diagnose the vehicle problem.
- A. Identify the concern. If possible, ask the owner/driver the following questions.
    - 1. Under what conditions does the problem occur?
    - 2. Are there unusual sounds?
    - 3. How long has the problem existed? Is it getting worse?
  - B. Test drive the vehicle under the conditions that the problem has been observed.

**CAUTION: Always obtain instructor's approval before conducting a road test. Conduct the road test in an area with little or no traffic. Never exceed the legal speed limit during the road test. Always wear safety belts. An assistant should record all observations made during the road test. Do not attempt to drive and record results at the same time.**
  - C. Isolate the cause of the problem.
    - 1. Locate and interpret vehicle and major component identification numbers.
      - a. VIN



- b. Vehicle certification labels
    - c. Calibration decals
  - 2. Research applicable vehicle and service information.
    - a. Applicable components and their operation
    - b. Vehicle service history
    - c. Service precautions
    - d. Technical service bulletins
  - 3. Perform a visual inspection of the applicable system.
    - a. Look for damaged or broken components.
    - b. Look for worn or misaligned components.
    - c. Check fluid levels.
    - d. Inspect related electrical sensors, corrector, controls, and wiring.
  - 4. Test the systems and components that could cause the problem. Eliminate good components until the cause is found.
- D. Determine the necessary action and correct the problem.