

BASICS OF MECHANICAL ENGINEERING:

**INTEGRATING SCIENCE, TECHNOLOGY
AND COMMON SENSE**

**Paul D. Ronney
Department of Aerospace and Mechanical Engineering
University of Southern California**

Available on-line at <http://ronney.usc.edu/ame101/>

Copyright © 2005 - 2021 by Paul D. Ronney. All rights reserved.

Table of contents

TABLE OF CONTENTS	II
FOREWORD	IV
NOMENCLATURE	VII
UNITS CONVERSIONS	IX
CHAPTER 1. WHAT IS MECHANICAL ENGINEERING?	1
CHAPTER 2. UNITS	4
Base units	4
Derived units	6
Special consideration 1: pounds force vs. pounds mass	6
Special consideration 2: temperature	7
Examples of the use (and power) of units	8
CHAPTER 3. “ENGINEERING SCRUTINY”	11
Scrutinizing analytical formulas and results	11
Scrutinizing computer solutions	13
Examples of the use of units and scrutiny	14
CHAPTER 4. FORCES IN STRUCTURES	20
Forces	20
Degrees of freedom	20
Moments of forces	22
Types of forces and moments of force	24
Analysis of statics problems	27
CHAPTER 5. STRESSES, STRAINS AND MATERIAL PROPERTIES	36
Stresses and strains	36
Principal stresses and maximum shear stress	42
Pressure vessels	47
Bending of beams	49
Buckling of columns	56
CHAPTER 6. FLUID MECHANICS	58
Fluid statics	58
Equations of fluid motion	61
Bernoulli’s equation	61
Conservation of mass	63
Viscous effects	64
Definition of viscosity	64
No-slip boundary condition	65

Reynolds number	65
Navier-Stokes equations	67
Laminar and turbulent flow	68
Lift, drag and fluid resistance	69
Lift and drag coefficients	69
Flow around spheres and cylinders	69
Flow through pipes	73
Compressible flow	76
CHAPTER 7. THERMAL AND ENERGY SYSTEMS	81
Conservation of energy – First Law of Thermodynamics	81
Describing a thermodynamic system	81
Statement of the First Law	81
Equations for conservation of energy for a control mass	81
Equations for conservation of energy for a control volume	84
Processes	86
Examples of energy analysis using the 1 st Law	87
Second Law of thermodynamics	90
Engines cycles and efficiency	91
Heat transfer	97
Conduction	97
Convection	98
Radiation	99
CHAPTER 8. WRITTEN AND ORAL COMMUNICATION	101
APPENDIX A. DESIGN PROJECTS	107
Generic information about the design projects	107
How to run a meeting (PDR's philosophy...)	107
Suggestions for the written report	107
King of the Hill	110
Arduino Cars	116
3D-Printed Bridge	119
APPENDIX B. PROBLEM-SOLVING METHODOLOGY	124
APPENDIX C. EXCEL TUTORIAL	125
APPENDIX D. STATISTICS	128
Mean and standard deviation	128
Stability of statistics	129
Least-squares fit to a set of data	130

Foreword

If you're reading this book, you're probably already enrolled in an introductory university course in Mechanical Engineering. The primary goals of this textbook are, to provide you, the student, with:

1. An understanding of what Mechanical Engineering is and to a lesser extent what it is not
2. Some useful tools that will stay with you throughout your engineering education and career
3. A brief but significant introduction to some of the major topics of Mechanical Engineering and enough understanding of these topics so that you can relate them to each other
4. A sense of common sense

The challenge is to accomplish these objectives without overwhelming you so much that you won't be able to retain the most important concepts.

In regards to item 2 above, I remember nothing about some of my university courses, even in cases where I still use the information I learned therein. In others I remember "factoids" that I still use. One goal of this textbook is to provide you with a set of useful factoids so that even if you don't remember any specific words or figures from this text, and don't even remember where you learned these factoids, you still retain them and apply them when appropriate.

In regards to item 3 above, in particular the relationships between topics, this is one area where I feel engineering faculty (myself included) do not do a very good job. Time and again, I find that students learn something in class A, and this information is used with different terminology or in a different context in class B, but the students don't realize they already know the material and can exploit that knowledge. As the old saying goes, "We get too soon old and too late smart..." Everyone says to themselves several times during their education, "oh... that's so easy... why didn't the book [or instructor] just say it that way..." I hope this text will help you to get smarter sooner and older later.

A final and less tangible purpose of this text (item 4 above) is to try to instill you with a sense of common sense. Over my 33 years of teaching at the university level, I have found that students have become more technically skilled and well-rounded but have less ability to think and figure out things for themselves. I attribute this in large part to the fact that when I was a teenager, cars were relatively simple and my friends and I spent hours working on them. When our cars weren't broken, we would sabotage (nowadays "hack" might be a more descriptive term) each other's cars. The best hacks were those that were difficult to diagnose, but trivial to fix once you figured out what was wrong. We learned a lot of common sense working on cars. Today, with electronic controls, cars are very difficult to work on or hack. Even with regards to electronics, today the usual solution to a broken device is to throw it away and buy a newer device, since the old one is probably nearly obsolete by the time it breaks. Of course, common sense *per se* is probably not teachable, but *a sense of common sense*, that is, to know when it is needed and how to apply it, might be teachable. If I may be allowed an immodest moment in this textbook, I would like to give an anecdote about my son Peter. When he was not quite 3 years old, like most kids his age had a pair of shoes with lights (actually light-emitting diodes or LEDs) that flash as you walk. These shoes work for a few months until the heel switch fails (usually in the closed position) so that the LEDs stay on continuously for a day or two until the battery goes dead. One morning he noticed that the LEDs in one of his shoes were on continuously. He had a puzzled look on his face but said nothing. Instead, he went to look for his other shoe, and after rooting around a bit, found it. He then picked it up, hit it against

something and the LEDs flashed as they were supposed to. He then said, holding up the good shoe, “this shoe - fixed... [then pointing at the other shoe] that shoe - broken!” I immediately thought, “I wish all my students had that much common sense...” In my personal experience, about half of engineering is common sense as opposed to specific, technical knowledge that needs to be learned from coursework. Thus, to the extent that common sense can be taught, a final goal of this text is to try to instill this sense of when common sense is needed and even more importantly how to integrate it with technical knowledge. The most employable and promotable engineering graduates are the most flexible ones, i.e. those that take the attitude, “I think I can handle that” rather than “I can’t handle that since no one taught me that specific knowledge.” Students will find at some point in their career, and probably in their very first job, that *plans and needs change rapidly* due to testing failures, new demands from the customer, other engineers leaving the company, etc.

In most engineering programs, *retention* of incoming first-year students is an important issue; at many universities, less than half of first-year engineering students finish an engineering degree. Of course, not every incoming student who chooses engineering as his/her major should stay in engineering, nor should every student who lacks confidence in the subject drop out, but in all cases it is important that incoming students receive a good enough introduction to the subject that they make an informed, intelligent choice about whether he/she should continue in engineering.

Along the lines of retaining first-year students in engineering, I would like to give an anecdote. At Princeton University, in one of my first years of teaching, a student in my thermodynamics class came to my office, almost in tears, after the first midterm. She did fairly poorly on the exam, and she asked me if I thought she belonged in Engineering. (At Princeton thermodynamics was one of the first engineering courses that students took). What was particularly distressing to her was that her fellow students had a much easier time learning the material than she did. She came from a family of artists, musicians and dancers and got little support or encouragement from home for her engineering studies. While she had some of the artistic side in her blood, she said that her real love was engineering, but she wondered was it a lost cause for her? I told her that I didn’t really know whether she should be an engineer, but I would do my best to make sure that she had a good enough experience in engineering that she could make an informed choice from a comfortable position, rather than a decision made under the cloud of fear of failure. With only a little encouragement from me, she did better and better on each subsequent exam and wound up receiving a very respectable grade in the class. She went on to graduate from Princeton with honors and earn a Ph.D. in engineering from a major Midwestern university. I still consider her one of my most important successes in teaching. Thus, a goal of this text is (along with the instructor, teaching assistants, fellow students, and infrastructure) is to provide a positive first experience in engineering.

There are also many topics that should be (and in some instructors’ views, *must* be) covered in an introductory engineering textbook but are not covered here because the overriding desire to keep the book’s material manageable within the limits of a one-semester course:

1. History of engineering
2. Philosophy of engineering
3. Engineering ethics

Finally, I offer a few suggestions for faculty using this book:

1. *Projects.* I assign small, hands-on design projects for the students, examples of which are given in Appendix A.
2. *Demonstrations.* Include simple demonstrations of engineering systems – thermoelectrics, piston-type internal combustion engines, gas turbine engines, transmissions, ...

3. *Computer graphics.* At USC, the introductory Mechanical Engineering course is taught in conjunction with a computer graphics laboratory where an industry-standard software package is used.

Nomenclature

Symbol	Meaning	SI units and/or value
A	Area	m ²
BTU	British Thermal Unit	1 BTU = 1055 J
C _D	Drag coefficient	---
C _L	Lift coefficient	---
C _P	Specific heat at constant pressure	J/kgK
C _V	Specific heat at constant volume	J/kgK
c	Sound speed	m/s
COP	Coefficient Of Performance	---
d	Diameter	m (meters)
E	Energy	J (Joules)
E	Elastic modulus	N/m ²
e	Internal energy per unit mass	J/kg
F	Force	N (Newtons)
f	Friction factor (for pipe flow)	---
g	Acceleration of gravity	m/s ² (earth gravity = 9.81)
g _c	USCS units conversion factor	32.174 lbf ft/ lbf sec ² = 1
h	Convective heat transfer coefficient	W/m ² K
I	Area moment of inertia	m ⁴
I	Electric current	amps
k	Boltzmann's constant	1.380622 x 10 ⁻²³ J/K
k	Thermal conductivity	W/mK
L	Length	m
\mathcal{M}	Molecular Mass	kg/mole
M	Moment of force	N m (Newtons x meters)
M	Mach number	---
m	Mass	kg
\dot{m}	Mass flow rate	kg/s
n	Number of moles	---
N _A	Avogadro's number (6.0221415 x 10 ²³)	---
P	Pressure	N/m ²
P	Point-load force	N
Q	Heat transfer	J
q	Heat transfer rate	W (Watts)
\mathfrak{R}	Universal gas constant	8.314 J/mole K
R	Mass-based gas constant = \mathfrak{R}/M	J/kg K
R	Electrical resistance	ohms
Re	Reynolds number	---
r	Radius	m
S	Entropy	J/K
T	Temperature	K
T	Tension (in a rope or cable)	N

t	Time	s (seconds)
U	Internal energy	J
u	Internal energy per unit mass	J/kg
V	Volume	m ³
V	Voltage	Volts
V	Shear force	N
v	Velocity	m/s
W	Weight	N (Newtons)
W	Work	J
w	Loading (e.g. on a beam)	N/m
Z	Thermoelectric figure of merit	1/K
z	elevation	m
α	Thermal diffusivity	m ² /s
γ	Gas specific heat ratio	---
η	Efficiency	---
ε	Strain	---
ε	Roughness factor (for pipe flow)	---
μ	Coefficient of friction	---
μ	Dynamic viscosity	kg/m s
θ	Angle	---
ν	Kinematic viscosity = μ/ρ	m ² /s
ν	Poisson's ratio	---
ρ	Density	kg/m ³
ρ	Electrical resistivity	ohm m
σ	Normal stress	N/m ²
σ	Stefan-Boltzmann constant	$5.67 \times 10^{-8} \text{ W/m}^2\text{K}^4$
σ	Standard deviation	[Same units as sample set]
τ	Shear stress	N/m ²
τ	Thickness (e.g. of a pipe wall)	m

Units conversions

Base units			
Type	SI unit	USCS unit	Other conversions
Length	meter (m)	3.281 foot (ft) = 1 m	1 m = 100 centimeters (cm) = 1000 millimeters (mm) = 39.37 inches (in) 1 kilometer (km) = 1000 m 1 mile (mi) = 5280 ft
Mass	kilogram (kg)	2.205 pounds mass (lbm) = 1 kg	1000 grams (g) = 1 kg 1 slug = 32.174 lbm
Time	second (s)	s	1 minute (min) = 60 s 1 hour (hr) = 60 min
Charge	coulomb (coul)	coul	1 coul = charge on 6.241506×10^{18} electrons
Derived units			
Type	SI unit	USCS unit	Other conversions
Area (length ²)	m ²	10.76 ft ² = 1 m ²	1 acre = 43,560 ft ² 640 acres = 1 mi ² 1 hectare = 10,000 m ² = 2.471 acre
Volume (length ³)	m ³	35.32 ft ³ = 1 m ³	1 ft ³ = 7.48 gallons (gal) = 28,317 cm ³ (ml, cc) 1 m ³ = 264.2 gal 1 liter = 0.001 m ³ = 1000 cm ³ = 61.02 in ³
Velocity (length/time)	m/s	3.281 ft/s = 1 m/s	60 mi/hr = 88 ft/s
Acceleration (length/time ²)	m/s ²	3.281 ft/s ² = 1 m/s ²	1 g (standard earth gravity) = 9.806 m/s ² = 32.174 ft/s ²
Force = $\frac{\text{mass} \times \text{length}}{\text{time}^2}$	1 Newton (N) = 1 kg m/s ²	1 pound force (lbf) = 4.448 N	1 dyne = 1 g cm/s ² = 10 ⁻⁵ N
Energy = $\frac{\text{mass} \times \text{length}^2}{\text{time}^2}$	1 Joule (J) = 1 kg m ² /s ² = 1 N m	1 J = 0.7376 (ft lbf) (foot-pound)	1 British Thermal Unit (BTU) = 1055 J = 778 ft lbf 1 calorie (cal) = 4.184 J 1 diet calorie = 1000 cal 1 erg = 1 g cm ² /s ² = 10 ⁻⁷ J
Power = $\frac{\text{mass} \times \text{length}^2}{\text{time}^3}$	1 Watt (W) = 1 kg m ² /s ³ = 1 N m/s	1 horsepower (hp) = 746 W	1 hp = 550 ft lbf/s
Pressure = force/length ²	1 Pascal (Pa) = 1 N/m ² = 1 kg/m s ²	1 lbf/in ² = 6899 Pa	1 standard atmosphere (atm) = 101325 Pa = 14.696 lbf/in ² 1 bar = 10 ⁵ Pa

Type	SI unit	USCS unit	Other conversions
Temperature	Kelvin (K)	1.8 Rankine (R) = 1 K	See notes below
Heat capacity = Energy mass × temperature	1 J /kg K = 1 J/kg°C	1 BTU/lbm°F = 1 BTU/lbmR = 1 cal/g°C	(Note: that's not a misprint, the conversion factor between BTU/lbm°F and cal/g°C is exactly 1)
Current = charge/time	1 Ampere (A or amp) = 1 coul/s	n/a	1 milliamp (mA) = 0.001 A
Voltage = energy/charge	1 Volt (V) = 1 J/coul	n/a	n/a
Capacitance = coul/Volt	1 Farad (f) = 1 coul/Volt = 1 coul ² /J	n/a	1 microfarad (μf) = 10 ⁻⁶ f 1 picofarad (pf) = 10 ⁻¹² f
Inductance = Volt / (amp/s)	1 Henry (H) = 1 J s ² /coul ²	n/a	1 millihenry (mH) = 0.001 H
Resistance = Volt/amp	1 Ohm (Ω) = 1 Volt/amp = 1 J s/coul ²	n/a	n/a

Temperature conversion formulae:

Kelvins (K, not °K) is the absolute temperature scale in SI units.

Rankines (R, not °R) is the absolute temperature scale in USCS units.

$$T \text{ (in units of } ^\circ\text{F)} = T \text{ (in units of R)} - 459.67$$

$$T \text{ (in units of } ^\circ\text{C)} = T \text{ (in units of K)} - 273.15$$

$$T \text{ (in units of } ^\circ\text{C)} = [T \text{ (in units of } ^\circ\text{F)} - 32]/1.8$$

$$T \text{ (in units of } ^\circ\text{F)} = 1.8[T \text{ (in units of } ^\circ\text{C)}] + 32$$

$$1 \text{ K of temperature change} = 1^\circ\text{C of temperature change}$$

$$= 1.8^\circ\text{F of temperature change} = 1.8 \text{ R of temperature change}$$

Revolution conversion formulae:

$$1 \text{ revolution} = 2\pi \text{ radians} = 360 \text{ degrees}$$

Ideal gas law - note that there are many “flavors” of the ideal gas law:

$$PV = n\mathfrak{R}T$$

$$PV = mRT$$

$$Pv = \mathfrak{R}T$$

P = ρRT – most useful form for engineering purposes; more useful to work with mass than moles, because moles are not conserved in chemical reactions!

P = pressure (N/m²); V = volume (m³); n = number of moles of gas

℞ = universal gas constant (8.314 J/moleK); T = temperature (K)

m = mass of gas (kg); R = mass-specific gas constant = ℞/M

M = gas molecular mass (kg/mole); v = V/m = specific volume (m³/kg)

ρ = 1/v = density (kg/m³)

Chapter 1. What is Mechanical Engineering?

“The journey of a thousand miles begins with a single step.”

- Lao Tzu

Definition of Mechanical Engineering

My personal definition of Mechanical Engineering is

If it needs engineering but it doesn't involve electrons, chemical reactions, arrangement of molecules, life forms, isn't a structure (building/ bridge/ dam) and doesn't fly, a mechanical engineer will take care of it... but

if it does involve electrons, chemical reactions, arrangement of molecules, life forms, is a structure or does fly, mechanical engineers may handle it anyway

Although every engineering faculty member in every engineering department will claim that his/her field is the broadest engineering discipline, in the case of Mechanical Engineering that's actually true (I claim) because the core material permeates all engineering systems (fluid mechanics, solid mechanics, heat transfer, control systems, etc.)

Mechanical engineering is one of the oldest engineering fields (though perhaps Civil Engineering is even older) but in the past 20 years has undergone a rather remarkable transformation as a result of a number of new technological developments including

- **Computer Aided Design (CAD).** The average non-technical person probably thinks that mechanical engineers sit in front of a drafting table drawing blueprints for devices having nuts, bolts, shafts, gears, bearings, levers, etc. While that image was somewhat true 100 years ago, today the drafting board has long since been replaced by CAD software, which enables a part to be constructed and tested virtually before any physical object is manufactured.
- **Simulation.** CAD allows not only sizing and checking for fit and interferences, but the resulting virtual parts are tested structurally, thermally, electrically, aerodynamically, etc. and modified as necessary before committing to manufacturing.
- **Sensor and actuators.** Nowadays even common consumer products such as automobiles have dozens of sensors to measure temperatures, pressures, flow rates, linear and rotational speeds, etc. These sensors are used not only to monitor the health and performance of the device, but also as inputs to a microcontroller. The microcontroller in turn commands actuators that adjust flow rates (*e.g.* of fuel into an engine), timings (*e.g.* of spark ignition), positions (*e.g.* of valves), etc.
- **3D printing.** Traditional “subtractive manufacturing” consisted of starting with a block or casting of material and removing material by drilling, milling, grinding, etc. The shapes that can be created in this way are limited compared to modern “additive manufacturing” or “3D printing” in which a structure is built in layers. Just as CAD + simulation has led to a new way of designing systems, 3D printing has led to a new way of creating prototypes and in limited cases, full-scale production.
- **Collaboration with other fields.** Historically, a nuts-and-bolts device such as an automobile was designed almost exclusively by mechanical engineers. Modern vehicles have vast electrical and electronic systems, safety systems (*e.g.* air bags, seat restraints), specialized batteries (in the case of hybrids or electric vehicles), etc., which require design contributions from electrical,

biomechanical and chemical engineers, respectively. It is essential that a modern mechanical engineer be able to understand and accommodate the requirements imposed on the system by non-mechanical considerations.

These radical changes in what mechanical engineers do compared to a relatively short time ago makes the field both challenging and exciting.

Mechanical Engineering curriculum

In almost any accredited Mechanical Engineering program, the following courses are required:

- Basic sciences - math, chemistry, physics
- Breadth or distribution (called “General Education” at USC)
- Computer graphics and computer aided design (CAD)
- Experimental engineering & instrumentation
- Mechanical design - nuts, bolts, gears, welds
- Computational methods - converting continuous mathematical equations into discrete equations solved by a computer
- Core “engineering science”
 - Dynamics – essentially $F = ma$ applied to many types of systems
 - Strength and properties of materials
 - Fluid mechanics
 - Thermodynamics
 - Heat transfer
 - Control systems
- Senior “capstone” design project

Additionally you may participate in non-credit “enrichment” activities such as undergraduate research, undergraduate student paper competitions in ASME (American Society of Mechanical Engineers, the primary professional society for mechanical engineers), the Formula SAE racecar project, etc.



Figure 1. SAE Formula racecar project at USC (photo: <http://www.uscformulasae.com>)

Examples of industries employing MEs

Many industries employ mechanical engineers; a few industries and the type of systems MEs design are listed below.

- Automotive
 - Combustion
 - Engines, transmissions
 - Suspensions
- Aerospace (w/ aerospace engineers)
 - Control systems
 - Heat transfer in turbines
 - Fluid mechanics (internal & external)
- Biomedical (w/ physicians)
 - Biomechanics – prosthesis
 - Flow and transport in vivo
- Computers (w/ computer engineers)
 - Heat transfer
 - Packaging of components & systems
- Construction (w/ civil engineers)
 - Heating, ventilation, air conditioning (HVAC)
 - Stress analysis
- Electrical power generation (w/ electrical engineers)
 - Steam power cycles - heat and work
 - Mechanical design of turbines, generators, ...
- Petrochemicals (w/ chemical, petroleum engineers)
 - Oil drilling - stress, fluid flow, structures
 - Design of refineries - piping, pressure vessels
- Robotics (w/ electrical engineers)
 - Mechanical design of actuators, sensors
 - Stress analysis

Chapter 2. Units

I often say that when you can measure what you are speaking about, and express it in numbers, you know something about it; but when you cannot measure it, when you cannot express it in numbers, your knowledge is of a meagre and unsatisfactory kind; it may be the beginning of knowledge, but you have scarcely, in your thoughts, advanced to the stage of science, whatever the matter may be

– William Thomson (Lord Kelvin)

All engineered systems require measurements for specifying the size, weight, speed, etc. of objects as well as characterizing their performance. Understanding the application of these units is the single most important objective of this textbook because it applies to all forms of engineering and everything that one does as an engineer. Understanding units is **far** more than simply being able to convert from feet to meters or vice versa; combining and converting units from different sources is a challenging topic. For example, if building insulation is specified in units of BTU inches per hour per square foot per degree Fahrenheit, how can that be converted to thermal conductivity in units of Watts per meter per degree C? Or can it be converted? Are the two units measuring the same thing or not? (For example, in a new engine laboratory facility that was being built for me, the natural gas flow was insufficient... so I told the contractor I needed a system capable of supplying a minimum of 50 cubic feet per minute (cfm) of natural gas at 5 pounds per square inch (psi). His response was “what’s the conversion between cfm and psi?” Of course, the answer is that there is no conversion; cfm is a measure of flow rate and psi a measure of pressure. One might as well be asking what’s the conversion between kilograms and miles.) Engineers must struggle with these misconceptions every day.

Base units

Engineers in the United States are burdened with two systems of units and measurements: (1) the *English* or *USCS* (US Customary System) ☹ and (2) the *metric* or *SI* (Système International d’Unités) ☺. Either system has a set of *base units*, that is, units which are defined based on a standard measure such as a certain number of wavelengths of a particular light source. These base units include:

- Length (meters (m), centimeters (cm), millimeters (mm); feet (ft), inches (in), kilometers (km), miles (mi))
 - $1 \text{ m} = 100 \text{ cm} = 1000 \text{ mm} = 3.281 \text{ ft} = 39.37 \text{ in}$
 - $1 \text{ km} = 1000 \text{ m}$
 - $1 \text{ mi} = 5280 \text{ ft}$
- Mass (lbm, slugs, kilograms); ($1 \text{ kg} = 2.205 \text{ lbm} = 0.06853 \text{ slug}$) (lbm = “pounds mass”)
- Time (seconds; the standard abbreviation is “s” not “sec”) (same units in USCS and SI)
- Electric current (really electric charge in units of coulombs [abbreviation: ‘coul’] is the base unit and the derived unit is current = charge/time) ($1 \text{ coulomb} = \text{charge on } 6.241506 \times 10^{18} \text{ electrons}$) ($1 \text{ ampere [abbreviation: amp]} = 1 \text{ coul/s}$)

Moles are often reported as a fundamental unit, but it is not; it is just a bookkeeping convenience to avoid carrying around factors of 10^{23} everywhere. The choice of the number of

particles in a mole of particles is completely arbitrary; by convention Avogadro's number is defined by $N_A = 6.0221415 \times 10^{23}$, the units being particles/mole (or one could say individuals of any kind, not limited just to particles, e.g. atoms, molecules, electrons or students).

Temperature is frequently interpreted as a base unit but again it is not, it is a *derived unit*, that is, one created from combinations of base units. Temperature is essentially a unit of energy divided by Boltzmann's constant. Specifically, the average kinetic energy of an ideal gas particle in a 3-dimensional box is $1.5kT$, where k is Boltzmann's constant $= 1.380622 \times 10^{-23} \text{ J/K}$ (really (Joules/particle)/K; every textbook will state the units as just J/K but you'll see below how useful it is to include the "per particle" part as well). Thus, 1 Kelvin is the temperature at which the kinetic energy of an ideal gas (and **only** an ideal gas, not any other material) molecule is $1.5kT = 2.0709 \times 10^{-23} \text{ J}$.

The ideal gas constant (\mathfrak{R}) with which you are very familiar is simply Boltzmann's constant multiplied by Avogadro's number, *i.e.*

$$\mathfrak{R} = kN_A = \left(1.38 \times 10^{-23} \frac{\text{J}}{\text{particle K}} \right) \left(6.02 \times 10^{23} \frac{\text{particle}}{\text{mole}} \right) = 8.314 \frac{\text{J}}{\text{mole K}} \frac{\text{cal}}{4.184 \text{J}} = 1.987 \frac{\text{cal}}{\text{mole K}}$$

(Equation 1)

In the above equation, note that we have multiplied and divided units such as Joules as if they were numbers; this is valid because we can think of 8.314 Joules as $8.314 \times (1 \text{ Joule})$ and additionally we can write $(1 \text{ Joule}) / (1 \text{ Joule}) = 1$. Extending that further, we can think of $(1 \text{ Joule}) / (1 \text{ kg m}^2/\text{s}^2) = 1$, which will be the basis of our approach to units conversion – multiplying and dividing by 1 written in different (and sometimes odd-looking) forms. Note also the value of the "hidden unit" 'particle' in the above equation. I find it extremely useful to include such units because the real units aren't J/K; if you have 2 particles you'll have twice as much energy (J) at the same value of K (temperature), so the real units ARE in fact J/(particle K).

Why does this discussion apply only for an ideal gas? By definition, ideal gas particles have only kinetic energy and negligible potential energy due to inter-molecular attraction; if there is potential energy, then we need to consider the total internal energy of the material (E , units of Joules) which is the sum of the microscopic kinetic and potential energies, in which case the temperature for any material (ideal gas or not) is defined as

$$T = \left(\frac{\partial U}{\partial S} \right)_{V=const.}$$

(Equation 2)

where U is the internal energy of the material (units J), S is the entropy of the material (units J/K) and V is the volume. This intimidating-looking definition of temperature, while critical to understanding thermodynamics, will not be needed in this course. (Until you read this you thought you understood temperature because of its common usage and a handy device called a thermometer; in fact, temperature is quite difficult to understand. The one thing you should understand is that it's the driving force for heat transfer, that is, heat must always flow from a higher to a lower temperature and never the reverse.)

Derived units

Derived units are units created from combinations of base units; there are an infinite number of possible derived units. Some of the more important/common/useful ones are:

- Area = length²; 640 acres = 1 mile², or 1 acre = 43,560 ft²
- Volume = length³; 1 ft³ = 7.481 gallons = 28,317 cm³; also 1 liter = 1000 cm³ = 61.02 in³
- Velocity = length/time
- Acceleration = velocity/time = length/time² (standard gravitational acceleration on earth = $g = 32.174 \text{ ft/s}^2 = 9.806 \text{ m/s}^2$)
- Force = mass * acceleration = mass*length/time²
 - 1 kg m/s² = 1 Newton = 0.2248 pounds force (pounds force is usually abbreviated lbf and Newton N) (equivalently 1 lbf = 4.448 N)
- Energy = force x length = mass x length²/time²
 - 1 kg m²/s² = 1 Joule (J)
 - 778 ft lbf = 1 British thermal unit (BTU)
 - 1055 J = 1 BTU
 - 1 J = 0.7376 ft lbf
 - 1 calorie = 4.184 J
 - 1 dietary calorie = 1000 calories
- Power (energy/time = mass x length²/time³)
 - 1 J/s = 1 kg m²/s³ = 1 Watt
 - 746 W = 550 ft lbf/sec = 1 horsepower
- Heat capacity = J/moleK or J/kgK or J/mole°C or J/kg°C (see note below)
- Pressure = force/area
 - 1 N/m² = 1 Pascal
 - 101325 Pascal = 101325 N/m² = 14.696 lbf/in² = 1 standard atmosphere
- Current = charge/time (1 amp = 1 coul/s)
- Voltage = energy/charge (1 Volt = 1 J/coul)
- Capacitance = amps / (volts/s) (1 farad = 1 coul²/J)
- Inductance = volts / (amps/s) (1 Henry = 1 J s² / coul²)
- Resistance = volts/amps (1 ohm = 1 volt/amp = 1 Joule s / coul²)
- Torque = force x lever arm length = mass x length²/time² – same as energy but one would usually report torque in Nm (Newton meters), not Joules, to avoid confusion.
- Radians, degrees, revolutions – these are all dimensionless quantities, but must be converted between each other, i.e. 1 revolution = 2π radians = 360 degrees.

Special consideration 1: pounds force vs. pounds mass

By far the biggest problem with USCS units is with mass and force. The problem is that pounds is both a unit of mass AND force. These are distinguished by lbm for pounds (mass) and lbf for pounds (force). We all know that $W = mg$ where W = weight, m = mass, g = acceleration of gravity. So

$$1 \text{ lbf} = 1 \text{ lbm} \times g = 32.174 \text{ lbm ft/s}^2 \quad (\text{Equation 3})$$

Sounds ok, huh? But wait, now we have an extra factor of 32.174 floating around. Is it also true that

$$1 \text{ lbf} = 1 \text{ lbm ft/s}^2$$

which is analogous to the SI unit statement that

$$1 \text{ Newton} = 1 \text{ kg m/s}^2 \quad (\text{Equation 4})$$

No, 1 lbf cannot equal 1 lbm ft/s² because 1 lbf equals 32.174 lbm ft/sec². So what unit of mass satisfies the relation

$$1 \text{ lbf} = 1 \text{ (mass unit) ft/s}^2?$$

This mass unit is called a “slug” believe it or not. With use of equation (2) it is apparent that

$$1 \text{ slug} = 32.174 \text{ lbm} = 14.59 \text{ kg} \quad (\text{Equation 5})$$

Often when doing USCS conversions, it is convenient to introduce a conversion factor called g_c ; by rearranging Equation 3 we can write

$$g_c = \frac{32.174 \text{ lbm ft}}{\text{lbf s}^2} = 1 \quad (\text{Equation 6}).$$

Since Equation 2 shows that $g_c = 1$, one can multiply and divide any equation by g_c as many times as necessary to get the units into a more compact form (*an example of “why didn’t somebody just say that?”*). Keep in mind that **any** units conversion is simply a matter of multiplying or dividing by 1, e.g.

$$\frac{5280 \text{ ft}}{\text{mile}} = 1; \frac{1 \text{ kg m}}{\text{N s}^2} = 1; \frac{778 \text{ ft lbf}}{\text{BTU}} = 1; \text{ etc.}$$

For some reason 32.174 lbm ft/ lbf s² has been assigned a special symbol called g_c even though there are many other ways of writing 1 (e.g. 5280 ft / mile, 1 kg m / N s², 778 ft lbf / BTU) all of which are also equal to 1 but none of which are assigned special symbols.

If this seems confusing, I don’t blame you. That’s why I recommend that even for problems in which the givens are in USCS units and where the answer is needed in USCS units, first convert everything to SI units, do the problem, then convert back to USCS units. I disagree with some authors who say an engineer should have “native fluency” in both systems; it is somewhat useful but not necessary. The second example in the next sub-section below uses the approach of converting to SI, do the problem, and convert back to USCS. The third example shows the use of USCS units employing g_c .

Special consideration 2: temperature

Many difficulties also arise with units of temperature. There are four temperature scales in “common” use: Fahrenheit, Rankine, Celsius (or Centigrade) and Kelvin. Note that one speaks of

“degrees Fahrenheit” and “degrees Celsius” but just “Rankines” or “Kelvins” (without the “degrees”).

$$\begin{aligned}
 T \text{ (in units of } ^\circ\text{F)} &= T \text{ (in units of R)} - 459.67 \\
 T \text{ (in units of } ^\circ\text{C)} &= T \text{ (in units of K)} - 273.15 \\
 1 \text{ K} &= 1.8 \text{ R} \\
 T \text{ (in units of } ^\circ\text{C)} &= [T \text{ (in units of } ^\circ\text{F)} - 32]/1.8, \\
 T \text{ (in units of } ^\circ\text{F)} &= 1.8[T \text{ (in units of } ^\circ\text{C)}] + 32 \\
 \text{Water freezes at } &32^\circ\text{F} / 0^\circ\text{C, boils at } 212^\circ\text{F} / 100^\circ\text{C}
 \end{aligned}$$

Special note (*another example of “that’s so easy, why didn’t somebody just say that?”*): when using units involving temperature (such as heat capacity, units J/kg°C, or thermal conductivity, units Watts/m°C), one can convert the temperature in these quantities these to/from USCS units (e.g. heat capacity in BTU/lbm°F or thermal conductivity in BTU/hr ft °F) simply by multiplying or dividing by 1.8. You don’t need to add or subtract 32. Why? Because these quantities are really derivatives with respect to temperature (heat capacity is the derivative of internal energy with respect to temperature) or refer to a temperature gradient (thermal conductivity is the rate of heat transfer per unit area by conduction divided by the temperature gradient, dT/dx). When one takes the derivative of the constant 32, you get zero. For example, if the temperature changes from 84°C to 17°C over a distance of 0.5 meter, the temperature gradient is (84-17)/0.5 = 134°C/m. In Fahrenheit, the gradient is [(1.8*84 + 32) - (1.8*17 + 32)]/0.5 = 241.2°F/m or 241.2/3.281 = 73.5°F/ft. The important point is that the 32 cancels out when taking the difference. So *for the purpose of converting between °F and °C in units like heat capacity and thermal conductivity*, one can use 1°C = 1.8°F. That **doesn’t** mean that one can just skip the + or – 32 whenever one is lazy.

Also, one often sees thermal conductivity in units of W/m°C or W/mK. How does one convert between the two? Do you have to add or subtract 273? And how do you add or subtract 273 when the units of thermal conductivity are not degrees? Again, thermal conductivity is heat transfer per unit area **per unit temperature gradient**. This gradient could be expressed in the above example as (84°C-17°C)/0.5 m = 134°C/m, or in Kelvin units, [(84 + 273)K - (17 + 273)K]/0.5 m = 134K/m and thus the 273 cancels out. So one can say that 1 W/m°C = 1 W/mK, or 1 J/kg°C = 1 J/kgK. And again, that **doesn’t** mean that one can just skip the + or – 273 (or 460, in USCS units) whenever one is lazy.

Examples of the use (and power) of units

Example 1

An object has a weight of 300 lbf at earth gravity. What is its mass in units of lbm?

$$F = ma \Rightarrow m = \frac{F}{a} = \frac{F}{a}(1) = \frac{F}{a}(g_c) = \frac{300 \text{ lbf}}{32.174 \frac{\text{ft}}{\text{s}^2}} \left(\frac{32.174 \text{ lbm ft}}{\text{lbf s}^2} \right) = 300 \text{ lbm}$$

This shows that an object that weighs 300 lbf at earth gravity has a mass of 300 lbm. At any other gravity level, its mass would still be 300 lbm but its weight would be different, but in all cases this weight would still be calculated according to $F = ma$ (force = mass x acceleration) or, specifically for weights, we can use $W = mg$ (weight = mass x acceleration of gravity).

Example 2

What is the weight (in lbf) of one gallon of air at 1 atm and 25°C? The molecular mass of air is 28.97 g/mole = 0.02897 kg/mole.

Ideal gas law: $PV = n\mathfrak{R}T$

(P = pressure, V = volume, n = number of moles, \mathfrak{R} = universal gas constant, T = temperature)

Mass of gas (m) = moles x mass/mole = $n\mathcal{M}$ (\mathcal{M} = molecular mass)

Weight of gas (W) = mg, where g = acceleration of gravity = 9.81 m/s²

Combining these 3 relations: $W = PVMg/\mathfrak{R}T$

$$W = \frac{PVMg}{\mathfrak{R}T} = \frac{\left(1 \text{ atm} \frac{101325 \text{ N/m}^2}{\text{atm}}\right) \left(1 \text{ gal} \frac{\text{ft}^3}{7.481 \text{ gal}} \left(\frac{\text{m}}{3.281 \text{ ft}}\right)^3\right) \left(\frac{0.02897 \text{ kg}}{\text{mole}}\right) \left(\frac{9.81 \text{ m}}{\text{s}^2}\right)}{\left(\frac{8.314 \text{ J}}{\text{mole K}}\right) (25 + 273) \text{ K}}$$

$$W = 0.0440 \frac{\left(\frac{\text{N}}{\text{m}^2}\right) (\text{m}^3) \left(\frac{\text{kg}}{\text{mole}}\right) \left(\frac{\text{m}}{\text{s}^2}\right)}{\left(\frac{\text{J}}{\text{mole K}}\right) \text{K}} = 0.0440 \frac{(\text{N})(\text{m})(\text{kg}) \left(\frac{\text{m}}{\text{s}^2}\right)}{\text{J}} = 0.0440 \frac{(\text{N}) \left(\frac{\text{kg m}^2}{\text{s}^2}\right)}{\text{J}}$$

$$W = 0.0440 \text{ N} \left(\frac{1 \text{ lbf}}{4.448 \text{ N}}\right) = 0.00989 \text{ lbf} \approx 0.01 \text{ lbf}$$

Note that it's easy to write down all the formulas and conversions. The tricky part is to check to see if you've actually gotten all the units right. In this case I converted everything to the SI system first, then converted back to USCS units at the very end – which is a pretty good strategy for most problems. The tricky parts are realizing (1) the temperature must be an absolute temperature, i.e. Kelvin not °C, and (2) that moles are not the same as mass, so you have to convert using \mathcal{M} . If in doubt, how do you know whether to multiply or divide by \mathcal{M} ? Check the units!

Example 3

A car with a mass of 3000 lbm is moving at a velocity of 88 ft/s. What is its kinetic energy (KE) in units of ft lbf? What is its kinetic energy in Joules?

$$KE = \frac{1}{2}(\text{mass})(\text{velocity})^2 = \frac{1}{2}(3000 \text{ lbm})\left(88 \frac{\text{ft}}{\text{s}}\right)^2 = 1.16 \times 10^7 \frac{\text{lbm ft}^2}{\text{s}^2}$$

Now what can we do with $\text{lbm ft}^2/\text{s}^2$? The units are $(\text{mass})(\text{length})^2/(\text{time})^2$, so it is a unit of energy, so at least that part is correct. Dividing by g_c , we obtain

$$KE = \left(1.16 \times 10^7 \frac{\text{lbm ft}^2}{\text{s}^2}\right)\left(\frac{1}{g_c}\right) = \left(1.16 \times 10^7 \frac{\text{lbm ft}^2}{\text{s}^2}\right)\left(\frac{\text{lbf s}^2}{32.174 \text{ lbm ft}}\right) = 3.61 \times 10^5 \text{ ft lbf}$$

$$KE = (3.61 \times 10^5 \text{ ft lbf})\left(\frac{1 \text{ J}}{0.7376 \text{ ft lbf}}\right) = 4.89 \times 10^5 \text{ J}$$

Note that if you used 3000 lbf rather than 3000 lbm in the expression for KE, you'd have the wrong units – $\text{ft lbf}^2/\text{lbm}$, which is NOT a unit of energy (or anything else that I know of...) Also note that since $g_c = 1$, we COULD multiply by g_c rather than divide by g_c ; the resulting units ($\text{lbm}^2 \text{ ft}^3/\text{lbf s}^4$) is still a unit of energy, but not a very useful one!

Example 4

The thermal conductivity of a particular brand of ceramic insulating material is $0.5 \frac{\text{BTU in}}{\text{ft}^2 \text{ hr } ^\circ\text{F}}$ (I'm not kidding, these are the units commonly reported in commercial products!) where the standard abbreviations in = inch and hr = hour are used. What is the thermal conductivity in units of $\frac{\text{W}}{\text{m } ^\circ\text{C}}$? (Here "W" = Watt, not weight.)

$$\left(0.5 \frac{\text{BTU in}}{\text{ft}^2 \text{ hr } ^\circ\text{F}}\right)\left(\frac{1055 \text{ J}}{\text{BTU}}\right)\left(\frac{\text{ft}}{12 \text{ in}}\right)\left(\frac{3.281 \text{ ft}}{\text{m}}\right)\left(\frac{\text{hr}}{3600 \text{ s}}\right)\left(\frac{1 \text{ W}}{1 \text{ J/s}}\right)\left(\frac{1.8 ^\circ\text{F}}{^\circ\text{C}}\right) = 0.0721 \frac{\text{W}}{\text{m } ^\circ\text{C}}$$

Note that the thermal conductivity of air at room temperature is $0.026 \text{ Watt/m } ^\circ\text{C}$, *i.e.*, about 3 times lower than the insulation. So why don't we use air as an insulator? We'll discuss that in Chapter 7.

Chapter 3. “Engineering scrutiny”

“Be your own worst critic, unless you prefer that someone else be your worst critic.”

- I dunno, I just made it up. But, it doesn't sound very original.

Scrutinizing analytical formulas and results

I often see analyses that I can tell within 5 seconds must be wrong. I have three tests, which should be done in the order listed, for checking and verifying results. These tests will weed out 95% of all mistakes. I call these the “smoke test,” “function test,” and “performance test,” by analogy with building electronic devices.

1. *Smoke test.* In electronics, this corresponds to turning the power switch on and seeing if the device smokes or not. If it smokes, you know the device can't possibly be working right (unless you intended for it to smoke.) In analytical engineering terms, this corresponds to **checking the units**. You have no idea how many results people report that can't be correct because the units are wrong (i.e. the result was 6 kilograms, but they were trying to calculate the speed of something.) **You will catch 90% of your mistakes if you just check the units.** For example, if I just derived the ideal gas law for the first time and predicted $PV = n\mathcal{R}/T$ you can quickly see that the units on the right-hand side of the equation are different from those on the left-hand side. There are several additional rules that must be followed:

- Anything inside a square root, cube root, etc. must have units that are a perfect square (e.g. m^2/sec^2), cube, etc.) This does **not** mean that every term inside the square root must be a perfect square, only that the **combination** of all terms must be a perfect square. For example, the speed (v) of a frictionless freely falling object in a gravitational field is $v = \sqrt{2gh}$, where g = acceleration of gravity (units $\text{length}/\text{time}^2$) and h is the height from which the object was dropped (units length). Neither g nor h have units that are a perfect square, but when multiplied together the units are $(\text{length}/\text{time}^2)(\text{length}) = \text{length}^2/\text{time}^2$, which is a perfect square, and when you take the square root, the units are $v = \sqrt{\text{length}^2/\text{time}^2} = \text{length}/\text{time}$ as required.
- Anything inside a log, exponent, trigonometric function, etc., must be dimensionless (I can take the log of 6 but I don't know how to take the log of 6 kilograms). Again, the individual terms inside the function need not all be dimensionless, but the combination must be dimensionless.
- Any two quantities that are added together must have the same units (I can't add 6 kilograms and 19 meters/second. Also, I can add 6 miles per hour and 19 meters per second, but I have to convert 6 miles per hour into meters per second, or convert 19 meters per second into miles per hour, before adding the terms together.)

2. *Function test.* In electronics, this corresponds to checking to see if the device does what I designed it to do, e.g. that the red light blinks when I flip switch on, the meter reading increases when I turn the knob to the right, the bell rings when I push the button, etc. – assuming that was what I intended that it do. In analytical terms this corresponds to determining if the result gives sensible predictions. Again, there are several rules that must be followed:

- Determine if the sign (+ or -) of the result is reasonable. For example, if your prediction of the absolute temperature of something is -72 Kelvin, you should check your analysis again.
- For terms in an equation with property values in the denominator, can that value be zero? (In which case the term would go to infinity). Even if the property can't go to zero, does it make sense that as the value decreases, the term would increase?
- Determine whether what happens to y as x goes up or down is reasonable or not. For example, in the ideal gas law, $PV = nRT$:
 - At fixed volume (V) and number of moles of gas (n), as T increases then P increases – reasonable
 - At fixed temperature (T) and n , as V increases then P decreases – reasonable
 - Etc.
- Determine what happens in the limit where x goes to special values, e.g. zero, one or infinity as appropriate. For example, consider the equation for the temperature as a function of time $T(t)$ of an object starting at temperature T_i at time $t = 0$ having surface area A (units m^2), volume V (units m^3), density ρ (units kg/m^3) and heat capacity C_p (units $J/kg^\circ C$) that is suddenly dunked into a fluid at temperature T_∞ with heat transfer coefficient h (units $Watts/m^2^\circ C$). It can be shown that in this case $T(t)$ is given by

$$T(t) = T_\infty + (T_i - T_\infty) \exp\left(-\frac{hA}{\rho VC_p} t\right) \quad \text{(Equation 7)}$$

$hA/\rho VC_p$ has units of $(Watts/m^2^\circ C)(m^2)/(kg/m^3)(m^3)(J/kg^\circ C) = 1/s$, so $(hA/\rho VC_p)t$ is dimensionless, thus the formula easily passes the smoke test. But does it make sense? At $t = 0$, $T_i = 0$ as expected. What happens if you wait for a long time? The temperature can reach T_∞ but cannot overshoot it (a consequence of the Second Law of Thermodynamics, discussed in Chapter 7). In the limit $t \rightarrow \infty$, the term $\exp(-(hA/\rho VC_p)t)$ goes to zero, thus $T \rightarrow T_\infty$ as expected. Other scrutiny checks: if h or A increases, heat can be transferred to the object more quickly, thus the time to approach T_∞ decreases. Also, if ρ , V or C_p increases, the “thermal inertia” (resistance to change in temperature) increases, so the time required to approach T_∞ increases. So, the formula makes sense.

- If your formula contains a difference of terms, determine what happens if those 2 terms are equal. For example, in the above formula, if $T_i = T_\infty$, then the formula becomes simply $T(t) = T_\infty$ for all time. This makes sense because if the bar temperature and fluid temperature are the same, then there is no heat transfer to or from the bar and thus its temperature never changes (again, a consequence of the Second Law of Thermodynamics ... two objects at the same temperature cannot exchange energy via heat transfer.)
3. *Performance test.* In electronics, this corresponds to determining how fast, how accurate, etc. the device is. In analytical terms this corresponds to determining how accurate the result is. This means of course you have to compare it to something else **that you trust**, i.e. an experiment, a more sophisticated analysis, someone else's published result (of course there is no guarantee that their result is correct just because it got published, but you need to check it anyway.) For example, if I derived the ideal gas law and predicted $PV = 7nRT$, it passes the smoke and function tests with no problem, but it fails the performance test miserably (by a factor of 7). But

of course the problem is deciding which result to trust as being at least as accurate as your own result; this of course is something that cannot be determined in a rigorous way, it requires a judgment call based on your experience.

Scrutinizing computer solutions

(This part is beyond what I expect you to know for AME 101 but I include it for completeness).

Similar to analyses, I often see computational results that I can tell within 5 seconds must be wrong. **It is notoriously easy to be lulled into a sense of confidence in computed results, because the computer always gives you some result, and that result always looks good when plotted in a 3D shaded color orthographic projection.** The corresponding “smoke test,” “function test,” and “performance test,” are as follows:

1. *Smoke test.* Start the computer program running, and see if it crashes or not. If it doesn’t crash, you’ve passed the smoke test, part (a). Part (b) of the smoke test is to determine if the computed result passes the *global conservation test*. The goal of any program is to satisfy mass, momentum, energy and atom conservation *at every point in the computational domain* subject to certain constitutive relations (*e.g.*, Newton’s law of viscosity $\tau_x = \mu \partial u_x / \partial y$), Hooke’s Law $\sigma = E \epsilon$) and equations of state (*e.g.*, the ideal gas law.) This is a hard problem, and it is even hard to verify that the solution is correct once it is obtained. But it is easy to determine whether or not *global conservation* is satisfied, that is,

- Is mass conserved, that is, does the sum of all the mass fluxes at the inlets, minus the mass fluxes at the outlets, equal to the rate of change of mass of the system (=0 for steady problems)?
- Is momentum conserved in each coordinate direction?
- Is energy conserved?
- Is each type of atom conserved?

If not, you are 100% certain that your calculation is wrong. You would be amazed at how many results are never “sanity checked” in this way, and in fact fail the sanity check when, after months or years of effort and somehow the results never look right, someone finally gets around to checking these things, the calculations fail the test and you realize all that time and effort was wasted.

2. *Performance test.* Comes before the function test in this case. For computational studies, a critical performance test is to *compare your result to a known analytical result under simplified conditions*. For example, if you’re computing flow in a pipe at high Reynolds numbers (where the flow is turbulent), with chemical reaction, temperature-dependent transport properties, variable density, etc., first **check your result against the textbook solution** that assumes constant density, constant transport properties, etc., by making all of the simplifying assumptions (in your model) that the analytical solution employs. **If you don’t do this, you really have no way of knowing if your model is valid or not.** You can also use previous computations by yourself or others for testing, but of course there is no absolute guarantee that those computations were correct.

3. *Function test.* Similar to function test for analyses.

By the way, even if you're just doing a quick calculation, I recommend **not** using a calculator. Enter the data into an Excel spreadsheet so that you can add/change/scrutinize/save calculations as needed. Sometimes I see an obviously invalid result and when I ask, "How did you get that result? What numbers did you use?" the answer is "I put the numbers into the calculator and this was the result I got." But how do you know you entered the numbers and formulas correctly? What if you need to re-do the calculation for a slightly different set of numbers?

Examples of the use of units and scrutiny

These examples, particularly the first one, also introduce the concept of "back of the envelope" (that is, simple, approximate but instructive) estimates, a powerful engineering tool.

Example 1. Drag force and power requirements for an automobile

A car with good aerodynamics has a drag coefficient (C_D) of 0.3. The drag coefficient is defined as the ratio of the drag force (F_D) to the *dynamic pressure* of the flow = $\frac{1}{2}\rho v^2$ (where ρ is the fluid density and v the fluid velocity far from the object) multiplied by the cross-section area (A) of the object, *i.e.*

$$F_D = \frac{1}{2} C_D \rho v^2 A \quad (\text{Equation 8})$$

The density of air at standard conditions is 1.18 kg/m^3 .

- (a) Estimate the power (in units of horsepower) required to overcome the aerodynamic drag of such a car at 60 miles per hour.

$$P = Fv \quad (P = \text{power}, F = \text{force}, v = \text{velocity}); \quad v = \frac{60 \text{ mi}}{\text{hr}} \frac{5280 \text{ ft}}{\text{mi}} \frac{\text{m}}{3.281 \text{ ft}} \frac{\text{hr}}{60 \text{ min}} \frac{\text{min}}{60 \text{ s}} = 26.8 \frac{\text{m}}{\text{s}}$$

Estimate the cross-section area of the car as $2 \text{ m} \times 1.5 \text{ m} = 3 \text{ m}^2$

$$F_D = \frac{1}{2} C_D \rho v^2 A = \frac{1}{2} (0.3) \left(\frac{1.18 \text{ kg}}{\text{m}^3} \right) \left(26.8 \frac{\text{m}}{\text{s}} \right)^2 (3 \text{ m}^2) = 381.4 \frac{\text{kg m}}{\text{s}^2} = 381.4 \text{ N}$$

$$P = Fv = (381.4 \text{ N}) \left(\frac{26.8 \text{ m}}{\text{s}} \right) = 1.022 \times 10^4 \frac{\text{Nm}}{\text{s}} = 1.022 \times 10^4 \frac{\text{J}}{\text{s}} = (1.022 \times 10^4 \text{ W}) \left(\frac{1 \text{ hp}}{746 \text{ W}} \right) = 13.7 \text{ hp}$$

which is reasonable.

- (b) Estimate the gas mileage of such a car. The heating value of gasoline is $4.3 \times 10^7 \text{ J/kg}$ and its density is 750 kg/m^3 .

$$\frac{\text{mi}}{\text{gal}} = \frac{\text{mi}}{\text{hr}} \frac{\text{hr}}{\text{gal}} = \frac{\text{mi}}{\text{hr}} \frac{\text{hr}}{\text{J}} \frac{\text{J}}{\text{gal}} = \frac{\text{mi}}{\text{hr}} \left(\frac{\text{s}}{\text{J}} \frac{\text{hr}}{\text{s}} \right) \left(\frac{\text{J}}{\text{kg}} \frac{\text{kg}}{\text{gal}} \right) = \frac{\text{mi}}{\text{hr}} \frac{\text{s}}{\text{J}} \frac{\text{hr}}{\text{s}} \frac{\text{J}}{\text{kg}} \left(\frac{\text{kg}}{\text{m}^3} \frac{\text{m}^3}{\text{ft}^3} \frac{\text{ft}^3}{\text{gal}} \right)$$

$$\frac{mi}{gal} = \left(\frac{60 mi}{hr}\right) \left(\frac{s}{1.022 \times 10^4 J}\right) \left(\frac{hr}{3600 s}\right) \left(\frac{4.3 \times 10^7 J}{kg}\right) \left(\frac{750 kg}{m^3}\right) \left(\frac{m}{3.218 ft}\right)^3 \left(\frac{ft^3}{7.481 gal}\right)$$

$$= 199.0706726 \frac{mi}{gal}$$

Why is this value of miles/gallon so high?

- The main problem is that conversion of fuel energy to engine output shaft work is about 20% efficient at highway cruise conditions, thus the gas mileage would be $199.0706726 \times 0.2 = 39.81413452$ mpg
- Also, besides air drag, there are other losses in the transmission, driveline, tires – at best the drivetrain is 80% efficient – so now we’re down to 31.85130761 mpg
- Also – other loads on engine – air conditioning, generator, ...

What else is wrong? There are too many significant figures; at most 2 or 3 are acceptable. When we state 31.85130761 mpg, that means we think that the miles per gallon is closer to 31.85130761 mpg than 31.85130760 mpg or 31.85130762 mpg. Of course we can’t measure the miles per gallon to anywhere near this level of accuracy. 31 is probably ok, 31.9 is questionable and 31.85 is ridiculous. You will want to carry a few extra digits of precision through the calculations to avoid round-off errors, but then at the end, round off your calculation to a reasonable number of significant figures *based on the uncertainty of the most uncertain parameter*. That is, if I know the drag coefficient only to the first digit, i.e. I know that it’s closer to 0.3 than 0.2 or 0.4, but not more precisely than that, there is no point in reporting the result to 3 significant figures.

Example 2. Scrutiny of a new formula

I calculated for the first time ever the rate of heat transfer (q) (in Watts) as a function of time t from an aluminum bar of radius r , length L , thermal conductivity k (units Watts/m°C), thermal diffusivity α (units m²/s), heat transfer coefficient h (units Watts/m²°C) and initial temperature T_{bar} conducting and radiating to surroundings at temperature T_{∞} as

$$q = k(T_{bar} - T_{\infty})e^{\alpha t/r^2} - hr^2(T_{bar} - T_{\infty} - 1) \quad \text{(Equation 9)}$$

Using “engineering scrutiny,” what “obvious” mistakes can you find with this formula? What is the likely “correct” formula?

1. The units are wrong in the first term (Watts/m, not Watts)
2. The units are wrong in the second term inside the parenthesis (can’t add 1 and something with units of temperature)
3. The first term on the right side of the equation goes to infinity as the time (t) goes to infinity – probably there should be a negative sign in the exponent so that the whole term goes to zero as time goes to infinity.
4. The length of the bar (L) doesn’t appear anywhere

5. The signs on $(T_{bar} - T_{\infty})$ are different in the two terms – but heat must ALWAYS be transferred from hot to cold, never the reverse, so the two terms cannot have different signs. One can, with equal validity, define heat transfer as being positive either to or from the bar, but with either definition, you can't have heat transfer being positive in one term and negative in the other term.

6. Only the first term on the right side of the equation is multiplied by the $e^{(-\alpha t/r^2)}$ factor, and thus will go to zero as $t \rightarrow \infty$. So the other term would still be non-zero even when $t \rightarrow \infty$, which doesn't make sense since the amount of heat transfer (q) has to go to zero as $t \rightarrow \infty$. So probably both terms should be multiplied by the $e^{(-\alpha t/r^2)}$ factor.

Based on these considerations, a possibly correct formula, which would pass all of the smoke and function tests is

$$q = \left[kL(T_{bar} - T_{\infty}) + hr^2(T_{bar} - T_{\infty}) \right] e^{-\alpha t/r^2}$$

Actually even this is a bit odd since the first term (conduction heat transfer) is proportional to the length L but the second term (convection heat transfer) is independent of L ... a still more likely formula would have both terms proportional to L, e.g.

$$q = \left[kL(T_{bar} - T_{\infty}) + hrL(T_{bar} - T_{\infty}) \right] e^{-\alpha t/r^2}$$

Example 3. Thermoelectric generator

The thermal efficiency (η) = (electrical power out) / (thermal power in) of a thermoelectric power generation device (used in outer planetary spacecraft (Figure 2), powered by heat generated from radioisotope decay, typically plutonium-238) is given by

$$\eta = \left(1 - \frac{T_L}{T_H} \right) \frac{\sqrt{1 + ZT_a} - 1}{\sqrt{1 + ZT_a} + T_L/T_H}; T_a \equiv \frac{T_H + T_L}{2} \quad \text{(Equation 10)}$$

where T is the temperature, the subscripts L, H and a refer to cold-side (low temperature), hot-side (high temperature) and average respectively, and Z is the “thermoelectric figure of merit”:

$$Z \equiv \frac{S^2}{\rho k} \quad \text{(Equation 11)}$$

where S is the *Seebeck coefficient* of material (units Volts/K, indicates how many volts are produced for each degree of temperature change across the material), ρ is the electrical resistivity (units ohm m) (*not to be confused with density!*) and k is the material's thermal conductivity (W/mK).

(a) show that the units are valid (passes smoke test)

Everything is obviously dimensionless except for ZT_a , which must itself be dimensionless so that I can add it to 1. Note

$$ZT_a = \frac{S^2}{\rho k} T_a = \frac{\left(\frac{\text{Volt}}{K}\right)^2}{(\text{ohm } m) \left(\frac{W}{m K}\right)} K = \frac{\left(\frac{J/\text{coul}}{K}\right)^2}{\left(\frac{J s}{\text{coul}^2} m\right) \left(\frac{J/s}{m K}\right)} K = \frac{J^2 \left(\frac{1}{\text{coul}}\right)^2}{J^2 \left(\frac{1}{\text{coul}^2}\right) s \frac{1}{K^2} K} = 1 \quad \text{OK}$$

(b) show that the equation makes physical sense (passes function test)

- If the material $Z = 0$, it produces no electrical power thus the efficiency should be zero. If $Z = 0$ then

$$\eta = \left(1 - \frac{T_L}{T_H}\right) \frac{\sqrt{1+0T_a} - 1}{\sqrt{1+0T_a} + T_L/T_H} = \left(1 - \frac{T_L}{T_H}\right) \frac{\sqrt{1} - 1}{\sqrt{1} + T_L/T_H} = \left(1 - \frac{T_L}{T_H}\right) \frac{0}{1 + T_L/T_H} = 0 \quad \text{OK}$$

- If $T_L = T_H$, then there is no temperature difference across the thermoelectric material, and thus no power can be generated. In this case

$$\eta = (1-1) \frac{\sqrt{1+ZT_a} - 1}{\sqrt{1+ZT_a} + T_L/T_H} = (0) \frac{\sqrt{1+ZT_a} - 1}{\sqrt{1+ZT_a} + T_L/T_H} = 0 \quad \text{OK}$$

- Even the best possible material ($ZT_a \rightarrow \infty$) cannot produce an efficiency greater than the theoretically best possible efficiency (called the *Carnot cycle* efficiency, see page 91) = $1 - T_L/T_H$, for the same temperature range. As $ZT_a \rightarrow \infty$,

$$\eta \approx \left(1 - \frac{T_L}{T_H}\right) \frac{\sqrt{ZT_a} - 1}{\sqrt{ZT_a} + T_L/T_H} \approx \left(1 - \frac{T_L}{T_H}\right) \frac{\sqrt{ZT_a}}{\sqrt{ZT_a}} = 1 - \frac{T_L}{T_H} \quad \text{OK}$$

Side note #1: a good thermoelectric material such as Bi_2Te_3 has $ZT_a \approx 1$ and works up to about 200°C before it starts to melt, thus

$$\begin{aligned} \eta &= \left(1 - \frac{T_L}{T_H}\right) \frac{\sqrt{1+1} - 1}{\sqrt{1+1} + (25+273)/(200+273)} = 0.203 \left(1 - \frac{T_L}{T_H}\right) = 0.203 \eta_{\text{Carnot}} \\ &= 0.203 \left(1 - \frac{25+273}{200+273}\right) = 0.0750 = 7.50\% \end{aligned}$$

By comparison, your car engine has an efficiency of about 25%. So practical thermoelectric materials are, in general, not very good sources of electrical power, but are extremely useful in some niche applications, particularly when either (1) it is essential to have a device with no moving parts or (2) a “free” source of thermal energy at relatively low temperature is available, *e.g.*, the exhaust of an internal combustion engine.

Side note #2: a good thermoelectric material has a high S , so produces a large voltage for a small temperature change, a low ρ so that the resistance of the material to the flow of electric current is low, and a low k so that the temperature across the material ΔT is high. The heat transfer rate (in Watts) $q = kA\Delta T/\Delta x$ (see Chapter 7) where A is the cross-sectional area of the material and Δx is its thickness. So for a given ΔT , a smaller k means less q is transferred across the material. One might think that less q is worse, but no. Consider this:

The electrical power = $IV = (V/R)V = V^2/R = (S\Delta T)^2/(\rho\Delta x/A) = S^2\Delta T^2A/\rho\Delta x$.

The thermal power = $kA\Delta T/\Delta x$

The ratio of electrical to thermal power is $[S^2\Delta T^2A/\rho\Delta x]/[kA\Delta T/\Delta x] = (S^2/\rho k)\Delta T = Z\Delta T$, which is why Z is the “figure of merit” for thermoelectric generators.)

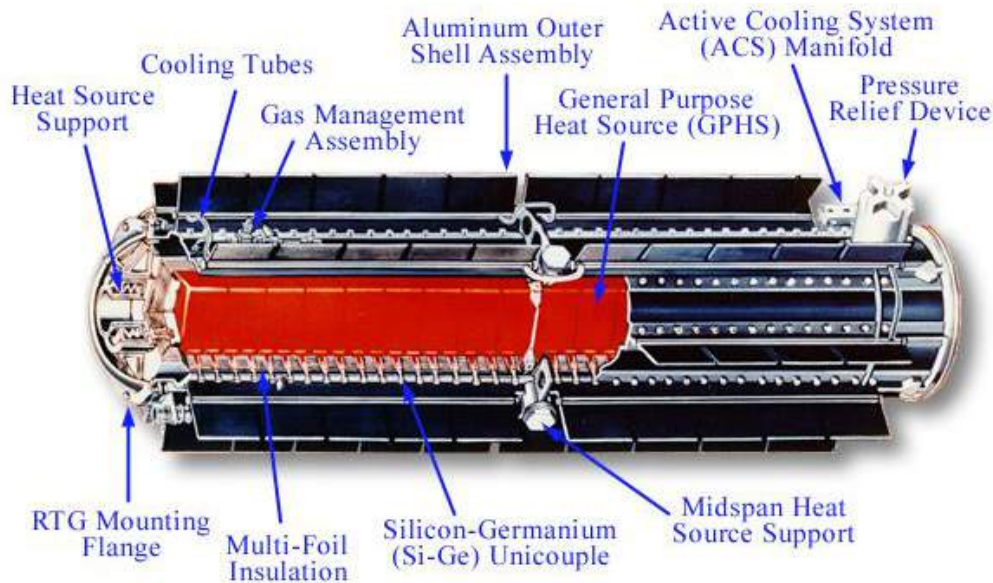

Figure 2. Radioisotope thermoelectric generator used for deep space missions. Note that the plutonium-238 radioisotope is called simply, “General Purpose Heat Source.”

Example 4. Density of matter

Estimate the density of a neutron. Does the result make sense? The density of a white dwarf star is about $2 \times 10^{12} \text{ kg/m}^3$ – is this reasonable?

The mass of a neutron is about one atomic mass unit (AMU), where a carbon-12 atom has a mass of 12 AMU and a mole of carbon-12 atoms has a mass of 12 grams. Thus one neutron has a mass of

$$(1 \text{ AMU}) \left(\frac{1 \text{ C-12 atom}}{12 \text{ AMU}} \right) \left(\frac{1 \text{ mole C-12}}{6.02 \times 10^{23} \text{ atoms C-12}} \right) \left(\frac{12 \text{ g C-12}}{\text{mole C-12}} \right) \left(\frac{1 \text{ kg}}{1000 \text{ g}} \right) = 1.66 \times 10^{-27} \text{ kg}$$

A neutron has a radius (r) of about 0.8 femtometer = 0.8×10^{-15} meter. Treating the neutron as a sphere, the volume is $4\pi r^3/3$, and the density (ρ) is the mass divided by the volume, thus

$$\rho = \frac{\text{mass}}{\text{volume}} = \frac{1.66 \times 10^{-27} \text{ kg}}{\frac{4\pi}{3} (0.8 \times 10^{-15} \text{ m})^3} = 7.75 \times 10^{17} \frac{\text{kg}}{\text{m}^3}$$

By comparison, water has a density of 10^3 kg/m^3 , so the density of a neutron is far higher (by a factor of 10^{14}) than that of atoms including their electrons. This is expected since the nucleus of an atom occupies only a small portion of the total space occupied by an atom – most of the atom is empty space where the electrons reside. Also, even the density of the white dwarf star is far less than the neutrons (by a factor of 10^5), which shows that the electron structure is squashed by the mass of the star, but not nearly down to the neutron scale (protons have a mass and size similar to neutrons, so the same point applies to protons too.)

Chapter 4. Forces in structures

“The Force can have a strong influence on the weak-minded”

- Ben Obi-wan Kenobi, explaining to Luke Skywalker how he made the famous “these aren’t the Droids you’re looking for” Jedi Mind Trick work.

Main course in AME curriculum on this topic: AME 201 (Statics).

Forces

Forces acting on objects are *vectors* that are characterized by not only a magnitude (e.g. Newtons or pounds force) but also a direction. A force vector \mathbf{F} (vectors are usually noted by a **boldface** letter) can be broken down into its components in the x, y and z directions in whatever coordinate system you’ve drawn:

$$\mathbf{F} = F_x\mathbf{i} + F_y\mathbf{j} + F_z\mathbf{k} \quad \text{Equation 12}$$

Where F_x , F_y and F_z are the magnitudes of the forces (units of force, e.g. Newtons or pounds force) in the x, y and z directions and \mathbf{i} , \mathbf{j} and \mathbf{k} are the *unit vectors* in the x, y and z directions (i.e. vectors whose directions are aligned with the x, y and z coordinates and whose magnitudes are exactly 1 (no units)).

Forces can also be expressed in terms of the magnitude $= (F_x^2 + F_y^2 + F_z^2)^{1/2}$ and direction relative to the positive x-axis ($= \tan^{-1}(F_y/F_x)$ in a 2-dimensional system). Note that the $\tan^{-1}(F_y/F_x)$ function gives you an angle between $+90^\circ$ and -90° whereas sometimes the resulting force is between $+90^\circ$ and $+180^\circ$ or between -90° and -180° ; in these cases you’ll have to examine the resulting force and add or subtract 180° from the force to get the right direction.

Degrees of freedom

Imagine a one-dimensional (1D) world, *i.e.*, where objects can move (translate) back and forth along a single line but in no other way. For this 1D world there is only one direction (call it the x-direction) that the object can move linearly and no way in which it can rotate, hence only one force balance equation is required. For the field of *dynamics* this equation would be Newton’s Second Law, namely that the sum of the forces $F_{x,1} + F_{x,2} + F_{x,3} + \dots + F_{x,n} = ma_x$ where m is the mass of the object and a_x is the acceleration of the object in the x direction, but this chapter focuses exclusively on *statics*, *i.e.* objects that are not accelerating, hence the force balance becomes simply

$$\sum_{i=1}^n F_{x,i} = 0 \quad \text{Equation 13.}$$

So a 1D world is quite simple, but what about a 2D world? Do we just need a second force balance equation for translation in the y direction (that is, $\Sigma F_y = 0$) and we’re done? Well, no. Let’s look at a counter-example (**Figure 3**). The set of forces on the object in the left panel satisfies the

requirements $\Sigma F_x = 0$ and $\Sigma F_y = 0$ and would appear to be in static equilibrium. In the right panel, it is also true that $\Sigma F_x = 0$ and $\Sigma F_y = 0$, but clearly this object would **not** be stationary; instead it would be rotating clockwise. Why is this? In two dimensions, in addition to the *translational* degrees of freedom in the x and y directions, there is also one *rotational* degree of freedom, that is, the object can rotate about an axis perpendicular to the x-y plane, *i.e.*, an axis in the z-direction. How do we ensure that the object is not rotating? We need to account for the *moments of force* (M) (discussed in the next sub-section) in addition to the forces themselves, and just as the forces in the x and y directions must add up to zero, *i.e.* $\Sigma F_x = 0$ and $\Sigma F_y = 0$, we need to have the moments of force add up to zero, *i.e.* $\Sigma M = 0$. So to summarize, in order to have *static equilibrium* of an object, the sum of all the forces AND the moments of force must be zero. In other words, there are two ways that a 2-dimensional object can translate (in the x and y directions) and one way that it can rotate (with the axis of rotation perpendicular to the x-y plane.) So there are 3 equations that must be satisfied in order to have equilibrium,

$$\sum_{i=1}^n F_{x,i} = 0; \sum_{j=1}^m F_{y,j} = 0; \sum_{k=1}^p M_{A,k} = 0 \quad \text{Equation 14}$$

where the number of forces in the x direction is n, the number of forces in the y direction is m and $p = n + m$ is the number of moments of force calculated with respect to some point A in the (x,y) plane. (The choice of location of point A is discussed below, but the bottom line is that any point yields the same result.)

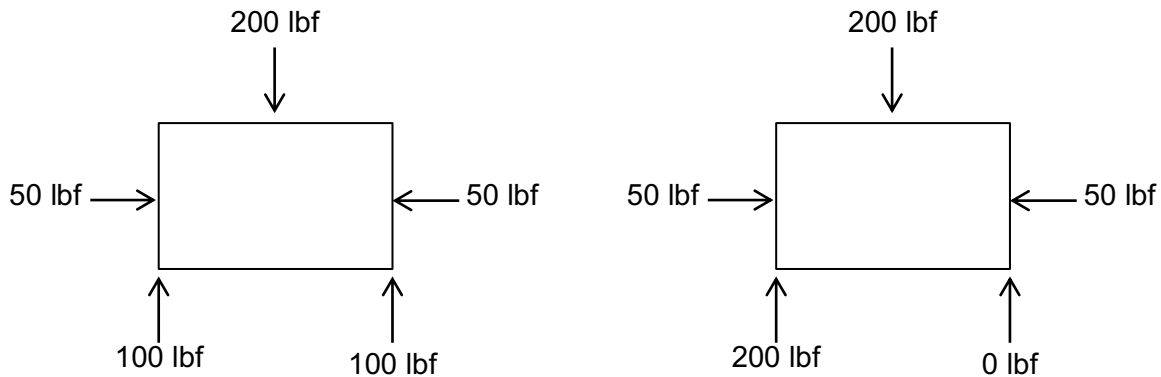

Figure 3. Two sets of forces on an object, both satisfying $\Sigma F_x = 0$ and $\Sigma F_y = 0$, but one (left) in static equilibrium, the other (right) not in static equilibrium.

This is all fine and well for a 2D (planar) situation, what about 3D? For 3D, there are 3 directions an object can move linearly (translate) and 3 axes about which it can rotate, thus we need 3 force balance equations (in the x, y and z directions) and 3 moment of force balance equations (one each about the x, y and z axes.) Table 1 summarizes these situations.

# of spatial dimensions	Maximum # of force balances	Minimum # of moment of force balances	Total # of unknown forces & moments
1	1	0	1
2	2	1	3
3	3	3	6

Table 1. Number of force and moment of force balance equations required for static equilibrium as a function of the dimensionality of the system. (But note that, as just described, moment of force balance equations can be substituted for force balance equations.)

Moments of forces

Some types of structures can only exert forces along the line connecting the two ends of the structure, but cannot exert any force perpendicular to that line. These types of structures include ropes, ends with pins, and bearings. Other structural elements can also exert a force perpendicular to the line (Figure 4). This is called the *moment of force* (often shortened to just “moment”, but to avoid confusion with “moment” meaning a short period of time, we will use the full term “moment of force”) which is the same thing as *torque*. Usually the term torque is reserved for the forces on rotating, not stationary, shafts, but there is no real difference between a moment of force and a torque.

The distinguishing feature of the moment of force is that it depends not only on the vector force itself (\mathbf{F}_i) but also the distance (d_i) from that line of force to a reference point A. (I like to call this distance the *moment arm*) from the anchor point at which it acts. If you want to loosen a stuck bolt, you want to apply whatever force your arm is capable of providing over the longest possible d_i . The line through the force \mathbf{F}_i is called the *line of action*. The moment arm is the distance (d_i again) between the line of action and a line parallel to the line of action that passes through the anchor point. Then the moment of force (M_i) is defined as

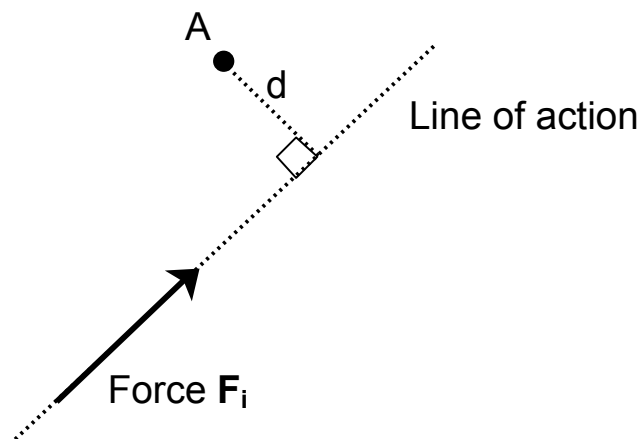

Figure 4. Force, line of action and moment of force ($= Fd$) about a point A. The example shown is a counterclockwise moment of force, i.e. force F_i is trying to rotate the line segment d counterclockwise about point A.

$$M_i = F_i d_i$$

Equation 15

where F_i is the magnitude of the vector \mathbf{F} . Note that the units of M_o is force x length, e.g. ft lbf or N m. This is the same as the unit of energy, but the two have nothing in common – it's just coincidence. So one could report a moment of force in units of Joules, but this is unacceptable practice – use N m, not J.

Note that it is necessary to assign a sign to M_i depending on whether the moment of force is trying to rotate the free body clockwise or counter-clockwise. Typically we will define a clockwise moment of force as positive and counterclockwise as negative, but one is free to choose the opposite definition – as long as you're consistent within an analysis.

Note that the moment of forces must be zero *regardless of the choice of the origin* (i.e. not just at the center of mass). So one can take the origin to be wherever it is convenient (e.g. make the moment of one of the forces = 0.) Consider the very simple set of forces below:

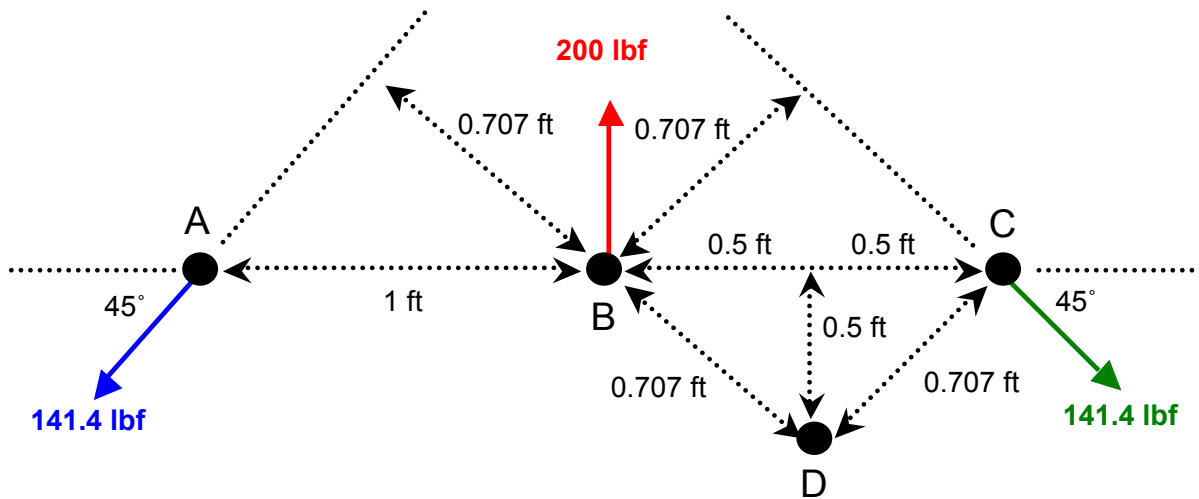

Figure 5. Force diagram showing different ways of computing moments of force

Because of the symmetry, it is easy to see that this set of forces constitutes an equilibrium condition. When taking moments of force about point 'B' we have:

$$\begin{aligned}\Sigma F_x &= +141.4 \cos(45^\circ) \text{ lbf} + 0 - 141.4 \cos(45^\circ) \text{ lbf} = 0 \\ \Sigma F_y &= +141.4 \sin(45^\circ) \text{ lbf} - 200 \text{ lbf} + 141.4 \sin(45^\circ) = 0 \\ \Sigma M_B &= -141.4 \text{ lbf} * 0.707 \text{ ft} - 200 \text{ lbf} * 0 \text{ ft} + 141.4 \text{ lbf} * 0.707 \text{ ft} = 0.\end{aligned}$$

But how do we know to take the moments of force about point B? We don't. But notice that if we take the moments of force about point 'A' then the force balances remain the same and

$$\Sigma M_A = -141.4 \text{ lbf} * 0 \text{ ft} - 200 \text{ lbf} * 1 \text{ ft} + 141.4 \text{ lbf} * 1.414 \text{ ft} = 0.$$

The same applies if we take moments of force about point 'C', or a point along the line ABC, or even a point NOT along the line ABC. For example, taking moments of force about point 'D',

$$\Sigma M_D = -141.4 \text{ lbf} * (0.707 \text{ ft} + 0.707 \text{ ft}) + 200 \text{ lbf} * 0.5 \text{ ft} + 141.4 \text{ lbf} * 0.707 \text{ ft} = 0$$

The location about which to take the moments of force can be chosen to make the problem as simple as possible, e.g. to make some of the moments of forces = 0.

Example of “why didn’t the book just say that...?” The state of equilibrium merely requires that 3 constraint equations are required. There is nothing in particular that requires there must be 2 force and 1 moment of force constraint equations. So one could have 1 force and 2 moment of force constraint equations:

$$\sum_{i=1}^n F_{x,i} = 0; \sum_{j=1}^m M_{j,A} = 0; \sum_{k=1}^p M_{k,B} = 0 \quad \text{Equation 16}$$

where the coordinate direction x can be chosen to be in any direction, and moments of force are taken about 2 separate points A and B. Or one could even have 3 moment of force equations:

$$\sum_{i=1}^n M_{i,A} = 0; \sum_{j=1}^m M_{j,B} = 0; \sum_{k=1}^p M_{k,C} = 0 \quad \text{Equation 17}$$

Also, there is no reason to restrict the x and y coordinates to the horizontal and vertical directions. They can be (for example) parallel and perpendicular to an inclined surface if that appears in the problem. In fact, the x and y axes don’t even have to be perpendicular to each other, as long as they are not parallel to each other, in which case $\Sigma F_x = 0$ and $\Sigma F_y = 0$ would not be independent equations.

Types of forces and moments of force

A *free body diagram* is a diagram showing all the forces and moments of forces acting on an object. We distinguish between two types of objects:

1. *Particles* that have no spatial extent and thus have no moment arm (d). An example of this would be a satellite orbiting the earth because the spatial extent of the satellite is very small compared to the distance from the earth to the satellite or the radius of the earth. Particles do not have moments of forces and thus do not rotate in response to a force.
2. *Rigid bodies* that have a finite dimension and thus has a moment arm (d) associated with each applied force. Rigid bodies have moments of forces and thus can rotate in response to a force.

There are several types of forces that act on particles or rigid bodies:

1. **Rope, cable, etc.** – Force (tension) must be along line of action; no moment of force (1 unknown force)



2. **Rollers, frictionless surface** – Force must be perpendicular to the surface; no moment of force (1 unknown force). There cannot be a force parallel to the surface because the roller would start rolling! Also the force must be away from the surface towards the roller (in other words the roller must exert a force on the surface), otherwise the roller would lift off of the surface.

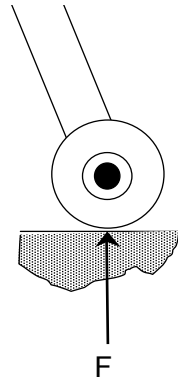

3. **Frictionless pin or hinge** – Force has components both parallel and perpendicular to the line of action; no moment of force (2 unknown forces) (note that the coordinate system does not need to be parallel and perpendicular to either the gravity vector or the bar)

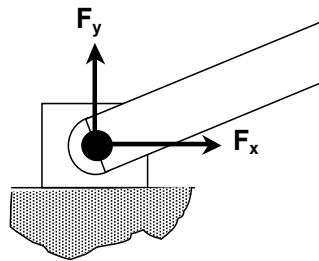

4. **Fixed support** – Force has components both parallel and perpendicular to line of action plus a moment of force (2 unknown forces, 1 unknown moment force). Note that for our simple statics problems with 3 degrees of freedom, if there is one fixed support then we already have 3 unknown quantities and the rest of our free body cannot have any unknown forces if we are to employ statics alone to determine the forces. In other words, if the free body has any additional unknown forces the system is *statically indeterminate* as will be discussed shortly.

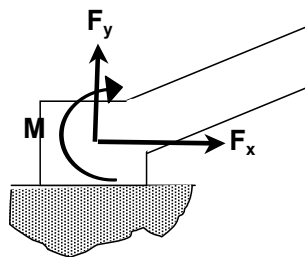

5. **Contact friction** – Force has components both parallel (F) and perpendicular (N) to surface, which are related by $F = \mu N$, where μ is the *coefficient of friction*, which is usually assigned

separate values for static (no sliding) (μ_s) and dynamic (sliding) (μ_d) friction, with the latter being lower. (2 unknown forces coupled by the relation $F = \mu N$). μ depends on both of the surfaces in contact. Most dry materials have friction coefficients between 0.3 and 0.6 but Teflon in contact with Teflon, for example, can have a coefficient as low as 0.04. Rubber (e.g. tires) in contact with other surfaces (e.g. asphalt) can yield friction coefficients of almost 2.

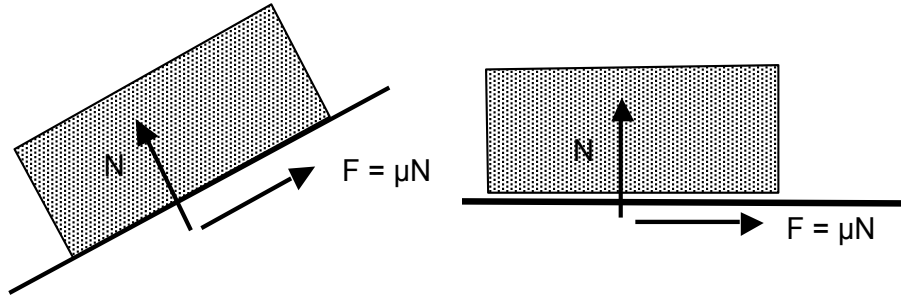

Actually, the statement $F = \mu_s N$ for static friction is not correct at all, although that's how it's almost always written. Consider the figure on the right, above. If there is no applied force in the horizontal direction, there is no need for friction to counter that force and keep the block from sliding, so $F = 0$. (If $F \neq 0$, then the object would start moving even though there is no applied force!) Of course, if a force were applied (e.g. from right to left, in the $-x$ direction) then the friction force at the interface between the block and the surface would counter the applied force with a force in the $+x$ direction so that $\Sigma F_x = 0$. On the other hand, if a force were applied from left to right, in the $+x$ direction) then the friction force at the interface between the block and the surface would counter the applied force with a force in the $-x$ direction so that $\Sigma F_x = 0$. The expression $F = \mu_s N$ only applies to the **maximum magnitude** of the static friction force. In other words, a proper statement quantifying the friction force would be $|F| \leq \mu_s N$, not $F = \mu_s N$. If any larger force is applied then the block would start moving and then the dynamic friction force $F = \mu_d N$ is the applicable one – but even then this force must always be in the direction opposite the motion – so $|F| = \mu_d N$ is an appropriate statement. Another, more precise way of writing this would be $\vec{F} = \mu_d N \frac{\vec{v}}{v}$, where \vec{v} is the velocity of the block and v is the magnitude of this velocity, thus $\frac{\vec{v}}{v}$ is a unit vector in the direction of motion.

Special note: while ropes, rollers and pins do not exert a moment of force **at the point of contact**, you can still sum up the moments of force **acting on the free body** at that point of contact. In other words, $\Sigma M_A = 0$ can be used even if point A is a contact point with a rope, roller or pin joint, and all of the other moments of force about point A (magnitude of force x distance from A to the line of action of that force) are still non-zero. Keep in mind that A can be any point, within or outside of the free body. It does not need to be a point where a force is applied, although it is often convenient to use one of those points as shown in the examples below.

Statically indeterminate system

Of course, there is no guarantee that the number of force and moment of force balance equations will be equal to the number of unknowns. For example, in a 2D problem, a beam supported by one pinned end and one roller end has 3 unknown forces and 3 equations of static equilibrium.

However, if both ends are pinned, there are 4 unknown forces but still only 3 equations of static equilibrium. Such a system is called *statically indeterminate* and requires additional information beyond the equations of statics (e.g. material stresses and strains, discussed in the next chapter) to determine the forces.

Analysis of statics problems

A useful methodology for analyzing statics problems is as follows:

1. Draw a free body diagram – a free body must be a rigid object, i.e. one that cannot bend in response to applied forces
2. Draw all of the forces acting on the free body. Is the number of unknown forces equal to the total number of independent constraint equations shown in Table 1 (far right column)? If not, statics can't help you.
3. Decide on a coordinate system. If the primary direction of forces is parallel and perpendicular to an inclined plane, usually it's most convenient to have the x and y coordinates parallel and perpendicular to the plane, as in the cart and sliding block examples below.
4. Decide on a set of constraint equations. As mentioned above, this can be any combination of force and moment of force balances that add up to the number of degrees of freedom of the system (Table 1).
5. Decide on the locations about which to perform moment of force constraint equations. Generally you should make this where the lines of action of two or more forces intersect because this will minimize the number of unknowns in your resulting equation.
6. Write down the force and moment of force constraint equations. If you've made good choices in steps 2 – 5, the resulting equations will be “easy” to solve.
7. Solve these “easy” equations.

Example 1. Ropes

The US Civil War Union ship Monitor and the Confederate ship Merrimack are pulling a Peace Barge due west up Chesapeake Bay toward Washington DC. The Monitor's tow rope is at an angle of 53 degrees north of due west with a tension of 4000 lbf. The Merrimack's tow rope is at an angle of 34 degrees south of due west but their scale attached to the rope is broken so the tension is unknown to the crew.

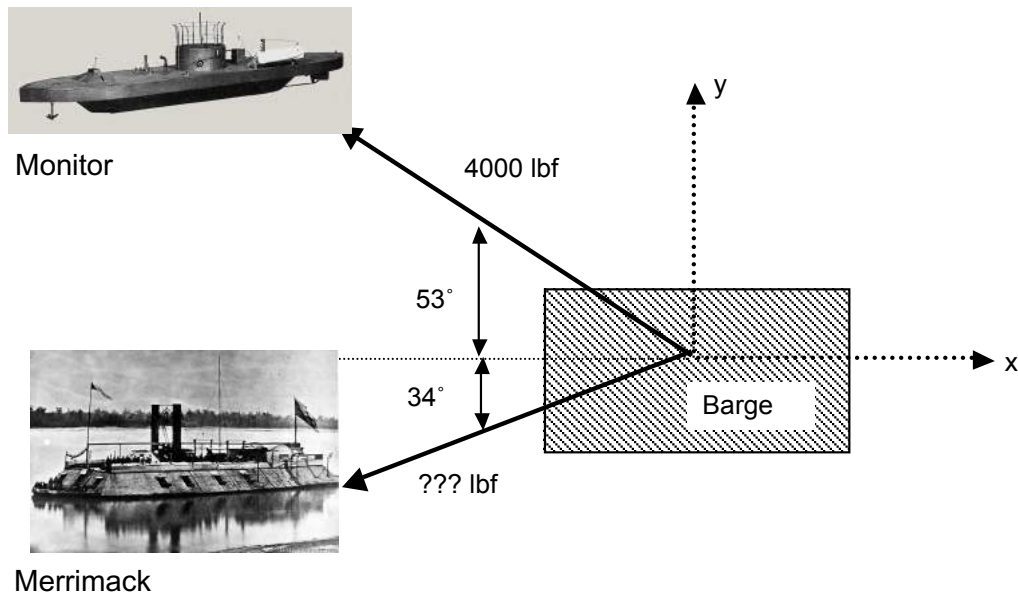

Figure 6. Free body diagram of Monitor-Merrimack system

- a) What is the tension in the Merrimack's tow rope?

Define x as positive in the easterly direction, y as positive in the northerly direction. In order for the Barge to travel due west, the northerly pull by the Monitor and the Southerly pull by the Merrimack have to be equal, or in other words the resultant force in the y direction, R_y , must be zero. The northerly pull by the Monitor is $4000 \sin(53^\circ) = 3195$ lbf. In order for this to equal the southerly pull of the Merrimack, we require $F_{\text{Merrimack}} \sin(34^\circ) = 3195$ lbf, thus $F_{\text{Merrimack}} = 5713$ lbf.

- b) What is the tension trying to break the Peace Barge (i.e. in the north-south direction)?

This is just the north/south force just computed, 3195 lbf

- c) What is the force pulling the Peace Barge up Chesapeake Bay?

The force exerted by the Monitor is $4000 \cos(53^\circ) = 2407$ lbf. The force exerted by the Merrimack is $5713 \cos(34^\circ) = 4736$ lbf. The resultant is $R_x = 7143$ lbf.

Example 2. Wheels

A car of known weight W is being held by a cable with tension T on an of angle θ with respect to horizontal. The wheels are free to rotate, so there is no force exerted by the wheels in the direction parallel to the ramp surface. The center of gravity of the vehicle is a distance " c " above the ramp, a distance " a " behind the front wheels, and a distance " b " in front of the rear wheels. The cable is attached to the car a distance " d " above the ramp surface and is parallel to the ramp.

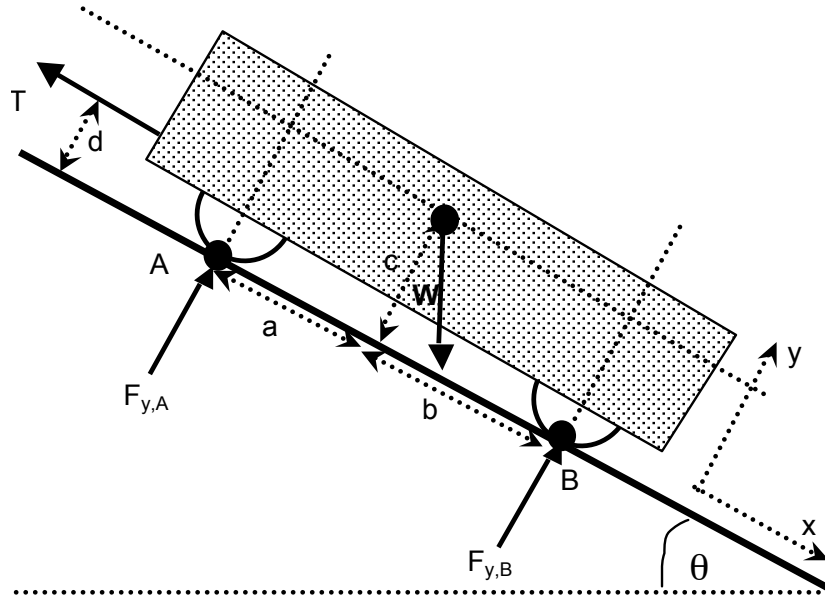

Figure 7. Free body diagram for car-on-ramp with cable example

- (a) What is the tension in the cable in terms of known quantities, i.e. the weight W , dimensions a , b , c , and d , and ramp angle θ ?

Define x as the direction parallel to the ramp surface and y perpendicular to the surface as shown. The forces in the x direction acting on the car are the cable tension T and component of the vehicle weight in the x direction $= W\sin\theta$, thus $\Sigma F_x = 0$ yields

$$W\sin\theta - T = 0 \Rightarrow T = W\sin\theta$$

- (b) What are the forces where the wheels contact the ramp ($F_{y,A}$ and $F_{y,B}$)?

The forces in the y direction acting on the car are $F_{y,A}$, $F_{y,B}$ and component of the vehicle weight in the y direction $= W\cos\theta$. Taking moments of force about point A, that is $\Sigma M_A = 0$ (so that the moment of force equation does not contain $F_{y,A}$ which makes the algebra simpler), and defining moments of force as positive clockwise yields

$$(W\sin\theta)(c) + (W\cos\theta)(a) - F_{y,B}(a+b) - T(d) = 0$$

Since we already know from part (a) that $T = W\sin\theta$, substitution yields

$$(W\sin\theta)(c) + (W\cos\theta)(a) - F_{y,B}(a+b) - (W\sin\theta)(d) = 0$$

Since this equation contains only one unknown force, namely $F_{y,B}$, it can be solved directly to obtain

$$F_{y,B} = W \frac{a \cos(\theta) + (c - d) \sin(\theta)}{a + b}$$

Finally taking $\Sigma F_y = 0$ yields

$$F_{y,A} + F_{y,B} - W\cos\theta = 0$$

Which we can substitute into the previous equation to find $F_{y,A}$:

$$F_{y,A} = W \frac{b\cos(\theta) - (c-d)\sin(\theta)}{a+b}$$

Note the function tests:

- 2) For $\theta = 0$, $T = 0$ (no tension required to keep the car from rolling on a level road)
- 3) As θ increases, the tension T required to keep the car from rolling increases
- 4) For $\theta = 90^\circ$, $T = W$ (all of the vehicle weight is on the cable) but note that $F_{y,A}$ and $F_{y,B}$ are non-zero (equal magnitudes, opposite signs) unless $c = d$, that is, the line of action of the cable tension goes through the car's center of gravity.
- 5) For $\theta = 0$, $F_{y,A} = (b/(a+b))$ and $F_{y,B} = (a/(a+b))$ (more weight on the wheels closer to the center of gravity.)
- 6) Because of the $-$ sign on the 2nd term in the numerator of $F_{y,A}$ ($-(c-d)\sin(\theta)$) and the $+$ sign in the 2nd term in the numerator of $F_{y,B}$ ($+(c-d)\sin(\theta)$), as θ increases, there is a transfer of weight from the front wheels to the rear wheels.

Note also that $F_{y,A} < 0$ for $b/(c-d) < \tan(\theta)$, at which point the front (upper) wheels lift off the ground, and that $F_{y,B} < 0$ for $a/(d-c) > \tan(\theta)$, at which point the back (lower) wheels lift off the ground. In either case, the analysis is invalid. (Be aware that c could be larger or smaller than d , so $c-d$ could be a positive or negative quantity.)

Example 3. Friction

A 100 lbf acts on a 300 lbf block placed on an inclined plane with a 3:4 slope. The coefficients of friction between the block and the plane are $\mu_s = 0.25$ and $\mu_d = 0.20$. The gravitational acceleration is standard earth gravity.

- a) Determine whether the block is in static equilibrium on the ramp
- b) If the block is not in static equilibrium (*i.e.*, it's sliding), find the net force on the block
- c) If the block is not in static equilibrium, find the acceleration of the block

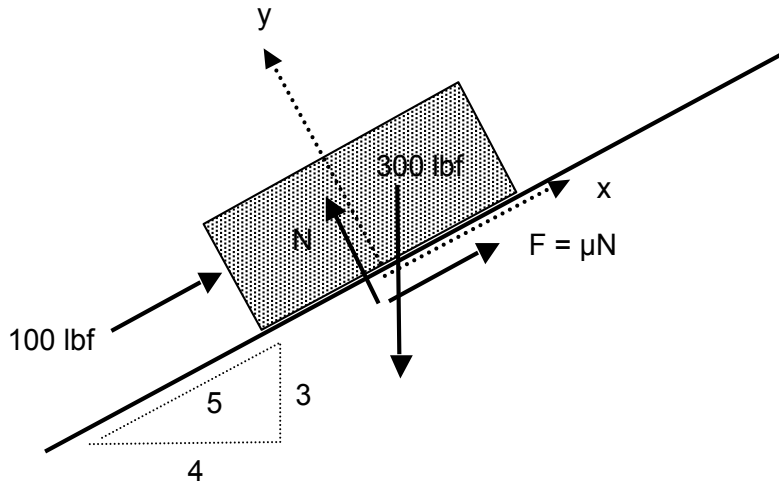

Figure 8. Free body diagram for sliding-block example

(a) To maintain equilibrium, we require that $\Sigma F_x = 0$ and $\Sigma F_y = 0$. Choosing the x direction parallel to the surface and y perpendicular to it,

$$\Sigma F_y = N - (4/5)(300 \text{ lbf}) = 0 \Rightarrow N = 240 \text{ lbf}$$

so the maximum possible friction force is

$$F_{\text{friction, max}} = \mu_s N = 0.25 * 240 \text{ lbf} = 60 \text{ lbf.}$$

The force needed to prevent the block from sliding is

$$\begin{aligned} \Sigma F_x &= 100 \text{ lbf} - (3/5)(300 \text{ lbf}) + F_{\text{needed}} = 0 \\ F_{\text{needed}} &= -100 \text{ lbf} + (3/5)(300 \text{ lbf}) = 80 \text{ lbf} \end{aligned}$$

Which is more than the maximum available friction force, so the block will slide down the plane.

(b) The sliding friction is given by

$$F_{\text{friction, max}} = \mu_d N = 0.20 * 240 \text{ lbf} = 48 \text{ lbf}$$

so the net force acting on the block in the x direction (not zero since the block is not at equilibrium) is

$$\Sigma F_x = 100 \text{ lbf} - (3/5)(300 \text{ lbf}) + 48 \text{ lbf} = -32 \text{ lbf}$$

(b) Note that the mass of an object that weighs 300 lbf at earth gravity is 300 lbm (see example 1, chapter 2). Thus

$$F = ma \Rightarrow -32 \text{ lbf} = (300 \text{ lbm})(a) \Rightarrow a = -32 \text{ lbf}/300 \text{ lbm} ???$$

what does $-32 \text{ lbf}/300 \text{ lbm}$ mean? lbf/lbm has units of force/mass, so it is an acceleration. But how to convert to something useful like ft/s^2 ? Multiply by 1 in the funny form of $g_c = 1 = 32.174 \text{ lbf ft} / \text{lbf s}^2$, of course!

$$\text{acceleration} = (-32 \text{ lbf}/300 \text{ lbm}) (32.174 \text{ lbf ft} / \text{lbf s}^2) = -3.43 \text{ ft}/\text{s}^2$$

or, since $g_{\text{earth}} = 32.174 \text{ ft}/\text{s}^2$,

$$\text{acceleration} = (-3.43 \text{ ft}/\text{s}^2)/(32.174 \text{ ft}/\text{s}^2 g_{\text{earth}}) = -0.107 g_{\text{earth}}$$

The negative sign indicates the acceleration is in the $-x$ direction, i.e. down the slope of course.

A good function test is that the acceleration has to be less than $1 g_{\text{earth}}$, which is what you would get if you dropped the block vertically in a frictionless environment. Obviously, a block sliding down a slope (not vertical) with friction and with an external force acting up the slope must have a smaller acceleration.

Example 4. Wheels and friction

A car of known weight W is equipped with rubber tires with coefficient of static friction μ_s . Unlike the earlier example, there is no cable but the wheels are locked and thus the tires exert a friction force parallel to and in the plane of the ramp surface. As with the previous example, the car is on a ramp of angle θ with respect to horizontal. The center of gravity of the vehicle is a distance “ c ” above the ramp, a distance “ a ” behind the front wheels, and a distance “ b ” in front of the rear wheels.

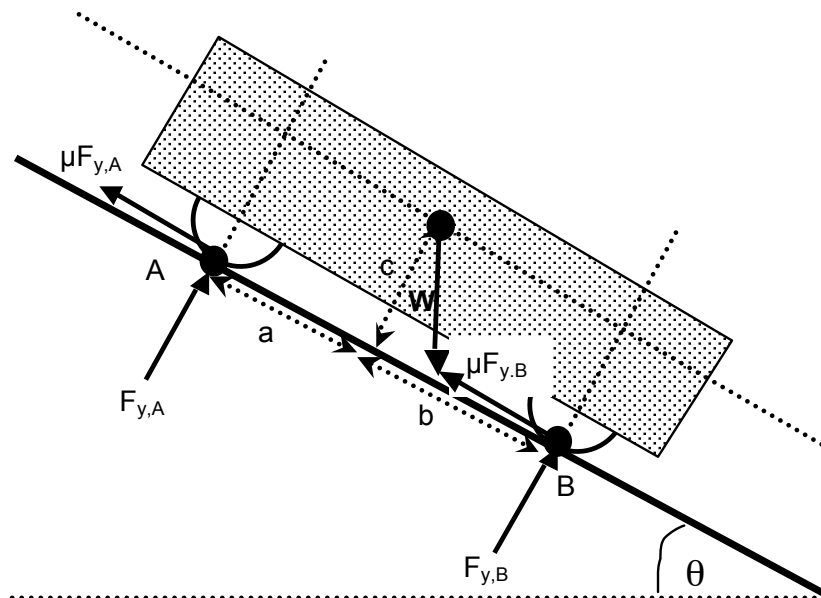

Figure 9. Free body diagram for car-on-ramp with friction example

(a) What is the minimum μ_s required to keep the car from sliding down the ramp?

The unknowns are the resulting forces at the wheels ($F_{y,A}$ and $F_{y,B}$) and the coefficient of friction μ_s . Taking $\Sigma F_x = 0$, $\Sigma F_y = 0$ and $\Sigma M_A = 0$ yields, respectively,

$$-\mu_s F_{y,A} - \mu_s F_{y,B} + W \sin \theta = 0$$

$$F_{y,A} + F_{y,B} - W \cos \theta = 0$$

$$(W \sin \theta)(c) + (W \cos \theta)(a) - F_{y,B}(a+b) = 0$$

Which may be solved to obtain

$$F_{y,A} = W \frac{b \cos(\theta) - (c-d) \sin(\theta)}{a+b}; F_{y,B} = W \frac{a \cos(\theta) + c \sin(\theta)}{a+b}; \mu_s = \frac{\sin(\theta)}{\cos(\theta)} = \tan(\theta)$$

Note the function tests

- 1) For $\theta = 0$, $\mu_s = \tan(\theta) = 0$ (no friction required to keep the car from sliding on a level road)
- 2) As θ increases, the friction coefficient μ_s required to keep the car from sliding increases
- 3) For $\theta = 0$, $F_{y,A} = (b/(a+b))$ and $F_{y,B} = (a/(a+b))$ (more weight on the wheels closer to the center of gravity)
- 4) Because of the $-$ sign on the 2nd term in the numerator of $F_{y,A}$ ($-c \sin(\theta)$) and the $+$ sign in the 2nd term in the numerator of $F_{y,B}$ ($+c \sin(\theta)$), as θ increases, there is a transfer of weight from the front wheels to the rear wheels.

Note also that we could have also tried $\Sigma F_y = 0$, ΣM_A and $\Sigma M_B = 0$:

$$F_{y,A} + F_{y,B} - W \cos \theta = 0$$

$$(W \sin \theta)(c) + (W \cos \theta)(a) - F_{y,B}(a+b) = 0$$

$$(W \sin \theta)(c) - (W \cos \theta)(b) + F_{y,A}(a+b) = 0$$

In which case, the second equation could have been subtracted from the third to obtain:

$$F_{y,A} + F_{y,B} - W \cos \theta = 0$$

which is the same as the first equation. So the three equations are not independent of each other, and we can't solve the system. What's wrong? *The coefficient of friction μ_s doesn't appear in the set of equations $\Sigma F_x = 0$, ΣM_A and $\Sigma M_B = 0$.* We need to have each of the three unknowns $F_{y,A}$, $F_{y,B}$ and μ_s in at least one of the three equations. The set $\Sigma F_x = 0$, ΣM_A and $\Sigma M_B = 0$ doesn't satisfy that criterion.

- (b) At what angle will the car tip over backwards, assuming that it doesn't start sliding down the ramp at a smaller angle due to low μ_s ?

This will occur when $F_{y,A} = 0$, i.e. when $\sin(\theta)/\cos(\theta) = \tan(\theta) = b/c$. This is reasonable because the tip-over angle should increase when c is made larger (center of gravity closer to the ground) or b made smaller (center of gravity shifted forward). Notice also that it doesn't depend on μ_s , that is, as long as it doesn't slide due to low μ_s , the tip-over angle only depends on the force balance.

For what it's worth, also note that the tip-over angle equals the sliding angle when $\tan(\theta) = \mu_s = b/c$. Since generally $\mu_s < 1$, except for a very top-heavy (large c) or rear-weight-shifted (small b) vehicles, the vehicle will slide down the ramp before it flips over backwards.

Example 5. Pinned joint

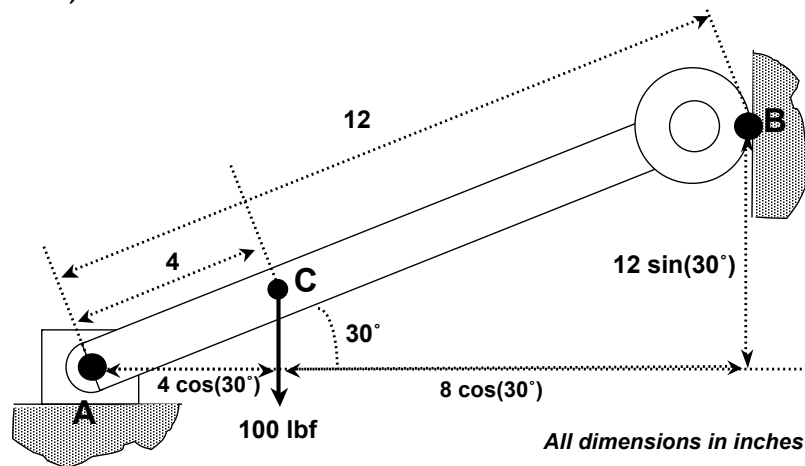

Figure 10. Free body diagram for pinned joint example

A straight bar of negligible mass 12 inches long is pinned at its lower end (call it point A) and has a roller attached to its upper end (call it point B) as shown in the figure. The bar is at a 30° angle from horizontal. A weight of 100 lbf is hung 4 inches from the lower end (call it point C).

- a) What are the forces in the x and y directions on the pinned end? What is the force in the x direction on the roller end?

The pinned end can sustain forces in both the x and y directions, but no moment of force. The roller end can sustain a force only in the x direction, and again no moment of force. Summing the forces in the y direction

$$F_{y,A} + F_{y,B} + F_{y,C} = 0 \Rightarrow F_{y,A} + 0 - 100 \text{ lbf} = 0 \Rightarrow F_{y,A} = +100 \text{ lbf.}$$

In other words, in the y direction the vertical force at point A must be +100 lbf since that is the only force available to counteract the 100 lbf weight. Next, taking moments of force about point A (since the lines of action of two of the unknown forces intersect at point A),

$$\Sigma M_A = 0 \Rightarrow +(4 \text{ in})(\cos(30^\circ))(100 \text{ lbf}) + (6 \text{ in})F_{x,B} = 0 \Rightarrow F_{x,B} = -57.7 \text{ lbf.}$$

Finally, for force balance in the x direction,

$$F_{x,A} + F_{x,B} + F_{x,C} = 0 \Rightarrow F_{x,A} = -F_{x,B} - F_{x,C} = -(-57.7 \text{ lbf}) - 0 = +57.7 \text{ lbf}$$

- b) Would the forces change if the roller and pinned ends were reversed?

In this case summing the forces in the x direction:

$$F_{x,A} + F_{x,B} + F_{x,C} = 0 \Rightarrow 0 + F_{x,B} + 0 = 0 \Rightarrow F_{x,B} = 0.$$

For force balance in the y direction,

$$F_{y,A} + F_{y,B} + F_{y,C} = 0 \Rightarrow F_{y,A} + F_{y,B} = 100 \text{ lbf}$$

Taking moments of force about point C just for variety (not the easiest way, since neither $F_{y,A}$ nor $F_{y,B}$ are known, we just know that $F_{y,A} + F_{y,B} = 100 \text{ lbf}$),

$$\Sigma M_C = 0 \Rightarrow (4 \text{ in})(\cos(30^\circ))F_{y,A} - (8 \text{ in})(\cos(30^\circ))F_{y,B} + (8 \text{ in})(\sin(30^\circ))F_{x,B} = 0$$

$$\Rightarrow (4 \text{ in})(\cos(30^\circ))(100 \text{ lbf} - F_{y,B}) - (8 \text{ in})(\cos(30^\circ))F_{y,B} + 0 = 0$$

$$\Rightarrow F_{y,B} = +33.3 \text{ lbf} \Rightarrow F_{y,A} = +66.7 \text{ lbf}$$

which is quite different from case (a).

- c) What would happen if the lower end were fixed rather than pinned (upper end having the roller again)?

In this case there are 4 unknown quantities ($F_{x,A}$, $F_{y,A}$, M_A and $F_{x,B}$) but only 3 equations ($\Sigma F_x = 0$, $\Sigma F_y = 0$, $\Sigma M = 0$) so the system is statically indeterminate. If one takes away the roller end entirely, then obviously $F_{y,A} = 100 \text{ lbf}$, $F_{x,A} = 0$ and $M_A = +(100 \text{ lbf})(4 \text{ in})(\cos(30^\circ)) = 346.4 \text{ in lbf}$.

Chapter 5. Stresses, strains and material properties

“It is not stress that kills us, it is our reaction to it”

- Hans Selye, endocrinologist.

Main course in AME curriculum on this topic: AME 204 (Strength of Materials).

Stresses and strains

As a follow-on to the discussion of statics we need to consider whether a material subject to a given set of forces will break and if not, how much it will bend. While we will write down many formulas in this chapter without deriving them, essentially what these equations do is

1. Break an object up into many infinitesimal cubes of dimension $dx \times dy \times dz$
2. Apply the laws of statics you just learned to these infinitesimal cubes of material that may deform
3. Apply *constitutive laws* relating the forces (actually *stresses*, defined below) acting on each cube to its deformation and thus displacement from where it was without applied forces
4. Write a set of equations for all these cubes that is mutually consistent, that is, the stress and displacement on the right face of cube A must be equal to those on the left side of adjacent cube B
5. Solve this large set of equations to determine the stresses and displacements everywhere in the object

As this discussion implies, the first step in the process is to compute the *stress* in the material. There are two flavors of stress, the *normal stress* which is the stress in the direction perpendicular to an imaginary plane in the material, and the *shear stress* which is the stress in the direction parallel to that same imaginary plane. Of course, this imaginary plane could be in any direction, so the magnitude of the normal and shear stresses depends strongly on the choice of said imaginary plane. How should one choose said plane and what is the relationship between normal and shear stresses? We'll discuss that shortly, but first we'll individually define normal then shear stress.

The *normal stress* (σ) in a material is defined as

$$\sigma \equiv F/A$$

Equation 18

where F is the force (either tension or compression) acting perpendicular to an imaginary plane surface passing through a piece of material and A is the cross section area. It is called “normal” not in the sense of being “typical” or “standard” but in the sense of being perpendicular or orthogonal to the cross-section of the material. **Stress is defined as positive if the material is in tension** (i.e. the material is being pulled apart) and **negative if the material is in compression** (i.e. being squeezed together). From the definition it is clear that stress has units of force/area, i.e. the same as pressure. The units are typically N/m^2 or lbf/in^2 . Sometimes the unit of “kips” (kilopounds per square inch = 1000 lbf/in^2) is used to report stress.

In order to characterize the deformation of a material in response to stress we define another property called *strain* (ϵ) which is the fractional amount of elongation (increase in length) or contraction (decrease in length) in a material caused by a stress. For example, if under a given amount of tensile stress, a steel bar stretches from an initial length (L) of 1.00 inch to a final length 1.01 inch (a change in length, ΔL , of 0.01 inch) the strain = $(1.01 - 1.00)/1.00 = 0.01$. In other words,

$$\epsilon \equiv \Delta L/L \quad \text{Equation 19}$$

For most materials (other than gooey ones, i.e. Silly Putty™, Play-Doh™, ...) the maximum strain before failure of the material is relatively small (*i.e.* less than 0.1, meaning that the material deforms less than 10% before failing.)

An *elastic* material has a linear relationship between stress and strain, i.e.

$$\sigma = \epsilon E \quad \text{Equation 20}$$

where E is called the *elastic modulus*, i.e. the slope of the plot of σ vs. ϵ in the elastic region shown in Figure 11. An equation such as this one is an example of a *constitutive relation* between the stress and deformation mentioned at the beginning of this chapter (the ideal gas law is another example of a constitutive relation between the properties of a material). Note that since ϵ is dimensionless, E also has units of σ , that is, force per unit area.

The strength of a material is generally reported in terms of the maximum stress it can withstand without breaking. For a sufficiently small stress, materials return to their original length or shape after the stress is removed. The smallest stress for which the material does **not** return to its original length or shape after the stress is removed is called the *yield stress* (σ_{yield}). Beyond this stress, generally the slope of a plot of σ vs. ϵ plot generally (but not always) becomes smaller. There is often an increase in slope as ϵ is increased still further, up to a maximum σ called the “ultimate stress”, beyond which σ actually *decreases* as ϵ increases, leading finally to fracture (breakage) of the material at which point it can no longer hold any stress at all. **A material’s yield stress may be (and usually is) different in tension, compression and shear.**

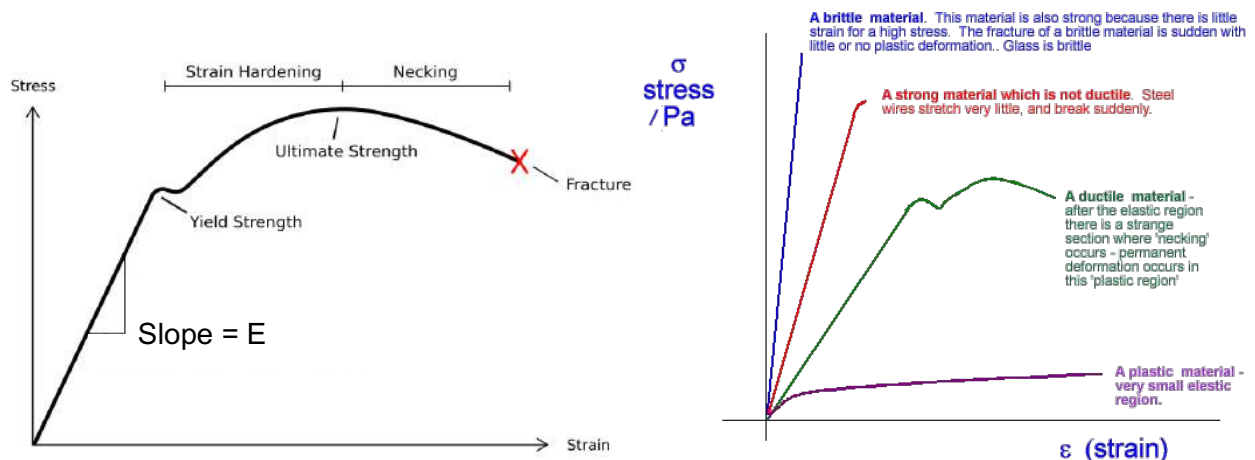

Figure 11. Typical stress-strain relationships: left: ductile material; right: comparison of various types of materials. Sources: wikipedia.com, cyberphysics.co.uk.

Note that we can write the above equation $\sigma = \epsilon E$ in the form $F/A = (\Delta L/L)E$ or $F = (EA/L)(\Delta L)$, which looks just like the force on a linear spring, $F = kx$, with $k = EA/L$. (One might wonder what happened to the - sign, that is, isn't $F = -kx$? Stress is defined as positive in tension whereas for the spring F is defined as positive in compression.) Consequently, the elastic modulus E and the material dimensions A and L determine its “spring constant.” Figure 11 shows examples of stress vs. strain (σ vs. ϵ) relationships for different materials. A *ductile* material such as steel will yield significantly before fracture whereas a *brittle* material such as a ceramic or concrete will fail without significant yielding, that is, the σ vs. ϵ curve is nearly linear up to the failure point. This doesn't mean that ceramics are necessarily weak, in fact they may have higher E than ductile materials, but they are unforgiving to over-stressing (really, over-straining.)

E and yield or ultimate stress have the same units (Pa or lbf/in²) but there is no particular relationship between E and yield or ultimate stress. Materials can be hard (high E) but break easily (low yield or ultimate stress) or vice versa. Some examples of material properties are shown in **Table 2**. This table shows materials that are *isotropic*, *i.e.*, their properties are similar no matter what direction stress is applied relative to the material. Many engineering materials are *anisotropic*, *i.e.*, they are not isotropic. A typical example of such materials is graphite-epoxy composites composed of fibers of graphitic carbon (which have very high yield stress in the plane of the graphite sheets, and low yield stress in the direction perpendicular to this plane) that are bonded to an epoxy polymer, which has relatively low yield stress in tension but high yield stress in compression and shear. The result is a material that has very high stress for its weight. The Boeing 787 uses composites for most of the structure; this has the advantage of high ratio of yield stress to weight, no possibility of corrosion, and relative ease of forming into any desired shape. (One could also say that a much older engineering material, namely wood, is also an anisotropic composite material.)

Of course, in any design one must employ a material with a yield stress greater than the actual stress that will occur in the material; the ratio of the yield stress of the material to the actual predicted stress in the material is call the **factor of safety**. For example, if a material has a yield stress in tension of 10,000 lbf/in² and the system is designed such that the maximum tension is 2,500 lbf/in², the factor of safety for this particular design is $(10,000 \text{ lbf/in}^2 / 2,500 \text{ lbf/in}^2) = 4$, at least in tension.

Material	E (10 ⁹ Pa)	ν	Yield stress (tension unless otherwise noted) (10 ⁶ Pa)	Ultimate stress (10 ⁶ Pa)
Aluminum, 6061-T6	68.9	0.32	276	310
Steel, 4340-HR	200	0.30	910	1041
Iron, pure	200	0.29	30	540
Diamond	700 – 1200	0.10 – 0.29	8680 – 16530 (compressive)	
High-density polyethylene	0.18 – 1.6		2.4 – 31.7	10 – 50
Alumina, Al ₂ O ₃	370	0.22	3000 (compressive)	300
Solder (60% tin, 40% lead)	30	0.4		53
Silica aerogel	0.001 – 0.01	0.2		0.016

Table 2. Properties of some common materials (from <http://www.matweb.com>)

Some factoids about materials

How strong are these materials? How does this compare with the strength of the attractive forces between the atoms (F_{atoms})? That is, can we estimate the yield stress of the material $\sigma \approx F_{\text{atoms}}/A_{\text{atoms}}$, where A_{atoms} is the cross-section area of the atoms? How could we estimate F_{atoms} and A_{atoms} based on macroscopically measurable properties? Let's start with the size of one atom. Let's consider a typical material like aluminum. Its molecular weight is 27 g/mole, and its density is (by coincidence) 2.7 g/cm³, and 1 mole = 6.02 x 10²³ atoms. So the volume occupied by each atom is

$$\frac{\text{cm}^3}{2.7 \text{ g}} \frac{27 \text{ g}}{\text{mole}} \frac{\text{mole}}{6.02 \times 10^{23} \text{ atom}} = 1.66 \times 10^{-23} \frac{\text{cm}^3}{\text{atom}}$$

Thus each atom occupies a roughly cubic space of $(1.66 \times 10^{-23})^{1/3} = 2.55 \times 10^{-8} \text{ cm} = 2.55 \times 10^{-10} \text{ m}$, or a cross-section area of $(2.55 \times 10^{-10} \text{ m})^2 = 6.51 \times 10^{-20} \text{ m}^2$. What is the attractive force between the atoms? The heat of formation of Al(gas) from Al(s) is 330 kJ/mole (see <http://webbook.nist.gov>). This is the energy needed to separate Al atoms in the solid phase from each other to make a gas. On a per-atom basis this is $(330,000 \text{ J/mole})(\text{mole}/6.02 \times 10^{23} \text{ atoms}) = 5.48 \times 10^{-19} \text{ J}$. Then, since Energy = force x distance, we can roughly estimate the attractive force as energy/distance or

$$F_{\text{atoms}} = (5.48 \times 10^{-19} \text{ J}) / (2.55 \times 10^{-10} \text{ m}) = 2.15 \times 10^{-9} \text{ N}.$$

Then finally, the force per unit area is

$$F_{\text{atoms}} = (2.15 \times 10^{-9} \text{ N}) / (6.51 \times 10^{-20} \text{ m}^2) = 3.30 \times 10^{10} \text{ Pa} = 33 \text{ GPa}$$

Note that this is comparable to the elastic modulus (E), not the yield stress in tension or shear, which is about 1000 times smaller. Why is the yield stress so much smaller than the elastic modulus? For a perfect crystal with no defects, the above estimate would be appropriate. But real materials have *defects* in their crystalline structure. The yield stress of materials is determined mostly by the *microstructural properties* like the number of defects, the size of the “grains” (individual crystals), and the response of the defects to strain. This is why small amounts of additives (like adding carbon to iron to make steel) to a material and the details of how the material is processed (e.g. heat treating, rolling, etc.) affect its yield stress so much, but do not significantly affect other properties such as E, ν (see below), density, etc. You'll learn much more about this in MASC 310.

As materials deform under tension, they become longer of course, but they also become narrower. The ratio between the change in diameter (d) of a cylindrical sample and change in length (L) is called *Poisson's ratio* (ν), *i.e.*,

$$\nu \equiv - \frac{\Delta d}{d} \bigg/ \frac{\Delta L}{L} \qquad \text{Equation 21}$$

The minus sign is there because under tension $\Delta L > 0$ (sample lengthening) but $\Delta d < 0$ (sample is narrowing). Note that the volume (V) of the cylindrical sample is $L\pi d^2/4$ before applying the stress, and $(L+\Delta L)\pi(d+\Delta d)^2/4$ after applying the stress. So

$$\frac{V + \Delta V}{V} = \frac{(\pi/4)(L + \Delta L)(d + \Delta d)^2}{(\pi/4)Ld^2} = \left(1 + \frac{\Delta L}{L}\right)\left(1 + \frac{\Delta d}{d}\right)^2$$

or, keeping only leading-order terms, i.e., with only one $\Delta d/d$ or $\Delta L/L$ and discarding terms like $(\Delta d/d)^2$, $(\Delta L)(\Delta d)/Ld$, $(\Delta L/L)^2$ etc.:

$$\frac{\Delta V}{V} = 2\frac{\Delta d}{d} + \frac{\Delta L}{L} = 2\frac{\Delta L}{L}\left(\frac{\Delta d}{d} / \frac{\Delta L}{L}\right) + \frac{\Delta L}{L} = \frac{\Delta L}{L}(1 - 2\nu) \quad \text{Equation 22.}$$

Function test. From the above equation, it is apparent that for a material to have no change in volume under stress, one would need $1 - 2\nu = 0$ or $\nu = 0.5$. In reality most materials have $\nu \approx 0.3$, which means that their volume increases under tensile load ($\Delta L/L > 0$). Certainly, one would not expect $\nu > 0.5$, for this would imply the volume decreases under tensile load, and increases under compressive load ($\Delta L/L < 0$) – not very likely!

Example

A 1/2 inch diameter steel bar increases in length from 10 cm to 10.4 cm under an applied force of 10,000 lbf.

- (a) What is the stress in the bar?

$$\text{Stress} = \text{force/area} = 10,000 \text{ lbf} / (\pi(0.5 \text{ in})^2/4) = 50920 \text{ lbf/in}^2.$$

- (b) What is the strain in the bar?

$$\text{Strain} = \Delta L/L = (10.4 \text{ cm} - 10 \text{ cm})/(10 \text{ cm}) = 0.04$$

- (c) What is the change in diameter of the bar?

Note that the volume of the bar isn't constant; to answer this question you'll have to use the expression for Poisson's ratio given above.

$$\nu \equiv -(\Delta d/d)/(\Delta L/L); \text{ if } \nu \approx 0.3 \text{ for steel as in Table 2, then}$$

$$\Delta d = -\nu d(\Delta L/L) = -(0.3)(0.5 \text{ inch})((0.4 \text{ cm})/(10 \text{ cm})) = -0.006 \text{ inch}$$

Shear forces

Tension and compression are forces that act in the direction perpendicular to a particular imaginary plane cut through a piece of material. The force that acts *parallel to a particular imaginary plane* cut through the material is called the *shear force* (V) (why V ? I dunno...) The *shear stress* (τ) is the shear force per unit area, i.e.

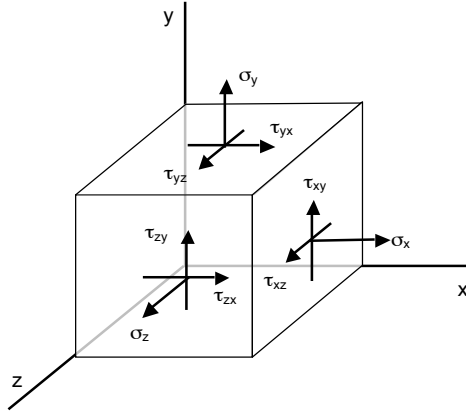

Figure 12. Diagram of normal (σ) and shear (τ) stresses in an imaginary, infinitesimally small cube of material

$$\tau = V/A.$$

Equation 23

To describe **all** of the stresses (normal and shear) in a material, we need something more than just a vector (which sufficed to describe forces.) For example, a two-dimensional object in the x-y plane has two components of tension or compression (call them σ_x and σ_y) and two shear stresses (one each in the x and y directions; call them τ_{xy-x} and τ_{xy-y} ; usually these are just called τ_{yx} and τ_{xy}). These are 4 entities acting in the x-y plane; the composite effect of these 4 stresses cannot be represented in terms of a single scalar or vector. In three dimensions, the situation is even more problematic. As shown in Figure 12, a three-dimensional object will have three components of tension or compression (one each in the x, y and z directions) and six components of shear (in the x-y plane, in the x and y directions; in the y-z plane, in the y and z directions; and in the x-z plane, in the x and z directions). Consequently, stress is actually not a single scalar value or even a single vector, but a 3 x 3 matrix called the **Cauchy stress tensor** σ :

$$\sigma = \begin{bmatrix} \sigma_x & \tau_{xy} & \tau_{xz} \\ \tau_{yx} & \sigma_y & \tau_{yz} \\ \tau_{zx} & \tau_{zy} & \sigma_z \end{bmatrix}$$

Equation 24

Keep in mind that for each force shown in Figure 12, there is an equal and oppositely-directed force on the opposing side of the imaginary cube. This looks fairly complicated, and perhaps it is, but one saving grace is that, in order for the moments of force about a very small cube of material to sum to zero, one must have $\tau_{xy-x} = \tau_{yx-y}$, $\tau_{zx-z} = \tau_{xz-x}$ and $\tau_{zy-z} = \tau_{yz-y}$, in other word the matrix is *symmetric*. So there are only 6, not 9, independent stresses, or in two dimensions there are only 3 independent stresses, namely σ_x , σ_y and $\tau_{xy} = \tau_{yx}$. Note the analogy between the number of independent stresses (3 in two dimensions, 6 in three dimensions) and the number of degrees of freedom of a free body (see Table 1) which determines the number of constraint equations needed to enforce static equilibrium; this is not a coincidence at all but a necessary outcome of the number of degrees of freedom of an object as discussed in the previous chapter on Statics. Consequently, **for two-dimensional systems**, and taking advantage of the fact that $\tau_{xy} = \tau_{yx}$, we can write the Cauchy stress tensor as

$$\sigma = \begin{bmatrix} \sigma_x & \tau_{xy} \\ \tau_{xy} & \sigma_y \end{bmatrix} \quad (\text{for any 2D system}) \quad \text{Equation 25}$$

As previously stated, normal stress is defined as the stress in the direction perpendicular to an imaginary plane and shear stress is defined as the stress in the direction parallel to that same imaginary plane – but how should that plane be chosen? For a simple shape like a cylinder it seems natural to define a plane parallel to the ends of the cylinder, but what about oddly shaped objects? Will the stresses be different depending on how one chooses the coordinate system? Will an object fail or not fail under stress depending on how one chooses the coordinate system? What is important to understand is that the **magnitudes of both normal stress and shear stress are entirely dependent on the choice of coordinate system**. This is no different than simple forces; how much force is in the x-direction and how much is in the y-direction is entirely dependent on the choice of coordinate system, however, for a certain choice of coordinates, the shear stress or the normal stress may be exactly zero as discussed below.

It is worth noting that for shear stresses τ_{xy} we do not need to distinguish between positive and negative values since τ_{xy} always appears in the equations in the form τ_{xy}^2 and τ_{\max} always has a \pm sign in front of it. This is because (as **Figure 13** indicates) only 1 type of shear stress $\tau_{xy} = \tau_{yx}$ is allowed; $\tau_{xy} \neq \tau_{yx}$ would violate static equilibrium because the sum of moments of force would not equal zero. In contrast, two independent normal stresses σ_x and σ_y are allowed and there is no restriction on their relative magnitudes or signs.

Principal stresses and maximum shear stress

It can be shown that the coordinate system (x, y, z) of Figure 12 can be rotated such that all of the off-diagonal terms (i.e. all the shear stresses τ_{ij}) are zero; these coordinates are called the *principal directions* and the corresponding stresses the *principal stresses*. Now we're down to 3 independent stresses in this coordinate system. Furthermore, in the principal directions two of the three coordinates yield the maximum and minimum stress attainable from any rotation of the coordinates. Proving this or using these results is beyond the scope of this course but will be discussed in AME 204. In this course we will consider only the simpler **two-dimensional** case (**Figure 13**). If the normal stresses σ_x and σ_y and the shear stress τ_{xy} are known in some coordinate system (x, y) then by rotating the coordinate system by an angle θ_P , **the principal stresses (called σ_1 and σ_2)** are obtained; their values are given by

$$\sigma_1 = \frac{\sigma_x + \sigma_y}{2} + \sqrt{\left(\frac{\sigma_x - \sigma_y}{2}\right)^2 + \tau_{xy}^2}; \sigma_2 = \frac{\sigma_x + \sigma_y}{2} - \sqrt{\left(\frac{\sigma_x - \sigma_y}{2}\right)^2 + \tau_{xy}^2}; \theta_P = \frac{1}{2} \tan^{-1} \left(\frac{2\tau_{xy}}{\sigma_x - \sigma_y} \right) \quad \text{Equation 26}$$

Stated in terms of the Cauchy stress tensor, the stresses are

$$\sigma = \begin{bmatrix} \sigma_1 & 0 \\ 0 & \sigma_2 \end{bmatrix} \quad (\text{in the coordinate system of the principal stresses}) \quad \text{Equation 27}$$

where σ_1 and σ_2 are given in the equation above.

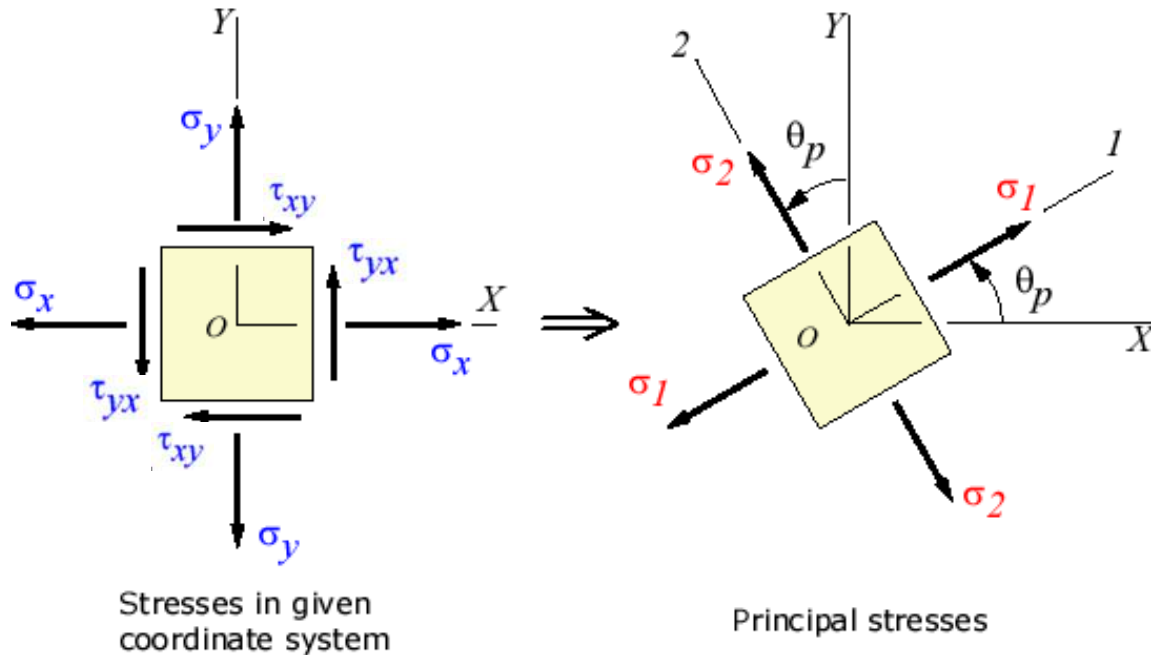

Figure 13. Diagram of normal (σ) and shear (τ) stresses in a 2-dimensional system and transformation to the principal stresses. Source: efunda.com

Note that σ_1 and σ_2 could be both positive, both negative, or one of each depending on the values of σ_x , σ_y and τ_{xy} . If both are positive then the larger one is the only one you need to worry about in terms of material failure, and failure could occur in tension only. If both σ_1 and σ_2 are negative, then the more negative one is the only one you need to worry about in terms of material failure, and failure could occur in compression only. If σ_1 is positive and σ_2 is negative, then you need to worry about both in terms of material failure, the positive one in tension and the negative one in compression.

Also note that there are some good function tests you can perform on the formula for principal stresses:

- If $\tau_{xy} = 0$, then $\sigma_1 = \sigma_x$ and $\sigma_2 = \sigma_y$, that is, the normal stresses are the principal stresses since there is no shear in this coordinate systems.
- If σ_y and τ_{xy} are both zero, that is, if there is only one normal stress and no shear stress, then $\sigma_1 = \sigma_x$ and $\sigma_2 = 0$.
- If $\sigma_x \neq 0$, $\sigma_y = 0$ and $\tau_{xy} \neq 0$, then the principal stresses are

$$\sigma_1 = \frac{\sigma_x}{2} + \sqrt{\left(\frac{\sigma_x}{2}\right)^2 + \tau_{xy}^2} > \sigma_x; \sigma_2 = \frac{\sigma_x}{2} - \sqrt{\left(\frac{\sigma_x}{2}\right)^2 + \tau_{xy}^2} < 0$$

which makes sense because adding the shear increases σ_1 to a value larger than its value if there were no shear (σ_x), and decreases σ_2 to a value smaller than its value if there were no shear (0).

Also, by rotating the coordinate system by a different angle θ_s , the **maximum shear stress (τ_{\max})** is obtained; its value is given by

$$\tau_{\max} = \pm \sqrt{\left(\frac{\sigma_x - \sigma_y}{2}\right)^2 + \tau_{xy}^2} = \pm \frac{\sigma_1 - \sigma_2}{2}; \quad \theta_s = \frac{1}{2} \tan^{-1}\left(\frac{\sigma_x - \sigma_y}{2\tau_{xy}}\right) = \theta_p \pm 45^\circ \quad \text{Equation 28}$$

In this coordinate system where we find the maximum shear stress, the normal stresses are the same and equal to $(\sigma_x + \sigma_y)/2$, i.e., the average of σ_x and σ_y in the original coordinate system. Thus, written in terms of the Cauchy stress tensor again

$$\sigma = \begin{bmatrix} \frac{\sigma_x + \sigma_y}{2} & \tau_{\max} \\ \tau_{\max} & \frac{\sigma_x + \sigma_y}{2} \end{bmatrix} \quad (\text{in the coordinate system of the maximum shear stress}) \quad \text{Equation 29}$$

Note also that if in the above equations the stress in the x direction is non-zero ($\sigma_x \neq 0$) but the stress in the y direction is zero ($\sigma_y = 0$) and the shear in the x-y plane is zero ($\tau_{xy} = 0$), then the principal stresses are $\sigma_1 = \sigma_x$, $\sigma_2 = 0$ and $\tau_{\max} = \sigma_x/2$. This indicates that just because one is only pulling on the material in one direction (say, in tension) that doesn't mean that there is no shear stress in the material; it's all a matter of my choice of coordinates. The important conclusion is that **a material under any type of stress has both normal and shear stresses; to determine the conditions for failure, it is not sufficient just to calculate the stresses in one particular coordinate system.** One must determine the maximum normal and shear stresses in the material based on the above equations for σ_1 , σ_2 and τ_{\max} and choose an appropriate dimensions and materials that can withstand such stresses. There is an analogy of sorts with Alfred Hitchcock movies – typically the main character is an ordinary person doing some ordinary task, then something happens to him/her that causes him/her to become involved in some terrifying event from which he/she cannot become uninvolved. The message of his movies is typically, “you think you're not involved... but you ARE.” The same thing applies to stresses: “you calculate normal stress and you think you're not involved with shear stress... but you ARE.” Note that according to Eq. 26, the **only** situation where the material has no shear stress at all ($\tau_{\max} = 0$) is when $\sigma_x = \sigma_y$ and $\tau_{xy} = 0$.

Yet another noteworthy aspect of the above equations for the maximum normal stresses (σ_1 and σ_2) and the maximum shear stress (τ_{\max}) is that for pure shear with no normal stress in the original coordinate system ($\sigma_x = \sigma_y = 0$ and $\tau_{xy} \neq 0$), the principal stresses are $\sigma_1 = \tau_{xy}$ and $\sigma_2 = -\tau_{xy}$. In this case, “you think you're not involved with normal stress ... but you ARE” applies and in fact the maximum normal stresses in this case are equal in magnitude to the shear stress in the original coordinate system.

Table 3 summarizes these special cases and others for maximum normal and shear stresses for different ratios of normal and shear stress in the original coordinate system. In **Table 3**, “1” unit of stress could be 1 N/m², 1 lbf/in², 1000 Pa, or any unit of stress – it's all based on ratios.

In original (x,y) coordinate system			In coordinate system of the principal stresses (maximum and minimum normal stress)			In coordinate system of maximum shear stress		von Mises stress
σ_x	σ_y	τ_{xy}	σ_1	σ_2	θ_p	τ_{max}	θ_s	σ_{VM}
1	0	0	1	0	0	± 0.5	45°	1
1	1	0	1	1	0	0	n/a	1
1	-1	0	1	-1	0	± 1	45°	$\sqrt{3}$
1	0	± 1	$(1+\sqrt{5})/2$	$(1-\sqrt{5})/2$	31.7°	$\pm\sqrt{5}/2$	76.7°	2
0	0	± 1	1	-1	45°	± 1	0	$\sqrt{3}$
1	-1	$\pm 4/3$	5/3	-5/3	53.1°	$\pm 5/3$	8.1°	5/ $\sqrt{3}$

Table 3. Principal stresses and maximum shear stress for some special cases of ratios of stress in the (x,y) plane.

Finally, we need to consider the combined effects of normal and shear stress on the condition for yielding or failure, that is, if (for example) the stress in the material were very close to but below the yield stress in both tension and shear, the material might be more likely to fail than if the stress in the material were very close to but below the yield stress only in tension and well below the yield stress in shear. There are many models of the effects of these combined stresses on the conditions for material failure; certainly we will not try to cover them here. Probably the most common model is based the *von Mises stress* (σ_{VM}) which states that combination of the normal stresses σ_x and σ_y plus the shear stress τ_{xy} has the equivalent effect of tension in the amount of σ_{VM} as given by (for a 2D system)

$$\sigma_{VM} = \sqrt{\sigma_x^2 + \sigma_y^2 - \sigma_x \sigma_y + 3\tau_{xy}^2} = \sigma_{yield,tension} \quad \text{Equation 30.}$$

According to this model, failure will occur when σ_{VM} exceeds the yield stress in pure tension $\sigma_{yield,tension}$. In this case we do not separately consider yield stresses in compression and shear, which is handy if we haven't actually measured the yield stress in compression and shear. Note the function test: when $\sigma_x > 0$, $\sigma_y = 0$, and $\tau_{xy} = 0$ (that is, the only applied stress is tension in the x-direction) then $\sigma_{VM} = \sigma_x = \sigma_{yield,tension}$ which is our usual yield criterion for failure in tension.

Summarizing the possible failure criteria (in any given problem, I will tell you which ones to check; we won't discuss which is the best in any given situation):

- Tension: $\sigma_x > \sigma_{yield,tension}$ Or $\sigma_y > \sigma_{yield,tension}$
- Compression: $\sigma_x < \sigma_{yield,compression}$ Or $\sigma_y < \sigma_{yield,compression}$ (recall compressive stress is negative)
- Shear: $|\tau_{xy}| > \tau_{yield,shear}$
- Von Mises: $\sigma_{VM} > \sigma_{yield,tension}$

In the remainder of this chapter we will apply these concepts of stress, strain, etc. to several specific engineering structures, namely pressure vessels, beams and columns.

Example

A horizontal steel clevis pin 0.5 inch in diameter in an anchor shackle has a 5,000 lbf anchor hung on it. The bolt is tightened until the tension is 7,000 lbf.

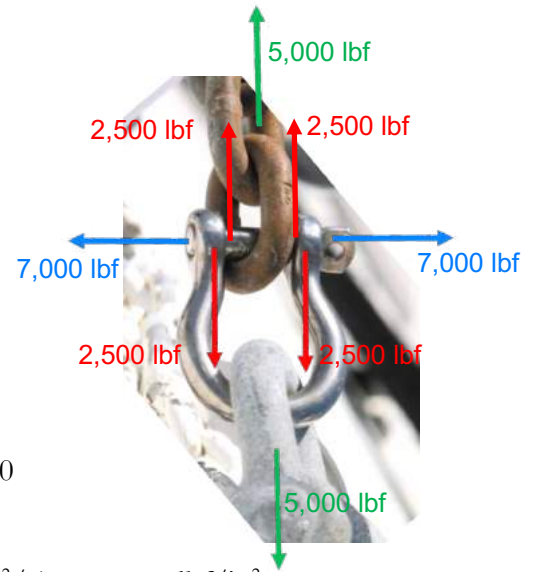

- (a) What is the maximum normal stress in the bolt?

$$\text{Normal stress along length of bolt} = \sigma_x = \text{Force/Area} \\ = (7,000 \text{ lbf}) / (\pi(0.5 \text{ in})^2 / 4) = 35,651 \text{ lbf/in}^2$$

$$\text{Normal stress perpendicular to the length of bolt} = \sigma_y = 0$$

$$\text{Shear stress on each of the two ends of the bolt} \\ = \tau_{xy} = (\text{Shear force}) / \text{Area} = (2,500 \text{ lbf}) / (\pi(0.5 \text{ in})^2 / 4) = 12,732 \text{ lbf/in}^2$$

Using Equation (26) for principal stresses we find that σ_1 and σ_2 are

$$\sigma_1 = \frac{\sigma_x + 0}{2} + \sqrt{\left(\frac{\sigma_x - 0}{2}\right)^2 + \tau_{xy}^2} = \frac{35,651}{2} + \sqrt{\left(\frac{35,651}{2}\right)^2 + (12,732)^2} = 39,731 \frac{\text{lbf}}{\text{in}^2}$$

$$\sigma_2 = \frac{\sigma_x + 0}{2} - \sqrt{\left(\frac{\sigma_x - 0}{2}\right)^2 + \tau_{xy}^2} = \frac{35,651}{2} - \sqrt{\left(\frac{35,651}{2}\right)^2 + (12,732)^2} = -4,080 \frac{\text{lbf}}{\text{in}^2}$$

So the maximum normal stress is 39,731 lbf/in² (+ sign indicating tension) and the maximum compressive stress is -4,080 lbf/in², (- sign indicating compression). Also note that the transformation from the coordinate system x, y to the principal directions requires an angle of rotation given by

$$\theta_p = \frac{1}{2} \tan^{-1} \left(\frac{2(\pm 12,732)}{35,651 - 0} \right) = \pm 35.5^\circ$$

- (b) What is the maximum shear stress in the bolt?

$$\tau_{\max} = \pm \sqrt{\left(\frac{35,651 - 0}{2}\right)^2 + 12,732^2} = \pm 21,906 \frac{\text{lbf}}{\text{in}^2}$$

- (c) What is von Mises stress in the bolt?

$$\sigma_{VM} = \sqrt{(35,651)^2 + 0^2 - (35,651)(0) + 3(12,732)^2} = 41,920 \frac{\text{lbf}}{\text{in}^2}$$

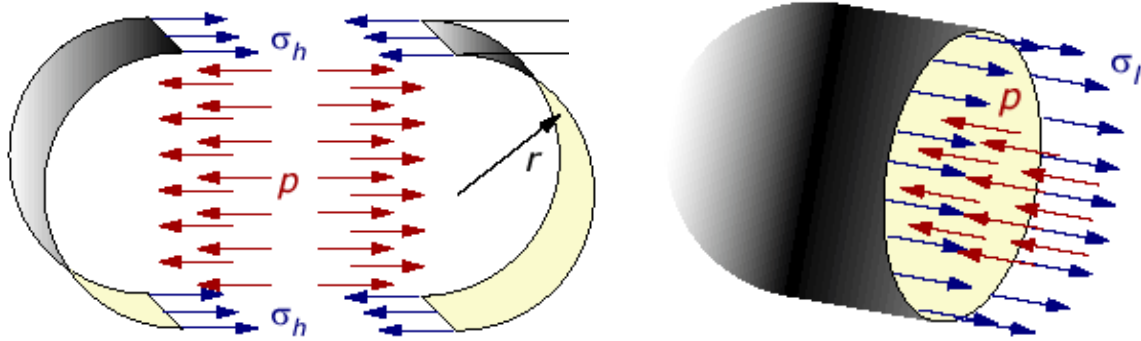

Figure 14. Diagrams of pressure vessel showing hoop stress (σ_h , left) and longitudinal stress (σ_l , right). Figures from <http://www.efunda.com/>.

Pressure vessels

In a cylindrical vessel containing an internal pressure P_{in} with a pressure outside P_{out} , there are 2 stresses to be considered: the *hoop stress* trying to pull the cylinder apart radially, and the *longitudinal stress* or *axial stress* trying to pull it apart axially. Referring to Figure 14, note that the total force trying to pull the cylinder apart radially is $(P_{in}-P_{out})A$, where the area $A = 2rL$, where r is the cylinder radius and L its length. The total wall cross section area resisting this force is $2\tau L$, where τ is the wall thickness (not to be confused with τ the shear stress used above; wall thickness has units of length, shear stress has units of pressure). Thus,

$$\begin{aligned} \text{Hoop stress } (\sigma_h) &= (\text{total force})/(\text{area of wall resisting force}) \\ &= ((P_{in}-P_{out}) * 2rL) / (2\tau L) = (P_{in}-P_{out})r/\tau \end{aligned} \quad \text{Equation 31}$$

Similarly for the longitudinal stress, the total force trying to pull the cylinder apart axially is $(P_{in}-P_{out})A = (P_{in}-P_{out})(\pi r^2)$ and the total wall cross section area resisting this force is $2\pi * r * \tau$, thus

$$\begin{aligned} \text{Longitudinal stress } (\sigma_l) &= (\text{total force})/(\text{area of wall resisting force}) \\ &= (P_{in}-P_{out})(\pi r^2)/(2\pi r\tau) = (P_{in}-P_{out})r/2\tau \end{aligned} \quad \text{Equation 32}$$

or stated in terms of the Cauchy stress tensor, defining the x-direction to be along the axis of the cylinder:

$$\sigma = \begin{bmatrix} \frac{(P_{in} - P_{out})r}{2\tau} & 0 \\ 0 & \frac{(P_{in} - P_{out})r}{\tau} \end{bmatrix}$$

Note that the hoop stress is twice the longitudinal stress. This is why an overcooked hot dog usually cracks along the longitudinal direction first (*i.e.*, its skin fails from hoop stress, generated by internal

steam pressure). Also note that if the pressure inside the vessel is higher than that outside the vessel ($P_{in} > P_{out}$), both hoop and longitudinal stress are positive, *i.e.*, in tension. Of course, if the pressure outside is higher ($P_{in} < P_{out}$, *e.g.*, a vacuum chamber or submarine) then both hoop and longitudinal stress will be negative, *i.e.*, in compression.

Also note that for a sphere, any cross-section of the material experiences longitudinal stress (Figure 14, right) and no cross section experiences hoop stress (Figure 14, left). Thus, the maximum stress in a spherical vessel is half of that a cylindrical vessel with the same pressure, radius and wall thickness, *i.e.* $(P_{in}-P_{out})r/2\tau$ (sphere) vs. $(P_{in}-P_{out})r/\tau$ (cylinder). For a given material, the wall thickness τ required to hold a given pressure difference ($P_{in}-P_{out}$) is thus half as much for the sphere as the cylinder. Of course the volume of a sphere of diameter $2r$ is less (by 33.3%) than a cylinder with equal diameter $2r$ and length $2r$, but the weight of the pressure vessel is 50% less, so a spherical vessel is preferred in applications where weight is critical, *e.g.*, in spacecraft.

So for the pressure vessel we have hoop stress (call it σ_x , where x is the radial direction) = $(P_{in}-P_{out})r/\tau$ and longitudinal stress (call it σ_y , where y is the axial direction) = $(P_{in}-P_{out})r/2\tau$. In this coordinate system there is no shear stress. Thus, the principal stresses are

$$\begin{aligned}\sigma_1, \sigma_2 &= \frac{\sigma_x + \sigma_y}{2} \pm \sqrt{\left(\frac{\sigma_x - \sigma_y}{2}\right)^2 + \tau_{xy}^2} \\ &= \frac{(P_{in} - P_{out})r/\tau + (P_{in} - P_{out})r/2\tau}{2} \pm \sqrt{\left(\frac{(P_{in} - P_{out})r/\tau - (P_{in} - P_{out})r/2\tau}{2}\right)^2 + 0^2} \\ &= \frac{(P_{in} - P_{out})r}{\tau}, \frac{(P_{in} - P_{out})r}{2\tau}\end{aligned}$$

Equation 33

So for this case the principal stresses σ_1 and σ_2 are just the calculated stresses in the x and y directions; as discussed earlier will happen any time $\tau_{xy} = 0$. On the other hand, the maximum shear stress for the pressure vessel is

$$\tau_{max} = \pm \sqrt{\left(\frac{\sigma_x - \sigma_y}{2}\right)^2 + \tau_{xy}^2} = \pm \sqrt{\left(\frac{(P_{in} - P_{out})r/\tau - (P_{in} - P_{out})r/2\tau}{2}\right)^2 + 0^2} = \pm \frac{(P_{in} - P_{out})r}{4\tau}$$

Equation 34

Thus, unless the yield stress in shear was less than $1/4$ the yield stress in tension or compression, the material would fail in tension or compression before it failed in shear.

Example (to be continued below...)

An iron pipe 1 foot in diameter and 50 feet long has a wall thickness of 1/2 inch. The material properties are: elastic modulus (E) = 30×10^6 lbf/in², yield stress (σ_{yield}) = 30×10^3 lbf/in² in tension, yield stress = -30×10^4 lbf/in² in compression and yield stress = 10×10^3 lbf/in² in shear. If the ends of the iron pipe are sealed and the pipe is used as a cylindrical pressure vessel, with the high pressure inside:

- (a) At what pressure difference (in units of lbf/in²) will the iron yield if the high pressure is inside the pipe and yield occurs in tension?

$$\text{Maximum normal stress} = \text{hoop stress } (\sigma_h) = +(P_{\text{in}} - P_{\text{out}})r / \tau \text{ (tension)}$$

$$\text{Pressure difference } (P_{\text{in}} - P_{\text{out}}) \text{ at yield} = \sigma_{\text{yield}} \tau / r = (+30 \times 10^3 \text{ lbf/in}^2)(0.5 \text{ in}) / (6 \text{ in}) \\ = +2,500 \text{ lbf/in}^2$$

- (b) For what yield stress in shear (in units of lbf/in²) will the iron yield in shear rather than in tension for this pressure?

$$\tau_{\text{max}} = \pm \frac{(P_{\text{in}} - P_{\text{out}})r}{4\tau} \Rightarrow \tau_{\text{yield}} = \pm \frac{(P_{\text{in}} - P_{\text{out}})r}{4\tau} = \pm \frac{(+2500 \text{ lbf/in}^2 - P_{\text{out}})(6 \text{ in})}{4(0.5 \text{ in})} = \pm 7500 \text{ lbf/in}^2$$

Since the actual yield stress in shear is 10,000 lbf/in², the pipe will not yield in shear at this pressure difference and thus it will yield in tension instead as calculated in part (a).

Bending of beams

One of the most common problems in structural mechanics is to compute the stresses in a *beam* subject to a load, perpendicular to the axis of the beam, distributed over the length of the beam. The load is typically reported as a force per unit length along the beam (w), with units N/m or (more likely) lbf/ft. As shown in Figure 15 (left), this load causes a shear force in the beam (V) = wL , where L is the distance from the end of the beam. Or, if w is not constant, we can say that $dV = w dx$ and $V = \int_0^L w dx$. Then the moment of force about one end of the beam is given by

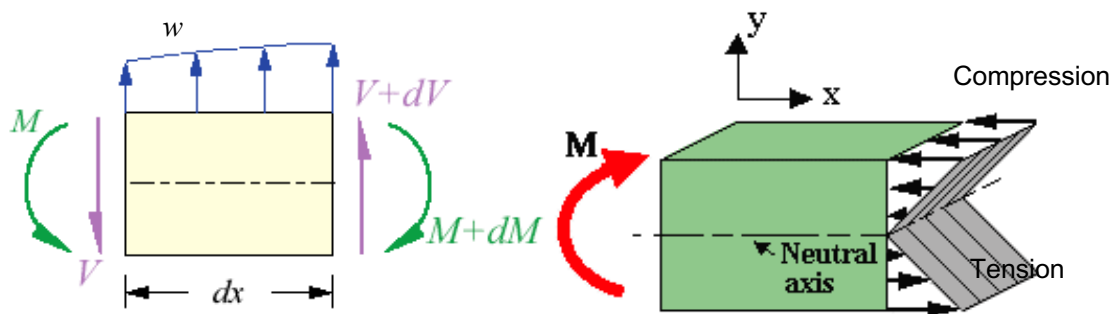

Figure 15. Left: Force balance on a differential element of beam of length dx , showing the applied load per unit length w , shear force V and bending moment M . From <http://www.efunda.com/>. Right: Schematic of compressive and tensile stresses in a beam caused by the bending moment. From http://strengthandstiffness.com/6_beams/page_6b.htm

(defining moments of force positive in the counterclockwise direction, which is standard in structural mechanics):

$$dM = -Vdx, \text{ thus}$$

$$\frac{dM}{dx} = -V; \frac{dV}{dx} = w \Rightarrow \frac{d^2M}{dx^2} = -w \quad \text{Equation 35}$$

Knowing $w(x)$ for the beam and the boundary conditions at the ends of the beam, one can determine the moment of force M at any location along the beam. For example, with a constant load w per unit length and which is pinned at one end (able to withstand a force in both x and y directions, but unable to cause a moment of force) and has a roller at the other end (so able to withstand a force in the y direction only, so there are 3 unknown forces and 3 degrees of freedom, i.e. a statically determinate system) we have

$$d^2M/dx^2 = -w = \text{constant}$$

with the boundary conditions

$$M = 0 \text{ at } x = 0 \text{ and } x = L$$

for which the solution is

$$dM/dx = -wx + c_1;$$

$$M = -wx^2/2 + c_1x + c_2;$$

$$M = 0 \text{ at } x = 0 \Rightarrow c_2 = 0;$$

$$M = 0 \text{ at } x = L \Rightarrow -wL^2/2 + c_1(L) + 0 = 0 \Rightarrow c_1 = wL/2$$

$$\Rightarrow M(x) = (wx/2)(L - x) \quad (\text{uniformly loaded beam}) \quad \text{Equation 36a}$$

Note that the maximum of M is at $x = L/2$ with a value of $wL^2/8$ (see Figure 16).

The above relation applies to a *uniform loading* w (units force/length) along the whole beam, with pinned ends. For a *point force* P (units force, not force/length) at the midpoint ($x = L/2$) between the two ends of the beam, the above equations can be integrated to obtain

$$\Rightarrow M(x) = Px/2 \text{ (for } x \leq L/2); M(x) = P(L-x)/2 \text{ (for } x \geq L/2) \quad \text{Equation 36b}$$

(beam with point load in the middle, pinned ends)

Note that for this case maximum of M is at $x = L/2$ with a value of $PL/4$ (see Figure 16). How does this compare with uniform loading? Note that for uniform loading, $M_{\max} = wL^2/8 = (wL)(L/8)$ where (wL) is the total force exerted by the loading on the beam, which is $1/2$ as much as the moment $P(L/4)$ when the same total force is concentrated at the midpoint of the beam rather than distributed along its length. As we will show shortly show, the stress in the material is proportional to the bending moment. As a consequence, for a given maximum allowable stress, a uniformly-loaded beam can handle twice as much total weight as a point-loaded beam, everything else about the beam being equal. *Function test:* note that far from the point load (i.e. away from $x/L = 0.5$, near $x/L = 0$ or $x/L = 1$), the bending moment is the same for uniform or point load. This

makes sense because for the same total load $P = wL$, far from the location of the point load one would expect the resulting bending moments to be the same for the two types of loading.

Who cares about these moments? Well, what we do care about is the stress in the beam. The beam must resist this moment by the stresses in the material. In order to do that, the beam has to be (for downward loading, i.e. weight on the beam) in tension on the bottom and compression on top. In other words

Forces (loads) on beam \Rightarrow Shear forces in beam \Rightarrow Bending moments in beam \Rightarrow Stresses in beam material

It's important to understand that the bending moments cause far more stress in the beam than the stresses caused by the direct application of the force $w(x)$. It's beyond the scope of this course to derive the relationship between bending moment $M(x)$ and stresses (you'll learn about this in AME 204), but for a slender beam (one for which its length L is much larger than its height in the y direction, that is, $L \gg b$ for a rectangular beam or $L \gg d$ for a beam of circular cross-section) by far the largest stress in the beam is the normal stress in the x direction (σ_x) resulting from this bending moment and this stress given by

$$\sigma_x(x, y) = -\frac{M(x)y}{I} \quad \text{Equation 37}$$

where y is the vertical distance from the "neutral axis" of the beam (where $\sigma_x = 0$) (the "neutral axis" is half-way through the beam for a symmetrical cross-section), $M(x)$ is the moment just computed, and I is the *area moment of inertia* of the beam cross-section (units are length⁴) defined by

$$I \equiv \int_{y_{\min}}^{y_{\max}} y^2 z(y) dy \quad \text{Equation 38}$$

which is illustrated in Figure 17. In comparison to $\sigma_x(x, y)$ given by this equation, the normal stress in the y direction (σ_y) and the shear stress τ_{xy} in the (x, y) coordinate system are much smaller and so

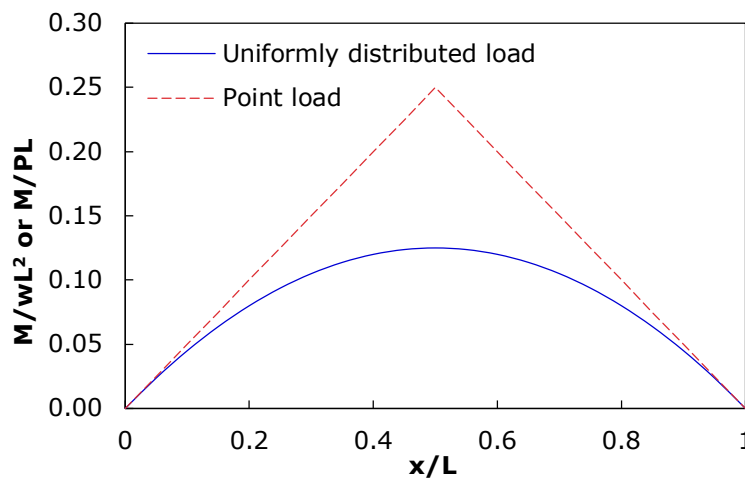

Figure 16. Distribution of bending moments along a beam for uniform or point loading

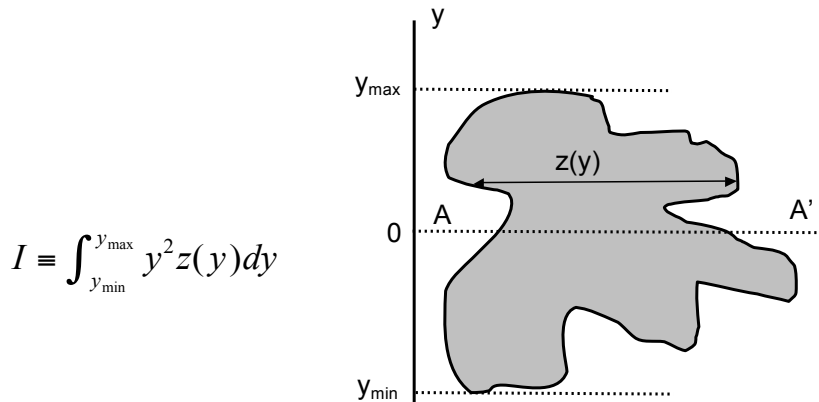

Figure 17. Definition of area moment of inertia (I) about axis (dotted line) A-A'

can be neglected. (Of course we still have to find the maximum shear stress τ_{\max} obtained by rotating the coordinate system, as discussed below.)

Note that for a given total cross-section area (thus total weight of beam) one can have large I (thus lower stress σ) by having more material at larger distances from the axis A-A'. This is the reason for using I-shaped beam sections. Formulas for I for common shapes include:

- Circular cross-section of diameter d: $I = \pi d^4/64$
- Thin-wall hollow tube of diameter d and wall thickness τ : $I = \pi d^3 \tau/8$
- Rectangular cross-section $I = ab^3/12$ (a = width of beam; b = height of beam)
- I beam of width a, height b, thickness of central section τ_w and thickness of top and bottom sections τ_h :

$$I = \frac{ab^3}{12} - \frac{(a - \tau_w)(b - 2\tau_h)^3}{12}$$

Note that the I-beam formula satisfies the function tests: when $\tau_w = a$ or $\tau_h = b/2$, the I-beam is just a “filled” rectangle with $I = ab^3/12$, and if $\tau_w = 0$ and $\tau_h = 0$, the beam has no material thus $I = 0$.

The above equation for the stress in the beam $\sigma_x(x,y) = -M(x)y/I$ can be used to calculate the normal stress in the x-direction $\sigma_x(x,y)$ at any location along the length of the beam (in the x direction) and any vertical position in the beam (in the y direction), but we are almost exclusively interested in the maximum value of σ_x , which will occur at $x = L/2$ (if the beam is subject to a uniform load w or a point-load P at the middle of the beam, i.e. for the only 2 cases we are considering) and at the maximum value of y (i.e. at $y = \pm d/2$ for a circular cross-section or $y = \pm b/2$ for a rectangular or I-beam of height b.) So let's use $\sigma_x(x,y) = -M(x)y/I$ for the simple case of a **uniformly-loaded or point-loaded rectangular cross-section beam** (Figure 18) of height b and thickness a and determine the maximum normal stress in the beam. For this case, the moment of inertia $I = ab^3/12$, thus σ_{\max} (at the center of the beam ($x = L/2$), at the top or bottom, where $y = +b/2$ at the top of the beam and $-b/2$ at the bottom of the beam) is given by

$$\sigma_{\max} = -\frac{M_{\max} y_{\max}}{I} = -\frac{(wL^2/8)(\pm b/2)}{ab^3/12} = \mp 0.75 \frac{wL^2}{ab^2} \quad (\text{uniform load})$$

$$\sigma_{\max} = -\frac{M_{\max} y_{\max}}{I} = -\frac{(PL/4)(\pm b/2)}{ab^3/12} = \mp 1.5 \frac{PL}{ab^2} \quad (\text{point load})$$

Equation 39

where the $-$ sign refers to the compression at the top of the beam and the $+$ sign refers to the tension at the bottom of the beam (recall that the sign convention for stresses is that compression is negative and tension is positive.) Does this result make sense?

- Smoke test: The units (for uniform load) are $wL^2/ab^2 = (\text{Force}/\text{Length})(\text{Length})^2/(\text{Length}^3) = \text{Force}/\text{Length}^2$, which is stress – OK.
- Function test #1: a longer (larger L) or more heavily loaded (larger w or P) beam should have more stress - OK
- Function test #2: a thicker (larger a) or taller (larger b) should have less stress – OK

Note that shown in Table 3, for a situation in which there is normal stress σ_x in only one direction ($\sigma_y = 0$) and no shear stress in that x-y coordinate system ($\tau_{xy} = 0$), there is still a shear stress $\tau_{\max} = \sigma_x/2$. So the beam would fail in shear if the yield stress in shear were less than half of the smaller of the yield stress in tension or compression.

Also note that for a given total load (in units of force) = wL (uniform load) or P (point load) and beam length L , the stress is proportional to $1/ab^2$, whereas the weight is proportional to volume = abL . Thus to minimize the stress for a given weight of beam, one wants to minimize the ratio $(abL/ab^2) = L/b$, meaning that (since L is already fixed) we want to maximize b (and thus minimize a) – in other words, a tall skinny beam cross-section (large b , small a) works better than a short fat one (small b , large a). That's another reason for using the I-beam shape. Another way of thinking of this is that since σ_{\max} is proportional to $1/ab^2$, one gets more benefit from increasing b than increasing a . Increasing a results in a proportional decrease in stress and a proportional increase in weight, so the stress-to-weight ratio doesn't change. However, increasing b resulting in a more-than-proportional ($1/b^2$) decrease in stress, thus the stress-to-weight ratio increases.

By examination of Figure 18, one might notice that there is a compressive stress acting on the beam in the y direction by virtue of the loading. In Figure 18, this “direct” compressive stress would be $\text{Force}/\text{Area} = wL/aL = w/a$. Is this a lot or a little? By comparison the compressive or tensile stress in the x direction caused by the bending moment is $0.75wL^2/ab^2$. The ratio of the bending-induced to direct compression is then $(0.75wL^2/ab^2)/(w/a) = 0.75(L/b)^2$. Since we have already assumed $L \gg b$ (a long, slender beam), the bending-induced compression far exceeds the “direct” compression. Similarly, for the shear force V caused by the “direct” loading, from $dV/dx = -w$, thus $V = -wx = -wL/2$ at the center of the beam. This results in a shear stress = force/area = $-(wL/2)/ab$. The ratio of the shear stress caused by the bending moment = $\sigma_x/2 = (0.75wL^2/ab^2) = 0.375wL^2/ab^2$ to that caused by the “direct” loading is then $0.75(L/b)$. So again, since $L \gg b$, the stress caused by the bending moment is much more than that due to direct loading, which explains why we can usually ignore the direct loading when determining the point at which a beam will fail.

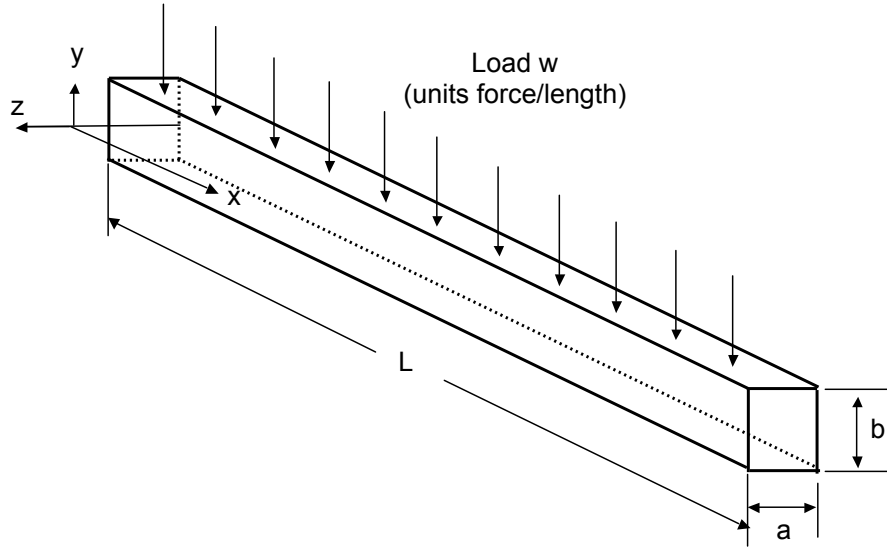

Figure 18. Schematic of example beam-loading problem

Another property of some interest is the maximum deflection Δ (i.e. the sag in the middle of the beam) due to the applied load. Its value is given by

$$\Delta = \frac{5wL^4}{384EI} \text{ (uniform load)} \quad \Delta = \frac{PL^3}{48EI} \text{ (point load)} \quad \text{Equation 40}$$

Note that for the same total applied load ($wL = P$), the maximum deflection is $(1/48)/(5/384) = 1.6$ times larger for the point load than the uniform load.

Another common stress analysis problem is a circular disk (e.g., the end caps of a cylindrical pressure vessel) of radius r and thickness τ with pressure difference $P_{in} - P_{out}$. The maximum stress (including the transformation to principal stresses) is given by

$$\sigma_{max} = \pm c \frac{(P_{in} - P_{out})r^2}{\tau^2} \quad \text{Equation 41}$$

where $c = 1.24$ if the edges of the disk are free to pivot (e.g. like a drum head, which is not very realistic) or $c = 0.696$ if the edges are rigidly clamped and unable to pivot (which would be the case if the disk were welded or bolted on to the end of the cylindrical part of the pressure vessel.) Since this normal stress exists and has the same magnitude in both the x and y directions within the plane of the end cap ($\sigma_x = \sigma_y$) according to Eq. 25, $\tau_{max} = 0$, i.e. there is no shear stress in the end caps.

Example

- (a) If the iron pipe from the pressure vessel example above has no pressure inside but instead is used as a beam with one pinned end and one roller end instead, what is the maximum point load (P, units of force, not to be confused with pressure P) that could be applied at the middle of the beam before the iron yields?

$$\sigma_{\max} = -\frac{M_{\max} y_{\max}}{I} = -\frac{(PL/4)(-d/2)}{\pi d^3 \tau / 8} = +\frac{PL}{\pi d^2 \tau}$$

$$P = +\frac{\pi d^2 \tau \sigma_{\text{yield}}}{L} = +\frac{\pi (12 \text{ in})^2 (0.5 \text{ in}) (30 \times 10^3 \text{ lbf/in}^2)}{50 \text{ ft} \frac{12 \text{ in}}{\text{ft}}} = +11,310 \text{ lbf}$$

(Note: the material is weaker in tension, so the failure will occur when $\sigma_y = +30 \times 10^3 \text{ lbf/in}^2$ in tension at the bottom of the beam ($y = -d/2$) rather than $\sigma_y = -30 \times 10^4 \text{ lbf/in}^2$ in compression at the top of the beam ($y = +d/2$)).

However, we need to check for failure due to shear stress also. At the top or bottom of the beam, for a given value of the normal stress in the x direction (along the length of the beam) of σ_x , assuming no normal stress in the y direction ($\sigma_y = 0$) and no shear stress ($\tau_{xy} = 0$), there is a shear stress given as (Eq. 33):

$$\tau_{\max} = \pm \sqrt{\left(\frac{\sigma_x - \sigma_y}{2}\right)^2 + \tau_{xy}^2} = \pm \sqrt{\left(\frac{\sigma_x - 0}{2}\right)^2 + 0^2} = \pm \frac{\sigma_x}{2}$$

As discussed below Equation 26 and shown in Table 3, in this particular case of $\sigma_x \neq 0$, $\sigma_y = 0$, $\tau_{xy} = 0$, the maximum shear stress is half as much as the normal stress σ_x . Thus

$$\tau_{\text{yield}} = -\frac{1}{2} \frac{M_{\max} y_{\max}}{I} = -\frac{1}{2} \frac{(PL/4)(-d/2)}{\pi d^3 \tau / 8} = \frac{PL}{2\pi d^2 \tau}$$

$$P = \frac{2\pi d^2 \tau (\tau_{\text{yield}})}{L} = \frac{2\pi (12 \text{ in})^2 (0.5 \text{ in}) (10 \times 10^3 \text{ lbf/in}^2)}{50 \text{ ft} \frac{12 \text{ in}}{\text{ft}}} = 7,540 \text{ lbf}$$

So the beam yields at a lower point load P in shear than in tension (7,540 lbf vs. 11,310 lbf.)

- (b) What is the maximum deflection of the beam?

$$\Delta = \frac{PL^3}{48EI} = \frac{(7,356 \text{ lbf}) [(50 \text{ ft})(12 \text{ in/ft})]^3}{48(30 \times 10^6 \text{ lbf/in}^2) [\pi (12 \text{ in})^3 (0.5 \text{ in})/8]} = 3.33 \text{ in}$$

Notice that the 50 foot long beam deflects/bends a maximum (i.e. at the failure load) of 3.33 inches, i.e. only $3.33 / (50 \times 12) = 0.0056 = 0.56\%$.

- (c) Assuming that shear stress is not an issue (as it was shown to be at the end of part (a)), how much compressive force (pre-stressing) should be applied to the pipe to maximize the point load that could be applied? What would this maximum point load be?

At the maximum load condition there is $\sigma_x = -30 \times 10^3 \text{ lbf/in}^2$ (compression) at the top of the beam and $\sigma_x = +30 \times 10^3 \text{ lbf/in}^2$ (tension) at the bottom of the beam. This is sort of a waste, since the top of the beam could take a lot more compressive stress before it failed. So by pre-compressing the beam, one could even things out. So to have both the top and bottom of the beam at their maximum stress, we would have a stress of $-30 \times 10^4 = PC - S$ at the top of the beam (- sign indicating compression, PC is the pre-compression, S is the stress due to the applied load – on top, + on the bottom) and $+30 \times 10^3 = PC + S$ at the bottom of the beam. So combining this two equations, we have

$$\begin{aligned} -30 \times 10^4 &= PC - S \\ 30 \times 10^3 &= PC + S \\ \Rightarrow -27 \times 10^4 &= 2 PC \Rightarrow PC = -13.5 \times 10^4; S = 16.5 \times 10^4 \end{aligned}$$

We already showed that without pre-compressing, a point load of 11,300 lbf produces a stress of $\pm 30 \times 10^3 \text{ lbf/in}^2$ in the beam. With pre-compressing, we can withstand $\pm 16.5 \times 10^4$ of stress in the beam due to the loading, that is, 5.5 times more stress. Since the relationship between the applied load P and the stress is linear, we can conclude that $P = 5.5 (11,300) = 62,200 \text{ lbf}$.

- (d) If the pipe has welded disk end caps of the same material and thickness as the pipe, at what pressure P (again this is pressure P, not to be confused with point load P) would the end cap fail?

$$\sigma_{max} = \pm c \frac{(P_{in} - P_{out}) r^2}{\tau^2} \Rightarrow P = \pm \frac{\sigma_{max} \tau^2}{c r^2} = \frac{(+30 \times 10^3 \text{ lbf/in}^2)(0.5 \text{ in})^2}{0.696(6 \text{ in})^2} = \pm 299 \text{ lbf/in}^2$$

where again the tensile (not compressive) stress is chosen because is it the smaller value.

Buckling of columns

Another way in which a structural element under compression can fail is by *buckling*. This is not strictly a failure of the material, but effectively eliminates the load-carrying capability of the structure. The compressive force (F) at which buckling occurs in a column of length L is given by

$$F_{buckling} = n\pi^2 EI/L^2 \qquad \text{Equation 42}$$

where E is the elastic modulus discussed above, I is the moment of inertia **of the cross-section of the column in the plane perpendicular to the direction of the applied force** (which is parallel

to the long direction of the column) and n is a constant that depends on the way in which the column ends are or are not held:

- Both ends pinned, *i.e.*, free to pivot: $n = 1$
- Both ends clamped, *i.e.*, unable to pivot: $n = 4$
- One end pinned, one end clamped: $n = 2$

It should be noted that this buckling formula is valid **only** for a “slender” column (where the length L is much greater than the width of the column cross section) and it assumes that the column cross-section does not change (in other words, it would not account for the crumpling of an aluminum beverage can, where the buckling occurs due to a change in the cross-section of the can.

When computing I for a rectangular cross-section of a buckling column, which is the “ a ” dimension and which is the “ b ” dimension? Since the column can buckle either way, you have to use the lesser I , *i.e.* where a is the smaller dimension, which says that to avoid buckling, you don’t want tall skinny beam cross-sections, you want round or square ones. Note that this conflicts with the desired cross-section to minimize stress due to bending moments, *i.e.* it was just mentioned above that for best stress to weight ratio, you want tall skinny I-beams. Thus the optimal I-beam cross-section will be a compromise between the two shapes.

Example

What is the buckling load of a polyethylene plastic drinking straw ($E \approx 10^9$ Pa), 1/4” in diameter and 1/32” wall thickness, 6” long, with both ends free to pivot?

$$F_{\text{buckling}} = n\pi^2 EI/L^2;$$

$$n = 1;$$

$$E \approx 10^9 \text{ Pa};$$

$$I = \pi d^3 \tau / 8 = \pi (0.25)^3 (1/32) / 8 = 1.92 \times 10^{-4} \text{ in}^4 = 7.99 \times 10^{-11} \text{ m}^4$$

$$L = 6 \text{ in} = 0.152 \text{ m}$$

$$F_{\text{buckling}} = 1\pi^2 (10^9 \text{ Pa}) (7.99 \times 10^{-11} \text{ m}^4) / (0.152 \text{ m})^2 = 34 \text{ N} = 7.7 \text{ lbf.}$$

In practice the buckling load would be less because this analysis assumes the load is exactly along the axis of the column, whereas in reality there would be some sideways (shear) load. Additionally, the analysis assumes that the cross-section of the column does not change, whereas in practice the drinking straw would fold (sort of like buckling in the x -direction), thus violating the constant-cross-section assumption.

Chapter 6. Fluid mechanics

“The goal in life is to be solid, whereas the way that life works is totally fluid, so you can never actually achieve that goal.”- Damien Hirst (British artist).

Main course in AME curriculum on this topic: AME 309 (Dynamics of Fluids).

What distinguishes a fluid from a solid is that a solid deforms only a finite amount due to an applied shear stress (unless it breaks), whereas the fluid continues to deform as long as the shear stress is applied. This makes fluid mechanics a lot more complicated (at least to me) than solid mechanics.

Note that in scientific circles, the term “fluid” can mean either a gas or a liquid whereas colloquially “fluid” is generally interpreted as meaning a liquid. We will use the term “fluid” to apply to either a gas or liquid and state specifically “gas” or “liquid” for concepts or equations that apply only to one of the two.

Fluid mechanics is basically $\Sigma \mathbf{F} = d(m\mathbf{v}/dt)$ (Newton’s 2nd Law, the sum of the forces is equal to the rate of change of momentum) applied to a fluid. Generally this is done on a per unit volume (V) basis, so Newton’s 2nd Law becomes $\Sigma(\mathbf{F}/V) = d(\rho\mathbf{v}/dt)$, where $\rho = m/V$ is the fluid density.

By far the two most common assumptions made about fluid density is that the fluid is either

- (1) *incompressible*, meaning that ρ is constant; this is a good assumption for most liquids because their density does not change much over a large range of pressures.
- (2) an *ideal gas*, that is, a substance for which $PV = n\mathfrak{R}T$. This formula based on the number of moles n isn’t very useful for engineering purposes compared to a mass-based formula because (a) it’s **far** easier to measure mass than moles and (b) moles aren’t conserved during chemical reactions whereas mass is. The alternative version of the ideal gas law which is much more commonly used in engineering is obtained by computing the mass (m) from $m = n\mathcal{M}$, where \mathcal{M} is the molecular mass, then applying the definition of density $\rho \equiv m/V$ and combining to obtain

$$P = \rho RT \quad (\text{ideal gas } \underline{\text{ONLY}}) \quad \text{Equation 43}$$

where $R \equiv \mathfrak{R}/\mathcal{M}$ is the mass-based gas constant (which is different for every gas depending on its value of \mathcal{M} whereas \mathfrak{R} is the same for every gas).

Fluid statics

Hydrostatic pressure

Let’s look first at fluid *statics*, i.e. when $\Sigma \mathbf{F} = 0$. If a fluid is not moving at all, as in a glass of water, then the fluid is *static*, that is, zero velocity everywhere, and has only a *hydrostatic pressure*. Imagine a

column of fluid of height z , cross-section area A and density ρ_f (units M/L^3 , i.e. mass of fluid per unit volume.) Table 4 gives the density of several common liquids and gases. The weight of the water is the mass $\times g = \text{density} \times \text{volume} \times g = \rho_f z A g$. This weight is distributed over an area A , so the force per unit area (the hydrostatic pressure) is $\rho_f z A g / A = \rho_f g z$. This is added to whatever pressure $P(0)$ exists at $z = 0$. So the hydrostatic pressure $P(z)$ is

$$P(z) = P(0) - \rho_f g z \quad \text{Equation 44}$$

where z is defined as positive upward, i.e. decreasing depth. This result assumes that the fluid density ρ_f is constant. This is reasonable for water and practically all liquids, even at pressures of thousands of atm. It's also ok for gases if z is not too large, i.e., such that $\rho_f g z \ll P_0$.

Fluid	Density (ρ , kg/m ³)	Dynamic viscosity (μ , kg/m s)	Kinematic viscosity ($\nu = \mu/\rho$, m ² /s)
Water	997.1	8.94×10^{-4}	8.97×10^{-7}
Air	1.18	1.77×10^{-5}	1.50×10^{-5}
Motor oil	917	0.260	2.84×10^{-4}
Mercury	13500	1.53×10^{-3}	1.13×10^{-7}

Table 4. Properties of some common fluids at ambient temperature and pressure.

Buoyancy

According to Archimedes' principle, an object of volume V placed in a liquid of density ρ will exert a buoyant force equal the weight of the fluid displaced $= \rho_f g V$. The net force on the object is the difference between this Archimedean (buoyant) force and the weight of the object $= \rho_o g V$, where ρ_o is the average density of the object (just total mass/total volume). Thus the *net* force F acting on the object is

$$F = (\rho_f - \rho_o) g V \quad \text{Equation 45,}$$

where the sign convention is such that the force is positive (directed upward) when the object density is less than the fluid density (i.e., the object floats upward). *Function test:* if the density of the object and the fluid are the same, the object is "neutrally buoyant," and there is no net force on the object ($F = 0$).

Example

- The deepest part of the ocean is a spot called "Challenger Deep" in the Marianas Trench in the western Pacific Ocean. The depth is 35,838 feet. The density of seawater is 1026 kg/m^3 . What is the hydrostatic pressure (in atmospheres) at this depth? Remember, at sea level, the pressure is 1 atm and increases as the depth increases.

Ocean depth: $z = -35838 \text{ ft} = -10923 \text{ m}$; seawater density $\rho_f = 1026 \text{ kg/m}^3$

$$P = P(0) - \rho_f g z = 1 \text{ atm} - (1026 \text{ kg} / \text{m}^3) (9.81 \text{ m} / \text{s}^2) (-10923 \text{ m}) \frac{1 \text{ atm}}{101325 \text{ N} / \text{m}^2} = 1086 \text{ atm}$$

- b) The density of air at sea level is $1.18 \text{ kg} / \text{m}^3$. If the air density were constant (not, as in reality, a function of elevation), at what elevation would the pressure be zero?

$$P = P(0) - \rho_{air} g z = 0 \Rightarrow P(0) = \rho_{air} g z \quad \text{thus } z = -\frac{P(0)}{\rho_{air} g}$$

$$= -\frac{101325 \text{ N} / \text{m}^2}{1.18 \text{ kg} / \text{m}^3 \times 9.81 \text{ m} / \text{s}^2} = 8753 \text{ m}$$

- c) Until 2012, the only vessel ever to carry people to Challenger Deep was the bathyscaphe *Trieste* (pictured below) in 1960. It used gasoline ($\rho_f = 739 \text{ kg} / \text{m}^3$) for flotation since no air tank could be made light enough to sustain an 1100 atm pressure difference and still provide positive buoyancy (since the gasoline is essentially incompressible it could be contained in a thin-walled tank that did not need to sustain a pressure difference between the gasoline and the surrounding seawater; note that the gasoline is used only for buoyancy, not as fuel.) The *Trieste* used 22,500 gallons of gasoline for flotation. How much buoyant force could this much gasoline produce?

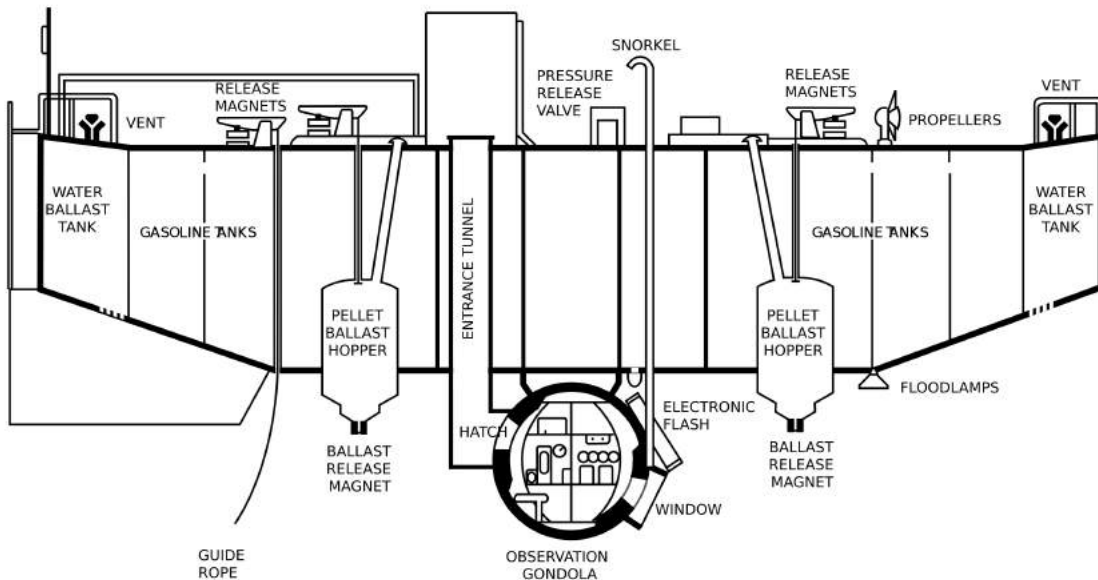

GENERAL ARRANGEMENT DRAWING OF TRIESTE, CA. 1959

In this case the surrounding fluid is seawater and the “object” is the gasoline itself, thus

$$F = (\rho_f - \rho_o)gV = \left(\frac{1026 \text{ kg}}{m^3} - \frac{739 \text{ kg}}{m^3} \right) \frac{9.81m}{s^2} \left(22,500 \text{ gal} \frac{ft^3}{7.46 \text{ gal}} \left(\frac{m}{3.281 \text{ ft}} \right)^3 \right)$$

$$F = 2.404 \times 10^5 \frac{\text{kg m}}{s^2} = 2.404 \times 10^5 N \frac{1 \text{ lbf}}{4.448 N} = 5.41 \times 10^4 \text{ lbf} = 27.0 \text{ tons}$$

Equations of fluid motion

Bernoulli's equation

One of the most common problems in fluid flows is to determine the relationship between velocity, pressure and elevation of a flowing fluid in a pipe or other duct. To do this, we enforce *conservation of energy* on the fluid, i.e. the energy contained by the fluid at one point in the flow is the same as any other, but the energy may be transformed from one form to another. Moreover, it is more convenient to work with *power* (rate of change of energy) rather than energy itself. If the flow is steady so that no energy is accumulating or dissipating within the pipe then the power (sum of all forms) must be constant. This course in general is not intended to provide derivations of formulas you will study in much greater detail in later courses, but it is worthwhile to do so for Bernoulli's equation just as an example of the value and power of units, and the concept of conservation (e.g., of energy) applied to a fixed volume called a *control volume* (the other common method of analysis is to apply conservation of energy to fixed mass called a *control mass*; we will discuss both in detail in the next chapter).

There are 3 types of power that must be considered, and their sum conserved. In words, the conservation of energy can be stated as:

$$\begin{aligned} & \text{(Power needed to push fluid into the tube inlet - power extracted at the tube outlet)} \\ & + \text{(kinetic power of the fluid flowing into tube - kinetic power of the fluid flowing out of tube)} \\ & + \text{(power associated with change of gravitational potential energy of fluid)} \\ & = 0 \end{aligned}$$

Let's compute the individual terms then add them up.

1. Power needed to push fluid into the tube inlet or power extracted at the tube outlet:

$$\begin{aligned} \text{Power} &= \text{force} \times \text{velocity} = \left(\frac{\text{force}}{\text{area}} \right) (\text{velocity} \times \text{area}) \\ &= \text{pressure} \left(\frac{\text{volume}}{\text{time}} \right) = \text{pressure} \frac{\text{mass/time}}{\text{mass/volume}} = \frac{P\dot{m}}{\rho} \end{aligned} \tag{Equation 46}$$

where \dot{m} is the mass flow rate (units kg/sec), discussed in more detail in the next sub-section. (Here we're dropping the subscript "f" in ρ_f because we're only dealing with one material, namely the fluid, and not an object flowing or sinking in the fluid as well.)

2. Kinetic power of the fluid:

$$\text{Power} = \frac{d}{dt} \left(\frac{1}{2} mv^2 \right) = \frac{1}{2} \frac{dm}{dt} v^2 = \frac{1}{2} \dot{m} v^2 \quad (\text{Equation 47})$$

3. Power associated with gravitational potential energy of fluid

$$\text{Power} = \frac{d}{dt} (mgz) = \frac{dm}{dt} gz = \dot{m}gz \quad (\text{Equation 48})$$

Combine: sum of the powers at inlet (call it station 1) = sum of powers at outlet (call it station 2). Assume mass flow rates are equal at inlet and outlet (if they're not, the flow can't be steady because mass will be accumulating or being lost from the pipe)

$$\frac{P_1 \dot{m}_1}{\rho_1} + \frac{1}{2} \dot{m}_1 v_1^2 + \dot{m}_1 g z_1 = \frac{P_2 \dot{m}_2}{\rho_2} + \frac{1}{2} \dot{m}_2 v_2^2 + \dot{m}_2 g z_2 \quad \text{or}$$

$$P_1 + \frac{1}{2} \rho v_1^2 + \rho g z_1 = P_2 + \frac{1}{2} \rho v_2^2 + \rho g z_2 \quad (\text{Equation 49})$$

This is *Bernoulli's equation*, which is merely a statement of conservation of energy flow with four critical assumptions:

1. **Incompressible** ($\rho = \text{constant}$)
2. **Inviscid** (no viscosity), otherwise additional work (and thus additional pressure drop $P_1 - P_2$) would be required to push the fluid between locations 1 and 2
3. **Steady flow between locations 1 and 2**, otherwise some unsteady terms (d/dt) would exist
4. **Uniform velocity, pressure and elevation across the inlet and outlet**, otherwise there would not be a single value of v_1 , P_1 or z_1 , etc.

Function test: it was shown that for a static fluid ($v_1 = v_2 = 0$), $P(z) = P(0) - \rho g z$, or $P(z) + \rho g z = P(0)$, which is the same as Bernoulli's equation for $z_2 = 0$.

Recall that the term $\rho v^2/2$ is called the *dynamic pressure*, *i.e.*, the increase in pressure that would occur if the fluid were decelerated (at constant z) from velocity v to a velocity of zero.

If there are more than one inlets or outlets, we still have to conserve energy, thus the sum of the Bernoulli terms must be the same at the inlet and outlet. For example, if there are two inlets (say 1a and 1b) and two outlets (say 2a and 2b) then

$$\left(P_{1a} + \frac{1}{2} \rho v_{1a}^2 + \rho g z_{1a} \right) + \left(P_{1b} + \frac{1}{2} \rho v_{1b}^2 + \rho g z_{1b} \right) = \left(P_{2a} + \frac{1}{2} \rho v_{2a}^2 + \rho g z_{2a} \right) + \left(P_{2b} + \frac{1}{2} \rho v_{2b}^2 + \rho g z_{2b} \right)$$

Note that Bernoulli's equation assumes that the density (ρ) is constant. At first glance this might suggest that it cannot be used for air or other gases, which are compressible. Actually, Bernoulli's equation can be used for gases if the Mach number (ratio of velocity to sound speed) is significantly

less than 1. This applies to most of our common flow situations, *e.g.*, for all practical purposes the air flowing over a car can be considered to have constant density, as discussed later.

The assumptions of constant density, steady flow, and constant properties at the inlet and outlet are reasonable in many circumstances. In my mind, the most significant limitation of Bernoulli's equation is that **friction losses (viscosity)** are not considered. Can we just add another term to Bernoulli's equation to account for viscosity? No, because viscosity is dissipative and causes a loss in the total power (sum of the three terms). Where does the power go? Into thermal energy of the fluid (*i.e.* it gets warmer.) Moreover, the amount of power lost is *path dependent*, *i.e.* a longer or narrower tube will have more loss, whereas the above three terms don't depend on the length or diameter of the tube. Of course, viscosity can be incorporated into fluid flow analysis, but it's much more difficult and can't be done with a simple equation like Bernoulli's that depends only on the initial and final states (1 and 2 in our notation) and not at all on the path between states 1 and 2.

Conservation of mass

How does one determine the velocity v ? For steady flow in a pipe, channel or duct, the mass flow rate \dot{m} (in kg/s) has to be the same everywhere in the flow system. This mass flow rate is the product of the fluid density (ρ), velocity (v) and the cross-section area (A) of the pipe or duct through which the fluid flows, *i.e.*,

$$\begin{aligned}\dot{m} &= \frac{dm}{dt} = \frac{d(\rho V)}{dt} = \rho \frac{dV}{dt} = \rho \frac{d(Ax)}{dt} = \rho \frac{dx}{dt} A = \rho v A \\ \Rightarrow \dot{m} &= \rho_1 v_1 A_1 = \rho_2 v_2 A_2\end{aligned}\quad \text{Equation 50.}$$

Where again V is the volume of fluid and x is the position of the fluid. In the case of Bernoulli's equation, we have already assumed that the density is constant, so for this case (*i.e.*, liquids, as well as gases at low Mach number) we can simplify this to

$$v_1 A_1 = v_2 A_2$$

note that vA has units of (length/time)(length)² = length³/time = volume/time, *i.e.* the *volumetric flow rate*, usually given the symbol Q . Thus, for steady flow of an incompressible fluid $Q_1 = Q_2$. If there are more than 1 inlets or outlets then the sum of the mass flows at the inlets must equal those at the outlets, *i.e.*

$$\rho_{1a} v_{1a} A_{1a} + \rho_{1b} v_{1b} A_{1b} = \rho_{2a} v_{2a} A_{2a} + \rho_{2b} v_{2b} A_{2b}$$

or for incompressible flow ($\rho = \text{constant}$)

$$v_{1a} A_{1a} + v_{1b} A_{1b} = v_{2a} A_{2a} + v_{2b} A_{2b} \quad \text{or} \quad Q_{1a} + Q_{1b} = Q_{2a} + Q_{2b}$$

We can combine conservation of mass (Equation 50) with conservation of energy (Bernoulli, Equation 49), to determine the state of the fluid at an outlet (location "2") given its properties at an inlet (location "1") as shown in the example below.

Example

Water flows steadily from a faucet at elevation $z = 0$ with supply pressure (P_1) of 30 lbf/in² = 207,000 Pa (above atmospheric), area 5 cm², to the roof of a house with $z = 5$ m and through a nozzle with area 1 cm², into ambient air with a pressure (P_2) of 0 lbf/in² above atmospheric. What is the velocity of the water leaving the nozzle? Assume that viscous effects are negligible.

Neither v_1 nor v_2 are known, but P_1 , P_2 , z_1 and z_2 are all known, so we have 2 equations (Bernoulli and mass conservation) for the two unknowns.

First apply mass conservation: $v_1 = v_2 A_2 / A_1 = v_2 (1 \text{ cm}^2) / (5 \text{ cm}^2) = 0.2 v_2$.

Then use Bernoulli and solve for v_2 :

$$\begin{aligned} \frac{1}{2} \rho (v_2^2 - v_1^2) &= (P_1 - P_2) + \rho g (z_1 - z_2) \Rightarrow [v_2^2 - (0.2v_2)^2] = 2 \left[\frac{P_1 - P_2}{\rho} + g (z_1 - z_2) \right] \\ \Rightarrow v_2 &= \sqrt{\frac{2}{1 - (0.2)^2} \left[\frac{P_1 - P_2}{\rho} + g (z_1 - z_2) \right]} = \sqrt{2.083 \left[\frac{2.07 \times 10^5 \text{ N/m}^2}{1000 \text{ kg/m}^3} + \left(9.81 \frac{\text{m}}{\text{s}^2} \right) (0 - 5 \text{ m}) \right]} \\ \Rightarrow v_2 &= 18.1 \frac{\text{m}}{\text{s}} \end{aligned}$$

Note also that velocity at the supply faucet $v_1 = 0.2 v_2 = (0.2)(18.1 \text{ m/s}) = 3.63 \text{ m/s}$.

Viscous effects

Definition of viscosity

Bernoulli's equation pertains only when there is no viscosity (i.e. the flow is *inviscid*). Fluids resist motion, or more specifically resist a velocity *gradient*, through viscosity (μ), defined by the relation (called Newton's Law of Viscosity)

$$\tau_{xz} = \mu \frac{\partial v_x}{\partial y} \quad \text{Equation 51}$$

where τ_{xz} is the shear stress in the x-z plane, v_x is the component of velocity in the x direction, and $\partial v_x / \partial y$ is the x-velocity *gradient* in the y direction.

Side note: in the above equation, we have used *partial derivative* of v_x with respect to y ($\partial v_x / \partial y$) not the total derivative of v_x with respect to y (dv_x / dy). A partial derivative (which is denoted by a curly “ ∂ ” compared to the straight “ d ” of a total derivative) is a derivative of a function of two or more variables, treating all but one of the variables as constants. For example if $f(x, y, z) = x^2 y^3 - z^4$, then $\partial f / \partial x = 2xy^3$, $\partial f / \partial y = 3x^2 y^2$ and $\partial f / \partial z = -4z^3$. In this case we it means that the shear stress in the x-

z plane due to viscous effects depends only on how v_x changes in the y direction, not how v_x changes in the x or z direction.

This type of viscosity (μ) is called the *dynamic viscosity*. Since τ_{xz} has units of force/area = $(ML/T^2)/L^2$, v_x has units of L/T and y has units of L, the viscosity μ has units of M/LT, for example kg/m s. This unit has no particular name, but $1 \text{ g/cm s} = 0.1 \text{ kg/m s} = 1 \text{ Poise}$. The unit *centipoise* = 0.01 Poise = 0.001 kg/m s is frequently used because the dynamic viscosity of water at ambient temperature is almost exactly 1 centipoise.

Another type of viscosity is the *kinematic viscosity*, which is just the dynamic viscosity divided by density:

$$\nu = \frac{\mu}{\rho} \quad \text{Equation 52}$$

which has units of $(M/LT)/(M/L^3) = L^2/T$, e.g. m^2/s . (Note that the symbols “v” (Roman letter ‘vee’) for velocity and “ν” (Greek letter ‘nu’) for kinematic viscosity are similar, be careful!) Again, this unit has no particular name but $1 \text{ cm}^2/\text{s} = 10^{-4} \text{ m}^2/\text{s} = 1 \text{ Stoke}$, and again 1 centistoke = 0.01 Stoke, which is very nearly the kinematic viscosity of water at ambient temperature. The units of kinematic viscosity, L^2/T , are the same as that of diffusion coefficients, e.g., the property that describes how fast a drop of ink will spread out in a beaker of water, thus my favorite interpretation of ν is that it is the *momentum diffusivity*. This describes how quickly or slowly the momentum of the fluid is exchanged with the solid object passing through the fluid (or fluid passing through the solid object, as in the case of flow in a pipe.)

No-slip boundary condition

At the boundary between a fluid and a solid object, the velocity of the fluid and the solid must be the same. This is called the *no-slip* condition. This means that any time a solid is moving through a fluid (e.g. an airplane flying through the air) or a fluid is moving through a solid (e.g. flow through a pipe) there will be a velocity *gradient* (i.e. $\partial u/\partial y$ in the above equation) because there is a difference between the fluid velocity far from the boundary and the fluid velocity at the boundary, and this velocity difference occurs over some finite distance. This velocity gradient is the source of the viscous drag – the velocity gradient creates a shear stress on the fluid (see definition of viscosity above) that resists the motion of the fluid. *It should be noted, however, that while the action of viscosity always causes drag, not all drag is due to viscosity.*

Reynolds number

How important is viscosity in a given flow? That depends on the dimensionless quantity called the *Reynolds number* (Re):

$$\text{Re} = \frac{\rho v \lambda}{\mu} = \frac{v \lambda}{\nu} \quad \text{(Equation 53)}$$

where λ is some characteristic length scale of the flow which has to be specified. In the case of a wing, λ is usually chosen to be the length of the wing in the streamwise direction (which is called the

chord of the wing.) For flow in a pipe, λ would be the pipe inside diameter (d); in this case the Reynolds number would be written as Re_d to indicate that the length scale to use is the diameter d . For flow around a cylinder or sphere, λ would be the outer diameter (d) of the cylinder or sphere. Also, the fluid velocity v changes as the fluid approaches the object, so v is chosen to be the value *far away from the object* (usually called the “free-stream velocity.”) For flow inside pipes, v is the average velocity of the fluid, i.e. the volume flow rate (gallons per minute, m^3/sec) divided by the cross-section area of the tube.

The standard catechism of fluid mechanics states that “Reynolds number is the ratio of inertial forces to viscous forces” but this is nonsense. First of all there is no such thing as “inertial forces” in mechanics. Second, $\rho v L$ is not a unit of force, nor is μ . Here’s my interpretation of Re . Re-write Re as

$$Re = \frac{\rho v \lambda}{\mu} = \frac{\rho v^2}{\mu v / \lambda} \sim \frac{\text{Dynamic pressure}}{\text{Shear stress due to viscosity}} \quad \text{or}$$

$$Re = \frac{v \lambda}{\nu} = \frac{\lambda^2 / \nu}{\lambda / v} \sim \frac{\text{Viscous diffusion time scale}}{\text{Flow time scale}}$$

The first interpretation notes that $\rho v^2/2$ is the dynamic pressure noted above in the context of Bernoulli’s equation and the velocity gradient $\partial v / \partial y$ is proportional to v/λ , thus the shear stress $\tau \sim \mu v / \lambda$. The second interpretation (which is my personal favorite) notes that the time scale for any type of diffusion process is λ^2/D where D is the diffusion coefficient for that process (the momentum diffusivity ν in this case), and the time scale for the fluid to move a distance λ is simply λ/v . So the second interpretation states that the Reynolds number is the ratio of the time for the momentum (or lack of momentum, as in a stationary wall with a fluid moving past it) to diffuse across a distance λ to the time for the fluid to move a distance λ .

Why is Reynolds number useful? Besides determining how important viscosity is in a given flow, it allows one to employ *scaling*. For example, suppose you want to determine the drag coefficient C_D (another dimensionless number, to be re-discussed shortly) on a car whose length (L) is 5 meters traveling at 30 m/sec (about 67 mi/hr) and you don’t have a wind tunnel large enough to put a real car in it, but you have a water channel that is big enough for a 1/5 scale ($L = 1$ meter) model of a car. The kinematic viscosity of air at ambient temperature and pressure is about $1.5 \times 10^{-5} m^2/s$ and that of water is about $1.0 \times 10^{-6} m^2/s$. Then by choosing the velocity of water in the water channel to get the same Reynolds number, you can obtain a valid measurement of C_D :

$$Re = \frac{v \lambda}{\nu} = \frac{v_{air} \lambda_{air}}{\nu_{air}} = \frac{v_{water} \lambda_{water}}{\nu_{water}} \Rightarrow \frac{(30 \text{ m/s})(5 \text{ m})}{1.5 \times 10^{-5} m^2/s} = \frac{v_{water} (1 \text{ m})}{1.0 \times 10^{-6} m^2/s} \Rightarrow v_{water} = 10 \text{ m/s}$$

So a 5 meter long model in air moving at 30 m/s will have the same behavior as a 1 meter long model in water moving at 10 m/s. There are other advantages to using water, *e.g.*, the use of fluorescent dye molecules added to the water that make it easier to visualize the flow using a sheet of laser light.

Navier-Stokes equations

As previously stated, fluid mechanics is just Newton's 2nd Law, $\Sigma(\mathbf{F}/V) = d(\rho\mathbf{v}/dt)$, applied to a fluid (where $\rho\mathbf{v}$ is (mass/volume) \times velocity, i.e. the momentum of the fluid per unit volume). Note that the sum of forces $\Sigma\mathbf{F}$, momentum $\rho\mathbf{v}$ and velocity \mathbf{v} are all vectors, hence the **boldface** notation. The set of equations that describe $\Sigma\mathbf{F} = d(\rho\mathbf{v})/dt$ applied to a fluid, including viscosity effects, is called the *Navier-Stokes equations*, shown here in 2 dimensions, for an incompressible fluid ($\rho = \text{constant}$) that follows Newton's law of viscosity ($\tau_{xz} = \mu\partial v/\partial y$ as described above):

$$\begin{aligned} \rho \frac{\partial v_x}{\partial t} + \rho v_x \frac{\partial v_x}{\partial x} + \rho v_y \frac{\partial v_x}{\partial y} &= -\frac{\partial P}{\partial x} + \rho g_x + \mu \left(\frac{\partial^2 v_x}{\partial x^2} + \frac{\partial^2 v_x}{\partial y^2} \right) \quad (\text{x momentum}) \\ \rho \frac{\partial v_y}{\partial t} + \rho v_x \frac{\partial v_y}{\partial x} + \rho v_y \frac{\partial v_y}{\partial y} &= -\frac{\partial P}{\partial y} + \rho g_y + \mu \left(\frac{\partial^2 v_y}{\partial x^2} + \frac{\partial^2 v_y}{\partial y^2} \right) \quad (\text{y momentum}) \\ \frac{\partial v_x}{\partial x} + \frac{\partial v_y}{\partial y} &= 0 \quad (\text{mass conservation}) \end{aligned} \quad (\text{Equation 54})$$

Here v_x and v_y are the components of fluid velocity vector \mathbf{v} in the x and y directions, respectively. Of course, at every point (x, y) in the flow, the velocity components v_x and v_y may be different. The left-hand side of the first two equations is basically the $d(\rho\mathbf{v})/dt = \rho(d\mathbf{v}/dt) + \mathbf{v}(d\rho/dt)$ terms, i.e. the rate of change of momentum of the fluid. In particular, the $\rho(\partial v_x/\partial t)$ terms are just $\rho(d\mathbf{v}/dt) = \text{mass/volume} \times \text{acceleration}$ and the $\rho v(\partial v_x/\partial x)$ terms are just $\mathbf{v}(d\rho/dt)$, i.e. the increase or decrease in momentum within an infinitesimal volume due to an increase or decrease of $m\mathbf{v}$ within the volume. The right-hand side of the first two equations is the forces acting on the fluid due to pressure, gravity, and viscosity. The third equation is required to conserve the mass of fluid, i.e. it basically says that for a fluid of constant density, the rate of volume flow into an infinitesimal volume must equal rate of volume flow out of that volume.

The Navier-Stokes equations are very difficult to solve for all but the simplest situations. Certainly we will not try to do it in this course. For the purposes of this course, the key points to note about the Navier-Stokes equations are:

1. The first two equations are just expressions of conservation of momentum, $\Sigma\mathbf{F} = d(\rho\mathbf{v})/dt$, applied to a fluid
2. The third equation is just conservation of mass applied to a fluid
3. The units of every term in the first two equations is force/volume
4. There are two momentum equations because momentum is a vector and thus there are x and y components; for a three-dimensional system another equation for the z component of momentum would be required
5. There is only one mass conservation equation (the 3rd equation) because mass is a scalar.
6. The terms on the right hand side of the first two equations are just the forces $\Sigma\mathbf{F}$ broken down into their components in the x and y directions
7. The terms on the left hand side of the first two equations are just the rate of change of momentum $d(\rho\mathbf{v})/dt$ broken down into their components in the x and y directions.

8. There are three equations for the three unknowns v_x , v_y and pressure P . (Unlike velocity, P is a scalar so it doesn't have x and y components.)
9. The equations are linear except for the $v_x(\partial v_x/\partial x)$, $v_y(\partial v_x/\partial y)$, $v_x(\partial v_y/\partial x)$ and $v_y(\partial v_y/\partial y)$ terms. This nonlinearity is very significant because
 - a. It makes fluid mechanics difficult – the nonlinear terms are responsible for very complicated phenomena such as flow instabilities, turbulence and shock waves.
 - b. It makes fluid flow fundamentally different than linear systems. For example, if I have one solution to the Navier-Stokes equation, call it $\mathbf{v}_1(x,y)$, $P_1(x,y)$ and a second solution $\mathbf{v}_2(x,y)$, $P_2(x,y)$, it is generally NOT the case that $\mathbf{v}_1(x,y) + \mathbf{v}_2(x,y)$, $P_1(x,y) + P_2(x,y)$ is also a solution. As an example of a linear system, consider traveling waves on a string. A rightward-traveling wave and a leftward-traveling wave can pass through each other without any change in the waves after the passage. However, a rightward-traveling flow structure (say, a spinning vortex) and a leftward-traveling flow structure will interact with each other in such a way that each will be permanently changed by the interaction.

Laminar and turbulent flow

When Re is low, which means that viscous effects are relatively important, the flow will be steady and smooth, which is called “laminar flow.” At higher Re , viscosity effects are not strong enough to suppress the instabilities (due to the nonlinear terms in the Navier-Stokes equations) and the flow becomes *turbulent*. While you have an intuitive feel of what turbulence is, a precise definition of what is or is not turbulent is not a simple matter and we will not attempt to define it rigorously here.

The Reynolds number at the transition from laminar to turbulent flow depends on the type of flow, for example:

- Flow in circular pipes: $Re_d = vd/\nu \approx 2,200$ (v = average velocity of flow in the pipe; d = inside diameter of pipe) (see Figure 19).
- Flow along a flat plate: $Re_L = vL/\nu \approx 500,000$ (v = velocity of flow far from the plate; L = distance from the “leading edge” of the plate.)

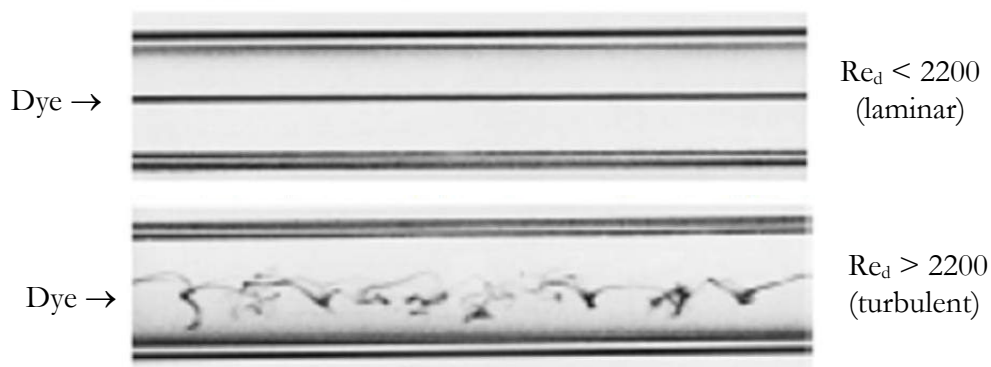

Figure 19. Images of a tracer dye in laminar and turbulent pipe flow. Flow from left to right. (From M. VanDyke, “An Album of Fluid Motion,” Parabolic Press, 1982.)

Since value of Re at the transition from laminar to turbulent flow can be vary widely depending on the type of flow, the actual value of Re is not meaningful in comparing different flows. That is, one cannot say if 10,000 is a large or small value of Re until one also specifies the type of flow; it is a

relatively high value (well into the turbulent regime) for pipe flow, but a low value (well within the laminar regime) for flow along a flat plate.

Lift, drag and fluid resistance

Lift and drag coefficients

Any object moving through a fluid will experience a force (F_D) in the direction opposing the motion. This force is called *drag*. Recall the definition of drag coefficient (page 14):

$$F_D = \frac{1}{2} C_D \rho v^2 A$$

where C_D is the drag coefficient, ρ is the fluid density, v the fluid velocity far from the object and A is the cross-section area of the object in the direction perpendicular to the direction of flow. For example, for a sphere this cross-section area would be πr^2 , where r is the radius of the sphere, and for a cylinder in cross-flow (flow perpendicular to the axis of the cylinder), the area would be $2rL$, where L is the length of the cylinder.

An object moving through a fluid may also experience a force in the direction *perpendicular to the direction of fluid motion*. This force is called *lift* and is defined in a way similar to drag:

$$F_L = \frac{1}{2} C_L \rho v^2 A \quad \text{(Equation 55)}$$

where C_L is the *lift coefficient*. While all objects moving through a fluid experience drag, only some will experience lift. The main goal of aircraft wing design is to maximize the lift to drag ratio, i.e. C_L/C_D . A glider may have a lift to drag ratio of 50, whereas commercial passenger aircraft wings are in the range 15 – 20 (which is about the same as an albatross).

Flow around spheres and cylinders

In the case of **laminar flow** at very low Re_d , and **only in this case**, the drag coefficient C_D on a sphere is equal to $24/Re_d$ (**for laminar flow around spheres at low Re only – got it???**). Combining this result with the definition of drag coefficient and definition of Re , we obtain

$$F_{\text{drag}} = 3\pi\mu v d \quad \text{(laminar flow around spheres)} \quad \text{(Equation 56)}$$

If the sphere is moving due to gravity alone, the buoyant force (F_{buoyant}) is given by $F_{\text{buoyant}} = (\rho_{\text{fluid}} - \rho_{\text{sphere}})gV = (\rho_{\text{fluid}} - \rho_{\text{sphere}})g(4\pi/3)r^3 = (\rho_{\text{fluid}} - \rho_{\text{sphere}})g(\pi/6)d^3$. Note that the buoyant force does not depend on v , but the drag force does. Thus a dropped sphere will initially accelerate until its velocity is just that required for the drag force to equal the buoyant force, at which point there is no acceleration, and the velocity has reached a constant value called the *terminal velocity*. For the case of the sphere, equating F_{drag} and F_{buoyant} we obtain:

$$v_{\text{terminal}} = gd^2(\rho_{\text{fluid}} - \rho_{\text{sphere}})/18\mu \quad \text{(laminar flow around spheres)} \quad \text{(Equation 57)}$$

where the + sign is consistent with the fact that if $\rho_{\text{fluid}} > \rho_{\text{sphere}}$, the sphere moves upward (positive v).

The above terminal velocity is **only valid for laminar flow**. For turbulent flow, there is no simple analytical relationship between Re_d and C_D , so one must resort to experiments or detailed (and difficult) computer simulations of the Navier-Stokes equations. Figure 21 shows a comparison of the actual C_D vs. Re_d with that predicted by the low- Re_d laminar-flow model. It can be seen that the relation for laminar flow is reasonable up to about $Re_d \approx 3$ but at higher Re_d , the flow is NOT laminar and thus the laminar flow result $C_D = 24/Re_d$ does not apply. As one would expect, C_D is higher with turbulent flow. Note also that at $Re_d \approx 3 \times 10^5$ there is a sudden decrease in C_D .

To provide a physical explanation of the drag coefficient plot, note that, apart from the small dip

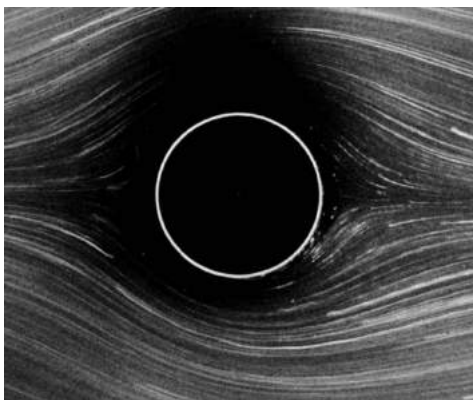

$Re_d = 1.54$ (attached flow)

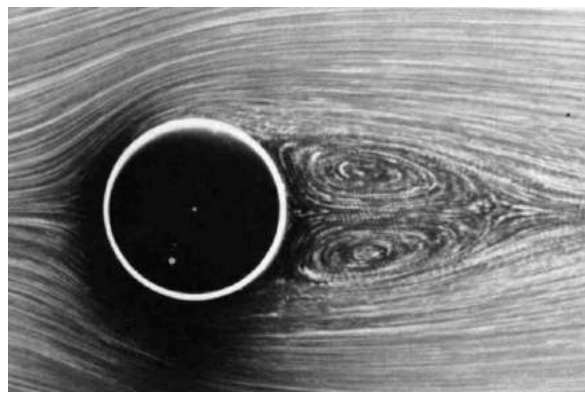

$Re_d = 26$ (separated flow with recirculation zones)



$Re_d = 100$ (vortex shedding flow)

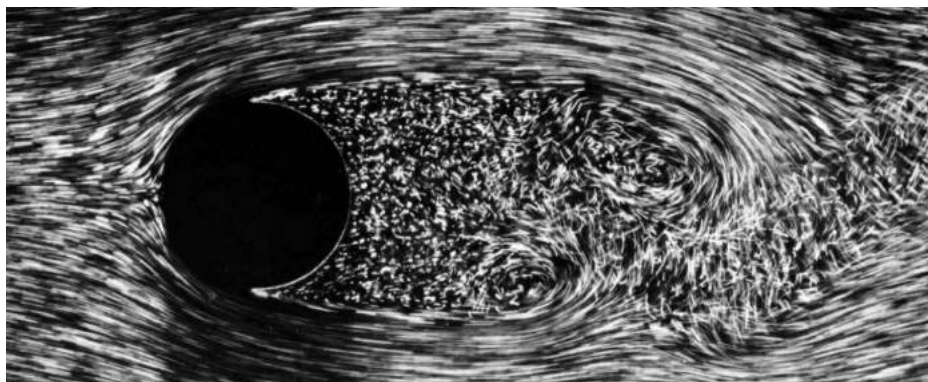

$Re_d = 2000$ (turbulent flow, large separation region)

Figure 20. Flow (from left to right) around cylinders in cross-flow at different Reynolds numbers Re_d . From M. Van Dyke, "Gallery of Fluid Motion," Parabolic Press, 1982.

near $Re_d \approx 3 \times 10^5$, at high Re , C_D is close to 1 and doesn't change much with Re_d . This is because at low Re_d , the fluid flows smoothly around the sphere (Figure 20, top panel) whereas at high Re_d , the high momentum (relative to viscous effects) of fluid causes the flow behind the sphere to *separate* (Figure 20, second panel) which can lead to a (rather beautiful, in some cases) trail of vortices of alternating direction of rotation (Figure 20, third panel) and at sufficiently high Re_d there is a region behind the sphere with $v \approx 0$ (Figure 20, bottom panel). Thus, most of the dynamic pressure ($=\frac{1}{2}\rho v^2$) of the flow is lost, thus according to Bernoulli's equation (which does not strictly apply because the flow is neither steady nor inviscid, but is still useful for estimation purposes) the pressure on the downstream side of the sphere is higher than that on the upstream side by $\frac{1}{2}\rho v^2$. Hence, the net force on the sphere due to this separation-induced drag is $F_D = \frac{1}{2}\rho v^2 A$, and thus the drag coefficient $= F_D/(\frac{1}{2}\rho v^2 A) = (\frac{1}{2}\rho v^2 A)/(\frac{1}{2}\rho v^2 A) = 1$. Thus, for any blunt object at high Re , C_D is usually close to 1 (another example of "that's easy to understand, why didn't somebody just state that?") At low Re_d (less than about 10 for the sphere), the drag is predominantly viscous (not due to the pressure drag caused by flow separation) and thus C_D is higher.

Please note: both axes in Figure 21 are plotted on a logarithmic scale in order to span many decades of Re_d and C_D . The "distance" between numbers A and B on a logarithmic scale is calculated based on $\log_{10}(A) - \log_{10}(B) = \log_{10}(A/B)$, whereas the "distance" between A and B on a linear scale is calculated based simply on $A - B$. So the tick marks between (for example) 1 and 10 are 2, 3, ...9 but they are not evenly spaced because the "distance" (in logarithmic space) between 1 and 2 is $2/1 = 2$ and the "logarithmic distance" is $\log_{10}(2/1) = \log_{10}(2) = 0.301$ (or 30.1% of the distance between 1 and 10) whereas the "logarithmic distance" between 8 and 9 is much less, i.e., $\log_{10}(9/8) = \log_{10}(1.125) = 0.051$ (or 5.1% of the distance between 1 and 10). Another point to note is that a straight line on a plot with logarithmic scales on both axes does not represent a linear relation such as $y = mx + b$, but rather it indicates a power-law relation, i.e. $y = mx^b$. For laminar flow around spheres, the relationship is $C_D = 24/Re_d$, that is $m = 24$ and $b = -1$, thus the slope of the plot for this special case is -1.

A similar C_D vs. Re_d plot for cylinders in cross-flow (i.e. with the flow in the direction perpendicular to the axis of the cylinder) is also shown in **Figure 21**, but for cylinders there is no simple analytical relationship analogous to the $C_D = 24/Re_d$ result for laminar flow over spheres. There is an approximate solution, called the Oseen solution, **for cylinders only, valid only for low Re_d :**

$$C_D = \frac{8\pi}{Re_d [1/2 - \Gamma - \ln(8/Re_d)]}; \Gamma = 0.577216... \quad (\text{Equation 58}).$$

Note again the sudden decrease in C_D at almost the same Re_d as for spheres. Note that a 3 cm golf ball hit at 70 m/s in air has a Reynolds number of $(70 \text{ m/s})(0.03 \text{ m})/(1.5 \times 10^{-5} \text{ m}^2/\text{s}) = 1.4 \times 10^5$. Dimpling the golf ball decreases the transition Re_d somewhat, and thus enables a lower C_D (actually the dimpling also increases the lift due to the backspin on the ball, but that's beyond our scope.)

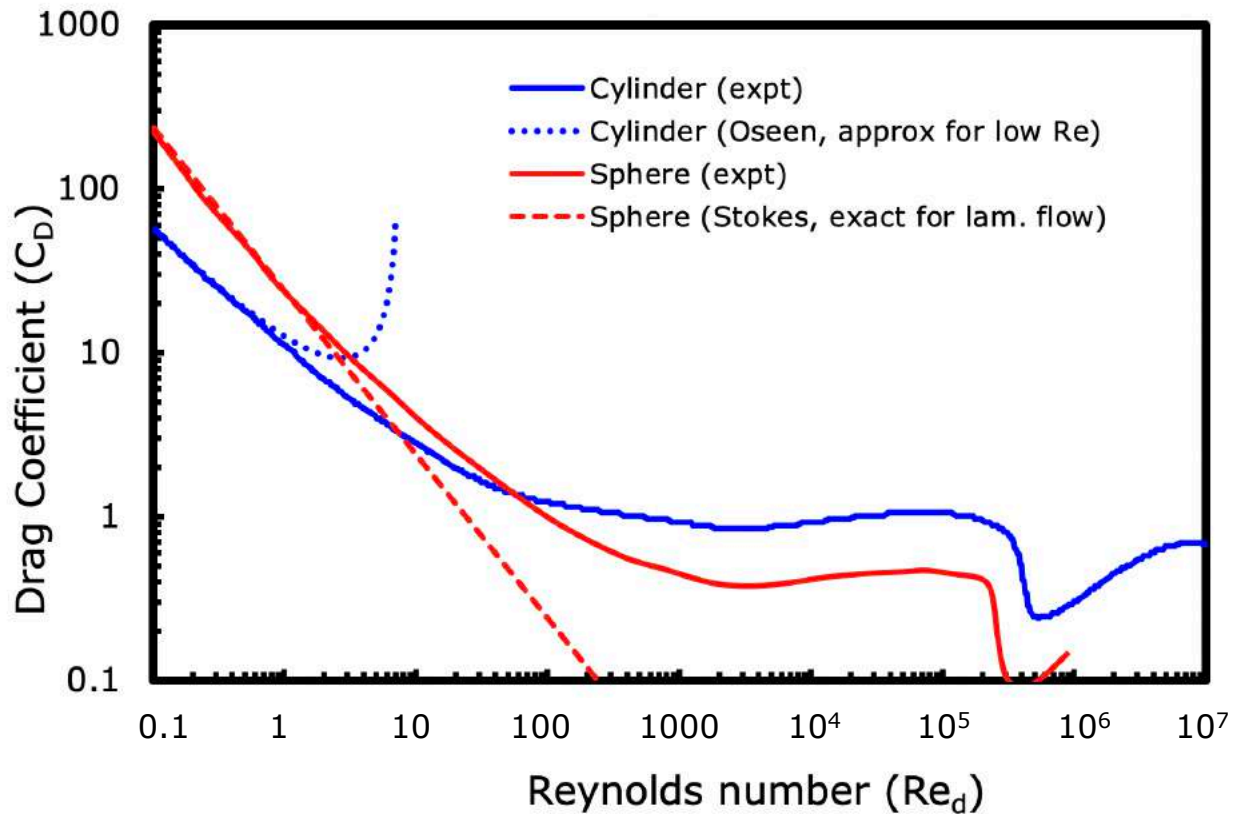

Figure 21. Drag coefficients as a function of Reynolds number based on diameter (Re_d) for cylinders in cross-flow and spheres. The Oseen solution for cylinders is just an approximation, valid only for low Re_d , whereas the Stokes solution for spheres is exact for laminar flow.

Example

- (a) Howard and Samantha go skydiving. Howard weighs 175 lbf with all his gear, and has a cross-sectional area when free falling of 8 ft². If Howard's terminal velocity is 150 miles per hour, what is his drag coefficient?

Drag force

$$F_D = \frac{1}{2} C_D \rho v^2 A \Rightarrow C_D = \frac{2F_D}{\rho v^2 A} = \frac{2(175 \text{ lbf}) \frac{4.448 \text{ N}}{\text{lbf}}}{\frac{1.18 \text{ kg}}{\text{m}^3} \left(\frac{150 \text{ mi}}{\text{hr}} \frac{5280 \text{ ft}}{\text{mi}} \frac{\text{hr}}{3600 \text{ s}} \frac{\text{m}}{3.281 \text{ ft}} \right)^2 (8 \text{ ft}^2) \left(\frac{\text{m}}{3.281 \text{ ft}} \right)^2} = 0.395$$

- (b) Samantha has an unusual skydiving style. She free-falls lying perfectly straight horizontally, and her shape can be treated as roughly that of a cylinder 5 ft long and 2 ft in diameter. She weighs 125 lbf with all her gear. Assuming that her drag coefficient can be modeled as that of a circular cylinder, what is her terminal velocity? To do this problem you will have to

- 1) Guess a terminal velocity
- 2) Compute her Reynolds number

- 3) Look up her drag coefficient in Figure 21.
- 4) Compute her drag force
- 5) Does her drag force equal her weight? If not, adjust your guess of terminal velocity and go back to step 2.

1) “Guess” $v = 113 \text{ mph} = 50.51 \text{ m/s}$

$$2) \text{ Reynolds \# } Re_d = \frac{vd}{\nu} = \frac{(50.51 \text{ m/s})(2 \text{ ft})(\text{m} / 3.281 \text{ ft})}{1.5 \times 10^{-5} \text{ m}^2 / \text{s}} = 2.053 \times 10^6$$

3) From Figure 21, $C_D \approx 0.4$

4) Compute drag force:

$$F_D = \frac{1}{2} C_D \rho v^2 A = \frac{1}{2} (0.4) \left(\frac{1.18 \text{ kg}}{\text{m}^3} \right) \left(\frac{50.51 \text{ m}}{\text{s}} \right) (2 \text{ ft}) (5 \text{ ft}) \left(\frac{\text{m}}{3.281 \text{ ft}} \right)^2 = 559.4 \text{ N} = 125 \text{ lbf}$$

5) Does her drag force equal her weight?

Yes, $125 \text{ lbf} = 125 \text{ lbf}$ so mission accomplished.

Flow through pipes

For flow through pipes, drag coefficient C_D is not used because what we’re really interested in is not the drag force but rather the pressure drop (ΔP), and thus a slightly different quantity called the *friction factor* (f) is used to quantify the effect of viscosity on the flow in the pipe:

$$f \equiv \frac{\Delta P}{\frac{\rho v^2}{2} \frac{L}{d}} \quad (\text{Equation 59}),$$

where v is the average velocity of the fluid flowing through the pipe, ρ the fluid density, L is the length of the pipe and d its diameter. Why do we care about ΔP ? Primarily because we would like to know the power required to pump the fluid through the pipe. How do we determine the power?

$$\text{Power} = \text{force} \times \text{velocity} = \frac{\text{force}}{\text{area}} (\text{velocity} \times \text{area}) = (\Delta P)(Q)$$

where Q is the volume flow rate (units of volume/time, *e.g.*, gallons per minute or m^3/s) is the velocity multiplied by the cross-section area of the pipe, *i.e.* for a circular pipe $Q = v\pi d^2/4$.

For **laminar flow only** in pipes, $f = 64/Re_d$ where $Re_d = \rho v d / \mu$ is the **Reynolds number based on pipe diameter d , not pipe length L** , thus

$$\Delta P = (64/Re_d)(\rho v^2/2)(L/d) = (64\mu/\rho v d)(\rho v^2/2)(L/d) = 32\mu v L/d^2 \quad (\text{Equation 60}).$$

Usually it's more convenient to deal with the volume flow rate (Q) rather than velocity (v). Thus using $Q = v\pi d^2/4$ we can write one last relation:

$$\Delta P = (128/\pi)\mu Q L/d^4 \quad (\text{laminar flow only!}) \quad (\text{Equation 61}).$$

Note the significance of this result: if you double the flow rate Q or the length of the pipe L , the pressure drop doubles (makes sense) whereas for a given flow rate Q and length L , if you double the diameter of the tube, the pressure drop decreases by a factor of 16! So use a bit bigger pipe in your plumbing design!

The results leading to the last 2 equations assumed $f = 64/Re_d$ and thus **are valid only for laminar flow through pipes**. For turbulent flow, the friction factor depends not only on Re_d but also the roughness of the pipe wall, which is characterized by a *roughness factor* $= \epsilon/d$, where ϵ is a measure of the roughness (i.e. height of the bumps on the wall) and d is (as always) the pipe diameter. The roughness ϵ does not significantly affect the friction factor f for laminar flow. The combined effects of roughness and Re_d are presented in terms of the *Moody Chart* (Figure 22). Note that laminar flow prevails up to $Re_d = 2,200$ (this value is essentially independent of the pipe roughness factor), then for higher Re_d , C_D increases suddenly but in a way that depends on the pipe roughness – as one would expect, rougher pipes have higher C_D . It's remarkable (to me, anyway) that at high Re_d a tiny amount of roughness has a huge effect on f . For example, at $Re_d = 10^8$, f increases by a factor of 3 if the roughness factor ϵ/d increases from zero (a perfectly smooth pipe) to 0.001 (that is, a roughness ϵ of 1/1000 of the diameter d). Size does matter!

Another remarkable fact about the Moody Chart is that at sufficiently high Re_d , the friction factor f does not depend on Re_d at all (i.e., for a given roughness factor ϵ/d , the plot of f vs. Re_d becomes horizontal). Since the pressure drop ΔP does not depend explicitly on viscosity μ , only implicitly through $Re_d = \rho v d/\mu$, this means that at sufficiently high Re_d , the pressure drop does not depend on viscosity at all, only the roughness factor! This indicates that, for example, in large oil pipelines with high Re_d an additive that would decrease the oil viscosity would have no effect on the pressure drop (thus pumping costs) – only making the pipe smoother would help.

Alternatively, if you don't like using the Moody Chart, the following empirical formula for turbulent flow can be used (for laminar flow, use $f = 64/Re_d$ as mentioned above):

$$\frac{1}{\sqrt{f}} = -2 \log \left(\frac{\epsilon/d}{3.7} + \frac{2.51}{Re_d \sqrt{f}} \right) \quad (\text{turbulent flow}) \quad (\text{Equation 62})$$

but note that this formula has f on both sides of the equation, and you can't simplify it any further, so for a given Re_d and ϵ/d , you have to guess a value of f and see if the right and left hand sides of the equations are equal, and adjust your guess of f until the two sides are equal (this is called a *transcendental equation*, one that cannot be solved in closed form).

Example: A 50 foot long garden hose has an inside diameter of 5/8” and a roughness (ϵ) of 1/32”. Water flows through the pipe at a velocity of 3 ft/s.

a) What is the flow rate in gallons per minute?

$$\begin{aligned} \text{Flow rate} &= \text{velocity} \times \text{cross-sectional area} \\ &= 3 \text{ ft/sec} \times (\pi/4) (0.625 \text{ inch})^2 \times (\text{ft} / 12 \text{ inch})^2 \times (7.48 \text{ gallon} / \text{ft}^3) \times (60 \text{ sec} / \text{min}) \\ &= 2.87 \text{ gallon} / \text{min} \end{aligned}$$

b) What is the pressure drop in lbf/in²?

$$\begin{aligned} Re_d &= vd/\nu \\ &= [(3 \text{ ft/sec})(\text{m}/3.281 \text{ ft})] [(0.625 \text{ inch})(\text{ft}/12 \text{ inch})(\text{m}/3.281 \text{ ft})] / 1.0 \times 10^{-6} \text{ m}^2/\text{sec} \\ &= 14,515 > 2200 \Rightarrow \text{turbulent} \end{aligned}$$

$$\epsilon/d = (1/32)/(5/8) = (1/32)/(20/32) = 1/20 = 0.05$$

Use $\frac{1}{\sqrt{f}} = -2 \log \left(\frac{\epsilon/d}{3.7} + \frac{2.51}{Re_d \sqrt{f}} \right)$ and “guess” $f = 0.0731$:

$$\frac{1}{\sqrt{f}} = \frac{1}{\sqrt{0.0731}} = 3.699; -2 \log \left(\frac{\epsilon/d}{3.7} + \frac{2.51}{Re_d \sqrt{f}} \right) = -2 \log \left(\frac{0.05}{3.7} + \frac{2.51}{14,515 \sqrt{0.0731}} \right) = 3.698$$

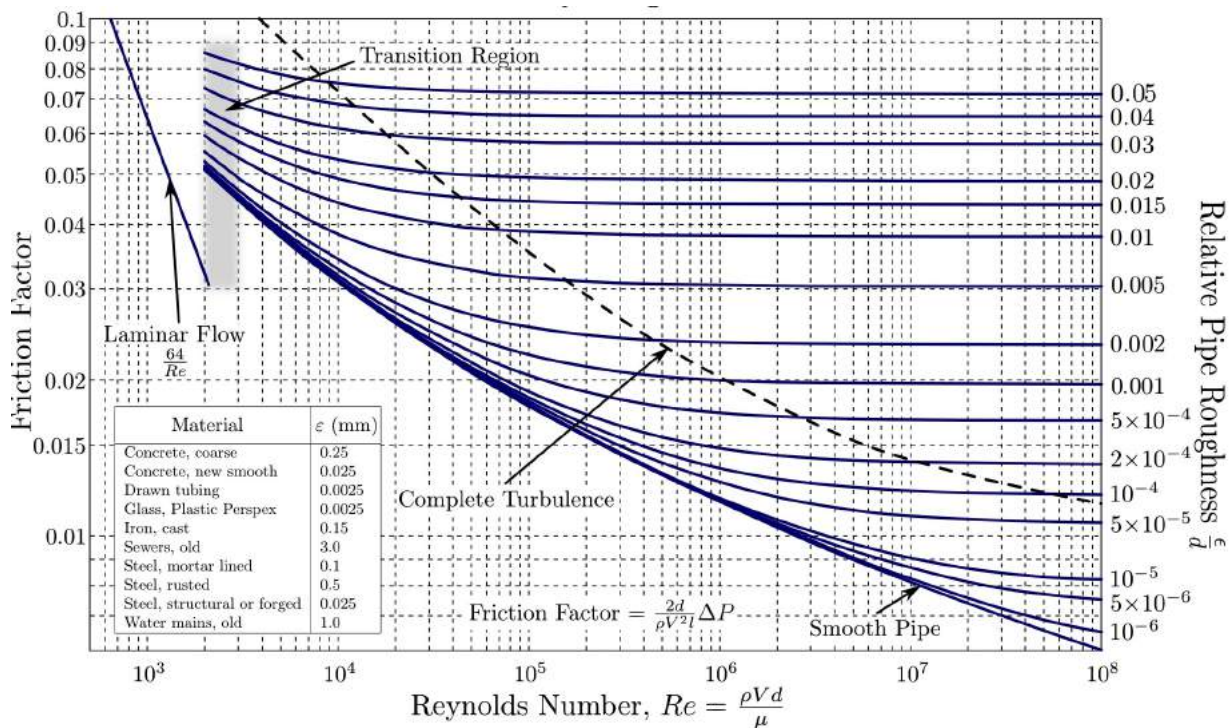

Figure 22. “Moody Chart” showing the effect of Re_d (that is, Reynolds number based on pipe **diameter** not **length**) and surface roughness ϵ/d on the friction factor (f).

the equation is satisfied, so $f = 0.0731$. Then

$$f \equiv \frac{\Delta P}{\frac{\rho v^2}{2} \frac{L}{d}} \Rightarrow \Delta P = f \frac{\rho v^2}{2} \frac{L}{d} = 0.0731 \frac{\frac{1000 \text{ kg}}{\text{m}^3} \left(\frac{3 \text{ ft}}{\text{s}} \frac{\text{m}}{3.281 \text{ ft}} \right)^2 (50 \text{ ft}) \left(\frac{12 \text{ in}}{\text{ft}} \right)}{0.625 \text{ in}}$$

$$\Rightarrow \Delta P = 29,335 \frac{\text{N}}{\text{m}^2} \frac{\text{lbf}}{4.448 \text{ N}} \left(\frac{\text{m}}{39.37 \text{ in}} \right)^2 = 4.26 \frac{\text{lbf}}{\text{in}^2}$$

c) What is the pumping power required in Watts?

$$\text{Power} = (\Delta P)(Q) = \frac{4.26 \text{ lbf}}{\text{in}^2} \frac{2.87 \text{ gal}}{\text{min}} \frac{4.448 \text{ N}}{\text{m}} \left(\frac{39.37 \text{ in}}{\text{m}} \right)^2 \frac{\text{ft}^3}{7.48 \text{ gal}} \left(\frac{\text{m}}{3.281 \text{ ft}} \right)^3 \frac{\text{min}}{60 \text{ s}} = 5.3 \frac{\text{Nm}}{\text{s}} = 5.3 \text{ W}$$

Do you think I did these calculations by hand? No way! I used an Excel sheet (double click to open). The cells shaded in blue are the things you change, and the other cells are calculated values, except for the “Friction factor (guess)” cell, which you have to adjust until the left-hand side (LHS) and the right-hand side (RHS) of the equation for the friction factor are equal, and thus the “fraction error” goes to zero. (You can also use Excel’s “goal seek” feature to do this adjustment automatically.) Actually, nowadays many people will use the Wolfram Alpha website (<http://www.wolframalpha.com>) where you can just enter the equations and Wolfram Alpha will solve them automatically. In fact, Wolfram Alpha actually has a built-in calculator for the friction factor (Equation 62) (<http://www.wolframalpha.com/input/?i=darcy+friction+factor>)!

Pipe dia (in)	Pipe len (ft)	Roughness (in)	Viscosity (m ² /s)	rho (kg/m ³)
0.625	50	0.03125	1.00E-06	1000
Pipe dia (m)	Pipe len (m)	epsilon		
0.01587423	15.23925632	0.05		
Velocity (ft/s)	Velocity (m/s)	Re		
3	0.914355379	14515		
Friction factor (guess)	LHS	RHS	fraction error	
0.07309956	3.698645	3.698296	9.4274E-05	
Delta P (N/m ²)	Pressure drop (lbf/in ²)			
29335.00	4.26			

Compressible flow

All of the above discussion of fluid mechanics relates to cases with constant density (ρ), which is certainly reasonable for liquids (e.g. water) under most conditions and even air if the velocity (v) is “small enough”. How small is small enough? We have to compare v to something else that also has

units of velocity. That “something else” turns out to be the speed of sound (c). The ratio of these is the *Mach number* (M), i.e.

$$M = v/c \quad \text{Equation 63.}$$

For an ideal gas, the sound speed c is given by the formula

$$c = (\gamma RT)^{1/2}$$

where

- γ is the *specific heat ratio* of the gas (≈ 1.4 for air at ambient temperature, but may be as low as 1 for gas molecule with many atoms, and as high as 5/3 for a monatomic gas like helium)
- R is the gas constant for the specific gas of interest = \mathfrak{R}/\mathcal{M} , where \mathfrak{R} is the universal gas constant = 8.314 J/mole K and \mathcal{M} is the molecular mass of the gas (in kg/mole, = 0.02897 kg/mole for air, thus $R = 287$ J/kgK for air.)
- T is the gas temperature (**absolute temperature** (*i.e.*, K not °C) of course!)

How does Mach number affect density (ρ), temperature (T) and/or pressure (P)? That depends on the *process* the gas experiences as it accelerates or decelerates. A detailed discussion of compressible gas dynamics is way beyond the scope of this course, but I’ll give you the results for the simplest case of one-dimensional steady flow of an ideal gas in a duct of changing area A with constant specific heats (C_p and C_v , discussed in the next chapter) between locations 1 and 2 assuming no heat transfer, no friction and no shock waves (we call this special case “isentropic flow,” meaning no change in the entropy of the gas) as well as no potential energy (elevation) change:

$$\begin{aligned} \rho_1 \left(1 + \frac{\gamma-1}{2} M_1^2 \right)^{1/\gamma-1} &= \rho_2 \left(1 + \frac{\gamma-1}{2} M_2^2 \right)^{1/\gamma-1} \\ P_1 \left(1 + \frac{\gamma-1}{2} M_1^2 \right)^{\gamma/\gamma-1} &= P_2 \left(1 + \frac{\gamma-1}{2} M_2^2 \right)^{\gamma/\gamma-1} \\ T_1 \left(1 + \frac{\gamma-1}{2} M_1^2 \right) &= T_2 \left(1 + \frac{\gamma-1}{2} M_2^2 \right) \\ \frac{A_2}{A_1} &= \frac{M_1}{M_2} \left[\frac{1 + \frac{\gamma-1}{2} M_2^2}{1 + \frac{\gamma-1}{2} M_1^2} \right]^{(\gamma+1)/2(\gamma-1)} \end{aligned} \quad \text{Equation 64}$$

These equations are plotted in Figure 23 below.

While a lot of simplifying assumptions were made (note all the underlined words above), this “isentropic flow” is still useful as the simplest model of flow in nozzles of jet and rocket engines, as well as intakes in jet engines. Note that as Mach number increases (for example, during expansion in a nozzle), pressure, density and temperature all decrease. However, to obtain transition from subsonic ($M < 1$) to supersonic ($M > 1$) flow, the area must pass through a minimum, i.e. a throat, which occurs at $M = 1$. Thus, rocket nozzles must have an hourglass shape in order to accelerate the exhaust to high Mach numbers and therefore produce the maximum possible thrust. Often the

areas are referenced to the minimum area at the throat (A^*) where $M = 1$, that is set $M_1 = 1$ and $A_1 = A^*$ in the above equation for A_2/A_1 and call A_2 just simply A , in which case equation reduces to

$$\frac{A}{A^*} = \left(\frac{2}{\gamma + 1} \right)^{(\gamma+1)/2(\gamma-1)} \frac{1}{M} \left(1 + \frac{\gamma-1}{2} M^2 \right)^{(\gamma+1)/2(\gamma-1)} \quad \text{Equation 65}$$

One important but often overlooked point about the above equation: the Mach number M is the local (at station 1 or 2) flow velocity U divided by the local sound speed (which depends on the local temperature.) So you can't divide the local velocity by the sound speed at ambient temperature to get the Mach number! That is, $M_1 = v_1/(\gamma RT_1)^{1/2}$ and $M_2 = v_2/(\gamma RT_2)^{1/2}$ but you can't say $M_2 = v_2/(\gamma RT_1)^{1/2}$!

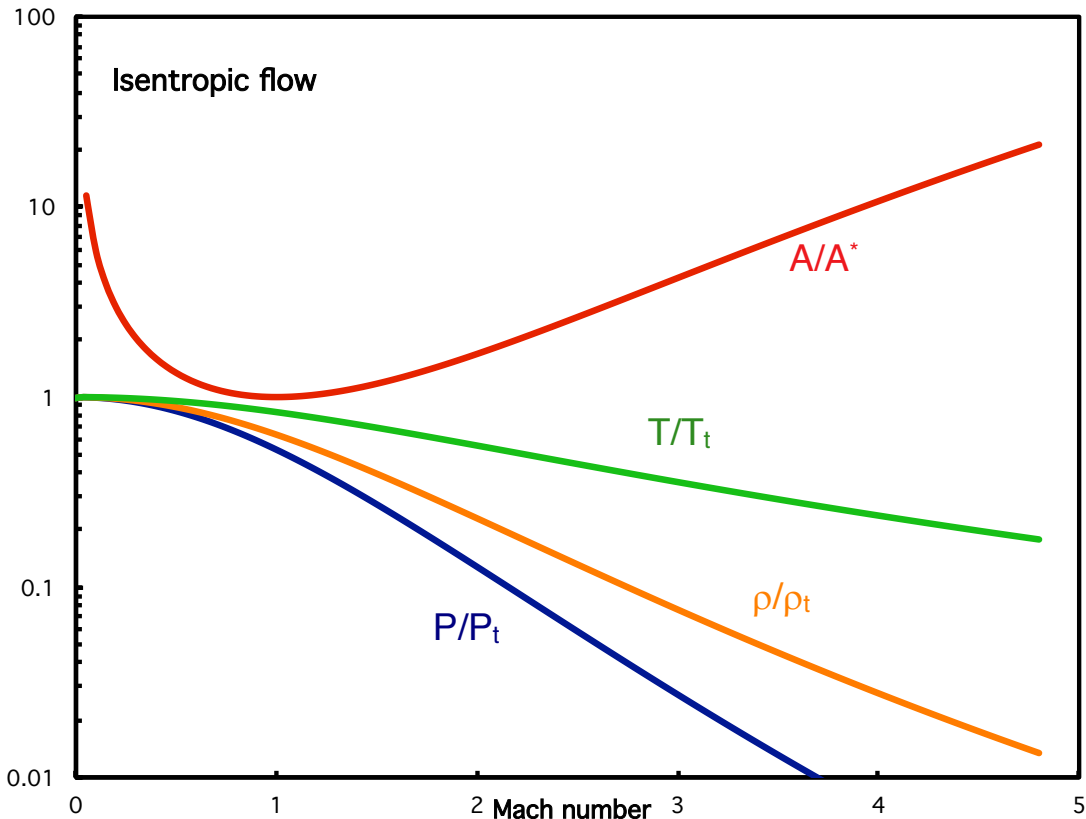

Figure 23. Plot of pressure, density, temperature and area as a function of Mach number for one-dimensional, isentropic flow of an idea gas with $\gamma = 1.4$. The “t” subscript indicates the pressure, density or temperature when $M = 0$ (called the *stagnation pressure, density or temperature*).

How to scrutinize this result? The units are clearly ok since γ and M are dimensionless. Also, if $A_1 = A_2$ then $M_1 = M_2$, that is, nothing changes. But here's a great function test: in the limit of small M

(small compressibility effects), the results should reduce to Bernoulli's equation. The second relation involves pressure (P) and velocity (v), so looks a lot like Bernoulli. Recall the binomial expansion theorem which says that for $m \ll 1$, $(1 + m)^n \approx 1 + mn$, thus

$$M \ll 1: P_1 \left(1 + \frac{\gamma-1}{2} M_1^2 \right)^{\gamma/(\gamma-1)} \approx P_1 \left(1 + \frac{\gamma-1}{2} M_1^2 \frac{\gamma}{\gamma-1} \right) = P_1 \left(1 + \frac{\gamma-1}{2} \frac{v_1^2}{\gamma RT} \frac{\gamma}{\gamma-1} \right)$$

$$= P_1 \left(1 + \frac{v_1^2}{2RT} \right) = P_1 + \frac{P}{RT} \frac{v_1^2}{2} = P_1 + \frac{\rho v_1^2}{2}$$

$$\text{similarly } P_2 \left(1 + \frac{\gamma-1}{2} M_2^2 \right)^{\gamma/(\gamma-1)} \approx P_2 + \frac{\rho v_2^2}{2}, \text{ thus } P_1 + \frac{\rho v_1^2}{2} \approx P_2 + \frac{\rho v_2^2}{2}$$

This is not quite Bernoulli's equation, which requires $\rho = \rho_1 = \rho_2 = \text{constant}$. But from the first part of Equation 64, in the limit of small M_1 and M_2 , $\rho_1 = \rho_2$. Notice that the exponent on the density terms, $1/(\gamma-1)$, is smaller than that on the pressure terms, $\gamma/(\gamma-1)$, and thus density can be assumed constant even when pressure is not. A formal derivation requires carrying out higher order terms (i.e. M^4 terms) in the binomial expansion so I'll skip that...

Example

The (now decommissioned) SR-71 "Blackbird" aircraft (pictured below) flew at Mach 3 at an altitude of 80,000 feet. Assuming isentropic flow, what is the temperature and pressure on the leading edges of the wings where the flow (in the frame of reference of the aircraft) has decelerated from $M_1 = 3$ to $M_2 = 0$?



From <http://www.digitaldutch.com/atmoscalc/calculator.htm>: at an altitude of 80,000 ft, the standard atmospheric conditions are $P_1 = 0.0273 \text{ atm}$ (that is, 0.0273 sea-level atmospheres!) and $T_1 = -52^\circ\text{C} = 221 \text{ K}$.

$$P_1 \left(1 + \frac{\gamma-1}{2} M_1^2\right)^{\gamma/\gamma-1} = P_2 \left(1 + \frac{\gamma-1}{2} M_2^2\right)^{\gamma/\gamma-1} \Rightarrow 0.0273 \text{ atm} \left(1 + \frac{1.4-1}{2} 3^2\right)^{1.4/1.4-1} = P_2 \left(1 + \frac{1.4-1}{2} 0^2\right)^{1.4/1.4-1}$$

$$\Rightarrow P_2 = 1.003 \text{ atm}$$

$$T_1 \left(1 + \frac{\gamma-1}{2} M_1^2\right) = T_2 \left(1 + \frac{\gamma-1}{2} M_2^2\right) \Rightarrow (-52 + 273) \text{ K} \left(1 + \frac{1.4-1}{2} 3^2\right) = T_2 \left(1 + \frac{1.4-1}{2} 0^2\right)$$

$$\Rightarrow T_2 = 619 \text{ K} = 654^\circ\text{F}$$

So the dynamic pressure loading on the wings (1 atm, or 14.7 lbf/in²) and the temperature (654°F) are really high, and things get worse in a hurry as M_1 increases - notice the M^2 terms appear everywhere, and there is an additional $\gamma/(\gamma-1) \approx 3.5$ exponent on the pressure equation - so dynamic pressure increases like M^7 in high-speed flight!

Since you're undoubtedly dying to know more about compressible flow, check out <http://ronney.usc.edu/AME436/Lecture12>.

Example

Can the air flow over a car be considered an incompressible flow ($\rho \approx \text{constant}$)? In decelerating the air flow from say 75 mph to 0 mph, how much does the density change assuming isentropic flow?

$$v = \frac{75 \text{ mi}}{\text{hr}} \frac{\text{hr}}{3600 \text{ s}} \frac{5280 \text{ ft}}{\text{mi}} \frac{\text{m}}{3.281 \text{ ft}} = 33.53 \frac{\text{m}}{\text{s}}$$

$$c = \sqrt{\gamma RT} = \sqrt{1.4 \frac{287 \text{ J}}{\text{kgK}} 298 \text{ K}} = 346.0 \frac{\text{m}}{\text{s}} \Rightarrow M = \frac{33.53 \text{ m/s}}{346.0 \text{ m/s}} = 0.0969$$

$$\rho_1 \left(1 + \frac{\gamma-1}{2} M_1^2\right)^{1/\gamma-1} = \rho_2 \left(1 + \frac{\gamma-1}{2} M_2^2\right)^{1/\gamma-1} \Rightarrow \frac{\rho_2}{\rho_1} = \frac{\left(1 + \frac{1.4-1}{2} 0.0969^2\right)^{1/1.4-1}}{\left(1 + \frac{1.4-1}{2} 0^2\right)^{1/1.4-1}} = 1.0047$$

Thus, the density changes by less than 0.5% in decelerating from 75 mph to 0 mph, so for all but the most stringent accuracy requirements, the density change can be neglected. In other words, for most practical purposes the air flow over a vehicle at 75 mph can be treated as *incompressible*, i.e. in the same way as if the flow were water at the same Reynolds number. At higher Mach numbers this would not necessarily be the case, but we usually don't drive fast enough for that to matter!

Chapter 7. Thermal and Energy Systems

“*Passion is energy. Feel the power that comes from focusing on what excites you.*” – Oprah Winfrey

Main courses in AME curriculum on this topic: AME 310 (Thermodynamics); AME 331 (Heat Transfer).

Conservation of energy – First Law of Thermodynamics

Describing a thermodynamic system

In order to characterize thermodynamic systems, we need to describe the behavior of the material as its temperature, pressure, volume, *etc.* changes, hence, the following terminology has been developed:

- Property – a quantitative description of a piece of matter (e.g. pressure, temperature, density, volume, mass, internal energy, enthalpy, entropy, as well as the composition)
- State – a list of the properties of a piece of matter (e.g., liquid water at 25°C and 1 atm)
- Process – a sequence of states (e.g., heat transfer to water at a constant pressure of 1 atm, with temperature increasing from 25°C to 35°C)
- Cycle – a sequence of processes that returns to the original state (e.g., compress liquid water at 25°C from 1 atm to 100 atm, transfer heat at constant pressure until the temperature is 400°C, expand the water (actually steam) until the pressure is back to 1 atm, then transfer heat from the water (actually steam) until the temperature is 25°C again)

Statement of the First Law

The cornerstone of thermodynamics is the First Law of Thermodynamics, which simply states that energy is conserved, *i.e.*, the energy contained in an isolated system (one that does not exchange energy with its surroundings) cannot change. Of course, energy can be converted from one form to another, which is the whole point of energy engineering – converting energy from a less-useful form to a more-useful form with the least wasted (notice I didn’t say **lost**) energy possible.

Equations for conservation of energy for a control mass

How do we quantify the above statement? Generally we perform our energy accounting in one of two ways, either by considering a **control mass**, *i.e.* a fixed mass of material (but generally changing volume, for example the gas in a piston/cylinder) or a **control volume**, *i.e.* a fixed volume in space that may have mass inflows and outflows, for example a jet engine.

Let’s start with the control mass approach since it’s a bit simpler. For the control mass, the First Law of Thermodynamics can be stated as follows for an infinitesimal change in state:

$$dE = dQ - dW$$

Equation 66

where

dE = change in energy contained by the mass - a property of the mass (in Joules, BTUs, etc.)

dQ = heat transfer to the mass (in Joules, BTUs, etc.)

dW = work transfer to or from the mass (in Joules, BTUs, etc.)

For change from an initial state 1 to a final state 2, the 1st law can then be written as

$$E_2 - E_1 = Q_{1 \rightarrow 2} - W_{1 \rightarrow 2} \quad \text{Equation 67}$$

i.e., during the process of going from state 1 to state 2, the change in energy contained by the mass ($E_2 - E_1$) is equal to the heat transferred to the mass during the process of going from state 1 to state 2 ($Q_{1 \rightarrow 2}$) minus the work transferred out of the mass during the process of going from state 1 to state 2 ($W_{1 \rightarrow 2}$). The minus sign in front of $W_{1 \rightarrow 2}$ is a result of the fact that heat transfer is defined as positive if it is from the surroundings to the system whereas work transfer is defined as positive if from the system to the surroundings. This is probably a consequence of the fact that the earliest common application of thermodynamics was to devices such as steam engines in which heat was transferred in and work was transferred out. (It is certainly acceptable to define heat transfer as negative if it is out of the system and/or work as positive if it is into the system, but then the signs on $Q_{1 \rightarrow 2}$ and/or $W_{1 \rightarrow 2}$ would have to change.) A process in which no heat transfer occurs is called an *adiabatic* process, but there is no common term for a system in which no work transfer occurs.

There's nothing profound about the above equation, it's just "energy accounting." It merely states that the change in the energy E contained by a substance is equal to the energy transfer to the substance (via heat transfer Q) minus the energy transfer from the substance (via work transfer W). In other words, "**what goes in – what goes out = what accumulates.**"

In the above equation, 1 is the initial *state* or condition of the system (temperature, pressure, volume, etc.) and 2 is the final state. $1 \rightarrow 2$ is the *process* or series of states leading from the initial state 1 to the final state 2.

What is the difference between heat and work? Why do we need to consider them separately? This is a very profound issue.

1. Heat transfer is **disorganized** energy transfer on the **microscopic (molecular or atomic) scale** and has **entropy transfer** associated with it. (What is entropy? We'll talk about this in the context of the 2nd Law of Thermodynamics, but basically it's a measure of the level of disorganization of the system.)
2. Work transfer is **organized** energy transfer which may be at either the microscopic scale or macroscopic scale and has **no entropy transfer** associated with it.

Furthermore, the total energy of the substance (E) consists of

- Macroscopic kinetic energy ($KE = \frac{1}{2}mv^2$) (m = mass, v = velocity)
- Macroscopic potential energy ($PE = mgz$) (g = acceleration of gravity, z = elevation)
- Microscopic internal energy (U) (which consists of both kinetic (thermal) and potential (chemical bonding) energy, but we lump them together since we can't see them separately,

only their effect at macroscopic scales.) Generally this is written not as U but as mu, where m = mass and u = internal energy per unit mass (units Joules/kg, BTU/lbm, etc.).

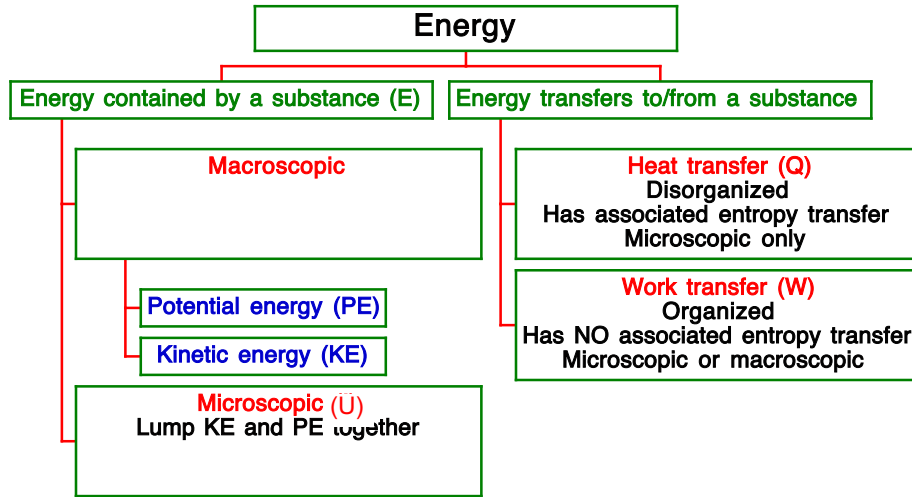

Figure 24. Energy family tree.

Thus, the total energy contained by a piece of material is given by

$$E = KE + PE + U = \frac{1}{2}mv^2 + mgz + mu$$

See the “energy family tree” (Figure 24). Consequently, with the aforementioned forms of energy only (internal, kinetic, potential) along with the two types of energy transfers (heat and work) the First Law for a control mass (recall a control mass is a fixed mass of material that may change size or shape or volume but no mass crosses its boundary) can be written as

$$\left(mu_2 + \frac{1}{2}mv_2^2 + mgz_2 \right) - \left(mu_1 + \frac{1}{2}mv_1^2 + mgz_1 \right) = Q_{1-2} - W_{1-2} \quad \text{or} \quad \text{Equation 68}$$

$$\left(u_2 + \frac{1}{2}v_2^2 + gz_2 \right) - \left(u_1 + \frac{1}{2}v_1^2 + gz_1 \right) = \frac{Q_{1-2} - W_{1-2}}{m}$$

where the subscript “1” indicates some initial state and “2” a final state after some process has occurred.

There are several ways to transfer heat to/from a system, that is, by conduction, convection and/or radiation as will be discussed later. Another way is to have a chemical reaction, for example combustion, occur within the mass. Strictly speaking, this is **not** heat transfer, it is a change in the potential energy part of internal energy of the mass (usually changed into the kinetic part of the internal energy, *i.e.*, the substance gets hotter). But chemical energy release due to combustion is often modeled as heat transfer from an external source. How much? That depends on 2 things: the mass of fuel being burned (m_f) and the *heating value* of the fuel, denoted as Q_R :

$$Q_{1 \rightarrow 2} \text{ (due to combustion)} = m_f Q_R \quad \text{Equation 69}$$

The units of Q_R are Joules/kg, but be careful – this is **per kg of fuel**, not per kg of fuel+air mixture! Some typical values of Q_R (in J/kg) are given in Table 5. The most fuel that can be added without wasting fuel is when there is just enough oxygen (from the air) to burn all of the carbons to make CO_2 and all the hydrogens to make H_2O . This is called the *stoichiometric* mixture, and the ratio of (fuel mass)/(fuel mass + air mass) at stoichiometric is about 0.064 for typical hydrocarbons – which means the mixture is mostly air. If there is a higher mass ratio of fuel, then fuel is added that can't be burned because there is not enough oxygen, which is a waste of fuel and generates pollutants such as CO (carbon monoxide) (poisonous) and unburned hydrocarbons that helps create ozone (O_3) (bad stuff!) in the atmosphere. Values of the stoichiometric ratio of (fuel mass)/(fuel mass + air mass) are also given in Table 5.

Fuel	Heating value, Q_R (J/kg)	(fuel mass)/(fuel mass + air mass) at stoichiometric
Gasoline	44×10^6	0.0642
Methane	50×10^6	0.0550
Methanol	20×10^6	0.104
Ethanol	27×10^6	0.0915
Coal	34×10^6	0.0802
Paper	17×10^6	0.122
Fruit Loops™	16×10^6	Probably about the same as paper
Hydrogen	120×10^6	0.0283
Pu_{238} decay	$2,000 \times 10^6$	n/a
U_{235} fission	$82,000,000 \times 10^6$	n/a

Table 5. Heating values and stoichiometric fuel mass ratios of some common fuels

By comparison, the energy content of the lithium-ion batteries used in your cell phone and laptop computer (that is, by discharging the battery to extract its electrical energy, not burning the battery!) is about 0.8×10^6 J/kg – **more than 50 times less than hydrocarbon fuels**. This is why most of us don't drive a battery-powered car, and none of us fly in battery-powered aircraft! Also, starches and sugars all contain about 110 cal/ounce (just look at the nutritional information on the side of the box of cereal or any other dry food), which can be converted to 16×10^6 J/kg (recall that 1 diet calorie = 1000 thermodynamic calorie). Note also that nuclear energy sources such as uranium-235 fission have **millions** of times more energy per unit mass than fuels, which explains their value for bombs, submarine propulsion, etc.

Equations for conservation of energy for a control volume

For a control volume (recall a control volume is a fixed volume in space whose size and shape do not change but there may be mass flow in and out of the volume) it's generally more convenient to write the First Law as a rate equation:

$$\frac{dE}{dt} = \dot{Q} - \dot{W} + \dot{m}_{in} \left(h_{in} + \frac{v_{in}^2}{2} + gz_{in} \right) - \dot{m}_{out} \left(h_{out} + \frac{v_{out}^2}{2} + gz_{out} \right) \quad \text{Equation 70}$$

where

E = energy contained by the control volume

$\dot{m}_{in}, \dot{m}_{out}$ = mass flows into / out of control mass (kg/s)

\dot{Q}, \dot{W} = rates of heat transfer in and work transfer out (Watts)

h_{in}, h_{out} = *enthalpy* of material at inlet/outlet per unit mass (Joules/kg) = $u + P/\rho$, where u = internal energy per unit mass as above, P = pressure and ρ = density.

Note that the above equation could have been written down simply by taking the time derivative of the Control Mass form of the First Law. The only thing one couldn't figure out by inspection is the substitution of the enthalpy h for internal energy u . Note also that since $h = u + P/\rho$, thus the difference between h and u is just P/ρ . This is due to something called the "flow work" required to push the material into the control volume and the work obtained when extracting it from the exit of the control volume. This flow work term doesn't apply to the control mass since (by definition) there is no mass entering or leaving the control mass!

Note also that for the Control Volume form, instead of using the subscripts "1" and "2" to denote the states before and after the process as was done with the Control Mass form of the First Law, in the Control Volume form the subscripts "in" and "out" are used. This is because for the control volume one must distinguish between a mass flow inlet (which causes mass and energy to be added to the control volume) from a mass flow outlet (which causes mass and energy to leave the control volume). The difference is only a sign (+ or -), but that sign is very important! On the other hand, for the Control Mass form of the first law, the subscripts "1" and "2" are interchangeable, that is, 1 could be at the beginning of the process and 2 at the end or vice versa, and the conservation of energy is still enforced. When the Second Law of Thermodynamics is considered, however, there is a very definite requirement as to which state, 1 or 2, happened first. Only for a very special type of process, called a *reversible process*, could either 1 or 2 be the initial state. The same applies to the inlet vs. outlet; when the Second Law of Thermodynamics is considered, unless the process is reversible, there is a definite restriction on which end can be the inlet and which end is the outlet.

For many materials over not too large a temperature range, C_p can be assumed to be constant, *i.e.*

$$h_2 - h_1 \approx C_p(T_2 - T_1) \quad \text{Equation 71,}$$

where C_p is the *specific heat* or *heat capacity at constant pressure* of the material (units J/kg°C or J/kgK) and T is the temperature. Also, the internal energy per unit mass (u) can be represented in a similar way:

$$u_2 - u_1 \approx C_v(T_2 - T_1) \quad \text{Equation 72,}$$

where C_v is the *specific heat* or *heat capacity at constant volume* of the material (units again J/kg°C or K/kgK) and again one must be able to assume that C_v is constant over this temperature range. The ratio of C_p to C_v is called the *specific heat ratio* (γ) that we've already used in Chapter 6 without actually knowing what it is:

$$\gamma \equiv C_p/C_v \quad \text{Equation 73.}$$

For liquids and solids, γ is very nearly 1 so this distinction between C_p and C_v is of no practical importance. But it is hugely important for gases; even though for gases $1 \leq \gamma \leq 5/3$, many of the formulas (e.g., at the end of Chapter 6) involve a factor of $(\gamma - 1)$. **Important point:** the terms “specific heat” or “heat capacity” at “constant pressure” or “constant volume” are terribly misleading for two reasons:

1. Substances do not contain heat, they contain internal energy and enthalpy; heat is a mode of energy transfer between a substance and its surroundings, not a property of a material
2. C_p and C_v can be and often are used even in processes for which pressure or volume is not constant

Despite these atrocities of terminology, we are forced to use these terms because they are engrained in the vernacular of science and engineering. “Specific enthalpy” and “Specific internal energy” would be much better terms for C_p and C_v , respectively (in which case we would probably call them C_h and C_u instead.)

A very useful and important special case of the control volume form of the First Law is the *Steady State, Steady Flow* (SSSF) case, where all properties (E , h_{in} , h_{out} , u_{in} , u_{out} , z_{in} , z_{out}) and all fluxes (\dot{m}_{in} , \dot{m}_{out} , \dot{Q} , \dot{W}) are constant (not changing over time) and moreover $\dot{m}_{in} = \dot{m}_{out}$ (otherwise the mass contained within the control volume would change over time). In this case the First Law for the Control Volume is written as

$$0 = \dot{Q} - \dot{W} + \dot{m} \left[(h_{in} - h_{out}) + \left(\frac{v_{in}^2}{2} - \frac{v_{out}^2}{2} \right) + g(z_{in} - z_{out}) \right] \quad \text{Equation 74}$$

Processes

As previously mentioned, a “process” is a sequence of states. Normally in simple thermodynamic analyses, one assumes that one of the properties of the substance (temperature, pressure, volume, entropy, internal energy, etc.) is constant during a given process. It is beyond our scope to identify which property is most nearly constant during a given type of process except to mention a few specific cases. For heat addition due to combustion in a piston-type engine, the process is nearly constant volume. For steady-flow heat addition due to combustion in a gas turbine, or heat transfer to water/steam in a boiler, the process is nearly constant pressure. Compression of a substance is usually idealized as being “reversible,” meaning that the process can be reversed (i.e. the substance can be expanded) until the substance returns to its original state and the same amount of work transferred into the system can be transferred out during expansion. This is similar to an ideal spring. Moreover, compression processes are usually idealized as being adiabatic (without heat transfer). It can be shown that a reversible and adiabatic process results in no change in the entropy (discussed later) of the substance. Furthermore, it can be shown that isentropic compression or expansion of an ideal gas with constant specific heat ratio (γ) follows the relation

$$P_1 V_1^\gamma = P_2 V_2^\gamma \quad (\text{ideal gas, constant } \gamma, \text{ reversible adiabatic process}) \quad \text{Equation 75}$$

P = pressure, V = volume

This relationship ($PV^\gamma = \text{constant}$) is called the *isentropic compression law* (but note the restrictions on when it applies: (1) ideal gas, (2) constant specific heat ratio γ , (3) reversible and (4) adiabatic process! 3 out of 4 is NO GO!)

Examples of energy analysis using the 1st Law

Example #1 – gas compression

For isentropic compression of $480 \text{ cm}^3 (= 480 \times 10^{-6} \text{ m}^3)$ of air in a cylinder of car engine initially at 300K and 1 atm ($= 101325 \text{ Pa}$) by a volume ratio of 8, neglecting kinetic and potential energy in the gas,

- What is the pressure and temperature of the air after compression?
 - What is the work required?
 - If there are 8 cylinders and the engine rotates at 3000 RPM, what power is required to do this compression?
- a) For an ideal gas with constant γ undergoing an isentropic process,

$$P_1 V_1^\gamma = P_2 V_2^\gamma \text{ where } P = \text{pressure, } V = \text{volume}$$

$$\text{Thus } P_2 / P_1 = V_1^\gamma / V_2^\gamma \text{ or } P_2 = P_1 (V_1 / V_2)^\gamma = (1 \text{ atm})(8)^{1.4} = 18.4 \text{ atm.}$$

Since this is an ideal gas we can also say $P_1 V_1 = mRT_1$ and $P_2 V_2 = mRT_2$; combining these relations with $P_1 V_1^\gamma = P_2 V_2^\gamma$ we obtain $T_2 = T_1 (V_1 / V_2)^{\gamma-1}$

$$V_1 = 480 \text{ cm}^3, V_2 = 480/8 = 60 \text{ cm}^3, T_1 = 300\text{K} \Rightarrow T_2 = 300\text{K} (480/60)^{0.4} = \mathbf{689.2 \text{ K}}$$

Note that the pressure after compression (P_2) seems to fail the function test – how can the pressure ratio be more than the volume ratio, that is, how can the post-compression pressure be more than 8 atm? It's because we put work into the gas, as evidenced by the temperature rise. If the temperature were constant during the compression, then from the ideal gas law $PV = mRT$ with m , R and T all constant, we would have $P_2/P_1 = V_1/V_2 = 8$ (or less, if there were leaks in the cylinder, which is the whole reason for doing a compression test – to check for leaks.) This confused me as a fledgling auto mechanic in high school; even then I was doing function tests, and I couldn't understand why when I did a compression test on my engine, the pressure ratio was higher than the volume ratio. I was thinking the process was isothermal, not isentropic (I didn't know about isentropic processes in high school...)

- Treat the mass of gas in the cylinder as a control mass

$$E_2 - E_1 = Q_{1-2} - W_{1-2}$$

In an isentropic (*reversible, adiabatic*) process there is no heat transfer (which is what adiabatic means), only work transfer, so $Q_{1-2} = 0$. Also, $KE = PE = 0$, so

$$E = U + KE + PE = U, \text{ thus}$$

$$W_{1 \rightarrow 2} = E_1 - E_2 = U_1 - U_2 = m(u_1 - u_2) = mC_v(T_1 - T_2).$$

From the ideal gas law, $m = P_1V_1/RT_1$; for air $R = 287 \text{ J/kg}^\circ\text{C} = 287 \text{ J/kgK}$ (see Chapter 6, the section on Compressible Flow, or the discussion at the end of the units conversion table near the beginning of these notes), thus

$$m = \frac{P_1V_1}{RT_1} = \frac{(101325 \text{ N/m}^2)(480 \text{ cm}^3)(\text{m}/100 \text{ cm})^3}{(287 \text{ J/kgK})(300 \text{ K})} = 5.65 \times 10^{-4} \text{ kg}$$

For air at 300K, $C_v \approx 720 \text{ J/kg}^\circ\text{C} = 720 \text{ J/kgK}$ (see, for example, https://www.engineeringtoolbox.com/air-specific-heat-capacity-d_705.html) thus

$$W_{1 \rightarrow 2} = mC_v(T_1 - T_2) = (5.65 \times 10^{-4} \text{ kg}) \left(720 \frac{\text{J}}{\text{kgK}} \right) (300 \text{ K} - 689.2 \text{ K}) = -158.3 \text{ J}$$

(Function test: work is negative because it's work going **into** the gas)

c) All modern automotive engines are 4-stroke engines and have only one compression stroke for every 2 revolutions of the engine, so there are only 1500 compression strokes per minute per cylinder, thus

$$\begin{aligned} \text{Power} &= \frac{\text{work}}{\text{time}} = \frac{-158.3 \text{ J}}{\text{compression}} \frac{1500 \text{ compression}}{\text{cylinder min}} \frac{\text{min}}{60 \text{ s}} (8 \text{ cylinder}) = -3.14 \times 10^4 \frac{\text{J}}{\text{s}} \\ &= -3.14 \times 10^4 \frac{\text{J}}{\text{s}} \frac{\text{W}}{\text{J/s}} \frac{1 \text{ hp}}{746 \text{ W}} = -42.4 \text{ hp} \end{aligned}$$

(Performance test: this sounds like a lot of power, but keep in mind (a) this is an 8-cylinder engine with a *displacement* of $(480 - 60) \text{ cm}^3/\text{cyl} \times 8 \text{ cyl} = 3360 \text{ cm}^3 = 3.36 \text{ liter}$; (b) the engine rotation rate is fairly high, 3000 rev/min, whereas your typical highway cruise is closer to 2000 rev/min and (c) this assumes the air is coming in at 1 atm, which means wide open throttle, i.e. “pedal to the metal.” At this condition the engine would produce well over 100 net horsepower.)

Wouldn't it be better not to compress the air, and get 42 more horsepower? No way! If you don't compress, you don't get any power at all. You don't have an engine any more, just a complicated heater. As it turns out, and you'll learn about this if you take AME 436, that you get more work out of expanding the hot gas than the work input required to compress the cold gas by the same volume ratio. This is the **only** reason that internal combustion engines work. In fact, the higher the volume compression ratio, the more work you get out for a given amount of heat input and thus the higher efficiency you get. This is discussed further below.

Example #2 – potential energy

The Upper Fall of Yosemite Falls in Yosemite National Park is a sheer plunge of 440 meters. Assuming no air drag (yeah, right), no heat transfer to/from the air or rocks (yeah, right) and no work extracted from the falling water (hey, this is a National Park, no hydroelectric plants allowed!)

- a) What is the velocity of the water just before it hits the rocks at the bottom of the upper falls? Assume that the water is nearly at rest at the top of the falls.

Draw a control volume where in = top of falls and out = bottom of falls, just above the rocks. Then from the *steady state, steady flow* form of the First Law, with no heat transfer, no work transfer, and (until after the water hits the rocks) no change in enthalpy:

$$0 = \dot{Q} - \dot{W} + \dot{m} \left[(h_{in} - h_{out}) + \left(\frac{v_{in}^2}{2} - \frac{v_{out}^2}{2} \right) + g(z_{in} - z_{out}) \right]$$

$$\dot{Q} = 0, \dot{W} = 0, h_{in} = h_{out}, v_{in} = 0 \Rightarrow v_{out} = \sqrt{2g(z_{in} - z_{out})} = \sqrt{2 \frac{9.81m}{s} (440m - 0m)} = 92.9 \frac{m}{s}$$

Note that this is just the result of a free-fall of 440 m (a good function test).

- b) After churning around in the rocks (with no further change in elevation) until the velocity is very small compared to that just before hitting the rocks, how much warmer is the water?

Draw a control volume where in = bottom of falls, just above the rocks and out = water downstream after churning around in the rocks until the velocity is very small:

$$0 = \dot{Q} - \dot{W} + \dot{m} \left[(h_{in} - h_{out}) + \left(\frac{v_{in}^2}{2} - \frac{v_{out}^2}{2} \right) + g(z_{in} - z_{out}) \right]$$

$$\dot{Q} = 0, \dot{W} = 0, z_{in} = z_{out}, v_{out} = 0 \Rightarrow h_{out} - h_{in} = \frac{v_{in}^2}{2}$$

$$h_{out} - h_{in} = C_p (T_{out} - T_{in}) \Rightarrow (T_{out} - T_{in}) = \frac{v_{in}^2}{2C_p} = \frac{\left(92.9 \frac{m}{s} \right)^2}{2 \left(\frac{4184J}{kg K} \right)} = 1.03K = 1.03^\circ C = 1.86^\circ F$$

Example #3 – kinetic energy

A jet engine on an aircraft flying steadily at 500 mi/hr has an inlet air mass flow of 10 kg/s, an inlet air temperature of 250K, a fuel mass flow of 0.3 kg/s, and an exhaust temperature of 900K. All flows are steady. What is the velocity of the jet exhaust? Assume $C_p = 1400 J/kg^\circ C$ for fuel, air and exhaust. The heating value of jet fuel is the same as gasoline. Neglect elevation change, and neglect any work extracted from the engine (*e.g.*, to drive an electrical generator.)

In this case we have two inlets, one for fuel ($v_{in,fuel} = 0$) and one for air ($v_{in,air} = 500 \text{ mi/hr} = 223.5 \text{ m/s}$), but only one outlet (for the jet exhaust) ($v_{out} = ???$). The heat input is the mass flow rate of fuel multiplied by the heating value of the fuel. Since the flow is steady, we can apply the SSSF Control Volume form of the First Law as follows:

Steady-state, steady-flow with $\dot{W} = 0, z_{in} = z_{out}, \dot{m}_{in,air} + \dot{m}_{in,fuel} = \dot{m}_{out,exhaust} \Rightarrow$

$$0 = \dot{Q} + \dot{m}_{in,air} \left[h_{in,air} + \frac{v_{in,air}^2}{2} \right] + \dot{m}_{in,fuel} \left[h_{in,fuel} + \frac{v_{in,fuel}^2}{2} \right] - \dot{m}_{out,exh} \left[h_{out,exhaust} + \frac{v_{out,exhaust}^2}{2} \right]$$

$$v_{in,fuel} = 0, h_{out} - h_{in} = C_p (T_{out} - T_{in}), \dot{Q} = \dot{m}_{fuel} Q_R \Rightarrow$$

$$\begin{aligned} \frac{v_{out,exhaust}^2}{2} &= \frac{\dot{m}_{in,fuel}}{\dot{m}_{in,fuel} + \dot{m}_{in,air}} Q_R + C_p (T_{in} - T_{out}) + \frac{\dot{m}_{in,air}}{\dot{m}_{in,fuel} + \dot{m}_{in,air}} \frac{v_{in,air}^2}{2} \\ &= \frac{0.3 \text{ kg/s}}{0.3 \text{ kg/s} + 10 \text{ kg/s}} \left(44 \times 10^6 \frac{\text{J}}{\text{kg}} \right) + \frac{1400 \text{ J}}{\text{kgK}} (250 \text{ K} - 900 \text{ K}) + \frac{10 \text{ kg/s}}{0.3 \text{ kg/s} + 10 \text{ kg/s}} \frac{\left(223.5 \frac{\text{m}}{\text{s}} \right)^2}{2} \\ &= 3.958 \times 10^5 \frac{\text{m}^2}{\text{s}^2} \Rightarrow v_{out,exhaust} = 890 \frac{\text{m}}{\text{s}} = 1990 \frac{\text{mi}}{\text{hr}} \end{aligned}$$

By using the Second Law of Thermodynamics (which we haven't covered yet) one can determine the exhaust temperature without having to specify it as we have done here. Note that the exhaust velocity is much higher than the flight velocity, which is required if we want any net thrust! In practical jet engines, however, only a portion of the fuel is burned and most of the air ingested into the engine goes through a giant fan without being burned. The power needed to drive this fan comes from taking work out of the combusted stream through several stages of turbines. This type of engine is called a *turbofan* and is much more efficient than the *turbojet* we just analyzed. The reasons why the turbofan is more efficient than the *turbojet* (where all of the air is compressed, mixed with fuel, burned and expanded) is discussed in great detail in AME 436.

Second Law of thermodynamics

The First Law of Thermodynamics told us that energy is conserved, i.e., the energy contained in an isolated system (one that does not exchange energy with its surroundings) cannot change. But this isn't the whole story, because it does not place any restrictions on the *direction* of a process. For example, one can readily fill a (constant-volume) combustion chamber with a mixture of methane and air at 300K, ignite the mixture with a spark, and observe a flame burn the mixture to form carbon dioxide, water and nitrogen at 2000K. Clearly this does not violate the First Law. But when was the last time you saw carbon dioxide, water and nitrogen at 2000K in a chamber spontaneously cool off to form methane and air at 300K? Clearly this does not violate the First Law either, since energy is conserved in either the forward or reverse direction, but you have never seen the reverse process and you never will.

So clearly, we need a Second Law of Thermodynamics that places restrictions on the direction of processes. The Second Law invokes a property of substances called *entropy*, which is the measure of the "disorganization" or "randomness" of a substance. The hotter or less dense a substance is, the

less information we have about where the individual molecules are, and thus the higher its entropy will be. The Second Law can be stated simply as

The entropy of an isolated system always increases or remains the same

meaning that the entropy never decreases. The methane – air mixture at 300K has a lower entropy than the carbon dioxide, water and nitrogen mixture at 2000K, so only the usual combustion process is physically possible, never the reverse. (Of course I could take that carbon dioxide, water and nitrogen at 2000K, cool it off to 300K, break the molecules apart, rearrange them to form methane and air, but to do this I would need to increase the entropy of the surroundings by more than the entropy change of combustion, so there would be a net increase in the entropy of the universe.)

Formally, the entropy (S) of a system of a given internal energy per particle can be calculated according to

$$S = k \ln(\Omega) \qquad \text{Equation 76}$$

where $k = 1.38 \times 10^{-23}$ J/K is Boltzmann's constant discussed in Chapter 2 (recall that k is **per particle** and the universal gas constant $\mathfrak{R} = kN_A$, where N_A is Avogadro's number) and Ω is the number of possible ways the system can attain that internal energy. If there is only one way the system can obtain a given internal energy ($\Omega = 1$) (for example, raising a mass to a given elevation to obtain a given potential energy) then the entropy $S = 0$, *i.e.*, there is no uncertainty or disorganization, and the more different ways the same energy level can be attained, the greater Ω is and thus the greater the entropy S is. A detailed discussion of entropy and the Second Law of Thermodynamics is WAY beyond the scope of this course, so only two important *consequences* of the Second Law will be mentioned here. The first such consequence is that

It is impossible to create a device that has no effect other than the transfer of heat from a lower temperature to a higher temperature.

If this were not true, then it would be possible for an object initially at uniform temperature to spontaneously become hotter on one side and colder on the other – which is obviously a more organized (lower entropy) state than the original, uniform-temperature object. This statement is sometimes stated as “heat is always transferred from hot to cold, never the reverse” – which is only a requirement if there is no other effect. Obviously a refrigerator transfers heat from a lower temperature (your food and drink) to a higher temperature (the air in your kitchen) but it has other effects too – namely there is a work input to the process. The second consequence of the Second Law that will concern us is the limitations on the efficiency of heat engines and refrigerators, discussed below.

Engines cycles and efficiency

The First Law said that “you can't win,” meaning that one cannot, for example, transfer 1 Joule of energy into a device in the form of heat transfer and get more than 1 Joule of work transfer out of said device (despite the fact that every day the news media reports that someone somewhere in the world has done exactly that.) The Second Law is an even more insidious and depressing because it

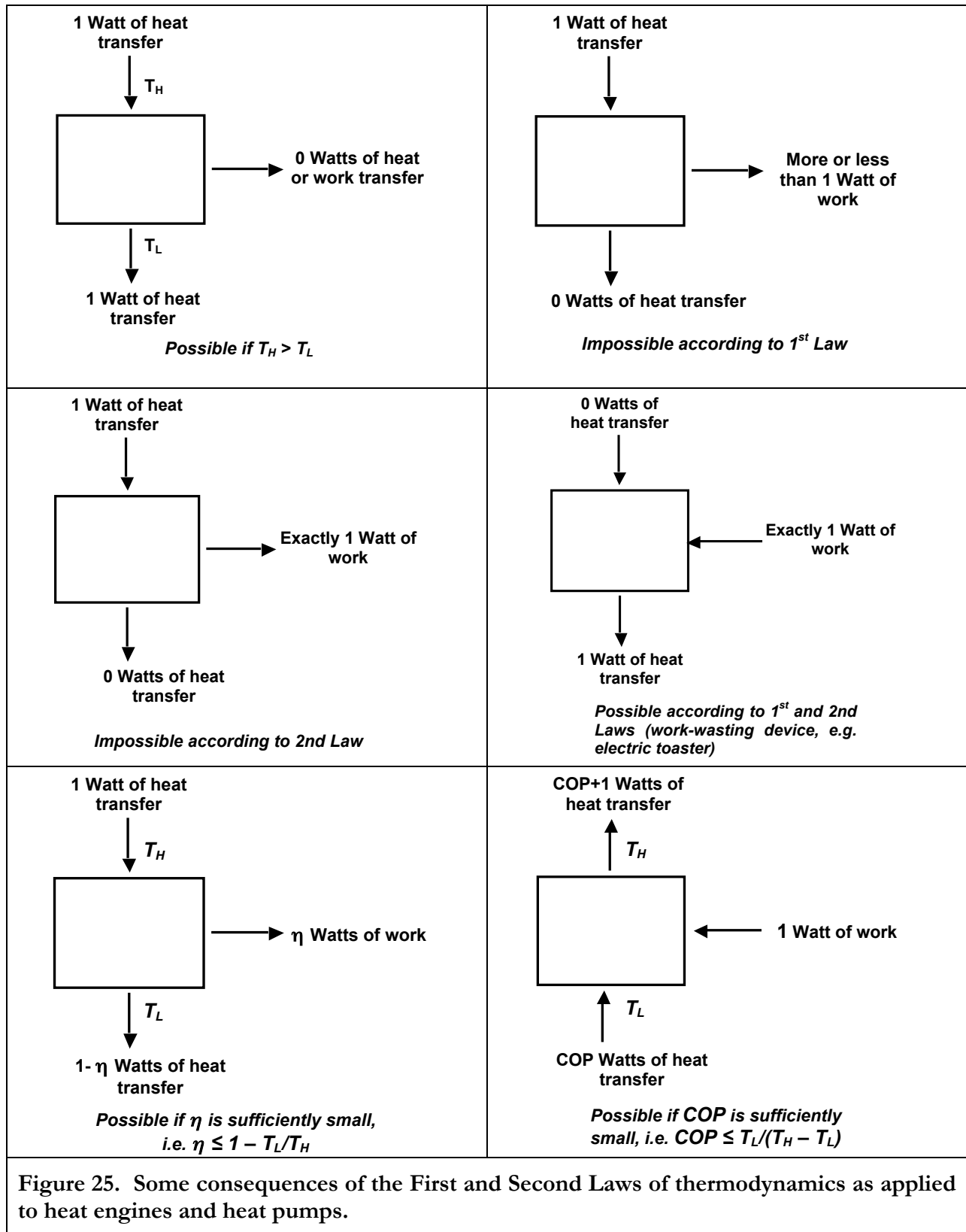

says in effect that “you can’t break even,” meaning that for 1 Joule of energy transfer into a device in the form of heat transfer, one cannot even get as much as 1 Joule of work transfer out of said device.

How much work output can one obtain if not 100% of the heat transfer input? To determine this, first we’ll state that “it can be shown” that the infinitesimal entropy change dS resulting from any heat transfer process is given by

$$dS \geq \frac{dQ}{T} \quad \text{Equation 77}$$

where dQ is the infinitesimal amount of heat transfer (units of Joules, not to be confused with volume flow rate Q in units of m^3/s discussed in the previous chapter) and T is the temperature (**must be absolute temperature, K not °C!**) at which the heat transfer occurs. The inequality is extremely important; the $=$ sign applies to theoretically best possible process (called a *reversible process*) and the $>$ sign applies for any real process (called an *irreversible process*). If the temperature T is constant during the process then the above equation becomes

$$\Delta S \geq \frac{Q}{T} \quad \text{Equation 78}$$

It is important to note that **there is no entropy transfer associated with work transfer, so there are no dW/T terms to consider when evaluating entropy changes.** It is equally important to note that changes in the macroscopic (organized) kinetic energy and/or potential energy of the substance causes no entropy change, thus no $\Delta(mv^2/2)/T$ or $\Delta(mgz)/T$ terms need to be considered when evaluating entropy changes.

Now applying this to a device in which Q_H units of heat are transferred into the device at a constant high temperature T_H and Q_L units of heat are transferred out of the device at a lower temperature T_L , the net entropy change in the universe surrounding the device must be positive, *i.e.*,

$$\begin{aligned} \text{Total entropy production in the universe} \\ = \Delta S_H + \Delta S_L = -Q_H/T_H + Q_L/T_L \geq 0 \Rightarrow T_L/T_H \leq Q_L/Q_H \end{aligned}$$

where the negative sign in front of Q_H appears because Q_H is out of the universe and the positive sign in front of Q_L appears because Q_L is into the universe. Thus, for the best possible device, $-Q_H/T_H + Q_L/T_L = 0$ or

$$T_L/T_H = Q_L/Q_H$$

The efficiency (η) of the engine is the ratio of work output (W) to heat input (Q_H) (see page 16), and by the first law $W = Q_H - Q_L$, thus

$$\eta \equiv W/Q_H = (Q_H - Q_L)/Q_H = 1 - Q_L/Q_H \text{ (for any engine)}$$

and for the best possible engine with zero net entropy production in the universe and thus $T_L/T_H = Q_L/Q_H$

$$\eta = 1 - \frac{T_L}{T_H} \quad (\text{for the best possible engine}) \quad \text{Equation 79}$$

This best possible device is a theoretical abstraction called a *Carnot cycle engine*. Then for any possible engine (Carnot or otherwise, we must have $T_L/T_H \leq Q_L/Q_H$ and thus

$$\eta < 1 - \frac{T_L}{T_H} \quad (\text{for any real engine}) \quad \text{Equation 80.}$$

Thus, any real engine must have an efficiency no higher than a Carnot engine. Note also that “engine” does not necessarily mean something with pistons and cylinders; it refers to **any** device that generates work transfer (shaft work, electrical work, etc.) using heat transfer as the energy source (*i.e.* a *heat engine* in the vernacular of thermodynamics). Another equivalent way of defining a heat engine is a device that converts disorganized energy transfer into organized energy transfer. (Of course, according to the above equation, the heat engine can only convert a portion of the disorganized energy transfer into organized energy transfer, not all of it.)

Figure 25 shows some consequences of the First and Second Laws as applied to heat engines and heat pumps (the black box; what’s inside is irrelevant).

No practical engine operates on a cycle similar to that of the Carnot cycle in which heat is added at constant temperature T_H (sounds weird, adding heat at constant temperature, but it can be done in theory if the temperature difference between the two objects is infinitesimally small...) and rejecting heat at another constant temperature T_L . Some other idealized thermodynamic cycles that more nearly approximate real cycles include

- *Otto Cycle*, which is a model for spark-ignition reciprocating-piston engines like those in most automobiles. The cycle assumes an **ideal gas** with the following processes:
 - Isentropic compression (see page 78) by a **volume** ratio of r
 $r = (\text{initial volume before compression})/(\text{final volume after compression})$
 - Heat addition at the minimum volume with **no change in volume** during the heat addition, and
 - Isentropic expansion by a volume ratio of $1/r$ to get back to the initial volume

The ideal, theoretical efficiency of this cycle is given by

$$\eta = 1 - \frac{1}{r^{\gamma-1}} \quad (\text{ideal Otto cycle}) \quad \text{Equation 81}$$

which satisfies the function tests

- $\eta = 0$ when $r = 1$ (no compression, no net work done; you have a heater, not an engine, in this case)
 - $\eta \rightarrow 1$ as $r \rightarrow \infty$ (efficiency can never exceed 1)
- *Brayton Cycle*, which is a model for gas turbine engines. The cycle assumes an **ideal gas** with the following processes:

- Isentropic compression by a **pressure** ratio of r (note **pressure ratio**, not **volume ratio** here); in this case

$$r = (\text{final pressure after compression})/(\text{initial pressure before compression})$$

- Heat addition at **constant pressure**, and
- Isentropic expansion by a pressure ratio of $1/r$ to get back to the initial pressure

The ideal, theoretical efficiency of this cycle is given by

$$\eta = 1 - \frac{1}{r^{(\gamma-1)/\gamma}} \quad (\text{ideal Brayton cycle}) \quad \text{Equation 82}$$

which satisfies the same function tests as the Otto cycle.

- *Rankine Cycle*, which is a model for steam turbine engines. The cycle assumes
 - Isentropic compression **of liquid (water or whatever fluid)** by a **pressure** ratio of r
 - Heat addition at **constant pressure** until the fluid is in the vapor (gas) state
 - Isentropic expansion of the steam by a pressure ratio of $1/r$ to get back to the initial pressure

There is no simple expression for the efficiency of the Rankine cycle because it does not assume a fluid with a simple equation of state like an ideal gas. Note that there is no difference between the Brayton and Rankine cycles except for the type of fluid used; both assume isentropic compression, constant-pressure heat addition and isentropic expansion back to the starting pressure.

The principle of increasing entropy can also be applied to pure heat transfer. For a device with no work input or output ($W = 0$), in order to satisfy energy conservation, $Q_H = Q_L$. Since the 2nd law requires $-Q_H/T_H + Q_L/T_L \geq 0$, with $Q_H = Q_L$,

$$-1/T_H + 1/T_L \geq 0 \text{ or } T_H \geq T_L \quad (\text{heat transfer with no work transfer})$$

which ensures heat transfer can only occur from a higher temperature to a lower temperature. Note that this not say that heat transfer can never occur from a lower temperature to a higher temperature, but that it cannot occur when there is no work transfer (e.g., as in a refrigerator) or other energy flow.

Following along this same line, one can also consider the case opposite of heat engines, namely refrigerators that obviously do enable heat transfer from low temperature to high temperature. If there is work transfer W into the device, then $Q_H = Q_L + W$ and in this case heat can flow from a lower temperature to a higher temperature if Q_L is sufficiently small. In other words, the work transfer W (which causes no entropy production or loss) decreases the ratio of Q_L/Q_H so that it can be less than T_L/T_H so that $+Q_H/T_H - Q_L/T_L \geq 0$ can be satisfied as required to have entropy production ≥ 0 . (Note that the signs on Q_H and Q_L are reversed compared to the heat engine analysis, since Q_L units of heat are being transferred out of the universe at T_L and Q_H units of heat are being transferred into the universe at T_H .)

What is the best possible performance of a refrigerator? In this case the concept of “efficiency” doesn’t apply since work is an input rather than an output, but one can define a different figure-of-merit called the *coefficient of performance* (COP) = Q_L/W . For the best possible (Carnot cycle in reverse) refrigerator, the COP would be

$$COP = \frac{\text{What you get}}{\text{What you pay for}} = \frac{Q_L}{W} = \frac{Q_H - W}{W} = \frac{Q_H}{W} - 1 = \frac{1}{\eta_{Carnot}} - 1 = \frac{1}{1 - \frac{T_L}{T_H}} - 1 = \frac{T_L}{T_H - T_L}$$

and thus for any “real” refrigerator

$$COP < \frac{T_L}{T_H - T_L} \text{ (refrigerator)} \quad \text{Equation 83.}$$

Note that, as a function test, as T_H approaches T_L , the COP approaches infinity, since no work input ($W = 0$) is required to transfer heat across from low temperature to high temperature when there is zero temperature difference. In other words, a refrigerator doesn’t need any power when the desired temperature of the food inside is the same as the outside temperature.

Note also that a heat pump used to heat homes is the same device as a refrigerator or air conditioner in that heat is transferred from a lower temperature to a higher temperature at the expense of some work input. The only difference is that in a refrigerator, Q_L is the desired heat transfer (from an object, to make it colder than ambient temperature) and Q_H is waste (heat transfer to the surroundings at higher than ambient temperature, which is why your cats love to sleep behind your refrigerator), whereas with a heat pump Q_H is the desired heat transfer (to your living room) and Q_L is waste (heat transfer from the cold outside environment). Because of this, the definition of COP for a heat pump is different from that of a refrigerator. For the best possible (Carnot cycle in reverse) heat pump, the COP would be

$$COP = \frac{\text{What you get}}{\text{What you pay for}} = \frac{Q_H}{W} = \frac{1}{\eta_{Carnot}} = \frac{1}{1 - \frac{T_L}{T_H}} = \frac{T_H}{T_H - T_L}$$

and thus for any “real” heat pump

$$COP < \frac{T_H}{T_H - T_L} \text{ (heat pump)} \quad \text{Equation 84.}$$

The advantage of a heat pump compared to simple electrical heating is that several units of heat transfer (Q_H) can be obtained for one unit of work transfer (W), whereas with simple electrical heating, only one unit of heat transfer is obtained per unit of work transfer. Of course, as the difference between T_H and T_L increases, COP decreases and thus the advantage of the heat pump decreases. Moreover, heat pumps, being functionally equivalent to air conditioners or refrigerators, are far more complicated than simple electrical heaters. For this reason heat pumps are not in widespread use, even in locations where air conditioners are installed and you could use the same device run forwards and backwards for both heating and cooling. (Keep in mind that heat pumps need electrical power whereas heating can also be done with natural gas which costs about ¼ as much for the same energy.)

Heat transfer

The First Law of thermodynamics places restrictions on how energy can be converted from one form to another, and the Second Law places restrictions on the direction which processes may occur, but neither one says anything about *how fast* such processes occur. Here we'll just look at the rates of heat transfer, which is only one piece of the puzzle. We've already talked about rate processes in terms of fluid mechanics, and you know something about dynamics ($F = ma$ applied to a solid body.) If there are chemical reactions, we would need to compute their rates also, but that's beyond the scope of this course.

Heat transfer may occur by one or more of three forms: *conduction*, *convection* or *radiation*, which we'll discuss separately below.

Conduction

Conduction heat transfer occurs in an *immobile* material (*i.e.*, not a moving fluid) due to the vibrations of the molecules within the material. The more rapidly vibrating (warmer) portion of the material induces faster vibrations in the initially cooler part of the material and thus enabling randomly directed kinetic energy to pass through the material. The rate of said heat transfer is described by *Fourier's Law*:

$$\dot{Q} = -kA \frac{\Delta T}{\Delta x} \quad \text{Equation 85}$$

where \dot{Q} is the rate of heat transfer (in Watts or some other unit of power), k is the *thermal conductivity* of the material (not to be confused with Boltzmann's constant!), A is the cross-section area of the material exposed to heat transfer (*i.e.* the area in the direction perpendicular to the direction of the temperature gradient), ΔT is the temperature difference across the material (which would be positive if temperature increases as x increases and negative if temperature decreases as x increases) and Δx is the thickness of the material. ΔT can be specified in either absolute (K or R) or relative ($^{\circ}\text{C}$ or $^{\circ}\text{F}$) units since the addition factor (273 from $^{\circ}\text{C}$ to K, or 460 from $^{\circ}\text{F}$ to R) will cancel out in the $T_H - T_L$ term. Since \dot{Q} is in units of watts, A is m^2 , ΔT is $^{\circ}\text{C}$ or K and Δx is meters, the units of k must be $\text{W}/\text{m}^{\circ}\text{C}$ or equivalently W/mK . Note that the minus sign ensures that heat transfer is positive when ΔT is negative and thus heat must flow from high temperature to low temperature as required by the Second Law of Thermodynamics. Some typical thermal conductivities are given in Table 6. Note that all of these values are approximate because k depends on the temperature and composition of the material. In particular, pure metals have much higher conductivities than alloys (mixtures of metals) because in the case of metals the mobile electrons can transport thermal energy much faster than vibration within the solid structure itself can.

Material	Thermal conductivity (W/m°C)
Air	0.026
Glass wool insulation	0.04
Plastics	0.2 – 0.4
Water	0.6
Glass	1
Silicon dioxide ceramic	2
Steel	20 - 40
Aluminum	200
Copper	400
Diamond	2000

Table 6. Thermal conductivities of some common materials at room temperature

Example. The walls of a house are filled with glass wool insulation. The wall is 4 inches thick. The temperature on the inside wall is 70°F and outside it's a nippy 0°F. The wall is 10 feet high and 20 feet wide.

- a) What is the rate of heat transfer through this wall?

$$\dot{Q} = -kA \frac{\Delta T}{\Delta x} = -\frac{0.04W}{m^{\circ}C} \left[(10ft \times 20ft) \left(\frac{m}{3.281ft} \right)^2 \right] \left[\frac{0^{\circ}F - 70^{\circ}F}{4in - 0in} \frac{1^{\circ}C}{1.8^{\circ}F} \frac{39.37in}{m} \right] = +284W$$

Note that we have defined $x = 0$ as the inner (warmer) wall and $x = 4$ inches as the outer (colder) wall, so $\Delta x = +4$ inches and $\Delta T = 0^{\circ}F - 70^{\circ}F = -70^{\circ}F$. The resulting heat transfer is in the $+x$ direction, *i.e.*, from the inner wall to the outer wall.

- b) If electrical heating is used at a cost of 10 cents per kilowatt-hour, what is the cost to heat this house for 1 day (just on the basis of heat loss through this one wall)?

$$\frac{\$0.12}{kW \text{ hr}} \frac{kW}{1000W} (284W)(24hr) = \$0.82$$

which doesn't seem like much. But the real cost of heating is due to heat loss through windows, which are much thinner and made of materials with much higher k than glass wool insulation.

Convection

Convection is heat transfer due to fluid flow across a surface. It is in general much faster than conduction (immobile material, no fluid flow) because in the case of convection, there is a continuous supply of hot fluid to deliver thermal energy to the cold surface, or of cold fluid to remove thermal energy from the hot surface. The rate of heat transfer by convection is given by

$$\dot{Q} = hA\Delta T = hA(T_{\text{surface}} - T_{\text{fluid}}) \quad \text{Equation 86}$$

where h is the *convective heat transfer coefficient* (units Watts/m²°C or Watts/m²K), A is the **total area of the surface exposed to convective heat transfer** (not the projected area A used in the formulas for drag force in Chapter 6!), T_{surface} is the surface temperature and T_{fluid} is the fluid temperature *far away from the surface*. In general, it is very difficult to compute h because it depends on both fluid flow and conductive heat transfer (from the surface to the fluid adjacent to the surface) and thus involves Fourier's Law coupled to the Navier-Stokes equations. For the purposes of this course I'll just give you a value of h when needed. Some typical values are 10 W/m²°C for buoyant convection in air (when there is no forced flow, just the rising or falling of air due to a temperature difference between a surface and the surrounding air), 100 – 1,000 W/m²°C for turbulent flow of water over a surface, and up to 10,000 W/m²°C for heat transfer to/from boiling water.

Example. Due to a tornado the insulation blew off the wall of the house in the previous example, so now there is a 70°F wall exposed directly to 0°F air. What is the rate of heat transfer now assuming buoyant convection only (i.e. the tornado has passed and the wind is calm) with $h = 10 \text{ W/m}^2\text{°C}$?

$$\dot{Q} = hA(T_{\text{surface}} - T_{\text{fluid}}) = \frac{10W}{m^2\text{°C}} \left[(10\text{ft} \times 20\text{ft}) \left(\frac{m}{3.281\text{ft}} \right)^2 \right] \left[(70\text{°F} - 0\text{°F}) \frac{1\text{°C}}{1.8\text{°F}} \right] = 7225W$$

which is 25 times more than the insulated wall! Note that the heat transfer is in the direction from the (warmer) surface to the (cooler) surrounding fluid as required by the Second Law of Thermodynamics.

Radiation

Radiation heat transfer is heat transfer due to electromagnetic radiation between objects. Radiation what makes a fire feel warm even when you're 10 feet away, i.e. too far for conduction or convection to be significant. The rate of heat transfer between two surfaces at temperatures T_H and T_L is given by

$$\dot{Q} = \sigma \epsilon A (T_H^4 - T_L^4) \quad \text{Equation 87}$$

where σ is the *Stefan-Boltzmann* constant = 5.67×10^{-8} Watts/m²K⁴, ϵ is the *emissivity* of the surface (a dimensionless number between 0 and 1; closer to 1 for opaque, non-reflecting surfaces and closer to 0 for highly polished, reflecting surfaces). Note that *temperatures must be specified in an absolute scale* (i.e. Kelvins, not Celsius) since there is a ()⁴ term and thus the 273 or 460 conversion factor does not simply subtract out as it did with in the case of conduction or convection. In other words, for conduction and convection,

$$(T_H + 273) - (T_L + 273) = T_H - T_L$$

so that either °C or K are acceptable, whereas for radiation

$$(T_H + 273)^4 - (T_L + 273)^4 \neq T_H^4 - T_L^4$$

so only K is acceptable.

Example. For the unfortunate house above with a bare wall exposed to ambient air, what is the rate of heat transfer by radiation? The wall emissivity (ϵ) is 0.5.

$$\begin{aligned}\dot{Q} &= \sigma \epsilon A (T_H^4 - T_L^4) \\ &= \left(5.67 \times 10^{-8} \frac{W}{m^2 K^4} \right) (0.5) \left[(10 \text{ ft} \times 20 \text{ ft}) \left(\frac{m}{3.281 \text{ ft}} \right)^2 \right] \left[\left((70 + 460)R \right)^4 - \left(0 + 460 \right)R^4 \right] \left(\frac{1K}{1.8R} \right)^4 \\ &= 1712W\end{aligned}$$

which is less than convection in this case. But note that since conduction and convection increase linearly with temperature, *radiation increases with temperature to the fourth power, thus at sufficiently high temperature, heat transfer by radiation will always exceed that due to conduction and convection.* Also note that the heat transfer is in the direction from the (warmer) surface to the (cooler) surroundings.

Chapter 8. Written and oral communication

“*The single biggest problem in communication is the illusion that it has taken place.*” – George Bernard Shaw.

The Golden Rule of written technical communication can be stated as follows:

If I didn't already know this subject and were reading this paper (or listening to this presentation) for the first time, would I understand it?

Written papers or reports

1. The usual organization of a paper or report is
 - A. Heading: title, authors, affiliations
 - B. Abstract: explains what was done and what the main conclusions are. **Must be short (a few hundred words at most, depending on the journal requirements), no matter how long and how complicated the paper is.**
 - C. Introduction:
 - i. Explain what your problem is and why it is important.
 - ii. State what is known about the subject.
 - iii. *Complain about what is lacking in the current state of knowledge*
 - iv. *Explain what you will do that is better* (may be in a separate Objectives section).
 - D. Method: experimental apparatus, numerical model, whatever
 - E. Results: what you found and how it compares with previous works
 - F. Conclusions: what you learned
 - G. Future work (optional)
 - H. Acknowledgements (optional) – organizations that funded the work and/or people who helped but wasn't included on the author list (e.g. people who gave advice but didn't participate in the work itself, technical support, computer programmers.)

Almost all novice writers (and many experienced writers) fail in two ways when organizing a paper. First, they fail to state clearly their **objectives** (what they are trying to learn) and their **message** or **conclusions** (what they found). Any piece of information that does not help to support the message doesn't belong in the paper (unless it helps to show what isn't certain about the conclusions.) For each paragraph, each picture, etc., ask yourself 2 questions:

1. What is the message I am trying to get across? and
2. Does this picture or text do that?

In particular, students like to report on everything they did that went wrong before they got to the final results, just to show that they worked hard even if they didn't accomplish much. This may be ok for a lab report in a class, but for a technical paper, nobody wants to know that the first 7 voltmeters you tried didn't work because someone spilled coffee on them. (Worst line ever: “We didn't finish the project, but we have **all the parts** ...” Which means you have some parts that might be useful; you never know if you have all of them until after the project is done.)

2. Every symbol in the text
 - A. is defined in a Nomenclature section (preferred) or defined at its first appearance in the text (often you have to do it this way because of space limitations, but it's annoying to

have to scan through a long document to find out what α is.) Hopefully you know by now how important it is to define your symbols.

3. Every equation that is set apart from the text
 - A. has a number
 - B. has all of its symbols defined if not already or defined in a Nomenclature section (if used)

4. Every word
 - A. is spell-checked
 - B. is defined the first time it is used if it is a “buzz word” or acronym. Example: “Many engineers use an excessive number of Three Letter Acronyms (TLAs).”

5. Every figure
 - A. is assigned a number – “Figure 1,” “Figure 2,” etc.
 - B. is referred to in the text – no “orphan” figures!
 - C. is referred to as “Figure x” if it appears at the beginning of a sentence, otherwise it is called “Fig. x”
 - D. has a sensible scale on each axis (i.e. 0, 1, 2, 3; not -0.37, 0.15, 0.67)
 - E. When showing multiple plots of similar results, use the same scales. For example, if showing the burning velocities of methane-air and propane-air mixtures as a function of fuel concentration on separate plots, use the same scale for burning velocity on each unless they have drastically different ranges.
 - F. Uses a logarithmic scale if a large numerical range of data (more than one decade) is covered (otherwise all the data having low numerical values are squashed together)
 - G. has the units defined on each axis
 - H. has a caption (in addition to its figure number)
 - I. has all relevant conditions (pressure, temperature, whatever is important) stated on the plot or in the caption
 - J. has all plot symbols (squares, circles, filled or open, ...) and curves (solid, dotted, dashed,..) defined either in a legend box within the figure (preferred method) or in the caption
 - K. Does not have a lot of “white space”
 - L. if it is a picture, it has a scale on the picture or has a statement in the caption such as “field of view is xxx cm by yyy cm” or has some object of easily identifiable scale (a person, coin, etc.) in the picture
 - M. must be readable - caution on pictures!!!**

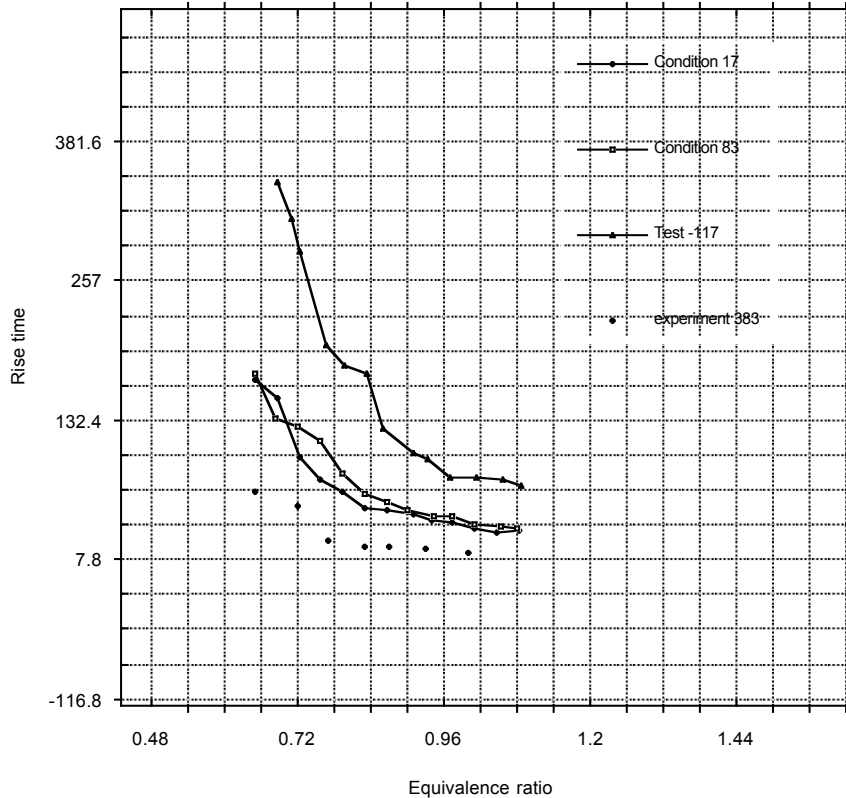

Figure 26a. Terrible figure.

Figure 26a shows a terrible figure with many common mistakes. What’s wrong?

- The scales on each axis are terrible – weird numbers, not 1, 2, 3, ...
- Units are not defined on the vertical axis (Seconds? Nanoseconds? Millenia?)
- The plot symbols are defined using meaningless notation (“Condition 17” means nothing to the reader.)
- There is a tremendous amount of “white space”
- Most of the data squashed together because a linear scale was used - the scale has to be large enough to cover the large values of rise time in “Test –117”, which goes up to 300, but most of the data is in the 10 – 50 range
- There are tick marks inside, outside, all over the place (I prefer tick marks on the inside only). Also, the major and minor tick marks are the same length so it’s hard to distinguish between them.
- The plot symbols are too small to see
- The numbers are too small to read
- All of the grid lines make it hard to read the data and legend. (I don’t like grids at all, they clutter the figure – if someone really wants to pick points off your graph, they can draw their own grid lines or ask you to email the data file to you.)
- There are ugly looking jagged lines connecting the data points (rather than a smoothed curve)

- Three data sets have lines connecting them, whereas the fourth does not (is there something different about the fourth data set that makes it ineligible for connecting lines?)
- The axes and tick marks are too thin

A big part of the problem is that most people just let their plotting program make bad plots using all the default settings, and somehow try to rationalize that still a good plot. Figure 26b shows a reasonable figure presenting exactly the same data as Figure 26a.

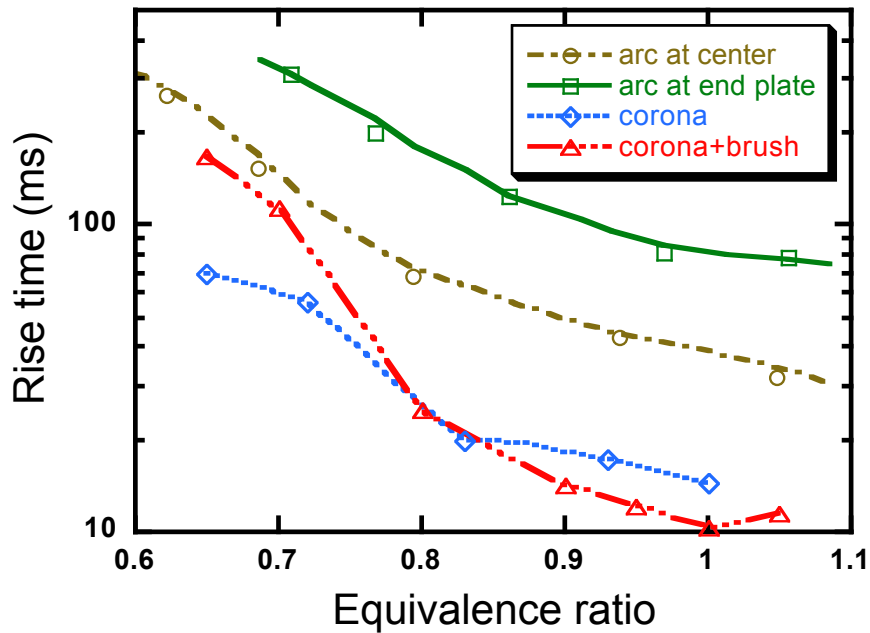

Figure 26b. Reasonable figure presenting same data as in Figure 26a.

- Every reference cited in the text
 - appears in the reference section
 - is a plain number (i.e. 11, 12, 13; not 11, 11a, 11b) or follow the Harvard system (e.g. Smith and Jones, 1953) depending on the instructions to authors
 - if a number, may be superscript or in [brackets] or (parenthesis) depending on the instructions to authors
- Every reference in the reference section
 - is called out in the text; it is not acceptable to simply have a list of references at the end of a document without referring them in the text so that the reader knows what information was used from that reference
 - has the journal name or book title (journal titles may or may not be abbreviated depending on the instructions to authors)
 - has the page number (may be just the first page of the article or inclusive pages depending on the instructions to authors)
 - has the journal issue number (if a journal article)
 - has the publisher (if a book)
 - has the year of publication
 - may or may not have the title of the article depending on the instructions to authors

Bottom line: ask yourself, *if I were reading this paper for the first time, and I were not already aware of the results, would I understand this paper???*

Oral presentations

Most of the rules listed above for written presentations apply to oral presentations. In particular:

1. Organization
 - A. Title page title, authors, affiliations, acknowledgements (optional) (no abstract)
 - B. Introduction:
 - i. Explain what your problem is and why it is important.
 - ii. State what is known about the subject.
 - iii. *Complain about what is lacking in the current state of knowledge*
 - iv. *Explain what you will do that is better* (may be in a separate Objectives section).
 - C. Method: experimental apparatus, numerical model, whatever
 - D. Results: what you found and how it compares with previous works
 - E. Conclusions: what you learned
 - F. Future work (optional)
2. Every symbol, buzz word, acronym, etc. must be defined the first time it is used (no Nomenclature section)
3. Every equation is numbered
4. All of the rules for figures and pictures still apply
5. References may be mentioned, especially if there are key works that your work builds upon or refutes, but are not numbered

There are also special rules for presentations:

6. Use a laptop-based powerpoint presentation. This makes it much easier to combine/split previous presentations, add color, animations, sound effects, etc. But the most valuable aspect is probably that it allows you make last-minute changes. Also it is useful because then you can email the presentation to interested people, or post it on your website.
7. Do not use 5-point font! Reduce the amount of material presented and use big fonts! Make sure everything is legible. *A good rule of thumb is that if the slide is printed on standard 8.5" x 11" paper, you should be able to put the page on the floor and read everything on the page while standing up and looking down at the page.*
8. Use color. The human eye is much more sensitive to variations in color than shades of gray. Key words can be given emphasis using colors. Plots in journals usually have to be in black only, but in a presentation you can use colors to make it easier for the audience to

distinguish between different data sets (as in Figure 26b above) that it is to distinguish between data sets by looking at the different symbols.

9. Include movies. Why limit yourself to static presentations when you have the power of a computer? A picture is worth a thousand words, and a movie is worth a thousand pictures.

10. Address the audience. Say things like, "this plot shows **you** the effect of x on y..." rather than "this plot shows the effect of x on y..."

11. Keep reminding the audience of your nomenclature. That is, if you show an equation

$$E = mc^2$$

don't say "this equation shows that eee equals emm cee squared," (the audience can already see that). Instead say, "this equation shows that the energy of a substance is equal to its mass times the speed of light squared" (the audience has forgotten your definitions of E, m and c that you gave 12 slides back).

Bottom line: ask yourself, *if I were in the audience listening to this presentation for the first time, would I understand it???*

Appendix A. Design projects

Generic information about the design projects

How to run a meeting (PDR's philosophy...)

Your design projects will require group meetings. Every meeting must have three items, all in writing:

- *An agenda.* What is it that needs to be discussed at the meeting? If it isn't written down, some items will be forgotten or will get dropped as the meeting runs over its time limit, so a written agenda is usually needed. Sometimes everyone knows the agenda items (as in a weekly meeting, for example), or the list of things to be discussed is very short, so a written agenda isn't needed
- *Minutes.* What was said and what was decided at the meeting? There definitely needs to be a permanent record of this, because you WON'T remember a week later what was said or what was decided. (More likely, you will remember but your recollection will be different from everyone else's.)
- *Action items.* Who will do what as a result of the meeting? When is it needed? What will people do that is different than what they would have done without the meeting? Think about that last question – *if no one is going to do anything differently as a result of the meeting, what was the purpose of the meeting?*

If you don't have all three of these items, then you have to ask yourself, why did you meet? What were you trying to accomplish by meeting? Was it a meeting or just a party, seminar, etc.?

Many groups choose to start an online page using their favorite social media platform just for their project; this is acceptable and in fact encouraged; clear, swift and accurate communication is of importance even in small projects like this one and in large, real-world engineering projects it is absolutely essential.

Suggestions for the written report

The report should include

1. Cover page
 - Name of your project. I do succumb to enjoying project titles with a twist, e.g. “Stressed Out” for the 3D printed bridge project. It breaks up the monotony of grading all those reports!
 - Your group number
 - Group members
 - Catchy picture
 - Grading table (project-specific table given for each project)
2. Table of contents
3. Body of the report including
 - a) Statement of objective(s)

- b) Drawings of preliminary design concepts (hardware and/or software) and critiques of these designs
 - c) Test data for preliminary designs
 - d) Explanation of why you chose your final design
 - e) Construction of your device
 - f) Results of the “official” test
 - g) What you would do differently if you built another device
4. Optional appendices(s) including (these may be incorporated into the body of the report rather than an appendix if you feel it improves the organization and readability of the report.)
- a) Meetings: agenda, minutes, action items
 - b) Email exchanges
 - c) Pictures of your test apparatus, construction and the final device
 - d) Anything else you think is appropriate

General comments about the reports:

- Printouts look a lot nicer than handwritten notes. I really can't do any writing by hand any more; my handwriting is illegible even to myself and even worse, my thought processes have become so jumpy I can't write anything, even one paragraph, from start to finish.
- Pictures are also nice. I think a picture is worth way more than 1000 words, because who wants to read 1000 words? (For PowerPoint presentations, I have a corollary - a video is worth a thousand pictures.) But, a collage of pictures at the end of the report isn't very useful. Include the pictures in the body of the report, and **every picture needs a caption** so the reader knows what the picture shows and what the reader is supposed to learn from looking at it.
- Pictures are nice but illegible hand drawings are not. If you're going to use hand drawings:
 - Make them legible
 - Don't draw on lined paper that has writing on the back
 - Use a proper scan, not a camera phone image
- Make sure throughout that whatever meetings, background research, testing, etc. you do, you are focused on the specific objectives of the project. For example, in the bridge project, just stating that such-and-such an idea is a good one because it should make the bridge strong is not very useful. Remember that the objective in that case was a high stress to weight ratio, not just low stress, so everything you do should revolve around that fact.
- Just showing sketches of ideas isn't terribly useful unless you then explain which ideas you embraced, which you rejected and why. (In a more formal setting you would document all the team members opinions and ideas, since this may lead to patents later on.) Also, just showing a bunch of stuff downloaded from the internet to pad the report isn't useful. Think of a report as if you were making a movie - you have a story to tell, you want to tell it in the most compelling way possible, and anything that doesn't help tell the story should be left on the cutting room floor.
- **MOST IMPORTANT POINT.** What convinces me more than anything else that (independent of the outcome of the contest) you are serious about the project is the TESTING part. Think about it - if you don't test anything, it says you're just going to accept whatever the first attempt at the design/build/test cycle gives you. And if you don't document the testing, did you really do any testing? (A variation of the proverbial question, "if a tree fell in the forest and no one heard it, did the tree make a sound?") So presenting test results is **HIGHLY ENCOURAGED**. Test results can be from either physical testing (*e.g.*, of sample 3D printed beams) or modeling (*e.g.* SolidWorks stress analysis of your bridge). Testing for the King of the Hill project might

include the time required for your vehicle to reach the top under different configurations (weight, wheel placement, battery type, gear ratio, etc.)

- Reference your statements. For example, if you say, “our research has shown that PLA (polyacetic acid, the standard 3D printing material) is stronger in tension than compression,” state what test you did or what the source is from which you obtained that information. (Note: a comment by Joe12345 on blogger.com doesn’t qualify as a legitimate source.)
- Make backup copies of your data. All storage devices (even those in the cloud) have anxiety and deadline sensors and are pre-programmed to crash when your anxiety level is highest or the deadline is nearest. Store your data in multiple locations so that there are no “single-point failures” regarding data security.

King of the Hill

Objective

The goal of this contest is to design and construct a vehicle that can climb a “hill” under its own power, stop at the top of the hill and defend its position against an opposing vehicle coming up from the other side of the hill. The contest will be held in the E-quad during class time on **October 12, 2021**.

The “hill” will be represented by two 5 foot long x 1 foot wide ramps separated by a 1 foot x 1 foot mesa at the top. The hill altitude is 33 inches from base to summit. This is a very steep hill, but the ramps are covered with a non-slip material like you might find in a bathtub. **Experience has shown that the most important thing is to get your vehicle to the top.** Many vehicles fail because they don’t have enough torque (*i.e.*, the wheels or tracks don’t move) or traction (*i.e.*, the wheels or tracks spin but the vehicle doesn’t move) to climb the steep ramp. Offensive or defensive tactics for use on top of the ramp are of secondary importance. I **strongly** recommend you **don’t** buy a radio-controlled racecar and cannibalize it; almost all of them are designed for speed, not hill-climbing ability. However, experience also shows that “possession is 9/10 of the law” and usually the vehicle that reaches the top of the ramp first wins because it’s difficult for a moving vehicle to displace a stationary one. So, you’ll have to decide on some optimal combination of speed, torque, traction, etc.

Some YouTube™ videos of previous competitions are available; search “USC AME 101 King of the Hill”.

A suggested source of motors, gearboxes, battery boxes, tracks, etc. is <http://www.pololu.com>, particularly the products made by Tamiya, for example these gearboxes: <http://www.pololu.com/product/61> (dual motors, enables steering) or <http://www.pololu.com/product/74> (single motor, 6-speeds, pick your favorite. A complete chassis + gearbox kit is also available: <https://www.pololu.com/product/1551>. Tilt switches to shut your vehicle off when it reaches the top of the hill can be obtained from many sources. Keep in mind that there are tilt **sensors** (like your iPhone has) which can carry almost no current, you need a tilt **switch**. Check the specifications of your switch to make sure it can carry the current your motor draws. (How much current does your motor draw? Read the motor specifications! Or better still, test them in the lab!) A fairly complete kit (motor, gearbox, switch, treads, chassis) is the “Tamiya 70108 Tracked Vehicle Chassis Kit” (<https://www.tamiyausa.com/shop/educational-construction/tracked-vehicle-chassis-kit/>).

Because you WILL be using microcontrollers in your engineering career, I strongly encourage you to use an Arduino, Raspberry Pi, or similar system. By “strongly encourage” I mean that **you’ll score an additional 10 points on your project report just for using a microcontroller-based vehicle instead of one with just a plain ol’ fashioned motor, battery, and tilt switch.** Here are some pointers for using the Arduino system:

1. Power
 - a) A new AA battery supplies about 1.6 Volts when nothing is connected to it (that is, no current draw) but is not a perfect 1.6 Volt source. It has an internal resistance of typically 0.25 ohms. That means if you’re drawing 0.5 amps of current, there will be a voltage drop of $(0.5 \text{ A})(0.25 \Omega) = 0.125\text{V}$, so the battery voltage will drop to $1.6\text{V} - 0.125\text{V} = 1.475\text{V}$.
 - b) The typical motors used in Tamiya kits draw about 0.2 amps with nothing connected to the motor to slow it down, about 2 amps (2A) at stall conditions (so much load

that the motor can't spin at all) and about 0.5A at the typical operating condition climbing a ramp. Consequently, two AA batteries provide about $2 \times 1.475\text{V} = 2.95\text{V}$ at KOTH conditions.

- c) The Arduino board will cease to function with a supply voltage below about 3V, so it may operate with two AA batteries under no load (3.2V) but stop when the load of the motor is applied (2.95V).
- d) The solution to the problem mentioned in (c) is to use a “boost converter” that converts the battery voltage to a constant 5 volts. Here is one example: <https://www.amazon.com/Pololu-Step-Up-Step-Down-Voltage-Regulator/dp/B01M4KIS7K> (below, left). Connect the +In and -In terminals to your battery and the +Out and -Out of this boost converter **only** to the Arduino, not to your motor(s).



2. The Arduino output pins can supply at most about 20 milliamps (0.02 A) of current. They cannot drive your 0.5A motors directly. You need to use a relay, a device that switches a large current (to drive the motors) using a smaller current (from the Arduino). Here's an example of a relay board designed to be compatible with an Arduino: <https://www.amazon.com/SMAKN%C2%AE-Active-Channel-Arduino-Raspberry/dp/B00VH8926C> (above, middle).
3. You'll also need a tilt sensor. A popular one for the Arduino is this unit: <https://www.amazon.com/MPU-6050-MPU6050-Accelerometer-Gyroscope-Converter/dp/B008BOPN40> (above, right). The linked page has instructions for how to connect it to the Arduino.
4. If you think this is too much development/learning/programming effort for the KoTH project, I don't blame you. **However** ... just because you're majoring in Mechanical or Aerospace Engineering, don't think you can get away without knowing some basic electronics and programming skills. You **will** be using programmable controllers during your career. Believe me.

Time will be scheduled in BHE 310 for groups to use the laboratory facilities and tools for making and testing their vehicles. Also, the “hill” may be inspected and test runs performed at that time. The lab gets VERY crowded on the last work day! I **strongly** recommend that you do at least some of your building and testing during the earlier work days. The rules for using the BHE 310 lab are as follows:

- You can only work in the BHE 310 lab after you've completed the training given during the 3rd and 4th weeks of classes (if you didn't get the training during one of the scheduled times, you're out of luck and can't work in the lab.)

- You can work in the BHE 310 lab during scheduled work hours, and in principle other times when it doesn't conflict with other classes, but in Fall semesters the BHE lab is heavily booked with classes most days. The ramps are available for test runs any time the BHE building is open. The scheduled days are as follows **(1 - 4 pm only each day)**:
 - Tuesday, Sept. 28 and Friday, Oct. 1
 - Tuesday, Oct. 5 and Friday, Oct. 8
- **Closed-toed shoes, long pants and safety goggles must be worn in BHE 310 at all times.**
- Basic hand tools are available (screwdrivers, pliers, wire cutters, etc.) but put the tools back where you found them when you're done!
- Wire, solder, tape, glue etc. are available in BHE 310. Some bins of materials (wood, aluminum, plexiglass, etc.) will be available but there is no guarantee that any particular material you need in any particular size you need is in those bins. **DO NOT** use any materials in anyplace other than a bin labeled as "scrap"!
- You can **only** use the machine tools (hand drill, band saw, belt sander, soldering, etc.) **that you have been trained to use.** If you need to use any machines you haven't been trained on, Rod or one of his assistants must train you before you use it.

Alternatively, you can work on your projects in the Baum Family Maker Space. For access to BFMS facilities, see <https://viterbiundergrad.usc.edu/bfms/operations/>. Training is required; currently such training can be obtained on a walk-in basis (no appointment required) at 5:00 pm every weekday. The initial familiarization training is 1 hour long. **This BFMS training is entirely different from the BHE 310 training and training in one space does not qualify you to work in the other space.** The current BFMS hours are Monday - Friday 11:00 am to 10:00 pm and Saturdays 10:00 am to 6:00 pm. Once you've been trained, you can come in any time during those hours to use the space and tools. Additional training is required to use the more advanced machinery.

Design rules

1. The vehicle must be completely autonomous. No remote power, control wires or wireless remote-control links are allowed.
2. The vehicle's exterior dimensions at the start of each run must not extend beyond the sides of an imaginary cube 1 foot on a side. A device, such as a ram, may extend beyond this limit once activated, but cannot be activated before the start of the run.
3. The vehicle's **total** mass must not exceed 1 kg.
4. The vehicle can start either on the ramp or at the base, on flat ground, your choice. The back of your vehicle must be even with the bottom of the ramp (which means that the front of your car cannot be more than 1 foot up the ramp).
5. The vehicle must be started by **one single** activation device (e.g., a switch or mechanical release) on the vehicle. Team members may not activate any device before the start of the contest and the vehicles may not have their "motors" running before the start. A team member will place the vehicle on the ramp and a **"contest official," not a team member, will start the vehicle,** so you must have a simple way to activate the vehicle.
6. The vehicle can be powered by the following energy sources only, either individually or combined (but still only one single activation device is allowed for all energy storage devices combined, and this activation device can only be used at the start of the contest). Note that these energy sources can be used for propulsion, offensive weaponry, or defensive purposes.

- **Batteries** – limited to 2 AA batteries. *Experience has shown that all AA batteries come equipped with anxiety sensors and will run out just before or during the contest. Use fresh batteries at the start of the contest and bring extras.*
 - **Mousetraps** having a maximum spring size of 5 mm outside diameter x 5 cm long (use as many as you want). This basically corresponds to a standard mouse trap; the specifications preclude the use of rat traps. These are typically used for “offensive weapons” but can be used for propulsion as well if you wish.
 - **Solar panels.** Solar panels may be used to augment the battery power, but there’s no guarantee it will be sunny on contest day! There are no restrictions on the number or size of panels other than those required by rules 2 and 3 above.
7. While it shouldn’t be necessary to say so in view of rule 6, just for completeness here it is. *The vehicle may not use fuels, explosives, compressed gases, “general purpose heat sources” or any dangerous/hazardous materials.* Also, if batteries are used, they may not be used for a “thermal protection device” (*i.e.*, a device that attempts to set the opposing vehicle on fire.) If in doubt, ask PDR what is/is not acceptable.
 8. Prior to the start of the competition, vehicles will be measured and weighed to ensure compliance with size and mass limits. If the vehicle is modified in any way during the course of the competition, it will be reweighed and remeasured.
 9. The vehicle must run within the 1-foot-wide track. The vehicle may not run on top of the guide rails, but parts of the vehicle may hang over the guardrail.

The contest

1. Vehicles will compete in a 5- or 6-round “Swiss system tournament” similar to that typically used in chess contests (see http://en.wikipedia.org/wiki/Swiss_system_tournament for example) so that every team will participate in the same number of rounds. Modifications to the vehicle are permitted between (but obviously not during) runs.
2. Contest schedule and current standings can be viewed in real time at <http://www.challenge.com/koth2021>.
3. The contest will be held on **Tuesday October 12** at 8:30 AM (*i.e.*, during class time) in the E-quad. Since many of you have classes during the time block (8:00 am – 9:30 am or 9:30 am – 11:00 am) when you don’t have AME 101, your group may have to staff the contest in shifts.
4. Teams may inspect the ramps before the contest and ask for modifications if they believe the ramps are not level, have undesirable obstacles, etc.
5. The order of the 1-on-1 contests will be selected at random and published in advance. If you are not ready at the time of your event, your team will be disqualified for that specific 1-on-1 contest. **Rigid adherence to schedule is necessary to conduct all 50+ contests during the available time. After the previous contest is completed, you will have 1.5 minutes to ready your vehicle for the event.**
6. To ensure fairness, the vehicles will be started by an “impartial” judge, not a team member.
7. Vehicles will be given 30 seconds to climb to the top of the hill and compete for possession of the hill. They will start at the bottom of the ramp, on the sloped part, rather than on the flat ground at the base of the ramp. It is possible that a vehicle may not make it all the way to the top or may travel across the top to the other side. **At the end of the 30 second period, the vehicle whose farthest point is closest (in 3 dimensions) to the center of the top mesa will be declared the winner of that particular contest.** Any parts such as

telescoping probes, anchors, oil slicks or projectiles count as part of the vehicle. I will make exceptions if in my judgment a part unintentionally breaks off; that won't count as part of the vehicle.

8. If at the end of the contest one vehicle is off the ramp and another is on the ramp, then the vehicle on the ramp wins, even if the other vehicle is closer to the top mesa.
9. If at the end of the contest the judges cannot declare a clear winner (because the difference in distances is very small), the contest will be repeated.
10. It is entirely acceptable (in fact it's really the whole point of the contest) to incorporate means to remove the opposing vehicle from the top of the hill, as well as defensive measures to prevent your vehicle from being removed from the top of the hill and/or being damaged by the opposing vehicle.
11. Project reports will be due on **Monday, October 25, at 4:00 pm in OHE 400.**

Organization and grading

You will work in teams of 4 or 5 people, assigned at random, nominally with 2 or 3 people from each section of the class. Each team must keep a report of their work. The report will be the primary means of grading the projects (2/3). **Remember, you'll get 10 extra points on the report score for using an Arduino or other microcontroller system for your vehicle.** Your level of success in the competition also counts (1/3) according to the formula:

$$\text{Competition score} = 50 * (N-P)/(N-1) + 50$$

where P is your place at the end of the Swiss tournament and N is the total number of teams competing. So even the last place team (N = P) gets 50% on the competition score. Also, the report/documentation score counts more than the competition score; in other words, more weight is given to the process than the result, which is just the opposite of how life really works where you're judged 100% on the result and 0% on the process.

Please add this table to your cover page:

Organization	/20
Documentation	/30
Testing	/25
Lessons learned	/25
TOTAL	/100

The report grading will be as follows:

(20 points) Organization/presentation

- Structure of report
- Writing style
- Clarity of figures
- Captions on figures

(30 points) Documenting the development process

- Focused on objectives
- Logic flow of development process

- Documenting meetings
- Justification of statements

(25 points) Testing your vehicles and control programs (if using Arduino or other microcontroller)

(25 points) Lessons learned - what would you do differently if you had to do it all over again?

The grading is not like an exam where you start at 0 and add points or start at 100 and remove points. The project reports start at 75 for an “average” report and points are added or subtract from there. So, getting a score of 75 doesn’t mean you lost 25 points, it means the report was average in our assessment. And, as advertised, you’ll get an extra 10 points on the report for having used an Arduino-controlled car on competition day for at least one contest, regardless of your performance in the contest.

Arduino Cars

Objective

The goal of this contest is to build and program an Arduino vehicle that can autonomously follow a line, avoid obstacles, and similar tasks. You will work in groups of 5, assigned at random, to develop these capabilities. The contest will be held virtually; you will submit a video of your group's vehicle's performance no later than **October 26, 2020**.

Design rules

1. The vehicle required is the "Freenove 4WD Car Kit" available on Amazon:

<https://www.amazon.com/gp/product/B07YBQ73CH>

It is not technically an Arduino, but it is Arduino-compatible. This kit has 4 independently controllable motors (1 per wheel), a line-follow sensor and an ultrasonic proximity sensor (for obstacle avoidance.)

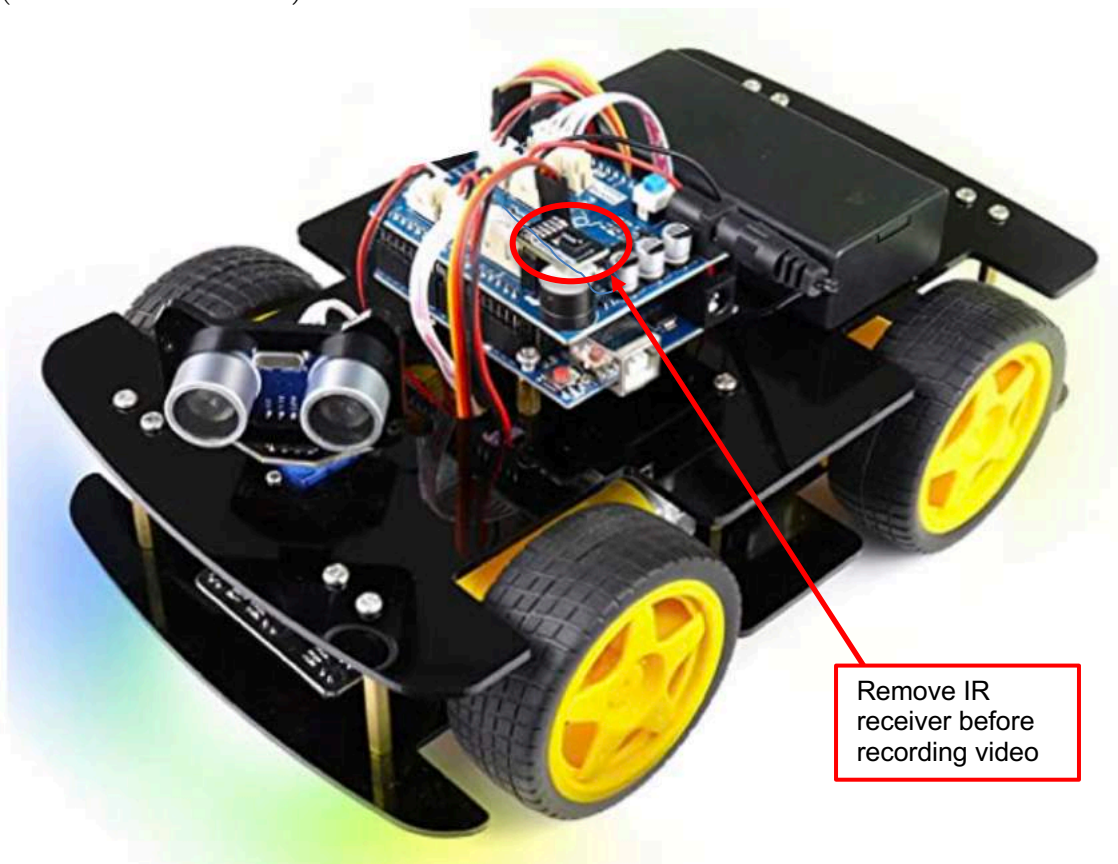

2. The vehicle must be completely autonomous. No remote power, control wires or wireless IR or RF remote-control links are allowed. Because of this, you can get the cheaper version without the RF remote unless you want the RF remote capability for some other future project (note that I removed the RF remote transmitter features in the above picture and showed where the IR receiver is located.)

3. The vehicle can be powered only by the two 18650 batteries specified for the car kit which are not included. Amazon sells them, but because they are used in vaping devices you may not be able to buy them as a stand-alone product. You can, however, buy them as part of a flashlight kit; just search “18650 flashlight” and get a kit with at least 4 batteries (2 to use and 2 to charge at any one time) and a charger; cost is around \$20. An adult (over 21) can buy them in person at smoke shops. Also, if you have a spare Tesla lying around, there are 7,104 of these batteries inside a Model S with the 85 kWh battery pack.
4. Since the groups will not be able to interact in person, each student should buy their own kit. With your group you will share construction tips and software routines for various tasks, compare their effectiveness, and pick the best one for your final competition.
5. This kit cannot be shipped to some countries. If this is the case, you can buy a kit that is similar hardware-wise which is available in your country. There may be an issue that the software is different and not compatible with the “standard” kit. If so, you'll still be able to build and test your car and contribute to your group in terms of ideas for the competition, but not actually contribute software to it.

There are 4 separate tasks; details are posted on Piazza:

1. A simple follow-the-line type of course just to show that you have built the car successfully and it can perform one of the built-in tasks (30% of the performance score)
2. A “slalom” course (30% of the performance score)
3. A “Figure-8” speed course (30% of the performance score)
4. Any “freestyle” “silly pet tricks” etc. type of routine (10% of the performance score)

The contest

1. You will submit a set of videos of your vehicle’s performance no later than **Monday, October 26, 2020**. Only one video per group can be submitted; the group can choose any combination of the members’ vehicles for the final video. (Having 5 people per group enables voting, if needed, that would be problematic with a 4-person group.)
2. At the beginning of the video, you must show that your IR module (which comes pre-installed, on top of the expansion board, below left) and Bluetooth module (which comes not pre-installed, below right) have been removed.

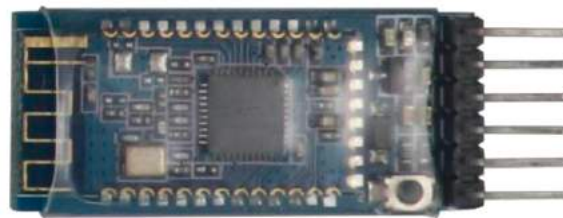
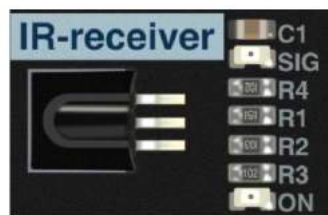

3. Project reports will be due on **Monday, October 26, 2020**.

Organization and grading

You will work in teams of 5 people, assigned at random. Each team will keep a report of their work. The report will count for half of the project grade and your level of success in the competition accounts half according.

The grading rubric for the project reports will be as follows:

(20 points) Organization/presentation

- Structure of report
- Writing style
- Clarity of figures
- Captions on figures

(30 points) Documenting the development process

- Focused on objectives
- Logic flow of development process
- Documenting meetings
- Justification of statements

(30 points) Testing your vehicles and control programs

(20 points) Lessons learned - what would you do differently if you had to do it all over again?

Add this table to your cover page:

Organization	/20
Documentation	/30
Testing	/30
Lessons learned	/20
Total	/100

The grading is not like an exam where you start at 0 and add points or start at 100 and remove points. The project reports start at 75 as an “average” report and points are added or subtract from there. So, getting a score of 75 doesn’t mean you lost 25 points, it means the report was average in our assessment.

3D-Printed Bridge

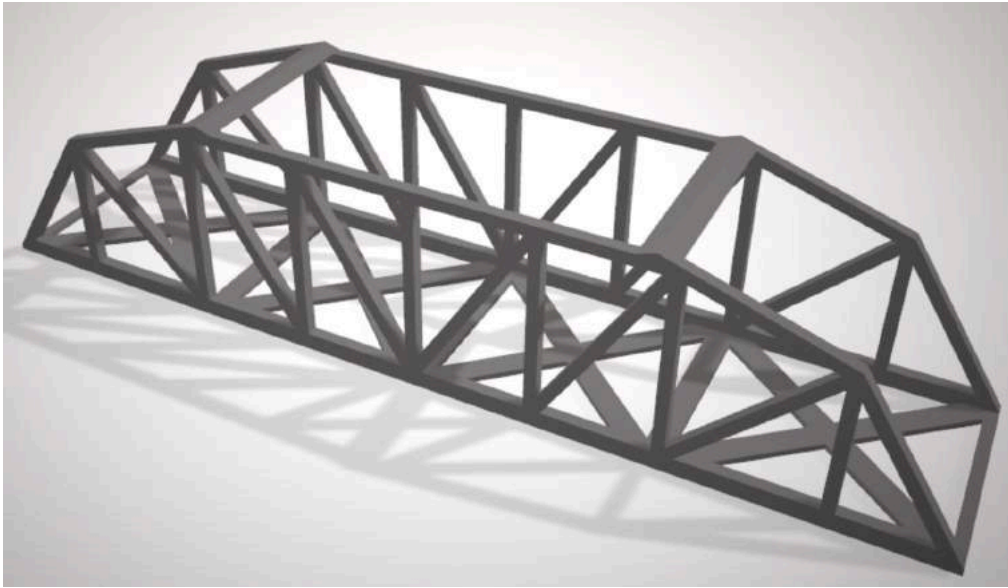

The goal of this project is to design, construct and test (to failure) a 3D-printed bridge made from Polylactic Acid (PLA). The contest specifications are chosen to simulate those of a “real” bridge as closely as practical. Your score on the performance part of the project is based entirely on how much weight your bridge holds before failure.

You will work in teams of 4 or 5 people, assigned at random. Each team will keep a report of their work. Keep in mind that “real” engineered systems always start with a statement of specifications, followed by brainstorming, then analysis, construction, testing and finally evaluation of the performance of the final product. So, your report should reflect “real” engineering practice.

Rules:

1. The **only** construction material allowed is PLA, 3D printed as one continuous part. **No other materials are allowed.** The final bridge will be printed by us to ensure a “level

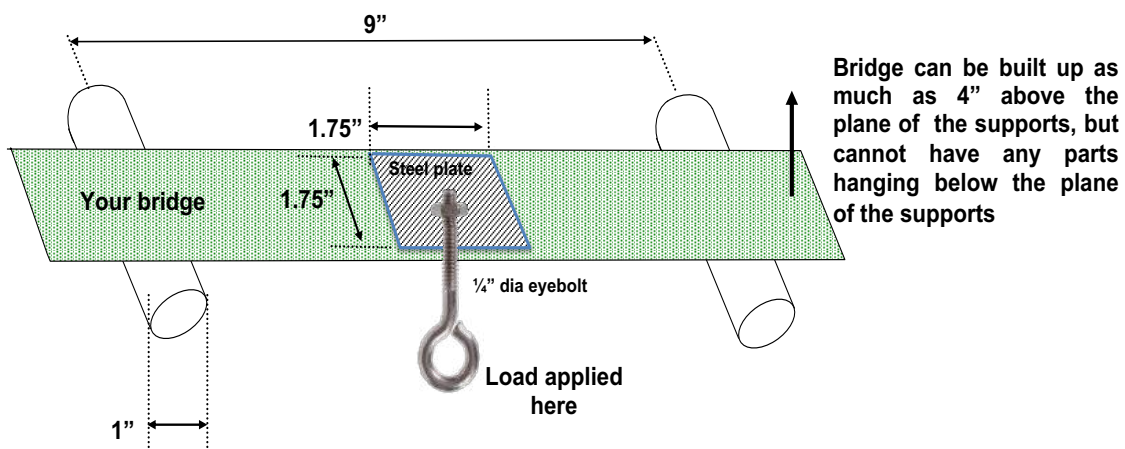

Figure 27. Diagram of bridge testing apparatus

playing field” for the teams.

2. Your bridge must weigh **no more than 40 grams** (I suppose I should say “grams force”). There is no bonus for having a bridge lighter than 40 grams but if your bridge is overweight, the “official” weight your bridge held will be reduced according to the formula:

$$\text{Weight (official)} = \text{Weight (actual)} \times (40 \text{ g} / \text{Bridge weight})^2$$

In other words, you will be penalized not just linearly, but in proportion to the square of how much you’re overweight.

3. The bridge must be able to span a gap of 9 inches between two steel half-rounds, each 1 inch in diameter (see Figure 27 and Figure 28). The bridge cannot have any structure below the plane of the top of the half-rounds. Loads will be applied by 1.75 inch x 1.75 inch steel plate fitted with a 1/4” diameter eyebolt and slowly pulling down on the eyebolts until the bridge fails. The application plane for this steel plate must be no more than 4 mm above “ground level” (defined as the plane passing through the tops of the two support half-rounds); in other words, your support underneath the plate must be no thicker than 4 mm as measured from the bottom of your bridge.
4. The maximum length of your bridge is 9.75” and the maximum width is 2.5”.
5. The minimum printed feature size is **2 mm in the x, y and z directions**, with **100% infill**.
6. If you are using a truss bridge, the bridge must have an open area (simulating a roadbed for trains) **2 inches wide and 2 inches tall**. A block 2” x 2” x 12”, oriented with the bottom plane parallel to the ground, will be pushed through your bridge to confirm this. This block must pass through at an elevation no higher than 4 mm above the bottom surface of your bridge.
7. No part of the bridge may be more than 4” above the lowest part.
8. You’ll need a hole in the center of the roadbed 5/16” in diameter to allow the eyebolt to pass through and connect to the loading plate.
9. We will print and test **one practice bridge per group** before the final bridge. Send your .stl files to ame101f21 at gmail dot com. The deadlines are
 - o Practice bridge: November 22, 2021, 9:00 am
 - o Final bridge: December 2, 2021, 9:00 am
10. You are welcome to print and test as many additional bridge designs as you wish using any 3D printing facilities you have access to and test them in BHE 310.

Testing

1. Testing schedule
 - o Practice bridge: November 29, 2021, 1:00 pm, in BHE 310
 - o Final bridge: Tuesday, December 7, 2021, 9:00 am in the E-Quad
2. To maximize your score, just before the test, provide us with a specific prediction about your bridge’s failure load, point of failure, and deformation at failure. We don’t expect that the agreement will be very good (though sometimes it is surprisingly good) and having a poor agreement won’t hurt your report score, but if the agreement isn’t good you should list some possible reasons for the discrepancy (*i.e.*, what happens in reality that isn’t modeled by SolidWorks FEA?)
3. You will receive a high-speed video of your bridge failure and data on applied load vs. displacement so you can compare the deformation before failure and the failure location to your FEA predictions.

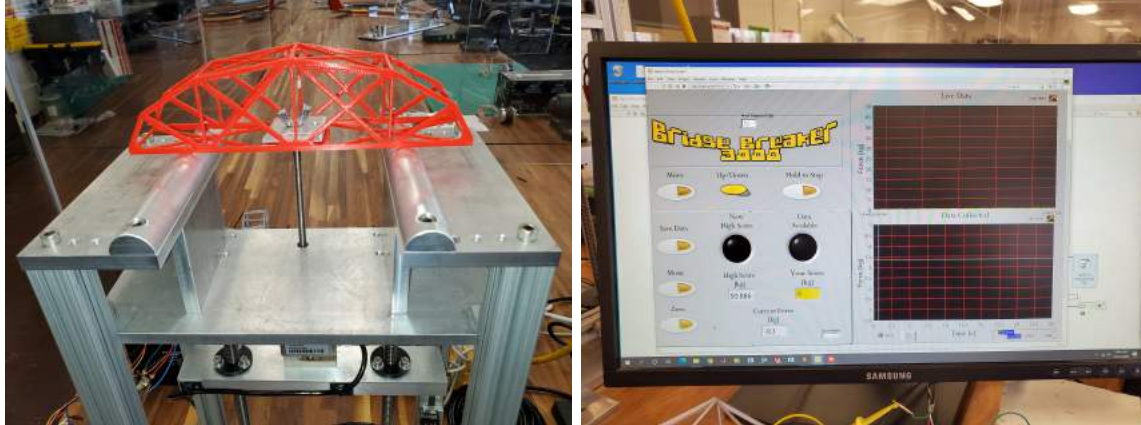

Figure 28. Photos of bridge testing apparatus (left) and testing display (right). A slow-motion video of a test run is available at <https://photos.app.goo.gl/MYNW1awqcMDmwHYx8>.

Report and grading:

The report (one report per group) will be the primary means of grading the projects (2/3). Your level of success in the competition also counts (1/3). The performance score (out of 100 possible) will be computed as follows:

$$\text{Performance score} = 50(1 + W/M)$$

where M = maximum weight held by any bridge and W = weight held by your bridge, so your group's score will be between 50 and 100. So more weight (no pun intended) is given to the process (*i.e.*, your report) than the result, which is just the opposite of how life really works. The report should include:

- Drawings of preliminary design concepts and critiques of these designs - In the report you need to explain your design in terms of minimizing the stress for the given maximum weight. So, talk about what you did that decreased stress more than anything else you could have done.
- Results of Finite Element Analysis (FEA) (stress computations) using SolidWorks. Put the summary results in the body of the report; if you have a lot of results, summarize them in the body and put the details in an appendix.
- Testing of the preliminary bridge(s).
- Design changes made based preliminary testing.
- Results of the “official” test.
- “Post-mortem” of your bridge (why it failed). Did the bridge fail at the location where the predicted stress was highest according to the SolidWorks FEA analysis? If not, any idea why not?
- What you would do differently if you built another bridge.
- Appendices
 - Meetings – agenda, minutes, action items.
 - Copies of e-mail exchanges.
 - Details of FEA stress computations

- Whatever else you think is appropriate. Some people show pictures of “real” bridges or other people’s bridges, which isn’t very insightful. Also, I prefer to have the pictures in the body of the report where they are referred to in the text, not at the end where I have to keep referring back and forth.
- Project reports will be due on **Thursday, December 16, 2021 at 4:00 pm.**

Suggestions for the design/construction

- From various references you can find that the yield stress (σ_{yield}) of PLA in tension is around 45 MPa and the elastic modulus (E) is around 3000 MPa, and the density 1.25 g/cm³. You can use values from the references, but you’ll get a better grade if you use the results of the testing of our 3D-printed beams (test data will be sent to the class).
- Make sure your bridge is a little longer than 9 inches (recall that the maximum is 9.75) so that when the load is applied and it starts to bend, it won’t slip between the supports!
- Do NOT build anything on the bottom to constrain the bridge on the support half-rounds; as the bridge bends that will add increased tension on the lower support beams (real bridges are built to flex this way, too.)
- You should test your virtual bridge using the SolidWorks FEA and estimate its failure load. In particular, if the program shows that some elements are under more stress than others, you should strengthen that element, for example by increasing the thickness of that element. Conversely, elements with little stress should be weakened or eliminated completely. **Show how you use the results to minimize your stress to weight ratio. Just running the FEA program without using the results isn’t very insightful. What is really cool and will get you a really good grade on the report is if you actually use SolidWorks to predict the load at which the bridge will fail and compare the actual failure load to the predicted one.**
- Inevitably a bridge with a superstructure (*i.e.*, a truss bridge) will be stronger than a flat bridge of the same weight. This is a natural consequence of the fact that you’ll get more moment of inertia (I) for the same amount of material with a tall structure than a flat one (think about the discussion of I-beams).
- Don’t forget to consider buckling of elements (e.g., by determining the maximum deformation) as well as stress failures
- In presenting the Solidworks FEA results, the scales on the plots are too small to read and the tick marks have weird intervals - don’t just accept the defaults, make a good plot out of a bad one.

Grading

The grading rubric for the project reports will be as follows:

(20 points) Organization/presentation

- Structure of report
- Writing style
- Clarity of figures
- Captions on figures

(60 points) Documenting the development process

- Focused on objectives
- Logic flow of development process
- Results of Solidworks analysis and design iterations
- Documenting meetings

(20 points) Lessons learned - what would you do differently if you had to do it all over again?

Add this table to your cover page:

Organization	/20
Documentation	/60
Lessons learned	/20
Total	/100

The grading is not like an exam where you start at 0 and add points or start at 100 and remove points. The project reports start at 75 as an “average” report and points are added or subtract from there. So, getting a score of 75 doesn’t mean you lost 25 points, it means the report was average in our assessment.

Appendix B. Problem-solving methodology

1. Make a clean start (clean sheet of paper)
2. Draw a picture
3. State givens, state unknowns (in real life, in most cases you won't have enough givens to determine the unknowns so you'll have to turn some of the unknowns into givens by making "plausible" assumptions.) **You need to have as many equations as unknowns. If you can state what the equations and the unknowns are, you're 90% of the way to the solution.**
4. Think, then write (I don't necessarily agree with this...) But it is essential that you STATE YOUR ASSUMPTIONS AND WRITE DOWN THE EQUATIONS THAT YOU USE BEFORE YOU PLUG NUMBERS INTO SAID EQUATIONS. Why is this so important? To make sure that your equations are valid for the problem assumptions. For example, Bernoulli's equation is valid only for steady, incompressible (constant-density) flow but on the panic of an exam you'll try to apply it to a gas at high Mach number. Another example is Hooke's law, which applies only to an elastic material, not Play-Doh.
5. Be coordinated – show your coordinate system on you picture and follow through with this coordinate system in your equations
6. Neatness counts
7. Units
8. Significant figures
9. Box your answer
10. Interpret the result – is it reasonable?

Appendix C. Excel tutorial

Excel is a fairly powerful tool for data analysis and computation. It is primarily oriented toward financial calculations but it works reasonably well for engineering and scientific calculations as well. It is certainly not as capable as programs like Matlab, Mathematica, TKSolver, etc. but most people have free access to Excel. And you can imbed an Excel spreadsheet in a Word or Powerpoint document such that all you need to do to open the spreadsheet is to click on the figure. Plus, a lot of people (PDR included) have created spreadsheets in Excel for solving various types of problems that can be downloaded from the internet. Some of my spreadsheets are available on-line at

<http://ronney.usc.edu/excel-spreadsheets/>

This short tutorial is aimed to give you a few pointers at how to use Excel for engineering problems. Of course, there's no substitute for actually playing with the program – reading about how to use software is about as useful as reading about how to ride a bicycle.

Cells, rows and columns

Spreadsheets are organized into *cells* arranged in rows and columns of information. In Excel the columns are A, B, C, ... and the rows are 1, 2, 3, So the address of the cell in 4th column, 5th row would be D5.

Formulas

Each cell may contain raw data (i.e. just a plain number) or a formula, or text. The formula cells generally refer to other cells, for example if cell A1 had a number in it, and B1 had another number, and you wanted to know the sum of those 2 values, you could enter `=A1+B1` into another cell (not A1 or B1) for example C1: (If you're viewing the Word version of this document (not the online web version, not the pdf version), you can double click the table to open the Excel spreadsheet)

1st number	2nd number	Sum
7	5	12

You can look at the formula entered into a cell by clicking on that cell and looking at the “formula bar” at the top of the screen. There's a zillion different functions you can use in Excel, e.g. addition (+), multiplication (*), subtraction (-), division(/), exponentiation (^), ln(), exp(), sin(), etc. Pick “function” from the “insert” menu to see the available functions. Some functions like SUM, AVERAGE, STDEV, etc. refer to an array of cells rather than an individual cell, in which case the formula is of the form `=SUM(A1:B10)`. (Note that the array of cells can be a vertical column, a horizontal row, or a block more than one cell wide in both the horizontal and vertical directions).

Also, sometimes you want to create a formula in one cell then copy/paste the same formula into other cells, e.g. $E = mc^2$. If your cell contains a constant, when you copy/paste, you'll get the constant in all the cells into which you paste. If your cell contains a formula, when you copy/paste, you'll get that formula in the other cells, but the cells to which the formula refers will be adjusted accordingly. For example, if cell C1 contains the formula `=A1+B1`, if you copy/paste this formula into cell E7 (2 columns to the right and 6 rows down), the formula in cell E7 will read `=C7+D7` (each cell reference is changed by 2 columns to the right and 6 rows down). This is extremely convenient

for calculating $E = mc^2$ for a large set of masses (m), but really you only want to enter c (speed of light) in one cell, and have all formulas refer to the value of c in that cell which would be (in the example below) cell A2. In that case you can use an “absolute reference” to that cell which is of the form $\$A\2 rather than just A2. Without the dollar signs formulas use “relative references” and thus change when you copy/paste them. (If on the other hand you **cut** and paste rather than **copy** and paste, meaning you’re moving a cell or cells from one location to another rather than creating new formulas in new cells, then the referencing doesn’t change, that is, A2 stays A2.)

c (m/s)				
3.00E+08				
m (kg)	1	10	100	1000
E (Joules)	3.00E+08	3.00E+09	3.00E+10	3.00E+11

There are also *array formulas* that are especially useful for solving a set of simultaneous linear equations. They are rather cryptic to create, almost like a secret handshake, so I’ll just give you a “template” you can use:

1.01E+00	2	3	4	10
1	2	3	4	10
1	-1	1	-1	0
4	5	2	0.00E+00	12
-1.003E-14	1.64102564	1.8974359	0.25641026	

This solves the set of equations
 $1 X_1 + 2 X_2 + 3 X_3 + 4 X_4 = 10$
 $8 X_1 + 7 X_2 + 6 X_3 + 5 X_4 = 26$
 $1 X_1 - 1 X_2 + 1 X_3 + -1 X_4 = 0$
 $4 X_1 + 5 X_2 + 2 X_3 + 1 X_4 = 12$

which has the solution $X_1 = X_2 = X_3 = X_4 = 1$.

Another useful function is “Goal Seek” from the “Tools” menu, for which you can ask Excel to modify the value in one cell until another cell has a specific value. For example, you could input the formula for the left-hand side of an equation in one cell, input the formula for the right-hand side of the equation into another cell, then set another cell to compute the difference between the right and left-hand sides, and use Goal Seek to find the solution. Let’s suppose you want to find x such that $150 \sin(x) e^x = 12 \ln(x) + 7x^2$ (x in radians for the $\sin(x)$ term). There’s no way to solve this analytically, so you have to do tedious trial and error to find the solution, so set up the spreadsheet:

x	150*sin(x)*exp(x)	12*ln(x) + 7x^2	LHS-RHS
1.88396438	32.44579276	32.44579189	-0.000875599

In this case use **Tools / Goal Seek / Set cell: D2 / To value: 0 / By changing cell: A2**
 Of course, your initial guess of x has to be good enough that Excel can converge on the solution. There are also other selections under the Tools menu such as “Solver” that has more options (like changing multiple cells to find the solution, or find the maximum or minimum rather than a specific value, optionally subject to constraints such as certain cells have to be greater than zero) but in my experience Solver is less reliable for simple problems – use Goal Seek if it will do what you need.

A very powerful “dirty trick” within Excel is the “iterate” feature. Select Preferences / Calculation and check “Manual.” Also select “Iteration” and set “Maximum iterations” = 1. With this, Excel (a) does not update the calculations automatically, but only when you type **Cmd =** (on the Mac, or something similar on the PC) and (b) Excel doesn’t complain when cells refer to each other (circular references, like if you had the formula “=A1” in cell B1, and “=A1” in cell B1. This might not seem like anything useful, but in most scientific calculations, one has a large set of simultaneous, non-linear equations and the only way to solve them is iteratively. Each time you type **Cmd =**, the calculation advances by one iteration towards the solution. A trivial example of this is to put the formula “=A1+1” in cell A1:

1

Every time you hit **Cmd =**, the value of this cell will increase by 1.

Also, for time-dependent problems, you can use the iteration feature and each iteration will increment the solution by one time step. I have written a fairly elaborate sheet for use in heat conduction problems:

http://ronney.usc.edu/spreadsheets/Unsteady_2D_conduction.xls

You can also plot data sets by highlighting the cells and selecting “Chart” from the “Insert” menu and you’ll get a bunch of options of what to plot and how to plot it. Excel doesn’t make very good quality plots suitable for publication in journals, but they’re adequate for homework, internal reports, etc. If you click on the chart you created and select the “Add Trendline” option from the Chart menu, you can add a least-squares fit to the data in the form of a line, polynomial, power law, etc.

One of my favorite examples of a fairly complete spreadsheet package including plotting is the one I wrote for analyzing internal combustion engine cycles including the effects of compression and expansion, heat losses, the rate of combustion, the exhaust gases trapped in the cylinder after the end of the exhaust stroke, etc.:

<http://ronney.usc.edu/spreadsheets/AirCycles4Recips.xls>

Appendix D. Statistics

“There are three kinds of lies: lies, damn lies, and statistics...”

- Origin unknown, popularized by Mark Twain.

Mean and standard deviation

When confronted with multiple measurements y_1, y_2, y_3, \dots of the same experiment (e.g. students' scores on an exam), one typically reports at least two properties of the *ensemble* of scores, namely the *mean value* and the *standard deviation*:

Average or mean value = (sum of values of all samples) / number of samples

$$\bar{y} \equiv \frac{y_1 + y_2 + y_3 + \dots + y_n}{n} = \frac{1}{n} \sum_{i=1}^n y_i \quad (\text{Equation 88})$$

Standard deviation = square root of sum of squares of difference between each sample and the mean value, also called *root-mean-square* deviation, often denoted by the Greek letter lower case σ :

$$\sigma \equiv \sqrt{\frac{(y_1 - \bar{y})^2 + (y_2 - \bar{y})^2 + (y_3 - \bar{y})^2 + \dots + (y_n - \bar{y})^2}{n-1}} = \sqrt{\frac{1}{n-1} \sum_{i=1}^n (y_i - \bar{y})^2} \quad (\text{Equation 89})$$

Warning: in some cases a factor of n , not $(n-1)$, is used in the denominator of the definition of standard deviation. I actually prefer n , since it passes the function test better:

- With n in the denominator, then when $n = 1$, $y_1 = \bar{y}$, and $\sigma = 0$ (that is, no sample deviates at all from the mean value.)
- With $n - 1$ in the denominator, then when $n = 1$, again $y_1 = \bar{y}$, but now $\sigma = 0/0$ and thus standard deviation is undefined

But the definition using $n - 1$ connects better with other forms of statistical analysis that we won't discuss here, so it is by far the more common definition.

Example:

On one of Prof. Ronney's exams, the students' scores were 50, 33, 67 and 90. What is the mean and standard deviation of this data set?

$$\text{Mean} = \frac{50 + 33 + 67 + 90}{4} = 60 \quad (\text{a bit lower than the average I prefer})$$

$$\text{Standard deviation} = \sqrt{\frac{(50 - 60)^2 + (33 - 60)^2 + (67 - 60)^2 + (90 - 60)^2}{4 - 1}} = 31.12$$

Note also that (standard deviation)/mean is $31.12/60 = 0.519$, which is a large spread. More typically this number for my exams is 0.3 or so. In a recent class of mine, the grade distribution was as follows:

Grade	# of standard deviations above/below mean
A+	> 1.17 σ above mean (1.90, 1.81)
A	0.84 to 1.17 above mean
A-	0.60 to 0.67 above mean
B+	0.60 above mean to 0.10 below mean
B	0.32 to 0.29 below mean
B-	0.85 to 0.68 below mean
C+	1.20 to 1.07 below mean
C	1.67 to 1.63 below mean
C-	> 1.67 below mean (2.04)

Stability of statistics

If I want to know the mean or standard deviation of a property, how many samples do we need? For example, if I flip a coin only once, can I decide if the coin is “fair” or not, that is, does it come up heads 50% of the time? Obviously not. So obviously I need more than 1 sample. Is 2 enough, 1 time to come up heads, and another tails? Obviously not, since the coin might wind up heads or tails 2 times in a row. Below are the plots of two realizations of the coin-flipping experiment, done electronically using Excel. If you have the Word version of this file, you can double-click the plot to see the spreadsheet itself (assuming you have Excel on your computer.) Note that the first time the first coin toss wound up tails, so the plot started with 0% heads and the second time the first coin was heads, so the plot started with 100% heads. Eventually the data smooths out to about 50% heads, but the approach is slow. For a truly random process, one can show that the uncertainty decreases as $1/\sqrt{n}$, where n is the number of samples. So to have half as much uncertainty as 10 samples, you need 40 samples!

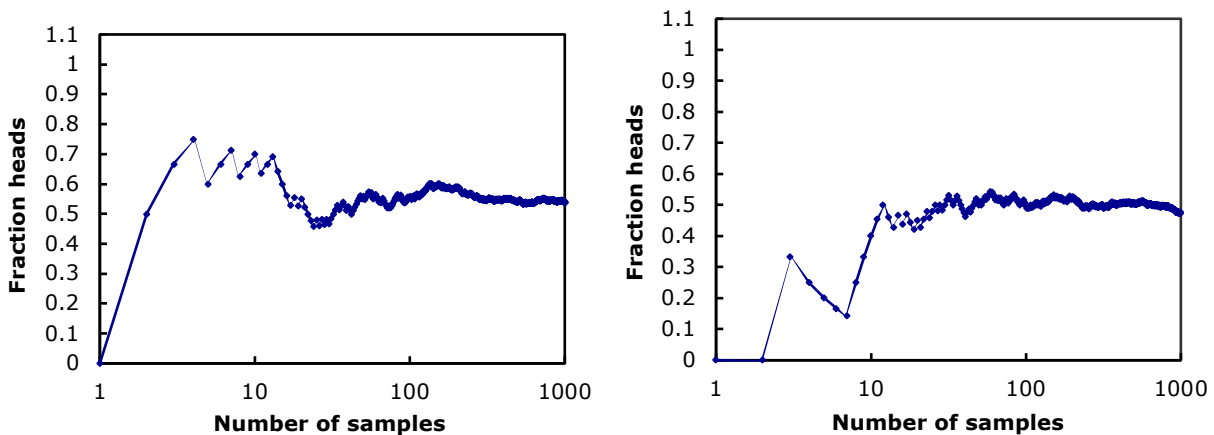

Figure 29. Results of two coin-toss experiments.

Side note: if a “fair” coin lands heads 100 times in a row, what are the chances of it landing heads on the 101st flip? 50% of course, since each flip of a fair coin is independent of the previous one.

Least-squares fit to a set of data

Suppose you have some experimental data in the form of $(x_1, y_1), (x_2, y_2), (x_3, y_3), \dots (x_n, y_n)$ and you think that the data should fit a linear relationship, i.e. $y = mx + b$, but in plotting the data you see that the data points do not quite fit a straight line. How do you decide what is the “best fit” of the experimental data to a single value of the slope m and y -intercept b ? In practice this is usually done by finding the minimum of the sum of the squares of the deviation of each of the data points $(x_1, y_1), (x_2, y_2), (x_3, y_3), \dots (x_n, y_n)$ from the points on the straight line $(x_1, mx_1+b), (x_2, mx_2+b), (x_3, mx_3+b), \dots ((x_n, mx_n+b))$. In other words, the goal is to find the values of m and b that minimize the sum

$$S = (y_1 - (mx_1 + b))^2 + (y_2 - (mx_2 + b))^2 + (y_3 - (mx_3 + b))^2 + \dots + (y_n - (mx_n + b))^2.$$

So we take the *partial derivative* of S with respect to m and b and set each equal to zero to find the minimum. **Note: this is the ONLY place in the lecture notes where substantial use of calculus is made, so if you have trouble with this concept, don't worry, you won't use it again in this course.** A partial derivative (which is denoted by a curly “ ∂ ” compared to the straight “ d ” of a total derivative) is a derivative of a function of two or more variables, treating all but one of the variables as constants. For example if $S(x, y, z) = x^2y^3 - z^4$, then $\partial S/\partial x = 2xy^3$, $\partial S/\partial y = 3x^2y^2$ and $\partial S/\partial z = -4z^3$. So taking the partial derivatives of S with respect to m and b separately and setting both equal to zero we have:

$$\begin{aligned} \frac{\partial S}{\partial m} &= \frac{\partial}{\partial m} \left[(y_1 - (mx_1 + b))^2 + (y_2 - (mx_2 + b))^2 + (y_3 - (mx_3 + b))^2 + \dots + (y_n - (mx_n + b))^2 \right] = 0 \\ &\Rightarrow \frac{\partial}{\partial m} \left[(y_1^2 - 2y_1mx_1 - 2y_1b + m^2x_1^2 + 2mx_1b + b^2) + \dots + (y_n^2 - 2y_nmx_n - 2y_nb + m^2x_n^2 + 2mx_nb + b^2) \right] = 0 \\ &\Rightarrow (-2y_1x_1 + 2mx_1^2 + 2x_1b) + \dots + (-2y_nx_n + 2mx_n^2 + 2x_nb) = 0 \\ &\Rightarrow 2m \sum_{i=1}^n x_i^2 + 2b \sum_{i=1}^n x_i - 2 \sum_{i=1}^n y_i x_i = 0 \quad \Rightarrow \quad m \sum_{i=1}^n x_i^2 + b \sum_{i=1}^n x_i = \sum_{i=1}^n y_i x_i \end{aligned}$$

(Equation 90)

$$\begin{aligned} \frac{\partial S}{\partial b} &= \frac{\partial}{\partial b} \left[(y_1 - (mx_1 + b))^2 + (y_2 - (mx_2 + b))^2 + (y_3 - (mx_3 + b))^2 + \dots + (y_n - (mx_n + b))^2 \right] = 0 \\ &\Rightarrow \frac{\partial}{\partial b} \left[(y_1^2 - 2y_1mx_1 - 2y_1b + m^2x_1^2 + 2mx_1b + b^2) + \dots + (y_n^2 - 2y_nmx_n - 2y_nb + m^2x_n^2 + 2mx_nb + b^2) \right] = 0 \\ &\Rightarrow (-2y_1 + 2mx_1 + 2b) + \dots + (-2y_n + 2mx_n + 2b) = 0 \\ &\Rightarrow 2m \sum_{i=1}^n x_i + 2b \sum_{i=1}^n 1 - 2 \sum_{i=1}^n y_i = 0 \quad \Rightarrow \quad m \sum_{i=1}^n x_i + bn = \sum_{i=1}^n y_i \end{aligned}$$

(Equation 91)

These are two simultaneous *linear* equations for the unknowns m and b . Note that all the sums are known since you know all the x_i and y_i . These equations can be written in a simpler form:

$$Cm + Ab = D$$

$$Am + nb = B$$

(Equation 92)

$$A = \sum_{i=1}^n x_i; B = \sum_{i=1}^n y_i; C = \sum_{i=1}^n x_i^2; D = \sum_{i=1}^n x_i y_i$$

These two linear equations can be solved in the usual way to find m and b:

$$m = \frac{1}{A} \left(B - n \frac{AD - BC}{A^2 - nC} \right); b = \frac{AD - BC}{A^2 - nC}$$

(Equation 93)

Example

What is the best linear fit to the relationship between the height (x) of the group of students shown below and their final exam scores (y)? Assuming this trend was valid outside the range of these students, how tall or short would a student have to be to obtain a test score of 100? At what height would the student's test score be zero? What test score would an amoeba (height ≈ 0) obtain?

Student name	Height (x) (inches)	Test score (y) (out of 100)
Juanita Hernandez	68	80
Julie Jones	70	77
Ashish Kumar	74	56
Fei Wong	78	47
Sitting Bear	63	91

$$A = 68+70+74+78+63 = 353$$

$$B = 80 + 77 + 56 + 47 + 91 = 351$$

$$C = 68^2 + 70^2 + 74^2 + 78^2 + 63^2 = 25053$$

$$D = 68*80 + 70*77 + 74*56 + 78*47 + 63*91 = 24373$$

From which we can calculate **m = -3.107**, **b = 289.5**, i.e.

$$\text{Test score} = -3.107 * \text{Height} + 289.5$$

For a score of 100, $100 = -3.107 * \text{Height} + 289.5$ or $\text{Height} = 61.01$ inches = 5 feet 1.01 inches

For a score of zero, $0 = -3.107 * \text{Height} + 289.5$ or $\text{Height} = 93.20$ inches = 7 feet 9.2 inches

For a height of 0, score = 289.5

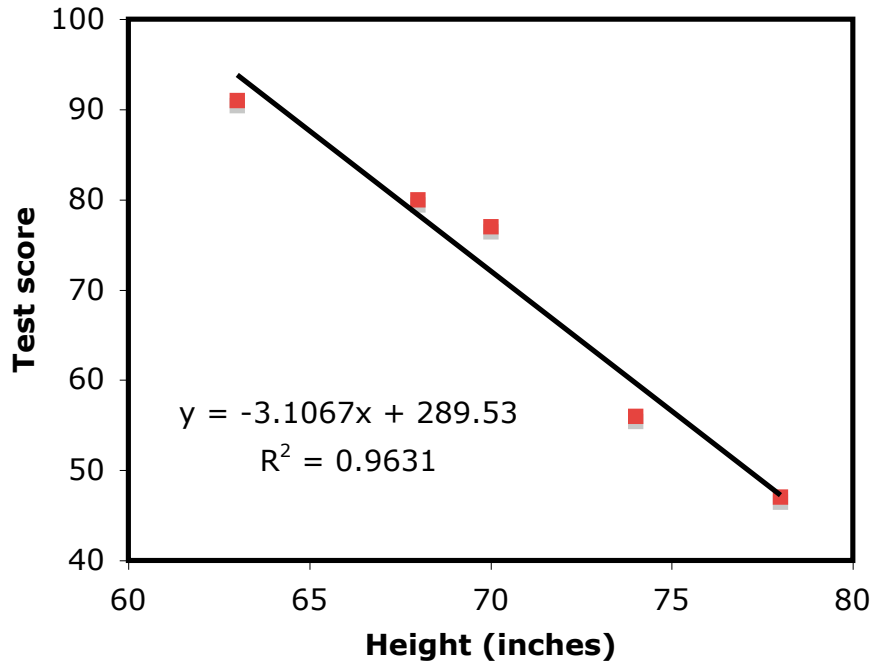

Figure 30. Least-squares fit to data on test score vs. height for a hypothetical class

How does one determine how well or poorly the least-square fit actually fits the data? That is, how closely are the data points to the best-fit line? The standard measure is the so-called R^2 -value defined as one minus the sum of the squares of the deviations from the fit just determined (i.e. the sum of $(y_i - (mx_i + b))^2$ divided by the sum of the squares of the difference between y_i and the average value \bar{y} ($=70.2$ for this case), i.e.,

$$R^2 = 1 - \frac{\sum_{i=1}^n (y_i - (mx_i + b))^2}{\sum_{i=1}^n (y_i - \bar{y})^2} \quad (\text{Equation 94})$$

For a perfect fit $y_i = mx_i + b$ for all i , so the sum in the numerator is zero, thus $R^2 = 1$ is a perfect fit. The example shown above is pretty good,

$$R^2 = 1 - \frac{(80 - (-3.107 * 68 + 298.5))^2 + (77 - (-3.107 * 70 + 298.5))^2 + (56 - (-3.107 * 74 + 298.5))^2 + (47 - (-3.107 * 78 + 298.5))^2 + (91 - (-3.107 * 63 + 298.5))^2}{(80 - 70.2)^2 + (77 - 70.2)^2 + (56 - 70.2)^2 + (47 - 70.2)^2 + (91 - 70.2)^2}$$

$= 0.9631$

and even fairly crummy fits (i.e. as seen visually on a plot, with many of the data points far removed from the line) can have $R^2 > 0.9$. So R^2 has to be pretty close to 1 before it's really a good-looking fit.