

origami paper presents

origami™



100 FREE

Origami Design's

GET MORE DESIGN'S  
AND IDEAS AT

[WWW.ORIGAMICRAZE.COM](http://WWW.ORIGAMICRAZE.COM)

# Get Some More Stuff...



Hands On  
Ability



Observation  
Ability



Imagination



Understanding  
Ability



We have taken the most popular origami designs from around the world and placed them within the pages of this book. When most people think of "origami," the picture that usually jumps to mind is that of the paper crane. The crane, which represents luck, hope and happiness, has come to be a highly-recognized symbol in the West of the ancient paper-folding tradition.

---

*Thank you for your purchase of Origami  
Craze origami paper!*

# Index : Easy

- A BEAR FACE
- A BELL PEPPER
- A CAR
- A CHAIR
- A FOX
- A HEART
- A NECKTIE
- A PANDA
- A PEACH
- A PENCIL
- A PIGEON
- A SHORT CAKE
- A SIMPLE HAT
- A TRIANGLE BOX
- AN APPLE
- AN ORIENTAL RADISH
- BANANAS
- BELL FLOWER
- BLOSSOM
- BOAT
- CABBAGE
- CATERPILLAR
- DOLL HAT
- DRINKING CUP
- FORTUNE TELLER
- HOME SWEET HOME
- DOLL IN KIMONO
- LOITERING MOUSE
- LOTUS FLOWER
- MOBILE
- OCTAGON STAR
- ONE PIECE 4
- ONE PIECE M6
- PERSIMMON
- PIGEON
- POLO SHIRT
- ROSE
- SAMURAI HAT
- SIMPLY HAPPY STAR
- TALKING DOG
- THE BUNNY
- THE CAT
- TRADITIONAL BOX
- A YELLOW BOX

# Index : Moderate

- A BALLOON
- A BEAR CLUB
- A BIRD
- A BLINKING EYE
- A CARNATION
- A CARROT
- A DOG ON KENNEL
- A FLY AGARIC
- A HVDRANGEA
- A PIG
- A RED FLOWER
- A TURTLE
- AN IRIS
- BREAD BASKETS
- CABBAGE BUTTERFLY
- CANDY DISH
- CRAB
- DOLLAR BILL
- DOLPHIN
- HAMSTER
- ONE PIECE DRESS
- SANTA CAP
- STAR BOX
- STRAWBERRY
- THE BUTTERFLY
- TULIP
- WATER FLOWER
- WATER MELON



# Index : Hard

- A DRAGON
- A FROG
- A GIANT WATER BUG
- A HEART CRANE
- A HELMET CRAB
- A LION
- A MANTIS
- A MUSHROOM
- A RUNT PONY
- A SHARK
- A SHIRT BAG
- A SUN FLOWER
- AN EVENING DRESS
- BALLON BUNNY
- BASKET
- JUMPING FROG
- CRAB
- CRAW FISH
- DIAMOND ROSE
- FLAPPING BIRD
- FRILLED LIZARD
- JACK O LANTERN
- MAPLE
- NABOO STARFIGHTER
- SCORPION
- SUMO WRESTLER
- WRIST WATCH
- YODA

# Index : Bonus

- SQUIRREL
- PARTITIONED BOX
- GIRAFFE
- AIRPLANE
- SANTA CLAUS
- ORIZURU
- PEACOCK
- PYRAMID
- THREE HEADED CRANE
- SQUID
- PAPILLON

**ORIGAMI CRAZE**

# **SIMPLE DESIGNES**

**FOR BEGINNERS**

**GET MORE DESIGNS AND IDEAS AT  
[WWW.ORIGAMICRAZE.COM](http://WWW.ORIGAMICRAZE.COM)**

# A BEAR FACE

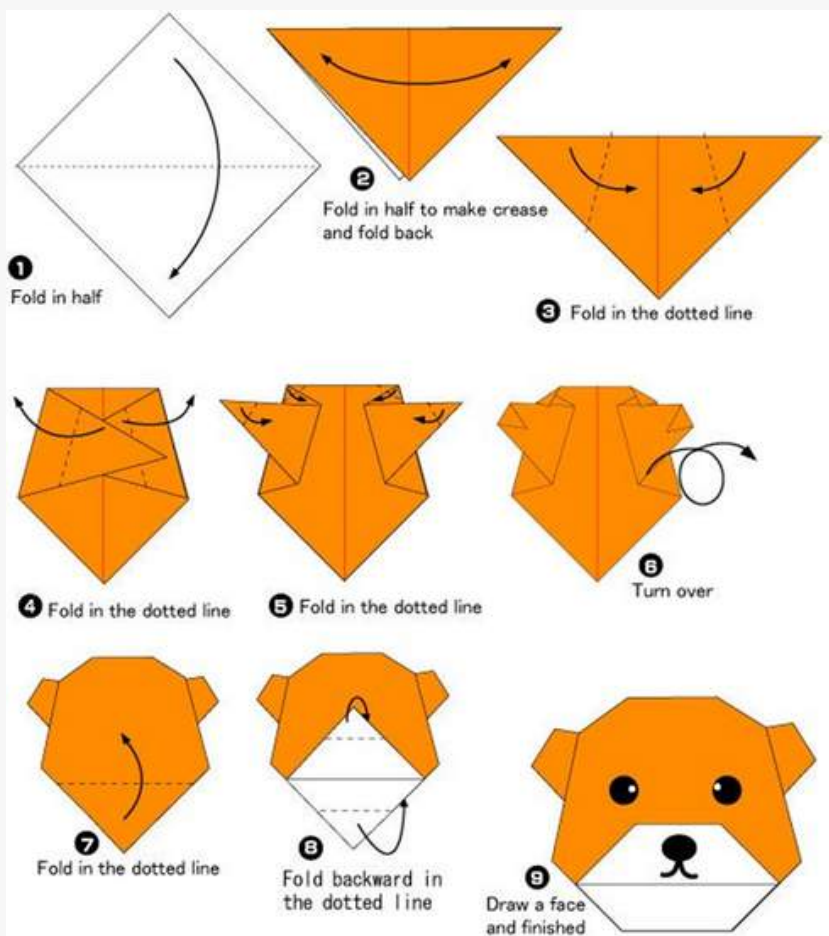

**A Bear (face)**



## 2. A BELL PEPPER

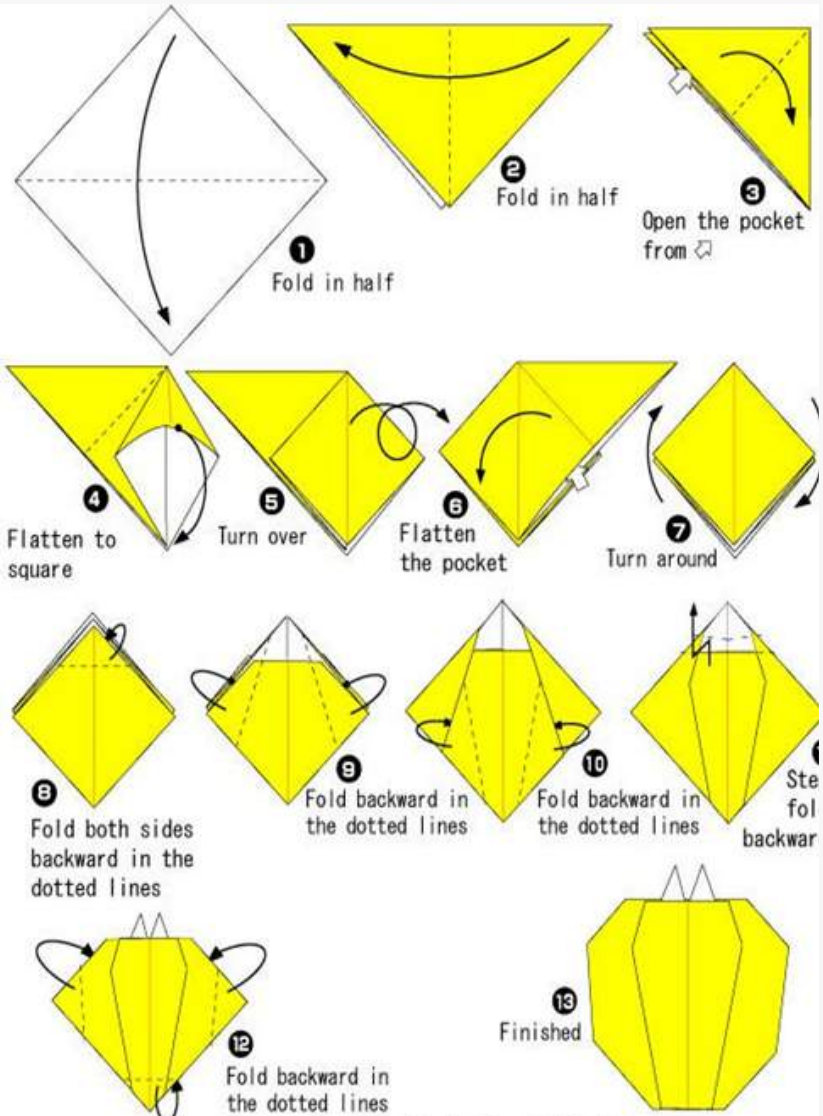

# A Bell Pepper



### 3. A CAR

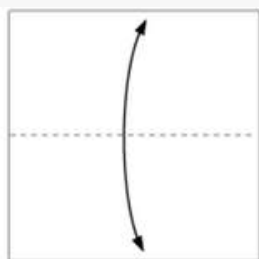

1 Fold in half to make a crease and fold back

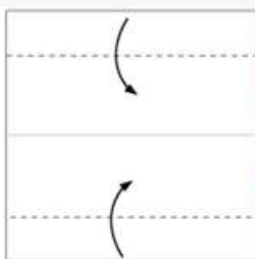

2 Fold in the dotted lines

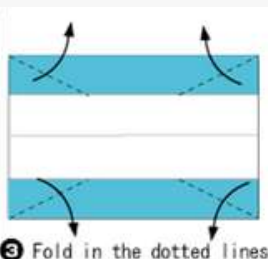

3 Fold in the dotted lines

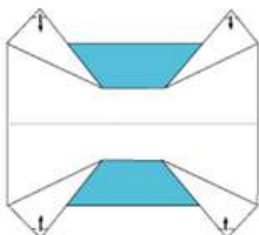

4 Fold in the dotted lines

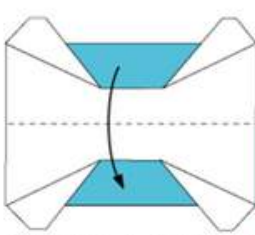

5 Fold in half

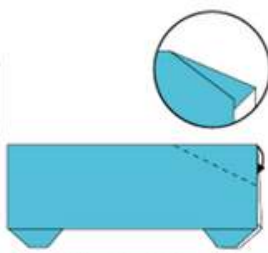

6 Pocket fold in the dotted lines

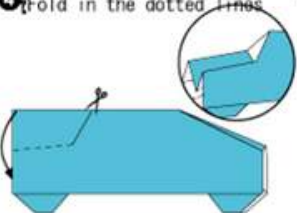

7 Cut with a pair of scissors and tuck in

8 Draw windows and finished



## A Car

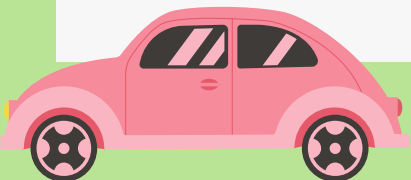

# 4. A CHAIR

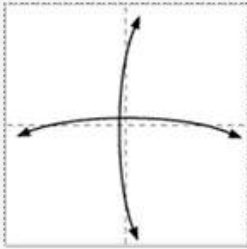

1 Fold in half twice to make crease

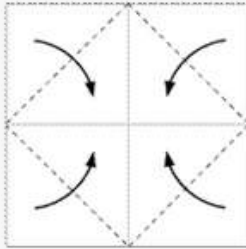

2 Fold forward in the dotted line

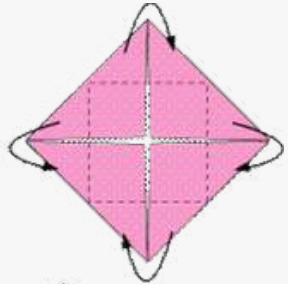

3 Fold backward in the dotted line

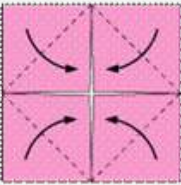

4 Fold forward in the dotted line



5 Turn over

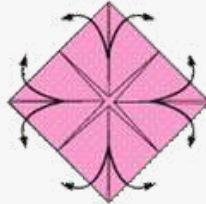

6 Open and flatten them

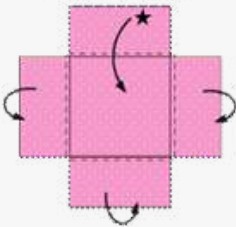

7 Fold ★ forward in the dotted line and fold others backward in the dotted line

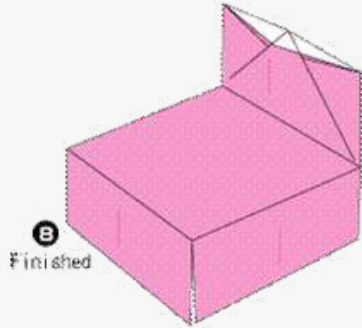

8 Finished

# A Chair

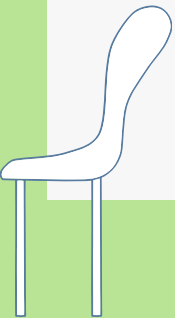

## 5. A FOX

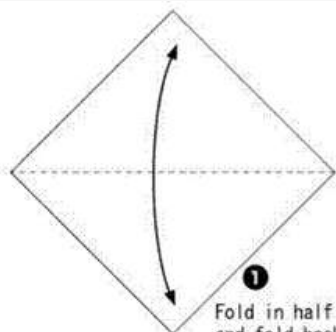

**1**  
Fold in half to make creases  
and fold back

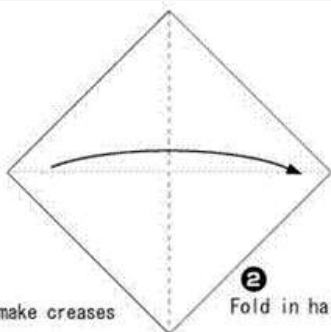

**2**  
Fold in half

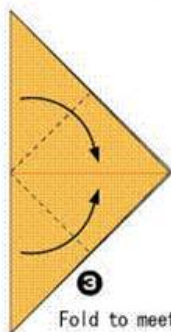

**3**  
Fold to meet  
the center line

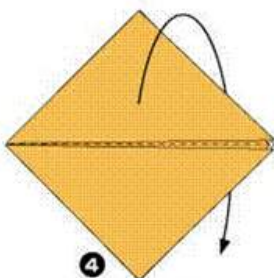

**4**  
Fold in half

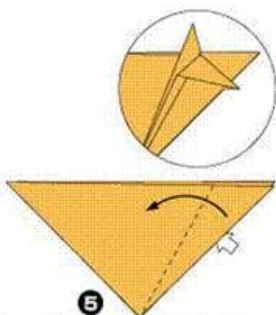

**5**  
Open the  part and flatten

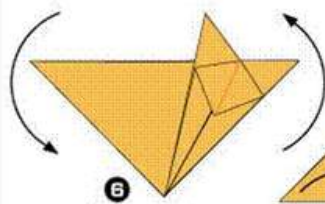

**6**  
Turn around

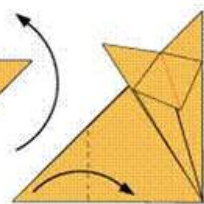

**7**  
Fold in the dotted line

Draw a face  
and finished

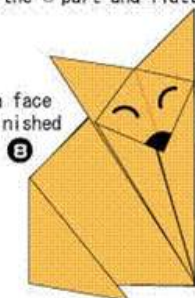

**A Fox**





## 6. A HEART

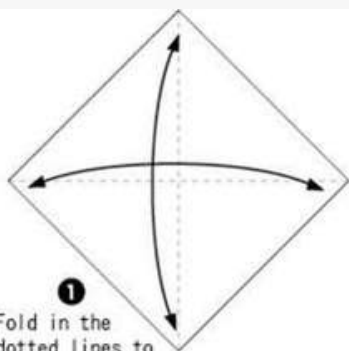

**1**  
Fold in the dotted lines to make creases and fold back

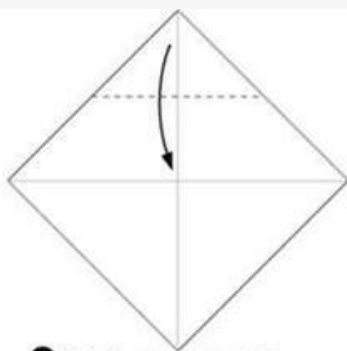

**2** Fold in the dotted line

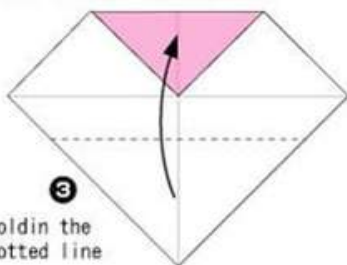

**3**  
Fold in the dotted line

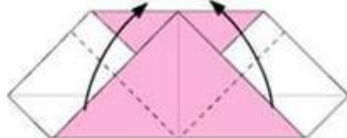

**4** Fold in the dotted lines

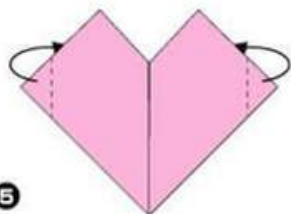

**5**  
Fold backward in the dotted lines

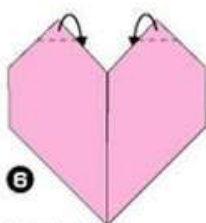

**6**  
Fold backward in the dotted lines

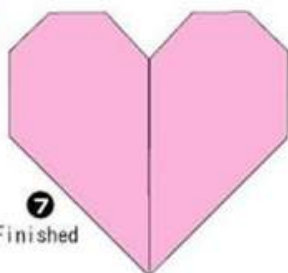

**7**  
Finished

# An Easy Heart



# 7. A NECKTIE

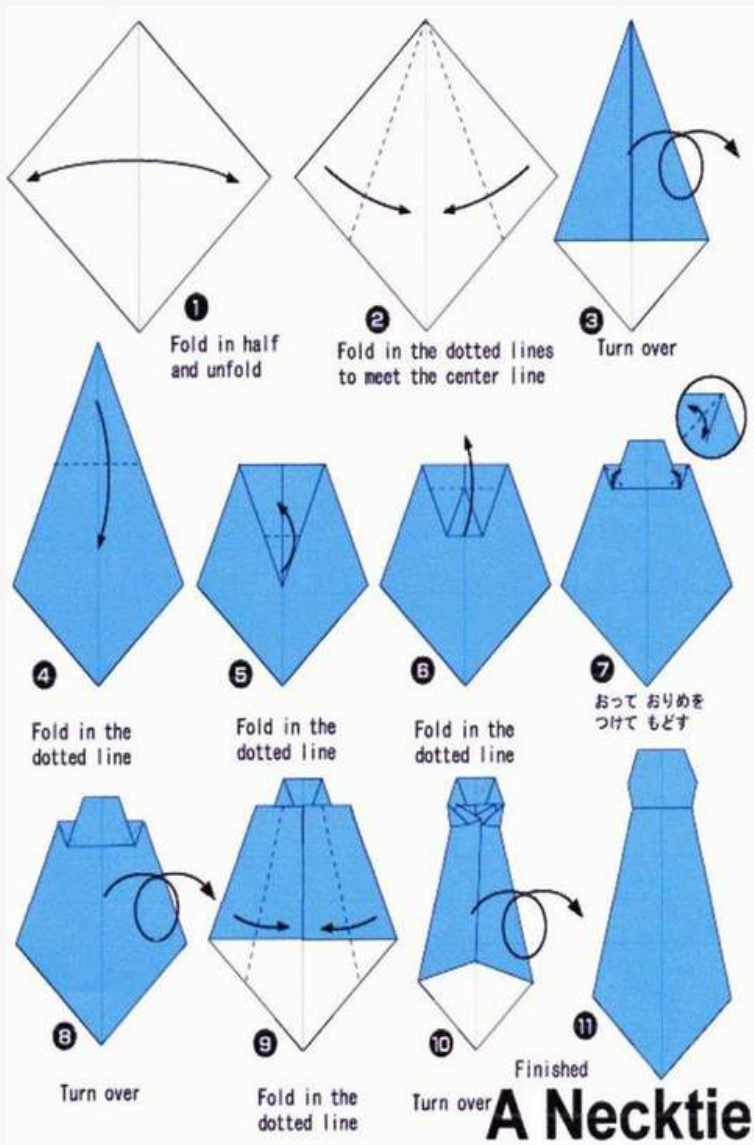

## 8. A PANDA

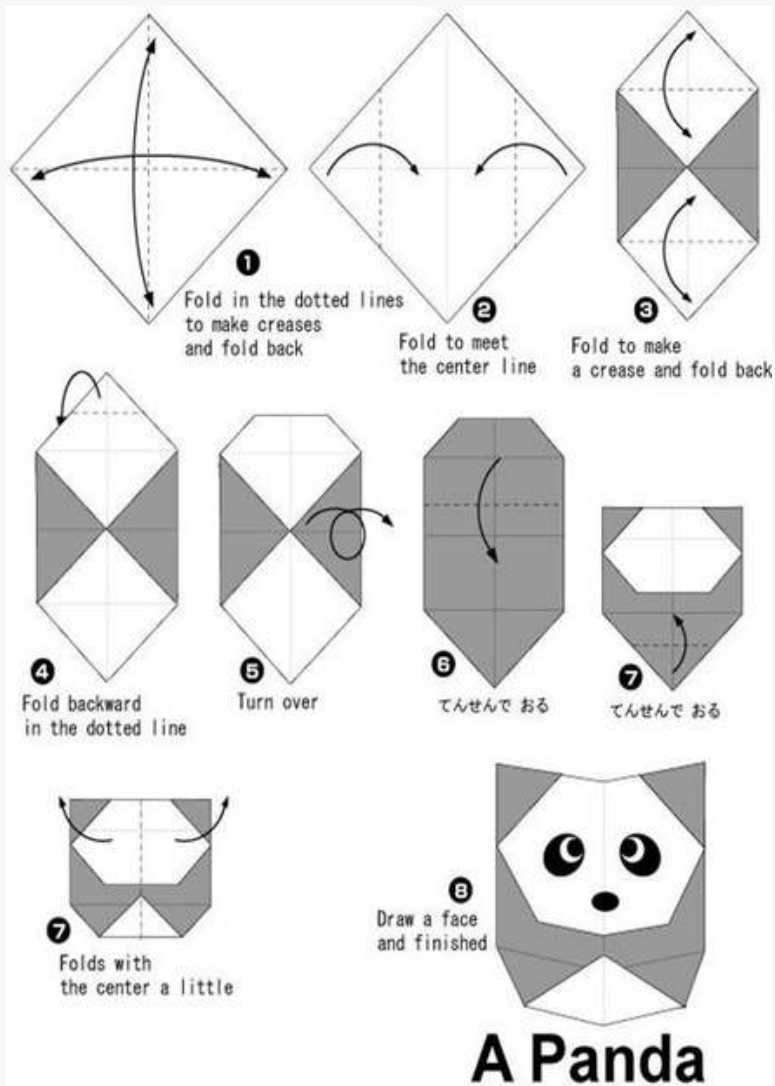

## 9. A PEACH

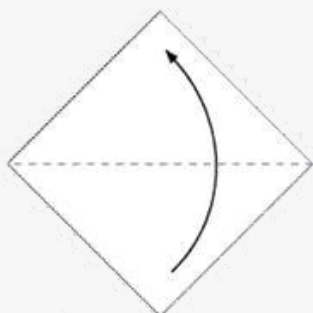

1 Fold in half

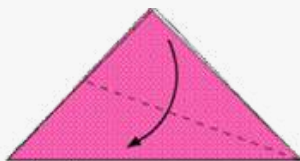

2 Fold in the dotted line

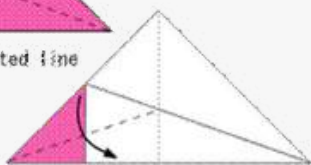

3 Fold in the dotted line

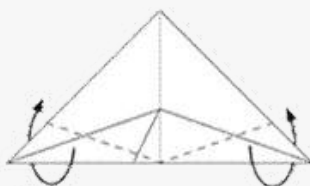

4 Fold in the dotted line

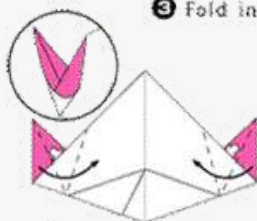

5 Open the pocket from 

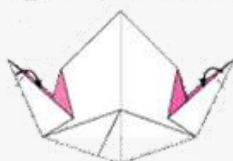

6 Pocket fold in the dotted lines

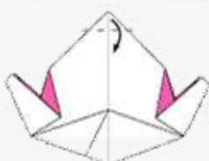

7 Fold in the dotted line



8 Turn over

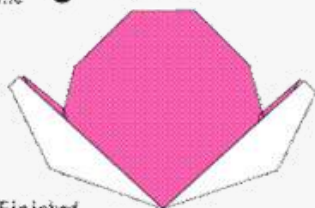

9 Finished

# A Peach



# 10. A PENCIL

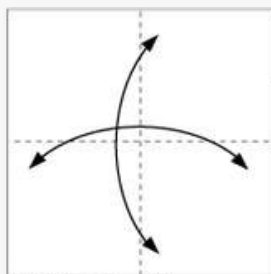

1 Fold to make crease and fold back

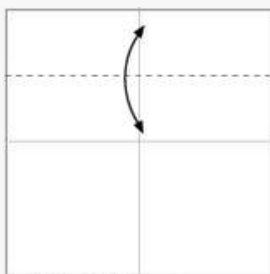

2 Fold to make crease and fold back



3 Fold to make crease and fold back

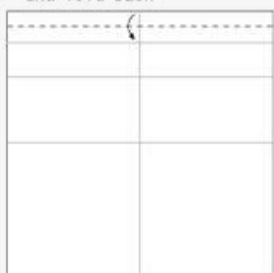

4 Fold in the dotted line

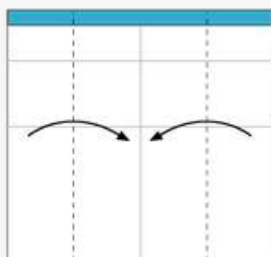

5 Fold to meet the center line along the crease

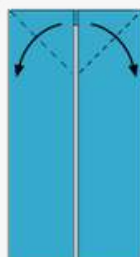

6 Fold in the dotted line

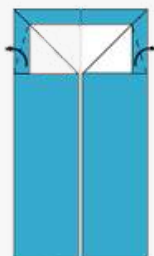

7 Fold in the dotted line

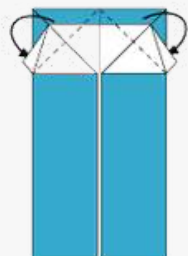

8 Fold backward in the dotted line

9 Finished

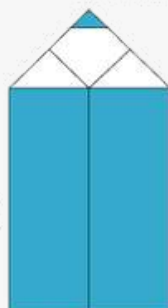

## A Pencil



# 11. A PIGEON

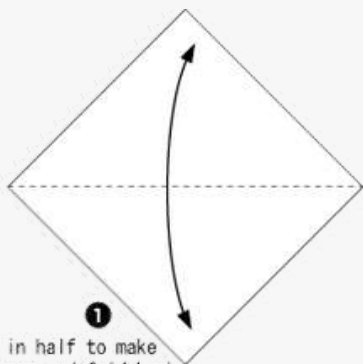

1  
Fold in half to make a crease and fold back

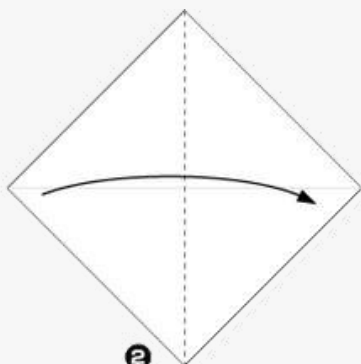

2  
Fold in half

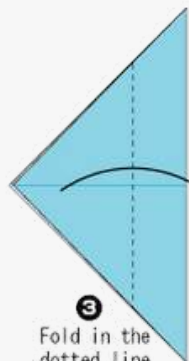

3  
Fold in the dotted line

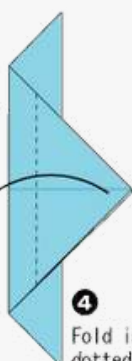

4  
Fold in the dotted line

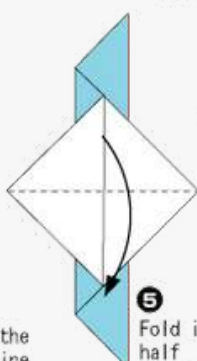

5  
Fold in half

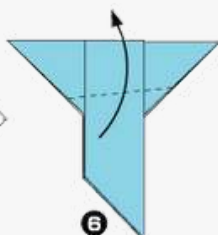

6

Fold in the dotted line. Back is the same, too

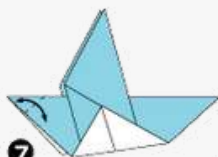

7

Fold to make a crease and fold back



8

Pocket fold in the dotted line

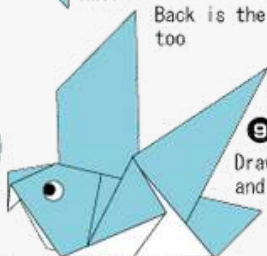

9

Draw eyes and finished

## A Pigeon

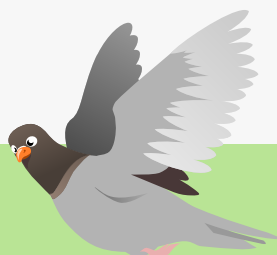

## 12. A SHORT CAKE

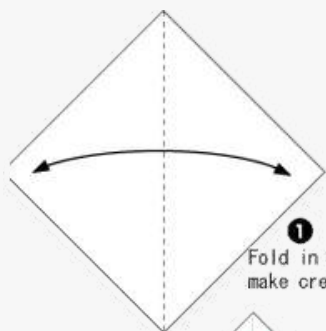

1

Fold in the dotted lines to make creases and fold back

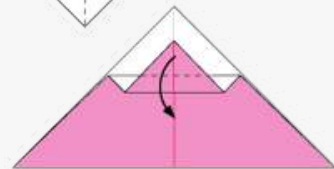

4 Fold in the dotted line

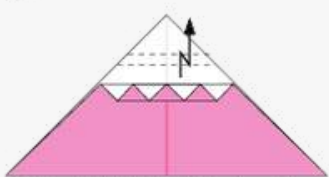

6 Step fold in the backward

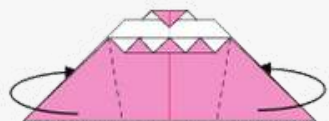

8 Fold backward in the dotted line



9

Folds with the center a little

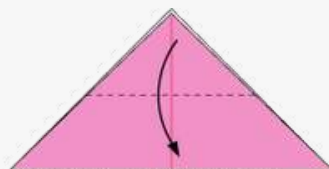

2 Fold in the dotted line

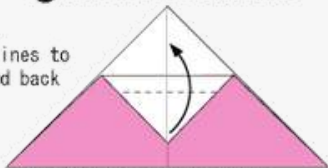

3 Fold in the dotted line

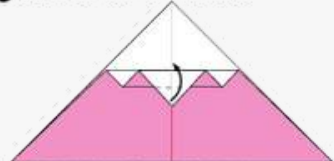

5 Fold in the dotted line

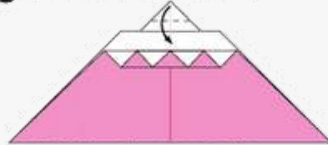

7 Fold in the dotted line



10  
Finished

# A Shortcake

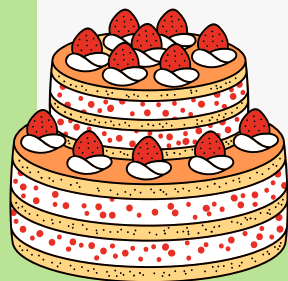

## 13. A SIMPLE HAT

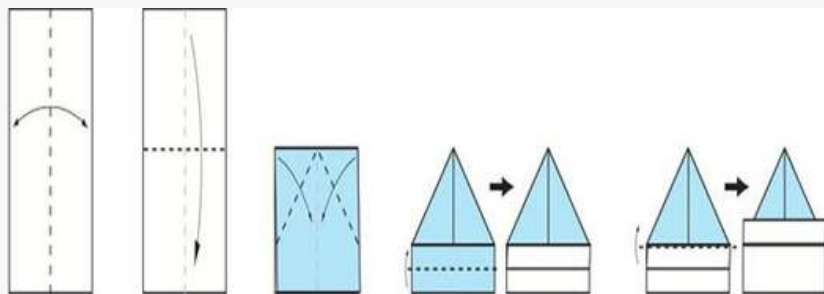

1. Start with a rectangular piece of paper, white side up. Fold the paper in half and open.

2. Now fold the top down to the bottom edge. Crease well.

3. Fold the top corners down to the centre line.

4. Fold the bottom edge (uppermost layer only) up to the base of the triangles.

5. Fold this part up once again, and crease well.

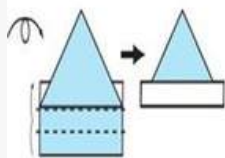

6. Turn model over, and repeat step 4 & 5 on the other side.



7. Open out the hat to shape it.

Your hat is now finished!

# A Simple Hat





# 14. A TRIANGLE BOX

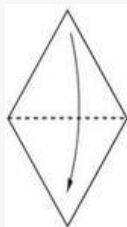

1. Start with a square piece of paper, plain side up.

Fold the paper in half.

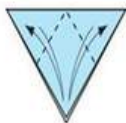

2. Fold the top corners toward the bottom point, then open to create these creases.

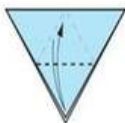

3. Fold both layers of the bottom point up to the top of the model, then open.

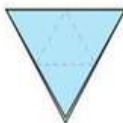

4. This is one completed unit. You need three. So make 2 more of these!

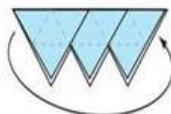
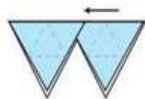

5. Insert one unit inside the other, then link the units all together.

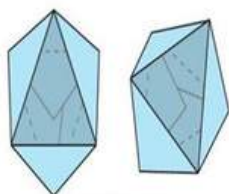

Completed Triangle Box

You can also make boxes with more than three units.

If you join four units together, you will have a lovely box with a square opening...

If you join 5 units together, you will have a box with a pentagon shaped opening.

Note: boxes with more than 3 units will need a bit of paper on the base as the units will not quite touch.

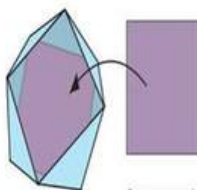

4 sided Triangle Box

Cut out a square piece of paper to glue to the bottom of the box. This will cover up the hole and look neat!

The square should be the same size as the opening of the box, so measure the edges to get a perfect fit.

## A Triangle Box

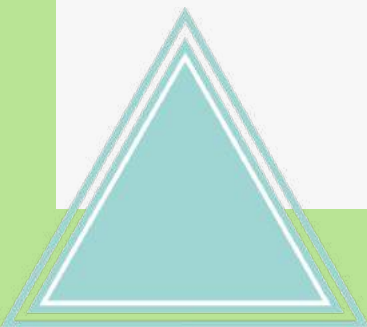

# 15. AN APPLE

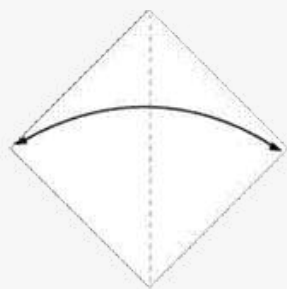

1 Fold in half

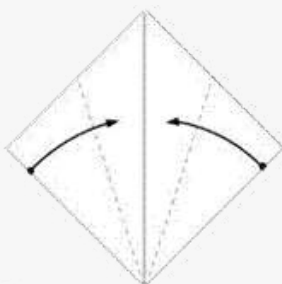

2 Fold in the dotted lines



3

Fold forward in the dotted line



4 Lift up to ★ and fold



5 Fold forward in the dotted line



6 Fold forward in the dotted line



7 Fold backward in the dotted lines



8 Turn over

9 Finished



# A Apple



# 16. AN ORIENTAL RADISH

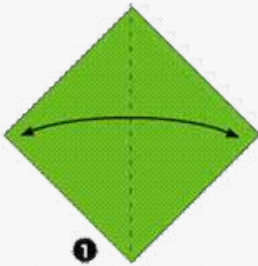

1  
Fold in half to make a crease and unfold

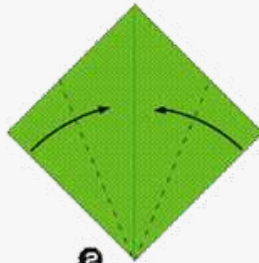

2  
Fold in the dotted lines to meet the center line

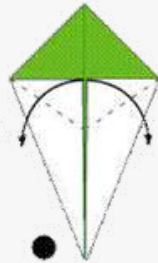

3  
Fold in the dotted lines

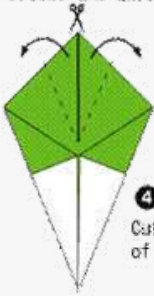

4  
Cut with a pair of scissors

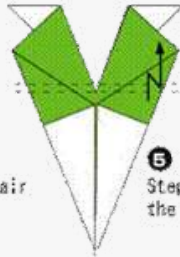

5  
Step fold in the dotted line



6  
Fold in the dotted lines

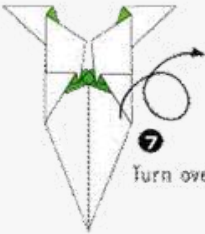

7  
Turn over

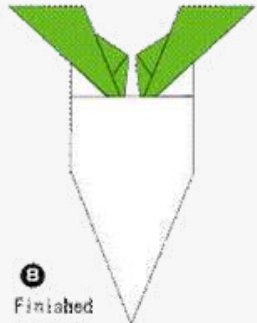

8  
Finished

## An Oriental Radish



# 17. BANANAS

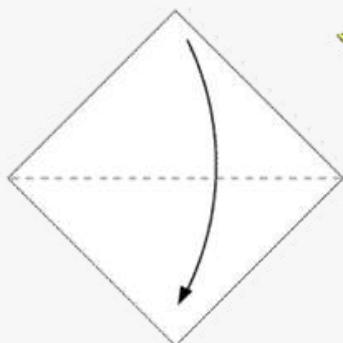

1 Fold in half

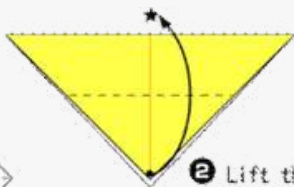

2 Lift the corner up to ★

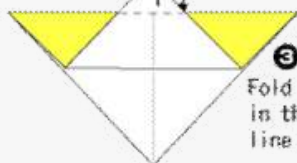

3 Fold backward in the dotted line

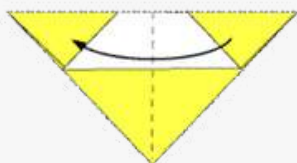

4 Fold in half

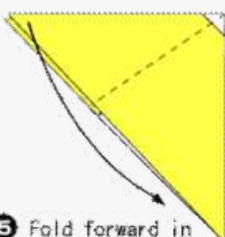

5 Fold forward in the dotted line

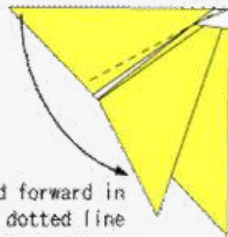

6 Fold forward in the dotted line

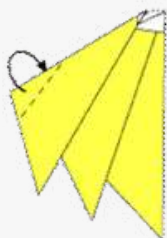

7 Fold backward in the dotted line

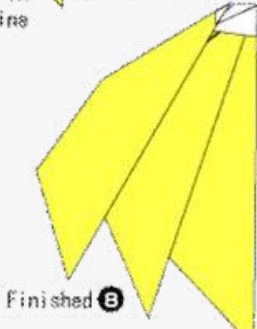

Finished 8

# Bananas



# 18. BELL FLOWER



**Bellflower**  
A traditional Japanese origami model.  
Diagrammed by Aaron Walden.

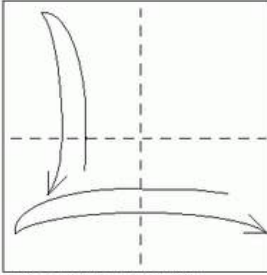

1. Crease vertically and horizontally, by valley folding and unfolding.

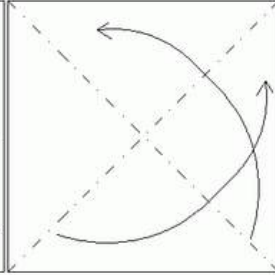

2. Crease diagonally in half, both ways, by mountain folding and unfolding.

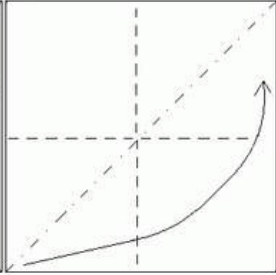

3. Fold left bottom corner to meet right top corner, by folding along creases, to get figure shown in the next step.

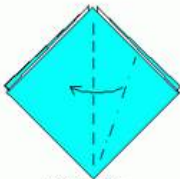

4. Squash fold.

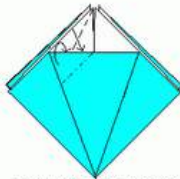

5. Fold upper left to inside, as shown. Repeat steps 4-5 on other three flaps.

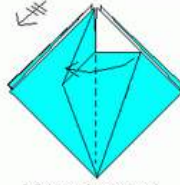

6. Fold one flap over, and repeat steps 4-6 on the three remaining sides.

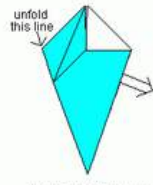

7. Pull right front layers to the right, as shown.

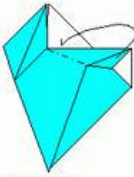

8. Fold all the way to the bottom of inside as shown.

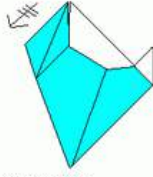

9. Repeat step 8 on other three sides.

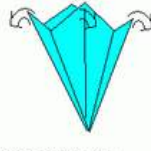

10. Curl the tips of the petals a bit, if desired.



COMPLETE

Diagram © 2007 by Aaron Walden.

# Bell Flower



# 19. BLOSSOM

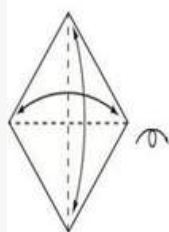

1. Start with a square piece of paper, white side up. Fold in half and open. Then fold in half the other way.



2. Turn the paper over to the coloured side. Fold the paper in half, crease well and open, and then fold in half the other direction.

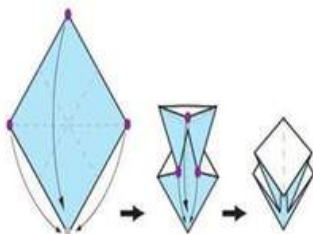

3. Using the creases you have made, bring the top 3 corners of the model down to the bottom corner. Flatten model.



4. Rotate model so the open part is at the top.

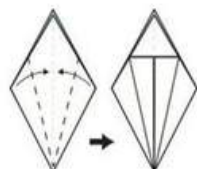

5. Fold top triangular flaps into the centre.



6. Turn model over and repeat this step on the other side.

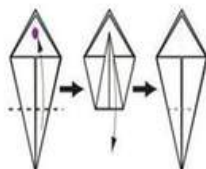

7. Fold the bottom corner upwards to the point shown. Crease very well and unfold.



8. Open out the front and back petals. As you open the front and back petals, the side petals should open up too, revealing the colour inside.



9. You can then fold the stem in half backwards to make the petals stay in place.

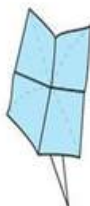

Finished Blossom

# Blossom

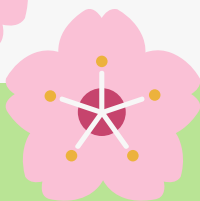
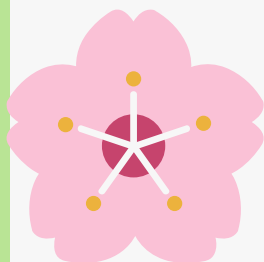

# 20. BOAT

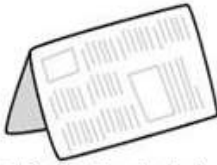

1. Start with a sheet of newspaper folded in half



2. Fold top corners in toward the middle

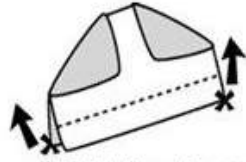

3. Fold bottom edges up on both sides ...

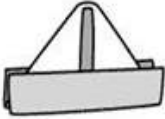

4. ... and flatten like this.

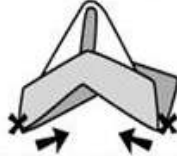

5. Bring the ends together ...



6. ... and flatten sideways to make a square

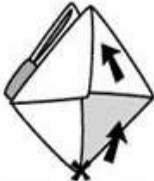

7. Fold one bottom corner up ...

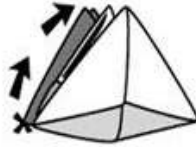

8. ... then fold the other corner up.



9. Bring the ends together ...



10. ... and flatten sideways to make a square.



11. Gently pull the ends down to open

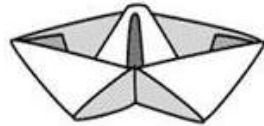

12. Here's your new boat!

# Boat





## 21. CABBAGE

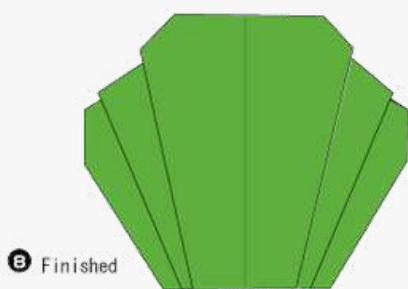
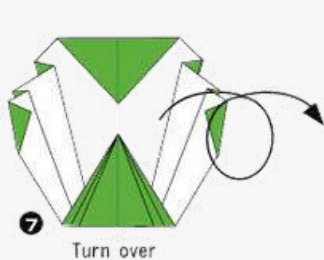
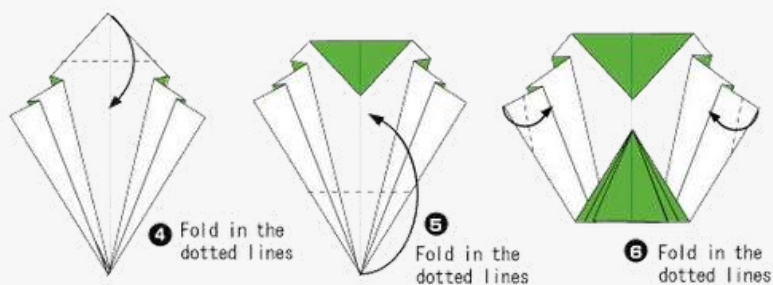
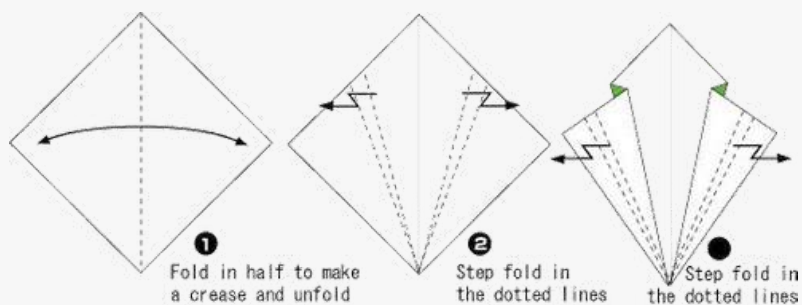

# A Cabbage

\*Copyright: Fumiaki Shingu





## 22. CATERPILLAR

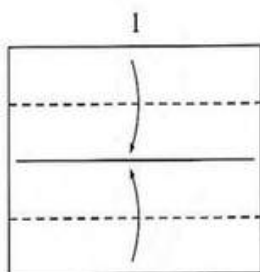

Use the piece of paper left over from the origami of slide (page 10). Find the centre line and fold the upper and the lower edges to it.

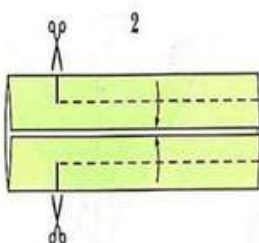

Make two cuts at 3 cm from the left edge and fold the upper and the lower quarter flaps to the centre line.

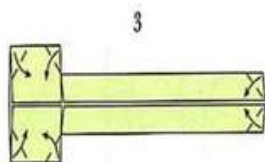

Fold all the six corners inwards.

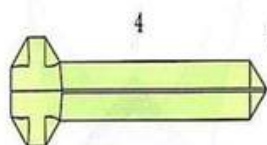

... like this.

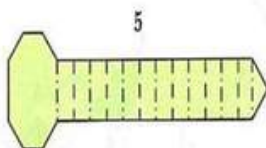

Fold backwards and forwards alternately.

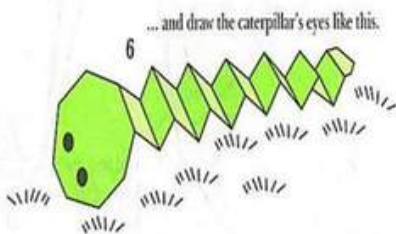

... and draw the caterpillar's eyes like this.

You may use a green paper for more realistic effect.

# Caterpillar



# 23. DOLL HAT

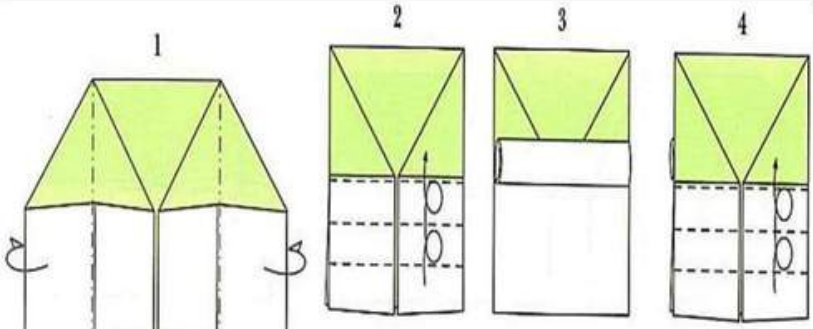

Start with a twin house-fold. Fold the left and the right edges backwards to the centre line.

Fold the upper layer thrice from bottom

... like this.

... and repeat step 2.



Turn upside down.

Turn the model upside down and you have a purse to hold your pencils or sweets for you.

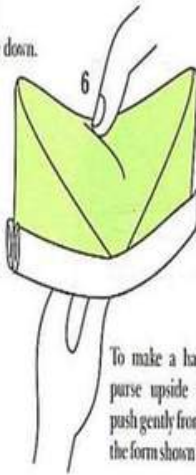

To make a hat turn the purse upside down and push gently from top to get the form shown in fig. 7.



Make a hat large enough for yourself by using a wrapping paper or a multi-coloured newspaper.

# Doll Hat



## 24. DRINKING CUP

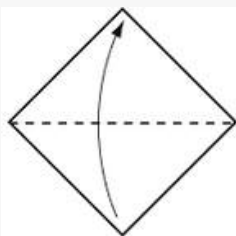

1. Start with your paper white side up. Fold in half, as shown.

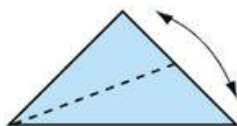

2. Fold the top corner down to the baseline. Crease well and unfold.

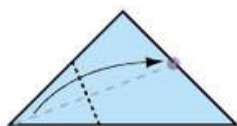

3. Fold the bottom left hand corner up to the crease line just made.

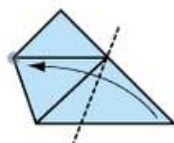

4. Now fold the bottom right hand corner up to the opposite side.

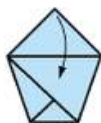

5. Fold the front flap downwards.

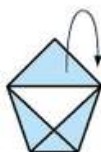

6. Now fold the back top flap backwards in the same manner.



7. Open out.

Your drinking cup is finished!

# Drinking Cup



# 25. FORTUNE TELLER

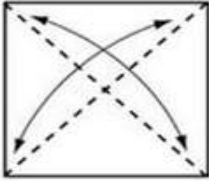

1. Start with white side up. Fold diagonally in both directions.

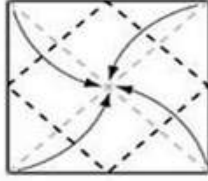

2. Fold each corner into the centre point.

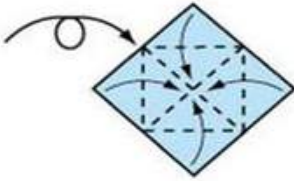
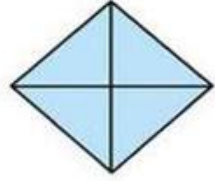

3. Turn over and again fold each corner into the centre point.

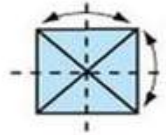

4. Fold in half along creases shown, both ways, and open.

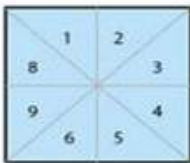

5. Number each segment from 1-8.



6. Open up each flap and write a fortune in each segment. Below are some examples of fortunes you can write, but you can also make up your own.

# Fortune Teller

# 26. HOME SWEET HOME

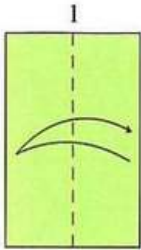

1  
Fold in half and unfold.

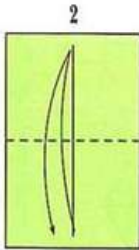

2  
Again, fold in half from top to bottom and unfold.



3  
Fold the top edge backwards to align it with the centre line.

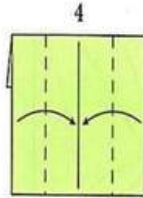

4  
Fold the left and the right edges inwards to the centre line.



5  
Fold the upper middle corners and unfold.

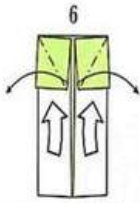

6  
Insert your thumb where thick arrows are indicated and open the corner. Flatten it out to form a triangular shape as shown in fig. 7.



7  
Fold the bottom edge upwards to align with the lower edge of the triangles

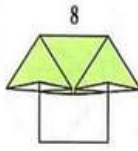

8  
... like this.



9  
Draw two windows and a door and the house is ready!



Turn over.

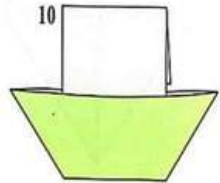

10  
If you turn it upside down, you get a pair of cup and saucer.

## Sweet Home



# 27. JAPANESE DOLL IN KIMONO

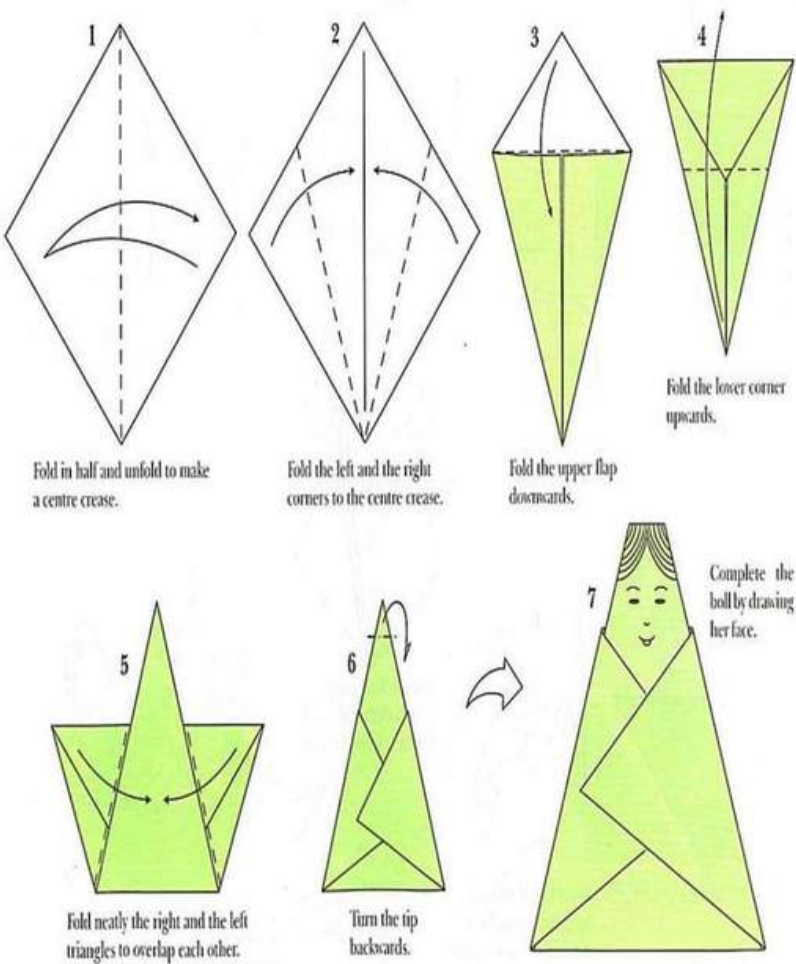

# Doll in Kimono



# 28. LOITERING MOUSE

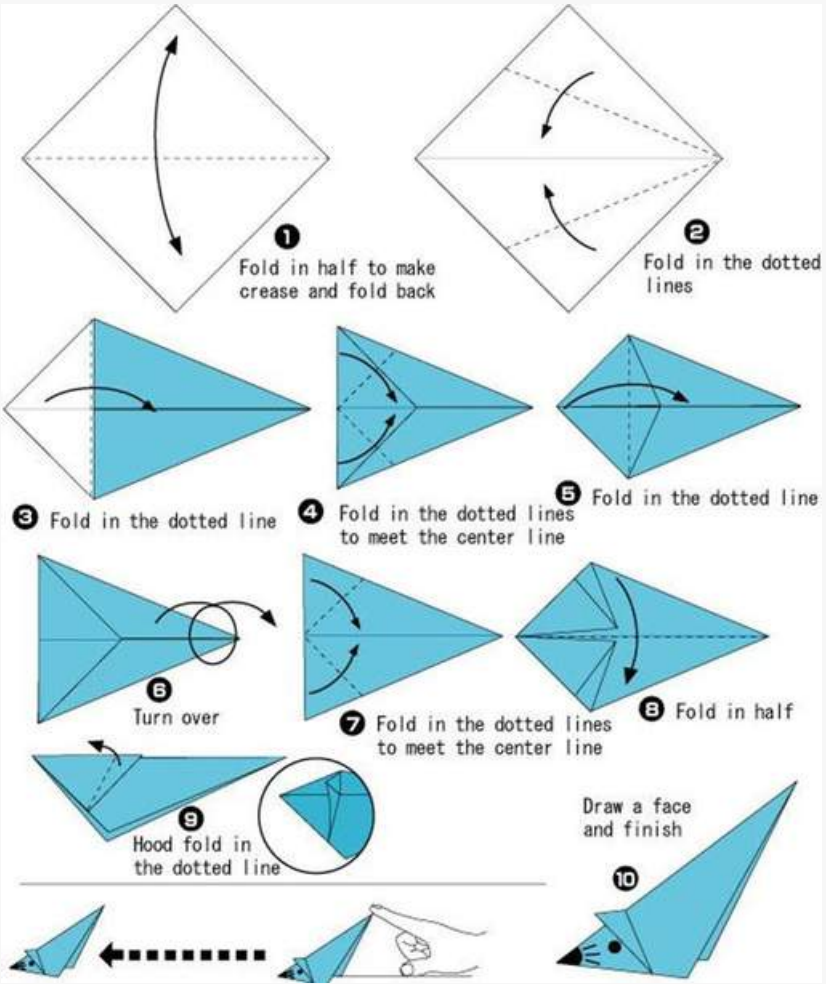

# Mouse





# 29. LUTOS FLOWER

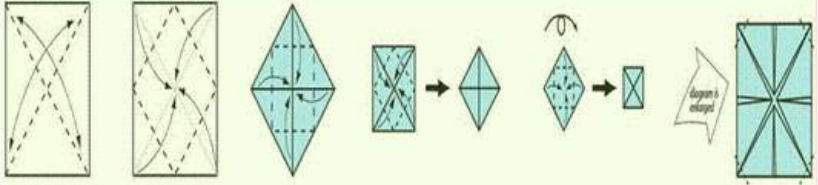

1. Start with white side up. Fold diagonally both ways and open.
2. Fold each corner into the centre.
3. Fold each corner into the centre once again.
4. For a third time fold each corner into the centre.
5. Turn model over and fold each corner into the centre.
6. Fold each corner inwards a small amount.

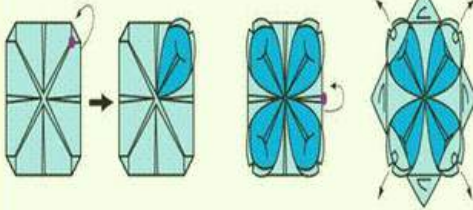

7. To form the petals, press down on the point shown, while slowly pulling the petal from behind, to the front. It's almost like turning the corner "inside out". Repeat on all corners.
8. The second set of petals are formed the same way but the corner from the point shows.
9. The third set doesn't need to be turned "inside out", just folded normally from below the first set.



# Lotus Flower

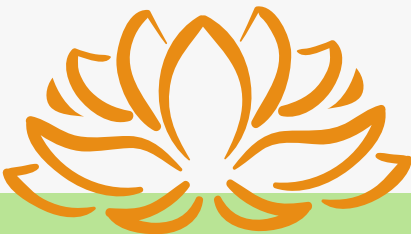



## 30. MOBILE

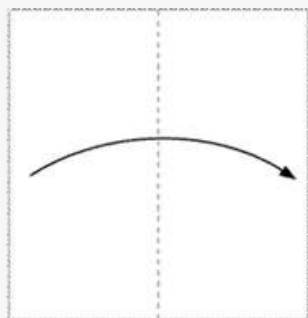

1 Fold in half



2 Fold in the dotted line

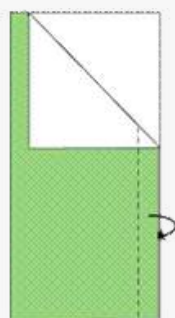

3 Fold inside in the dotted line

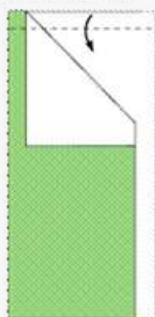

4 Fold in the dotted line

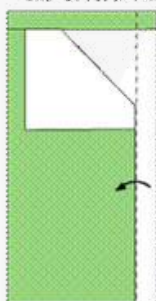

5 Fold in the dotted line

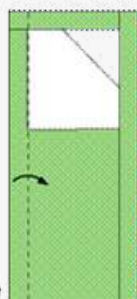

6 Fold in the dotted line



7 Fold in half to make creases and fold back

Draw numbers and finished

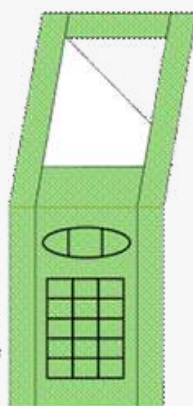

8

# A Mobile



# 31. OCTAGON STAR

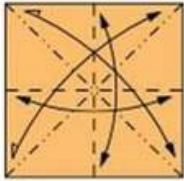

①

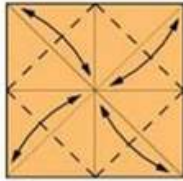

②

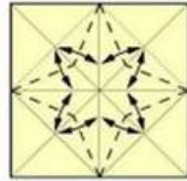

③

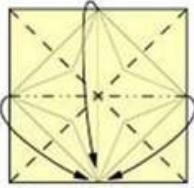

④

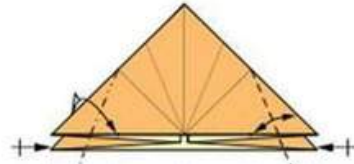

⑤

Piegare gli angoli di sinistra a monte e quelli di destra a valle e riaprirli.



⑥

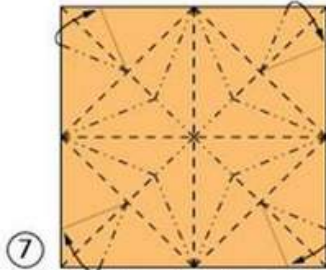

⑦

Piegare in modo che il centro del foglio sia la parte più sporgente.

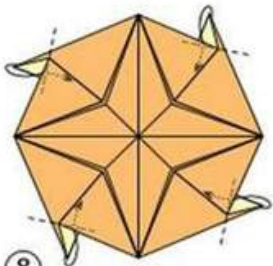

⑧

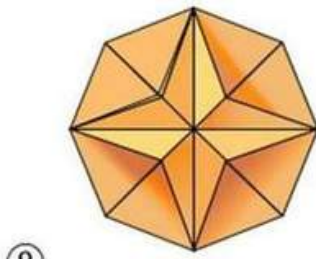

⑨

# Octagon Star



## 32. ONE PIECE 4

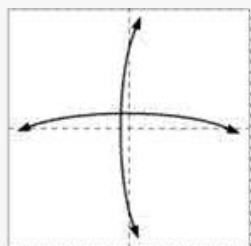

1 Fold in half twice to make a crease and unfold

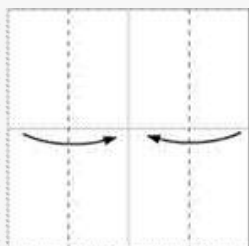

2 Fold in the dotted lines to meet the center line



3 Fold in the dotted lines

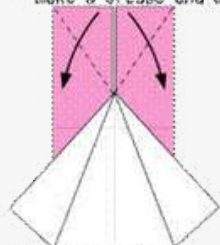

4 Fold in the dotted lines

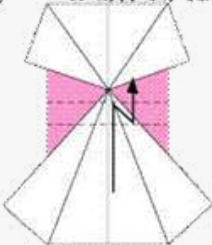

5 Step fold



6 Fold in the dotted lines

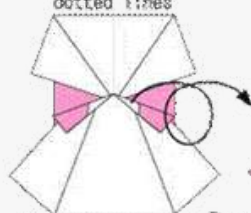

7 Turn over

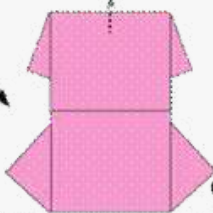

8 Cut with a pair of scissors

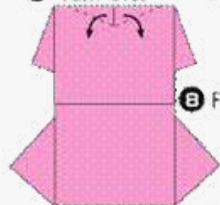

9 Fold



10 Cut



10 Finished

# An One Piece 4

### 33. ONE PIECE M6

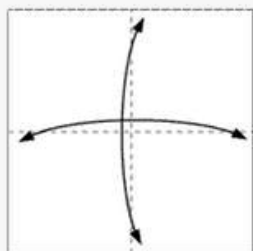

1 Fold in half twice to make creases and fold back

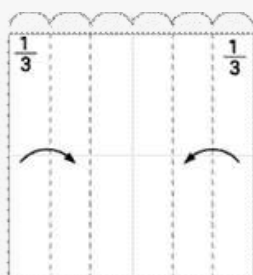

2 Fold

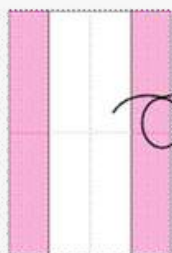

3 Turn over



4 Fold

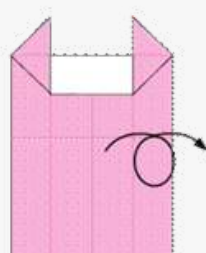
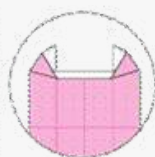

5 Turn over

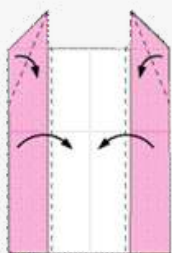

6 Fold



7 Fold

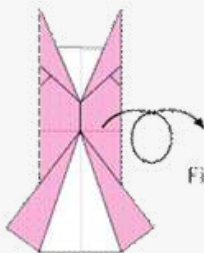

8 Turn over

Finished

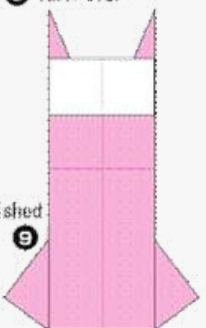

9

An One Piece M6

# 34. PERSIMMON

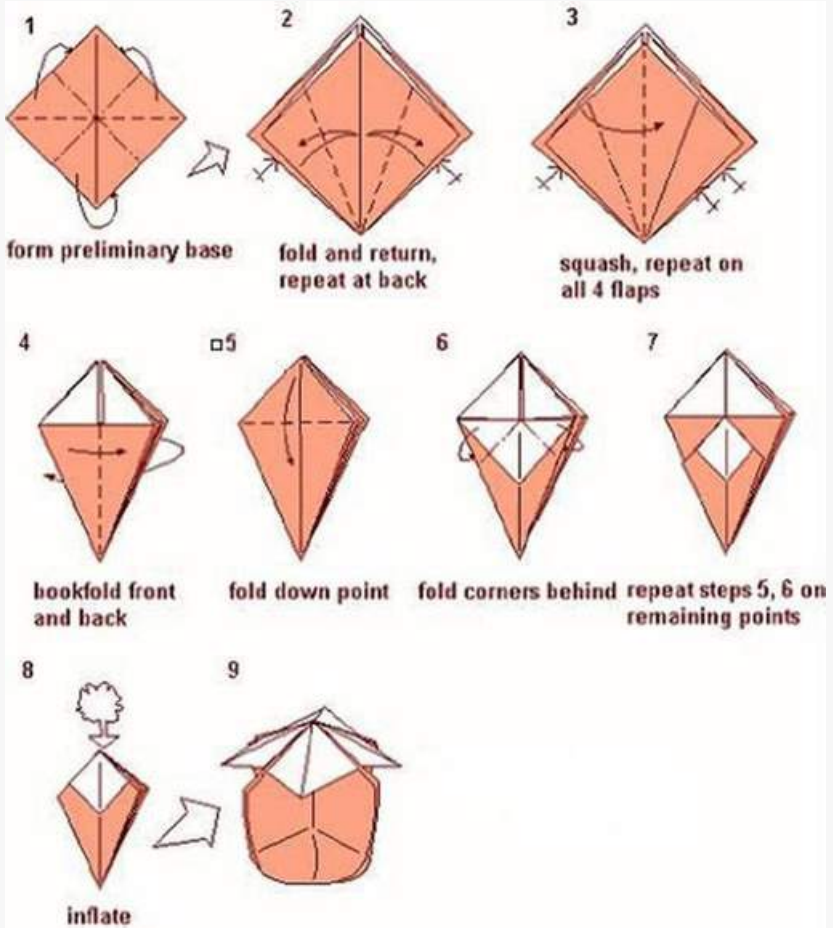

## Persimmon

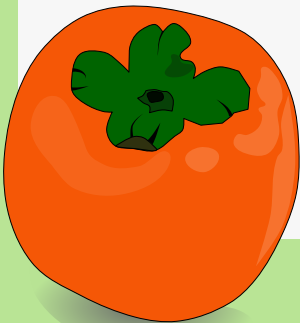

# 35.A PIGEON

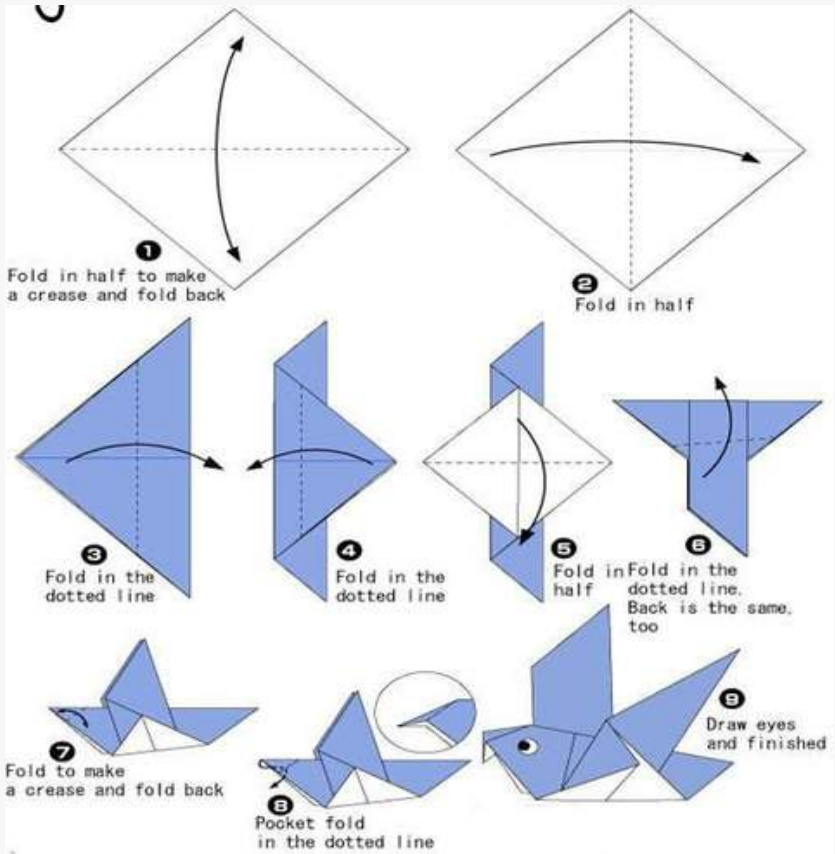

## A Pigeon

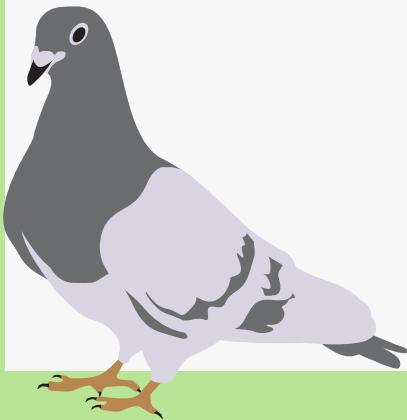

# 36. POLO SHIRT

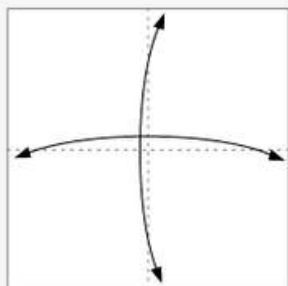

1 Fold in half twice to make a crease and unfold

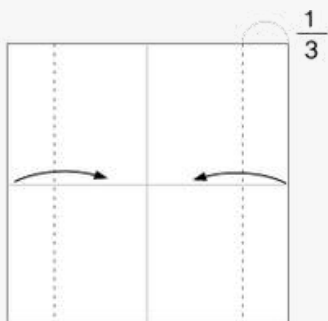

2 Fold in the dotted lines

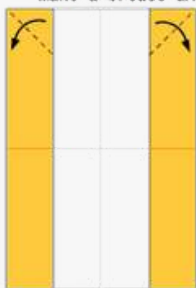

3 Fold forward in the dotted lines

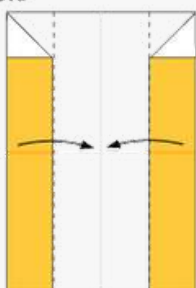

4 Fold in the dotted lines

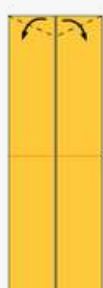

5 Fold forward in the dotted lines

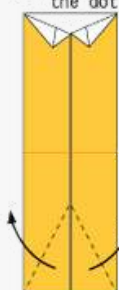

6 Fold forward

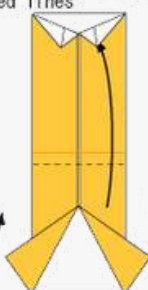

7 Fold and tuck under the collars



8 Fold backward in the dotted lines

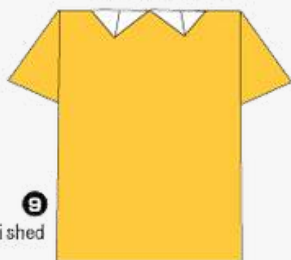

9 Finished

## A Polo Shirt





# 37. ROSE

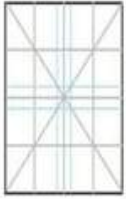

1. Make these creases.

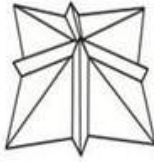

2. Form the 4 corners.

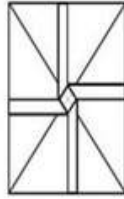

3. Flatten, while rotating counter-clockwise.

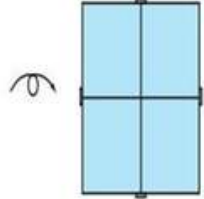

4. Turn over.

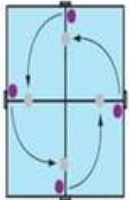

5. Form the 3D rose by taking each top right corner and folding to next quadrant, counter clockwise.

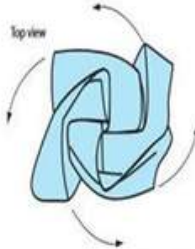
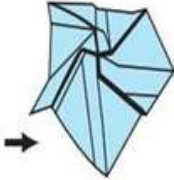

6. Form rose within the palm of your hand.

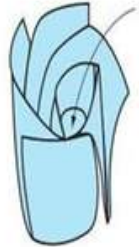

7. Turn over and smooth inside of rose, by pressing down slightly at the base.



8. Fold down edges and tuck in to form the bottom of the rose.



9. Turn over, open centre of flower and smooth.



10. Roll the petals down to curve them. Finished rose.



# Rose



# 38. SAMURAI HAT

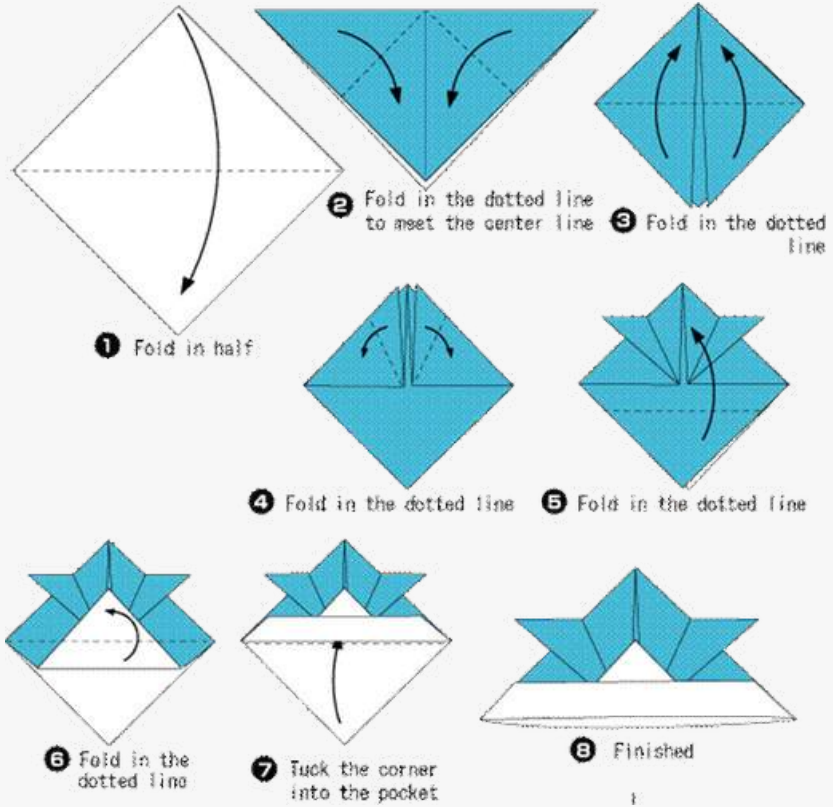

# Samurai Hat



# 39. SIMPLY HAPPY STAR

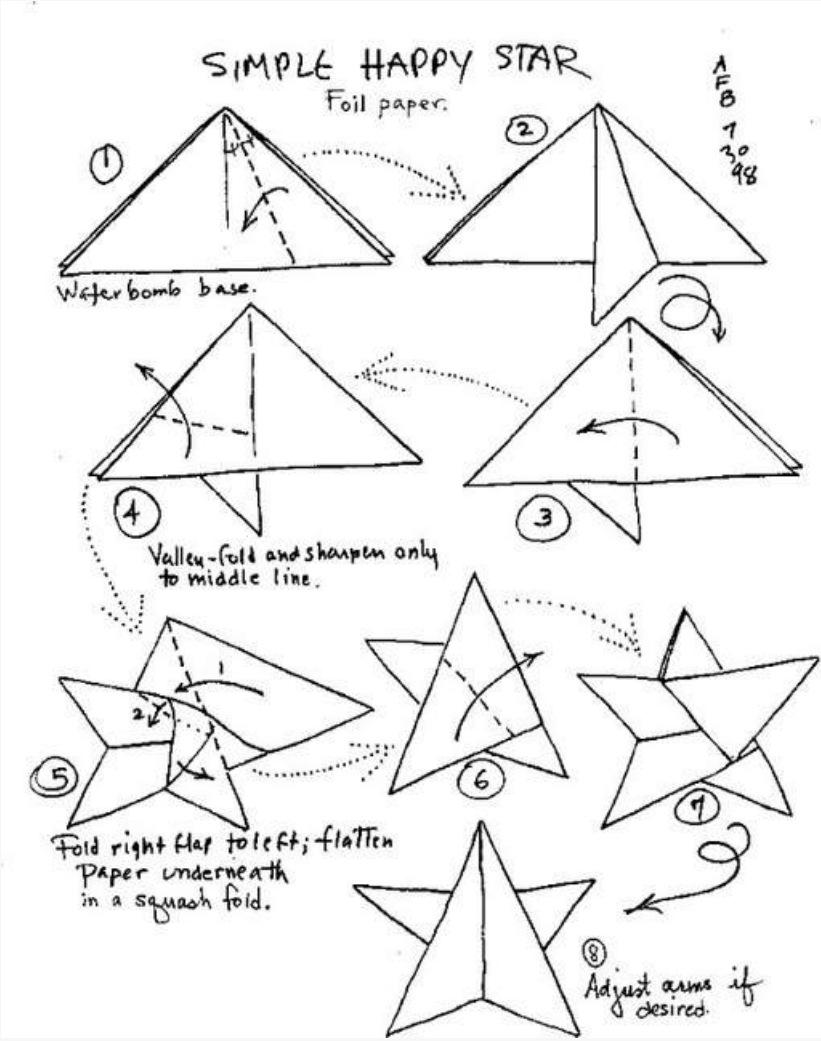

## Happy Star



# 40. TALKING DOG

Use a square of paper.

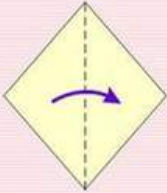

**1** Place a square of paper on the table so it looks like a diamond. Fold the left point to meet the right point.

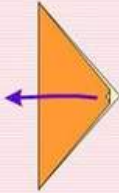

**2** Unfold.

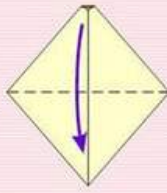

**3** Fold the top point down to meet the bottom point.

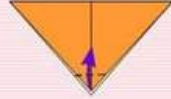

**4** Now there are two layers. Fold the top layer up a little bit, making a tiny triangle for a mouth.

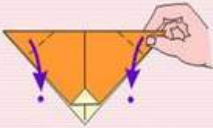

**5** Fold both the side corners down to the dots to form the ears, as shown. (The ears will cover part of the face.)



**6** Draw a face. If you hold it like this, you can move your hands together and back to make the dog "talk" face.)

## Talking Dog

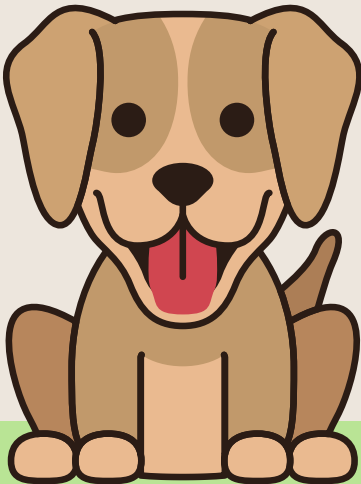

# 41. THE BUNNY

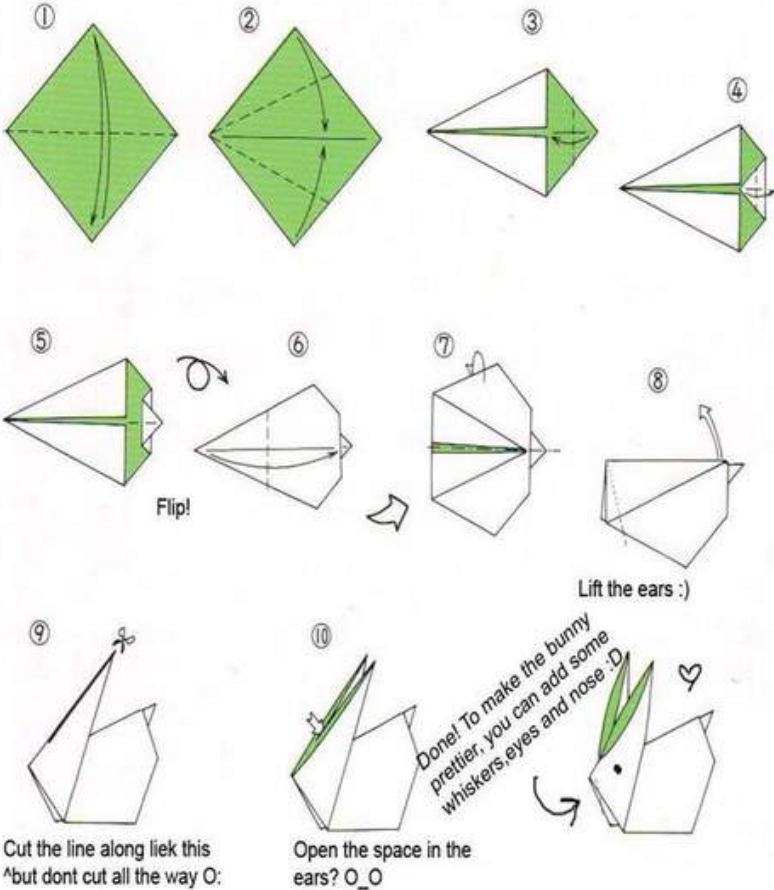

## The Bunny



# 42. THE CAT

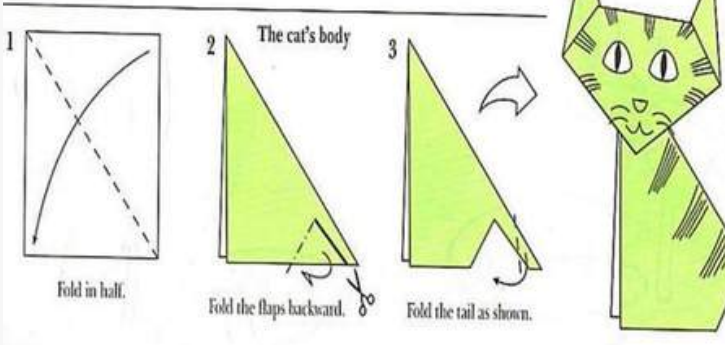
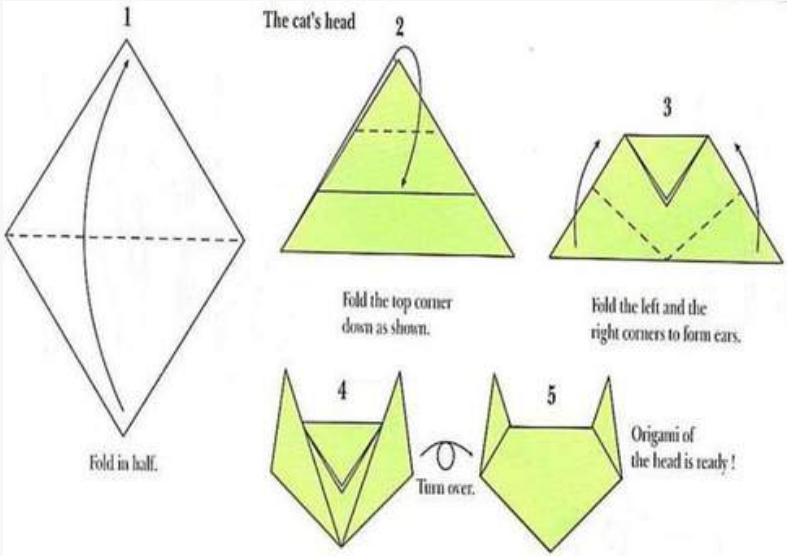

# The Cat

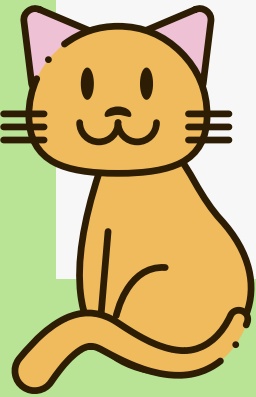

# 43. TRADITIONAL BOX

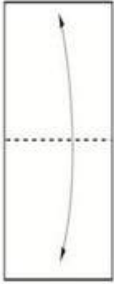

1. Start with a rectangular piece of paper, white side up.  
Fold in half, crease and open.

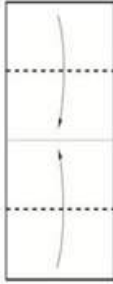

2. Fold top and bottom in to the centre crease.

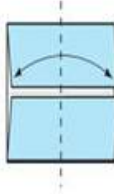

3. Fold in half, crease and open.

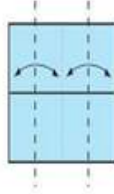

4. Fold outside edges in to the centre line and open.

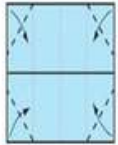

5. Fold each corner in to the creases made in the previous step.

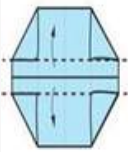

6. Take the inside edges and fold them outwards over the corner triangles. Crease well.

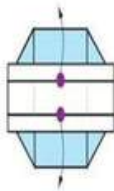

7. Grip the model at points down and open outwards. The box will form itself. You can pinch the corners to make it more rectangular.

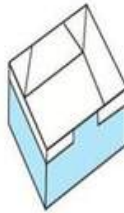

Finished Traditional Box.

# Traditional Box



# 44.A YELLOW BOX

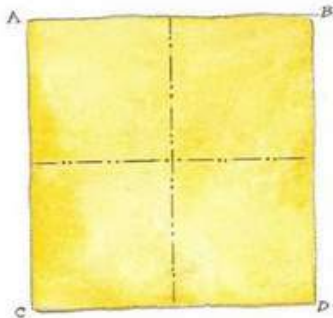

**1** Mountain fold horizontally and vertically across the centre, unfolding each time.

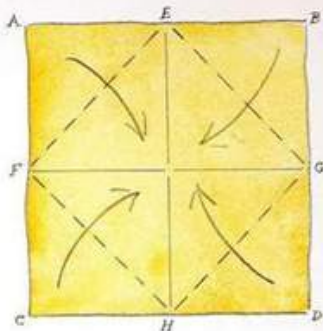

**2** Fold the corners to the centre. (The existing creases are mountains.)

**3** Fold each edge in turn to the centre point, unfolding each crease before making the next.

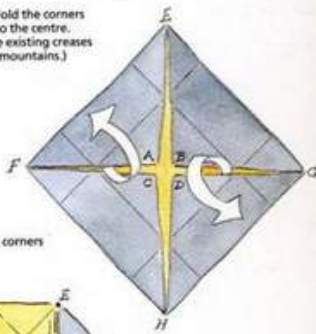
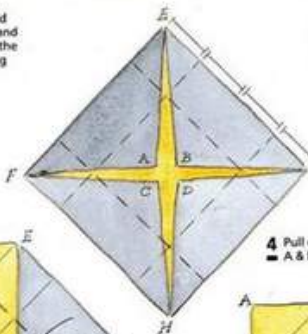

**4** Pull open corners A & D.

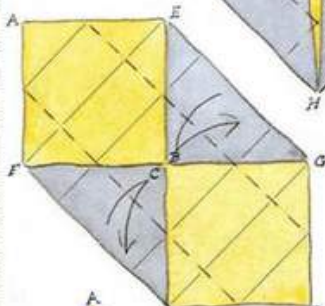

**5** Re-create valleys where shown.

**6** Make the paper 3D by bringing F & E to the centre dot

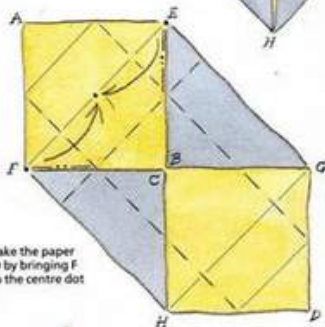

**7** ... like this. Lock the end of the box by folding A over the top and into the middle.

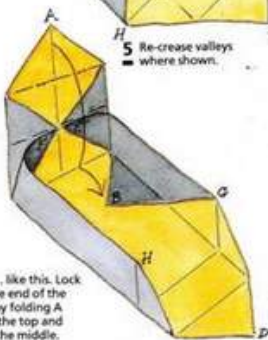

**8** Repeat Steps 6-7 with H & G, folding D over the top to lock.

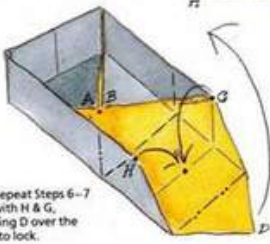

**9** The Traditional Box complete.

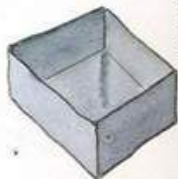

# A Yellow Box

**ORIGAMI CRAZE**

# **MODERATE DESIGNES**

**FOR LEARNERS**

**GET MORE DESIGNS AND IDEAS AT  
[WWW.ORIGAMICRAZE.COM](http://WWW.ORIGAMICRAZE.COM)**



## 45. A BALLOON

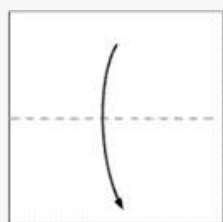

1 Fold in half

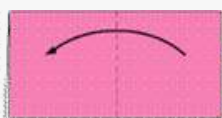

2 Fold in half



3 Open the  part



4 Flatten the space

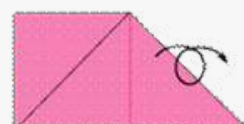

5 Turn over

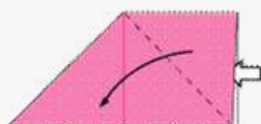

6 Open the  part like fig 3

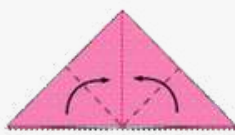

7 Fold in the dotted lines to meet the center line

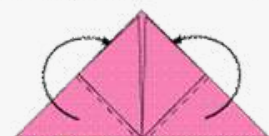

8 Fold backward in the dotted lines

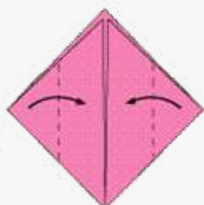

9 Fold in the dotted lines

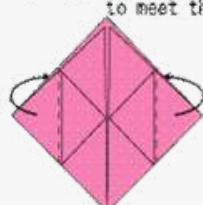

10 Fold backward in the dotted lines



11 Tuck them into the pockets



12 Blow up from 

13 Finished

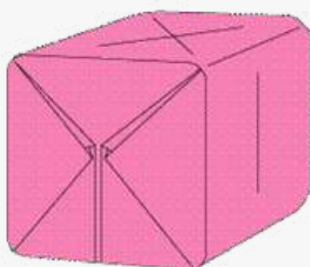

# A Balloon



# 46. A BEAR CUB

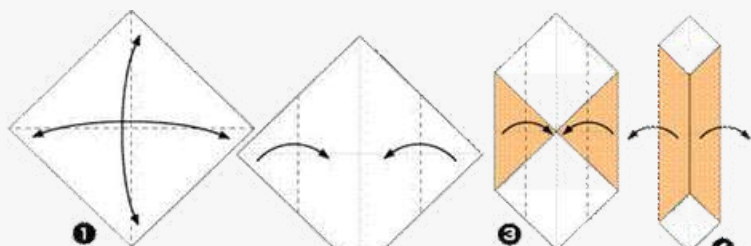

1 Fold in half twice to make creases and fold back

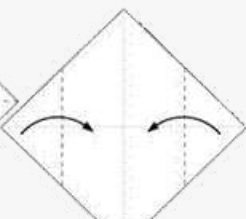

2 Fold to meet the center line

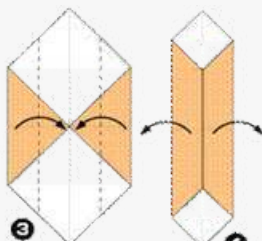

3 Fold to meet the center line

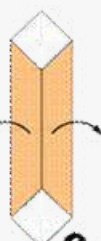

4 Open

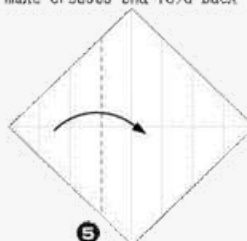

5 Fold in the dotted line

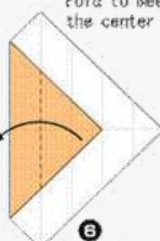

6 Fold in the dotted line

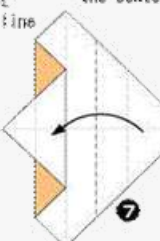

7 Folds as much as 6~7

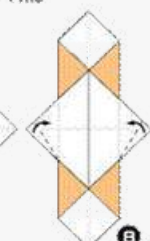

8 Fold in the dotted line

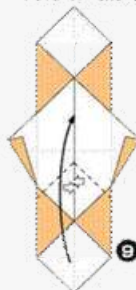

9 Open the  $\diamond$  part and flatten

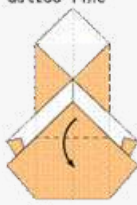
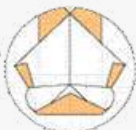

10 Fold in the dotted line

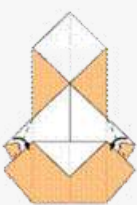

11 Fold in the dotted line

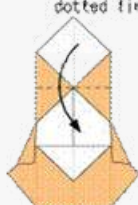

12 Fold in the dotted line

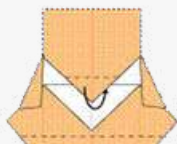

13 Fold backward in the dotted line

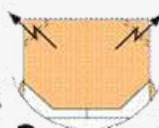

14 Step fold in the dotted line

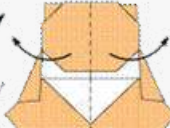

15 Folds a little in center line

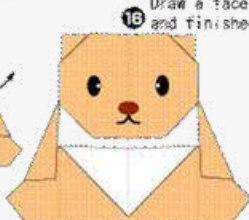

16 Draw a face and finished

## A Bear Cub



# 47. A BIRD

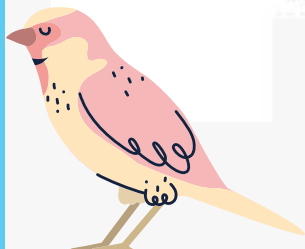
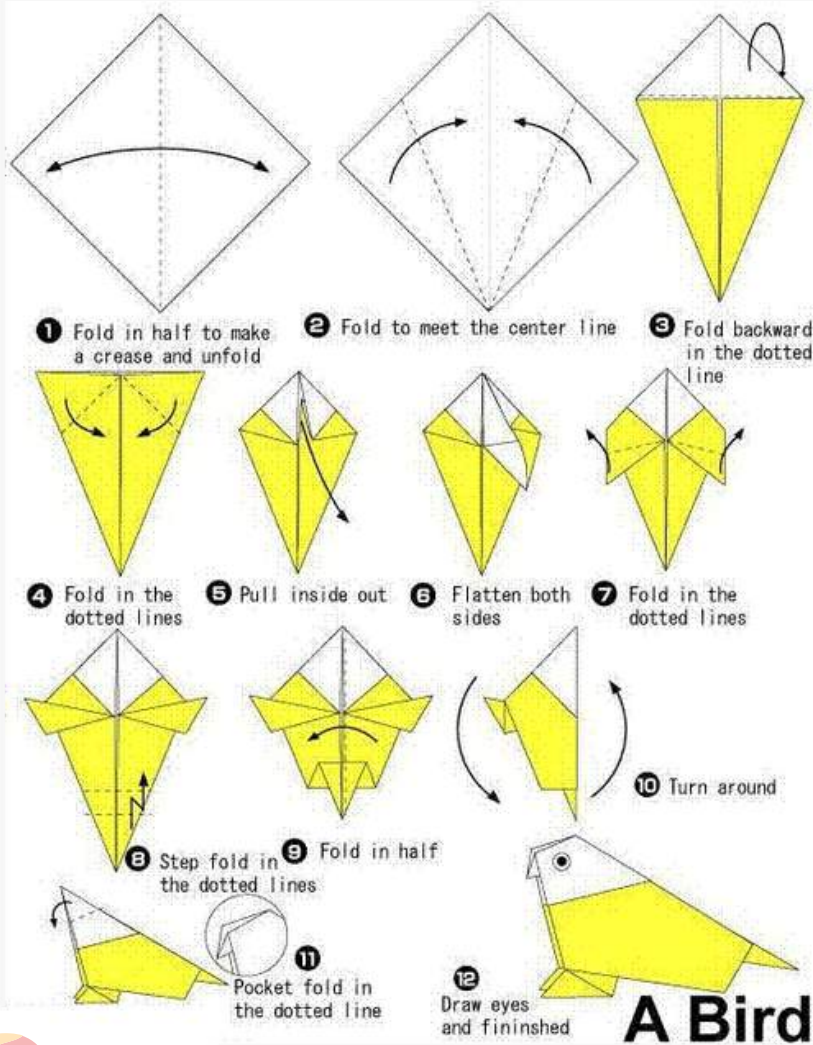

# 48. A BLINKING EYE

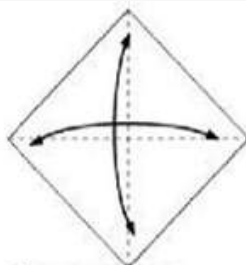

1 Fold in half to make creases

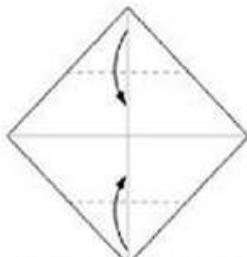

2 Fold in the dotted lines

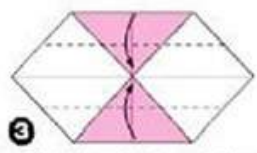

3 Fold in the dotted lines

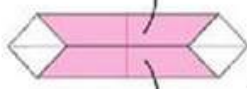

4 Open them

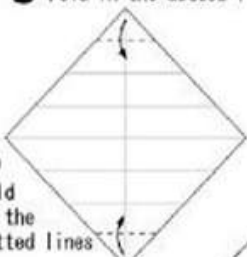

5 Fold in the dotted lines

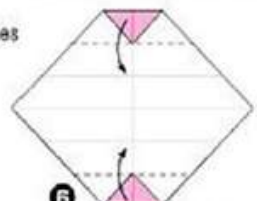

6 Fold in the dotted lines

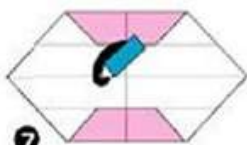

7 Draw a black eye

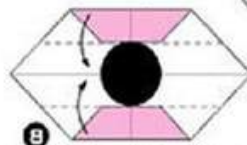

8 Fold in the dotted lines

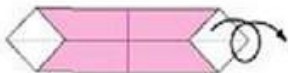

9 Turn over



10 Fold in the dotted lines



11 Fold in the dotted lines and fold back

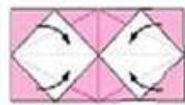

12 Fold a bit forward



13 Turn over

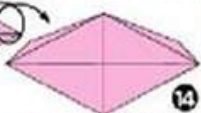

14 Finished

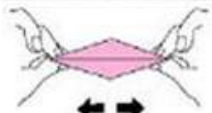

Pinch both sides and flirt the eye



## A Blinking Eye



# 49. A CARNATION

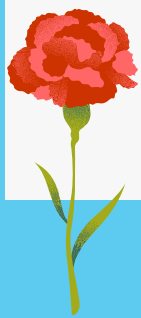
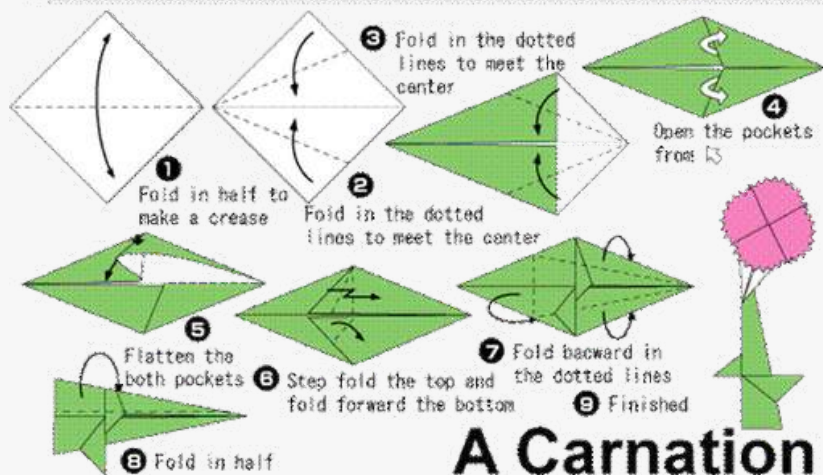
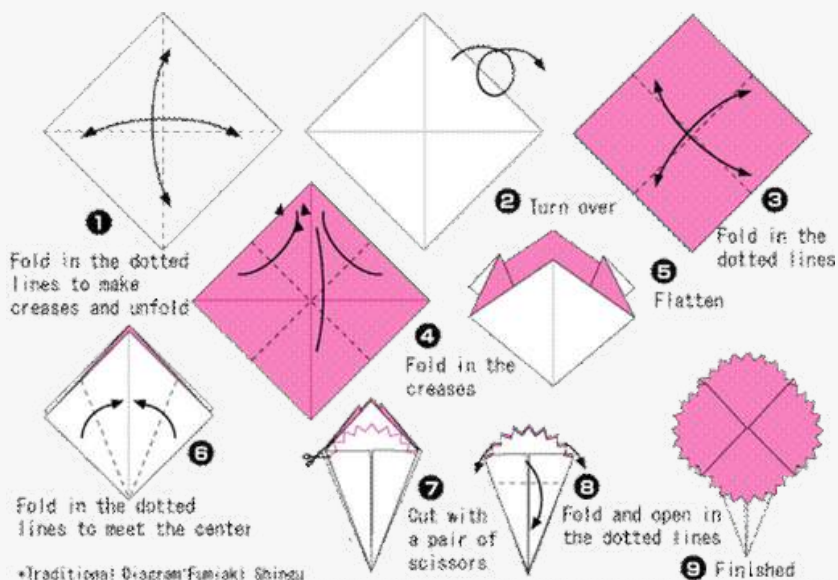



# 50. A CARROT

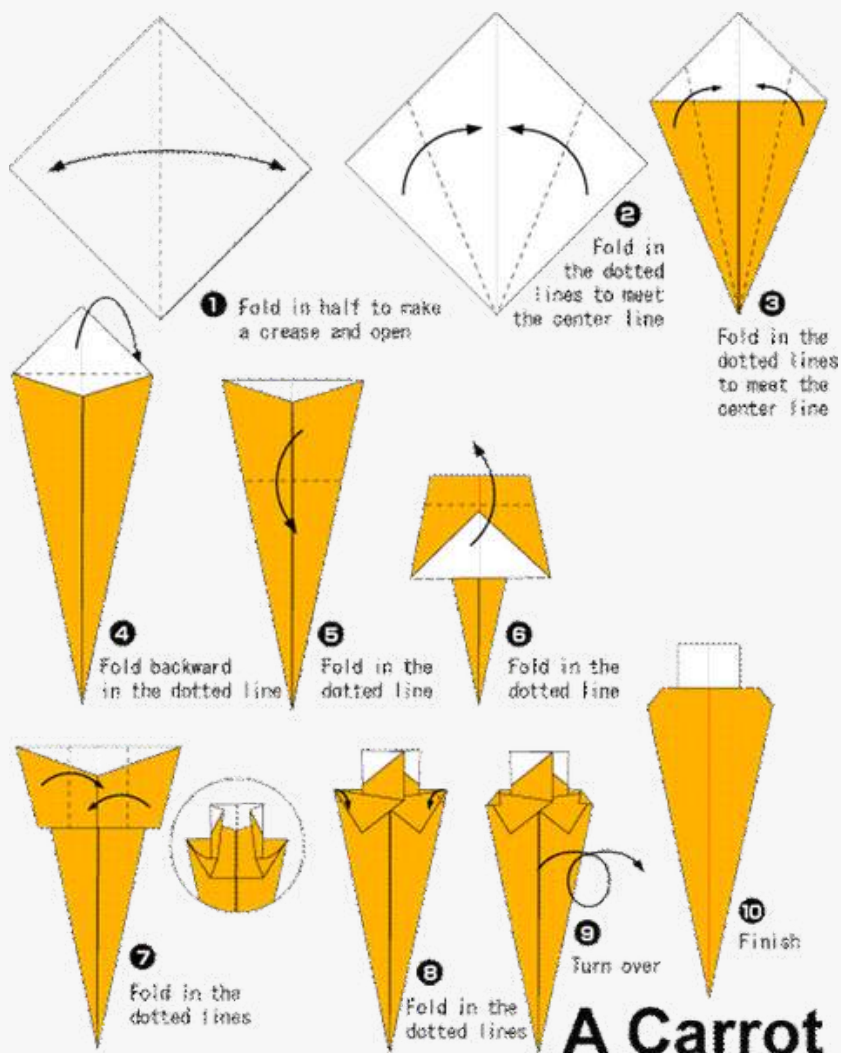

# 51. A DOG ON KENNEL

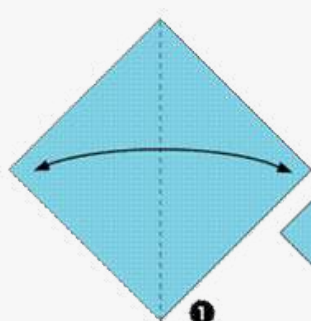

1 Fold in half to make a crease and fold back

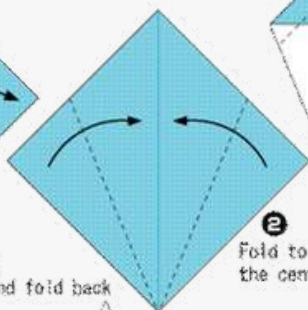

2 Fold to meet the center line

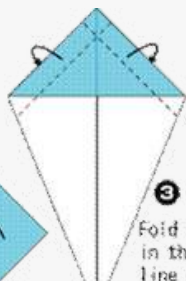

3 Fold backward in the dotted line

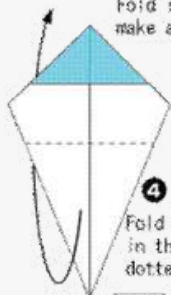

4 Fold backward in the dotted line

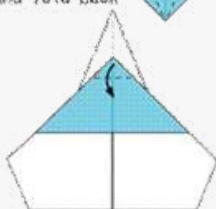

5 Fold in the dotted line

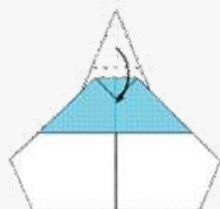

6 Fold in the dotted line

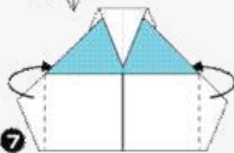

7 Fold backward in the dotted line

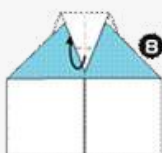

8 Fold backward in the dotted line

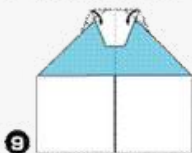

9 Fold backward in the dotted line



10 Draw spots and folds with the center a little



Finished

11

A Dog on kennel



# 52. A FLY AGARIC

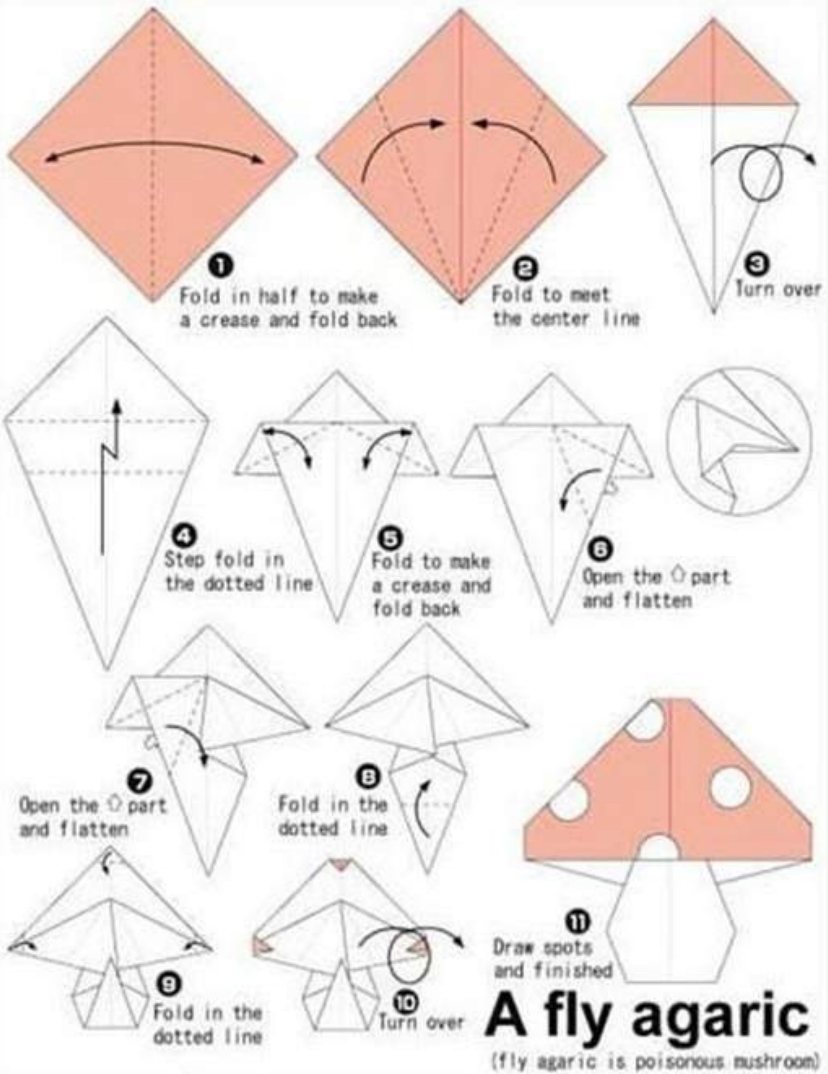



# 53. A HYDRANGEA

\* Fold with a quarter piece of origami paper

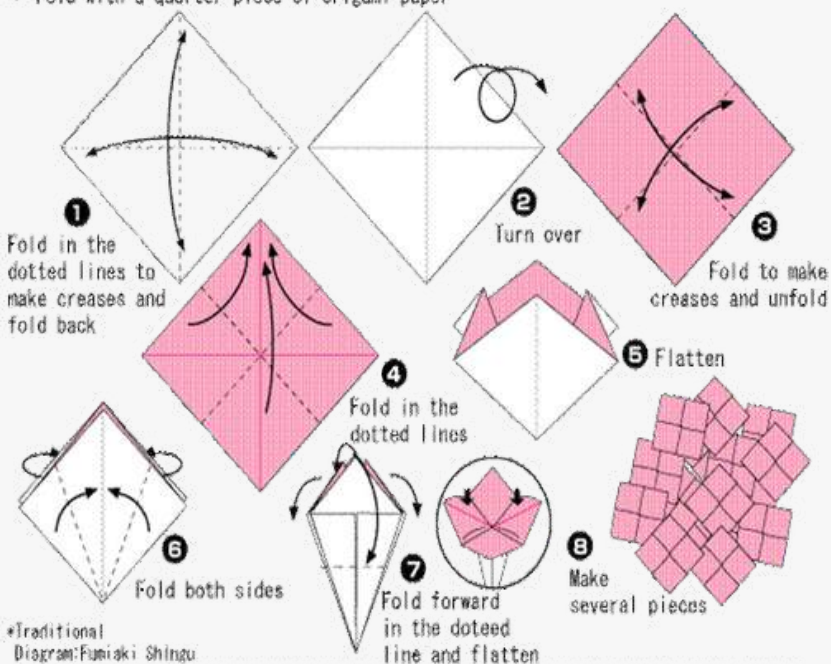

\*Traditional Diagram: Fuenaki Shingu

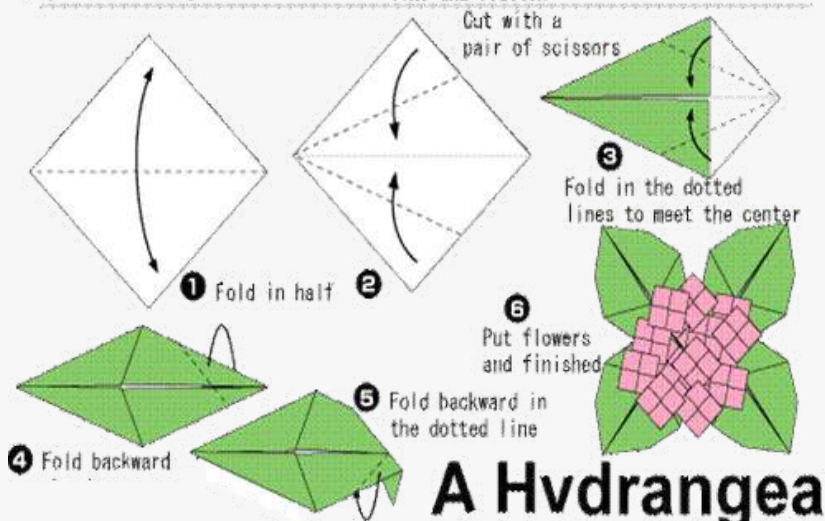

# A Hydrangea

## 54. A PIG

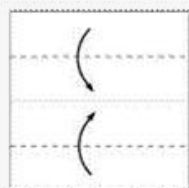

- 1 Fold in the dotted lines to meet the center line

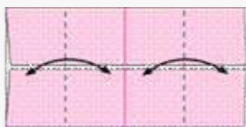

- 2 Fold in the dotted lines to make crease



- 3 Fold forward in the dotted line



- 4 Open the pocket from the top and flatten to triangle

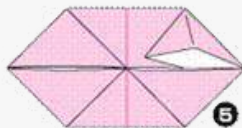

- 5 Follow the same step as 4 to the other three

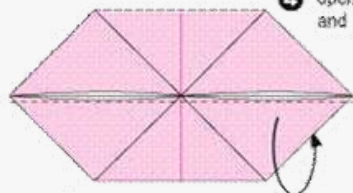

- 6 Fold backward in the dotted line



- 7 Fold forward in the dotted line

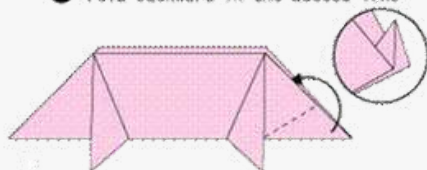

- 8 Pocket fold in the dotted line

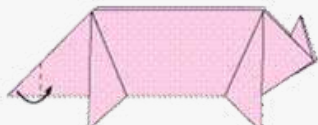

- 9 Fold forward in the dotted line

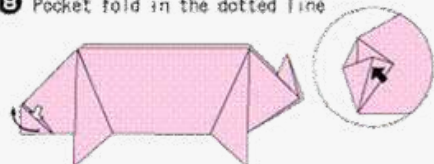

- 10 Open the pocket from the top and flatten to square

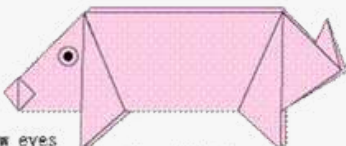

- 11 Draw eyes and finished

### A Pig

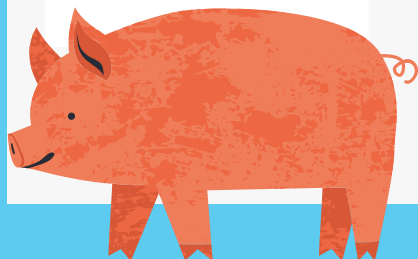

## 55. A RED FLOWER

Both sides of the hexagon piece of paper are coloured.



This is the back of the paper. Turn the paper.



Make mountain- and valley-folds over the 6 lines. Unfold each fold after you made one.



First, make 2 valley-folds below, at the 2 arrows. Make these folds from the edge to the center of the paper. Then, make 2 mountain-folds on the lines next to the first lines. Continue making valley- and mountain-folds until the 2 lines on top, on the left.



Make a valley-fold over the yellow line.



Unfold the model.



Now the center of the paper has to be folded down over the yellow lines. These are the lines you made with the valley-fold of step 4.



Here a part of the center is folded down already.



Press the outside of the model back in the shape it had in step 4, but now with the center of the paper folded down.



Make an inside reverse fold over the yellow lines. Do the same with the other 5 petals.



The flower is ready!

# Red Flower



# 56. A TURTLE

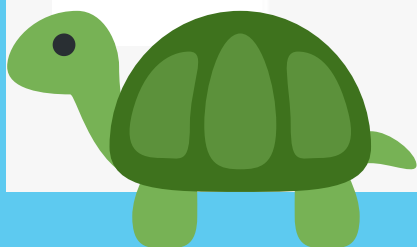
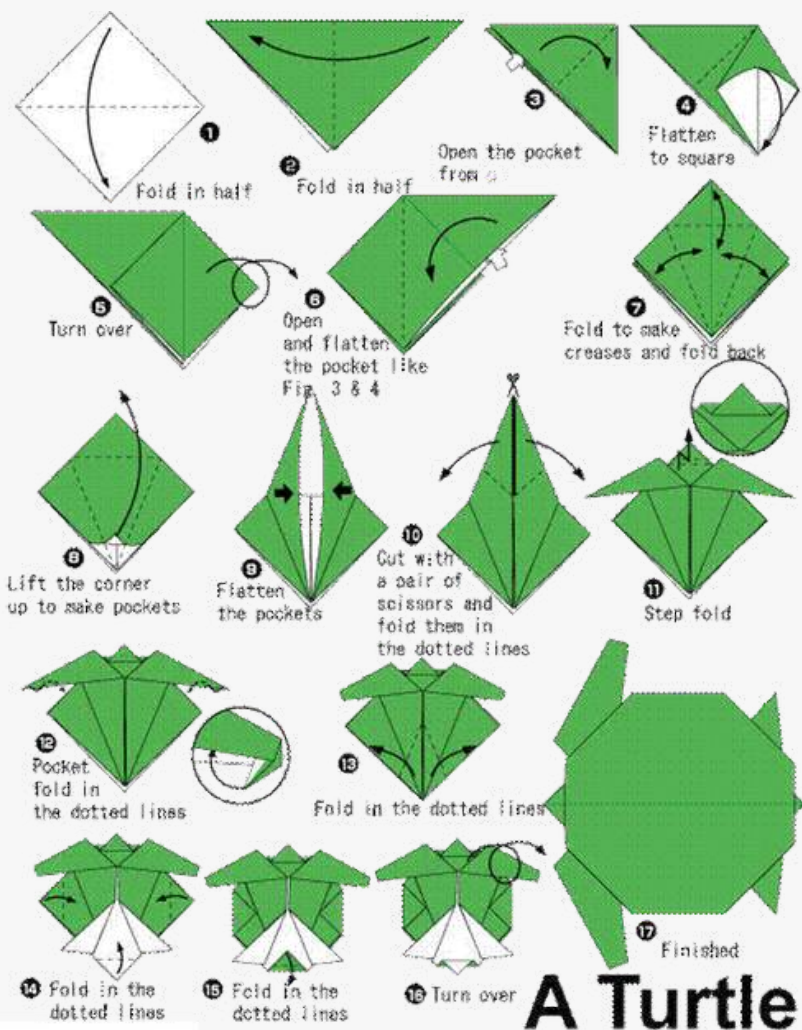

# 57. AN IRIS

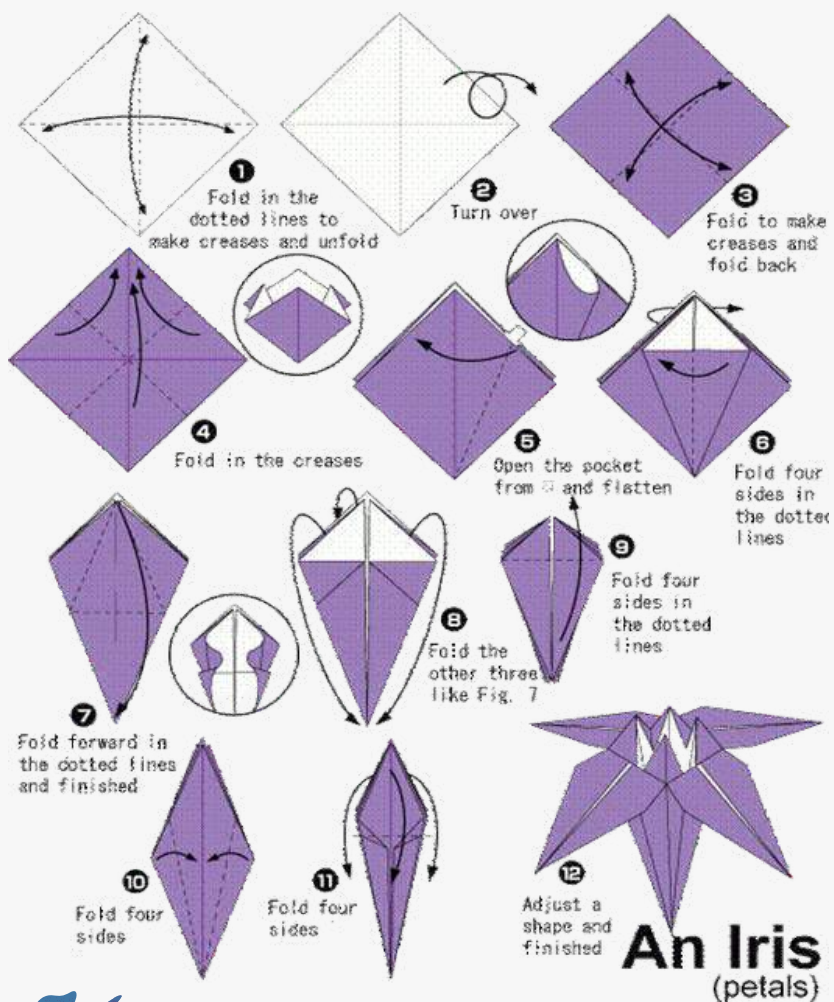



# 58. BREAD BASKETS

Use a stiff napkin to make Basket B.

(Basket A)

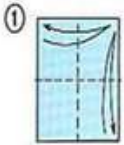

Make creases.

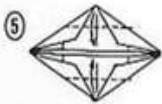
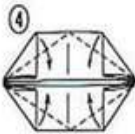
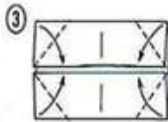
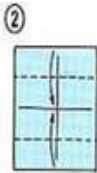

Gently turn inside out.



finished

(Basket B)

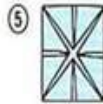
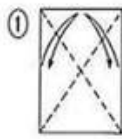

Turn it over.

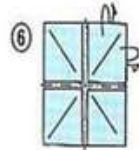
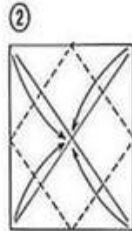

Make creases.

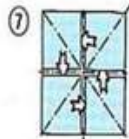
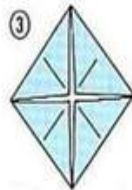

Insert fingers and stand on points.

Turn it over.

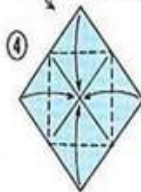

finished

# Bread Box

# 59. CABBAGE BUTTERFLY

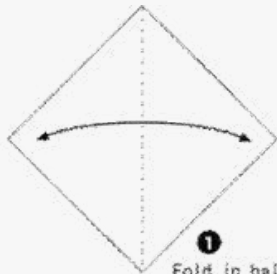

1 Fold in half to make a crease and unfold

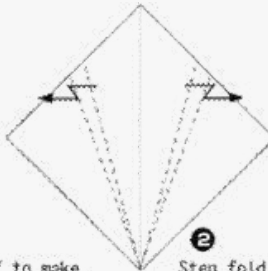

2 Step fold in the dotted lines

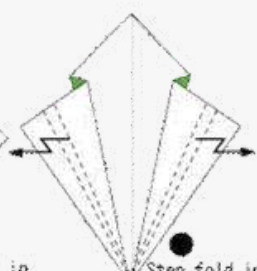

3 Step fold in the dotted lines

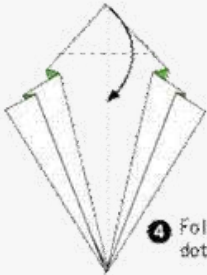

4 Fold in the dotted lines

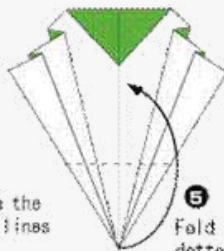

5 Fold in the dotted lines

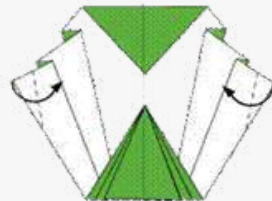

6 Fold in the dotted lines

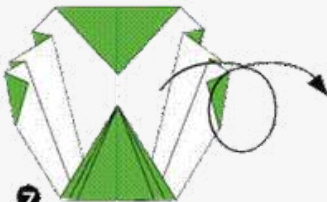

7 Turn over

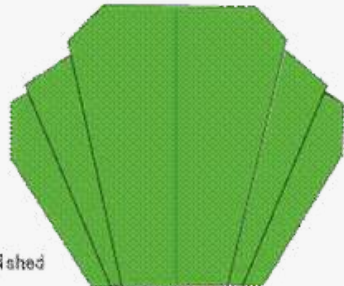

8 Finished

## A Cabbage

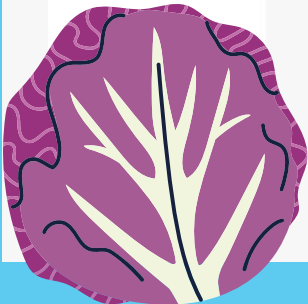

## 60. CANDY DISH

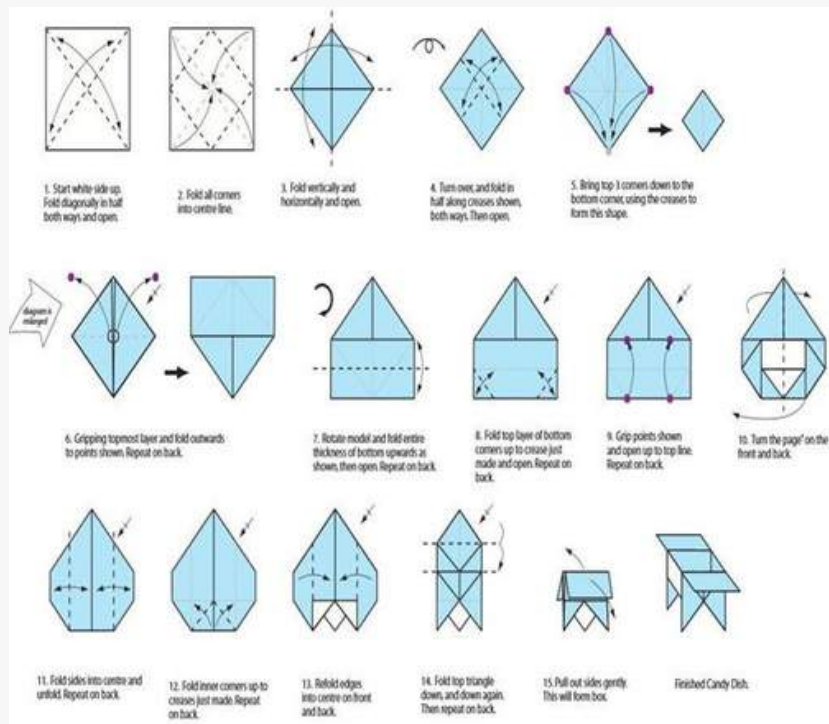

# Candy Dish





# 61. CRAB

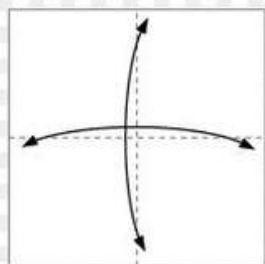

1 Fold in half twice to make creases and fold back

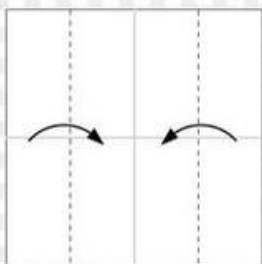

2 Fold to meet the center line

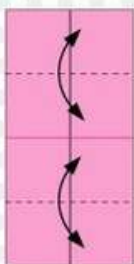

3 Fold to make crease and fold back

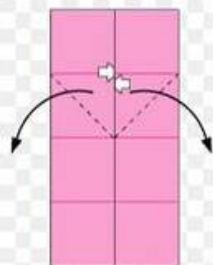

4 Open the  part and flatten

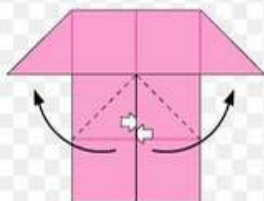

5 Open the  part and flatten

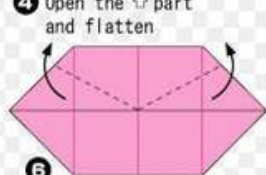

6 Fold in the dotted line



8 Fold in the dotted line

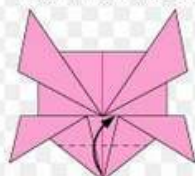

9 Fold in the dotted line



10 Turn over

Draw eyes and finished

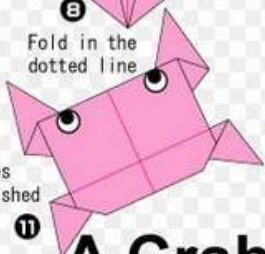

**A Crab**



# 62. DOLLAR BILL

Dollar Bill  
**Armadillo**  
Jim Cowling

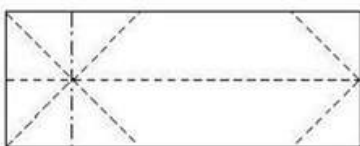

1

Fold in half and along the edges to lock the pleats.

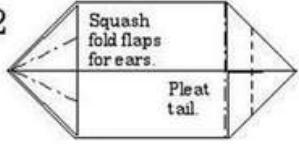

2 Squash fold flaps for ears. Pleat tail.

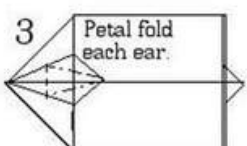

3 Petal fold each ear.

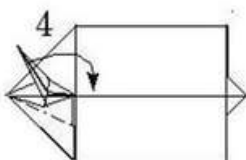

4

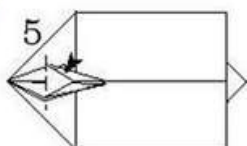

5 Fold under and sink crown of head

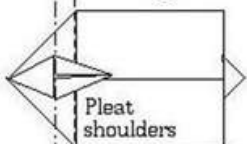

6 Pleat shoulders

Expand

Shape ears.

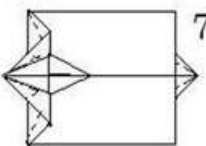

7

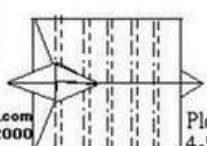

8 Pleat about 4-5 times.

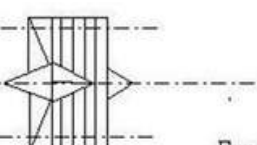

9

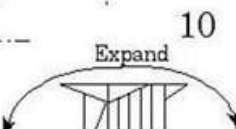

10



1.com  
2000

Narrow the face and shoulders. You can do the same to the tail if you wish.

cowling@aol.com  
Convention 2000

# Dollar Bill

## 63. DOLPHIN

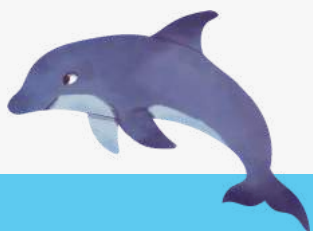
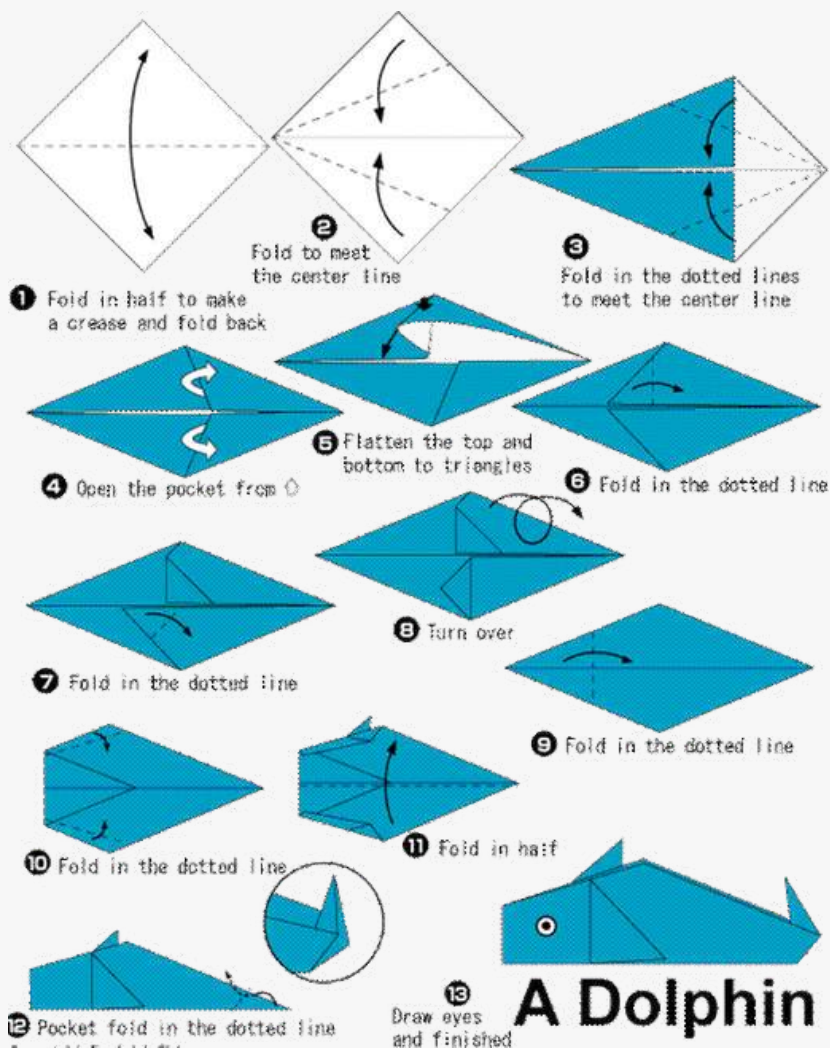

# 64. HAMSTER

## Hamster

1 Easy rate

These little rodents are an affectionate and entertaining breed. Most are missing several hamsters, and give each one a happy year!

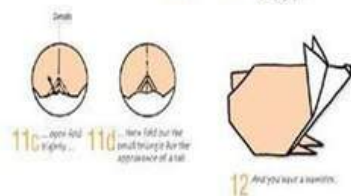
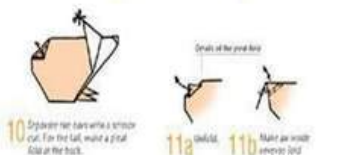
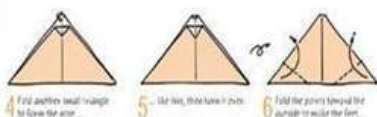
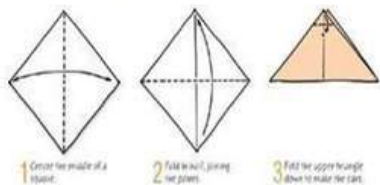

# Hamster

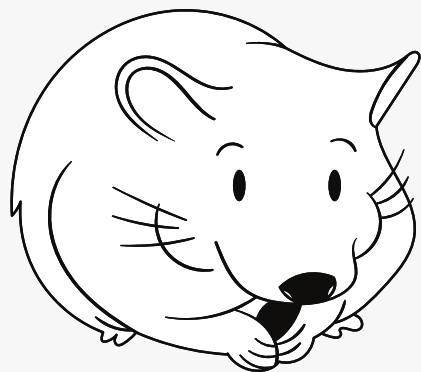

# 65. ONE PIECE DRESS

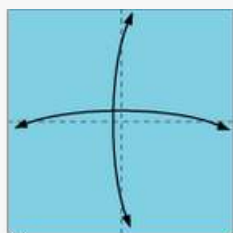

1 Fold in half twice to make a crease and unfold

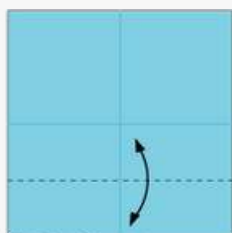

2 Fold to make a crease and unfold



3 Fold in the dotted line

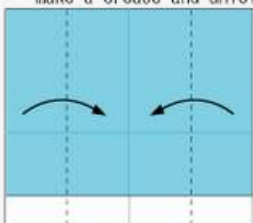

4 Fold in the dotted lines

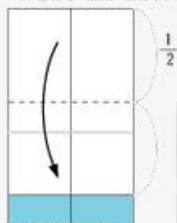

5 Fold in the dotted line

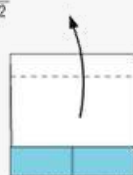

6 Fold in the dotted line

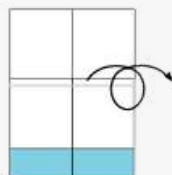

7 Turn over



8 Fold to make creases and unfold

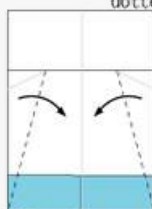

9 Fold in the dotted lines

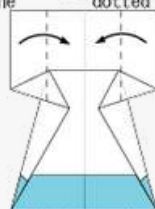

10 Fold in the dotted lines

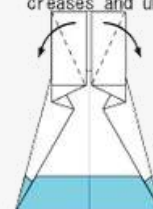

11 Fold



12 Turn over

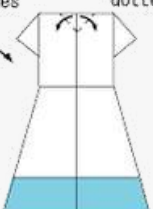

13 Fold



14 Finished

An One Piece Dress 3



# 66. SANTA CAP

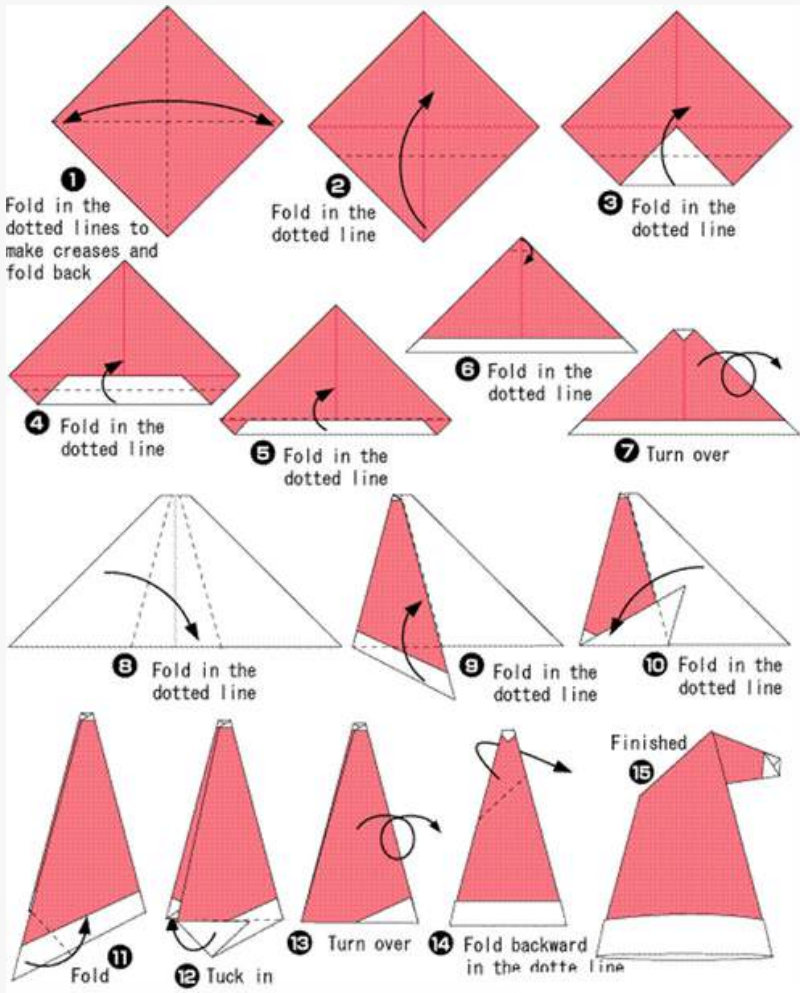

# Santa Cap





# 67. STAR BOX

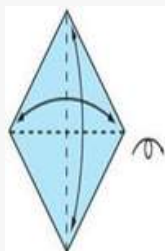

1. Start with a square piece of paper, coloured side up. Fold in half and open, then fold in half the other way.



2. Turn the paper over to the white side. Fold the paper in half, crease well and open, and then fold again in the other direction.

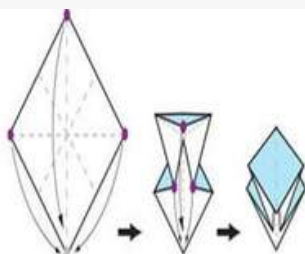

3. Using the creases you have made, bring the top 3 corners of the model down to the bottom corner.



4. Flatten model. This is a Square Base.

5. Rotate Square Base so the open end is at the top.

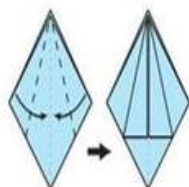

6. Fold the uppermost outer flaps in to meet the centre line.



7. Repeat Step 6 on the back side.

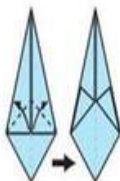

8. Fold each flap up toward the outer edge of the model and crease well.

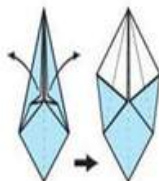

9. Open out the flaps, and flatten.



10. Repeat Steps 8 & 9 on the back side.

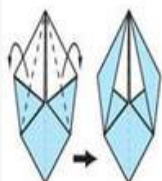

11. Tuck the top flaps behind themselves. Crease well.



12. Repeat Step 11 on the back side, so the model now looks like this.



13. Fold bottom of model upwards. Crease very well then unfold.

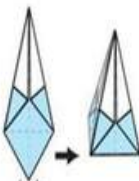

14. Push in the base of the model, along the creases you just made. This will form the base of the box.



15. Fold each point of the star downwards.



Finished Star Box



## Star Box

# 68. STRAWBERRY

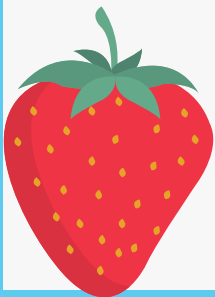
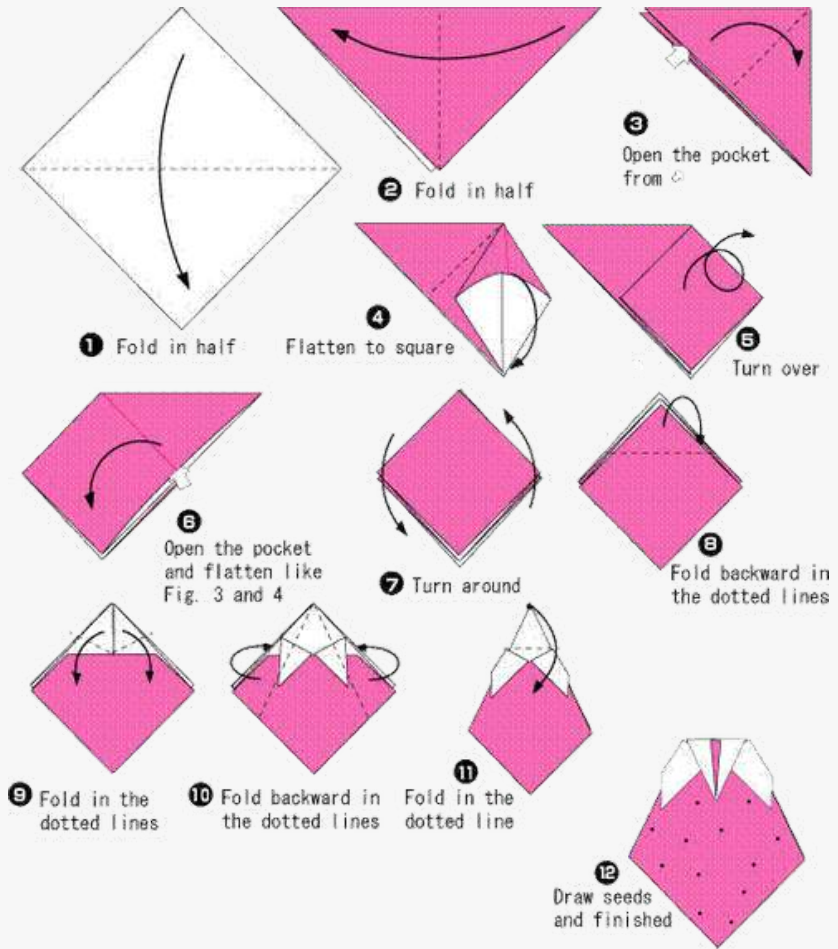

# Strawberry



# 69. THE BUTTERFLY

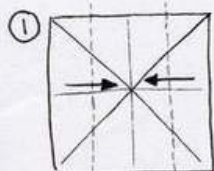

① MAKE CREASES TO FIND THE CENTRE. FOLD ON THE DOTTED LINES TO THE MIDDLE.

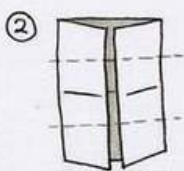

② VALLEY FOLD ON THE DOTTED LINES TO THE CENTRE.

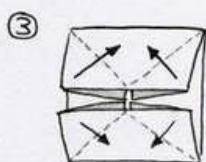

③ FOLD THE CORNERS AS SHOWN.

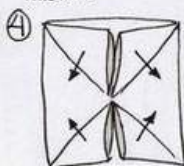

④ UNFOLD.

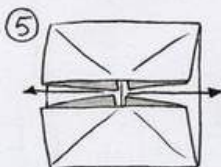

⑤ OPEN THE "WINGS" INSIDE OUT.

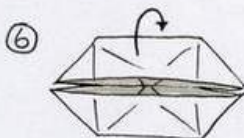

⑥ MOUNTAIN FOLD THE TOP "WING" TO THE BACK.



⑦ FOLD THE TOP LAYER ALONG THE DOTTED LINE FROM RIGHT TO LEFT.



⑧ PRESS THE INSIDE TRIANGLE FLAT. DO STEPS 7-8 ON THE OTHER SIDE.



⑨ FOLD THE TOP LAYER ALONG THE DOTTED LINE, RIGHT TO LEFT.



⑩ FOLD THE PAPER BACK ALONG THE DOTTED LINE FROM LEFT TO RIGHT.



⑪ REPEAT STEPS 9+10 FOR THE "WING" ON THE LEFT. TURN THE PAPER OVER.



⑫ FOLD INSIDE ALONG THE DOTTED LINE.



⑬ FOLD THE BOTTOM CORNERS ON THE DOTTED LINE. TURN OVER.



⑭ REVERSE FOLD THE TOP CORNERS INSIDE ON THE DOTTED LINES.

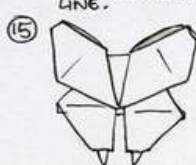

⑮ HAVE FUN WITH YOUR BUTTERFLY!



# Butterfly

# 70. TULIP

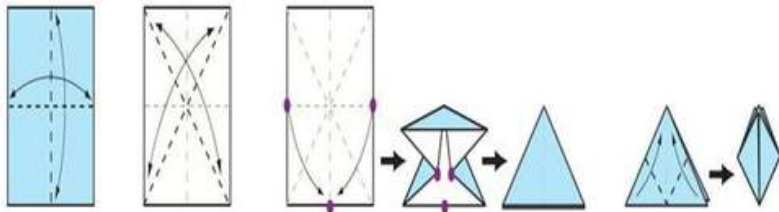

1. Start with your paper colored side up.

Fold in half, then in half again, as shown. Crease well, then open out again.

2. Turn the paper over and fold in half diagonally and in both directions. Crease well and open out once again.

3. Holding the points shown, bring them both down to the centre point on the bottom line.

Flatten model. This is called a waterbomb base.

4. Fold bottom corners of front flaps up to the top corner.

Repeat this on the back as well.

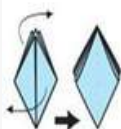

5. Turn the front flap to the left, like turning the pages in a book. Do the same to the other side of the model.

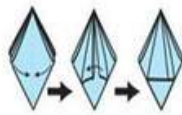

6. Move the upper flaps toward each other, and tuck one into the other, as far as it goes.

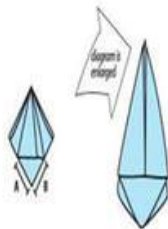

7. When you flatten this, make sure the distances  $a$  &  $b$  shown are equal.

8. Repeat steps 4 & 7 on back of model to get this.

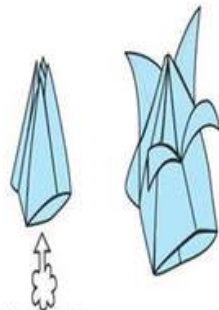

9. Blow into base of tulip to inflate and shape the flower.

10. Peel each petal down, slowly and carefully.

Finished tulip.

Pair with the Flower Stem.

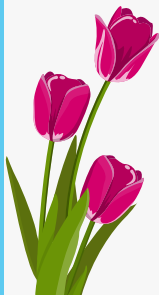

# Tulip

# 71. WATER FLOWER

## Waterflower

Traditional.  
Diagrammed by Aaron Walden.

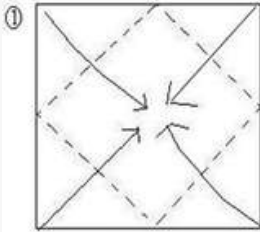

Valley fold four corners of square, to center.

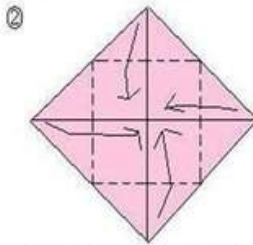

Valley fold four corners of square, to center.

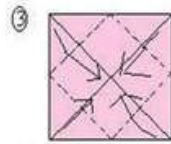

Valley fold four corners of square, to center.

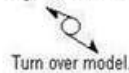

Turn over model.

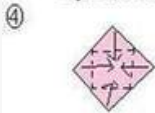

Valley fold four corners of square, to center.

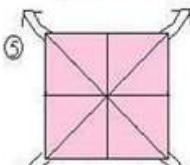

Bring forward top layer of each corner, from underside.

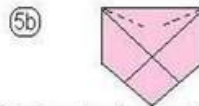

This is most easily accomplished by unfolding two of the sides (at a time) folded in the previous step, and refolding with the valley folds shown. Note that this illustration is shown from the bottom side.



Bring four corners together, so that petals stand upright.

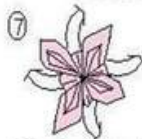

Bring forward next layer of corners from underside.

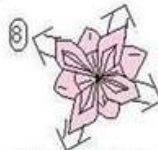

Bring forward final layer of corners from underside. Round and shape petals.



Completed flower

# Water Flower

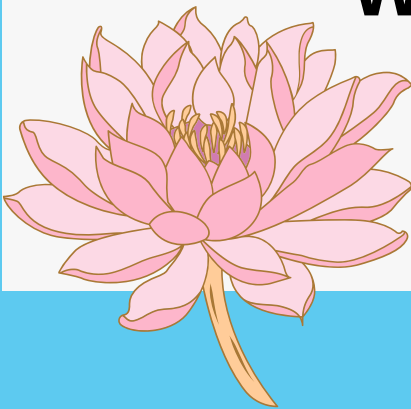

# 72. WATER MELON

(Rind)

1

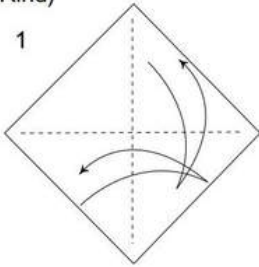

2

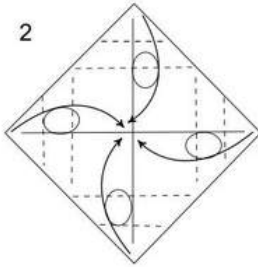

3

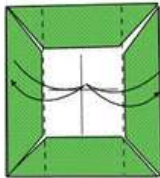

Fold and unfold.

4

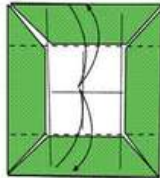

Fold and unfold.

5

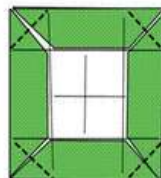

Fold behind and unfold.

6

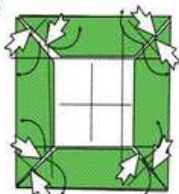

7

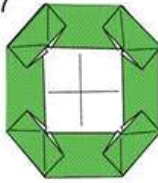

Here is the rind of the watermelon.

Write your message on the back, this becomes a greeting card.

Draw the seeds on the front.

(Let's assemble them.)

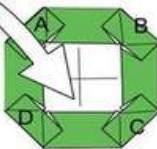

Insert the corners of the Fruit into 'A', 'B', 'C' and 'D' as shown.

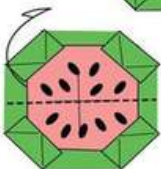

Here is a slice of watermelon.

## Water Melon

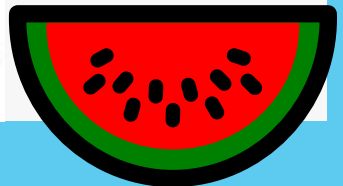

**ORIGAMI CRAZE**

# **HARD DESIGNES**

**FOR EXPERTS**

**GET MORE DESIGNS AND IDEAS AT  
[WWW.ORIGAMICRAZE.COM](http://WWW.ORIGAMICRAZE.COM)**

# 73. A DRAGON

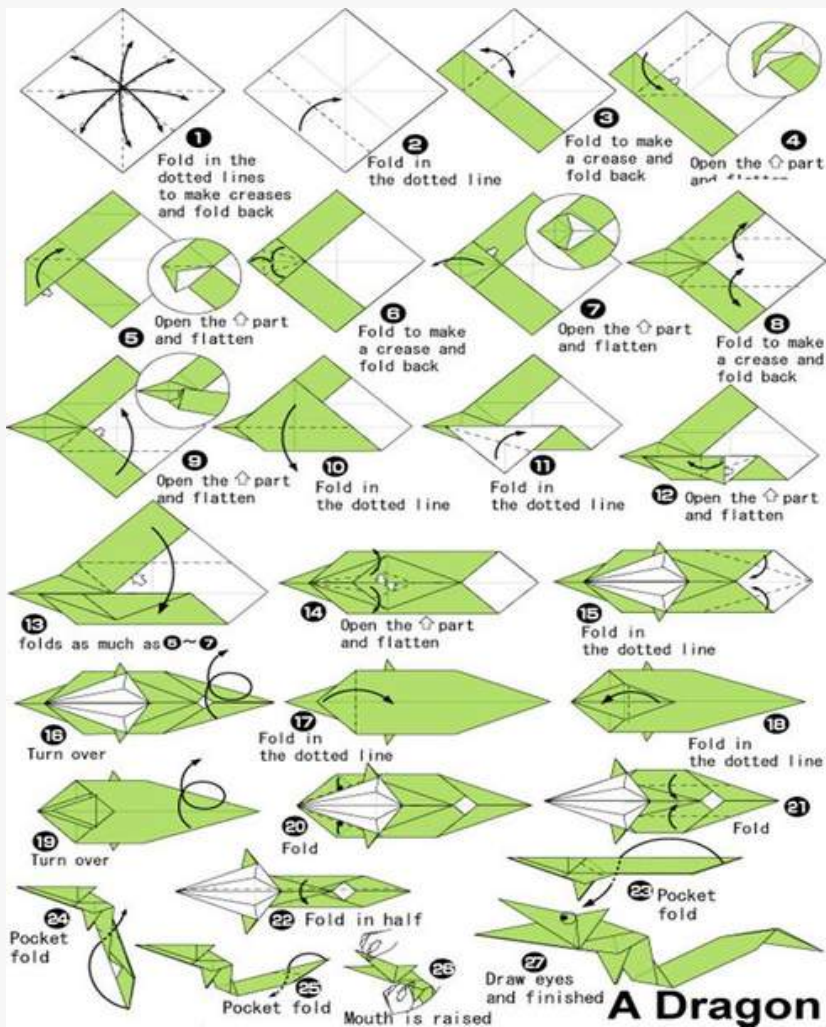



# 74. A FROG

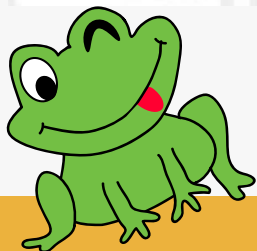
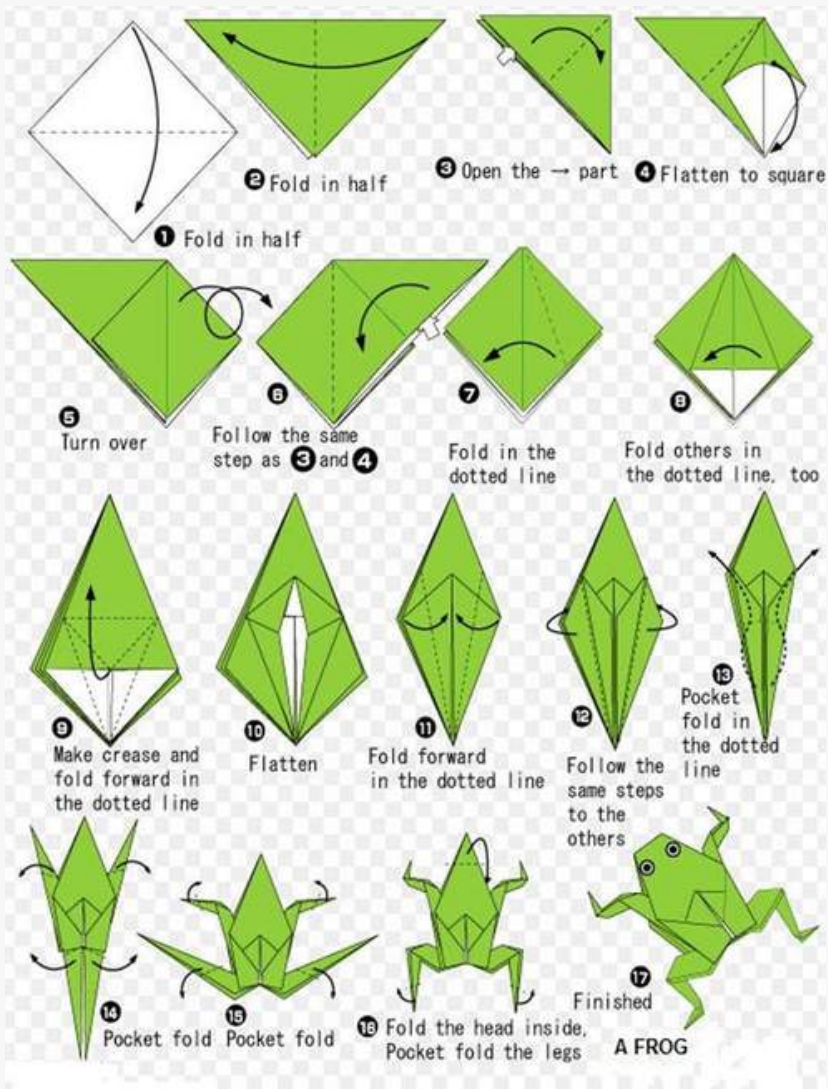

## A Frog

# 75. A GIANT WATER BUG

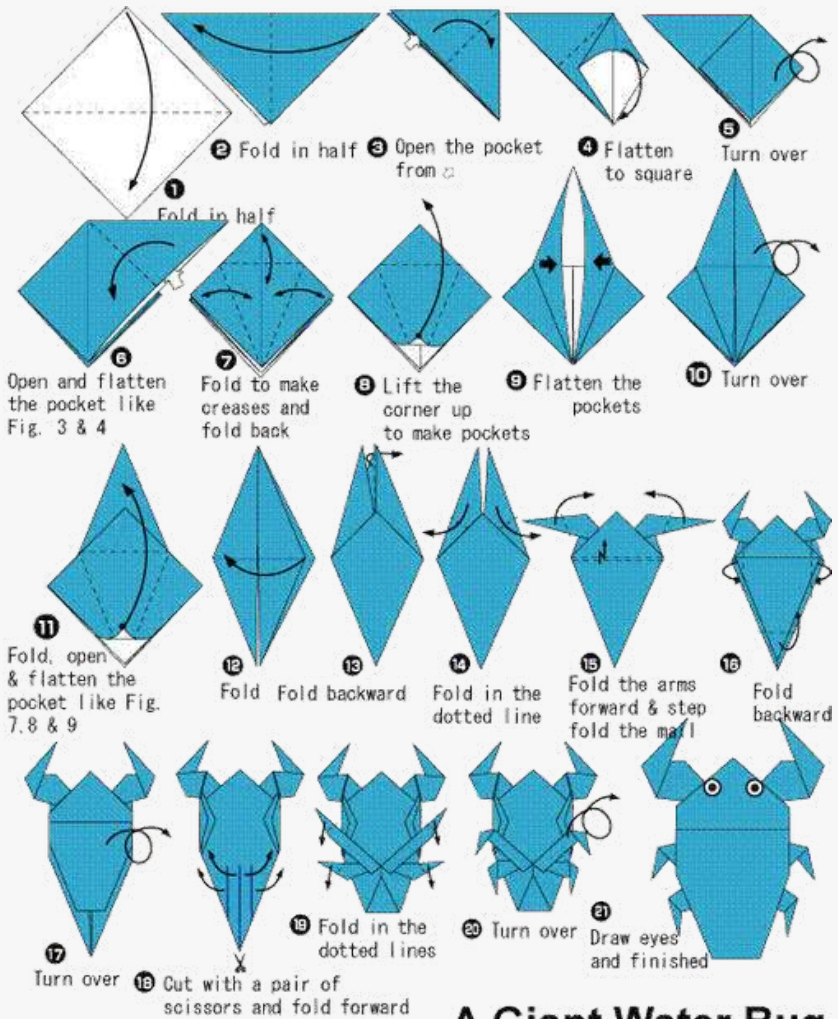

## A Giant Water Bug





# 76. A HEART CRANE

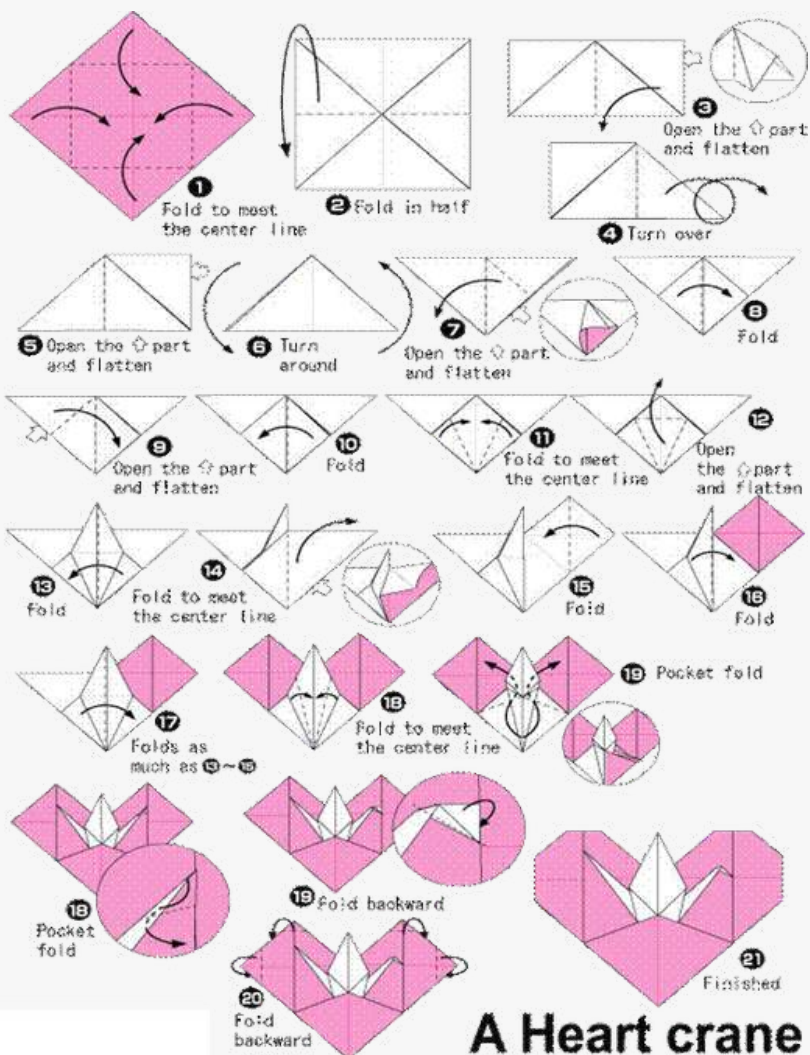

# 77. A HELMET CRAB

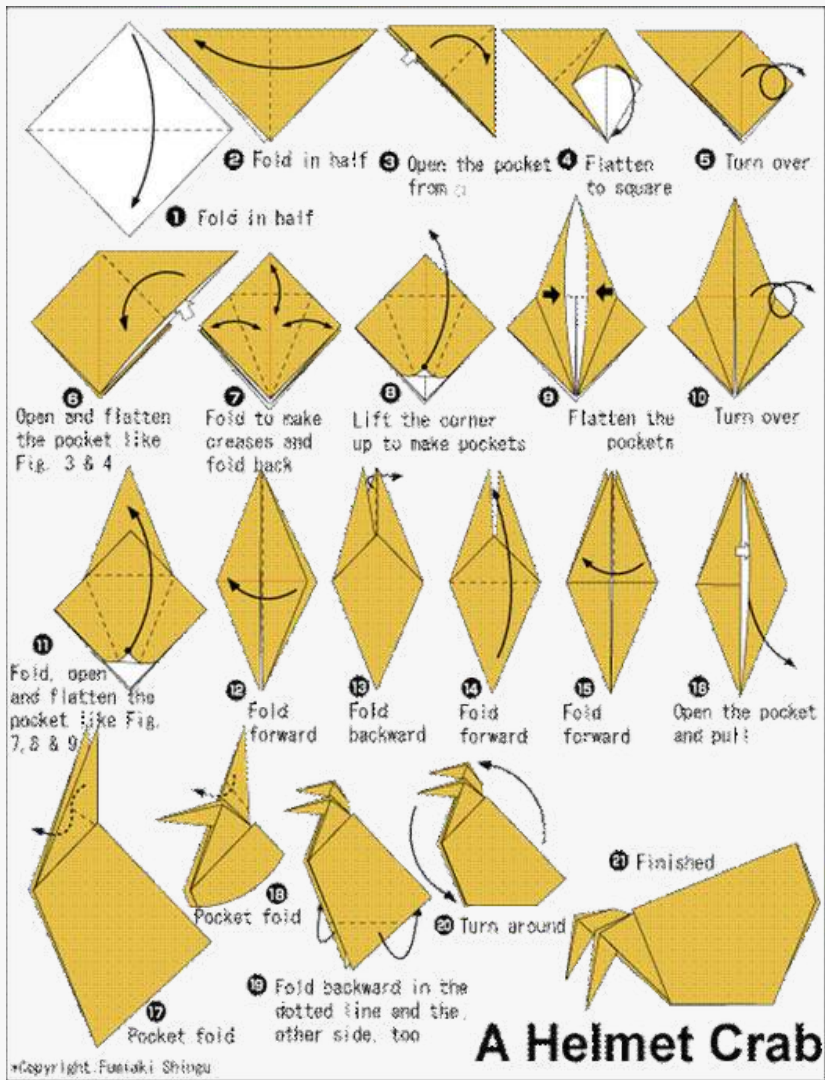

## 78. A LION

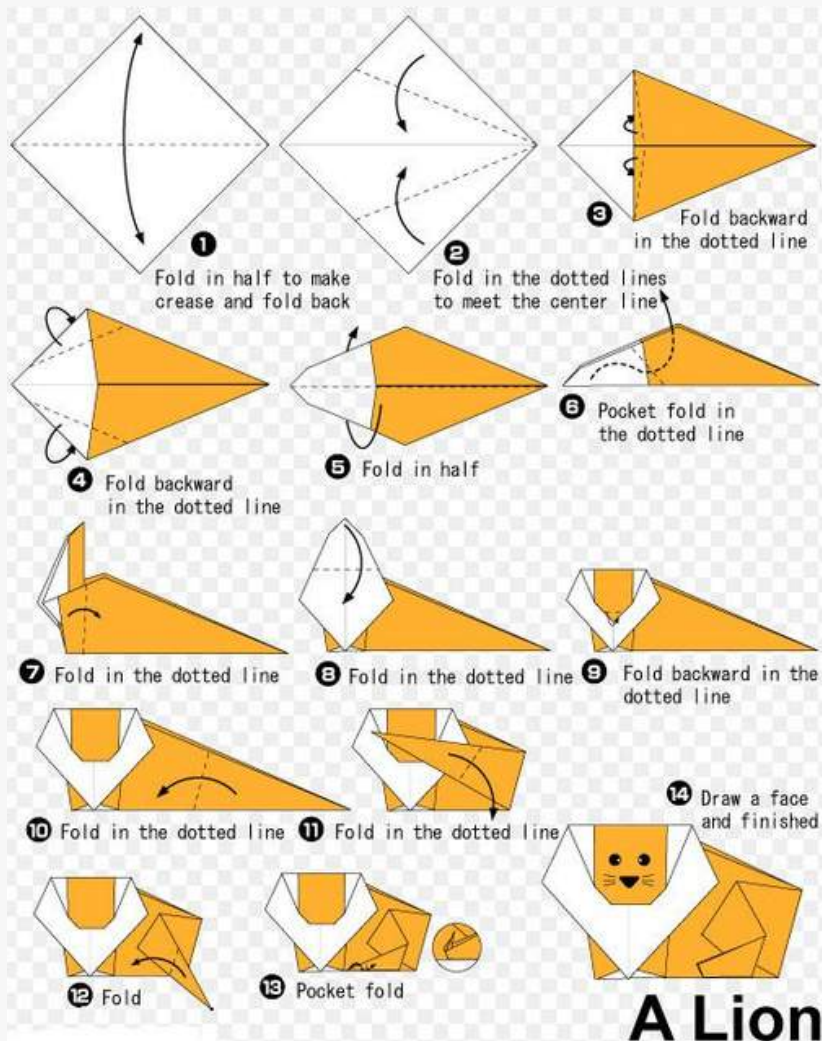

# 79. A MANTIS

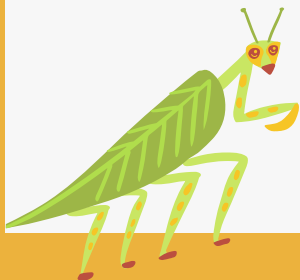
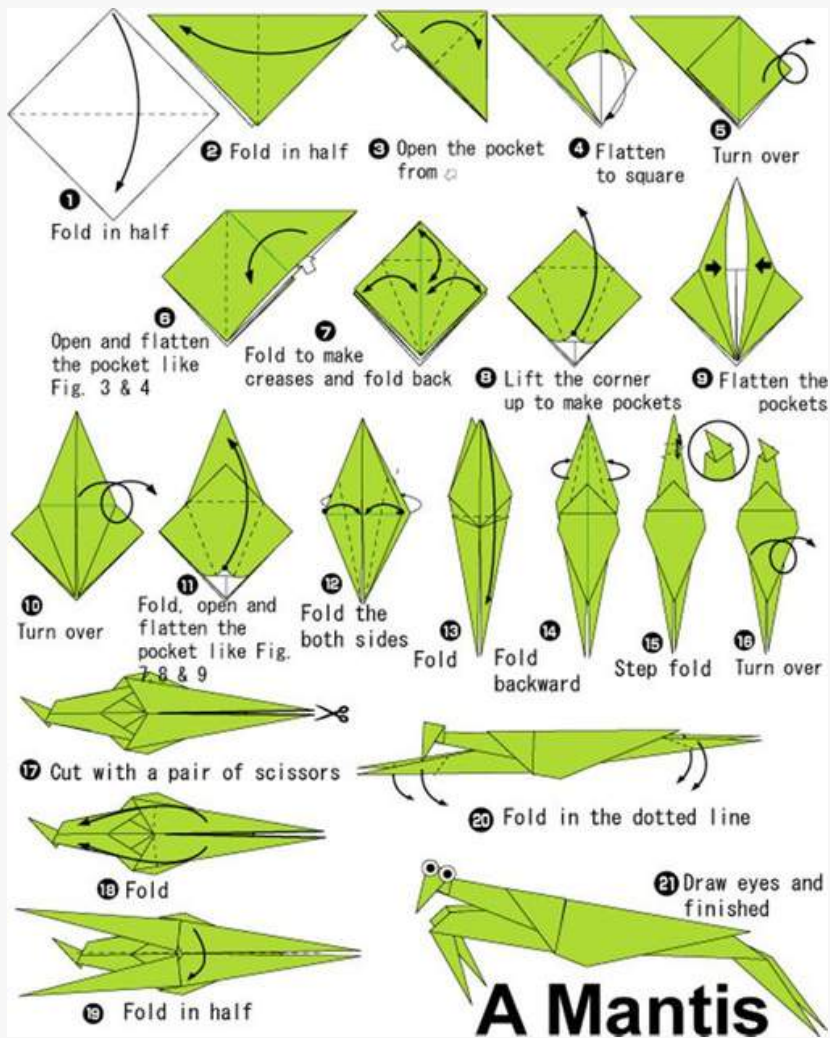



## 80. A MUSHROOM

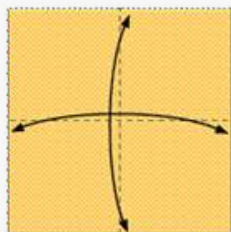

1 Fold in the dotted lines, make creases and fold back

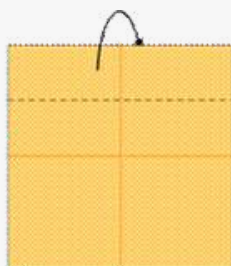

2 Fold backward in the dotted lines



3 Fold forward to meet the center lines

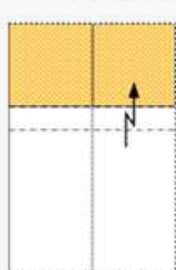

4 Pocket fold in the dotted lines

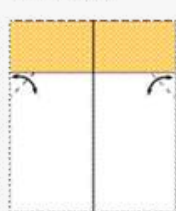
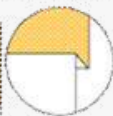

5 Fold to make creases and fold back

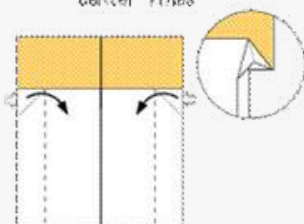

6 Open the pocket from the top and flatten

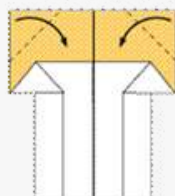

7 Fold in the dotted lines

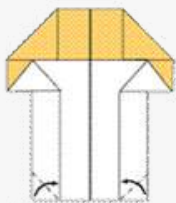

8 Fold in the dotted lines

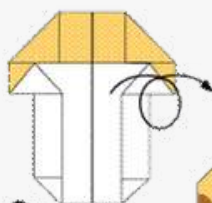

9 Turn over

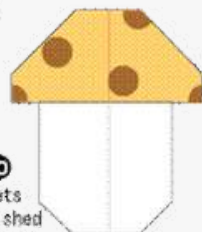

10 Draw spots and finished

# A Mushroom



# 81. A RUNT PONY

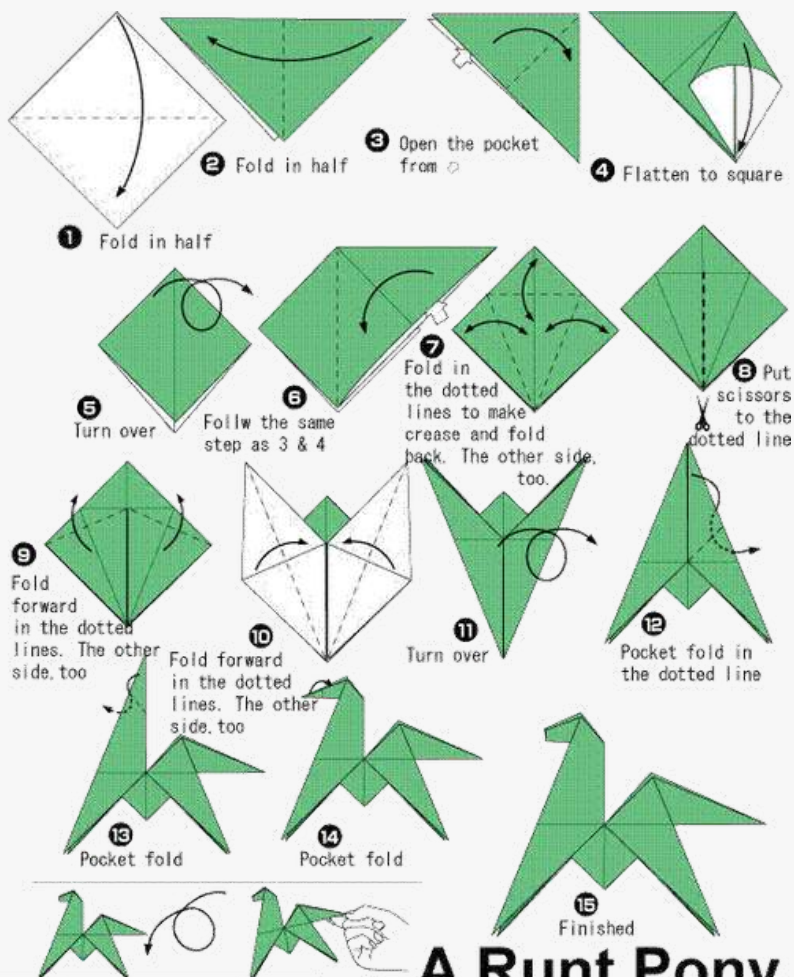

# 82. A SHARK

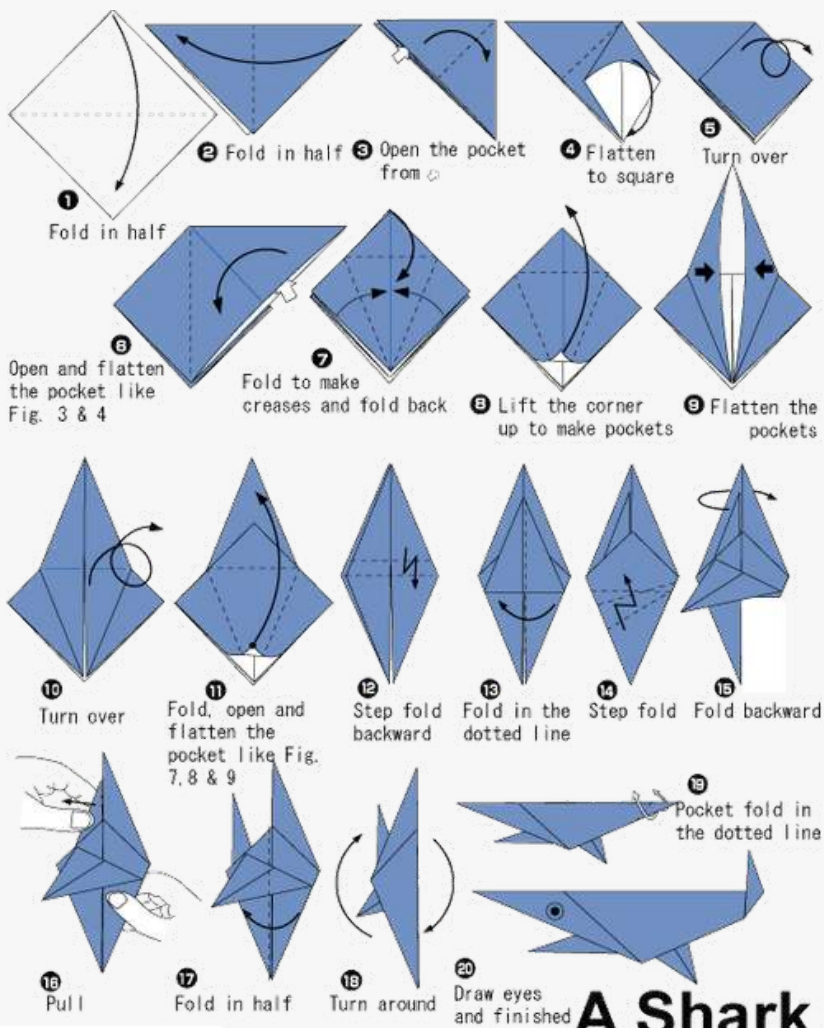

## A Shark

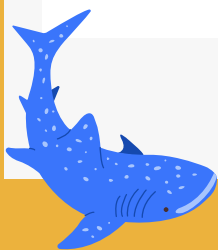

# 83. A SHIRT BAG

※A4 size paper or copy paper is used.

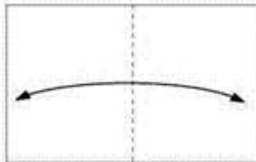

1 Fold in half to make a crease and fold back

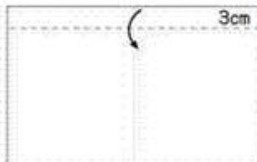

2 Fold in the dotted line

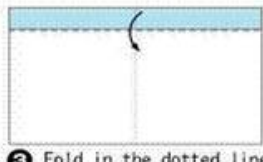

3 Fold in the dotted line

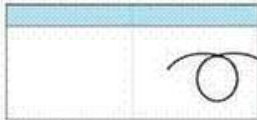

4 Turn over

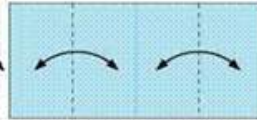

5 Fold to make creases and fold back

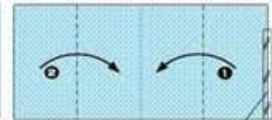

6 Put adhesive tape and hold to meet the center line

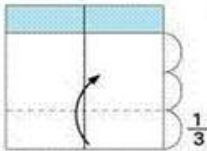

7 Fold

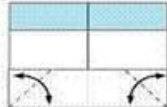

8 Fold to make creases and fold back



9 Open the part and flatten

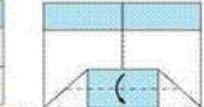

10 Fold

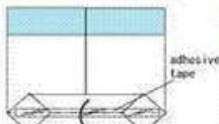

11 Put adhesive tape and hold in center

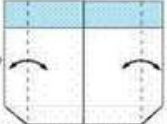

12 Fold in half to make a crease and fold back



13 Moves it

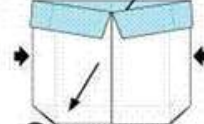

14 Assembles it



15 Fold and inserts it. right is the same, too

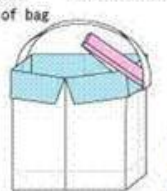

16 Stop it with a stapler. right is the same, too

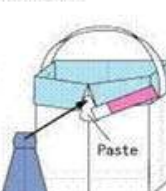

17 put a necktie.

10cm x 10cm paper

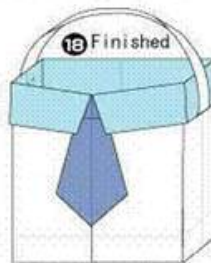

18 Finished

## A Shirt bag





# 84. A SUN FLOWER

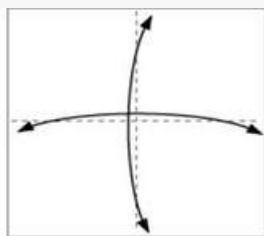

1 Fold in half twice to make creases and fold back

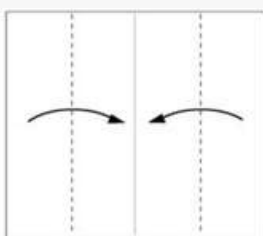

2 Fold to meet the center line

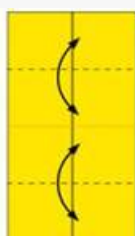

3 Fold to make a crease and fold back

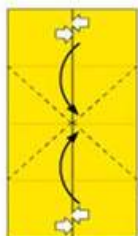

4 Open the  part and flatten

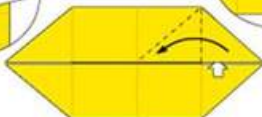

5 Open the  part and flatten



6 Open the others and flatten



7 Fold to make a crease and fold back



8 Open the  part and flatten



9 Folds as much as 7~8

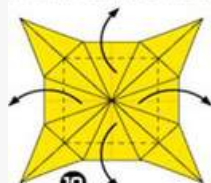

10 Fold in the dotted line

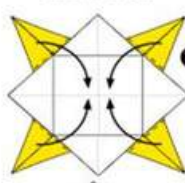

11 Fold in the dotted line

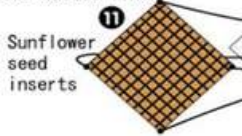

Sunflower seed inserts

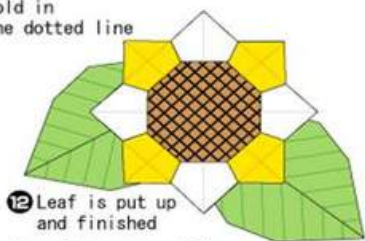

12 Leaf is put up and finished

## A Sunflower

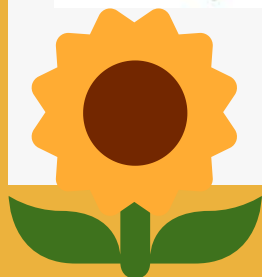

# 85. AN EVENING DRESS

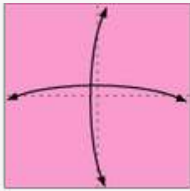

1 Fold in half twice to make a crease and unfold

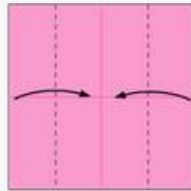

2 Fold forward in the dotted lines

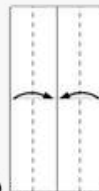

3 Fold forward in the dotted lines



4 Open

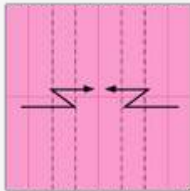

5 Step fold forward in the dotted lines



6 Turn over



7 Fold in the dotted lines



8 Fold in the dotted lines

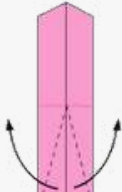

9 Fold in the dotted lines

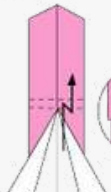

10 Step fold in the dotted lines

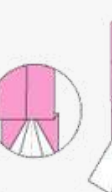

11 Fold in the dotted lines

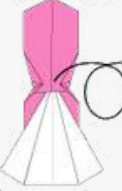

12 Turn over

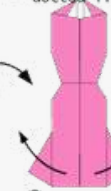

13 Pull

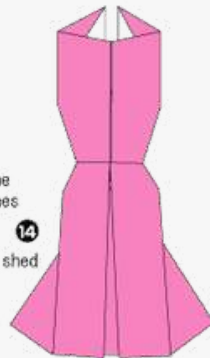

14 Finished

## An Evening Dress

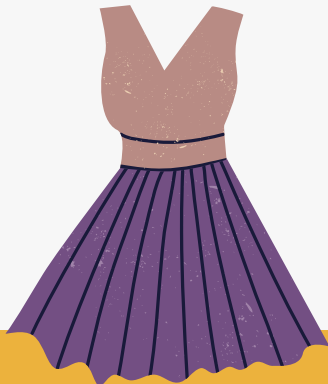

## 86. BALLON BUNNY

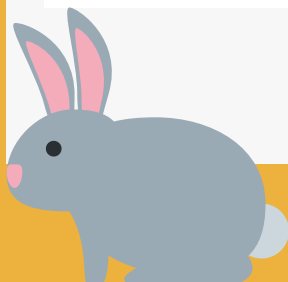
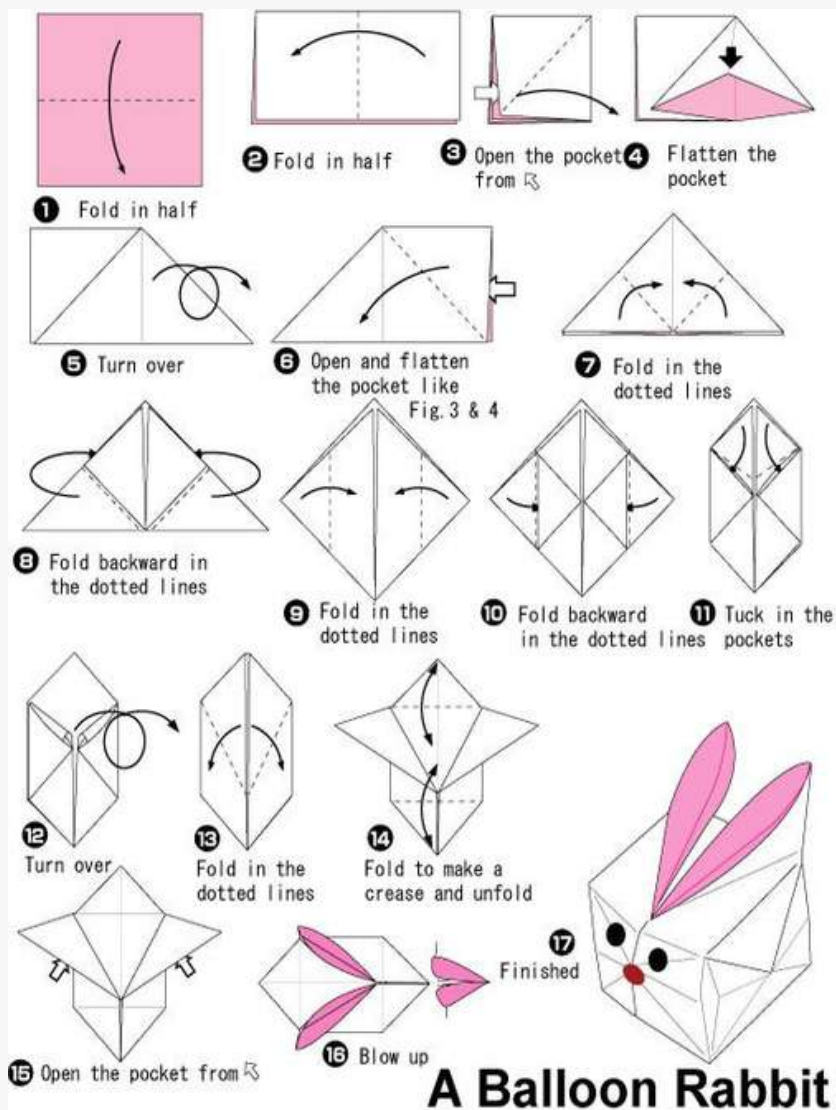

# 87. BASKET

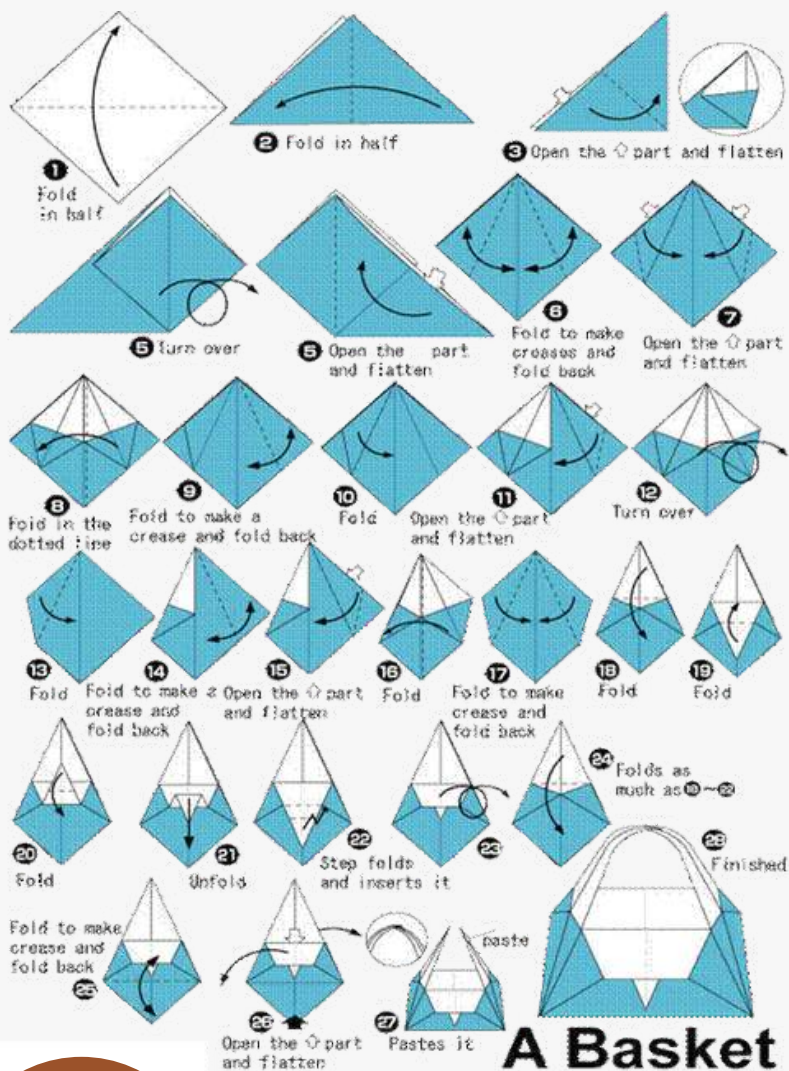

# 88. CHINESE JUMPING FROG

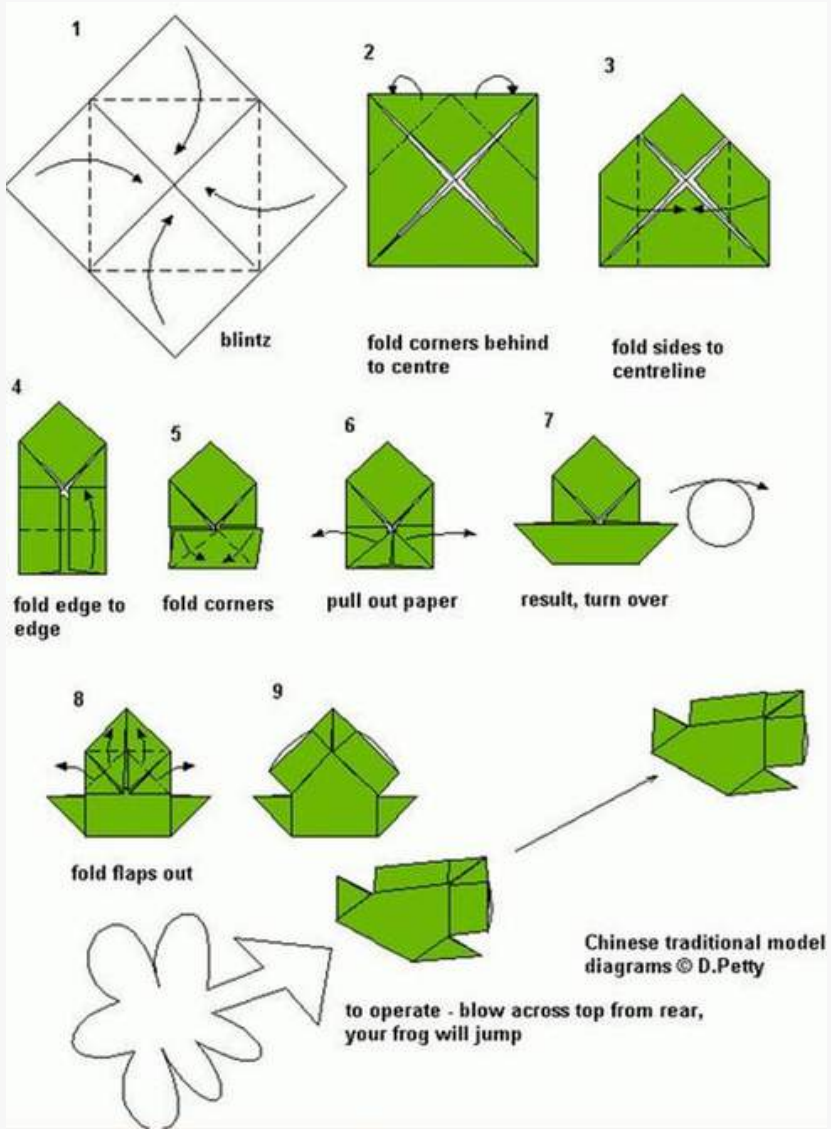

## Chinese Jumping Frog





# 89. CRAB

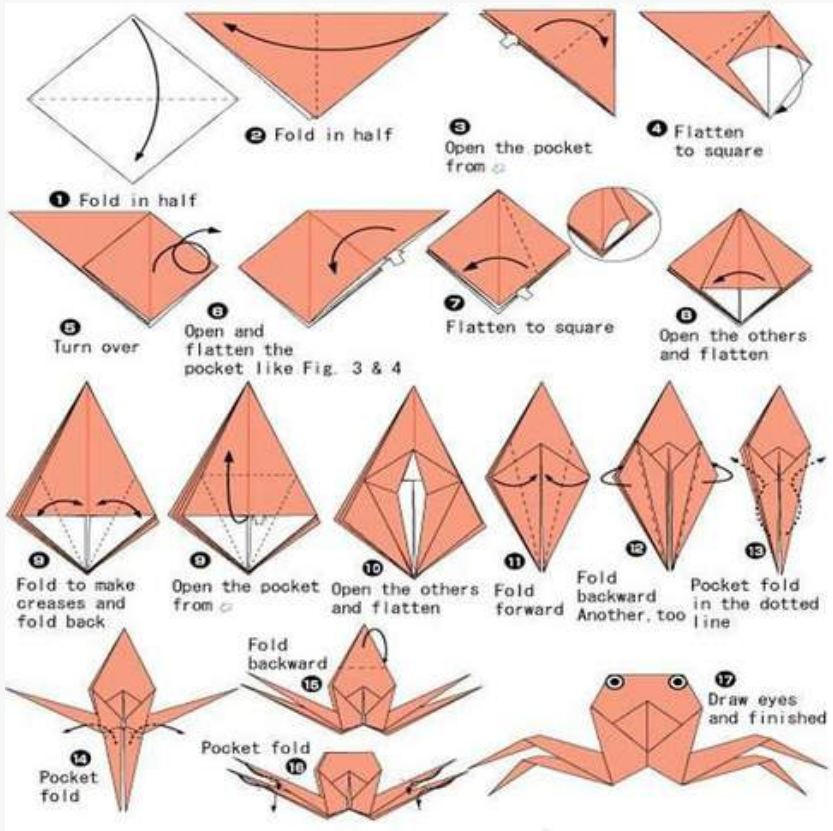

## Crab



# 90. CRAW FISH

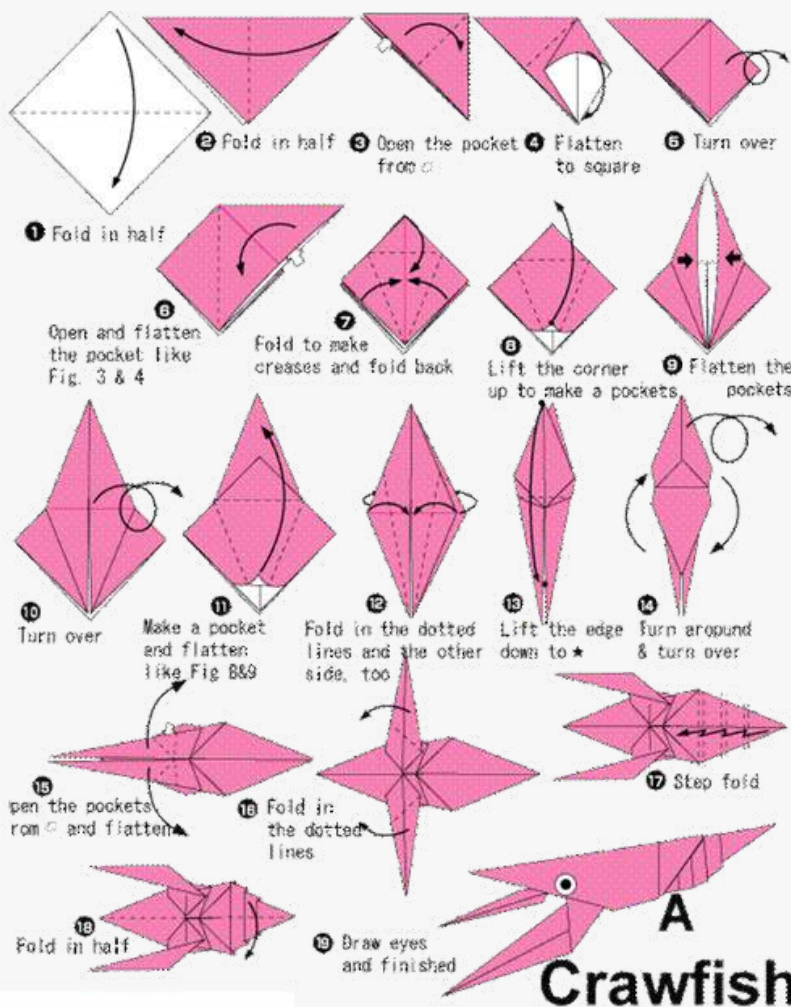



# 91. DIAMOND ROSE SQUARE JUMPER

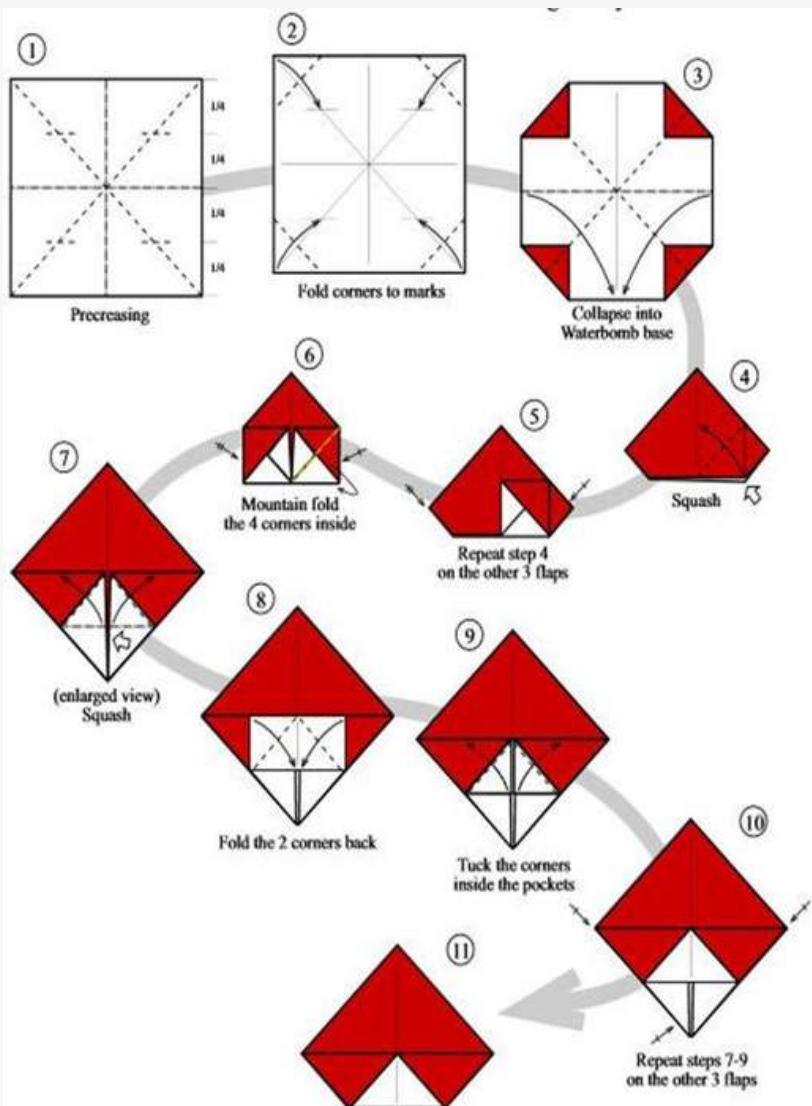

With this step we have reached Caroline Cermak's Diamond (hence the first part of the name). Continue on the next page to discover the rest of the name ^ ^

# CONTINUED....

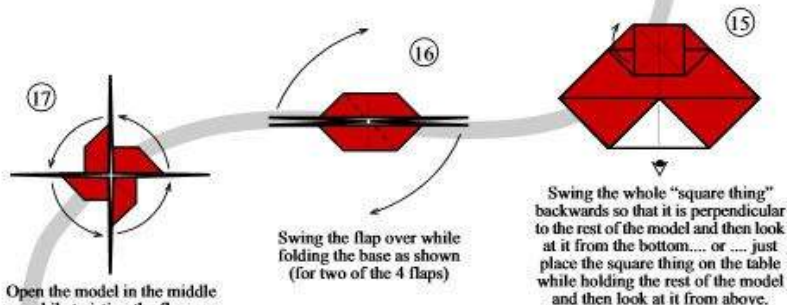
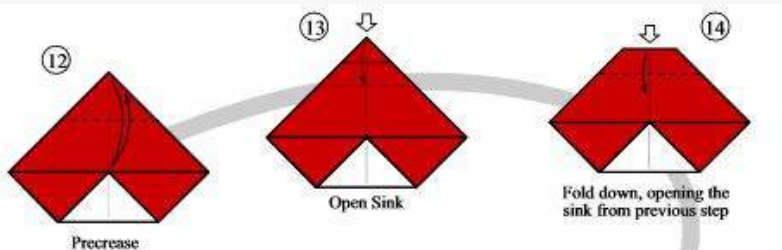

Open the model in the middle while twisting the flaps downwards and counter-clockwise for about 90°. Difficult to describe this step but it happens quite naturally ^ ^

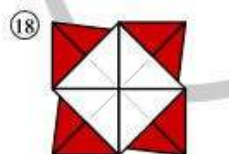

Result of step 17 Turn the model over.

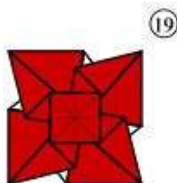

And with this step we have almost reached my Diamondrose. Shape it to your liking, for example like in the picture with the tips of the petals folded backwards and the center rebuilt to its "sink state" after step 13 and twisted a bit more. Or... you can continue on the next page for the rest of the name and some more fun ^ ^



**Note 1:**

The next steps won't work that well after too much shaping.

**Note 2:**

By doing steps 16 and 17 in the other direction you can get the rose twisted the other way round.



## Diamondrose Squarejumper

# 92. FLAPPING BIRD

**1** Fold in half

**2** Fold in half

**3** Open the pocket from □

**4** Flatten to square

**5** Turn over

**6** Follow the same step as 3 & 4

**7** Fold to make crease and fold back

**8** Lift the edge to make a pocket

**9** Flatten the pockets

**10** Turn over

**11** Follow the same step as 7, 8 & 9

**12** Pocket fold in the dotted line and do the same thing on the other side

**13** Pocket fold in the dotted line

**14** Pocket fold in the dotted line

**15** Fold in the dotted line

**16** Finished

**A Flapping Bird**



# 93. FRILLED LIZARD

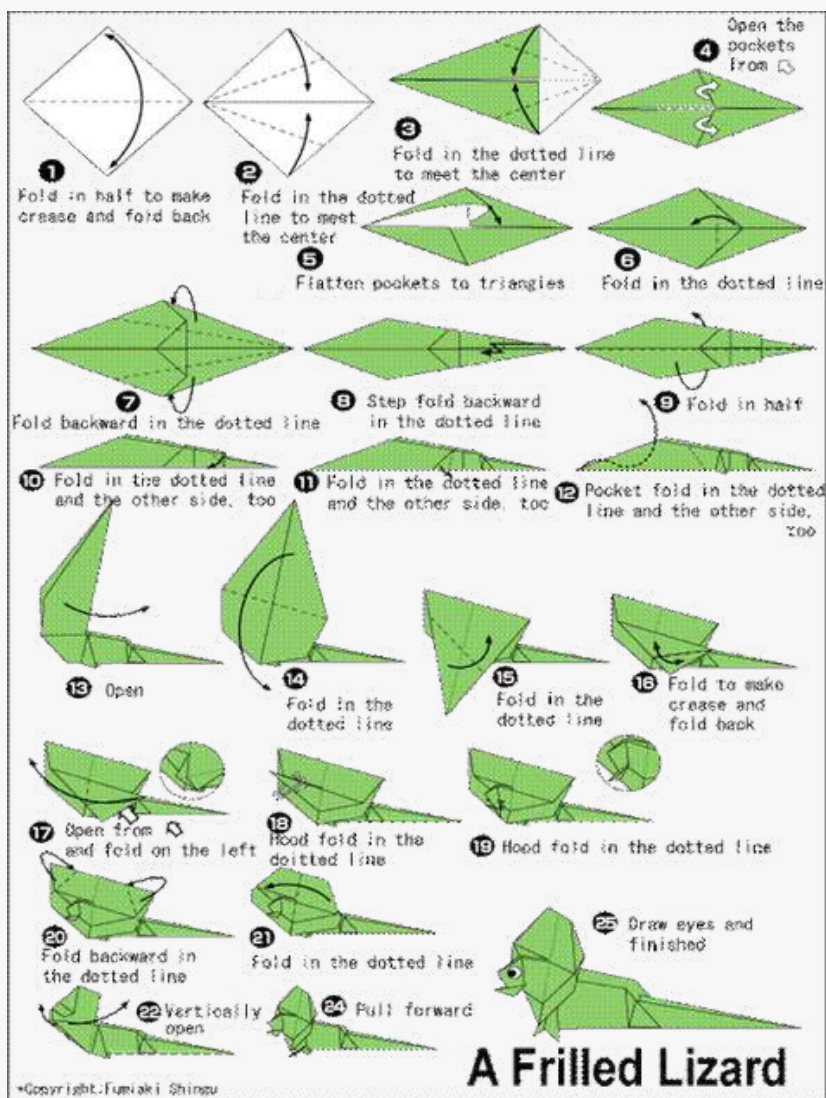

# 94. JACK O LANTERN

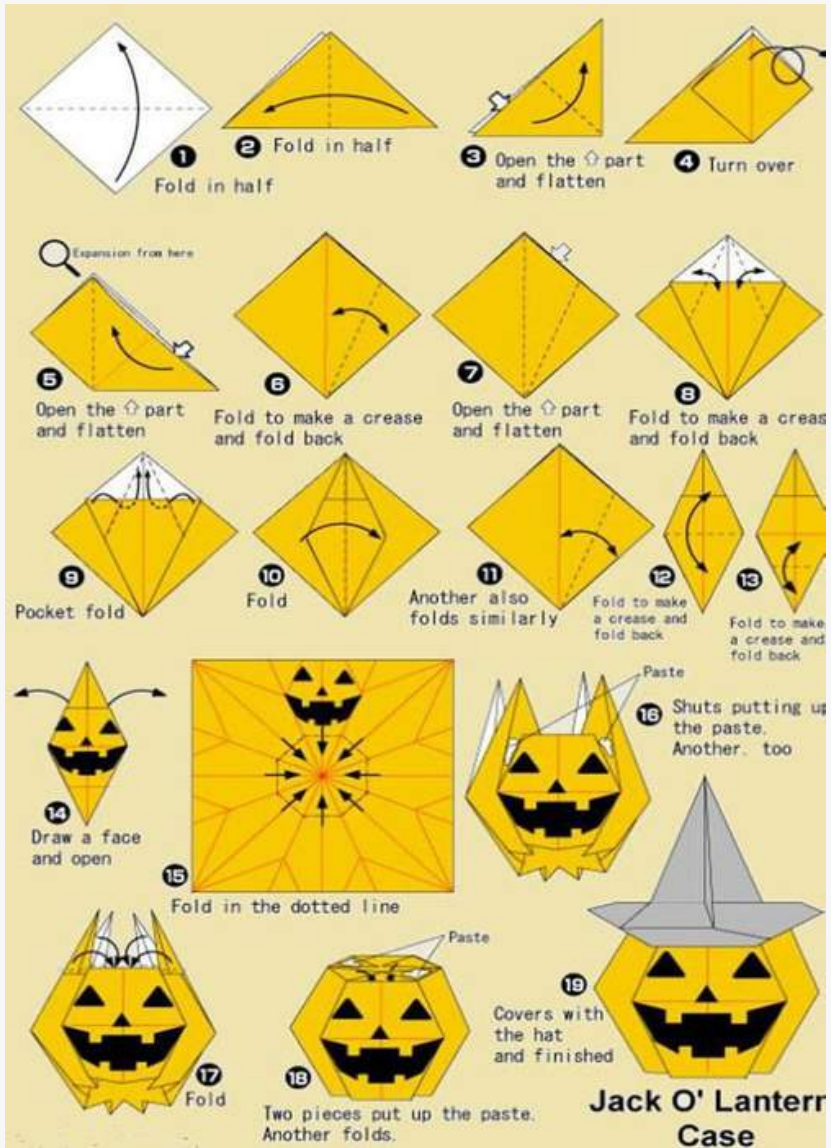



# 95. MAPLE

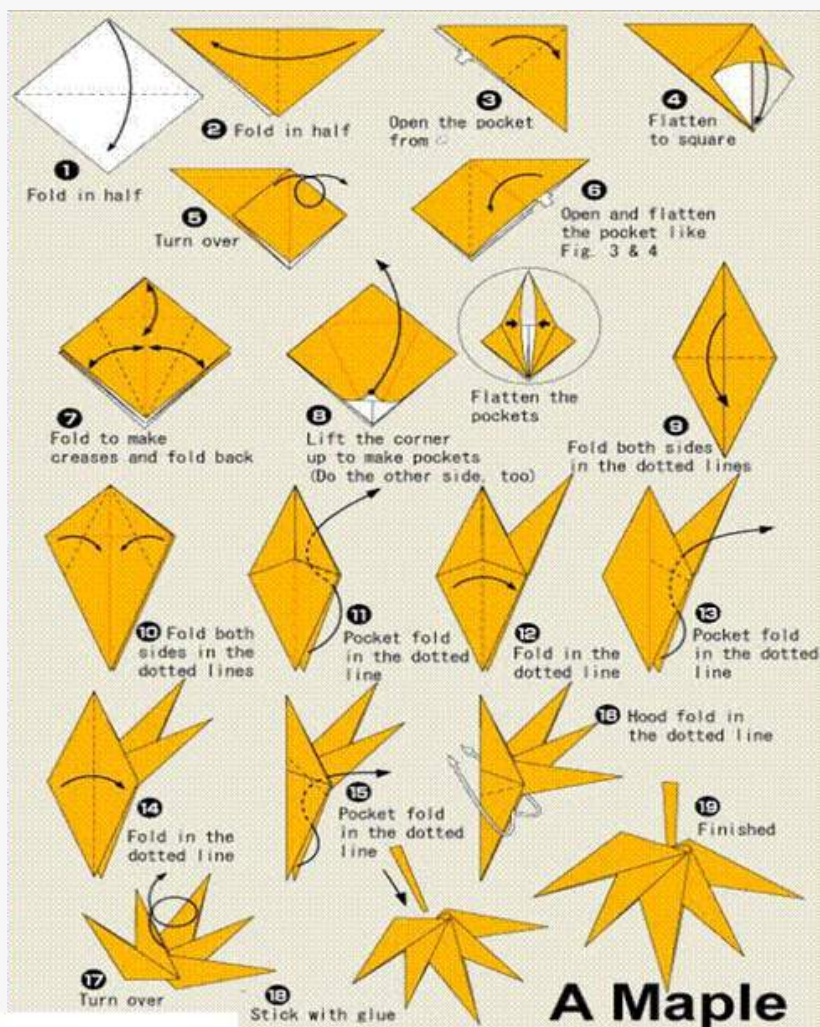

# 96. NABOO STARFIGHTER

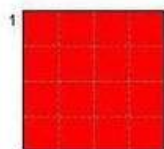

1  
Fold and unfold

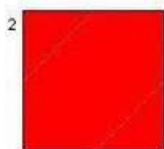

2  
Mountain fold behind

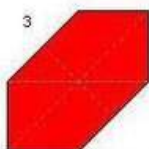

3  
Fold waterbomb base



4  
Squash Fold

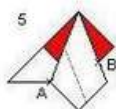

5  
Fold A to B

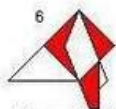

6  
Like so. Unfold

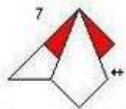

7  
Repeat 5-6 on right

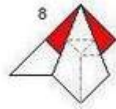

8  
Squash fold flap to right



9  
Squash fold

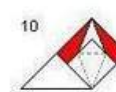

10  
Petal fold

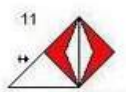

11  
Repeat 4-10 behind



12  
Fold 2 layers to left



13  
Squash Fold



14  
Reverse Folds



15  
Fold 3 layers to right

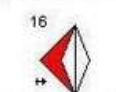

16  
Repeat 13-15 on left

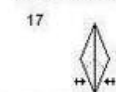

17  
Reverse folds between  
2nd and 3rd layers.  
Repeat behind



18  
Wrap one layer to the  
outside from the middle  
of each wing



19  
(i) Reverse folds  
(ii) Open layers while  
folding flap down.  
Repeat behind



20  
Pleat flap. Repeat behind



21  
(i) Mountain fold inside.  
Repeat behind  
(ii) Squash fold corners.  
Repeat behind

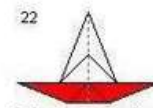

22  
Fold one wing to the  
left in front and one  
to the right behind



23  
Swivel fold just past  
the centre line



24  
Valley fold left

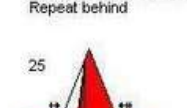

25  
Repeat 22-23 on right  
and behind



26  
Fold wing back to the right,  
tucking flap A into pocket B.  
Repeat in reverse behind



27  
Sink small flap  
in and out in thirds



28  
Pleat the edges in  
towards the centre



29  
Mountain fold edges  
into centre.



## Starship



# 97. SCORPION

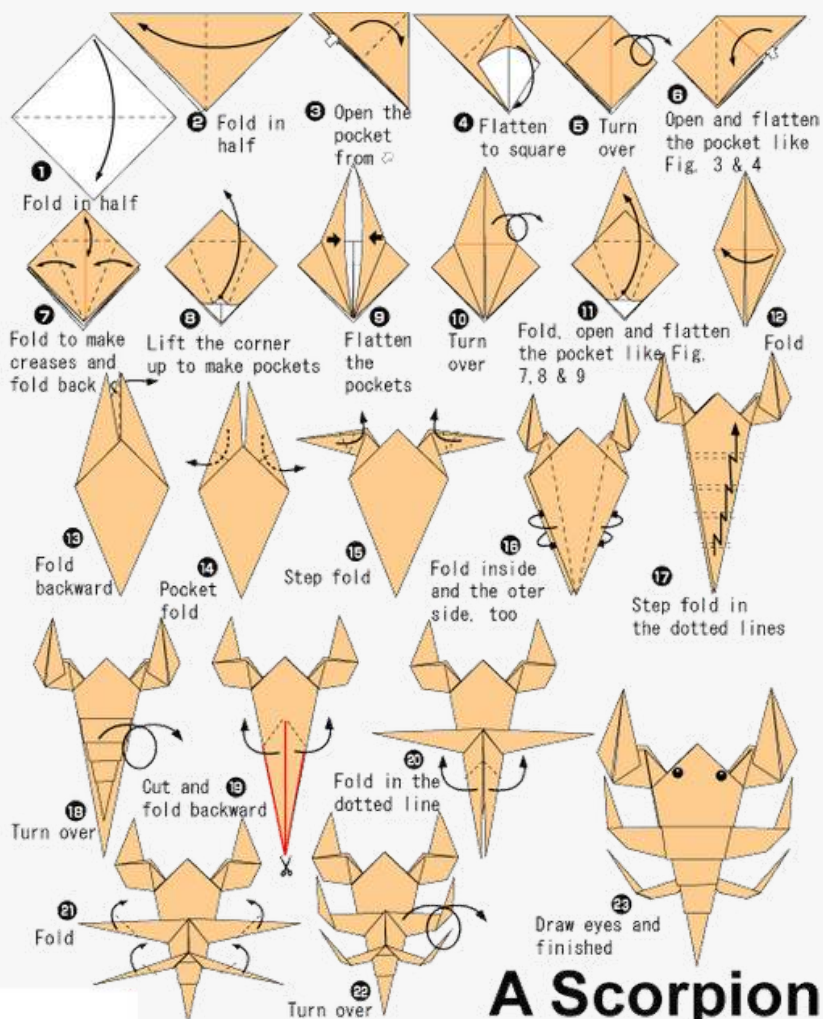

## A Scorpion



# 98. SUMO WRESTLER

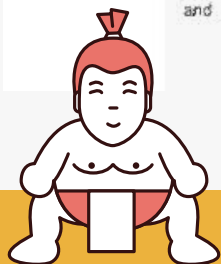
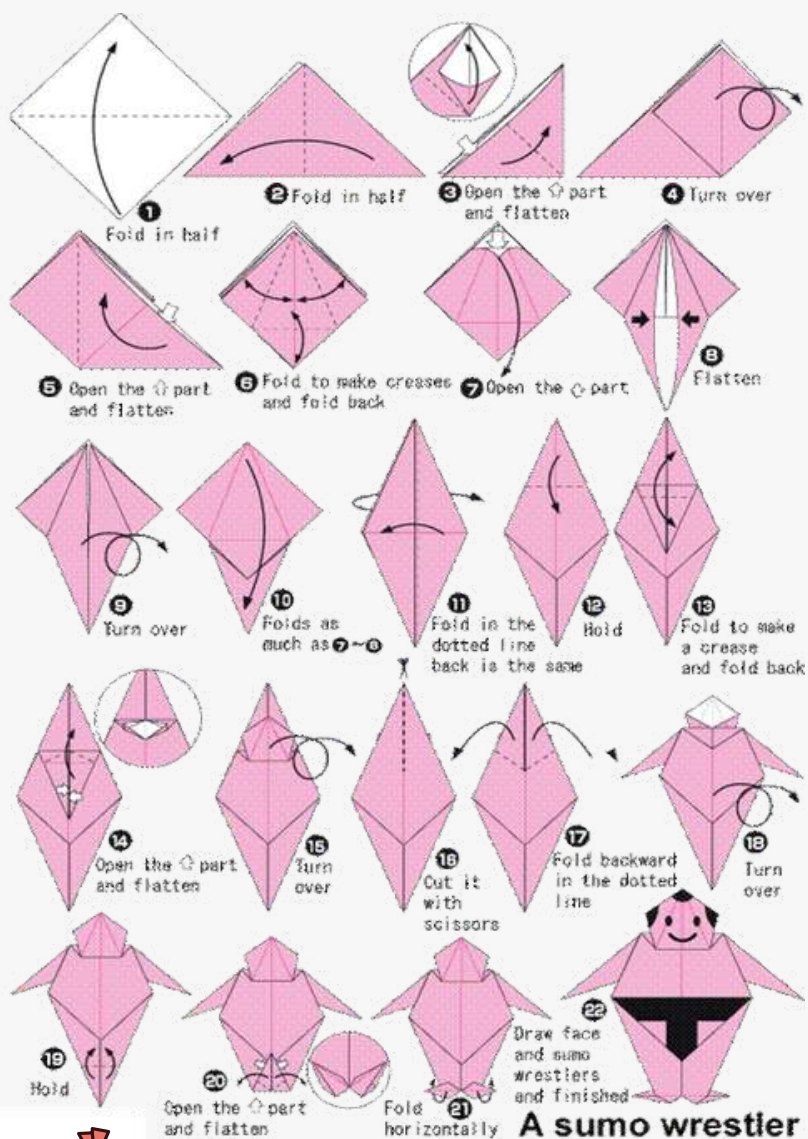

# 99. WRIST WATCH

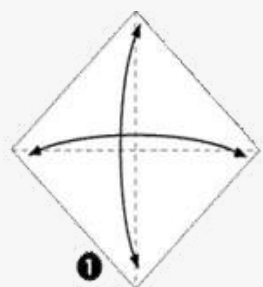

1  
Fold in the dotted lines to make creases and fold back

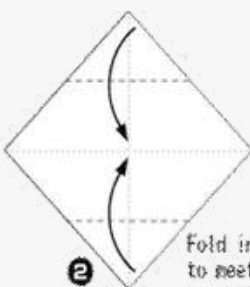

2  
Fold in the dotted lines to meet the center lines

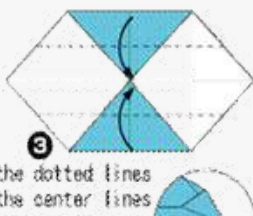

3  
Fold in the dotted lines to meet the center lines

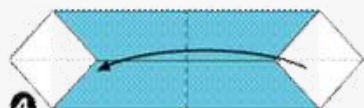

4  
Fold in half



5  
Fold to make creases and fold back

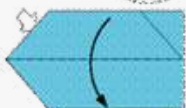

6  
Open the pocket from  and flatten

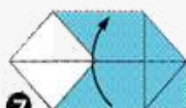

7  
Fold in the dotted lines

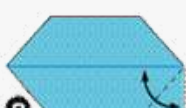

8  
Fold to make a crease and unfold

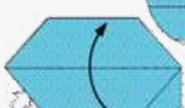

9  
Open the pocket from  and flatten



10  
Fold in the dotted lines

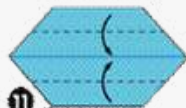

11  
Fold in the dotted lines

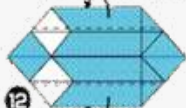

12  
Fold backward in the dotted lines

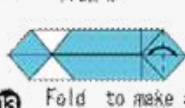

13  
Fold to make a crease and unfold

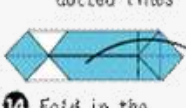

14  
Fold in the dotted lines

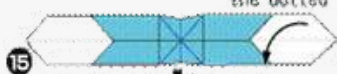

15  
16  
Flatten



17  
Make a ring



18  
Stick with a sticky tape

19  
Draw numbers, hands and finished



## A Wrist Watch



# 100. YODA

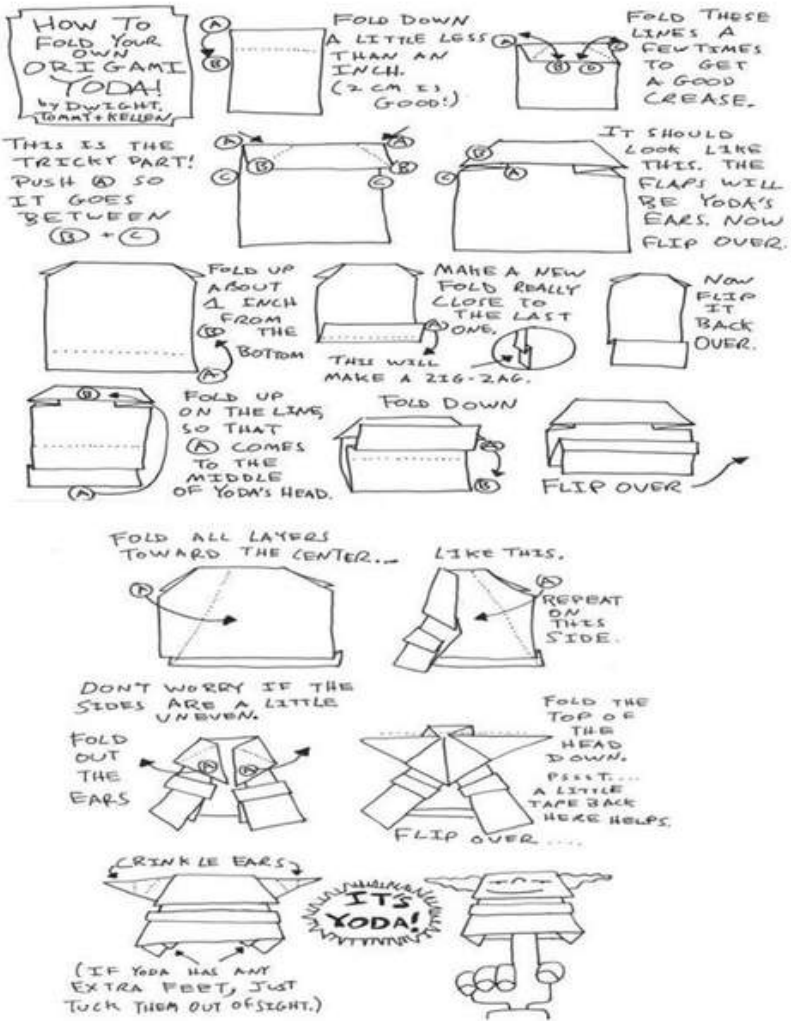

Thank you!

Yoda

**ORIGAMI CRAZE**

# **BONUS DESIGNES**

**FOR MOTIVATORS**

**GET MORE DESIGNS AND IDEAS AT  
[WWW.ORIGAMICRAZE.COM](http://WWW.ORIGAMICRAZE.COM)**



# 1. SQUIRREL

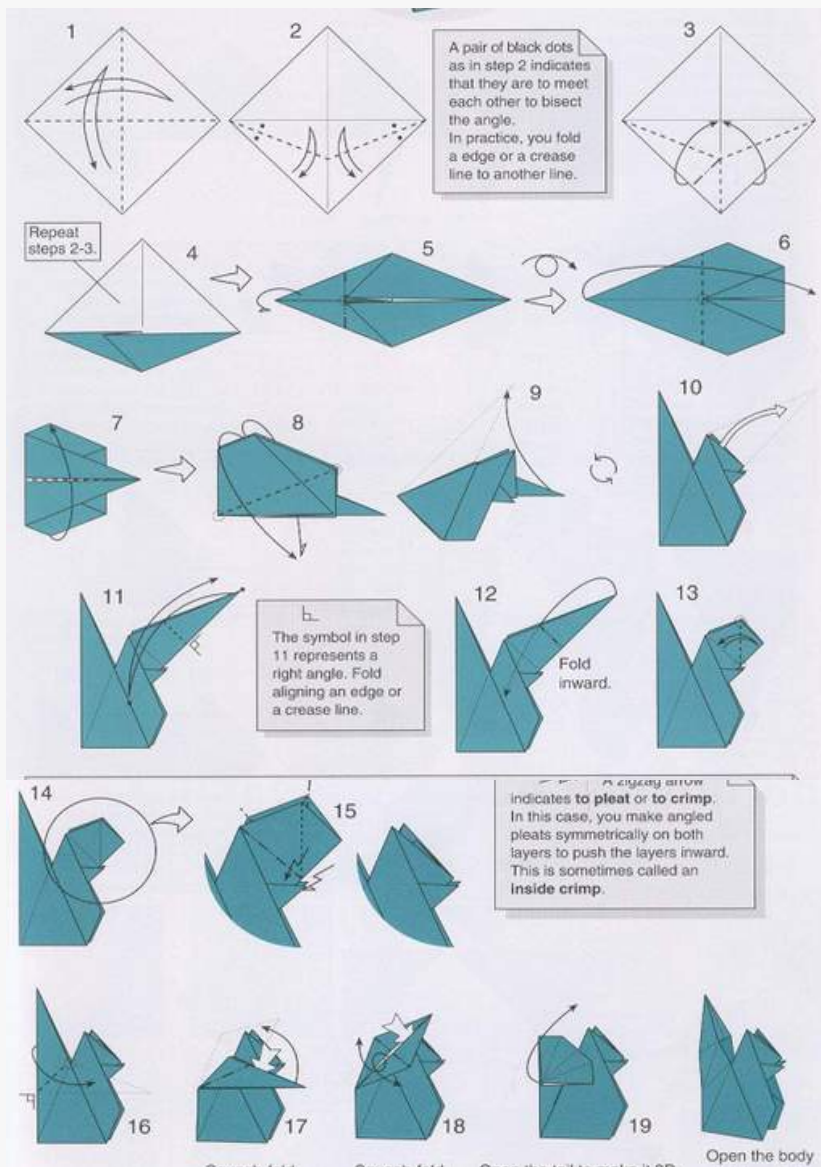

## 2. PARTITIONED BOX

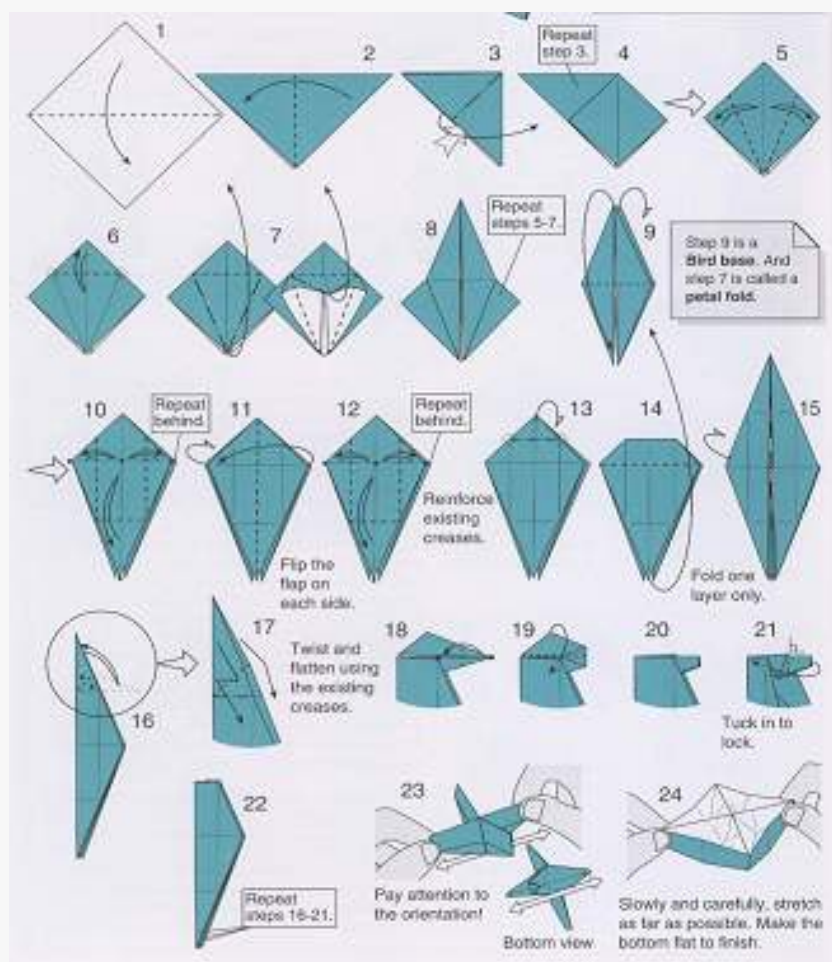



### 3. GIRAFFE

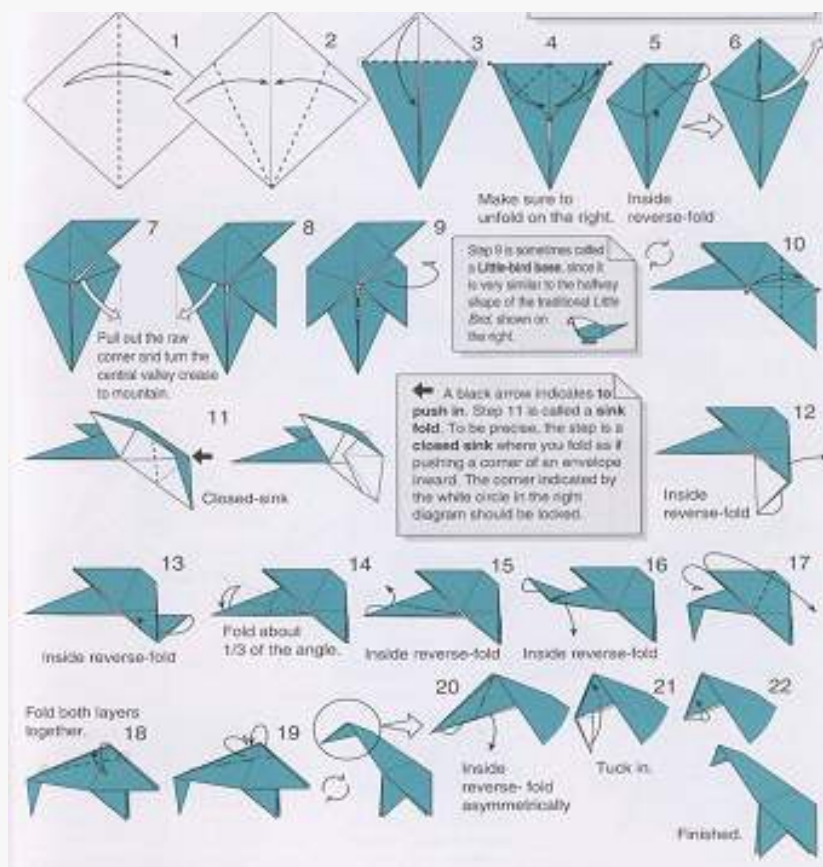

## 4. AIRPLANE

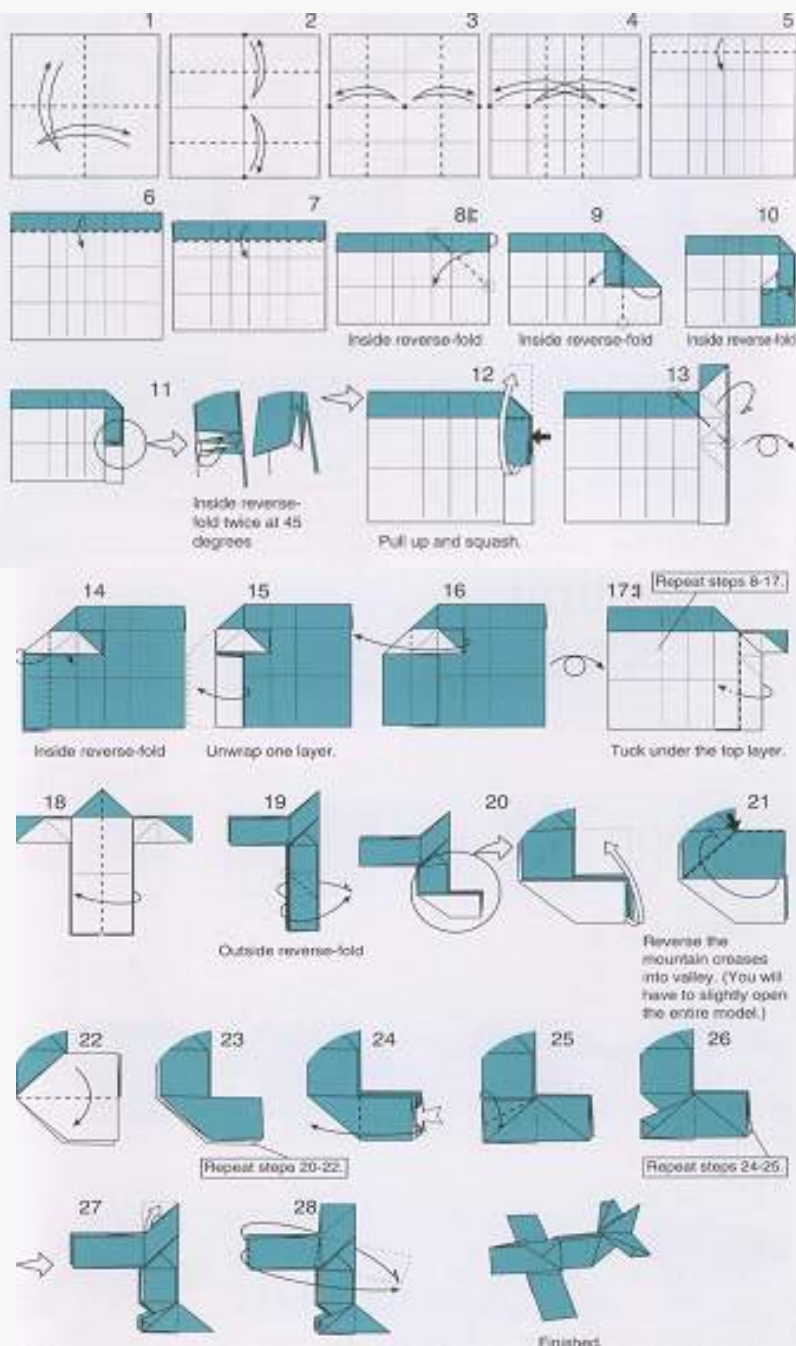

## 5. SANTA CLAUS

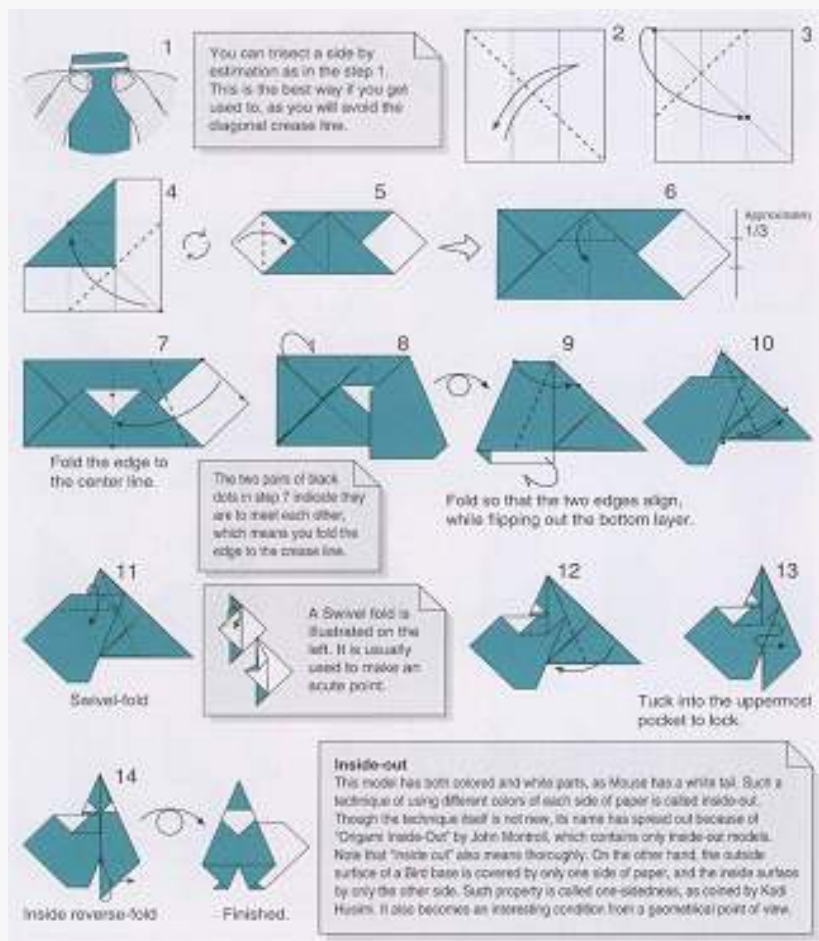

## 6. ORIZURU

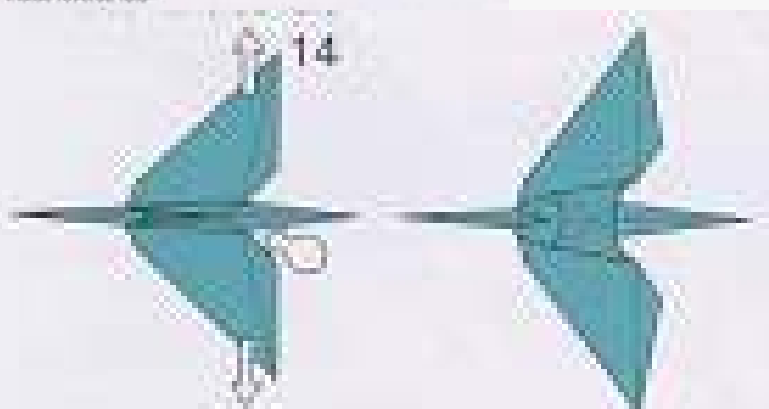
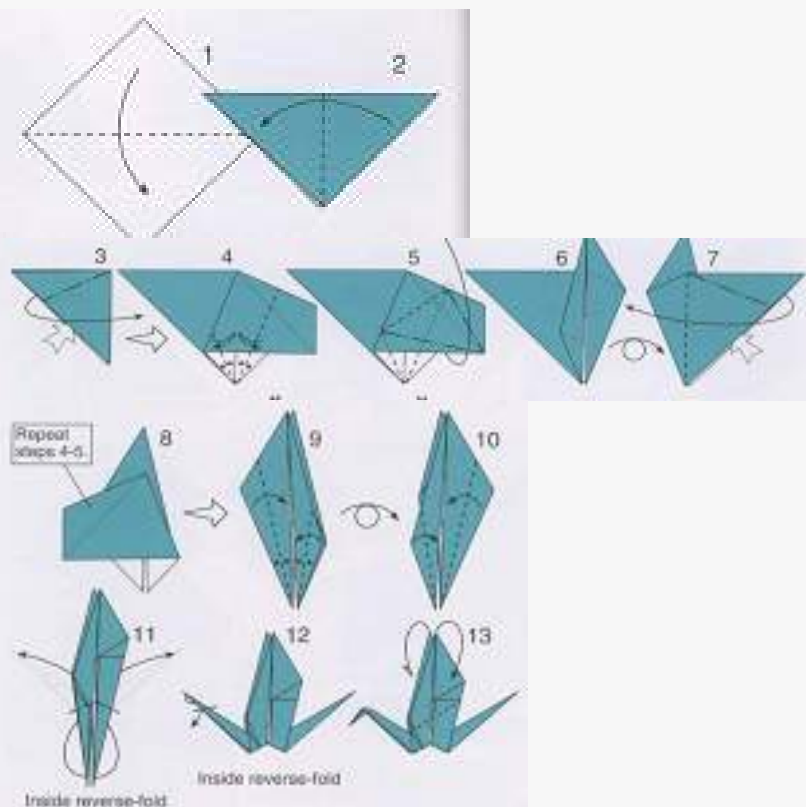

## 6. PEACOCK

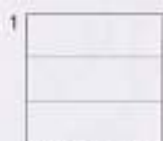

1  
Divide the side into three.



2  
Divide the side into six.

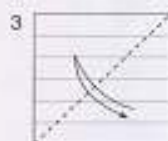

4  
Divide the other side into six.



5  
Divide both sides into twelve.



6  
Fold and unfold the diagonals of small squares.

Don't crease in this area.

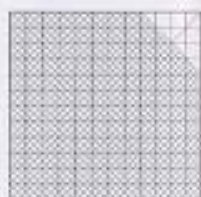

7  
Fold and unfold main diagonals in half.

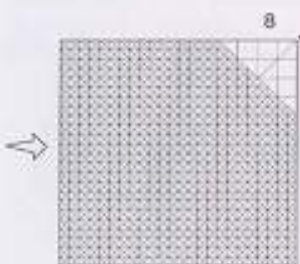

8  
Fold and unfold horizontally and vertically in half.



9  
Repeat steps 2-24 of Peacock 1.

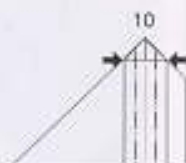

10  
Closed-sink



11  
12  
Inside reverse-fold



13  
Inside reverse-fold



14  
Inside reverse-fold

# CONTINUED...

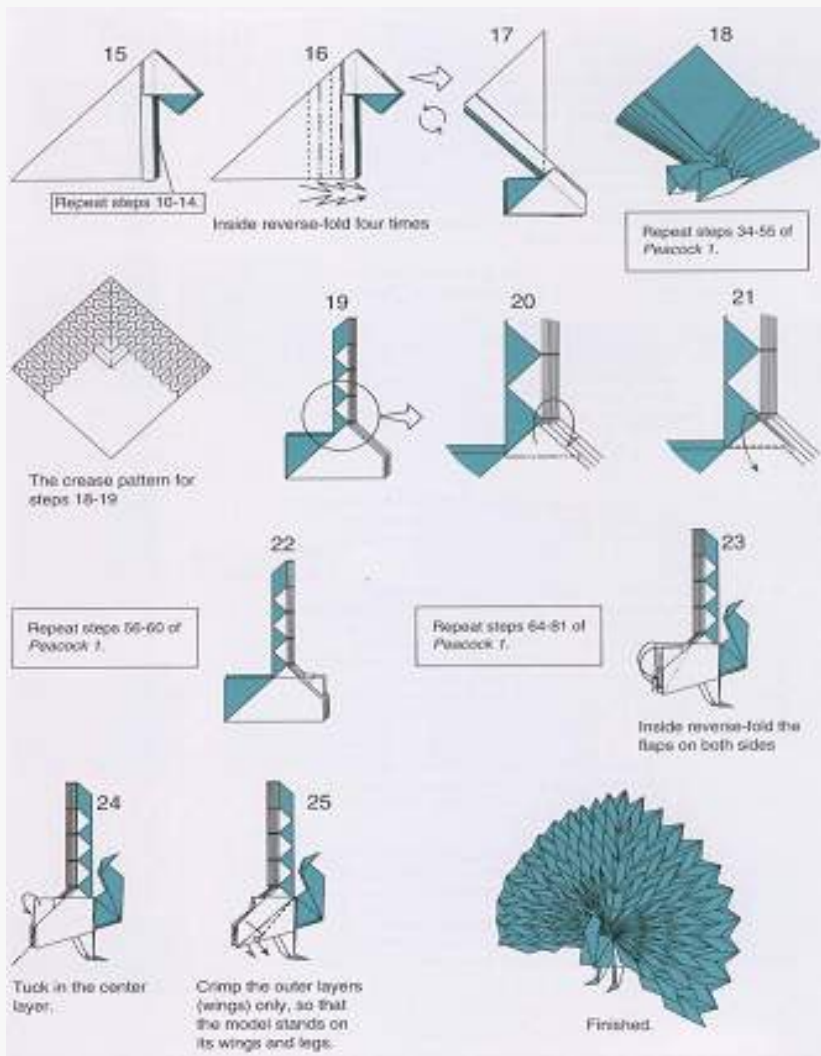



## 7. PYRAMID

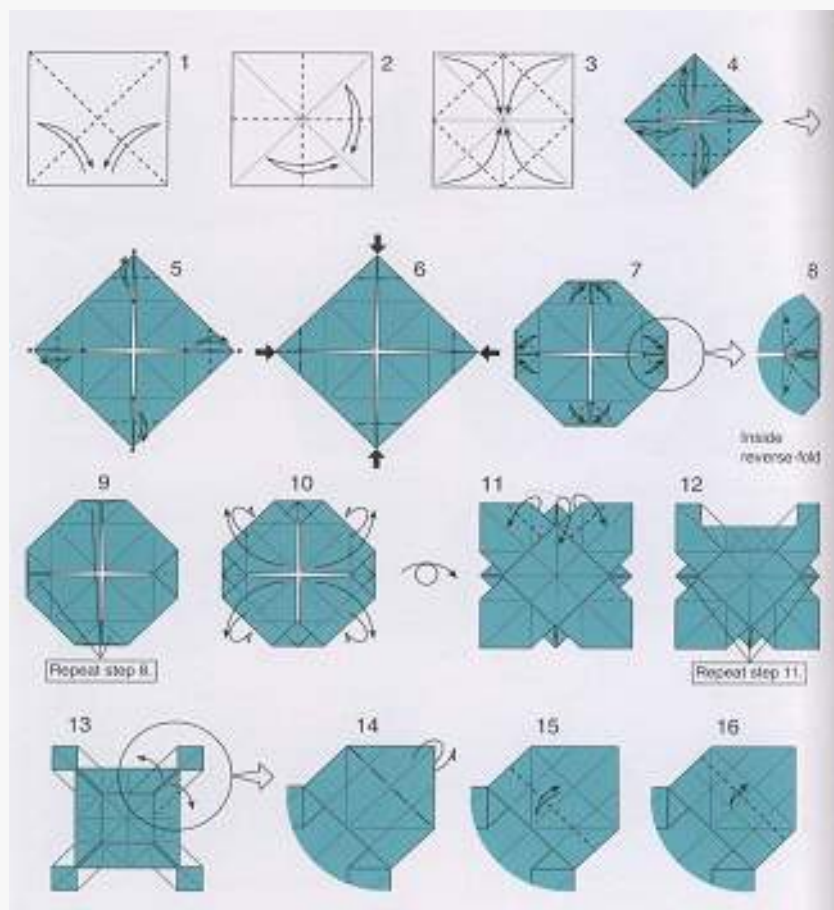

# CONTINUED...

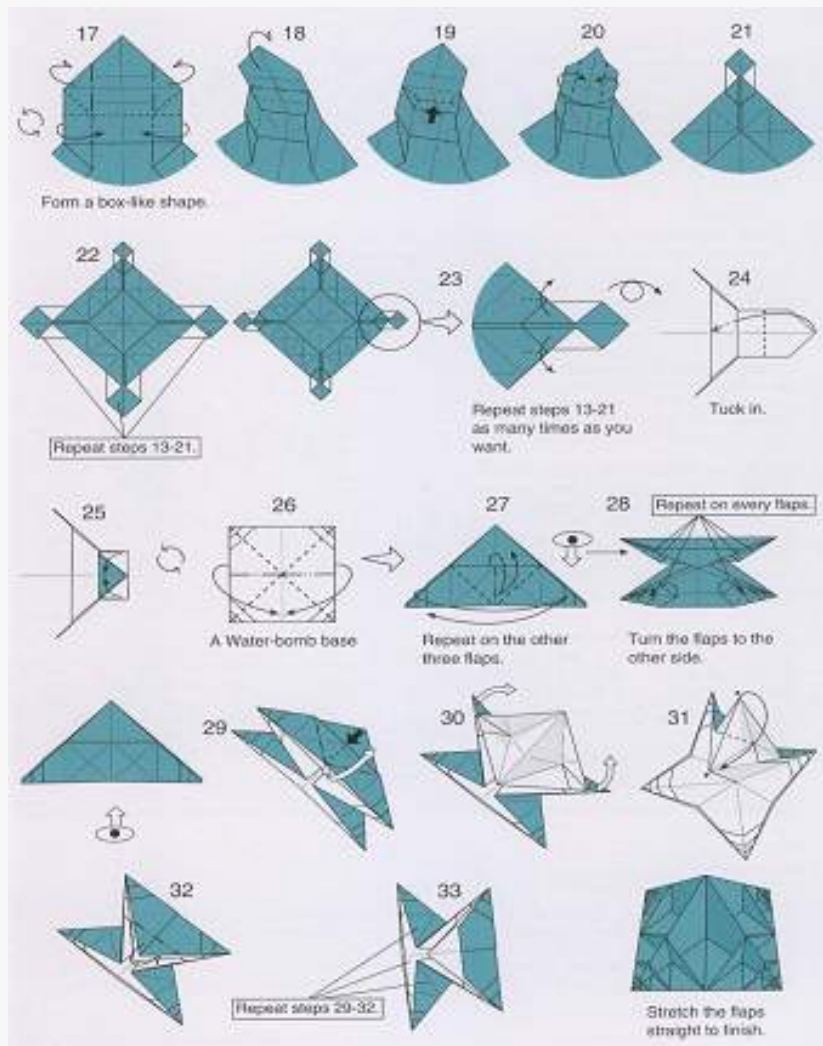

## 8. THREE HEADED CRANE

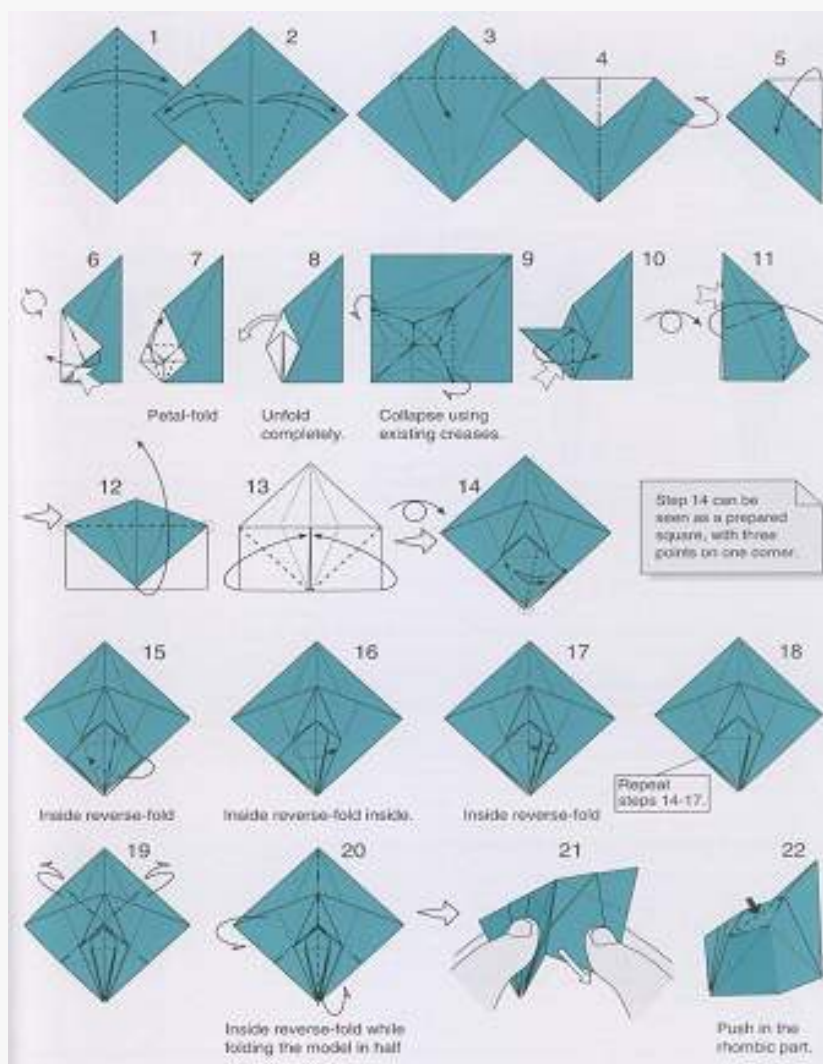

# CONTINUED...

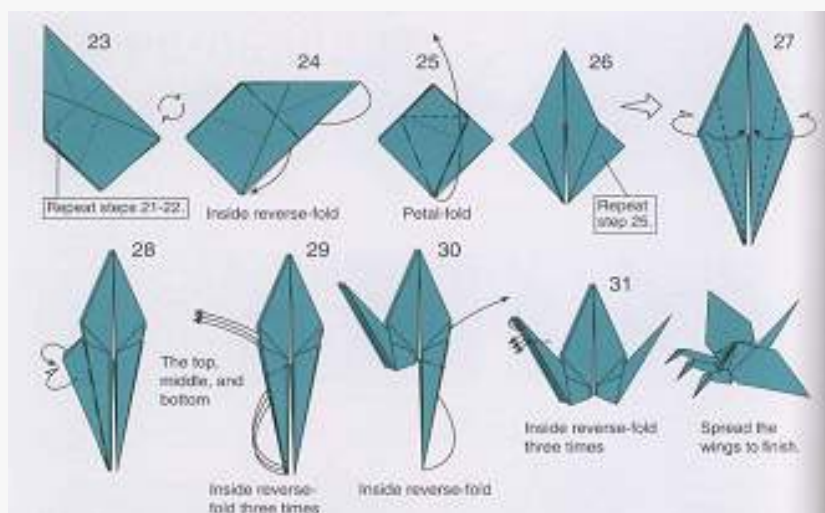

# 9. SQUID



Fold a diagonal, from the corner to the center.  
the corner to the center.

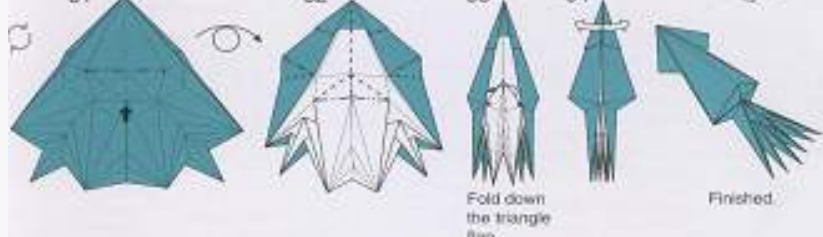
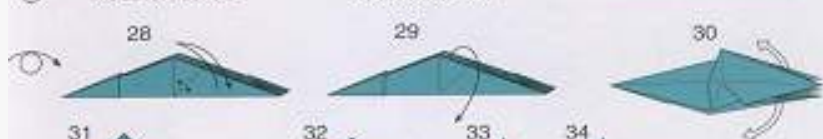
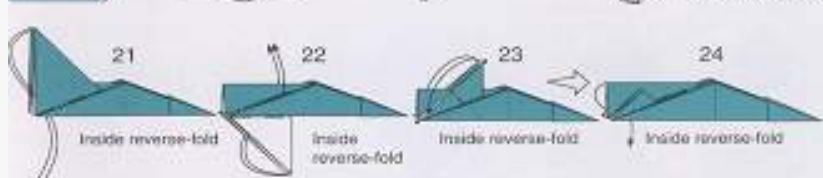
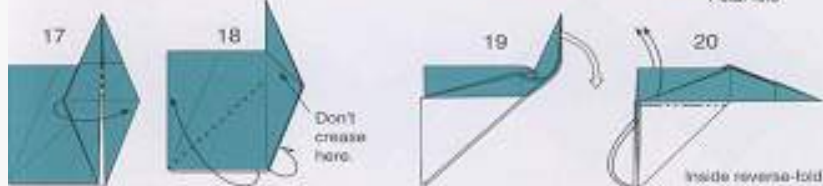
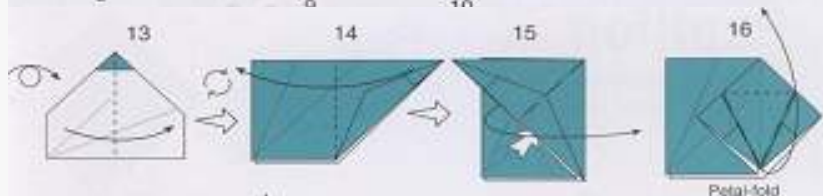
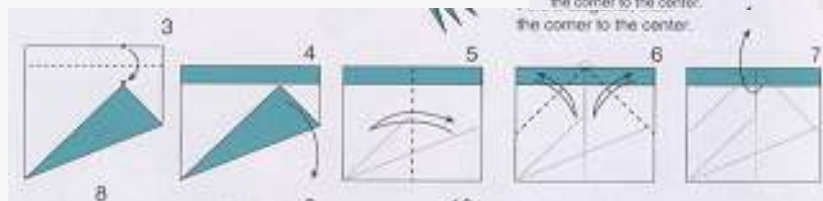

# 10. PAPILLON

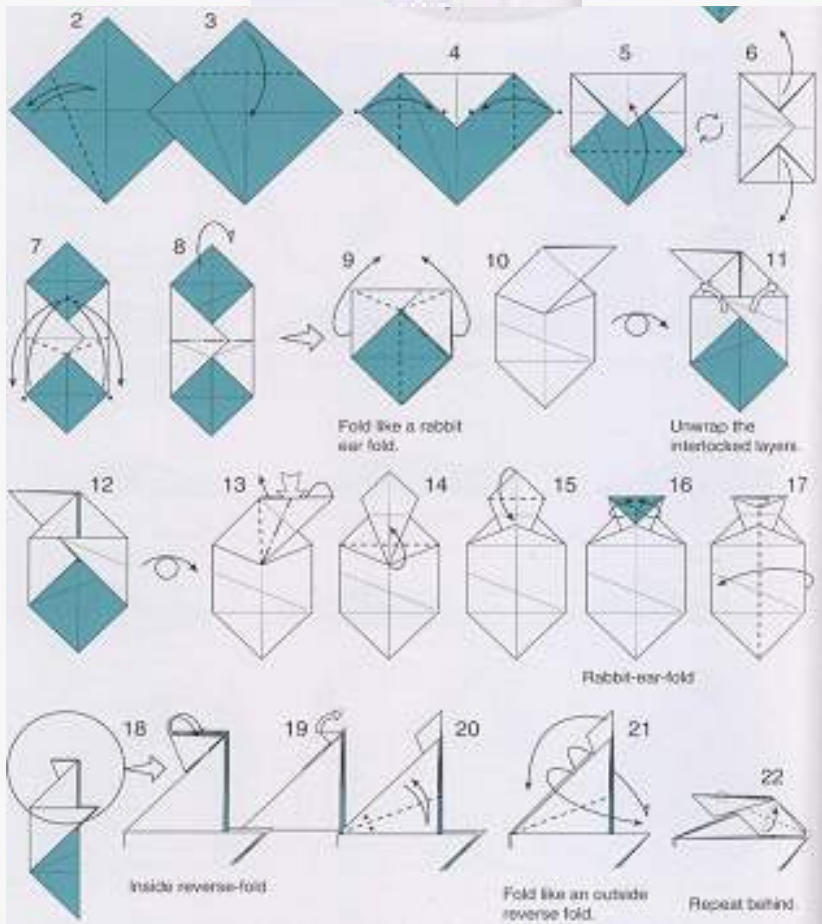
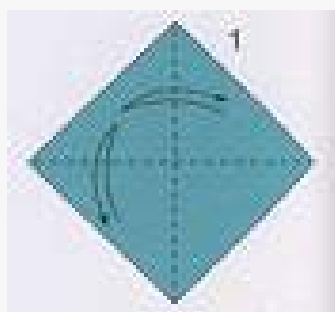



# CONTINUED...

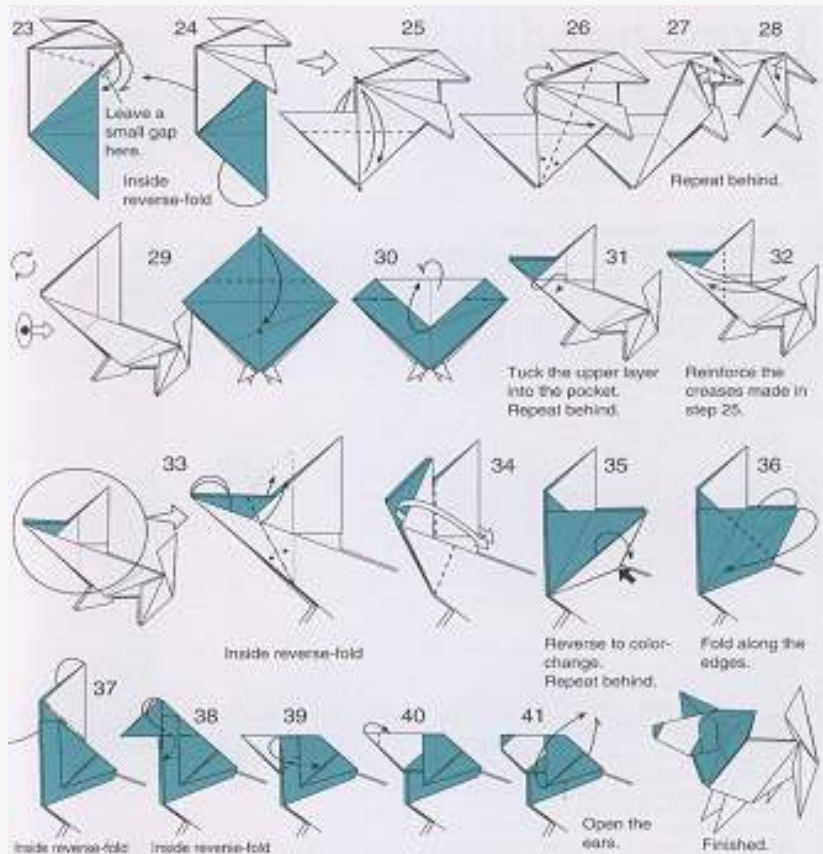



# Origami<sup>TM</sup> Craze

love and joy

FROM ORIGAMI CRAZE

