

Financial Management

Paper-20

M Com (Final)

**Directorate of Distance Education
Maharshi Dayanand University
ROHTAK – 124 001**

Copyright © 2004, Maharshi Dayanand University, ROHTAK
All Rights Reserved. No part of this publication may be reproduced or stored in a retrieval system
or transmitted in any form or by any means; electronic, mechanical, photocopying, recording or
otherwise, without the written permission of the copyright holder.

Maharshi Dayanand University
ROHTAK - 124 001

Developed & Produced by EXCEL BOOKS PVT. LTD., A-45 Naraina, Phase 1, New Delhi-110028

CONTENTS

Chapter-1:	Introduction to Financial Management	5
Chapter-2:	Cost of Capital	25
Chapter-3:	Operating and Financial Leverage	77
Chapter-4:	Capital Budgeting	94
Chapter-5:	Capital Budgeting Evaluation Techniques	112
Chapter-6:	Capital Budgeting under Risk and Uncertainties	130
Chapter-7:	Working Capital Management	165
Chapter-8:	Cash Management and Marketable Securities	196
Chapter-9:	Management of Receivables	223
Chapter-10:	Inventory Management	244
Chapter-11:	Capital Structure Theories	262
Chapter-12:	Dividend Decisions	330
Chapter-13:	Working Capital Financing	346
Chapter-14:	Regulation of Bank Finance	380

FINANCIAL MANAGEMENT

MCom (Final)

Paper-20

M. Marks : 100

Time : 3 Hrs.

Note: There will be three sections of the question paper. In section A there will be 10 short answer questions of 2 marks each. All questions of this section are compulsory. Section B will comprise of 10 questions of 5 marks each out of which candidates are required to attempt any seven questions. Section C will be having 5 questions of 15 marks each out of which candidates are required to attempt any three question. The examiner will set the questions in all the three sections by covering the entire syllabus of the concerned subject.

Course Inputs

- UNIT-I** Evaluation of Finance, Objectives of the Firm-Profit Max, And Wealth Max, Functions of Financial Management, Organisation of the Finance Function, Cost of Capital: Definition and Concepts, Measurement, the weighted average cost of Capital; Leverage: Operating and Financial, Combined Leverage.
- UNIT-II** Capital Budgeting, Meaning, Importance, Rational of Capital Budget, Nature of Investment Decision, The Administrative framework, methods of appraisal, Capital Rationing, Inflation and Capital Budgeting; Capital budgeting under Risk and Uncertainties.
- UNIT-III** Working Capital Management, Concept, Need, Determinants, Finance mix for working capital, Estimating working capital needs, Cash management; The Cash Budget, Techniques of cash management and marketable securities; Management of receivables; Objectives, Factors affecting policies for managing accounts receivables; Inventory Management; Objectives, Inventory Management techniques.
- UNIT-IV** Financing Decisions: Capital Structure Theories, taxation and capital structure; Planning the capital structure, Factors affecting capital structure, E.B.I.T.-E.P.S. analysis, ROI-ROE analysis, Assessment of Debt Capacity, Capital Structure Policies in Practice.
- Dividend Decision: Theories of Dividends-traditional position, Gordon Model, Walter model, M.M. Model, Radical Model, Factors affecting dividend policy, stock dividends and stock splits, Repurchase of stock procedural and legal aspects of dividends.
- UNIT-V** Sources of Working Capital Funds: Accruals, trade, credit, commercial banks advances, public deposits, Inter corporate deposits, short term loans from financial institution, right debentures for working capital, commercial papers and factoring.
- Regulation of Bank Finance:-Recommendations of Latest Committee.

Chapter-1

Introduction to Financial Management

Companies do not work in a vacuum, isolated from everything else. It interacts and transacts with the other entities present in the economic environment. These entities include Government, Suppliers, Lenders, Banks, Customers, Shareholders, etc. who deal with the organisation in several ways. Most of these dealings result in either money flowing in or flowing out from the company. This flow of money (or funds) has to be managed so as to result in maximum gains to the company.

Managing this flow of funds efficiently is the purview of finance. So we can define finance as the study of the methods which help us plan, raise and use funds in an efficient manner to achieve corporate objectives. Finance grew out of economics as a special discipline to deal with a special set of common problems.

The corporate financial objectives could be to:

1. Provide the link between the business and the other entities in the environment and
2. Investment and financial decision making

Let us first look at what we mean by investment and financial decision making.

1. **Investment Decision:** The investment decision, also referred to as the capital budgeting decision, simply means the decisions to acquire assets or to invest in a project. Assets are defined as economic resources that are expected to generate future benefits.
2. **Financing Decision:** The second financial decision is the financing decision, which basically addresses two questions:
 - a. How much capital should be raised to fund the firm's operations (both existing & proposed)
 - b. What is the best mix of financing these assets?

Financing could be through two ways: debt (loans from various sources like banks, financial institutions, public, etc.) and equity (capital put in by the investors who are also known as owners/ shareholders). Shareholders are owners because the shares represent the ownership in the company.

Funds are raised from financial markets. Financial markets is a generic term used to denote markets where financial securities are traded. These markets include money markets, debt market and capital markets. We will understand them in detail later in the 3rd chapter.

Financing and investing decisions are closely related because the company is going to raise money to invest in a project or assets. Those who are going to give money to the company (whether lenders or investors) need to understand where the company is investing their money and what it hopes to earn from the investments so that they can assure themselves of the safety of their money.

The questions that you may be thinking about right now are "Why do we need to learn finance? Shall we not leave it to the people who are going to specialise in finance? Finance won't help me in the area that I am going to work in, so why learn?" This is to say that the knowledge of finance does not add any value to you. Is it so? Think about it. When you get your pocket money from your parents, you do not go out and blow the whole lot in one day because if you do, your parents are not going to give you more money to last through that month. You quickly learn that you need to plan your expenditure so that the money lasts throughout the month and you may actually plan to save some of it. Those who do not get enough to meet their requirements, think about some clever means to raise more money (like falling sick!). Alternatively if they need more money for the month because of certain special events (like Valentine's day) they can plan to borrow money for a month and repay in the next month.

So you plan, raise and efficiently utilise funds that are your disposal (or at least try to). That a business organisation also needs to do the same can hardly be overemphasised. The scale of operations is much bigger and to efficiently manage funds at this scale, decisions cannot be taken without sound methodology. Finance teaches you this terminology.

For managing these funds the first thing you would need is information. External information has to be collected from the environment and accounting provides internal information about the firm's operations. Accounting can be defined as an information and measurement system that identifies, records, and communicates relevant information about a company's economic activities to people to help them make better decisions.

You would now agree that a company needs to manage its own funds efficiently but your question still remains "Why am I concerned with it?" Further arguing, you say that, "I am going to specialise in Marketing/ Information Technology/ Human Resource Management/ Operations Management and there is no need for me to learn finance. Also Finance is a separate function in my organisation (or the organisation that I am going to work for) and I am hardly going to use finance to work in my respective department."

Think again. Everything that you do has an impact on the profitability of the company (including drinking ten cups of coffee in a day!). So if you want to grow up to be the CEO of the company in a few years from now (which I undoubtedly think that you would love to) you should take the advice of the top CEOs.

79 per cent of the top CEOs rate Finance skills, as the most required for the CEO of the future.

KPMG survey

Better take the CEOs advice. But don't get the feeling that only the CEOs require the Finance Skills, all other functions of management also cannot do without finance and the financial information.

Fields of Finance

The academic discipline of financial management may be viewed as made up of five specialized fields. In each field, the financial manager is dealing with the management of money and claims against money. Distinctions arise because different organizations pursue different objectives and do not face the same basic set of problems. There are five generally recognized areas of finance.

1. **Public Finance.** Central, state and local governments handle large sums of money, which are received from many sources and must be utilized in accordance with detailed policies and procedures. Governments have the authority to tax and otherwise raise funds, and must dispense funds according to legislative and other limitations. Also, government do not conduct their activities to achieve the same goals as private organizations. Businesses try to make profits, whereas a government will attempt to accomplish social or economic objectives. As a result of these and other differences, a specialized field of public finance has emerged to deal with government financial matters.
2. **Securities and Investment Analysis.** Purchase of stocks, bonds, and other securities involve analysis and techniques that are highly specialized. An investor must study the legal and investment characteristics of each type of security, measure the degree of risk involved with each investment, and forecast probable performance in the market. Usually this analysis occurs without the investor having any direct control over the firm or institution represented by the form of security. The field of investment analysis deals with these matters and attempts to develop techniques to help the investor reduce the risk and increase the likely return from the purchase of selected securities.
3. **International Finance.** When money crosses international boundaries individuals, businesses, and governments must deal with special kinds of problems. Each country has its own national currency; thus a citizen of the United States must convert dollars to French francs before being able to purchase goods or services in Paris. Most governments have imposed restrictions on the exchange of currencies, and these may affect business transactions. Governments may be

facing financial difficulties, such as balance-of-payments deficits, or may be dealing with economic problems, such as inflation or high levels of unemployment. In these cases, they may require detailed accounting for the flows of funds or may allow only certain types of international transactions. The study of flows of funds between individuals and organizations across national borders and the development of methods of handling the flows more efficiency are properly within the scope of international finance.

4. **Institutional Finance.** A nation’s economic structure contains a number of financial institutions, such as banks, insurance companies, pension funds, credit unions. These institutions gather money from individual savers and accumulate sufficient amounts for efficient investment. Without these institutions, funds would not be readily available to finance business transactions, the purchase of private homes and commercial facilities, and the variety of other activities that require organizations that perform the financing function of the economy.
5. **Financial Management.** Individual businesses face problems dealing with the acquisition of funds to carryon their activities and with the determination of optimum methods of employing the funds. In a competitive marketplace, businesses and actively manage their funds to achieve their goals. Many tools and techniques have been developed to assist financial managers to recommend proper courses of action.

These tools help the manager determine which sources offer the lowest cost of funds and which activities will provide the greatest return on invested capital. Financial management is the field of greatest concern to the corporate financial officers and will be the major thrust of the approach we shall use in studying finance.

An overview of the five fields of finance is given in Figure 1.1.

Public Finance	Securities and Investment Analysis
<ul style="list-style-type: none"> ● Used in central, state and local government. ● Examines taxes and other revenues. ● Pursues nonprofit goals. 	<ul style="list-style-type: none"> ● Used by individual and institutional investors. ● Measures risk in securities transactions. ● Measures likely return.
<p>Institutional Finance</p> <ul style="list-style-type: none"> ● Examines banks, insurances companies and pension funds. ● Studies saving and capital formation. 	<p>International Finance</p> <ul style="list-style-type: none"> ● Studies economic transactions among nations. ● Concerned with flows among countries.
<p>Financial Management</p> <ul style="list-style-type: none"> ● Studies financial problems in individual firms. ● Seeks sources of low-cost funds. ● Seeks profitable business activities. 	



Objectives of the Firm - Profit Maximisation and Wealth Maximisation

To put it simply, we might say that the goal of any business is to maximise the returns to the owners of the business. So the goal of finance is to help the business in maximising returns. But if you talk to the companies, you also hear about many other goals that they are pursuing at the same time. These goals could include maximisation of sales, maximisation of market share, maximisation of growth rates of sales, maximisation of the market price of the share (whether real or specifically pushed up to benefit the owners), etc. Individually speaking, managers would be more concerned with the money that they are making from the organisation and the benefits that they are receiving rather than care about what the owners are making!

As there could be many goals for the organisation, we should try and summarise the organisational goals in financial terms so that we can call them the financial goals. They boil down to two:

1. Maximise profits or
2. Maximise wealth

Maximise Profits

Let us first look at profit maximisation. Profit (also called net income or earnings) can be defined as the amount a business earns after subtracting all expenses necessary for its sales. To put it in an equation form:

$$\text{Sales} - \text{Expenses} = \text{Profit}$$

If you want to maximise profits, there are only two ways to do it. Either you reduce your expenses (also called costs) or you increase the sales (also called revenues). Both of these are not easy to achieve. Sales can be increased by selling more products or by increasing the price of the products. Selling more products is difficult because of the competition in the market and you cannot increase the price of the products without adding more features or value to it (assuming a competitive market). If you are a competitive company, reducing expenses beyond a certain level is possible only by reducing the investments in advertising, research and development, etc. which ultimately leads to reduction in sales in the long term and threatens the survival of the company. Profit maximisation goal assumes that many of the complexities of the real world do not exist and is, therefore, not acceptable.

Still, profit maximisation remains one of the key goals for the managers of the company because many managers' compensations are linked to the profits that the company is generating. Owners need to be aware of these goals and understand that it is the long-term viability of their companies that add value to them and not the short-term profitability.

Therefore, the long-term survival of the company should not be sacrificed for the short-term benefits.

Wealth Maximisation

Shareholders' wealth can be defined as the total market value of all the equity shares of the company. So when we talk about maximising wealth we talk about maximising the value of each share. How the decisions taken by the organisation affects the value of the organisation is reflected in the figure 1.1.

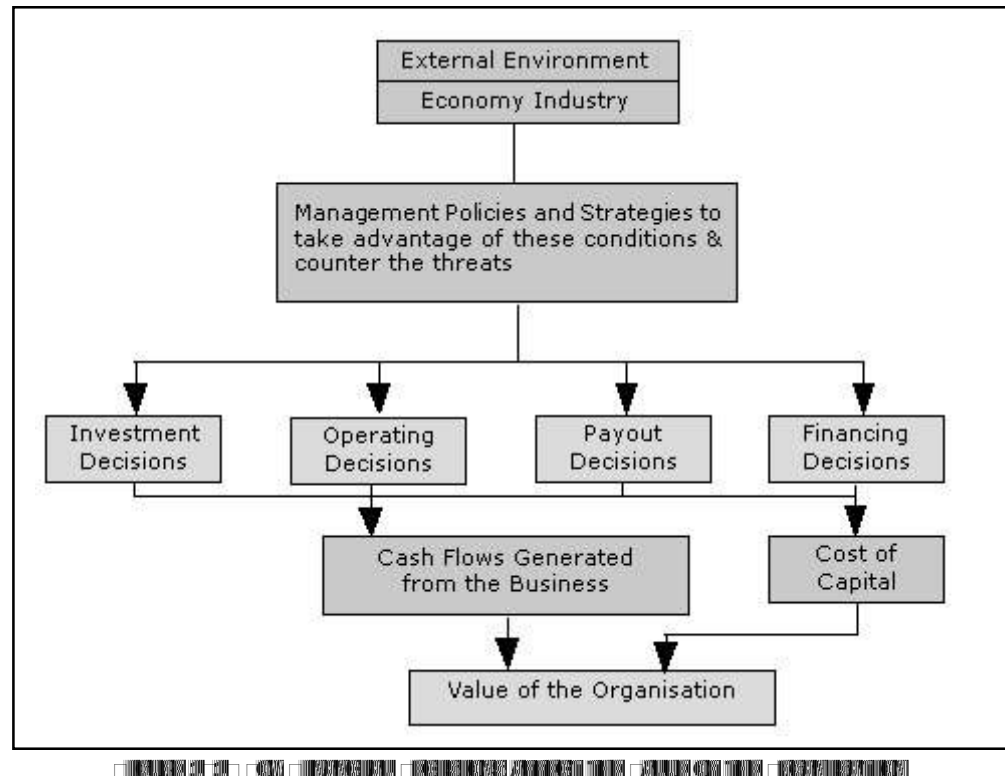

The shareholders' wealth maximisation goal gives us the best results because effects of all the decisions taken by the company and its managers are reflected in it. In order to employee use this goal, we do not have to consider every price change of our shares in the market as an interpretation of the worth of the decisions that the company has taken. What the company needs to focus on is the affect that its decision should have on the share price if everything else was held constant. This conflict of the decisions by the managers and the decisions required by the owners is known as the agency problem. How are companies solving this problem will be discussed later.

Scope of Financial Management

The approach to the scope and functions of financial management is divided, for purposes of exposition, into two broad categories: (a) The Traditional Approach, and (b) The Modern Approach.

Traditional Approach

The traditional approach to the scope of financial management refers to its subject-matter, in academic literature in the initial stages of its evolution, as a separate branch of academic study. The term 'corporation finance' was used to describe what is now known in the academic world as 'financial management'. As the name suggests, the concern of corporation finance was with the financing of corporate enterprises. In other words, the scope of the finance function was treated by the traditional approach in the narrow sense of procurement of funds by corporate enterprise to meet their financing needs. The term 'procurement' was used in a broad sense so as to include the whole gamut of raising funds externally. Thus defined, the field of study dealing with finance was treated as encompassing three interrelated aspects of raising and administering resources from outside: (i) the institutional arrangement in the form of financial institutions which comprise the organization of the capital market; (ii) the financial instruments through which funds are raised from the capital markets and the related aspects of practices and the procedural, aspects of capital markets; and (iii) the legal and accounting relationships between a firm and its sources of funds. The coverage of corporation finance was, therefore, conceived to describe the rapidly evolving complex of capital market institutions, instruments and practices. A related aspect was that firms require funds at certain episodic events such as merger, liquidation, reorganization and soon. A detailed description of these major events constituted the second element of the scope of this field of academic study. That these were the broad features of the subject-matter of corporation finance is eloquently reflected in the academic writings around the period during which the traditional approach dominated academic thinking. Thus, the issue to which literature on finance addressed itself was how resources could best be raised from the combination of the available sources.

The traditional approach to the scope of the finance function evolved during the 1920s and 1930s and dominated academic during the forties and through the early fifties. It has now been discarded as it suffers from serious limitations. The weaknesses of the traditional approach fall into two broad categories: (i) those relating to the treatment of various topics and the emphasis attached to them; and (ii) those relating to the basic conceptual and analytical framework of the definitions and scope of the finance function.

The first argument against the traditional approach was based on its emphasis on issues relating to the procurement of funds by corporate enterprises. This approach was challenged during the period when the approach dominated the scene itself. Further, the traditional treatment of finance was criticised because the finance function was equated with the issues involved in raising and administering funds, the theme was woven around the viewpoint of the suppliers of funds such as investors, investment bankers and so on, that is, the outsiders. It implies that no consideration was given to the viewpoint of those who had to take internal financial decisions. The traditional treatment was, in other words, the *outsider-looking-in approach*. The limitation was that internal decision making (i.e. *insider-looking out*) was completely ignored.

The second ground of criticism of the traditional treatment was that the focus was on financing problems of corporate enterprises. To that extent the scope of financial management was confined only to a segment of the industrial enterprises, as non-corporate organisations lay outside its scope.

Yet another basis on which the traditional approach was challenged was that the treatment was built too closely around episodic events, such as promotion, incorporation, merger, consolidation, reorganisation and so on. Financial management was confined to a description of these infrequent happenings in the life of an enterprise. As a logical corollary, the day-to-day financial problems of a normal company did not receive much attention.

Finally, the traditional treatment was found to have a lacuna to the extent that the focus was on long-term financing. Its natural implication was that the Issues involved in working capital management were not in the purview of the finance function.

The limitations of the traditional approach were not entirely based on treatment or emphasis of different aspects. In other words, its weaknesses were more fundamental. The conceptual and analytical shortcoming of this approach arose from the fact that it confined financial management to issues involved in procurement of external funds, it did not consider the important dimension of allocation of capital. The conceptual framework of the traditional treatment ignored what Solomon aptly describes as the *central issues of financial management*. These issues are reflected in the following fundamental questions which a finance manager should address. Should an enterprise commit capital funds to certain purposes do the expected returns meet financial standards of performance? How should these standards be set and what is the cost of capital funds to the enterprise? How does the cost vary with the mixture of financing methods used? In the absence of the coverage of these crucial aspects, the traditional approach implied a very narrow scope for financial management. The modern approach provides a solution to these shortcomings.

Modern Approach

The modern approach views the term financial management in a broad sense and provides a conceptual and analytical framework for financial making. According to it, the finance function covers both acquisition of funds as well as their allocations. Thus, apart from the issues involved in acquiring-external funds, the main concern of financial management is the efficient and wise allocation of funds to various uses. Defined in a broad sense, it is viewed as an integral part of overall management.

The new approach is an analytical way of viewing the financial problems of a firm. The main contents of this approach are what is the total volume of funds an enterprise should commit? What specific assets should an enterprise acquire? How should the funds required be financed? Alternatively, the principal contents of the modern approach to financial management can be said to be: (i) How large should an enterprise be, and how fast should it grow? (ii) In what form should it hold assets? and (iii) What should be the composition of its liabilities?

The three questions posed above cover between them the major financial problems of a firm. In other words, financial management, according to the new approach, is concerned with the solution of three major problems relating to the financial operations of a firm, corresponding to the three questions of investment, financing and dividend decisions. Thus, financial management, in the modern sense of the term, can be broken down into three major decisions as functions of finance: (i) The investment decision, (ii) The financing decision, and (iii) The dividend policy decision.

The investment decision relates to the selection of assets in which funds will be invested by a firm. The assets which can be acquired fall into two broad groups: (i) long-term assets which yield a return over a period of time in the future, (ii) short-term or current assets, defined as those assets which in the normal course of business are convertible into cash without diminution in value, usually within a year. The first of these involving the first category of assets is popularly known in financial literature as *capital budgeting*. The aspect of financial decision making with reference to current assets or short-term assets is popularly termed as *working capital management*.

Capital Budgeting is probably the most important financial decision for a firm. It relates to the selection of an asset or investment proposal or course of action whose benefits are likely to be available in the future over the lifetime of the project. The long-term assets can be either new or old/existing ones. The first aspect of the capital budgeting decision relates to the choice of the new asset out of the alternatives available or the reallocation of capital when an existing asset fails to justify the funds committed. Whether an asset will be accepted or not will depend upon the relative benefits and returns associated with it. The measurement of the worth of the investment proposals is, therefore, a major element in the capital budgeting exercise. This implies a discussion of the methods of appraising investment proposals.

The second element of the capital budgeting decision is the analysis of risk and uncertainty. Since the benefits from the investment proposals extend into the future, their accrual is uncertain. They have to be estimated under various assumptions of the physical volume of sale and the level of prices. An element of risk in the sense of uncertainty of future benefits is, thus, involved in the exercise. The returns from capital budgeting decisions should, therefore, be evaluated in relation to the risk associated with it.

Finally the evaluation of the worth of a long-term project implies a certain norm or standard against which the benefits are to be judged. The requisite norm is known by different names such as *cut-off rate*, *hurdle rate*, *required rate*, *minimum rate of return* and so on. This standard is broadly expressed in terms of the cost of capital. The concept and measurement of the cost of capital is, thus, another major aspect of capital budgeting decision. In brief, the main elements of capital budgeting decisions are: (i) the long-term assets and their composition, (ii) the business risk complexion of the firm, and (iii) concept and measurement of the cost of capital.

Working Capital Management is concerned with the management of current assets. It is an important and integral part of financial management as short-term survival is a prerequisite for long-term success. One aspect of working capital management is the trade-off between profitability and risk (liquidity). There is a conflict between profitability and liquidity. If a firm does not have adequate working capital, that is, it does not invest sufficient funds in current assets, it may become illiquid and consequently may not have the ability to meet its current obligations and, thus, invite the risk of bankruptcy. If the current assets are too large, profitability is adversely affected. The key strategies and considerations in ensuring a tradeoff between profitability and liquidity is one major dimension of working capital management. In addition, the individual current assets should be efficiently managed so that neither inadequate nor unnecessary funds are

locked up. Thus, the management of working capital has two basic ingredients: (1) an overview of working capital management as a whole, and (2) efficient management of the individual current assets such as cash, receivables and inventory.

The second major decision involved in financial management is the financing decision. The investment decision is broadly concerned with the asset-mix or the composition of the assets of a firm. The concern of the financing decision is with the financing-mix or capital structure or leverage. The term capital structure refers to the proportion of debt (fixed-interest sources of financing) and equity capital (variable-dividend securities/ source of funds). The financing decision of a firm relates to the choice of the proportion of these sources to finance the investment requirements. There are two aspects of the financing decision. First, the theory of capital structure which shows the theoretical relationship between the employment of debt and the return of the shareholders. The use of debt implies a higher return to the shareholders as also the financial risk. A proper balance between debt and equity to ensure a trade-off between risk and return to the shareholders is necessary. A capital structure with a reasonable proportion of debt and equity capital is called the optimum capital structure. Thus, one dimension of the financing decision whether there is an optimum capital structure? And in what proportion should funds be raised to maximise the return to the shareholders? The second aspect of the financing decision is the determination of an appropriate capital structure, given the facts of a particular case. Thus, the financing decision covers two interrelated aspects: (1) capital structure theory, and (2) capital structure decision.

The third major decision of financial management is the decision relating to the dividend policy. The dividend should be analysed in relation to the financing decision of a firm. Two alternatives are available in dealing with the profits of a firm: they can be distributed to the shareholders in the form of dividends or they can be retained in the business itself. The decision as to which course should be followed depends largely on a significant element in the dividend decision, the dividend payout ratio, that is, what proportion of net profits should be paid out to the shareholders. The final decision will depend upon the preference of the shareholders and investment opportunities available within the firm. The second major aspect of the dividend decision is the factors determining dividend policy of a firm in practice.

To conclude, the traditional approach had a very narrow perception and was devoid of an integrated conceptual and analytical framework. It had rightly been discarded in current academic literature. The modern approach has broadened the scope of financial management which involves the solution of three major decisions, namely, investment, financing and dividend. These are interrelated and should be jointly taken so that financial decision-making is optimal. The conceptual framework for optimum financial decisions is the objective of financial management. In other words, to ensure an optimum decision in respect of these three areas, they should be related to the objectives of financial management.

Functions of Financial Management

The traditional function of financial management has been limiting the role of finance to raising and administrating of funds needed by the company to meet their financial needs.

It broadly covered:

1. Arrangement of funds through financial institutions
2. Arrangement of funds through financial instruments
3. Looking after the legal and accounting relationship between a corporation and its sources of funds

This has outlived its utility. With the advent of technology and need to tighten ships because of competition, financial management became as much a science as art. Efficient allocation of funds became the imperative. The modern approach is an analytical way of looking at the financial problems of a firm with the main concerns like:

1. What is the total volume of funds committed
2. What specific assets should be acquired or divested
3. How should the funds required be financed and from which markets

The above questions relate to four broad decision areas, these are:

1. **Investment decision:** Decisions relating to investment in both capital and current assets. The finance manager has to evaluate different capital investment proposals and select the best keeping in view the overall objective of the enterprise. Capital Budgeting is the typical name given to this decision.
2. **Financing Decision:** Provision of funds required at the proper time is one of the primary tasks of the finance manager. Identification of the sources, deciding which types of funds to raise (debt or equity), and raising them is one of the crucial tasks.
3. **Dividend Decision:** Determination of funds requirements and how much of it will be generated from internal accruals and how much to be sourced from outside is a crucial decision. Equity holders are the owners and require returns, and how much money to be paid to them is a crucial decision.
4. **Working Capital Decision:** The investment in current assets is a major activity that a finance manager is engaged in a day to day basis. How much inventory to keep, how much receivables can be managed, and what is the optimum cash levels, are three of the key questions that are dealt with regularly.

All these decisions interact, investment decision cannot be taken without taking the financing decision, working capital decision also needs financing, dividend decision is a payout mechanism and has to be taken care of from financing. These tasks are divided and are taken care of by various entities.

Objectives of Financial Management

To make wise decisions a clear understanding of the objectives which are sought to be achieved is necessary. The objectives provide a framework for optimum financial decision-making. In other words, they are concerned with designing a method of operating the internal investment and financing of a firm. We discuss in this section the alternative approaches in financial literature. There are two widely-discussed approaches: (i) Profit maximisation approach and (ii) Wealth maximisation approach.

It should be noted at the outset that the term 'objective' is used in the sense of a goal or *decision criterion* for the three decisions involved in financial management. It implies that what is relevant is not the overall objective or goal of a business but an operationally useful criterion by which to judge a specific set of mutually interrelated business decisions, namely, investment, financing and dividend policy. The second point that should be clearly understood is that the term objectives provides a normative framework. That is the focus in financial literature is on what a firm should try to achieve and on policies that should be followed if certain goals are to be achieved. The implication is that these are not necessarily followed by firms in actual practice. They are rather employed to serve as a basis for theoretical analysis and do not reflect contemporary empirical industry practices. Thus, the term is used in a rather narrow sense of what a firm *should attempt* to achieve with its investment, financing and dividend policy decisions.

Profit Maximisation Decision Criterion

According to this approach, actions that increase profits should be undertaken and those that decrease profits are to be avoided. In specific operational terms, as applicable to financial management, the profit maximisation criterion implies that the investment, financing and dividend policy decisions of a firm should be oriented to the maximisation of profits.

The term 'profit' can be used in two senses. As a owner-oriented concept it refers to the amount and share of national income which is paid to the owners of business, that is, those who supply equity capital. As a variant it is described as profitability. It is an operational concept and signifies economic efficiency. In other words, profitability refers to a situation where output exceeds input, that is, the value created by the use of resources is more than the total of the input resources. Used in this sense, profitability maximisation would imply that a firm should be guided in financial decision making by one test; select assets, projects and decisions which are profitable and reject those which are not. In the current financial literature, there is a general agreement that profit maximisation is used in the second sense.

The rationale behind profitability maximisation, as a guide to financial decision making, is simple. Profit is a test of economic efficiency. It provides the yardstick by

which economic performance can be judged. Moreover, it leads to efficient allocation of resources, as resources tend to be directed to uses which in terms of profitability are the most desirable. Finally, it ensures maximum social welfare. The individual search for maximum profitability provides the famous ‘invisible hand’ by which total economic welfare is maximised. Financial management is concerned with the efficient use of an important economic resource (input), namely, capital. It is, therefore, argued that profitability maximisation should serve as the basic criterion for financial management decisions.

The profit maximisation criterion has, however, been questioned and criticized on several grounds. The reasons for the opposition in academic literature all into two broad groups: (i) those that are based on misapprehensions about the workability and fairness of the private enterprise itself, and (2) those that arise out of the difficulty of applying this criterion management, refers to an explicit operational guide for the internal investment and financing of a firm and not the overall goal of business operations. We, therefore, focus on the second type of limitations to profit maximisation as an objective of financial management. The main technical flaws of this criterion are ambiguity, timing of benefits, and quality of benefits.

Ambiguity. One practical difficulty with profit maximisation criterion for financial decision making is that the term-profit is a vague and ambiguous concept. It has no precise connotation. It is amenable to different interpretations by different people. To illustrate, profit may be short term or long term; it may be total profit or rate of profit; it may be before-tax or before-tax or after-tax; it may be return on total capital employed or total assets or shareholders equity and so on. If profit maximisation is taken to be the objectives, the question arises, which of these variable of profit should a firm try to maximise? Obviously, a loose expression like profit of operational criterion for financial management.

Timing of Benefits. A more important technical objection to profit maximisation, as a guide to financial decision making, is that it ignores the differences in the time pattern of the benefits received from investment proposals or courses of action. While working out profitability, ‘*the bigger the better*’ principle is adopted, as the decision is based on the total benefits received over the working life of the asset, irrespective of when they were received. Consider Table 1.1

TABLE 1.1: Comparison of Alternatives A and B

	Alternative A (Rs. Lakhs)	Alternative B (Rs. Lakhs)
Period I	50	–
Period II	100	100
Period III	50	100
Total	200	200

It can be seen from Table 1.1 that the total profits associated with the alternatives, A and B, are identical. If the profit maximisation is the decision criterion, both the alternatives would be ranked equally. But the returns from both the alternatives differ in one important respect, while alternative A provides higher returns in earlier years,

the returns from alternative B are larger in later years. As a result, the two alternative courses of "action are not strictly identical. This is primarily because a basic dictum of financial planning is the earlier the better as benefits received sooner are more valuable than benefits received later. The reason for the superiority of benefits now over benefits later lies in the fact that the former can be reinvested to earn a return. This is referred to as time value of money. The profit maximisation criterion does not consider the distinction between returns received in different time periods and treats all benefits irrespective of the timing, as equally valuable. This not true in actual practice as benefits in early years should be valued more highly than equivalent benefits in later years. The assumption of equal value is inconsistent with the real world situation.

Quality of Benefits. Probably the most important technical limitation of profit maximisation as an operational objective, is that it ignores the quality aspect of benefits associated with a financial course of action. The term quality here refers to the degree of certainty with which benefits can be expected. As a rule, the more certain the expected return, the higher is the quality of the benefits. Conversely, the more uncertain/fluctuating is the expected benefits, the lower is the quality of the benefits. An uncertain and fluctuating return implies risk to the investors. It can be safely assumed that the investors are risk-aversers, that is they want to avoid or at least minimise risk. They can, therefore, be reasonably expected to have a preference for a return which is more certain in the sense that it has smaller variance over the years.

The problem of uncertainty renders profit maximisation unsuitable as an operational criterion for financial management as it considers only the size of benefits and gives no weight to the degree of uncertainty of the future benefits. This is illustrated in Table 1.2.



State of Economy	Alternative A	Alternative B
Recession (Period I)	9	0
Normal (Period II)	10	10
Boom (Period III)	11	20
Total	30	30

It is clear from Table 1.2 that the total returns associated with the two alternatives are identical in a normal situation but the range of variations is very wide in case of alternative B, while it is narrow in respect of alternative A. To put it differently, the earnings associated with alternative B are more uncertain (risky) as they fluctuate widely depending on the state of the economy. Obviously, alternative A is better in terms of risk and uncertainty. The profit maximisation criterion fails to reveal this,

To conclude, the profit maximisation criterion is inappropriate and unsuitable as an operational objective of investment, financing and dividend decisions of a firm. It is not only vague and time value of money. It follows from the above that an appropriate operational decision criterion for financial management should (i) be precise and exact, (ii) be based on the 'bigger the better' principle, (iii) consider both quantity and quality dimensions of benefits, and (iv) recognise the time value of money. The alternative to profit maximisation, that is wealth maximisation is one such measure.

Wealth Maximisation Decision Criterion

This is also known as value maximisation or net present worth maximisation. In current academic literature value maximisation is almost universally accepted as an appropriate operations decision criterion for financial management decisions as it removes the technical limitations which characterise earlier profit maximisation criterion. Its operational features satisfy all the three requirements of a suitable operation objective of financial courses of action, namely, exactness, quality of benefits and the time value of money.

The value of an asset should be viewed in terms of the benefits it can produce. The worth of a course of action can similarly be judged in terms of the value of the benefits it produces less the cost of undertaking it. A significant element in computing the value of a financial course of action, is the precise estimation of the benefits associated with it. The wealth maximisation criterion is based on the measurement of benefits in the case of the profit maximisation criterion. Cash flow is a precise concept with a definite connotation. Measuring benefits in terms of cash flow avoids the ambiguity associated with accounting profits. This is the first operational feature of the net present worth maximisation criterion.

The second important feature of the wealth maximisation criterion is that it considers both the quantity and quality dimensions of benefit. At the same time, it also incorporates the time value of money. The operational implication of the uncertainty and timing dimensions of the benefits emanating from a financial decision is that adjustment should be made in the cash flow pattern, firstly, to incorporate risk and, secondly, to make an allowance for differences in the timing of benefits. The value of a course of action must be viewed in terms of its worth to those providing the resources necessary for its undertaking. In applying the value maximisation criterion, the term value is used in terms of worth to the owners, that is, ordinary shareholders. The capitalisation (discount) rate that is employed is, therefore, the rate that reflects the time and risk preferences of the result of higher risk longer time period. Thus, a stream of cash flows that is quite certain might be associated with a rate of 5 per cent, while a very risky stream may carry a 15 per cent discount rate.

For the above reasons the net present value maximisation is superior to the profit maximisation as an operational objective. As a decision criterion, it involves a comparison of value to cost. An action that has a discounted value – reflecting both time and risk – that exceeds its cost can be said to create value. Such actions should be undertaken. Conversely, actions with less value than cost, reduce wealth and should be alternative with the greatest net present value should be selected. In the words of Ezra Solomon,

“The gross present worth of a course of action is equal to the capitalised value of the flow of future expected benefit, discounted (or capitalised) at a rate which reflects their certainty or uncertainty. Wealth or net present worth is the difference between gross present worth and the amount of capital investment required to achieve the benefits being discussed. Any financial action which creates wealth or which has a net present worth above zero is a desirable one and should be undertaken. Any financial action which does not meet this test should be rejected.”

Chapter-2

Cost of Capital

Cost of Capital is the rate that must be earned in order to satisfy the required rate of return of the firm's investors. It can also be defined as the rate of return on investments at which the price of a firm's equity share will remain unchanged.

Each type of capital used by the firm (debt, preference shares and equity) should be incorporated into the cost of capital, with the relative importance of a particular source being based on the percentage of the financing provided by each source of capital. Using of the cost a single source of capital as the hurdle rate is tempting to management, particularly when an investment is financed entirely by debt. However, doing so is a mistake in logic and can cause problems.

Future Cost and Historical Cost

Future cost of capital refers to the expected cost of funds to be raised to finance a project. In contrast, historical cost represents cost incurred in the past in acquiring funds. In financial decisions future cost of capital is relatively more relevant and significant. While evaluating viability of a project, the finance manager compares expected earnings from the project with expected cost of funds to finance the project. Likewise, in taking financing decisions, attempt of the finance manager is to minimise future cost of capital and not the costs already defrayed. This does not imply that historical cost is not relevant at all. In fact, it may serve as a guideline in predicting future costs and in evaluating the past performance of the company.

Component Cost and Composite Cost

A company may contemplate to raise desired amount of funds by means of different sources including debentures, preferred stock, and common stocks. These sources constitute components of funds. Each of these components of funds involves cost to the company. Cost of each component of funds is designated as component or specific cost of capital. When these component costs are combined to determine the overall cost of capital, it is regarded as composite cost of capital, combined cost of capital or weighted cost of capital, The composite cost of capital, thus, represents the average of the costs of each sources of funds employed by the company. For capital budgeting decision, composite cost of capital is relatively more relevant even though the firm may finance one proposal with only one source of funds and another proposal with another source. This is for the fact that it is the overall mix of financing over time which is materially significant in valuing firm as an ongoing overall entity.

Average Cost and Marginal Cost

Average cost represents the weighted average of the costs of each source of funds employed by the enterprise, the weights being the relative share of each source of funds in the capital structure. Marginal cost of capital, by contrast refers to incremental cost associated with new funds raised by the firm. Average cost is the average of the component marginal costs, while the marginal cost is the specific concept used to comprise additional cost of raising new funds. In financial decisions the marginal cost concept is most significant.

Explicit Cost and Implicit Cost

Cost of capital can be either explicit cost or implicit. The explicit cost of any source of capital is the discount rate that equates the present value of the cash inflows that are incremental to the taking of the financing opportunity with the present value of its incremental cash outlay. Thus, the explicit cost of capital is the internal rate of return of the cash flows of financing opportunity.

A series of each flows are associated with a method of financing. At the time of acquisition of capital, cash inflow occurs followed by the subsequent cash outflows in the form, of interest payment, repayment of principal money or payment of dividends. Thus, if a company issues 10 per cent perpetual debentures worth Rs. 10,00,000, there will be cash inflow to the firm of the order of 10,00,00. This will be followed by the annual cash outflow of Rs. 1,00,000. The rate of discount, that equates the present value of cash inflows with the present value of cash outflows, would be the explicit cost of capital.

The technique of determination of the explicit cost of capital is similar to the one used to ascertain IRR, with one difference, in the case of computation of the IRR, the cash outflows occur at the beginning followed by subsequent cash inflows while in the computation of the explicit cost of capital, cash inflow takes place at the beginning followed by a series of cash inflow subsequently.

The formula used to compute the explicit cost of capital (C) is:

$$CI_0 = \sum_{t=1}^n \frac{CO^t}{(1+C)^t} \quad \dots(1)$$

Where,

CI_0 = net cash inflow in period 0.

CO^t = cash outflow in period under reference

C = Explicit cost of capital

The explicit cost of an interest bearing debt will be the discount rate that equates the present value of the contractual future payments of interest and principal with the net amount of cash received today. The explicit cost of capital of a gift is minus 100 per cent, since no cash outflow will occur in future.

Similarly, explicit cost of retained earnings which involve no future flows to or from the firm is minus 100 per cent. This should not tempt one to infer that the retained earnings is cost free. As we shall discuss in the subsequent paragraphs, retained earnings do cost the firm. The cost of retained earnings is the opportunity cost of earning on investment elsewhere or in the company itself. Opportunity cost is technically termed as implicit cost of capital. It is the rate of return on other investments available to the firm or the shareholders in addition to that currently being considered. Thus, the implicit cost of capital may be defined as the rate of return associated with the best investment opportunity for the firm and its Shareholders that will be foregone if the project presently under consideration by the firm were accepted. In this connection it may be mentioned that explicit costs arise when the firm raises funds for financing the project. It is in this sense that retained earnings has implicit cost. Other forms of capital also have implicit costs once they are invested, Thus in a sense, explicit costs may also be viewed as opportunity costs. This implies that a project should be rejected if it has a negative present value when its cash flows are discounted by the explicit cost of capital.

It is clear thus that the *cost of capital* is the rate of return a firm must earn on its investments for the market value of the firm to remain unchanged. Acceptance of projects with a rate of return below the cost of capital will decrease the value of the firm; acceptance of projects with a rate of return above the cost of capital will increase the value of the firm. The objective of the financial manager is to maximize the wealth of the firm's owners. Using the cost of capital as a basis for accepting or rejecting investments is consistent with this goal.

Risk

A basic assumption of traditional cost of capital analysis is that *the firm's business and financial risk are unaffected* by the acceptance and financing of projects.

Business risk is related to the response of the firm's earnings before interest and taxes, or operating profits, to changes in sales. When the cost of capital is used to evaluate investment alternatives, it is assumed that acceptance of the proposed projects will not affect the firm's business risk. The types of projects accepted by a firm can greatly affect its business risk.

If a firm accepts a project that is considerably more risky than average, suppliers of funds to the firm are quite likely to raise the cost of funds. This is because of the decreased probability of the fund suppliers' receiving the expected returns on their money. A long-term lender will charge higher interest on loans if the probability of receiving periodic interest from the firm and ultimately regaining the principal is decreased. Common stockholders will require the firm to increase earnings as compensation for increases in the uncertainty of receiving dividend payments or ably appreciation in the value of their stock.

In analyzing the cost of capital it is assumed that the business risk of the firm remains unchanged (i.e., that the projects accepted do not affect the variability of the firm's sales revenues). This assumption eliminates the need to consider changes in the cost of specific sources of financing resulting from changes in business risk. The definition

of the cost of capital developed in this chapter is valid only for projects that do not change the firm's business risk.

Financial risk is affected by the mixture of long-term financing, or the capital structure, of the firm. Firms with high levels of long-term debt in proportion to their equity are more risky than firms maintaining lower ratios of long-term debt to equity. It is the contractual fixed-payment obligations associated with debt financing that make a firm financially risky. The greater the amount of interest and principal (or sinking-fund) payments a firm must make in a given period, the higher the operating profits required to cover these charges. If a firm fails to generate sufficient revenues to cover operating charges, it may be forced into bankruptcy.

As a firm's financial structure shifts toward suppliers of funds recognize a more highly levered position the increased financial risk associated with the firm. They compensate for this increased risk by charging higher rates of interest or requiring greater returns. In short they react in much the same way as they would to increasing business risks.

Frequently the funds supplied to a firm by lenders will change its financial structure, and the charge for the funds will be based on the changed financial structure. In the analysis of the cost of capital in this chapter, however, the firm's financial structure is assumed to remain fixed. This assumption is necessary in order to isolate the costs of the various forms of financing. If the firm's capital structure were not held constant, it would be quite difficult to find its cost of capital, since the selection of a given source of financing would change the costs of alternate sources of financing. The assumption of a constant capital structure implies that when a firm raises funds to finance a given project these funds are raised in the same proportions as the firm's existing financing. The awkwardness of this assumption is obvious since in reality a firm raises funds in "lumps," it does not raise a mixture of small amounts of various types of funds. For example, in order to raise Rs. 1 million a firm may sell either bonds, preferred stock, or common stock in the amount of Rs. 1 million; or, it may sell Rs. 400,000 worth of bonds, Rs. 100,000 worth of preferred stock, and Rs. 500,000 worth of common stock. Most firms will use the former strategy, but our analysis of cost of capital is based on the assumption that the firm will follow the latter strategy. More sophisticated approaches for measuring the cost of capital when a firm's capital structure is changing are rare available.

The key factor affecting financing Costs

Since the cost of capital is measured under the assumption that both the firm's asset structure and its capital (financial) structure are fixed, the only factor that affects the various specific costs of financing is the supply and demand forces operating in the market for long-term funds. In other words, as a firm raises long-term funds at different points in time, the only factor affecting their cost is the riskless cost of the particular type of financing. Regardless of the type of financing used, the following relationship should prevail:

$$k_j = r_f + b + f \quad \dots(2)$$

where

k_j = the specific cost of the various types of long-term financing, j

r_j = the riskless cost of the given type of financing, j

b = the business risk premium

f = the financial risk premium

Equation 2 indicates that the cost of each specific type of capital depends on the riskless cost of that type of funds, the business risk of the firm, and the financial risk of the firm.

Since the firm's business and financial risk are assumed to be constant, the changing cost of each type of capital, j , over time should be affected only by changes in the *supply of and demand for* each type of funds, j . The cost of each type of capital to a given firm compared to the cost to another firm (i.e., the *inter firm* comparison) can differ because of differences in the degree of business and financial risk associated with each firm, since the riskless cost of the given type of funds remains constant. Different business and financial risk premiums are associated with different levels of business and financial risk. These premiums are a function of the business risk, b , and financial risk, f , of a firm. For *intra firm* (i.e., time series) comparisons, the only differentiating factor is the cost of the type of financing, since business and financial risk are assumed to be constant. An example may help to clarify these points.

Example

The W.T. L. Company's cost of long-term debt two years ago was 8 percent. This 8 percent was found to represent a 4-percent riskless cost of long-term debt, a 2-percent business risk premium, and a 2-percent financial risk premium. Currently, the riskless cost of long-term debt is 6 percent. How much would you expect the W. T. L.'s cost of debt to be today, assuming that the risk structure of the firm's assets (business risk) and its capital structure (financial risk) have remained unchanged? The previous business risk premium of 2 percent and financial risk premium of 2 percent will still prevail, since neither of these risks has changed in two years. Adding the 4 percent total risk premiums (i.e., the 2-percent business risk and the 2-percent financial risk premium) to the 6-percent riskless cost of long-term debt results in a cost of long-term debt to the W. T. L. Company of 10 percent. In this time-series comparison, where business risk and financial risk are assumed to be constant, the cost of the long-term funds changes only in response to changes in the riskless cost of a given type of funds.

Let us now suppose that there is another company, the Plate Company, for which the riskless cost of long-term debt is the same as it is for W. T. L. The Plate Company has a 2-percent business risk premium and a 4-percent financial risk premium because of the high degree of leverage in its financial structure. Although both companies are in the same type of business (and thus have the same business risk premium of 2 percent), the cost of long-term debt to the Plate Company is 12 percent (i.e., the 6-percent riskless cost of money,

Although the relationship between r_j , b , and f , is presented as linear in Equation A, this is only for simplicity; the actual relationship is likely to be much more complex mathematically. The only definite conclusion that can be drawn is that the cost of a

specific type of financing for a firm is somehow functionally related to the riskless cost of that type of financing adjusted for the firm's business and financial risk (i.e., that $k_j = f(r; b, f)$).

The reader should recognize that the riskless cost of each type of financing, 'I, may differ considerably. In other words, at a given point in time the riskless cost of debt may be 6 percent while the riskless cost of common stock may be 9 percent. The riskless cost is expected to be different for each type of financing, j . The risk less cost of different maturities of the same type of debt may differ, since longer-term Issues are generally viewed as more risky.

Factors determining the cost of capital

There are several factors that impact the cost of capital of any company. This would mean that the cost of capital of any two companies would not be equal. Rightly so as these two companies would not carry the same risk.

- **General economic conditions:** These include the demand for and supply of capital within the economy, and the level of expected inflation. These are reflected in the riskless rate of return and is common to most of the companies.
- **Market conditions:** The security may not be readily marketable when the investor wants to sell; or even if a continuous demand for the security does exist, the price may vary significantly. This is company specific.
- **A firm's operating and financing decisions:** Risk also results from the decisions made within the company. This risk is generally divided into two classes:
 - Business risk is the variability in returns on assets and is affected by the company's investment decisions.
 - Financial risk is the increased variability in returns to the common stockholders as a result of using debt and preferred stock.
- **Amount of financing required:** The last factor determining the company's cost of funds is the amount of financing required, where the cost of capital increases as the financing requirements become larger. This increase may be attributable to one of the two factors:
 - As increasingly larger public issues are increasingly floated in the market, additional flotation costs (costs of issuing the security) and underpricing will affect the percentage cost of the funds to the firm.
 - As management approaches the market for large amounts of capital relative to the firm's size, the investors' required rate of return may rise. Suppliers of capital become hesitant to grant relatively large amounts of funds without evidence of management's capability to absorb this capital into the business.

Generally, as the level of risk rises, a larger risk premium must be earned to satisfy company's investors. This, when added to the risk-free rate, equals the firm's cost of capital.

Significance of the Cost of Capital

It should be recognized at the outset that the cost of capital is one of the most difficult and disputed topics in the finance theory. Financial experts express conflicting opinions as to the way in which the cost of capital can be measured. It should be noted that it is a concept of vital importance in the financial decision-making. It is useful as a standard for:

- evaluating investment decisions,
- designing a firm's debt policy, and
- appraising the financial performance of top management.

Investment evaluation The primary purpose of measuring the cost of capital is its use as a financial standard evaluating the investment projects. In the NPV method, an investment project is accepted if it has a positive NPV. The project's NPV is calculated by discounting its cash flows by the cost of capital. In this sense, the cost of capital is the discount rate used for evaluating the desirability of an investment project. In the IRR method, the investment project is accepted if it has an internal rate of return greater than the cost of capital. In this context, *the cost of capital is the minimum return on an investment project*. It is also known as the cutoff, or the target, or the hurdle rate.

An investment project that provides positive NPV when its cash flows are discounted by the cost of capital makes a *net* contribution to the wealth of shareholders. If the project has zero NPV, it means that its return is just equal to the cost of capital, and the acceptance or rejection of the project will not affect the wealth of shareholders. The cost of capital is the minimum required rate of return on the investment project that keeps the present wealth of shareholders unchanged. It may be, thus, noted that the cost of capital represents a financial standard for allocating the firm's funds, supplied by owners and creditors, to the various investment projects in the most efficient manner.

Designing debt policy The debt policy of a firm is significantly influenced by the cost consideration. In designing the financing policy, that is, the proportion of debt and equity in the capital structure, the firm aims at the cost of capital. The relationship between the cost of capital and the capital structure decision is discussed later on.

The cost of capital can also be useful in deciding about the methods of financing at a point of time. For example, cost may be compared in choosing between leasing and borrowing. Of course, equally important considerations are control and risk.

Performance appraisal Further, the cost of capital framework can be used to evaluate the financial performance of top management. Such an evaluation will involve a comparison of actual profitability of the investment projects undertaken by the firm with the project overall cost of capital, and the actual cost incurred by management in raising the required funds.

The cost of capital also plays a useful role in dividend decision and investment in current assets. The chapters dealing with these decisions show their linkages with the methods of financing with the cost of capital.

Measurement

Time Value of Money

If an individual behaves rationally, then he would not equate money in hand today with the same value a year from now. In fact, he would prefer to receive today than receive after one year. The reasons cited by him for preferring to have the money today include:

1. Uncertainty of receiving the money later.
2. Preference for consumption today.
3. Loss of investment opportunities.
4. Loss in value because of inflation.

The last two reasons are the most sensible ones for looking at the time value of money. There is a 'risk free rate of return' (also called the time preference rate) which is used to compensate for the loss of not being able to invest at any other place. To this a 'risk premium' is added to compensate for the uncertainty of receiving the cash flows.

$$\text{Required rate of return} = \text{Risk free rate} + \text{Risk premium}$$

The risk free rate compensates for opportunity lost and the risk premium compensates for risk. It can also be called as the 'opportunity cost of capital' for investments of comparable risk.

To calculate how the firm is going to benefit from the project we need to calculate whether the firm is earning the required rate of return or not. But the problem is that the projects would have different time frames of giving returns. One project may be giving returns in just two months, another may take two years to start yielding returns. If both the projects are offering the same %age of returns when they start giving returns, one which gives the earnings earlier is preferred.

This is a simple case and is easy to solve where both the projects require the same capital investment, but what if the projects required different investments and would give returns over a different period of time? How do we compare them? The solution is not that simple. What we do in this case is bring down the returns of both the projects to the present value and then compare. Before we learn about present values, we have to first understand future value.

Future Value

If we are getting a return of 10 % in one year what is the return we are going to get in two years? 20 %, right. What about the return on 10 % that you are going to get at the end of one year? If we also take that into consideration the interest that we get on this 10 % then we get a return of $10 + 1 = 11$ % in the second year making for a total return of 21 %. This is the same as the compound value calculations that you must have learned earlier

$$\text{Future Value} = (\text{Investment or Present Value}) * (1 + \text{Interest})^{\text{No. of time Periods}}$$

The compound values can be calculated on a yearly basis, or on a half-yearly basis, or on a monthly basis or on continuous basis or on any other basis you may so desire. This is because the formula takes into consideration a specific time period and the interest rate for that time period only.

To calculate these values would be very tedious and would require scientific calculators. To ease our jobs there are tables developed which can take care of the interest factor calculations so that our formulas can be written as:

$$\text{Future Value} = (\text{Investment or Present Value}) * (\text{Future Value Interest Factor } n,i)$$

where n = no of time periods and i = is the interest rate.

Let us look at an example of how we calculate the future value:

Example

Rs 7000 are invested at 5% per annum compound interest compounded annually. What will be the amount after 20 years?

Solution

Here $i = 0.05$, $P = 7000$, and $n = 20$. Putting it in the formula we get:

$$\text{FV} = 7000 \times (1+0.05)^{20}$$

$$\text{FV} = 7000 \times 2.6533 = \text{Rs } 18573.1$$

We have taken a shortcut here. We looked at the future value of Rs 1 at the end of 20 years at 5% interest in the Future Value Interest Factor Table given at the end of this book (i.e. find the value of Future Value Interest Factor n,i) and found the figure to be 2.6533 and then substituted the figure here to get the answer.

Another way of doing it would be to use a scientific calculator and calculate the value that comes out to be the same.

A third way of doing this would be even more simple. Use a spreadsheet program. Let us see how we use Microsoft Excel to do the same.

Step 1: Go to the Insert menu and choose function. You get a screen that looks like this:

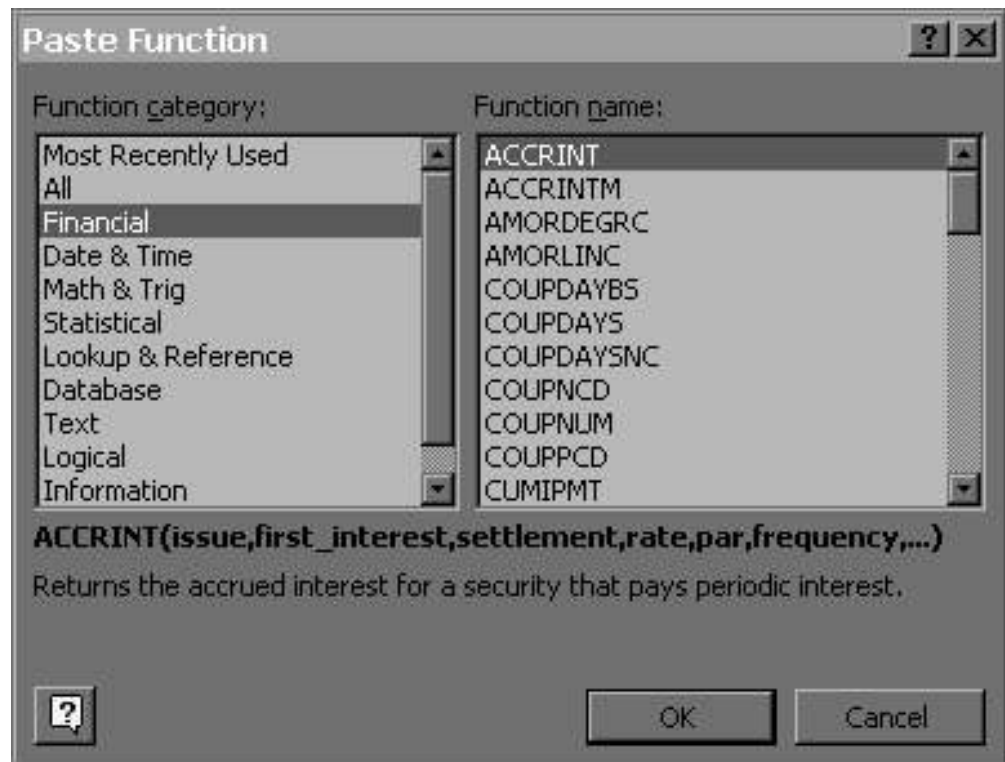

Step 2: In the financial function category choose FV (it stands for Future Value) and press OK.

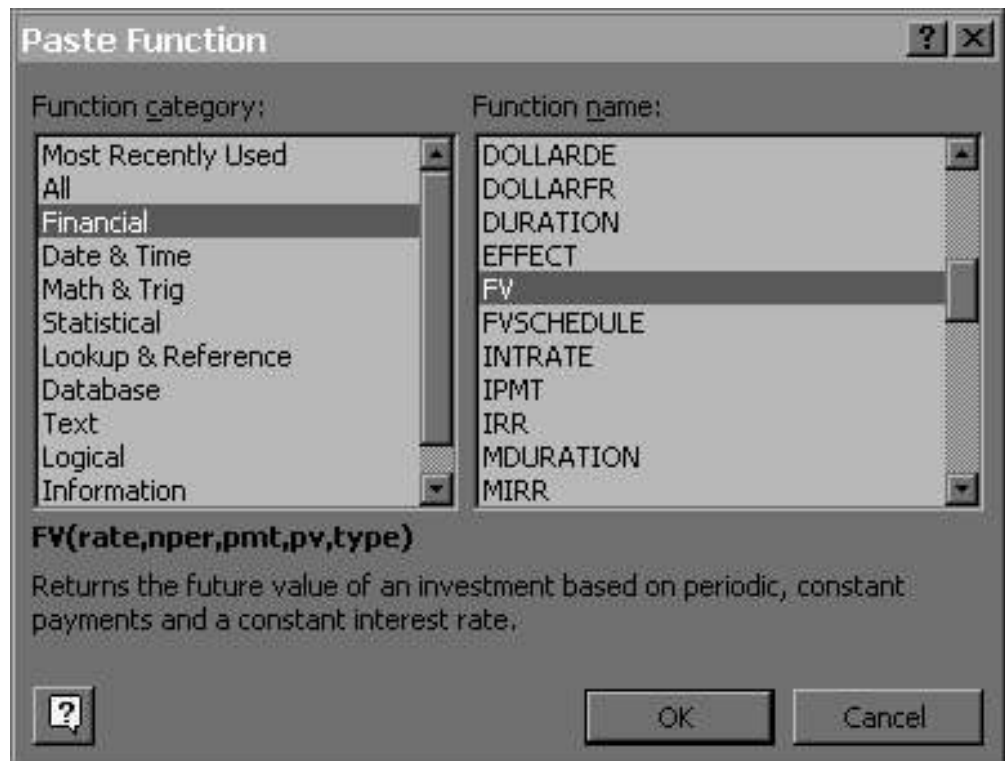

Step 3: You would get a screen that would look like this:

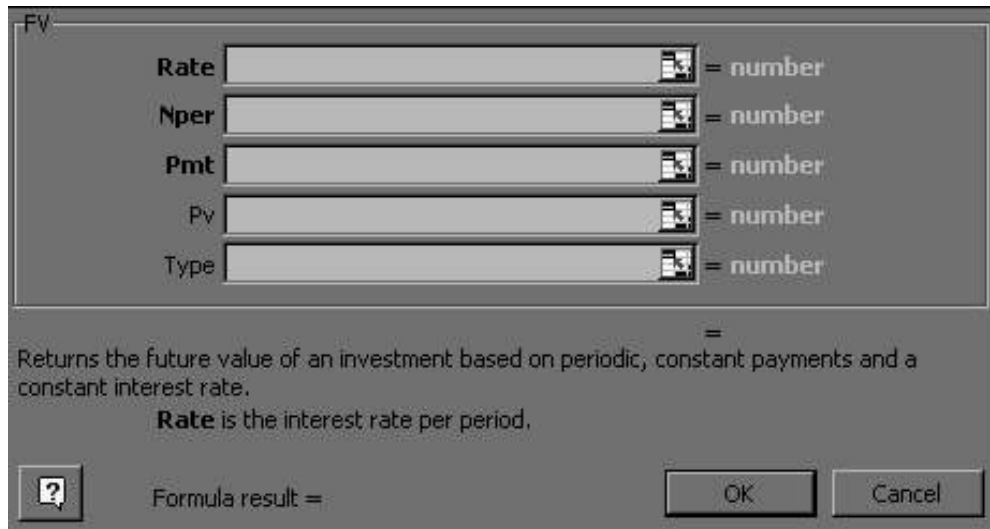

Step 4: Insert the values as given in the example. Here $r = i = 0.05$, Nper is the number of periods = 20, Pmt is the periodic annuity (how to use it we will see a little later) = 0 in this case as there is no annual payment except the first one. Pv is the present value = Rs 7000 in this case and Type is a value representing the timing of the payment = 0 in this case as the investment is done at the end of the period 0 or at the start of the period 1. This also means that we get the returns at the end of the period 20 simultaneously when we make the last payment. Putting these values we get the following screen.

Note that the result of the figures that you input is shown in the formula result section where it is Rs 18,573.08. Compare this with the figure that you get from using the value from the table, a difference of Rs 0.02. Negligible.

What if the money was payable at the start of the period rather than at the end of the period? Here it does not matter as there is only one investment and that is also at the start of the first period. It would matter when we look at the future value of the annuity. But what is an annuity anyway?

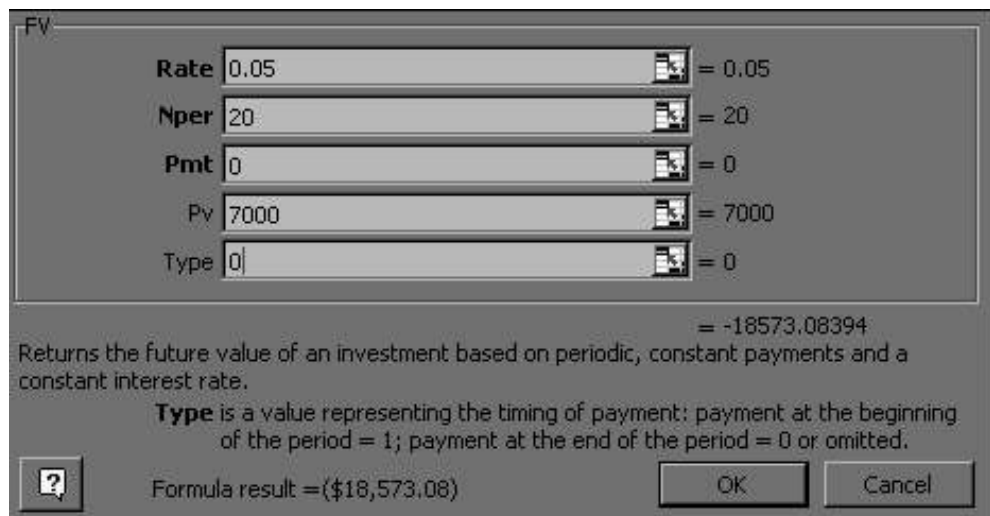

Future Value of an Annuity

Annuity is defined as periodic payment every period for a number of periods. This periodic payment is the same every year only then it could be called an annuity. The compound value (future value) of this annuity can be calculated using a different formula:

$$\text{Future Value} = A \left[\frac{[(1+i)^n - 1]}{i} \right]$$

Here A is the constant periodic cash flow (annuity), i is the rate of return for one period and n is the number of time periods. The term within the brackets is the compound value factor of an annuity. We can also use the tables given at the end of the text book to calculate the compound values of the cash flows and the formula would change to:

$$\text{Future Value} = \text{Annuity} * (\text{Future Value Annuity Factor}_{n,i})$$

Extending the same example we used above, if we were going to pay Rs 7000 every year for the next 20 years what is the value at the end of 20 years if the interest rate was 5 % compounded annually.

Example

An annual payment of Rs 7000 is invested at 5% per annum compounded annually. What will be the amount after 20 years?

Solution

Here $i = 0.05$, $P = 7000$, and $n = 20$. Putting it in the formula we get:

$$\text{Future Value} = 7000 \left[\frac{[(1+0.005)^{20} - 1]}{0.05} \right]$$

$$\text{FV} = 7000 \times 33.066 = \text{Rs } 2,31,462$$

We have taken a shortcut here. We looked at the future value of Rs 1 at the end of 20 years at 5% interest in the Future Value Annuity Factor Table given at the end of this book (i.e. find the value of Future Value Annuity Factor n,i) and found the figure to be 33.066 (try finding the figure yourself) and then substituted the figure here to get the answer. Another way of doing it would be to use a scientific calculator and calculate the value that comes out to be the same.

Let us see how we use Microsoft Excel to do the same. Insert the values as given in the example. Here $r = i = 0.05$, Nper is the number of periods = 20, Pmt is the periodic annuity = 7000. Pv is the present value = 0 in this case as it an annuity and Type is a value representing the timing of the payment = 0 in this case as the first investment is

done at the end of the period 1. Note that in the earlier case this also means that we get the returns at the end of the period 20 simultaneously when we make the last payment. Putting these values we get the following screen.

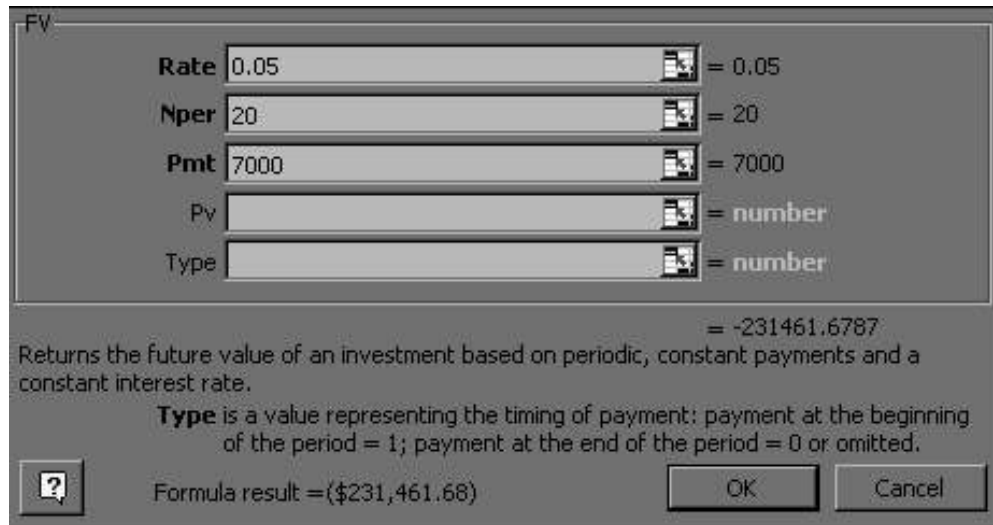

Can you find the answer? Yes, it is Rs 231,461.68 a difference of Rs 0.32 from the answer we got using the table above.

A variation on this would be that the payment made at the start of the period instead of the end of the period. This means that you earn extra interest for one year. The formula is slightly different in that the whole value is multiplied by (1+i) resulting in the following formula:

$$\text{Future Value} = A \left[\frac{[(1+i)^n - 1]}{i} \right] (1+i)$$

In the excel spreadsheet we just have to change the type to 1 to get the desired result.

The result now comes to Rs 243,034.76, which is nothing but the earlier figure of The result now comes to Rs 2,43,034.76, which is nothing but the earlier figure of Rs 2,31,461.68 multiplied by 1.05 (i.e. 1+i).

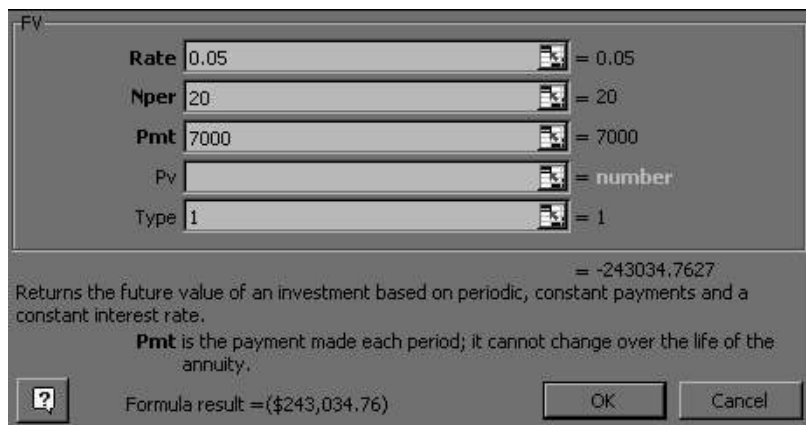

Still this leaves one problem unanswered: If the projects have different time spans (which could be as far apart as 50 years or more) how do we use the results that we get from here to compare. It becomes very difficult. Also we cannot be too sure of the discounting rates and cash flows so getting comparable values would be difficult to say the least. To solve this problem we solve for the present value.

Present Value

When we solve for the present value, instead of compounding the cash flows to the future, we discount the future cash flows to the present value to match with the investments that we are making today. Bringing the values to present serves two purposes:

1. The comparison between the projects become easier as the values of returns of both are as of today, and
2. We can compare the earnings from the future with the investment we are making today to get an idea of whether we are making any profit from the investment or not.

For calculating the present value we need two things, one, the discount rate (or the opportunity cost of capital) and two, the formula.

The present value of a lump sum is just the reverse of the formula of the compound value of the lump sum:

$$PresentValue = \frac{FutureValue}{(1+i)^n}$$

Or to use the tables the change would be:

$$Present\ Value = Future\ Value * (Present\ Value\ Interest\ Factor\ n,i)$$

where n = no of time periods and i is the interest rate.

Let us look at an example of how we calculate the future value:

Example

Rs.2,00,000 is the amount that you require after 20 years for your retirement. How much should you invest now at 5% per annum compounded annually?

Solution

Here $i = 0.05$, $FV = 2,00,000$, and $n = 20$. Putting it in the formula we get:

$$PresentValue = \frac{200000}{(1+0.05)^{20}}$$

Solve this or use the present value table.

Using the present value interest factor table we find that present value of Rs 1 of 20 years from now at 5% interest is 0.3769. Multiplying it with the future value Rs 2,00,000 we get:

$$PV = 2,00,000 \times 0.3769 = \text{Rs } 75,380$$

Let us see how we use Microsoft Excel to do the same.

Step 1: Go to the Insert menu and choose function. In the financial function category choose PV (it stands for Present Value) and press OK.

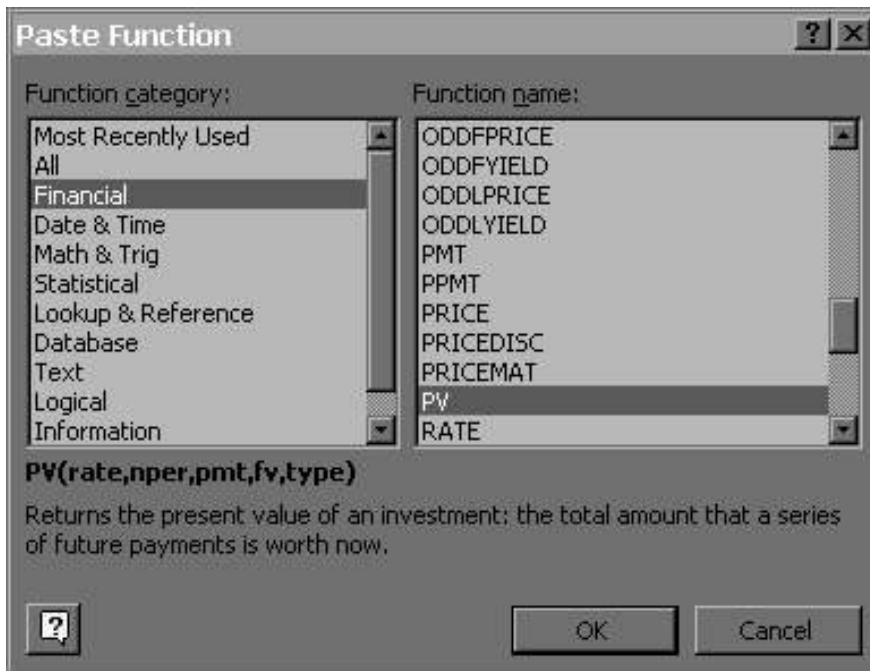

Step 3: You would get a seen that would look like this:

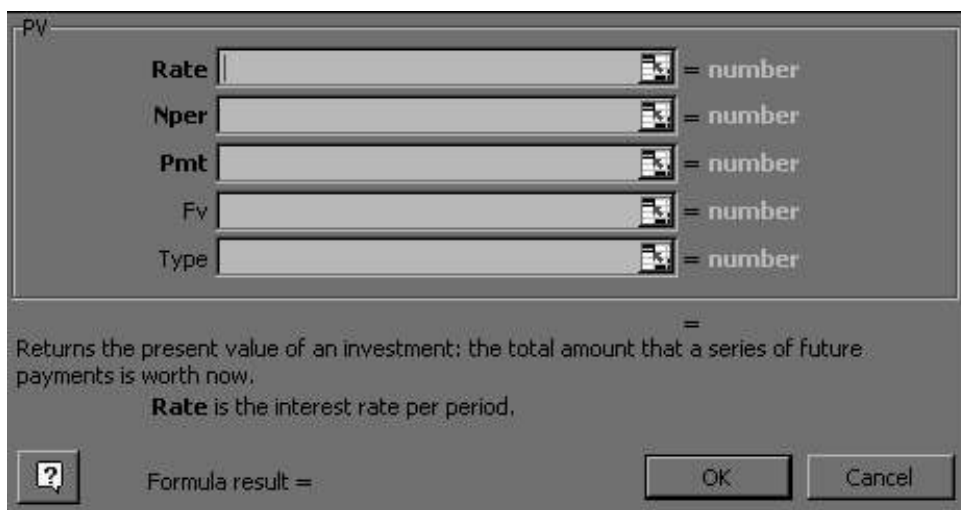

Step 4: Insert the values as given in the example. Here $r = I = 0.05$, N_{per} is the number of periods = 20, Pmt is the periodic annuity (how to use it we will see a little later) = 0 in this case as there is no annual payment except the first one. Fv is the future value = Rs 2,00,000 in this case and $Type$ is a value representing the timing of the payment = 0 in this case. Putting these values we get the following screen.

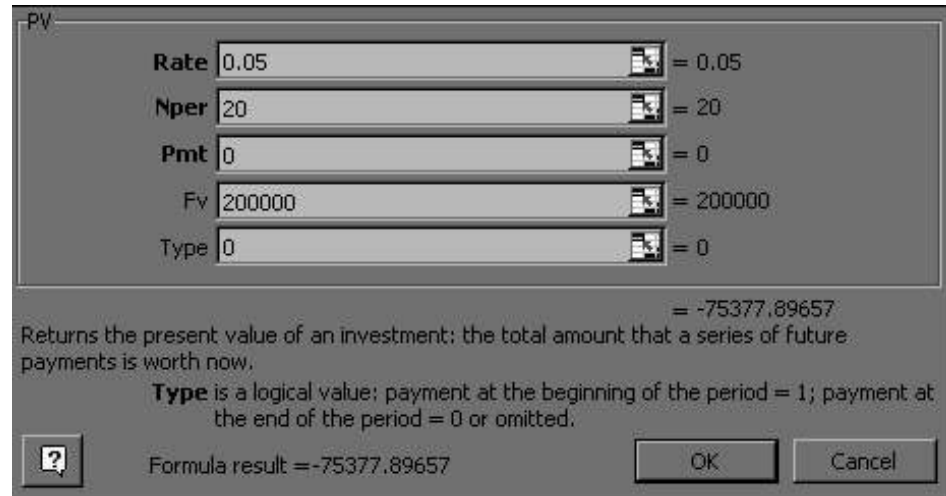

Note that the result of the figures that you input is shown in the formula result section where it is Rs 75,377.89. Compare this with the figure that you get from using the value from the table, a difference of Rs 2.11. Negligible, but still higher than the differences we used to get in the future value. Can you tell why? This is because of the fact that while dividing you require numbers more than four digits to get accuracy.

What if the money was payable at the start of the period rather than at the end of the period? Here it does not matter as there is only one future value and that is also at the start of the first period. It would matter when we look at the present value of the annuity.

Present Value of an Annuity

The present value of an annuity can be calculated by:

$$PresentValue = A \left[\frac{[(1+i)^n - 1]}{i(1+i)^n} \right]$$

Or to use the tables the change would be:

$$Present Value = Annuity * (Present Value Annuity Factor n,i)$$

Let us see an example

Example

You have been promised an annual grant of Rs 7000 every year for the next 20 years

If you can invest the amount at 5% per annum compounded annually what will be the amount you would require today to land up with the same position?

Solution

Here $i = 0.05$, $A = 7000$, and $n = 20$. Putting it in the formula we get:

Using the shortcut from the table we get:

$$Present\ Value = 7000 \left[\frac{(1 + 0.05)^{20} - 1}{0.05(1 + 0.05)^{20}} \right]$$

$$PV = 7000 \times 12.4622 = Rs\ 87,235.4$$

We looked at the present value of an annuity of Rs 1 for 20 years at 5% interest in the Present Value Annuity Factor Table given at the end of this book (i.e. find the value of Present Value Annuity Factor n,i) and found the figure to be 12.4622 (try finding the figure yourself) and then substituted the figure here to get the answer. Another way of doing it would be to use a scientific calculator and calculate the value that comes out to be the same.

Let us see how we use Microsoft Excel to do the same. Insert the values as given in the example. Here $r = i = 0.05$, Nper is the number of periods = 20, Pmt is the periodic annuity = 7000 in this case. Fv is the future value = 0 in this case as it is an annuity and Type is a value representing the timing of the payment = 0 in this case as the first investment is done at the end of the period 1. Putting these values we get the following screen.

Can you find the answer? Yes, it is Rs 87,235.47 a difference of Rs 0.07 from the answer we got using the table above.

A variation on this would be that the payment made at the start of the period instead of the end of the period. This means that you earn extra interest for one year. The formula is slightly different in that the whole value is multiplied by $(1+i)$ resulting in the following formula:

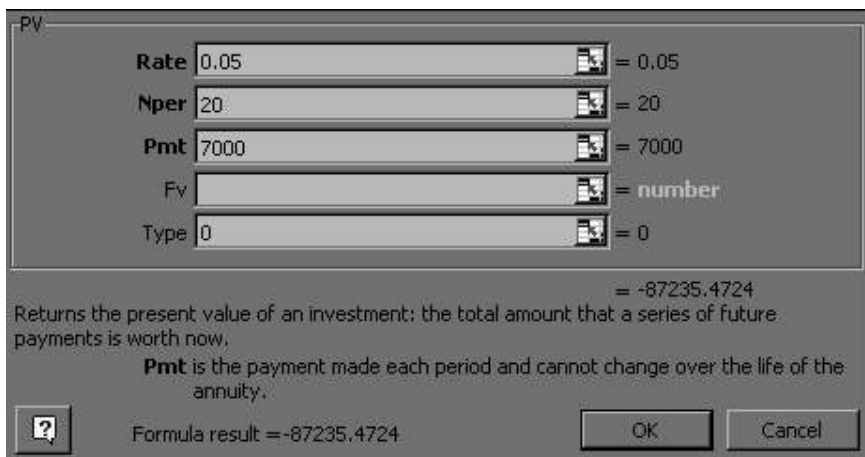

$$PresentValue = A \left[\frac{[(1+i)^n - 1]}{i(1+i)^n} \right] (1+i)$$

In the excel spreadsheet we just have to change the type to 1 to get the desired result.

The screenshot shows the Excel PV function dialog box. The fields are: Rate: 0.05, Nper: 20, Pmt: 7000, Fv: (blank), Type: 1. The formula result is -91597.24602. The dialog box also contains a help icon, an OK button, and a Cancel button. Below the fields, there is a description: "Returns the present value of an investment: the total amount that a series of future payments is worth now. Type is a logical value; payment at the beginning of the period = 1; payment at the end of the period = 0 or omitted."

The result now comes to Rs 91,597.25, which is nothing but the earlier figure of Rs 87,235.47 multiplied by 1.05 (i.e. 1+i).

Perpetuity

If the annuity is expected to go on forever then it is called a perpetuity and then the above formula reduces to:

$$PresentValue = \frac{A}{i}$$

Perpetuities are not very common in financial decision making as no project is expected to last forever but there could be a few instances where the returns are expected to be for a long indeterminable period. Especially when calculating the cost of equity perpetuity concept is very useful.

For a growing perpetuity the formula changes to:

$$PresentValue = \frac{A}{i - g}$$

All these calculations take into consideration that the cash flow is coming at the end of the period.

Valuing Securities

The objective of any investor is to maximise expected returns from his investments,

subject to various constraints, primarily risk. Return is the motivating force, inspiring the investor in the form of rewards, for undertaking the investment. The importance of returns in any investment decision can be traced to the following factors:

- It enables investors to compare alternative investments in terms of what they have to offer the investor.
- Measurement of past returns enables the investors to assess how well they have done.
- Measurement of historical returns also helps in estimation of future returns.

Why are we discussing the return so much? The value of the security to an investor is directly proportional to the return that he is expected to get from that security. Higher the return expected, higher is the value. But what are we going to do with the value of the security? Well, value of the security is the price that you are going to pay for that security. This means that the present value of the security is that value which is dependent on the return from the security and the risk profile of that security. Now let us go further on return.

The Components of Return

Return is basically made up of two components:

- The periodic cash receipts or income on the investment in the form of interest, dividends, etc. The term yield is often used in connection with the component of return. Yield refers to the income derived from a security in relation to its price, usually its purchase price.
- The appreciation (depreciation) in the price of the asset is referred to as capital gain (loss). This is the difference between the purchase price and the price at which the asset can be, or is, sold.

Measuring the Rate of Return

The rate of return is the total return the investor receives during the holding period (the period when the security is owned or held by the investor) stated as a %age of the purchase price of the investment at the beginning of the holding period. In other words it is the income from the security in the form of cash flows and the difference in price of the security between and the end of the holding period expressed as a %age of the purchase price of the security at the beginning of the holding period. Hence, total return can be defined as:

$$\text{Total Returns} = \frac{\text{Cash Payment received} + \text{Price change over the period}}{\text{Purchase price of the asset}}$$

The price change over the period, is the difference between the beginning (or purchase) price and the ending (or sales) price. This can be either positive (sales price exceeds purchase price) or negative (purchase price exceeds sales price).

The general equation for calculating the rate of return for one year is shown below:

$$K = \frac{[D_t + (P_t - P_{t-1})]}{P_{t-1}}$$

where K = Rate of Return

P_t = Price of the security at time "t" i.e. at the end of the holding period.

P_{t-1} = Price of the security at time "t-1" i.e. at the beginning of the holding period or purchase price.

D_t = Income or cash flows receivable from the security at time "t".

Valuing Debt Securities

Securities that promise to pay its investors a stated rate of interest and return the principal amount at the maturity date are known as debt securities. The maturity period is typically more than one year which is the key differentiating factor between them and the money market securities. Debt securities are usually secured. Debt securities differ according to their provisions for payment of interest and principal, assets pledged as a security and other technical aspects. In the case of bankruptcy of the corporation, the law requires that the debt holders should be paid off before the equity investors.

A legal agreement, called a trust deed, is drawn between the security holders and the company issuing the debt securities. Every security issued under it has the same right and protection. Trust deed is a complicated legal document containing restrictions on the company, pledges made by the company, and several other details. The trustee, usually a large bank or a financial institution, ensures that the issuing corporation keeps its promises and obeys the restrictions of the contract. The trustee is the watchdog for the debt securities holders because it is impossible for the individual holders to keep an eye on the functioning of the company.

Debt securities are different from term loans provided by the financial institutions and the banks to the company. Term loans are long term debt contracts under which a borrower agrees to make a series of interest and principal payments on specific dates to the lender. While this is true for debt securities also, term loans differ in one significant aspect that they are generally sold to one (or few) lenders especially financial institutions and banks, while debt securities (terms 'debentures' and 'bonds' will be used interchangeably for debt securities) are typically offered to the public. Another significant difference is that principal repayments in term loans are made along with the interest

payments but in debt securities it is usually a lump sum payment at the end of the period (or a series of payments).

Terms Associated with Debt Securities

There are several terms which are used when we talk about debt securities. Before we take a look at different kinds of debt securities available in the Indian market, let us first understand these terms.

Face Value/ Par Value

Value of the security as mentioned on the certificate of the security. Face values and par values are two terms which are used interchangeably. Corporate debentures are usually issued with Rs.100 face values and Government bonds with Rs.1 lac face values. Although the value of the debenture (or the Government bond) will fluctuate in price from the time they are issued until redemption, they are usually redeemed at maturity at their face value (unless a premium is to be given on redemption).

The face value is the amount on which the interest is calculated. Thus, a 15 per cent debenture with a face value of Rs.100 will pay debenture holders Rs.15 per debenture per year.

Coupon Rate

The coupon rate is the stipulated interest rate to be paid on the face value of a bond. It represents a fixed rupee amount that is paid periodically as long as the debtor is solvent. The period could be monthly, quarterly, semi-annually or annually. Zero-coupon bonds (discussed later) are also common. The coupon rate could be a fixed rate or a floating rate. The floating rate is normally pegged to a base rate (e.g. 1 per cent above bank rate) and fluctuates with the fluctuation in the base rate. The coupon rate is fixed after the issuing corporation's merchant banker has weighed the risk of default, the credit rating of the issuer, options attached with the issue, the investment position of the industry, the security backing of the debenture, and the appropriate market rate of interest for the firm's industry, size, and risk class. The goal is to pick a coupon rate that is just high enough to attract investors.

Interest payments

Debenture interest is usually paid semi-annually, though annual payments are not uncommon. In India we normally have registered debentures on which the interest is payable to the debenture holder whose name appears on the register when the payment is made. In developed countries, coupon bonds are also available which have a series of attached coupons that are clipped off at the appropriate times and sent to a bank for collection of the interest. Of course, now with the Electronic Clearing System, the interest can be directly deposited in the bank account of the bond holder.

Maturities

Debentures are sometimes grouped by the length of time until maturity that existed on the date the debenture was first issued. Money Market Securities mature in 364 days or less. Short-term debentures are those maturing within 1 to 3 years. Medium term debentures mature between 5 to 8 years and long term debentures are the ones who have a maturity life of 10 years or more.

Redemption

Redemption is the repayment of the debt security at or before maturity. Redemption could be at par or at a premium to face value. A debt security will be redeemed before maturity if the issuer feels that he can borrow the same amount at a lower rate of interest or he does not require the funds any longer. If there is a premature redemption (redemption before the maturity date), a premium is usually paid to the debenture holders.

Call/ Put Options Provision

A call/ put option provision allows both the issuing company and the investor to redeem the bonds at a specified amount before the maturity date. Long term bonds (10 years or more) usually have a call/ put option attached to the bond which is (usually) exercisable after every 5 year intervals. In this case the issuing company has a call option that it can call back the bonds and repay to the investors the principal and interest due till that date. If the issuer exercises his call option the investor has no recourse but to submit his bonds and get the money. Similarly the investor has a put option, in which case he has an option to return the bonds and get the principal and interest till that date. As in earlier case if the investor exercises his option, the company has no recourse but to pay the investor.

Issuing corporation will use the provision if the interest rates fall substantially below the coupon rates offered on the security and the investor will use the put option if he can get better returns elsewhere.

For bonds with call/ put options the yields are calculated to the nearest year at which the call/ put option is exercisable. This yield is known as yield to call (YTC) which is different from the yield to maturity (YTM).

Sinking Fund

A provision that requires the corporation to set aside a fixed amount each year to help provide for the orderly repayment of the debt issue.

Credit Rating

It is mandatory for the issuing companies to get the credit rating done on debt securities issues. Credit ratings are also mandatory for Commercial Paper and Fixed Deposits issues of the companies. Ratings reflect the probability of the companies going into default. The higher the rating, the lower the risk of default that is associated with the

issue. This also has an effect on the rate of interest offered on the issue. The methodology and the rating symbols remain the same as in money market securities.

Types of Debt Securities

There are several types of debt securities available in the market. The range includes Government Securities, debentures, deep discount bonds, zero coupon bonds, etc.

Government Securities

Government is one of the biggest borrowers from the capital and the money market. We have already taken a look at the money market securities offered by the Government as also the schemes run by it through the post office. Government Securities is the generic term applied to various kinds of debentures and bonds offered by the Government (centre or state) and quasi-governmental agencies.

The maturities of the Government securities range between 1-20 years and the return on the securities range between 5 to 7 per cent. The rates have significantly come down from the high yields of 14 per cent registered in 1996. Most of the Government Securities are bought by the banks, financial institutions, provident fund trusts, insurance companies.

There are two types of Government Securities that are offered:

Government of India Floating Rate Bonds Bonds which pay a floating rate depending upon the base rate announced by the RBI.

Government Securities Regular debentures which pay a fixed rate of return and the principal amount is returned on maturity. The last issue of government stock paid a coupon rate of 6.50 per cent.

The present yield on Government Securities is in the range of 5.50 - 7.00 per cent depending on the maturity.

Non-Convertible Debentures (NCDs)

NCDs are plain debenture securities issued by corporations. They are normally medium term in nature, maturing between 1 to 8 years and generally have a repayment schedule staggered over two to three years. They are secured by a collateral backing and credit rated. Interest rate offered on medium term NCDs is usually lower than the market rate so many times the companies offer a sop of equity warrants along with NCDs to sweeten the issue. Interest rate on the short term NCDs is in line with the market rate and depends upon the quality of the issuer.

Deep Discount Bond (DDB)

Usually long term with maturities exceeding 10 years, deep discount bonds are normally issued by blue chip corporations or financial institutions. Like money market securities, these bonds are issued at a discount to their face values. Because of long maturity

periods the discount is also higher, hence the term deep discount. Although long term maturity is the norm, short maturities are not uncommon, for example GE Capital had an issue of DDBs with a maturity period of 17 months and 29 days.

The first issue of DDBs was made by Small Industries Development Bank of India (SIDBI). Each DDB, with a face value of Rs.1,00,000, was issued at a discounted price of Rs.2,500 with a maturity period of 25 years from the date of allotment. Both the investors and SIDBI have an option of withdrawing or redeeming the bond (call & put options) respectively at the end of 5th, 9th, 12th, 15th, or 20th year from the date of allotment at the deemed value of Rs.5,300, Rs.9,600, Rs.15,300, Rs.25,000 and Rs.50,000 respectively.

After the success of the SIDBI issue, all the prominent financial institutions like IDBI, ICICI, etc. came out with the issues of DDBs. All these issues, however, were called by the institutions as the interest rates fell.

Zero Interest Bonds (ZIBs)

Very much alike DDBs, the only crucial difference is that these are issued at face values (DDBs are issued at a discount to face value) and the redemption is at a premium. Tax treatment of both is the same.

Secured Premium Notes (SPNs)

SPNs are bonds issued by corporations which are medium term in nature, maturing between 3 to 8 years. The advantage is the flexibility it offers in giving the returns as premium or interest payments depend upon the preferences of the holders.

The only issuer of SPNs in the Indian markets till now is TISCO Ltd. It issued SPNs of Rs.300 each. The repayment started after three years, and there was no payment of interest in between. The repayment went on for four years starting from the fourth year to seventh year. Every year there will be a payment of Rs.150 (totalling $Rs.150 \times 4 = Rs.600$ in four years). Rs.75 in this would be accounted for as principal repayment and the rest Rs.75 could be taken as a mixture of interest and premium at the option of the investor. (Rs.25 as interest + Rs.50 as premium; Rs.37.50 interest + Rs.37.50 premium; Rs.50 interest + Rs.25 premium).

The advantage of this was easier tax planning for the investor, but the tax authorities were not happy with this kind of an arrangement. TISCO also attached an equity warrant which was convertible into equity at a price which was at considerable discount to the market price prevailing at that time.

Floating Rate Bonds (FRBs)

Bonds whose interest payments fluctuate with changes in the general level of interest rates and are tied to a basic rate (known as the reference rate). The first issue in India

was from State Bank of India (SBI). It issued unsecured, redeemable, subordinated, floating interest rate bonds in the nature of promissory notes carrying a coupon rate of 3 per cent per annum above the bank's maximum term deposit rate.

Pass Through Certificates (PTCs)

Pass Through Certificates (PTCs) are debt securities that pass through income from debtors through intermediaries to investors. Primarily banks who have a strong retail loan portfolio are the intermediaries who issue these certificates. The most common form of pass through is mortgage backed security, in which the principal and interest payment from the home loan (or car loan) takers are passed from the banks or savings agencies that pool and repackage them in the form of securities, to investors. The bank that collects the payments from debtors charges a fee for its services, which is deducted from the income passed on to investors. These securities are credit rated and the interest payment is according to the rating. The rating (i.e. P1+) is followed by (So) to denote the transaction is that of securitization.

Rate of return of a Bond

In case of bonds, instead of dividends, the investor is entitled to payments of interest annually or semi-annually. The investor also benefits if there is an appreciation in the value of bond, otherwise there is the redemption of the bond at par value or at premium.

Using the present value formula developed above we can say that:

$$\text{Present Value of a Bond} = \sum_{t=1}^n \frac{\text{Interest Amount}}{(1+i)^t} + \frac{\text{Principal Amount}}{(1+i)^n}$$

Here interest amount is individually brought to its present value or we can apply the annuity factor table to get its present value. The principal amount is brought to its present value when it is due.

Or to use the tables the change would be:

$$\text{Present Value} = \text{Interest Amount} * (\text{Present Value Annuity Factor}_{n,i}) + \text{Principal Amount} * (\text{Present Value Interest Factor}_{n,i})$$

Example

A bond is paying 10 % interest per annum and is going to mature in the next two years. At maturity it will pay its principal amount of Rs 100. If the expected return on bonds today are (i) 7 %, (ii) 10 % and (iii) 15 %, what value would you pay for the bond today.

Solution

Using the above formula for situation 2), we can say that

$$\text{Present Value of a Bond} = \sum_{t=1}^2 \frac{\text{Interest Amount}}{(1.1)^t} + \frac{\text{Principal Amount}}{(1.1)^2}$$

$$\text{Present Value of a Bond} = \frac{10}{(1.1)^1} + \frac{10}{(1.1)^2} + \frac{100}{(1.1)^2}$$

Or to use the tables the change would be:

$$\begin{aligned} \text{Present Value} &= 10 * (\text{PVAF2}, 0.1) \\ &+ 100 * (\text{PVIF2}, 0.1) \end{aligned}$$

Substituting the values we find that

$$\text{Present Value} = 100$$

This is no magic. When you are getting a 10 % return and also expect a 10 % return, the price you would pay would equal the par value of the bond. This means that if we expect higher return i.e. 15% in situation (iii) above, the price that we would be willing to pay for a bond returning only 10 % would be less than the par value. Similarly, if we expect lower return, i.e., 7% in situation (i) above, the price that we would be willing to pay for a bond returning 10 % would be higher than the par value. Can you find out the values for these two cases?

There are five variables in this case: (1) present value, (2) future value, (3) interest amount paid, (4) return expected and (5) time period. Properties of mathematics say that if any four of these five variables are given, you can always find the value of the fifth variable. You can attempt that yourself or turn over to solved examples to look at a similar case.

Valuing Equity Securities

Unlike debt and money market instruments, equity instruments represent the ownership interest in the company. As owners must put in their money in the venture before anybody would lend to them, equity is always issued before debt is released by the institutions. In fact the incorporation of the company requires that the promoters must pick up some shares in the company, only then the company can be incorporated. As equity represents the owners it is but logical that all the debt holders must be paid off before owners can claim any returns from the company. So the equity has the lowest-priority claim on earnings. Equity also has the last claim on the assets in case the company is liquidated (closed down).

This means that the equity carries the highest risk. Not without reason. The flip side of the coin is that the equity owners are also the owners of all the profits that remain after all the debt holders are paid their interest. The interest payment is fixed while there is no limit on the levels of profits that can accrue to the equity holders. Vice Versa does not apply here, the liability of the equity holders is limited to the level of investments that

they have put in into the company and not unlimited.

Unlimited profit sharing means that equity shares have an unlimited potential for dividend payments and price appreciation. Which is why investing in equity is so exciting and full of opportunities. At the same time the risk is also high because there is nothing fixed about earnings which can fluctuate widely depending upon the business environment. This is also the reason why this book will devote much more time to equity than on debt.

Shareholders, being the owners of the company, elect the board of directors and vote on major issues that affect the functioning and long term plans of the company. Major shareholders take up seats on the board of directors and influence the decisions that are taken. Small shareholders cannot exercise the same level of control so when they do not like the way the company is being run they simply sell their shares and invest their money somewhere else.

A shareholder, by virtue of being an owner, is normally entitled to four basic rights of ownership:

1. claim on a share of the company's undivided assets in proportion to number of shares held (this is not to say that he can return the shares and get a part of the assets, he will not get it),
2. proportionate voting power in the election of Directors and other business conducted at annual general meeting which can be exercised either by attending of the meeting or by Proxy,
3. dividends, when earned and declared by the Board of Directors, as also a proportionate share in the residual earnings which the company retains, and
4. pre-emptive right to subscribe to additional share offerings before they are offered to general investors unless a special resolution has been passed in the annual general meeting to the contrary.

The piece of paper which testifies the ownership position of the shareholder in a company is called a share certificate. The number of shares, their par value, the certificate number, distinctive numbers, the date of issue and the owner's name are mentioned on the share certificate.

Terms Associated with Equity Securities

Let us look at some of key terms that are associated with equity shares:

Stock

Ownership of a company represented by shares that are a claim on the company's earnings and assets.

Share

Unit of equity ownership in a company or in a mutual fund. This ownership is represented by a share certificate, which names the company and the shareholder.

Face Value/ Par Value

The value of one share as given on the share certificate of the company. The face value today can be either Rs.10 or below that number (but in multiples of Rs. 1) as specified by the Securities Law governing public limited companies. You will find many companies with a face value of less than Rs. 10, for example Rs. 5 (E.g Infosys Technologies, Maruti Udyog), Rs. 4 (iGate Global Solutions), Rs.2 (Satyam Computers) and even Rs.1 (e.g. Tata Consultancy Services, Hindustan Lever). Earlier Rs 100 and Rs 50 were the typical face values and you will still find shares with these face values, e.g. Dawn Mills has Rs 50 face value and Shri Dinesh Mills has Rs 100 face value per share.

The face value is the amount on which the dividend is calculated. Thus, a 15 per cent dividend on a share with a face value of Rs.10 will pay the share holder Rs.1.5 per share. This means that any dividend percentage has different meaning in Rupee terms as the face value changes. For example 100% dividend on 1 share of Rs 100 face value will get you Rs 100 but the same dividend percentage on 1 share of Rs 1 face value would get you only Rs 1.

Authorised and Paid-up Share Capital

Number of shares of stock provided for in the Articles of Association of a company is the authorized share capital. This figure is usually indicated in the Share Capital section of the Balance Sheet.

Paid-up share capital is the capital that has been issued and subscribed by the shareholders. Authorised capital is usually well in excess of the paid-up capital and a company cannot legally issue more shares than authorized. The number of authorized shares can be changed only by amendment to the Articles of Association for which a special resolution needs to be passed in the Annual General Meeting.

Figure 2.1 shows the Schedule 'A' of the Cosco India balance sheet, which gives us details on the authorized and paid-up capital of the company.

	As at 31* March, 99	As at 31* March, 98
Authorised:		
100,00,000 Equity Shares of Rs. 10/- each	1,00,000,000	1,00,000,000
Issued & Subscribed:		
41,61,000 Equity Shares of Rs. 10/- each (includes 19,20,000 Equity Shares allotted as fully paid up Bonus Shares by Capitalisation of Rs. 192 Lacs from General Reserve)	41,610,000	41,610,000



The second part in the figure talks about 'Issued & Subscribed Capital'. Issued Share Capital is that portion of the authorised capital that has been actually offered for subscription. Subscribed share capital is that portion of issued share capital, which has actually been subscribed and allotted. Paid-up share capital is that part of the subscribed capital for which consideration in cash or otherwise has been received. Therefore, subscribed share capital can be less than or equal to the issued share capital. Similarly paid-up share capital can be less than or equal to subscribed share capital. All these types of share capital also include the bonus shares that have been allotted by the organisation.

There is another term 'called-up share capital' which you may find in some of the balance sheets. It refers to that part of the subscribed capital, which shareholders have been required or demanded to pay but have not paid as yet. This comes in the case where the company has issued partly paid up shares and some shareholders have not paid the entire amount to make the shares fully paid up.

Book Value

The book value is calculated by adding reserves to the equity capital of the company, multiplied by the face value and divided by the equity capital of the company. Book value tells us how much each share is worth in the books of the company. So if a company has a face value of Rs.10, equity capital of Rs.10 crores and reserves of Rs.20 crores, then the book value of each Rs.10 share will be:

$$\text{Book Value} = \frac{(Rs.10cr + Rs.20cr)}{Rs.10cr} \times Rs.10 = Rs.30$$

The true worth of the share could be very different from the book value so calculated even when we are not taking the market price into consideration. Why this is so we will see later. Book and market values will usually be equal on the day the shares in a new corporation are issued, but after that only coincidence will ever make them equal at any given moment.

Earnings Per Share (EPS)

EPS can be defined as the company's profit allocated to each outstanding equity share. For instance, a company that earned Rs.10 crore last year and has 1 crore shares outstanding (with a face value of Rs.10 each) will report a EPS of

$$\text{EPS} = \frac{Rs.10cr}{1cr} = Rs.10$$

The profits that are used to calculate EPS are the profits that are left after paying interest to debt holders, taxes and dividend on preference shares. EPS is considered to be a key figure (and also misleading) in evaluating a share's outlook.

Stock Price Quotations

If you pick up any of the major newspapers (financial or non financial), they carry at least some of the quotations of the last day's trading on the major stock exchanges, be it National Stock Exchange (NSE), Bombay Stock Exchange (BSE), or any other stock exchange.

The usual format in a financial newspaper is to carry four prices (open, high, low, close) along with volumes of shares traded and number of trades. Price/ Earning Ratio (P/E) and market capitalization is also carried. They also carry the closing share price of the previous trading day in a bracket before starting with yesterday's prices as also carry the previous 52 week (one year) high/low prices for that share. The prices mentioned are for one share of the company.

Figure 2.2 shows two samples taken from the Business Standard and The Economic Times. See the reporting differences. The Business Standard carries more information on top 200 companies and different information is carried every day of the week.

Types of Equity Instruments

There are basically two types of equity instruments: equity shares and preference shares.

What we have been discussing till now in equity instruments applies as it is to equity shares. Preference shares are different.

Preference Shares

Sandwiched between debt holders and equity share holders, preference share holders have the promise of an assured dividend from the company and therefore assume less risk than that borne by equity share holders. They do not have any voting rights in the company. When a company fails to pay the dividend to them for two years in a row, then these shares get a voting right.

The preference shares are issued by only those companies who are paying a very low level of tax. Why? This is because although the returns desired by the preference share holders is at par with the returns offered by the fixed deposits, the cost to the company is after tax in case of preference shares while the interest paid on fixed deposits is tax deductible.

So a company which is paying 10 per cent dividend on preference shares ends up paying 11 per cent (including 10 per cent dividend tax). If the company pays no income tax [as in the case of a 100 per cent Export Oriented Unit (EOU)] then this is the cost to the company. If the company pays tax at the rate of 35 per cent then the before tax cost shoots above 14 per cent. Compared with a debt cost of 7 to 12 per cent for established companies, it is not a viable alternative at all to go in for preference shares if the tax liabilities are high. Therefore, preference shares would only be issued if the company requires a more permanent source of capital.

For the investor the biggest benefit of investing in a preference share is that the dividends are tax free in their hands. Which means if you are getting a dividend of 10 per cent from a preference share and you are in 30 per cent tax bracket, your net return is still 10 per cent which is equivalent to receiving an interest income of 13 per cent from fixed deposits or any other interest bearing source.

American / Global Depository Receipts (ADRs/ GDRs)

Equity shares that are offered in the international markets to international investors are issued in the form of Depository Receipts (DRs). If these DRs are issued for US investors in the US markets, then they are known as American Depository Receipts (ADRs). They can be listed on New York Stock Exchange (NYSE) or National Association of Securities Dealers Automated Quotations (NASDAQ) Exchange. If they are issued for international investors to be listed on Luxemborg Stock Exchange in Europe then they are called Global Depository Receipts (GDRs). What goes in the hands of the investors is not a share certificate but a 'receipt' of a share certificate which is lying with the depository. The benefits of keeping the shares in the depository include: ease of transfer, no bad deliveries, less registrar & book keeping problems, etc. DRs entitle the holders to get both dividend and capital gains. ADRs/ GDRs can be converted into equity shares any time as they represent equity shares anyway and the reverse conversion of equity shares into ADRs/ GDRs is allowed to the extent of the first conversion.

ADRs/ GDRs give an opportunity to foreign investors to buy the equity shares in Indian companies with the added benefits of trading in their own exchanges and without registering in India for buying and selling securities.

Equity and Debt: A Comparison

1. Equity shares do not carry any fixed charges on them. If the company does not generate positive earnings, it does not have to pay equity shares any dividends. This is very much in contrast to interest on debt, which must be paid regardless of the level of earnings.
2. Equity shares have no maturity date - it is permanent capital that does not have to be "paid back". While debt has a fixed maturity date and the debt taken has to be paid pack on that date.
3. Equity shares can, at times, be easier to sell than debt. It appeals to many investor groups because (1) equity shares typically carry a higher expected return than does preference shares or debentures, (2) equity shares provide investors with a better hedge against inflation than debentures, and (3) returns from capital gains on equity shares are not taxed until the gains are realised whereas the interest income on debentures is taxed regularly.
4. The sale of new equity shares gives voting rights, or even control if the stake is high enough, to the additional new share owners who are brought into the company.

While the debt and preference share owners do not have any voting rights (except in special conditions). For this reason, debt is preferred over additional equity financing. Equity financing is often avoided by small companies, whose owner managers are not willing to share control.

5. The use of debt enables the firm to acquire funds at a fixed cost, whereas the use of equity shares means that more shareholders will share in the firm's net profits.
6. The costs of underwriting and selling equity shares are usually higher than the costs of underwriting and selling preferred shares or debt, which puts additional burden on the companies raising resources. But the life and permanency of the equity shares more than compensates for the additional expenses in initial floatation.

Share Capital

Figure 2.2 shows the Schedule 'A' of the Cosco India balance sheet.

	As at 31* March, 99	As at 31* March, 98
Authorised:		
100,00,000 Equity Shares of Rs. 10/- each	1,00,000,000	1,00,000,000
Issued & Subscribed:		
41,61,000 Equity Shares of Rs. 10/- each (includes 19,20,000 Equity Shares allotted as fully paid up Bonus Shares by Capitalisation of Rs. 192 Lacs from General Reserve)	41,610,000	41,610,000



The first heading is 'Authorised', which means authorised share capital. Authorised share capital is the total amount of shares that a company is authorised to sell. 'Memorandum and Articles of Association' of the company provides the information about the number of shares that the company is authorised to sell and their par value. Par Value is the value per share established at the time of authorisation. Par value of the share establishes the minimum legal capital for the company and the shareholder must invest assets equal to that amount (whether in cash or by transferring the assets to the company). Par value multiplied by the number of authorised shares form the authorised capital.

Cosco India Ltd is authorised to sell 10,000,000 equity shares (10 million or 1 crore shares) of Rs 10 each. Here the par value is Rs 10 per share and the total number of shares that the company can sell is 1 crore. Therefore the total authorised capital is Rs 10 crore.

The authorised capital is not fixed forever and can be changed depending upon the requirements. To change the authorised capital, first the company has to take permission

from the shareholders by passing a resolution in the annual general meeting to modify the authorised capital figure in the 'Memorandum and Articles of Association' of the company. This change is then notified to the 'Registrar of Companies' (Government) and then incorporated in the balance sheet.

No formal entry is required for authorised share capital in the books of accounts. Can you explain why? This is because of the reason that there is no transaction of the authorised share capital.

The second part talks about 'Issued, Subscribed and Paid-up Capital'. Issued Share Capital is that portion of the authorised capital that has been actually offered for subscription. Subscribed share capital is that portion of issued share capital, which has actually been subscribed and allotted. Paid-up share capital is that part of the subscribed capital for which consideration in cash or otherwise has been received. Therefore, subscribed share capital can be less than or equal to the issued share capital. Similarly paid-up share capital can be less than or equal to subscribed share capital. All these types of share capital also include the bonus shares that have been allotted by the organisation.

There is another term 'called-up share capital' which you may find in some of the balance sheets. It refers to that part of the subscribed capital, which shareholders have been required or demanded to pay but have not paid as yet. This comes in the case where the company has issued partly paid up shares and some shareholders have not paid the entire amount to make the shares fully paid up.

As you can see in the figure 5.4, Cosco has an 'Issued and Subscribed' share capital of 41,60,000 shares of Rs 10/- each amounting to Rs 41,610,000. The figure was the same last year meaning that the company has not issued any new shares in the last one year. In brackets it also says that the figure includes 19,20,000 equity shares allotted as fully paid up bonus shares by capitalisation of Rs 192 lacs from General Reserve. This means that Rs 192 lacs have been transferred from general reserves to the share capital. As both of them belong to the shareholders, it is merely a book entry and does not represent a flow of cash.

As Cosco India Ltd is a listed company, this means that the company would have issued shares to the public. The issue of new shares can be in five different ways:

1. It can sell shares directly to the public.
2. It can sell shares directly to selected investors.
3. It can sell shares only to its existing shareholders.
4. It can issue shares without any consideration to existing shareholders.
5. It can issue shares as exchange for assets from other entities.

The first four would result in money or assets flowing in and the last one would result in no additional asset as it is merely a book entry.

Selling Shares Directly to Public: Public Issue

Selling shares directly to the public is known as 'public issue'. You would have seen companies issuing advertisements for sale of its equity shares in the newspapers and other media targeted at potential buyers. The company has to get its issue managed by a merchant banker (finance intermediaries specialising in raising money for the companies). Certain norms specified by the Securities and Exchange Board of India (SEBI) apply to the companies who want to raise money from the public. Additionally there is a 'listing agreement' (specified by the stock exchanges where the company wants to list its shares for trading), which the company has to adhere to. Cosco India Ltd is listed on Bombay Stock Exchange and Delhi Stock Exchange, which means that it would have signed the listing agreement with both the stock exchanges separately. Both the listing agreements would nearly be the same with very minor differences.

Can you look at the newspapers and find out what is the rate that one share of Cosco is quoting at on these stock exchanges? This rate is known as the market price of the share. Market price of the share is influenced by a variety of factors, including expected future earnings, dividends, growth and other company specific and economic events. Market value of frequently traded shares are reported daily in newspapers such as The Business Standard, The Times of India, etc. and are available on the internet. Can you locate two web sites that give you the latest price information on Indian listed companies?

Selling Shares Directly to Select Investors: Private Placement

Selling shares directly to selected investors is known as 'private placement'. For making private placements the companies do not issue advertisements in the newspapers but offer shares directly to selected institutional investors like mutual funds and foreign institutional investors, etc. There is no obligation for the company to get its issue managed by a merchant banker but many of them employ financial intermediaries to help them sell the issue. Certain norms specified by the Securities and Exchange Board of India (SEBI) apply to the companies who want to raise money this way so as to protect the rights of existing shareholders. For example, the companies cannot issue shares below the average market price of the last six months. Of course, these guidelines apply to only those companies, which are listed on the stock exchange. Closely held companies can sell new shares to whomsoever they want and at whatever price per share that is mutually acceptable to the company and the buyers. However, this price cannot be less than the par value of the share.

Selling Shares only to existing Shareholders: Right Issue

The main difference between a public issue and a rights issue is that the rights issue is

only meant for the existing shareholders of the company. This means that the general public cannot subscribe to the issue. The right issue is made to shareholders in a ratio of their existing holdings. This means that if the shareholder holds 100 shares and the company want to offer right shares in the ratio of 1:1, the shareholder will get a right to subscribe to 100 shares. The shareholder can waive his right to subscribe to these shares and can pass it on or sell it to any other person who is interested in buying it.

Issuing shares without any consideration to existing shareholders: Bonus Issue

The first three types discussed issues that raise money. A company can also issue new shares without any consideration to its existing shareholders. This type of an issue is called 'bonus issue.' As in the rights issue, the company offers additional shares to its existing shareholders in a particular ratio of their existing shareholding. How can it do that when the company has a value attached to each share? The company transfer the money from reserves & surplus (a part of shareholder's money) to share capital, in other words, simply a book entry where the total funds available to the company does not change. The money for the bonus issue of shares comes from 'Reserves & Surplus', which means that the total shareholders funds remain constant.

Issuing shares as exchange for assets from other entities

When a company takes over the assets of another company or merges that company with it, it usually issues shares instead of paying the other company or its shareholders. The consideration paid for acquisition is usually more than the book value of the assets transferred (Can you explain why?). It could be due to the fact the goodwill of the assets of the company is also transferred or it could be because of the fact that the assets are in working condition and add significantly add to the value of the company. There are several methods of valuation of the future benefits that accrue from the assets, but these are outside of the purview of this book. These methods are discussed in detail in any good valuation book.

Issuing Shares at Par or at Premium

The consideration that the company gets by selling its shares does not necessarily have to be the face value (par value) per share. The company can issue shares 'at par' or 'at premium'. At par means that the company will charge only the par value for every share issued. This means that if Cosco issues shares at par, what will be the amount it will get per share? (Ans: Rs 10). At premium means that the company can charge an amount per share which is more than the par value per share. This additional amount is called the share premium and is shown as a separate head in the 'Reserves & Surplus' category.

Reserves & Surplus

General Reserves is the name given to the aggregate amount of corporate earning that has been reinvested in the business. There is another reserve called share premium reserve, which represents the premium charged when the company issued shares. The third is the surplus that comes from the profit and loss account. All these together constitute 'Reserves and Surplus'. The reserve and surplus as a whole increases each year by the net income that is retained in the company and decreases by losses.

You should note that the reserves and surplus does not mean cash. In fact, the company can have large reserves and surplus position and be without cash or it can have a lot of cash and a very small reserves and surplus balance. Although both cash and reserves & surplus usually increase when a company earns, the amount by which each one increases is usually different. Two reasons can be attributed for this difference.

1. The net profit of the company is calculated on accrual basis and not on a cash basis. Therefore, reserves & surplus would show increase on an accrual basis as against cash, which will only show increase if there is real inflow of cash.
2. The cash generated from the net profit can be invested in assets, can be used to pay off loans or spend in any number of ways, both of which would not affect net income or reserves and surplus. For example, if a Managing Director buys a Mercedes car for himself on company's account, he is basically making an expense that would not be reflected in the net income or reserves and surplus but would be reflected in the cash position of the company.

To summarise cash is an asset and retained earning is one of the sources of financing (along with share issues and loans) that a company can use for its business purposes.

In the figure 2.3 below, you can see the reserves and surplus figures of Cosco.



There are three items that you can notice in the figure. Let us discuss each one of them one by one. The share premium account shows a balance of Rs 31,230,000 which is unchanged from the last year closing balance. This means that company did not issue

any new shares in the last one year. It also means that the company would have issued shares at a premium somewhere in the past. When these shares were issued cannot be interpreted from the information given and no other information on that is available in this annual report. Searching information from other resources, we come to know that a company had issued shares at a premium of Rs 30 per share. Can you calculate, how many new shares has the company issued? Simple calculations would tell you that the company issued 1,041,000 shares (31,230,000 divided by 30).

Coming to the second item, we see the general reserve has an addition of Rs.7,921,724 in the last year's figure to bring the total to Rs.72,699,057. Now this addition has come again from the same head appropriations in the profit and loss account where it says 'transfer to general reserve' and the same figure is mentioned. There was a different amount transferred to the balance sheet last year. There is no stipulation that a particular amount should be transferred, it only depends on the company's requirements. Why did it not transfer more money can be traced to the fact that profits have been lower this year as compared to last year.

The third item shows the profit and loss account heading. But most of the companies report it under the heading 'Reserves & Surplus' as it belongs to the shareholders. Here also the figure has remained unchanged from the last year. This means that the next profit was appropriated fully and no extra surplus from the profit and loss account was carried to the balance sheet this time. If you look at the profit and loss account in Annexure I, you see an item in appropriations at the end of the profit and loss account which says 'Dividend Amount Expected' and 'Future Value of the Share Profit' was carried to balance sheet from profit and loss account this year. For the last year, it shows the figure of Rs.3,500,000/- which would now be a part of the figure of 8,500,000 that is shown now.

At the end of reserves & surplus, where it shows previous year figures, the additions work out to Rs 14,980,907 which is exactly the sum that you get when you add the two amounts that were transferred last year to the balance sheet under their respective heads.

A stocks rate of return

In case of shares the first component is "Dt" which is nothing but the income in cash from dividends and the second component is the price change (appreciation and depreciation).

This means that the price you are willing to pay for a share today is a function of the dividends that you expect to receive and the present value of the expected future share price.

Present Value of a Share = $\frac{\text{Dividend Amount Expected}}{r} + \frac{\text{Future Value of the Share}}{(1+r)^n}$

But what if you are going to hold the share to maturity and not sell. Then your only return is the dividend amount. This means that this perpetual dividend is what you would use to value the share. So you simply use the perpetuity formulas mentioned above for constant or growing dividends.

Finding out the present value of the share seems easy-Doesn't it! Now comes the tedious question, what return do you expect from the security? Now every security has a different risk profile and you being a rational human being would expect a return that is commensurate with the risk that you are going to bear. So let us devote some time to understand the nature of risk and then how do we use this knowledge to reach the desired rate of return on the share.

Risk

Risk and return go hand in hand in investments and finance. One cannot talk about returns without talking about risk, because, investment decisions always involve a trade-off between risk and return. Risk can be defined as the chance that the actual outcome from an investment will differ from the expected return. This means that, the more variable the possible outcomes that can occur (i.e. the broader the range of possible outcomes), the greater the risk.

Risk and Expected Rate of Return

The width of a probability distribution of rates of return is a measure of risk. The wider the probability distribution, the greater the risk or the greater the variability of return or greater the variance. An investor cannot expect greater returns without being willing to assume greater risks.

Sources of Risk

- **Interest Rate Risk.** It is the variability in a security's return from changes in the level of interest rates.
- **Market Risk.** Market risk refers to the variability of returns due to fluctuations in the securities market.
- **Inflation Risk.** With rise in inflation there is reduction of purchasing power, hence this is also referred to as purchasing power risk and affects all securities.
- **Business Risk.** This refers to the risk of doing business in a particular industry or environment and it gets transferred to the investors who invest in the business or company. It may be caused by a variety of factors like heightened competition, emergence of new technologies, development of substitute products, shifts in consumer preferences, etc.
- **Financial Risk.** Financial risk arises when companies resort to financial leverage or the use of debt financing. The more the company resorts to debt financing, the

greater is the financial risk as it creates fixed interest payments due to debt or fixed dividend payments on preference stock thereby causing the amount of residual earnings available for common stock dividends to be more variable than if no interest payments were required. It is avoidable to the extent that management have the freedom to decide to borrow or not to borrow funds.

- **Liquidity Risk.** This risk is associated with the secondary market which the particular security is traded in. A security which can be bought or sold quickly without significant price concession is considered liquid. The greater the uncertainty about the true element and the price concession, the greater the liquidity risk. Securities that have ready markets like treasury bills have lesser liquidity risk.

Measurement of Total Risk

Risk is associated with the dispersion in the likely outcomes. Dispersion refers to variability. If an asset's return has no variability, it has no risk. An investor analysing a series of returns on an investment over a period of years needs to know something about the variability of its returns or in other words the asset's total risk.

There are different ways to measure variability of returns. The range from the highest possible to lowest possible rate of return is one measure, but the range is based only on two extreme values.

A more popular way of measuring variability of returns is standard deviation. The standard deviation is simply the square root of the variance of the rates of return.

$$\sigma = \sqrt{\sum_{i=1}^n [P_i (k_i - \bar{k})^2]}$$

where, s = standard deviation

P_i = probability associated with the i th possible outcome

k_i = rate of return from the i th possible outcome

k = expected rate of return

n = number of outcomes

Portfolios and Risk

An investment portfolio refers to the group of assets that is owned by an investor. When an investor invests all his funds in a single security, it is more in the nature of speculation than of an investment, because the returns to the investor are based on the future of the single asset, making it a very risky proposition. Generally, in order to reduce risk, investors hold on to a diversified portfolio which might contain equity capital,

bonds, real estate, savings accounts and various other assets. In other words, the investor does not put all his eggs into one basket.

Diversifiable and Non-diversifiable Risk

The fact that returns on stocks do not move in perfect tandem means that risk can be reduced by diversification. But the fact that there is some positive correlation means that in practice risk can never be reduced to zero. So there is a limit on the amount of risk that can be reduced through diversification. The lower the degree of positive correlation, the greater is the amount of risk reduction that is possible.

The amount of risk reduction achieved by diversification also depends on the number of stocks in the portfolio. As the number of stocks in the portfolio increases, the diversifying effect of each additional stock diminishes.

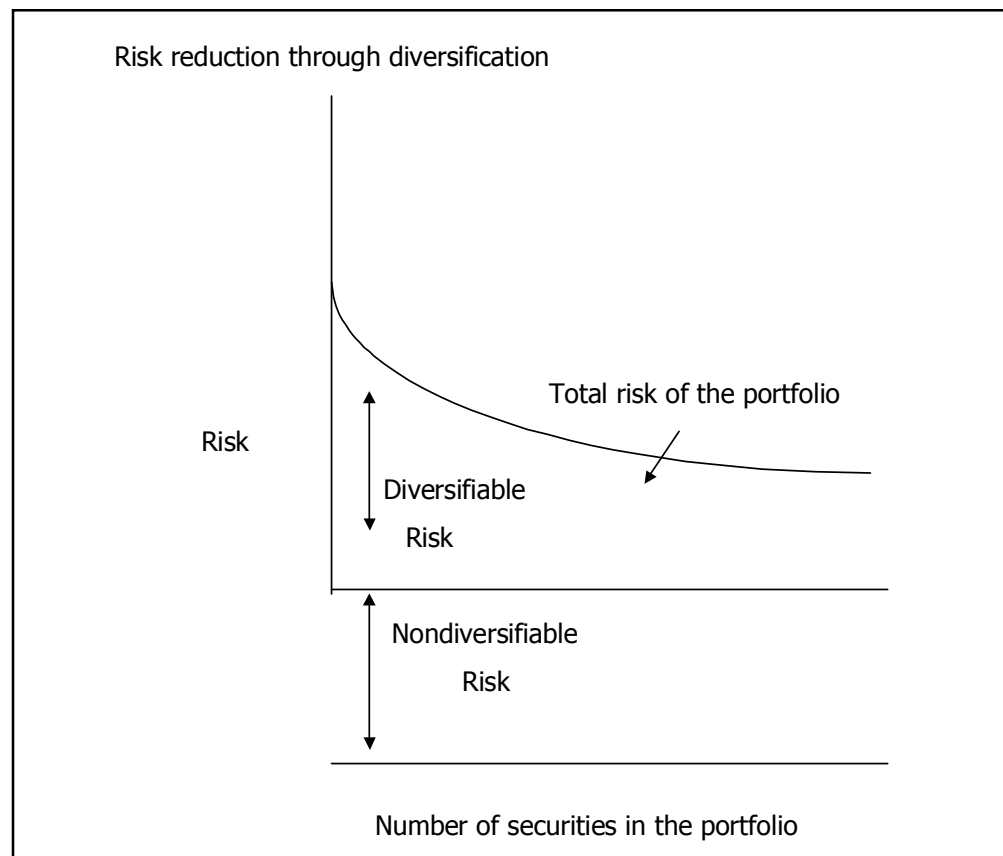

As you can see that the major benefits of diversification are obtained with the first 10 to 12 stocks, provided they are drawn from industries that are not closely related. Increases beyond this point continue to reduce the total risk but the benefits are marginal.

It is also apparent that it is the diversifiable risk that is being reduced unlike the non-diversifiable risk which remains constant whatever your portfolio is.

Nondiversifiable risk is that part of total risk (from various sources like interest rate risk, inflation risk, financial risk, etc.) that is related to the general economy or the stock market as a whole and hence cannot be eliminated by diversification. Nondiversifiable risk is also referred to as market risk or systematic risk.

Diversifiable risk on the other hand, is that part of total risk that is marginal to the company or industry and hence can be reduced by diversification. Diversifiable risk is also called unsystematic risk or specific risk.

Risk of Stocks in a Portfolio

A portfolio's standard deviation is a good indicator of the risk of a portfolio, to the extent that if adding a stock to the portfolio increases the portfolio's standard deviation, the stock adds risk to the portfolio. But the risk that a stock adds to a portfolio will depend not only on the stock's total risk, its standard deviation, but on how that risk breaks down into diversifiable and nondiversifiable risk. If an investor holds only one stock, there is no question of diversification, and this risk is therefore the standard deviation of the stock. For a diversified investor, the risk of a stock is only that portion of total risk that cannot be diversified or its nondiversifiable risk. The nondiversifiable risk is generally measured by Beta coefficient. Beta measures the relative risk associated with any individual portfolio as measured in relation to the risk of market portfolio. The market portfolio represents the most diversified portfolio of risky assets an investor could buy since it includes all risky assets.

The relative risk can be expressed as:

$$\beta = \frac{\text{Non - diversifiable risk of asset or potfolio}}{\text{risk of market portfolio}}$$

Thus, the Beta coefficient is a measure of the non-diversifiable or systematic risk of an asset relative to that of the market portfolio.

- A Beta of 1.0 indicates an asset of average risk.
- A Beta coefficient greater than 1.0 indicates above-average risk - stocks whose returns tend to be more risky than the market.
- A Beta coefficient less than 1.0 indicates below-average risk, i.e., less riskier than market portfolio.

In case of market portfolio all the diversification possible has been done- thus the risk of market is all non-diversifiable which an investor cannot avoid. Similarly, as long as the asset's returns are not perfectly positively with returns from other assets, there will be some way to diversify away its unsystematic risk. As a result beta depends only on non-diversifiable risks.

The beta of a portfolio is nothing but the weighted average of betas of the securities

that constitute the portfolio, the weights being the proportions of investments in respective securities.

Measurement of Beta

The systematic relationship between the return on the security or a portfolio and the return on the market can be described using a simple linear regression, identifying the return on a security or portfolio as the dependent variable K_j and the return on market portfolio as the independent variable K_m , in the single-index model or market model developed by William Sharpe.

This can be expressed as:

$$K_j = \alpha_j + \beta_j K_m + e_j$$

The Beta parameter β_j in the model represents the slope of the above regression relationship and measures the responsiveness of the security or portfolio to the general market and indicates how extensively the return of the portfolio or security will vary with changes in the market return. The Beta coefficient of a security is defined as the ratio of the security's covariance of return with the market to the variance of the market. This can be calculated as follows:

The Alpha parameter "a" is the intercept of the fitted line and indicates what the return of the security or portfolio will be when the market return is zero. For example, a security with an a of +2 per cent would earn 2 percent even when the market return was zero and would earn an additional 2 percent at all levels of market return. The converse is true if a security has a of -2 percent. The positive a thus represents a sort of bonus return and would be a highly desirable aspect of a portfolio or security while a negative a represents a penalty to the investor.

The third term e_j is the unexpected return resulting from influences not identified by the model. Frequently referred to as random or residual return, it may take on any value but is generally found to average out to zero.

The Capital Asset Pricing Model (CAPM)

The CAPM developed by William F Sharpe, John Linter and Jan Mossin is one of the major developments in financial theory. The CAPM establishes a linear relationship between the required rate of return of a security and its systematic or undiversifiable risk or beta.

This relationship as defined by CAPM can be used to value an equity share.

Mathematically the relationship between the share's return and the market return can be depicted by the following formula:

Here

R_s stands for return expected on the security,

R_f stands for risk-free return,

R_m stands for return from the market portfolio and

β stands for beta.

This relationship means that if the market goes up by 10 % and the security price also goes up by 10 %, and vice versa, the beta is said to be 1.00, i.e., there is a perfect correlation between return from the security and return from the market. If the beta is 2.00 the security price would up or down by twice the %age of change of the market. If the beta is 0.00 then no correlation exists between the market movement and the security price movement.

It is easy to see that the required return for a given security increases with increases in its beta.

Assumptions

The CAPM is based on a list of critical assumptions, some of which are as follows :

- Investors are risk-averse and use the expected rate of return and standard deviation of return as appropriate measures of risk and return for their portfolio. In other words, the greater the perceived risk of a portfolio, the risk-averse investor expects a higher return to compensate the risk.
- Investors make their investment decisions based on a single-period horizon, i.e., the next immediate time period.
- Transaction costs in financial markets are low enough to ignore and assets can be bought and sold in any unit desired. The investor is limited only by his wealth and the price of the asset.
- Taxes do not affect the choice of buying assets.
- All individuals assume that they can buy assets at the going market price and they all agree on the nature of the return and risk associated with each investment.

In the CAPM, the expected rate of return can also be thought of as a required rate of return because the market is assumed to be in equilibrium. The expected return is the return from an asset that investors anticipate or expect to earn over some future period. The required rate of return for a security is defined as the minimum expected rate of return needed to induce an investor to purchase it.

Investors can earn a riskless rate of return by investing in riskless assets like treasury bills. This risk free rate of return is designated R_f and the minimum return expected by the investors. In addition to this, because investors are risk-averse, they will expect a risk premium to compensate them for the additional risk assumed in investing in a risky asset.

$$\text{Required Rate of Return} = \text{Risk-free rate} + \text{Risk premium}$$

The CAPM provides an explicit measure of the risk premium. It is the product of the Beta for a particular security j and the market risk premium $K_m - R_f$.

$$\text{Risk premium} = b_j (K_m - R_f)$$

This Beta co-efficient ' b_j ' is the non-diversifiable risk of the asset relative to the risk of the market. If the risk of the asset is greater than the market risk, i.e., b exceeds 1.0, the investor assigns a higher risk premium to asset j , than to the market.

The Security Market Line

The plot of relationship between the required rate of return (k_j) and non-diversifiable risk(beta) as expressed in CAPM will produce a graph of the SML as shown below

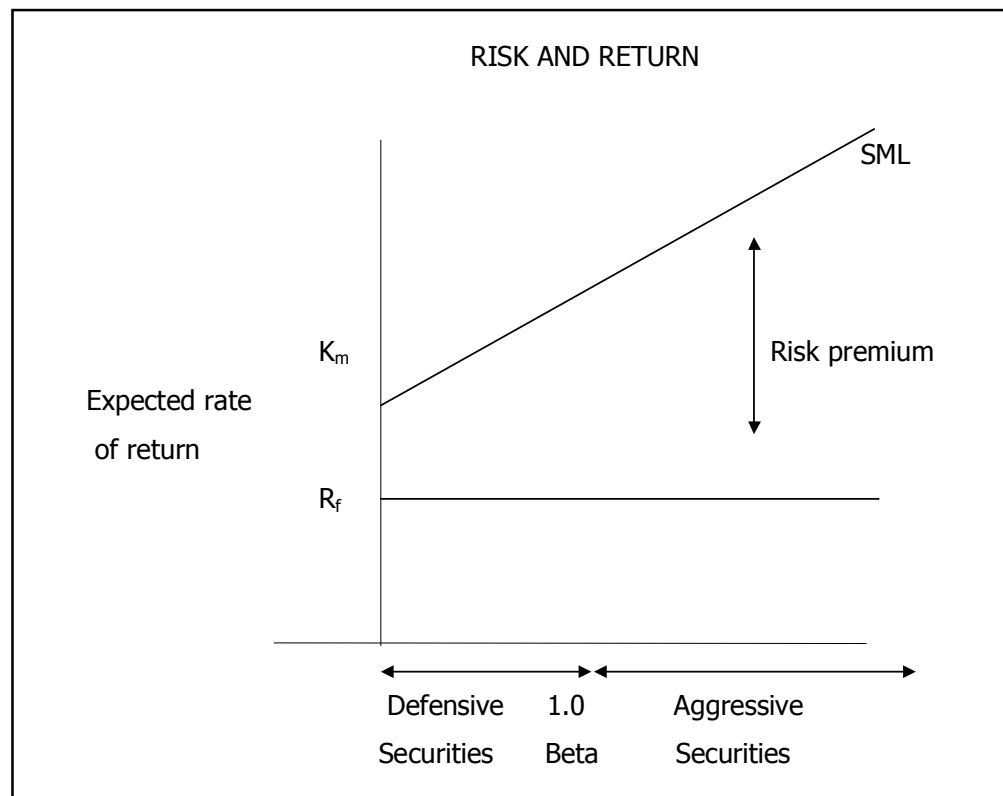

As per the CAPM assumptions any individual security's expected return and beta statistics should lie on the SML. The SML intersects the vertical axis at the risk-free

rate of return R_f and $k_m - R_f$ is the slope of the SML. Since all securities are expected to plot along the SML, the line provides a direct and convenient way of determining the expected/required return of a security if we know the Beta of the securities. The SML can also be used to classify securities. Those with betas greater than 1.00 and plotting on the upper part of the SML are classified as aggressive securities while those with betas less than 1.00 and plotting on the lower part of the SML can be classified as defensive securities which earn below-average returns.

Asset pricing implications of the SML

One of the major assumptions of the CAPM is that the market is in equilibrium and that the expected rate of return is equal to the required rate of return for a given level of market risk or beta. In other words, the SML provides a framework for evaluating whether high-risk stocks are offering returns more or less in proportion to their risk and vice versa.

Once a security's expected rate of return and beta have been computed they may be plotted with reference to the SML. If the security's required rate of return, the security may be over or under priced and may fall below or above the SML.

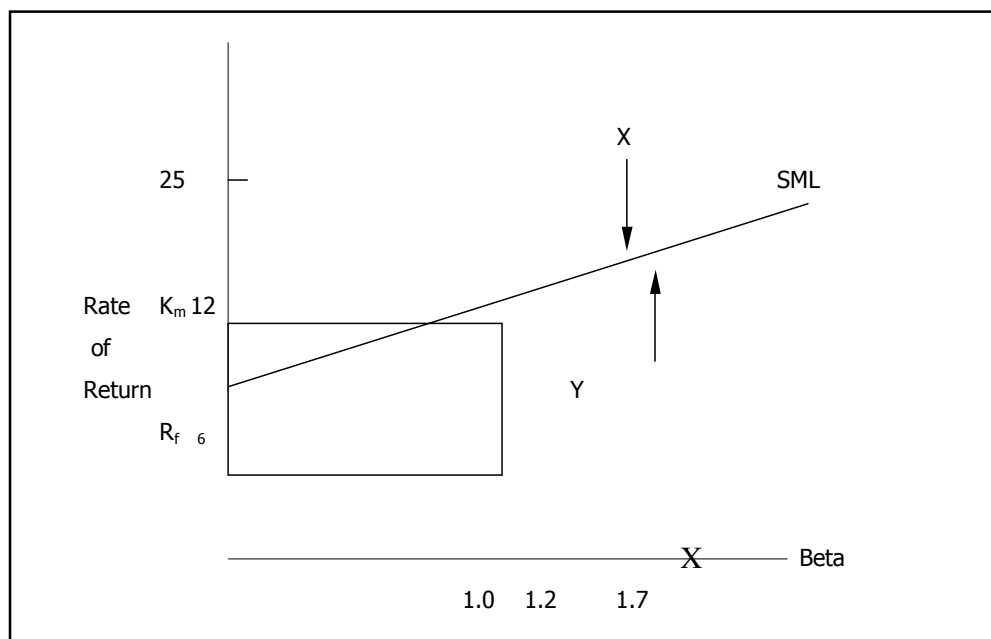

From the figure we see that $R_f = 6\%$ and $k_m = 12\%$.

Two securities X and Y have been shown in the figure. Both X and Y should have been on the SML but obviously are not. Taking the case of X first, the expected rate of return from X is around 25%. But at a beta of around 1.2, using the SML we see that the required rate of return need be only around 13%. This tells us that security X is undervalued or priced too low because its average rate of return is inappropriately high for the level of risk it bears.

On the other hand, Security Y with a beta of around 1.7 requires a rate of return of around 16% but its expected return is only about 7%. This tells us that the asset is overvalued or overpriced and hence unattractive because it is expected to produce a return lower than stocks with similar betas. These two assets should move toward their equilibrium - required return positions on the SML (i.e., expected rate of return should be equal to required rate of return and correspond to their respective betas).

To reach equilibrium and their required rate of return positions on the SML both stocks have to go through a temporary price adjustment. In order to reach equilibrium, assuming betas remain the same, the expected return of X has to be brought down to be equal to the required rate of return and be plotted on the SML. To accomplish this, the purchase price has to be sufficiently increased. Similarly, for security Y, the purchase price has to be sufficiently reduced so that the expected return rises to be the same level as the required rate of return.

In practice, investors will be interested in purchasing security X because it offers more than proportionate returns in comparison to the risk. This demand will push up the price of X as more of it is purchased and correspondingly bring down the returns. This process will continue till it reaches the equilibrium price and the expected returns are the same as the required returns.

In the case of security Y, investors will be tempted to sell as it offers less than the required rate of return. This increase in the supply of Y will drive down its price and correspondingly increase the return until the expected return rises enough to reach the SML and the security is once again in equilibrium.

Thus, the CAPM provides many useful insights for the finance manager to maximise the value of the firm. It shows the type of risk for which shareholders require compensation in the form of higher risk premium, and hence higher returns. Because finance managers also perform the investment function on behalf of shareholders, they must keep sight of the returns shareholders expect for taking risks.

Now let us look at another part of the investment decision, i.e., what cash flows to include and what cash flows to exclude.

Cash Flow

In considering investment decisions, it does not matter whether outlays are termed 'capital' or 'revenue' nor whether inflows are termed 'profit', 'depreciation', 'tax allowance', or whatever. All outlays and income must be taken into account.

Cash flows in this context is not the same as the cash flow through a bank account, nor is it identical to accounting profit, since changes in the later can occur without any change taking place in the cash flow.

For purposes of investment appraisal, the cash flow is the incremental cash receipts less the incremental expenditures solely attributable to the investment in question.

The future costs and revenues associated with each investment alternative are:

1. **Capital costs:** These cover (a) the long-term capital outlays necessary to finance a project, and (b) working capital. Typically additional working capital will be required to cover a higher inventory, or a larger number of debtors, and to be worth while the project must earn a turn on this capital as well as on the long-term capital.
2. **Operating costs:** Running costs of the operations that are required to generate income. These include both the variable and the fixed costs.
3. **Revenue:** Realisations from the sale of goods produced as well as other income which is not directly attributable to operations but contributes to the profitability of the operations.
4. **Depreciation:** In the case of the discounting methods of appraisal, the recovery of capital is automatically allowed for from the net cash flow, so depreciation need not be included as an accounting provision. This has the important advantage that the discounting profitability assessment is not affected by the pattern of accounting depreciation chosen.
5. **Residual value:** As with working capital, the residual assets of the project may have a value. This residual value should be included with the net cash flow.

An investment decision implies the choice of an objective, a technique or appraisal, and length of service-the project's life. The objective and technique must be related to definite period of time.

No matter how good a company's maintenance policy, its technological forecasting ability, or its demand forecasting ability, uncertainty will always be present because of the difficulty of predicting the length of project's life.

The actual assessment of a project's profitability is a team exercise in which the expertise of economist, the market researcher, the engineer, and the controller must all be brought together. The outcome of their collaboration will be a forecast of the cash flow over a period of years. If this period is incorrectly estimated, the whole analysis will be wrong or at least grossly inaccurate.

As a rule, in investment appraisal, one of two assumptions is adopted-either the cash flow is assumed to be known with certainty, or the best estimate is used. The assumption of certainty is generally unacceptable, so allowance must be made for the risk inherent in the proposed adoption of the 'best' estimate. To the expected outcome, probabilities can be attached to sales, costs, and other elements of the investment proposal to allow for risk.

The application of risk analysis enables management to answer the following questions: (1) What is the profitability resulting from given estimates of costs and revenues from the project, if they are achieved? and (2) What is the likelihood of such estimates being achieved?

This then enables top management to concentrate on those factors that are critical to the financial success of the project, such as selling price, sales volume, capital cost, and so forth.

Measuring cash flows is not a very tedious job if they exist, but always remember you are talking about future projections in these cash flows and projections are perceptions that change with each person.

The Weighted Average Cost of Capital

Assumptions of the cost of capital model

- A. **Constant business risk:** We assume that any investment being considered will not significantly change the firm's business risk. Therefore the overall cost of capital would not change with the changing nature of investments in different markets.
- B. **Constant financial risk:** Management is assumed to use the same financial mix as it used in the past with the same combination of debt and equity.
- C. **Constant dividend policy:**
 - 1. For ease of computation, it is generally assumed that the firm's dividends are increasing at a constant annual growth rate. Also, this growth is assumed to be a function of the firm's earning capabilities and not merely the result of paying out a larger percentage of the company's earnings.
 - 2. We also implicitly assume that the dividend payout ratio (dividend/net income) is constant.

Computing the weighted cost of capital

A firm's weighted cost of capital is a function of (1) the individual costs of capital, (2) the capital structure mix, and (3) the level of financing necessary to make the investment. The individual costs of capital helps in deciding the weightage that has to be given to the different modes of financing. The capital structure mix decides level of the debt that the company would take up. The level of financing helps in working out the amount that the company could shell out of its own and deciding whether and how much to finance from outside sources.

Determining individual costs of capital

- a) **Cost of Debt:** As we discussed in the last chapter the before-tax cost of debt is found by trial-and-error by solving for k_d in

$$PV = PV_0 = \sum_{t=1}^n \left(\frac{\text{Interest}_t}{(1+k_d)^t} \right) + \frac{\text{Principal}}{(1+k_d)^n}$$

where PV = the market price of the debt, less flotation costs,

Interest_t = the annual interest paid to the investor each year,

Principal = the maturity value of the debt

k_d = before-tax cost of the debt (before-tax required rate of return on debt)

n = the number of years to maturity.

The after-tax cost of debt equals $= k_d(1 - T)$.

- b) **Cost of preference share** (required rate of return on preference share), k_{ps} , equals the dividend yield based upon the net price (market price less flotation costs) or

$$k_{ps} = \frac{\text{dividend}}{\text{net price}} = \frac{D}{NP_o}$$

- c) **Cost of equity share:** There are three measurement techniques to obtain the required rate of return on equity shares as discussed in the last chapter. The first is the perpetuity growth model, also known as the dividend growth model. A variation on the same is to look at the floatation of a new equity share and include the floatation costs when determining the cost of capital. The second one is the CAPM model. The third one derives its value from the value of the debt of the company.

- i) Dividend growth model

- a. Cost of internally generated common equity, k_s

$$k_s = \frac{\text{dividend in year 1}}{\text{market price}} + \left(\frac{\text{annual growth}}{\text{in dividends}} \right)$$

$$k_s = \frac{D_1}{P_o} + g$$

- b. Cost of new equity share, k_{ns}

$$k_{ns} = \frac{D_1}{NP_o} + g$$

where $NP_o =$ the market price of the equity share less flotation costs incurred in issuing new shares.

- ii) **Capital asset pricing model:** As discussed in the last chapter the expected cost of equity share is dependent on the risk profile of the share versus the market as a whole.

$$k_s = k_f + b(k_m - k_f)$$

where $k_s =$ the cost of equity share

$k_f =$ the risk-free rate

$b =$ beta, measure of the stock's systematic risk

$k_m =$ the expected rate of return on the market

- iii) **Risk-Premium Approach:** All these models are very useful for companies that have their shares listed in the market or about to get them listed. What about the companies that are privately owned. The best way to do it for these companies is to find the general risk premium and take the company specific cost of debt (which is supposed to include the risk premium of the company) and then add the two to find out the equity cost of the company.

$$k_s = k_d + RP_s$$

where $k_s =$ cost of equity share

$k_d =$ cost of debt

$RP_s =$ risk-premium of equity share

2. Determining capital structure mix
3. The individual costs of capital will be different for each source of capital in the firm's capital structure. If the company uses debt to the level of fifty percent of its investment, then the cost of debt should get 50% weightage in the capital structure.

To use the cost of capital in investment analyses, we must compute a weighted or overall cost of capital.

3. **Level of financing and the weighted average cost of capital**

The weighted marginal cost of capital specifies the composite cost for each additional rupee of financing. The firm should continue to invest up to the point where the marginal internal rate of return earned on a new investment (IRR) equals the marginal cost of new capital.

Effect of additional financing on the cost of capital would be threefold.

- a. Issuing new equity share will increase the firm's weighted cost of capital because external equity capital has a higher cost than internally generated common equity.
- b. As we use additional debt and preference shares, their cost may increase, which will result in an increase in the weighted cost of capital.
- c. The increase in the firm's weighted marginal cost of capital curve will occur at the total rupee financing level when all the cheaper funding will be consumed by the firm's investments, given the targeted debt- equity ratio. The increase in the weighted cost of capital will occur when the total financing from all sources equals:

Procedure for determining the weighted marginal cost of capital curve is given below for ready reference.

1. Determine financial mix to be used.
2. Calculate the level of total financing at which the cost of equity capital increases.
3. Calculate the costs of each source of capital.
4. Compute the weighted marginal costs of capital at different levels of total financing.
5. Construct a graph that compares the internal rates of return of available investment projects with the weighted marginal costs of capital.

Calculation of Weighted average cost of capital

WACC basic computation is given by the formula given below

$$k_o = k_s \left(\frac{E}{D+E} \right) + k_d [1-T] \left(\frac{D}{D+E} \right)$$

where:

k_o = the weighted average cost of capital

k_s = the cost of equity capital

k_d = the before-tax cost of debt capital

T = the marginal tax rate

$E/(D+E)$ = percentage of financing from equity

$D/(D+E)$ = percentage of financing from debt

$(D+E)$ = Total capital employed by the firm

In the formula above we are assuming that the capital has two components only, debt

and equity. If the preference capital is also there then it is simply added to it the way other two are denoted.

The cost of capital and cash flows are then utilised to evaluate a project by using an evaluation method.

Chapter-3

Operating and Financial Leverage

One of the most important of the various financial decisions is how much leverage a firm should employ.

A fundamental decision made by any business is the degree to which it incurs fixed costs. A fixed cost is one that remains the same regardless of the level of operations. As sales increase, fixed costs don't increase in the same proportion. Some fixed costs do not increase at all till a particular point. As a result, profits can rise faster during good times. On the other hand, during bad times fixed costs don't decline, so profits fall more rapidly than sales do.

The degree to which a firm locks itself into fixed costs is referred to as its leverage position. The more highly leveraged a firm, the riskier it is because of the obligations related to fixed costs that must be met whether the firm is having a good year or not. At the same time, the more highly leveraged the greater the profits during good times. This presents a classic problem of making a decision where there is a trade-off between risk and return.

There are two major types of leverage - financial and operating. Financial leverage is specifically the extent to which a firm gets its cash resources from borrowing (debt) as opposed to issuance of additional shares of (equity). The greater the debt compared to equity, the more highly leveraged the firm because debt legally obligates the firm to interest payments. These interest payments represent a fixed cost.

Operating leverage is concerned with the extent to which a firm commits itself to high levels of fixed costs other than interest payments. A firm that rents property using cancellable leases has less leverage than a firm that commits itself to a long-term noncancellable lease does. A firm that has substantial vertical integration has created a highly leveraged situation. Consider what happens if a company vertically integrates by acquiring its raw materials' supplier. Raw materials will now cost the company less, because it doesn't have to buy them from an outside firm. But when times are bad, the firm will have to bear the fixed costs associated with the supplier subsidiary. Had there still been two separate companies, the big company could have simply slowed its purchases of raw materials from supplier without having to bear its fixed costs.

In the cases of both financial and operating leverage, the crucial question is how much leverage is appropriate. We can't answer that question in absolute terms, but we will

help you understand the topic. This understanding should make it simpler to make appropriate choices or to understand what went into making the choices your firm has already made.

Operating Leverage

While decisions about financial leverage is strictly the domain of the firm's highest levels of management, operating leverage is an issue that directly affects the line managers of the firm. The level of operating leverage a firm selects should not be made without input from the managers directly involved in the production process. For example, one of the most significant operating leverage issues is the choice of technology levels. Selection of the highest level of technology available is not always in the best interests of the business.

Suppose that we are opening a chain of copy centres. Each centre will provide a full service operation. Customers can drop work off in the morning and pick it up later in the day or the week. The employees will do the actual photocopying. We are faced with the choice of renting a relatively slow copy machine, or the newest technology machine, which is considerably faster. The faster machine is also considerably more expensive to lease.

It will generally be the case that newer technology has a higher fixed cost and lower variable cost than the older technology. Variable costs are those that vary directly with volume. If we double the number of copies made, we double the amount of paper, printing ink toner, and labour time needed for making the copies. One of the principle functions of new technology is to reduce the variable costs of production.

It may turn out that a machine that can reduce the variable costs is more expensive to make, and thus has a higher purchase or lease price than the older generation machine. However, even if it doesn't cost more to make, its manufacturer will charge more for the new machine than for the older machine. Intuitively, if the new machine is in some respect better than the old machine (that is, it lowers the variable cost without reducing quality), and doesn't cost more to buy, then no one will buy the older machine. Thus, anytime we see two technologies being sold side by side, such as slow and fast copy machines, we can expect the faster machine to have a higher rental fee or purchase price, and therefore a higher fixed cost.

Let's assume that we could lease the slower, older technology copy machine for Rs 10,000 per year, or a faster, newer technology copy machine for Rs 15,000 per year. Both produce photocopies of equal quality. Both use the same quantities of paper and ink toner, but the faster machine requires less operating time. Therefore, the labour cost is much lower for the faster machine. As a result, the variable cost of copies on the slow machine is 30 paise each, while the variable cost of copies from the fast machine is only 25 paise each. Is the faster machine the better bet?

That depends. Suppose we sell each copy for 50 paise. Then, for each copy we sell we receive 50 paise and spend extra 30 paise or 25 paise (depending on our choice of machine) for the variable costs. The difference between the price and the variable costs is referred to as the contribution margin. This margin represents the amount of money available to be used to pay fixed costs and provide the firm with a profit.

If we use the slower machine, we receive 50 paise and spend 30 paise, leaving 20 paise to be used toward paying the rent on the copy machine. If we sell enough copies, there will be enough individual contributions of 20 paise a piece to pay the full Rs 10,000 rent and leave some receipts for a profit.

So in operating leverage the decision boils down to the production levels that we have or we anticipate and on that basis we decide the amount of fixed costs that we are willing to bear. All this leads itself to breakeven analysis or cost-volume-profit analysis that you have learned earlier.

Financial Leverage

Let's start our discussion of financial leverage with an example. Assume you were to buy a small building as a piece of investment property. You buy the building for Rs 1,00,000 and pay the full amount in cash.

Suppose that an year later you sell the building for Rs 1,30,000. Your pre-tax profit is Rs 30,000. This is a 30% pre-tax return on your original investment of Rs 1,00,000.

As an alternative to paying the full Rs 1,00,000 cash for the investment, you might have to put Rs 10,000 cash down and borrow Rs 90,000 from the bank at 15% interest. This time when you sell the property for Rs 1,30,000 you repay Rs 90,000 to the bank, along with Rs 13,500 interest. After deducting your original Rs 10,000 investment, Rs 16,500 is left as a pre-tax profit. This is a pre-tax return of 165% on your Rs 10,000 investment. Compare the 30% we calculated earlier to this rate of return of 165%. That's financial leverage for you!

Note that we had a net profit of Rs 30,000 without leverage, but only Rs 16,500 in the leveraged case. Although we earned a higher return, we had less profit. That's because in the unleveraged case we had invested Rs 1,00,000 of our money, but in the leveraged case we had invested only Rs 10,000. If we have additional investment opportunities available to us, we could have invested our full Rs 1,00,000, borrowed Rs 90,000, and had a pre-tax profit of Rs 165,000 on the same investment that yields Rs 30,000 in the unleveraged situation. Financial leverage can not only increase your yield from investments, but can also allow you to consider projects that are much larger than what would be feasible without borrowing.

Suppose, however, that the property were sold after one year for Rs 70,000 rather than Rs 1,30,000. On Rs 1,00,000 unleveraged investment, the loss would be Rs 30,000 before taxes. This would be a 30% loss on our original Rs 1,00,000 investment.

In the leveraged case, the loss will be magnified. We would have to repay the bank the Rs 90,000 loan plus Rs 13,500 of interest. These payments total to Rs 1,03,500, which is Rs 33,500 greater than the Rs 70,000 proceeds from the sale. Further, we've lost our initial Rs 10,000 investment. The total loss is Rs 43,500 before taxes. On our initial investment of Rs 10,000, this constitutes a loss of 435 percent. That's financial leverage too!

Let us put that into a table so as to see the effect of financial leverage more clearly.

Original investment	Amount Borrowed	Profit/ (Loss)	Profit/ (Loss) as percentage of original investment
1,00,000	-	30,000	30 %
10,000	90,000	30,000	1,65 %
1,00,000	-	(30,000)	(30 %)
10,000	90,000	(30,000)	4,35 %

Clearly when the firm is going to accept this level of leverage it must decide if the 165% possible gain is worth the risk of a 435% loss. Whether it is or not depends on the likelihood of the increase in value versus the probability of a decline. Of course it can accept a lower level of leverage but still the interplay of debt and equity would be there and a study of its effects in both the good times and the bad times would be important.

If the project really was a sure thing, leverage would certainly make sense but projects are rarely sure things. Yet, managers should try to decide how confident they are of the success of a project, and weigh that confidence against the implications for the firm if the project does indeed fail. Not all managers rate the same project as being equally likely to succeed. Some managers feel a particular project is great, while others may not think as highly of it.

Further, even if all managers agreed on how likely a project were to succeed, they would not all make the same decision about financial leverage. Some managers and firms tend to be more averse to risk than others. There are gamblers and conservatives. Usually shareholders align themselves with a firm that they feel does things the way they want them done. A person dependent on a steady level of income from share dividends might prefer to buy the share of a firm that shuns leverage and prefers a steady, if lesser income. A person looking for large potential appreciation in share price might prefer the share of a firm that is highly leveraged.

How Much Financial Leverage Is Enough

In practice, the leverage decision is based on firm policy. Some firms raise almost all of their funds from issuing share to shareholders and from earnings retained in the firm. Other firms borrow as much as they possibly can and raise additional money from shareholders only when they can no longer raise any additional money by borrowing. Most firms are somewhere in the middle. In the example that we discussed above, you didn't have to borrow Rs 90,000 or nothing; you could have chosen to borrow some amount in between the two. Likewise, some firms maintain one-fourth as much debt as equity, some firms equal amounts of debt and equity, and some firms more debt than equity.

The firm's top corporate managers and the board of directors make this decision. Generally, project managers evaluating the potential of individual projects do not make the decision of issuing share or borrowing money.

Debt or Equity?

In making a decision regarding whether additional funds should be raised from issuing debt or equity, there are several factors to be considered. The first rule of financial leverage is that it only pays to borrow if the interest rate is less than the rate of return on the money borrowed. If your firm can borrow money and invest it at a high enough rate so that the loan can be repaid with interest and still leave some after-tax profit for your shareholders, then your shareholders have profited. They have made extra profit with no extra investment. This greatly magnifies the rate of return on the amount they invested.

Why are lenders so generously allowing you to benefit at their expense? How can there be a system where a firm can increase profits to its shareholders without extra investment from them? The key is risk. The shareholders of your company don't increase their investment, but they do increase their risk. The lender may not reap all of the possible profits from the use of his money. But the lender does earn a contractually guaranteed rate of return. The lender gets back his money plus a set amount of interest, whether we make a fortune or lose our shirts.

The amount that lenders let you borrow depends largely on your available collateral. Merely desiring to be highly leveraged doesn't guarantee that you can borrow enough to be highly leveraged. Because the lender isn't a partner if you strike it rich, he doesn't want to be a partner if you go bankrupt.

Assuming that you have enough collateral to borrow as much as you might want, what factors should you consider in trying to arrive at a reasonable level of leverage? To a great degree, your desired leverage position depends on the degree to which your sales and profits fluctuate. The greater the fluctuation in sales and profits, the less leverage you can afford. If your firm is a stable, noncyclical firm that makes money in good times and bad, then use of debt will help improve the rate of return earned by your shareholders. If cyclical factors in your industry or the economy at large tend to cause your business to have both good and bad years, then debt entails a greater risk.

For example, the petrochemicals industry, with its huge capital requirements has traditionally been highly leveraged. The results have been very large profits during the good years, but substantial losses during periods when petrochemical prices falls.

Cyclical factors shouldn't scare companies away from having any debt at all. The key is to accumulate no more interest and principal repayment obligations than can reasonably be met in bad times as well as good. Ultimately, considering the variability of your profit stream, a decision must be made regarding the level of extra risk you are willing to take to achieve a higher potential rate of return on shareholder investments.

Impact of Financial Leverage

Financial leverage acts as a lever to magnify the influence of fluctuations. Any fluctuation in earnings before interest and taxes (EBIT) is magnified on the earnings per share. (EPS) by operation of leverage. The greater the degree of leverage, the wider the variation in EPS given any change in EBIT. The following illustration would explain how leverage technique works.

Illustration

Pramila company is capitalised with Rs. 10,00,000 divided in 1,000 common shares of Rs. 1,000 each. The management wishes to raise another Rs. 10,00,000 to finance a major programme of expansion through one of our possible financing plans. The management may finance the company with :

- (I) all common stock,
- (II) Rs. 5 lakhs in common stock and Rs. 5 lakhs in debt at 5 per cent interest, or
- (III) all debt at 6 per cent interest or
- (IV) Rs. 5 lakhs in common stock and Rs. 5 lakhs in preferred stock with 5 per dividend.

The company's existing earnings before interest and taxes (EBIT) amounted to Rs. 1,20,000. Corporation tax is assumed to be 50 percent.

Solution:

Impact of financial leverage, as observed earlier, will be reflected in earnings per share available to common stockholders. To calculate, the EPS in each of the four alternative EBIT has to be first of all calculated:

	Proposal A Rs.	Proposal B Rs.	Proposal C Rs.	Proposal D Rs.
EBIT	120000	120000	120000	120000
Less Interest	-	25000	60000	-
EBT	120000	95000	60000	120000
Less Taxes @ 50%	60000	475000	30000	60000
EAT	60000	475000	30000	60000
Preferred Dividend	-	-	-	25000
Earnings Available to Common stock holders	60000	47000	30000	35000
No of Equity Shares	20000	15000	10000	15000
EPS	3.0	3.67	3.0	2.33

Thus, when EBIT is Rs. 1,20,000, proposal B involving a total capitalisation of 75 percent common stock and 25 per cent debt would be the most favorable with respect to earnings per share. It may further be noted that proposition of common stock in total capitalisation is the same in both the proposals Band D but EPS is altogether different because of induction of preferred stock. While preferred stock dividend is subject to taxes where as interest on debt is tax-deductible expenditure resulting in variation in EPS in proposals B and D. With a 50 percent tax rate the explicit cost of preferred stock is twice the cost of debt.

We have so far assumed that level of earnings would remain the same even after the expansion of funds. Now assume that level of earnings before interest and taxes doubles the present level in correspondence with increase in capitalisation, changes in earnings per share to common stockholders under different alternatives would be as follows:

Illustration

	Proposal A Rs.	Proposal B Rs.	Proposal C Rs.	Proposal D Rs.
EBIT	2,40,000	2,40,000	2,40,000	2,40,000
Less Interest	-	2,5000	60,000	-
EBT	2,40,000	2,15,000	1,80,000	2,40,000
Less Taxes @ 50%	1,20,000	1,07,000	90,000	1,20,000
EAT	1,20,000	1,07,000	90,000	1,20,000
Less: Preferred Dividend	-	-	-	25000
Earnings Available to Common stock holders	1,20,000	1,07,000	90,000	1,20,000
No of Equity Shares	20,000	15,000	10,000	15,000
EPS	6	7.17	9	6.33
EPS before Additional Issue	3	3	3	3

It is evident from illustration that increase in earnings before interest and taxes is magnified on the earnings per share where debt has been inducted. Thus, in proposal Band *d* where debt comprises a portion of total capitalisation, EPS would increase by more than twice the existing level while in proposal A EPS has improved exactly in proportion to increase in earnings before interest and taxes. Since dividend in preferred stock is a fixed obligation and is less than the increase in earnings, EPS in proposal D also increases more than twice the rise in earning.

Another important conclusion that could be drawn from the above illustration is that the larger the ratio of debt to equity, the greater the return to equity. Thus, in proposal C where debt represents 50 per cent of the total capitalisation, EPS is magnified three times over the existing level while in proposal B where debt has furnished one-third

of the total funds, increase in EPS is little more than double the earlier level. This volatility of earning operates' during contraction of income as well as during an expansion.

Likewise, financial leverage magnifies all losses sustained by the company. Assume that the Rekha Company expects to sustain a loss of Rs. 60,000 before interest and taxes, loss per share under the different alternatives would be:

Illustration

	Proposal A Rs.	Proposal B Rs.	Proposal C Rs.	Proposal D Rs.
Loss before interest and Taxes	-60,000	-60,000	-60,000	-60,000
Add: Interest	-	25,000	60,000	-
Loss Per Share	3	5.67	12	4

Thus loss per share is highest under alternative C where proportion of debt is, as high as 50 per cent of the total capitalisation and the lowest in proposal A where leverage is zero. This is why the phrase 'financial leverage magnifies both profits and loss is very often quoted to explain magic of the financial leverage.

Thus, the financial leverage is useful as long as the borrowed capital can be made to pay the company more than what it costs. Naturally it will become source of decrease in profit rates when it costs more than what it earns. To what extent debt capital should be used in order to improve earnings of the company is a major financing problem facing a finance manager. It should be remembered here that the financial leverage offers

financial advantages only up to a point. Beyond that point debt financing may be detrimental to the company. For instance, as we expand the use of debt' in our capital structure, lenders will perceive a greater financial risk for the company. For that reason, they may raise the average interest rate we pay, and place certain restrictions on the company. Furthermore, concerned equity stockholders' may drive down the price of the stock forcing the management away from the company's main objectives of maximizing

overall value of the company in the market. Thus, before using the financial leverage as a technique of improving net earnings of the company, its impact on EPS must carefully weighed .

A graphical presentation of a financing plan

A financing plan that consisted of Rs.40,000 of 5-percent bonds, 500 shares of Rs. 4 preferred stock, and 1,000 shares of common stock was used to illustrate financial leverage in Table 3.1. This financing plan can be illustrated graphically; like all plans of this type, it can be plotted as a straight line. This is because it is affected only by the deduction of certain fixed rupees costs. Plotting two values of EBIT Rs.10,000 and Rs.14,000-and associated earnings per share of Rs. 2 and Rs. 4 gives us the line in Figure 3.1.

This line shows the earnings per share associated with each level of EBIT. It is interesting to note that the line intersects the EBIT axis at Rs.6,000. This value of EBIT represents the level at which the firm's earnings per share are equal to zero. This zero intercept can be verified by looking at Case 2 in Table 3.1. At levels of EBIT below Rs.6,000, the firm would have negative EPS. This portion of the graph has not been included.

A graphical illustration of different degrees of financial leverage The type of graphical presentation in Figure 3.7 can be used to illustrate differences in financial leverage. Suppose we want to compare the financing plan in the preceding example with an alternate plan. The alternate plan involves Rs. 20,000 of 5-percent debt, 250 shares of Rs. 4 preferred stock,

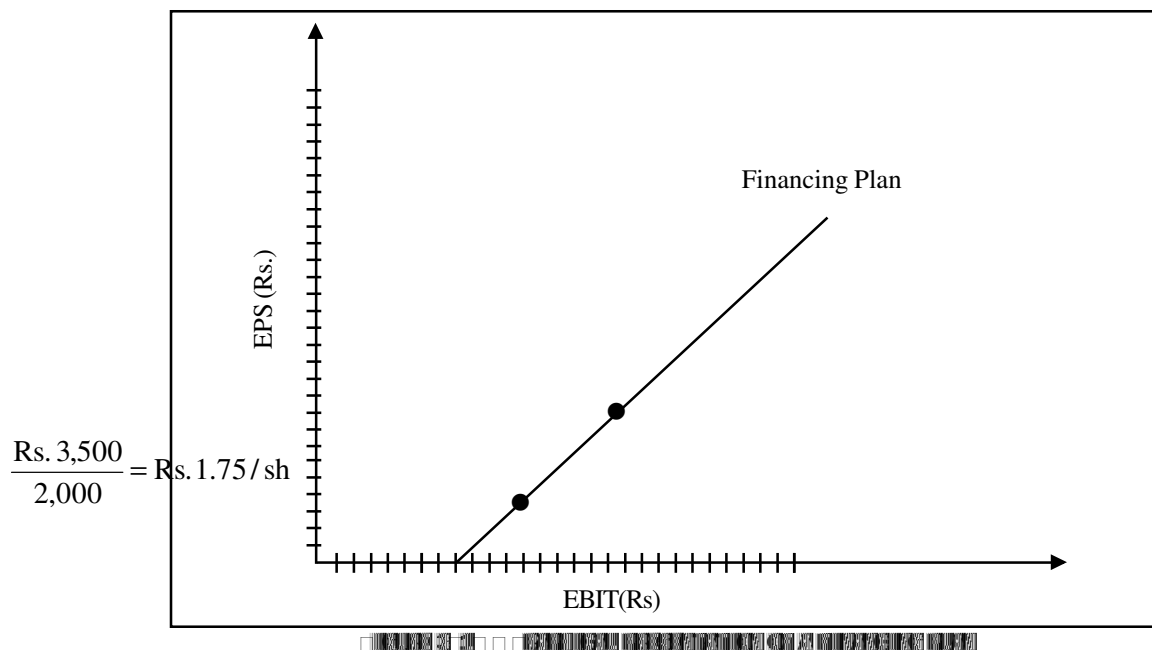

and 2,000 shares of common stock. The annual interest payment will be Rs. 1,000 (.05 × Rs.20,000) and the annual preferred dividend payment will be Rs. 1,000 (Rs.4/sh. × 250 sh.). in order to graph this plan, two sets of EBIT -EPS coordinates are required. The EPS associated with EBIT values of Rs.10,000 and Rs.14,000 are calculated below.

		40%	
		Rs.	Rs.
EBIT	10,000		14,000
I	1,000		1,000
EBT	9,000		13,000
-T (50%)	4,500		6,500
-P	1,000		1,000
EPC	3,500		3,500
EPS		$\frac{Rs. 5,500}{2,000} = Rs. 2.75 / sh$	
		+56%	

A 40-percent increase in the firm's EBIT will result in a 56-percent increase in EPS. Applying Equation 3.6 to these values yields

$$\frac{+56\%}{+40\%} = 1.4$$

The value of 1.4, when compared to the financial leverage value of 2.5 calculated earlier indicates that this plan has a lower degree presented initially. Each of these plans is graphed in Figure 3.8. The original plan, first graphed in Figure 3.1, is labeled plan A; the current plan is labeled plan B.

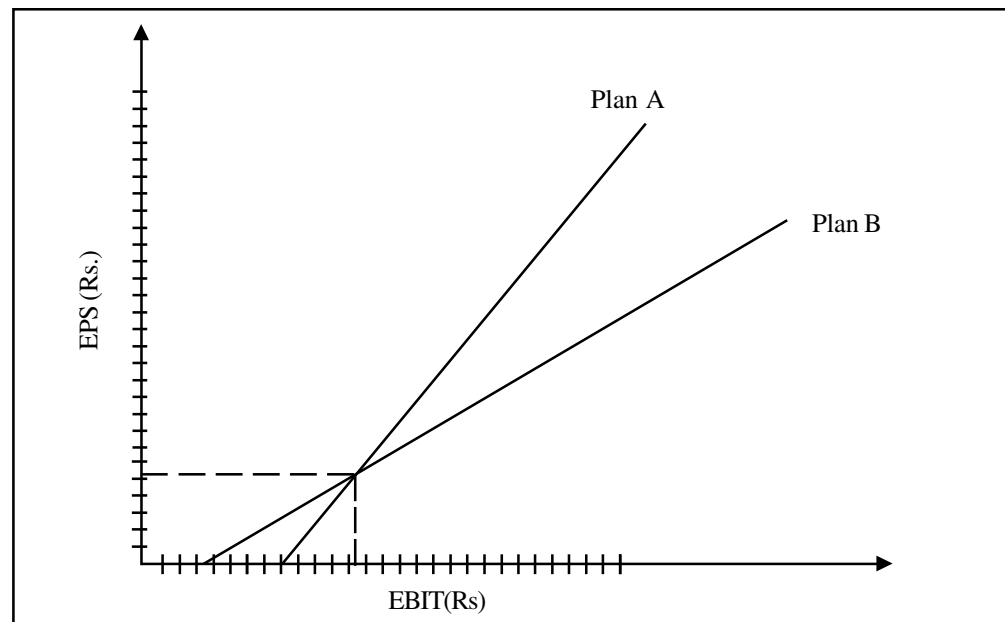

As Figure 3.8 illustrates, the slope of plan A is steeper than that of plan B. This indicates that plan A has more financial leverage than plan B. This result is as expected, since the ratio of the change in EPS for a given change in EBIT is 2.5 for plan A and 1.4 for plan B. The higher this ratio is, the more leverage a plan has. The reader should recognize from Figure 3.8 that financing plans with higher degrees of leverage have steeper slopes when plotted on EBIT -EPS axes.

The point of intersection of each plan with the EBIT axis represents the amount of earnings before interest and taxes necessary for the firm to cover its fixed financial charges, that is, the point at which $EPS = 0$. This point of intersection can be thought of a *financial break-even point* since it represents the level of EBIT necessary for the firm to break even on its fixed financial charges. The break-even EBIT for plan A is Rs. 6,000, and for plan B it is Rs. 3,000. In other words, earnings before interest and taxes of less than Rs. 6,000 with plan A or less than Rs. 3,000 with plan B will result in a loss, or negative EPS.

The point labeled X in Figure 3.2 represents, the point of intersection between plan A loss, or negative EPS. and plan B. It indicates that at a level of EBIT of Rs. 9,000, EPS of Rs. 1.50 would result under either plan. At levels of EBIT below Rs. 9,000, plan

B results in higher levels of EPS; while at levels of EBIT above Rs,9,COO, plan- A results in higher levels of EPS. The usefulness of this type of analysis is discussed in Chapter on Capital Structure while discussing methods of evaluating financing plans.

Combined Leverage

The operating leverage has its effects on operating risk and is measure by the percentage change in EBIT due to percentage change in sales. The financial leverage has its effects on financial risk and is measured by rthe percentage change in EPS due t percentage change in EBIT. Since both these leverages are closely concerned with ascertaining the ability to cover fixed charges (fixed-operating costs in the case of operating leverage and fixed-financial costs in the case of financial leverage), if they are combined, the result is total leverage and the risk associated with combined leverage is known as total risk. Symbolically,

$$DCL = DOL \times DFL \quad (14.11)$$

Where DCL = Degree of combined leverage

DOL = Degree of operating leverage

DFL = Degree of financial leverage

Substituting the values of DOL and DFL, we have:

$$\frac{\% \text{ change in EBIT}}{\% \text{ change in sales}} \times \frac{\% \text{ change in EPS}}{\% \text{ change in EBIT}} = DCL$$

$$DCL = \frac{\% \text{ change in EBIT}}{\% \text{ change in sales}}$$

$$DCL = \frac{\text{Contribution}}{\text{EBIT}} \times \frac{\text{EBIT}}{\text{EBIT} - 1} \frac{\text{Contribution}}{\text{EBIT} - 1}$$

Thus, the DCL measures the percentage change in EPS due to percentage change in sales. If the degree of operating leverage of a firm is 6 and its financial leverage is 2.5, the combined leverage of this a firm would be 15(6 X 2.5). That is, 1 per cent change in sales would bring about 15 per cent change in EPS in the direction of the change in sales. The combined leverage can work in either direction. It will be favourable if sales increase and unfavourable when sales decrease because changes in sales will result in more than proportionate returns in the form of EPS.

The usefulness of DCL lies in the fact that it indicates the effect that sales changes will have on EPS. Its potential is also great in the area of choosing financial plans for new investments. If, for example, a firm begins to invest heavily in more risky assets than usual, the operating leverage will obviously increase. If it does not change its financing

policy, that is, the capital structure remains constant, there would be no change in its financial leverage. As a result, the combined leverages would increase causing an increase in its total risk. The firm, in order to keep its risk constant, may like to lower its financial leverage. This could be done if the new investments are financed with more equity than the firm has used in the past. This would lower the financial leverage and compensate for the increased operating leverage caused by investment in more risky investments. If the operating leverage has decreased due to low fixed costs, the firm can afford to have a more levered financial plan to keep the total risk constant at the same time having the same prospects of magnifying effects on EPS due to change in sales.

Solved Problems

1. B Corporation is considering a new project which will require the purchase of a new machine at a cost of 250,000. The project will also require use of a machine which has been fully depreciated but which could be sold today for 30,000. In addition, the firm expects an increase in net working capital investment of 60,000 in the first year of the project. What is the incremental net investment at the outset of this project? How much of this incremental net investment will the firm be able to depreciate?

Solution

The incremental investment includes both the cash required to purchase the new machine and the after-tax disposal value of the old machine, which is calculated as follows:

$$\text{Gain on sale} = \text{Market value} - \text{Book value} = 30,000 - 0 = 30,000.$$

$$\text{Taxes on gain} = \text{Gain} \times \text{Tax rate} = (30,000)(0.40) = 12,000$$

Thus the firm's incremental investment flows are:

Cost of new machine :	250,000
Increase in net working capital	60,000
Market value of old machine	-30,000
Tax on gain of sale of old machine :	12,000
Incremental investment outlay	<u>292,000</u>

The firm's depreciable value for tax purposes will be only the 250,000 cost of the new machine. (If the old machine had remaining book value, the incremental tax basis would be reduced by the loss of this book value.)

2. The Stupid Company is considering a project requiring the purchase of a new machine costing Rs 200,000. The machine will be depreciated on a straight-line

basis over its economic life of five years. The project, however, has only a three-year life and the machine will be sold after three years for an estimated Rs 30,000. In addition, the firm will be able to recover Rs 6,000 of working capital investment. What is the after-tax cash flow in year 3 from the sale of this machine and the recovery of the working capital investment? Assume that the firm's marginal tax rate is 40 percent.

Solution

The net cash flow in the final year are after-tax cash flows, including the tax effect of any asset sale. Note that there is no tax effect on the recovery of working capital investment since the recovery involves the collection of accounts receivable and the sale of inventory which has no tax effect (other than those represented by revenues and expenses).

Gain or loss on asset sale :

Market value of asset	30,000
Less : Book value of asset [200-(3)(40)]	80,000
Loss of sale of asset	50,000
Calculating year 3 after-tax cash flows :	
Taxes saved due to loss on sale [(50)(0.40)]	20,000
Decreases in working capital investmen	6,000
Net after-tax cash flow in year 3	56,000

3. The following figures relate to two companies: *(Rs lakhs)*

	P Ltd.	Q Ltd.
Sales	500	1,000
Variable costs	<u>200</u>	<u>300</u>
Contribution	300	700
Fixed costs	<u>150</u>	<u>400</u>
	150	300
Interest	<u>50</u>	<u>100</u>
Profit before Tax	<u>100</u>	<u>200</u>

You are required to:

- (i) Calculate the operating, financial and combined leverages for the two companies; and
- (ii) Comment on the relative risk position of them.

Solution: Calculation of leverage :

$$\text{Operating leverage} = \frac{\text{Contribution}}{\text{Earning before Interest \& Tax}}$$

$$\text{P Ltd} = \frac{\text{Rs 300lakhs}}{\text{Rs.150lakhs}} = 2$$

$$\text{Q Ltd} = \frac{\text{Rs 700lakhs}}{\text{Rs.300lakhs}} = 2.33$$

$$\text{Financial leverage} = \frac{\text{Earning before Interest \& Tax}}{\text{Profit before Tax}}$$

$$\text{P Ltd} = \frac{\text{Rs 150lakhs}}{\text{Rs.100lakhs}} = 1.5$$

$$\text{Q Ltd} = \frac{\text{Rs 300lakhs}}{\text{Rs.200lakhs}} = 1.5$$

$$\text{Combined leverage} = \frac{\text{Contribution}}{\text{Earning before Tax}}$$

(i.e., Operating leverage \times Financial leverage)

$$\text{P Ltd} = \frac{\text{Rs 300lakhs}}{\text{Rs.100lakhs}} = 3$$

$$\text{Q Ltd} = \frac{\text{Rs 700lakhs}}{\text{Rs.200lakhs}} = 3.5$$

Comment on the relative risk position of P Ltd. and Q Ltd.

- (a) **Operating Leverage:** The operating leverage of Q Ltd. is higher than P Ltd.' and hence Q Ltd. is exposed to higher business risk than P Ltd. A firm will face business risk when the EBIT does not vary in direct proportion with the change in sales.
- (b) **Financial Leverage:** The financial leverage of both the companies is same i.e., 1.5.
- (c) **Combined Leverage:** When we study the overall risk of the companies, is carrying higher risk than P Ltd.

4. (i) **Find the operating leverage from the following data:**

Sales	Rs. 50,000
Variable Costs	60%
Fixed costs	Rs. 12,000

(ii) Find the financial leverage from the following data:

Net Worth	Rs. 25,00,000
Debt/Equity	3/1
interest rate	12%

Solution:

(i) Calculation of Operating level rage:

Particulars	(Rs.)
Sales	50,000
Less: Variable Costs (60% of Sales)	<u>30,000</u>
Contribution	20,000
less: Fixed Costs	<u>12,000</u>
Operating Profit	<u>8,000</u>

Operating leverage = Contribution/Operating profit
 = Rs. 20,000/Rs. 8,000 = 2.5

(ii) Calculation of Financial Leverage

Working Notes:

Calculation of debt and interest thereon:

(a) Debt	=Rs. 25,00,000 × 3	= Rs. 75,00,000
(b) Interest on debt	= Rs. 75,00,000 × 12/100	= Rs. 9,00,000

	Rs.
Operating Profit	20,00,000
Less: Interest on debt	<u>9,00,000</u>
Profit before tax	<u>11,00,000</u>

Financial Leverage = Operating profit/Profit before tax
 = Rs. 20,00,000/Rs. 11,00,000 = 1.82

5. Calculate the operating leverage, financial leverage and combined leverage from the following data under Situations I and II and Financial Plans A and B:

Installed capacity	4,00 unit
Actual Porduction and sales	75% of the Capacity
Selling Price	Rs. 30 per Unit

Variable Cost	Rs. 15 per Unit	
Fixed cost:		
Under Situation I	Rs. 15, 000	
Under Situation II	Rs. 20,000	
Capital structure:	Rs.	
Financial Plan	A	B
Equity	10,000	15,000
Debt (rate of Interest at 20%)	<u>10,000</u>	<u>5,000</u>
	<u>20,000</u>	<u>20,000</u>

Solution: (i) Calculation of Operating Leverage

Operating Leverage = (Contribution/operating profit)

	Rs.	
	Situation I	Situation II
Sales	90,000	90,000
Less: variable cost (3,00 unit@ Rs. 30 per unit)	<u>45,000</u>	<u>45,000</u>
Contribution	45,000	45,000
Less: Fixed Costs	<u>15,000</u>	<u>20,000</u>
Operating profit (EBIT)	<u>30,000</u>	<u>25,000</u>

$$\text{Operating Leverage} = \frac{\text{Rs. } 45,000}{\text{Rs. } 30,000} = 1.5 \quad \frac{\text{Rs. } 45,000}{\text{Rs. } 25,000} = 1.8$$

(ii) Calculation of financial leverage

$$\text{Financial leverage} = \frac{\text{Operating profit}}{\text{Profit before tax}}$$

Financial plan	A	B
Situation I	30,000	30,000
Operation profit		
Less: Interest on debt	<u>2,000</u>	1,000
profit before tax PBT	<u>28,000</u>	29,000
Financial leverage	=	= $\frac{\text{Rs. } 30,000}{\text{Rs. } 29,000}$
	= 1.07	= 1.04

Financial plan	A	B
Situation II	25,000	25,000
Operation profit	<u>2,000</u>	<u>1,000</u>
Less: Interest on debt	23,000	24,000
PBT		
Financial leverage =	$\frac{\text{Rs. } 25,000}{\text{Rs. } 23,000} =$	$\frac{\text{Rs. } 25,000}{\text{Rs. } 24,000} = 1.04$
	= 1.09	

(iii) Calculation of combined leverages

Combined leverage = Operating Leverage × Financial Leverage

Financial plan	A	B
Situation I	(1.5×1.07)	(1.5×1.04)
Situation II	(1.8×1.09)	(1.8×1.04)
	= 1.96	= 1.87

Chapter-4

Capital Budgeting

Meaning, Importance, rationale of capital budgeting, nature of investment decision, the administrative framework, Methods of Appraisal, Capital Rationing, Inflation and capital budgeting, Capital Budgeting under Risk and Uncertainties

Meaning, Importance & Rationale of Capital Budgeting

A firm conducts its business in a rapidly changing and highly competitive environment. The changing environment poses both opportunities and threats for the company. For example, change in Government policy may cause change in prices of inputs and outputs, demand and supply of products/services. Similarly, technology change may cause the production cost change. Also the cash inflows and outflows cannot be ascertained with accuracy. Therefore, evaluation of investment projects under uncertainty and risk become important.

Characteristically, a capital budgeting decision involves largely irreversible commitment of resources that is generally subject to a significant degree of risk. Such decisions have far reaching effects on a company's profitability and flexibility over the long-term, thus requiring that they be part of a carefully developed strategy that is based on reliable forecasting procedures.

Capital Budgeting

Capital budgeting may be defined as the decision-making process by which, firms evaluate the purchase of major fixed assets, including buildings, machinery, and equipment. It also covers decisions to acquire other firms, either through the purchase of their common stock or groups of assets that can be used to conduct an ongoing business. Capital budgeting scribes the firm's formal planning process for the acquisition and investment of capital and results in a capital budget that is the firm's formal plan for the expenditure of money to purchased assets.

A capital-budgeting decision is a two-sided process. First, the analyst must evaluate a proposed project to calculate the likely or expected return from the project. This calculation generally begins with expenditure of the project's service life and a stream of cash flowing into the firm over the life of the project. The calculation of expected, turn may be done by two methods: a *internal rate of return*, or (b) *net present value*, These two methods are discussed later in this unit.

The second side of a capital-budgeting decision is to determine the required return from a project. We may calculate the likely return to be 12 percent but the question is whether this is good enough for the proposal to be accepted. In order to determine whether the return is adequate, the analyst must evaluate the degree of risk in the project and then must calculate the, required return for the given risk level. Two techniques may be used to perform this analysis. The *weighted-average cost of capital* is used when the new proposal is assumed to have the same degree of risk as the firm's existing activities. The *capital asset pricing model* is used if the risk in the project is viewed *as* different from the firm's current risk level.

Capital budgeting is important for the future well-being of the firm; it is also a complex, conceptually difficult topic. As we shall see later in this chapter, the optimum capital budget—the level of investment that maximizes the present value of the firm—is simultaneously determined by the interaction of supply and demand forces under conditions of uncertainty. Supply forces refer to the supply of capital, the firm or its *cost of capital schedule*. Demand forces relate to the investment opportunities open to the firm, as measured by the *stream of revenues* that will result from an investment decision. *Uncertainty* enters the decision because it is impossible to know exactly either the cost of capital or the stream of revenues that will be derived from a project.

Significance of Capital Budgeting

A number of factors combine to make capital budgeting perhaps the most important decision with which financial management is involved. Further, a department of a firm—production, marketing, and so on, are vitally affected by the capital budgeting decisions, so all executives, no matter what their primary responsibility, must be aware of how capital budgeting decisions are made. These points are discussed in this section.

Long Term Effects

First and foremost, the fact that the results continue over an extended period means that the decision maker loses some of his flexibility. He must make a commitment into the future. For example, the purchase of an asset with an economic life of ten years requires a long period of waiting before the final results of the action can be known. The decision maker must commit funds for this period, and, thus, he becomes a hostage of future events.

Asset expansion is fundamentally related to expected future sales. A decision to buy or to construct a fixed asset that is expected to last five years involves an implicit five-year sales forecast. Indeed, the economic life of a purchased asset represents an implicit forecast for the duration of the economic life of the asset. Hence, failure to forecast accurately will result in over investment or under investment in fixed assets.

An erroneous forecast of asset requirements can result in serious consequences. If the firm has invested too much in assets, it will incur unnecessarily heavy expenses. If it

has not spent enough on fixed assets, two serious problems may arise. First, the firm's equipment may not be sufficiently modern to enable it to produce competitively. Second, if it has inadequate capacity, it may lose a portion of its share of the market to rival firms. To regain lost customers typically requires heavy selling expenses, price reduction, product improvements, and so forth.

Timing the Availability of Capital Assets

Another problem is to phase properly the availability of capital assets in order to have them come "on stream" at the correct time. For example, the executive vice-president of a decorative tile company gave the authors an illustration of the importance of capital budgeting. His firm tried to operate near capacity most of the time. For about four years there had been intermittent spurts in the demand for its product; when these spurts occurred, the firm had to turn away orders. After a sharp increase in demand, the firm would add capacity by renting an additional building, then purchasing and installing the appropriate equipment. It would take six to eight months to have the additional capacity ready. At this point the company frequently found that there was no demand for its increased output—other firms had already expanded their operations and had taken an increased share of the market, with the result that demand for this firm had leveled off. If the firm had properly forecast demand and had planned its increase in capacity six months or one year in advance, it would have been able to maintain its market—indeed, to obtain a larger share of the market.

Quality of Capital Assets

Good capital budgeting will also improve the timing of asset acquisitions and the quality of assets purchased. This situation follows from the nature of capital goods and their producers. Firms do not order capital goods until they see that sales are beginning to press on capacity. Such occasions occur simultaneously for many firms. When the heavy orders come in, the producers of capital goods go from a situation of idle capacity to one where they cannot meet all the orders that have been placed. Consequently, large backlogs accumulate. Since the production of capital goods involves a relatively long work-in-process period, a year or more of waiting may be involved before the additional capital goods are available. This factor has obvious implications for purchasing agents and plant managers.

Asset expansion is fundamentally related to expected future sales. A decision to buy or to construct a fixed asset that is expected to last five years involves an implicit five-year sales forecast. Indeed, the economic life of a purchased asset represents an implicit forecast for the duration of the economic life of the asset. Hence, failure to forecast accurately will result in over investment or under investment in fixed assets.

An erroneous forecast of asset requirements can result in serious consequences. If the firm has invested too much in assets, it will incur unnecessarily heavy expenses. If it has not spent enough on fixed assets, two serious problems may arise. First, the firm's

equipment may not be sufficiently modern to enable it to produce competitively. Second, if it has inadequate capacity, it may lose a portion of its share of the market to rival firms. To regain lost customers typically requires heavy selling expenses, price reduction, product improvements, and so forth.

Timing the Availability of Capital Assets

Another problem is to phase properly the availability of capital assets in order to have them come “on stream” at the correct time. For example, the executive vice-president of a decorative tile company gave the authors an illustration of the importance of capital budgeting. His firm tried to operate near capacity most of the time. For about four years there had been intermittent spurts in the demand for its product; when these spurts occurred, the firm had to turn away orders. After a sharp increase in demand, the firm would add capacity by renting an additional building, then purchasing and installing the appropriate equipment. It would take six to eight months to have the additional capacity ready. At this point the company frequently found that there was no demand for its increased output—other firms had already expanded their operations and had taken an increased share of the market, with the result that demand for this firm had leveled off. If the firm had properly forecast demand and had planned its increase in capacity six months or one year in advance, it would have been able to maintain its market—indeed, to obtain a larger share of the market.

Quality of Capital Assets

Good capital budgeting will also improve the timing of asset acquisitions and the quality of assets purchased. This situation follows from the nature of capital goods and their producers. Firms do not order capital goods until they see that sales are beginning to press on capacity. Such occasions occur simultaneously for many firms. When the heavy orders come in, the producers of capital goods go from a situation of idle capacity to one where they cannot meet all the orders that have been placed. Consequently, large backlogs accumulate. Since the production of capital goods involves a relatively long work-in-process period, a year or more of waiting may be involved before the additional capital goods are available. This factor has obvious implications for purchasing agents and plant managers.

Raising Funds

Another reason for the importance of capital budgeting is that asset expansion typically involves substantial expenditures. Before a firm spends a large amount of money, it must make the proper plans—large amounts of funds are not available automatically. A firm contemplating a major capital expenditure program may need to arrange its financing several years in advance to be sure of having the funds required for the expansion.

Raising Funds Another reason for the importance of capital budgeting is that asset expansion typically involves substantial expenditures. Before a firm spends a large

amount of money, it must make the proper plans-large amounts of fund are not available automatically. A firm contemplating, major capital expenditure program may need to arrange its financing several years in advance to be sure of having the funds required for the expansion.

Ability to Compete

Finally, it has been said with a great deal of truth that many firms fail, not because they have too much capital equipment but because they have too little. While the conservative approach of having a small amount of capital equipment may be appropriate at times, such an approach may also be fatal if a firm's competitors install modern, automated equipment that permits them to produce a better product and sell it at a lower price. The same thing also holds true for nations: If United States firms fail to modernize but those of other nations do, then the u.s. will not be able to compete in world markets Thus, an understanding of business investment behavior and of factors that motivate firms to undertake investment programs is vital for congressional leaders and others involved in governmental policy making.

Application of the Concept

At the applied level, the capital budgeting process is much more complex than what it looks. Projects do not just appear, a continuing stream of good investment opportunities results from hard thinking, careful planning, and, often, large outlays for research and development Moreover, some very difficult measurement problems are involved: the sales and costs associated with particular projects must be estimated, frequently many years into the future, in the face of great uncertainty. Finally, some difficult conceptual and empirical problems arise over the methods of calculating rates of return and the cost of capital.

Businessmen are required to take action, however, even in the face of the kinds of problems described; this requirement has led to the development of procedures that assist in making optimal investment decisions.

Difficulties in Capital Budgeting

While capital expenditure decisions are extremely important, they also pose difficulties, which stem from three principal sources:

- **Measurement Problems** Identifying and measuring the costs and benefits of a capital expenditure proposal tends to be difficult. This is more so when a capital expenditure has a bearing on some other activities of the firm (like cutting into the sales of some existing product) or has some intangible consequences (like improving the morale of workers).
- **Uncertainty** A capital expenditure decision involves costs and benefits that extend far into future. It is impossible to predict exactly what will happen in future. Hence, there is usually a great deal of uncertainty characterizing the costs and benefits of a capital expenditure decision.

- **Temporal Spread** The costs and benefits associated with a capital expenditure decision are spread out over a long period of time, usually years for industrial projects and 20-50 years for infrastructural projects. Such a temporal spread creates some problems in estimating discount rates and establishing equivalences.

Project Classification

Project analysis entails time and effort. The costs incurred in this exercise must be justified by the benefits from it. Certain projects, given their complexity and magnitude, may warrant a detailed analysis while others may call for a relatively simple analysis. Hence firms normally classify projects into different categories. Each category is then analysed somewhat differently.

While the system of classification may vary from one firm to another, the following categories are found in most classifications.

Mandatory Investment These are expenditures required to comply with statutory requirements. examples of such investments are pollution control equipment, medical dispensary, fire fitting equipment, clr5che in factory premises, and so on. These are often non-revenue producing investments. In analyzing such investments the focus is mainly on finding the most cost-effective way of fulfilling a given statutory need.

Replacement Projects Firms routinely invest in equipments meant to replace Obsolete and inefficient equipments, even though they may be in a serviceable condition. The objective of such investments is to reduce costs (of labor, raw material, and power), increase yield, and improve quality. Replacement projects can be evaluated in a fairly straightforward manner, though at times the analysis may be quite detailed.

Expansion Projects These investments are meant to increase capacity and/or widen the diistribution network. Such investments call for an explicit forecast of growth. Since this can be risky and complex, expansion projects normally warrant more careful analysis than replacement projects Decision relating to such projects are taken by the top management.

Diversification Projects These investments are aimed at producing new products or Services or entirely new geographical areas. Often diversiftcation projects entail substantial risks, involve large outlays, and require considerable managerial effort and attention. Given their strategic importance, such projects call for a very thorough evaluation, both quantitative and qualitative. Further, they require a significant involvement of the board of directors.

Research and Development Projects R&D projects absorbed a very Small proportion of capital budget in most Indian companies. Things, however, are changing. Companies are now allocating mote funds to R&D projects, more so in knowledge-intensive

industries. R&D projects are characterized by numerous uncertainties and typically involve sequential decision-making. Hence the standard DCF analysis is not applicable to them. Such projects are decided on the basis of managerial judgment. Firms, which rely more on quantitative methods, use decision tree analysis and option analysis to evaluate R&D projects.

Miscellaneous Projects This is a catch-all category that includes items like interior Decoration, recreational facilities, executive aircrafts, landscaped gardens, and so on.

There is no standard approach for evaluating these projects and decisions regarding them are based on personal preferences of top management.

Rationale

The rationale underlying the capital budgeting decision is efficiency. Thus, a firm must replace worn and obsolete plants and machinery, acquire fixed assets for current and new products and make strategic investment decisions. This will enable the firm to achieve its objective of maximizing profits either by way of increased revenues or cost reductions. The quality of these decisions is improved by capital budgeting. Capital budgeting decision can be of two types: (i) those which expand revenues, and (ii) those which reduce costs.

Investment Decision Affecting Revenues. Such investment decisions are expected to bring in additional revenue, thereby raising the size of the firm's total revenue. They can be the result of either expansion of present operations or the development of new product lines. Both types of investment decisions involve acquisition of new fixed assets and are income-expansionary in nature in the case of manufacturing firms.

Investment Decisions Reducing Costs Such decisions, by reducing costs, add to the earnings of firm. A classic example of such investment decisions is the replacement proposals when an asset wears out or becomes outdated. The firm must decide whether to continue with the existing assets or replace them. The firm evaluates the benefits from the new machine in terms of lower operating cost and the outlay that would be needed to replace the machine. An expenditure on a new machine may be quite justifiable in the light of the total cost savings that result.

A fundamental difference between the above two categories of investment decision lies in the fact that cost-reduction investment decisions are subject to less uncertainty in comparison to the revenue-affecting investment decisions. This is so because the firm has a better 'feel' for potential cost savings as it can examine past production and cost data. However, it is difficult to precisely estimate the revenues and costs resulting from a new product line, particularly when the firm, knows relatively little about the same.

Nature of Investment Decision

Typical examples of capital budgeting decisions are:

- expansion projects;
- replacement projects;
- selection among alternatives; and
- buy or lease decisions.

Good capital budgeting decisions, based on sound investment appraisal procedures, should improve the timing of capital acquisitions as well as the quality of capital acquisitions.

Investment in expansion/ modernisation is one of the main sources of economic growth, since it is required not only to increase the total capital stock of equipment and buildings, but also to employ labour in increasingly productive jobs as old plant is replaced by new.

The Administrative Framework

Successful administration of capital investments by a company involves

1. Generation of investment proposals
2. Estimation of cash flows for the proposals
3. Evaluation of cash flows
4. Selection of projects based upon an acceptance criterion
5. Continual reevaluation of investment projects after their acceptance

Depending upon the firm involved, investment proposals can emanate from various sources. For purposes of analysis, projects may be classified into one of five categories.

1. New products or expansion of existing products
2. Replacement of equipment or buildings
3. Research and development
4. Exploration
5. Others

The fifth category comprises miscellaneous items such as the expenditure of funds to comply with certain health standards or the acquisition of a pollution-control device. For a new product, the proposal usually originates in the marketing department. On the other hand a proposal to replace a piece of equipment with a more sophisticated model usually emanates from the production area of the firm, in each case, efficient administrative procedures are needed for channeling in-

Most firms screen proposals at multiple levels of authority. For a proposal originating in the production area, the hierarchy of authority might run from (1) section chiefs to

(2) plant managers to (3) the vice-president for operations to (4) a capital expenditures committee under the financial manager to (5) the president to (6) the board of directors. How high a proposal must go before it is finally approved usually depends upon its size. The greater the capital outlay, the greater the number of screens usually required. Plant managers may be able to approve moderate-sized projects on their own, but only higher levels of authority approve larger ones. Because the administrative procedures for screening investment proposals vary greatly from firm to firm, it is not possible to generalize. The best procedure will depend upon the circumstances.

The level and type of capital expenditure appear to be important to investors, as they convey information about the expected future growth of earnings. John J. McConnell and Chris J. Muscarelia test this notion with respect to the level of expenditures of a company. They find that an increase in capital-expenditure intentions, relative to prior expectations, results in increased stock returns around the time of the announcement, and vice versa for an unexpected decrease.

Investment Ideas: Who Generates?

Investment opportunities have to be identified or created; they do not occur automatically? Investment proposals of various types may originate at different levels within a firm. Most proposals, in the nature of cost reduction or replacement or process or product improvement take place at plant level. The contribution of top management in generating investment ideas is generally confined to expansion or diversification projects. The proposals may originate systematically or haphazardly in a firm. The proposal for adding a new product may emanate from the marketing department or from the plant manager who thinks of a better way of utilizing idle capacity. Suggestions for replacing an old machine or improving the production techniques may arise at the factory level. In view of the fact that enough investment proposals should be generated to employ the firm's funds fully well and efficiently, a systematic procedure for generating proposals may be evolved by a firm.

In a number of Indian 'companies, more than 50 per cent of the investment ideas are generated at the plant level. The contribution of the board in idea generation is relatively insignificant. However, some companies depend on the board for certain investment ideas. Other companies depend on research centers for investment ideas.

Is the investment idea generation primarily a bottom-up process in India? In UK, both bottom up as well as top-down processes exist.⁴ The Indian practice is more like that in USA. Petty and Scott's study (1981) showed that project initiation was a bottom-up process in USA, with about 82 per cent of investment proposals coming from divisional management and plant personnel. ⁵ However, it is to be noted that the small number of ideas generated at the top may represent a high percentage in terms of investment value, so that what looks to be an entirely bottom-up process may not be really so.

Indian companies use a variety of methods to encourage idea generation. The most common methods used are: (a) management sponsored studies for project identification, (b) formal suggestion schemes, and (c) consulting advice. Most companies use a combination of methods. The offer of financial incentives for generating investment idea is not a popular practice. Other efforts employed by companies in searching investment ideas are: (a) review of researches done in the country or abroad, (b) conducting market surveys, and (c) deputing executives to international trade fairs for identifying new products/technology.

Once the investment proposals have been identified, they could be submitted for scrutiny any time. However, some companies do specify a submission time.

Developing Cash Flow Estimation

Estimation of cash flows is a difficult task because the future is uncertain. Operating managers with the help of finance executives should develop cash now estimates. The risk associated with cash flows should also be properly handled and should be taken into account in the decision process. Estimation of cash flows requires collection and analysis of all qualitative and quantitative data, both financial and non-financial in nature. Large companies would have a management information system providing such data.

Executives in practice do not always have clarity about estimating cash flows. A large number of companies do not include additional working capital while estimating the investment project cash flows. A number of companies also mix up financial flows with operating flows. Although the companies claim to estimate cash flows on incremental basis, some of them make no adjustment for sale proceeds of existing assets while computing the project's initial cost.

Most Indian companies choose an arbitrary period of 5 or 10 years for forecasting cash flows. This was because companies in India largely depended on government-owned financial institutions for financing their projects, and these institutions required 5 to 10 years forecasts of the project Cash flows.

Evaluation

The evaluation of projects should be performed by a group of experts who have no axe to grind. For example, the production people may be generally interested in having the most modern type of equipments and increased production even if productivity is expected to be low and goods cannot be sold. This attitude can bias their estimates of cash flows of the proposed projects. Similarly, marketing executives may be too optimistic about the sales prospects of goods manufactured, and overestimate the benefits of a proposed new product. It is therefore, necessary to ensure that an impartial group scrutinizes projects and that objectivity is maintained in the evaluation process.

A company in practice should take all care in selecting a method or methods of investment evaluation. The criterion or criteria selected should be a true measure of evaluating if the investment is profitable (in terms of cash flows), and it should lead to the net increase in the company's wealth (that is, its benefits should exceed its cost adjusted for time value and risk). It should also be seen that the evaluation criteria do not discriminate between the investment proposals. They should be capable of ranking projects correctly in terms of profitability. The net present value method is theoretically the most desirable criterion as it is a true measure of profitability; it generally ranks projects correctly and is consistent with the wealth maximisation criterion. In practice, however, managers' choice may be governed by other practical considerations also.

A formal financial evaluation of proposed capital expenditures has become a common practice among companies in India. A number of companies have a formal financial evaluation of almost three-fourths of their investment projects. Most companies subject more than 50 per cent of the projects to some kind of formal evaluation. However, projects, such as replacement or worn-out equipment, welfare and statutorily required projects below certain limits, small value items like office equipment or furniture, replacement of assets of immediate requirements, etc., are not often formally evaluated.

Methods of Evaluation

As regards the use of evaluation methods, most Indian companies, use payback criterion. In addition to payback and/or other methods, some companies also use internal rate of return (IRR) and net present (NPV) methods. A few companies use accounting rate of return (ARR) method. IRR is the second most popular technique in India.

The major reason for DCF techniques not being as popular as payback is the lack of familiarity with DCF on the part of executives. Other factors are lack of technical people and sometimes unwillingness of top management to use the DCF techniques. One large manufacturing and marketing organisation, for example, thinks that conditions of its business are such that the DCF techniques are not needed. By business conditions the company perhaps means its marketing nature, and its products being in seller's markets. Another company feels that replacement projects are very frequent in the company, and therefore, it is not necessary to use DCF techniques for such projects.

The practice of companies in India regarding the use of evaluation criteria is similar to that in USA. A study by Schall, Sundem and Geiljsbeak (1978) showed that whereas 86 per cent of the firms used either the internal rate of return or net present value models, only 16 per cent used such discounting techniques without using the payback period or average rate of return methods. The tendency of US firms to use naive techniques as supplementary tools has also been reported in other studies. However, firms in USA have come to depend increasingly on the DCF techniques, particularly IRR. According to Rockley's study (1973) the British companies use both DCF

techniques and return on capital, sometimes in combination and sometimes solely, in their investment evaluation; the use of payback is wide-spread. A recent study by Pike shows that the use of the DCF methods has significantly increased in UK in 1992, and NPV is more popular than IRR. However, this increase has not reduced the importance of the traditional methods such as payback and return on investment. Payback continues to be employed by almost all companies.

One significant difference between practices in India and USA is that payback is used in India as a 'primary' method and IRR/NPV as a 'secondary' method, while it is just the reverse in USA. Indian managers feel that payback is a convenient method of communicating an investment's desirability, and it best protects the recovery of capital—a scarce commodity in the developing countries.

Cut-off Rate

In the implementation of a sophisticated evaluation system, the use of a minimum required rate of return is necessary. The required rate of return or the opportunity cost of capital should be based on the riskiness of cash flows of the investment proposal; it is compensation to investors for bearing the risk in supplying capital to finance investment proposals.

Not all companies in India specify the minimum acceptable rate of return. Some of them compute the weighted average cost of capital (WACC) as the discount rate. WACC is defined either as: (i) after-tax cost of debt \times weight + after-tax cost of equity \times weight (cost of equity is taken as 25 per cent (a judgmental number) and weights are in proportion to the sources of capital used by a specific project); (ii) (after tax cost of borrowing \times borrowings + dividend rate \times equity) divided by total capital.

Business executives in India are becoming increasingly aware of the Importance of the cost of capital, but they perhaps lack clarity among them about its computation. Arbitrary judgment of management also seems to play a role in the assessment of the cost of capital. The fallacious tendency of equating borrowing rate with minimum rate of return also persists in the case of some companies. In USA, a little more than 50 per cent companies have been found using WACC as cut-off rate. In UK, only 14 per cent firms were found to attempt any calculation of the cost of capital. As in USA and UK, companies in India have a tendency to equate the minimum rate with interest rate or cost of specific source of finance. The phenomenon of depending on management judgement for the assessment of the cost of capital is prevalent as much in USA and UK as in India.

Recognition of Risk

The assessment of risk is an important aspect of an investment evaluation. In theory, a number of techniques are suggested to handle risk. Some of them, such as the computer simulation technique are not only quite involved but are also expensive to use. How do companies handle risk in practice?

Companies in India consider the following as the four most important contributors of investment risk: selling price, product demand, technological changes and government policies. India is fast changing from sellers' market to buyers' market as competition is intensifying in a large number of products; hence uncertainty of selling price and product demand are being realised as important risk factors. Uncertain government policies (in areas such as custom and excise duty and import policy), of course, is a continuous source of investment risk in developing countries like India.

Sensitivity analysis and *conservative forecasts* are two equally important and widely used methods of handling investment risk in India. Each of these techniques is used by a number of Indian companies with other methods while many other companies use either sensitivity analysis or conservative forecasts with other methods. Some companies also use shorter payback and inflated discount rates (risk-adjusted discount rates).

In US risk adjusted discount rate is used by 90 per cent companies while only 10 per cent use payback and sensitivity analysis. This is also confirmed by another US study by Petty and Scott (1981). In Rockley's survey of the British companies only one firm out of 69 used sensitivity analysis.³ The contrasts in risk evaluation practices in India, on the one hand, and USA and UK, on the other, are sharp and significant. Given the complex nature of risk factors in developing countries, risk evaluation cannot be handled through a single number such as NPV calculation based on conservative forecasts or risk-adjusted discount rate. Managers must know the impact on project profitability of the full range of critical variables. Hastie, an American businessman, strongly advocates the use of sensitivity analysis for risk handling and casts doubt on the survey results in USA. He states: 'there appear to be more corporations using sensitivity analysis than surveys indicate. In some cases firms may not know that what they are undertaking is called 'sensitivity analysis', and it probably is not in the sophisticated, computer oriented sense.....Typically, analysts or middle managers eliminate the alternative assumptions and solutions in order to simplify the decision making process for higher management'

Capital Rationing

Indian companies, by and large, do not have to reject profitable investment opportunities for lack of funds, despite the capital markets not being so well developed. This may be due to the existence of the government-owned financial system which is always ready to finance profitable projects. Indian companies do not use any mathematical technique to allocate resources under capital shortage which may sometimes arise on account of internally imposed restrictions or management's reluctance to raise capital from outside. Priorities for allocating resources are determined by management, based on the strategic need for and profitability of projects.

Authorization

It may not be feasible in practice to specify standard administrative procedures for approving investment proposals. Screening and selection procedures may differ from one company to another. When large sums of capital expenditures are involved, the authority for the final approval may rest with top management. The approval authority may be delegated for certain types of investment projects. Delegation may be affected subject to the amount of outlay, prescribing the selection criteria and holding the authorized person accountable for results.

Funds are appropriated for capital expenditures after the *final* selection of investment proposals. The formal plan for the appropriation of funds is called the *capital budget*. Generally, the senior management tightly controls the capital expenditures. Budgetary controls may be rigidly exercised, particularly when a company is facing liquidity problem. The expected expenditure should become a part of the annual capital budget, integrated with the overall budgetary system.

Top management should ensure that funds are spent in accordance with appropriations made in the capital budget. Funds for the purpose of project implementation should be spent only after seeking formal permission from the financial manager or any other authorized person.

In India, as in UK, the power to commit a company to specific capital expenditure and to examine proposals is limited to a few top corporate officials. However, the duties of processing the examination and evaluation of a proposal are somewhat spread throughout the corporate management staff in case of a few companies.

Senior management tightly control capital spending. *Budgetary control* is also exercised rigidly. The expected capital expenditure proposals invariably become a part of the annual capital budget in all companies. Some companies also have formal long-range plans covering a period of 3 to 5 years. Some companies feel that long-range plans have a significant influence on the evaluation and I funding of capital expenditure proposals.

Qualitative Factors and Judgement

In theory, the use of sophisticated techniques is emphasized since they maximise value to shareholders. In practice, however, companies, although tending to shift to the formal methods of evaluation, give considerable importance to qualitative factors. Most companies in India are guided, one time or other, by three qualitative factors: *urgency*, *strategy*, and *environment*. All companies think that urgency is the most important consideration while a large number thinks that strategy plays a significant role. Some companies also consider intuition, security and social considerations as important qualitative factors. Qualitative factors like employees' morals and safety, investor and

customer image, or companies in USA consider legal matters important in investment analysis.

Due to the significance of qualitative factors, judgment seems to play an important role. Some typical responses of companies about the role of judgment are:

- Vision of judgment of the future plays an important role. Factors like market potential, possibility of technology change, trend of government policies etc., which are judgmental, play important role.
- The opportunities and constraints of selecting a project, its evaluation of qualitative and quantitative factors, *and* the weightage on every bit of pros and cons, cost-benefit analysis, etc., are essential elements of judgment. Thus, it is inevitable for any management decision.
- Judgment and intuition should definitely be used when a decision of choice has to be made between two or more, closely beneficial projects, or when it involves changing the long-term strategy of the company. For routine matters, liquidity and profits should be preferred over judgment.
- It (judgment) plays a very important role in determining the reliability of figures with the help of qualitative methods as well as other known financial matters affecting the projects.

We feel that what businessmen call intuition or (simply) judgment is in fact informed judgment based on experience. A firm growing in a favourable economic environment will be able to identify profitable opportunities without making NPV or IRR computation. Businessmen often act more intelligently than they talk.

Strategic Aspects of Investment Decision

Recently, a lot of emphasis has been placed on the view that a business firm facing a complex and changing environment will benefit immensely in terms of improved quality of decision-making if capital budgeting decisions are taken in the context of its overall strategy. This approach provides the decision-maker with a central theme or a big picture to keep in mind at all times as a guideline for effectively allocating corporate financial resources. As argued by a chief financial officer: Allocating resources to investments without a sound concept of divisional and corporate strategy is a lot like throwing darts in a dark room.

A businessman argues as follows:

We have erred too long by exaggerating the 'improvement in decision-making' that might result from the adoption of DCF or other refined evaluation techniques. What is needed are approximate answers to the precise problems rather than precise answer to the approximate problems

There is little value in refining an analysis that does not consider the most appropriate alternative and does not utilise sound. Management should spend its time improving the quality of assumptions and assuring that all the strategic questions have been asked rather than implementing and using more refined evaluation techniques. (Emphasis added).

In fact a close linkage between capital expenditure, at least major ones, and strategic positioning exists which has led some researchers to conclude that the set of problems companies refer to as capital budgeting is a task for general management rather than financial analyst. Some recent empirical works amply support the practitioners concern for strategic considerations in capital expenditure planning and control. It is therefore a myopic point of view to ignore strategic dimensions or to assume that they are separable from the problem of efficient resource allocations addressed by capital budgeting theory.

Most companies in India consider strategy as an important factor in investment evaluation. What are the specific experiences of the companies in India in this regard? Examples of six companies showing how they defined their corporate strategy are given as follows:

- To remain market leader by highest quality and remunerative prices. This company undertook the production of a new range of product (which was marginally profitable) for competitive reasons.
- To have moderate growth for saving taxes and to set up plants for forward and backward integration.
- Our strategy is to grow, diversify and expand in related fields of technology only. Any project, which is within the strategy and satisfied profitability yardsticks, is accepted. This company found a low-profit chemical production proposal acceptable since it came within its technological capabilities.
- Strategy involves analysis of the company's present position, nature of its relationship with the environmental forces, company's evaluation of company's strong and weak points.
- To take up new projects for expansion in the fields which are closer to present project/technology. This company rejected a profitable project (of deep sea fishing and ship budding) while it accepted a marginally profitable project (of paint systems) since it was very close to its current heat transfer technology.
- To stay in industrial intermediate and capital goods line, and in the process to achieve threefold profits in real terms over a 5-year period. This company rejected a highly profitable project (of manufacturing mopeds) since it was a consumer durable and accepted a marginal project.

One more example is that of an Indian subsidiary of a giant multinational that looks for projects in high technology, priority sector. This company even sold one of its profitable non-priority sector division to a sister concern to maintain its high-tech priority sector profile.

Strategic management has emerged as a systematic approach in properly positioning companies in the complex environment by balancing multiple objectives. In practice, therefore, a comprehensive capital expenditure planning and control system will not simply focus on profitability, as assumed by modern finance theory, but also on growth, competition, balance of products, total risk diversification, and managerial capability. There are umpteen examples in the developing countries Like India where unprofitable ventures are not divested even by the private sector companies because of their desirability from the point of view of consumer and employees, in particular and society, in general. Such considerations are not at all less important than profitability since the ultimate legitimating and survival of companies (and certainly that of management) hinges on them. One must appreciate the dynamics of complex forces influencing resource allocation in practice; it is not simply the use of the most refined DCF techniques.

Certain other practical considerations are as follows:

- Apart from the profitability of the project, other features like its (project's) critical utility in the production of the main product, strategic importance of capturing the new product first, adapting to the changing market environments, have a definite bearing on investment decisions. Technological developments play a critical role in guiding investment decisions. Government policies and concessions also have a bearing on these.
- Investment in production equipment is given top priority among the existing products and the new project. Capital investment for expansion in existing lines where market potential is proved is given first priority. Capital investment in new projects is given the next priority. Capital investment for buildings, furniture, cars, office equipments etc., is done on the basis of availability of funds and immediate needs.

These statements reinforce the need for a strategic framework for problem-solving under complexities and the relevance of strategic considerations in investment planning. It also implies that resource allocation is not simply a matter of choosing most profitable new projects. What is being stressed is that the strategic framework provides a higher level screening and an integrating perspective to the whole system of capital expenditure planning and control. Once strategic questions have been answered, investment proposals may be subjected to DCF evaluation.

Capital Budgeting Decision-making levels

For planning and control purposes, three levels of decision-making have been identified:

- operating
- administrative, and
- strategic.

Capital budgeting could be categorized into those three levels.

Operating capital budgeting may include routine minor expenditures, such as on office equipment, and lower level management can easily handle it.

Strategic capital budgeting involves large investments such as acquisition of new business or expansion in a new line of business. Strategic investment are unique and unstructured, and they cast a significant influence on the direction of the business. Top management therefore, generally handles such investments.

Administrative capital budgeting falls in-between these two levels. It involves medium-size investments such as expenditure on expansion of existing line of business. Administrative capital budgeting decisions are semi-structured in nature, and can be handled by middle management.

Keeping in view the different decision-making levels, capital expenditures could be classified in a way which would reflect the appropriate managerial efforts to be placed in planning and controlling them. One useful classification (i) strategic projects, (ii) expansion in the new line of business, (iii) general replacement projects, (iv) expansion in the existing line of business, and (v) statutory required and welfare projects. Further, each of these categories could be sub-classified according to funds required by the projects.

Chapter-5

Capital Budgeting Evaluation Techniques

Methods of Appraisal

Investment appraisal methods can be divided into two basic areas. One in which no time value of money is taken into consideration and one in which it is. Using time value of money while evaluating projects is known as discounting.

- A. Non-Discounting Methods
 - Urgency
 - Payback Period
 - Accounting Rate of Return
 - Debt Service Coverage Ratio
- B. Discounting Methods
 - Net Present Value
 - Profitability Index
 - Internal Rate of Return
- C. Economic Value Added (EVA) charm as a Performance Measure

Non-discounting Methods

Urgency

According to this criteria, projects which are deemed to be more urgent get priority over projects which are regarded as less urgent.

The problem with this criterion is: How can the degree of urgency be determined? In certain situations, of course, it may not be difficult to identify highly urgent investments. For example, some minor equipment may have to be replaced immediately due to failure, to ensure continuity of production. Non-replacement of such equipment may mean considerable losses arising from stoppage in production. It may be futile in such a case to go into detailed analysis and delay decision.

In view of these limitations of the urgency criterion, we suggest that in general it should not be used for investment decision making. In exceptional cases, where genuine urgency exists, it may be used provided investment outlays are not significant.

Payback Period

Payback period is the most widely used technique and can be defined as the number of years required to recover the cost of the investment. This is easy to calculate, but is often calculated before tax, and always after accounting depreciation. By definition, the payback period ignores income beyond this period, and it can thus be seen to be more as a measure of liquidity than of profitability.

The payback period is the length of time required to recover the initial cash outlay on the project. For example, if a project involves a cash outlay of Rs 6,00,000 and generates cash inflows of Rs 1,00,000, Rs 1,50,000, Rs 1,50,000 and Rs 2,00,000 in the first, second, third and fourth years respectively, its payback period is four years because the sum of cash inflows during four years is equal to the initial outlay. When the annual cash inflow is a constant sum, the payback period is simply the initial outlay divided by the annual cash inflow. For example, a project which has an initial cash outlay of Rs 10,00,000 and constant annual cash inflow of Rs 3,00,000 has a payback period of Rs. $10,00,000/Rs\ 3,00,000 = 3.1/3$ years.

According to the payback criteria, the shorter the payback period, the more desirable the project. Firms using this criterion, generally specify the maximum acceptable payback period. If this is n years, projects with a payback period of n years or less are deemed worthwhile, and projects with a payback period exceeding n years are considered unworthy.

Projects with long payback periods are characteristically those involved in long range planning, and which determine a firm's future. However, they may not yield their highest returns for a number of years and the result is that the payback method is biased against the very investments that are most important to long term success.

Evaluation

A widely used investment criterion, the payback period seems to offer the following advantages.

- It is simple, both in concept and application. It does not use complex concepts and tedious calculations and has few hidden assumptions.
- It is a rough and ready method for dealing with risk. It favours projects which generate substantial cash inflows in earlier years and discriminates against projects which bring substantial cash inflows in later years but not in earlier years. Now, if risk tends to increase with futurity - in general, this may be true - the payback criterion may be helpful in weeding out risky projects.
- Since it emphasises earlier cash inflows, it may be a sensible criterion when the firm is pressed with problems of liquidity.

The limitations of the payback criteria, however, are very serious:

- It fails to consider the time value of money. Cash inflows, in the payback calculation, are simply added without suitable discounting. This violates the most basic principle of financial analysis which stipulates that cash flows occurring at different points of time can be added or subtracted only after suitable compounding / discounting.
- It ignores cash flows beyond the payback period. This leads to discrimination against projects which generate substantial cash inflows in later years. To illustrate, consider the cash flows of two projects, A and B:

Year	Cash flow of A	Cash flow of B
0	-1,00,000	-1,00,000
1	50,000	20,000
2	30,000	20,000
3	20,000	20,000
4	10,000	40,000
5	10,000	50,000
6		60,000

The payback criteria prefers A, which has a payback period of 3 years, in comparison to B, which has a payback period of 4 years, even though B has very substantial cash inflows in years 5 and 6.

- Since the payback period is a measure of a projects' capital recovery, it may divert attention from profitability. Payback has harshly, but not unfairly, been described as the "fish bait test since effectively it concentrates on the recovery of the bait (the capital outlay) paying not attention to the size of the fish (the ultimate profitability), if any."
- Though it measures a project's liquidity, it does not indicates the liquidity position of the firm as a whole, which is more important.

Accounting Rate of Return

The accounting rate of return, also referred to as the average rate of return or the simple rate, is a measure of profitability which relates income to investment, both measured in accounting terms. Since income and investment can be measured variously, there can be a very large number of measures for accounting rate of return.

The measures that are employed commonly in practice are:

$$A : \frac{\text{Average income after tax}}{\text{Initial investment}}$$

The shortcomings of the accounting rate of return criterion seem to be considerable:

- It is based upon accounting profit, not cash flow.
- It does not take into account the time value of money. To illustrate this point, consider two investment proposals X and Y, each requiring an outlay of Rs 1,00,000. Both the proposals have an expected life of four years after which their value would be nil. Relevant details of these proposals are given below:

PROPOSAL X				
Year	Book Value	Depreciation after tax	Profit	Cash
0	1,00,000	0	0	1,00,000
1	75,000	25,000	40,000	65,000
2	52,000	25,000	30,000	55,000
3	50,000	25,000	20,000	45,000
4	0	25,000	10,000	35,000

PROPOSAL Y				
Year	Book Value	Depreciation after tax	Profit	Cash
0	(1,00,000)	0	0	(1,00,000)
1	70,000	25,000	10,000	35,000
2	50,000	25,000	20,000	45,000
3	25,000	25,000	30,000	55,000
4	0	25,000	40,000	65,000

Both the proposals, with an accounting rate of return (measure A) of 50% look alike from the accounting rate of return point of view, though project X, because it provides benefits earlier, is much more desirable. While the payback period criterion gives no weight to more distant benefits, the accounting rate of return criteria seems to give them too much weight.

- There are, as we have seen, numerous measures of accounting rate of return. This can create controversy, confusion and more confusion, and problems in interpretation.
- Accounting income (whatever particular measure of income we choose) is not uniquely defined because it is influenced by the methods of depreciation, inventory valuation, and allocation of certain costs. Working with the same basic accounting data, different accountants are likely to produce different income figures. A similar problem, though less severe, exists with respect to investment.
- The argument that the accounting rate of return measure facilitates post-auditing of capital expenditure is not very valid. The financial accounting system of a firm

is designed to report events with respect to accounting periods and for profit centres but not for individual investment.

Debt Service Coverage Ratio

Financial institutions, which provide the bulk of long-term finance for industrial projects, evaluate the financial viability of a project primarily in terms of the internal rate of return and the debt service coverage ratio.

$$DSCR = \frac{\sum_{i=1}^n (PAT_i + D_i + I_i)}{\sum_{i=1}^n (I_i + LTI_i)}$$

Debt service coverage ratio (DSCR) is defined as

where PAT_i = Profit after tax for year i

D_i = depreciation for year i

I_i = interest on long-term loans of financial institutions for year i

LRI_i = loan repayment instalment for year i.

n = period over which the loan has be repaid.

Looking at the debt service coverage ratio we find the numerator consists of a mixture of post-tax and pre-tax figures (profit after tax is a post tax figure and interest is a pre-tax figure). Likewise, the denominator consists of mixture of post-tax and pre-tax figures (loan repayment installation is a post-tax figure and interest is a pre-tax figure). It is difficult to interpret a ratio which is based on a mixture of post-tax and pre-tax figures. In view of this difficulty, we suggest two alternatives :

Alternative 1:

$$DSCR = \frac{\text{Earnings before depreciation interest and taxes}}{\frac{\text{Interest + Loan repayment instalment}}{1 - \text{Tax rate}}}$$

Alternative 2:

$$DSCR = \frac{\text{Profit after tax + Depreciation}}{\text{Loan repayment instalment}}$$

While alternative 1 is based on pre-tax figures, alternative 2 is based on post-tax figures.

There is one more difference. Alternative 1, assumes that the interest and loan repayment obligations are of the same order and focuses on the ability of the firm to meet these obligations jointly. Alternative 2 assumes that the interest burden is of a higher priority, and focuses on the ability of the firm to meet the principal repayment obligation, once the interest obligation is fully met.

These traditional methods of investment appraisal are misleading to a dangerous extent. A means of measuring cash that allows for the importance of time is needed. This is provided by the discounting methods of appraisal, of which there are basically two methods, both of which meet the objections to the payback period and the average rate of return methods.

Discounting Methods of Appraisal

Net Present Value

The net present value of a project is equal to the sum of the present value of all the cash flows associated with the project. One of the most important concepts originating from the time value of money, NPV is calculated by subtracting the present value of the cash outflows (investment) from the present value of the cash inflows (income).

Suppose you are making an investment of Rs 1 lac today and are expecting that you will get Rs 1.1 lacs one year from now. You will only invest if the present value of Rs 1.1 lac that you are getting one year hence is more than Rs 1 lac you have invested today. Using the table for present value of Rs 1, the multiplying factor for one year at 10% is 0.909. If we multiply Rs 1.1 lac with .909 we get approx. Rs 1 lac. This means that we are getting a return of 10% from the project.

If you again look at the same table, the value gets lowered as the interest rate increases, which means that for an interest rate of more than 10% we will be getting a present value which will be lower than the investment we are making. So if we are expecting a return of 15% for one year, we will not invest as the present value of Rs 1.1 lac at 15% discount rate is lower than the investment of Rs 1 lac we are making today.

The formula for calculating the NPV is:

where NPV = net present value

CF_t = cash flow occurring at the end of year

C_0 = Initial cash out flow or investment

t = ($t = 0 \dots n$), A cash inflow has a positive sign, whereas a cash outflow has a negative sign

n = life of the project

k = cost of capital used as the discount rate

Here C_0 is the initial investment we are making into the project and the rest is the present value of the cash flows we are expecting in the future. So NPV is the difference between the two at the expected rate of return.

With NPV the acceptance rule is

NPV > 0 Accept

= 0 Indifferent

< 0 Reject

If the NPV is greater than zero we accept the project because we are getting a rate of return which exceeds our desired rate of return, if it is equal to zero we may or may not accept the project as we are getting a return which is exactly equal to our desired rate of return, and if it is less than zero we reject the project proposal because the rate of return we are getting is less than our desired rate of return.

Features of Net Present Value

Two features of the net present value method to be emphasised :

1. The NPV method is based on the assumption that the intermediate cash inflow of the project is reinvested at a rate of return equal to the firm's cost of capital.
2. The NPV of a simple project monotonically decreases as the discount rate increases; the decrease in NPV, however, is at a decreasing rate.

Evaluation

Conceptually sound, the net present value criterion has considerable merits:

- It takes into account the time value of money.
- It considers the cash flow stream in its entirety.
- It squares neatly with the financial objective of maximisation of the wealth of stockholder. The net present value represents the contribution to the wealth of stockholders.
- The net present value of various projects, measured as they are in today's rupees, can be added. For example, the present value of package consisting of two projects A and B, will simply be the sum of the net present value of these projects individually:

$$NPV (A+B) = NPV (A) + NPV (B)$$

The additivity property of net present value ensures that a poor project (one which has

a negative net present value) will not be accepted just because it is combined with a good project (which has a positive net present value).

The limitations of the net present value criteria are:

- The ranking of projects on the net present value dimension is influenced by the discount rate. To illustrate, consider two mutually exclusive projects - A and B which have the following cash flow streams :

Year	A	B
0	-3,00,000	-3,00,000
1	60,000	1,30,000
2	1,00,000	1,00,000
3	1,20,000	80,000
4	1,50,000	60,000

The net present value of A and B for various rate of discounts is given below.

Discount rate	NPV (A)	NPV (B)
10%	36,622	29,180
12	20,390	17,658
14	5,318	6,828
15	-1,826	1,654
16	-8,702	-3,350

Looking at the behaviour of net present value, we find that : (i)when the discount rate is 12 per cent , the net present value of A is greater than the net present value of B; and (ii) when the discount rate is 14 per cent the net present value of B is greater than the net present value of A.

- The net present value measure, an absolute measure, does not appear very meaningful to businessmen who want to think in term of rate of return measures.

Profitability Index (PI)

Profitability Index relates the present value of benefits to the initial investment. It is also known as Benefit-Cost Ratio (BCR)

$$PI = \frac{PVCF}{I}$$

where , PI = Profitability Index

PVB = present value of cash flows

I = initial investment

To illustrate the calculation of these measures, let us consider a project which is being evaluated by a firm that has a cost of capital of 12 per cent.

Initial investment :	Rs. 1,00,000
Year 1	25,000
Year 2	40,000
Year 3	40,000
Year 4	50,000

The profitability index for this project is:

$$PI = \frac{\frac{25,000}{(1.12)^1} + \frac{40,000}{(1.12)^2} + \frac{40,000}{(1.12)^3} + \frac{50,000}{(1.12)^4}}{1,00,000} = 1.145$$

With PI the acceptance rule is

- PI > 1 Accept
- = 1 Indifferent
- < 1 Reject

If PI is greater than one we accept the project because we are getting a rate of return which exceeds our desired rate of return. If it is equal to one we may or may not accept the project as we are getting a return which is exactly equal to our desired rate of return. If it is less than one we reject the project proposal because the rate of return we are getting is less than our desired rate of return.

Putting it simply PI is an adaptation of the NPV rule because through it uses the same figures it only helps in ranking of the project.

Evaluation

The proponents of profitability index argue that since this criterion measures net present value per rupee of outlay it can discriminate better between large and small investments and hence is preferable to the net present value criterion. How valid is this argument ? Theoretically, it can be very easily verified that:

- (i) Under unconstrained conditions, the PI criteria will accept and reject the same projects as the net present value criteria.
- (ii) When the capital budget is limited in the current period, the benefit cost ratio criteria may rank projects correctly in the order of decreasingly efficient use of capital. However, its use is not recommended because it provides no means for aggregating several smaller projects into a package that can be compared with a large project.
- (iii) When cash outflows occur beyond the current period, PI criteria is unsuitable as a selection criteria.

Internal Rate of Return

When the present value of cash inflows are exactly equal to the present value of cash outflows we are getting a rate of return which is equal to our discounting rate. In this case the rate of return we are getting is the actual return on the project. This rate is called the IRR.

$$NPV = \sum_{i=1}^n \frac{CF_t}{(1+k)^t} - C_0$$

Using the same formula as given in the NPV above, IRR will be the return when the NPV is equal to zero as only then the present value of cash inflows will be equal to the present value of the cash outflows.

$$NPV = \sum_{i=1}^n \frac{CF_t}{(1+r)^t} - C_0 = 0$$

$$\sum_{i=1}^n \frac{CF_t}{(1+r)^t} = C_0$$

here CF_t = cash flow at the end of year t

r = discount rate

n = life of the project

In the net present value calculation we assume that the discount rate (cost of capital) is known and determine the net present value of the project. In the internal rate of return calculation, we set the net present value equal to zero and determine the discount rate (internal rate of return) which satisfies this condition.

Both the discounting methods NPV and IRR relate the estimates of the annual cash outlays on the investment to the annual net of tax cash receipt generated by the investment. As a general rule, the net of tax cash flow will be composed of revenue less taxes, plus depreciation. Since discounting techniques automatically allow for the recovery of the capital outlay in computing time-adjusted rates of return, it follows that depreciation provisions implicitly form part of the cash inflow.

Internal rate of return method consists of finding that rate of discount that reduces the present value of cash flows (both inflows and outflows attributable to an investment project to zero. In other words, this true rate is that which exactly equalises the net cash proceeds over a project's life with the initial investment outlay.

If the IRR exceeds the financial standard (i.e. cost of capital), then the project is prima facie acceptable. Instead of being computed on the basis of the average or initial investment, the IRR is based on the funds in use from period to period.

The actual calculation of the rate is a hit-and-miss exercise because the rate is unknown at the outset, but tables of present values are available to aid the analyst. These tables show the present value of future sums at various rates of discount and are prepared for both single sums and recurring annual payments.

What Does IRR Mean?

There are two possible economic interpretations of internal rate of return: (i) Internal rate of return represents the rate of return on the unrecovered investment balance in the project. (ii) Internal rate of return is the rate of return earned on the initial investment made in the project.

Evaluation

A popular discounted cash flow method, the internal rate of return criteria has several virtues :

- It takes into account the time value of money.
- It considers the cash flow stream in its entirety.
- It makes sense to businessmen who want to think in terms of rate of return and find an absolute quantity, like net present value, somewhat difficult to work with.

The internal rate of return criteria, however, has its own limitations.

- It may not be uniquely defined. If the cash flow stream of a project has more than one change in sign, there is a possibility that there are multiple rates of return.
- The internal rate of return figure cannot distinguish between lending and borrowing and hence a high internal rate of return need not necessarily be a desirable feature.

The internal rate of return criterion can be misleading when choosing between mutually exclusive projects that have substantially different outlays. Consider projects P and Q

Cash Flows ----- Period 0 1	Internal rate of return (%)	Net present value (assuming k = 12%)
P - 10,000 + 20,000	100	7,857
Q - 50,000 + 75,000	50	16,964

Both the projects are good, but Q, with its higher net present value, contributes more to the wealth of the stockholders. Yet from an internal rate of return point of view P looks better than Q. Hence, the internal rate of return criterion seems unsuitable for ranking projects of different scale.

Capital Rationing

In terms of financing investment projects, three essential questions must be asked:

1. How much money is needed for capital expenditure in the forthcoming planning period?
2. How much money is available for investment?
3. How are funds to be assigned when the acceptable proposals require more money than is available?

The first and third questions are resolved by reference to the discounted return on the various proposals, since it will be known which are acceptable, and in which order of preference. The second question is answered by a reference to the capital budget. The level of this budget will tend to depend on the quality of the investment proposals submitted to top management. In addition, it will also tend to depend on:

- top management's philosophy towards capital spending (e.g., is it growth - minded or cautious:)?
- the outlook for future investment opportunities that may be unavailable if extensive current commitments are undertaken;
- the funds provided by current operations; and
- the feasibility of acquiring additional capital through borrowing or equity issues.

It is not always necessary, of course, to limit the spending on projects to internally generated funds. Theoretically, projects should be undertaken to the point where the return is just equal to the cost of financing these projects. If safety and the maintaining of, say, family control are considered to be more important than additional profits, there may be a marked unwillingness to engage in external financing and hence a limit will be placed on the amounts available for investment.

Even though the firm may wish to raise external finance for its investment programme, there are many reasons why it may be unable to do this. Examples include:

- a) The firm's past record and its present capital structure may make it impossible or extremely costly to raise additional debt capital.
- b) The firm's record may make it impossible to raise new equity capital because of low yields or even no yield.
- c) Covenants in existing loan agreements may restrict future borrowing.

Furthermore, in the typical company, one would expect capital rationing to be largely self-imposed.

Each major project should be followed up to ensure that it conforms to the conditions on

which it was accepted, as well as being subject to cost control procedures.

Inflation and Capital Budgeting

One of the major mistakes is improper treatment of inflation in capital budgeting decisions. The capital budgeting results would be unrealistic if the impact of inflation is not correctly factored in the analysis as the cash flow estimates will not reflect the real purchasing power. In other words, cash flows would be shown at inflated sums and, to that extent, cause distortion in capital budgeting decisions. Therefore, cash flows should be adjusted to accommodate the inflation factor so that the capital budgeting decisions reflect the 'true' picture. This Section dwells on the procedure for adjusting data for inflation. Consider Example 2.2

An investment proposal P requires an initial capital outlay of Rs. 2,00,000, with no salvage value, and will be depreciated on a straight line basis for tax purposes. The earnings before depreciation and taxes (EBDT) during its 5 year life are:

Year	1	2	3	4	5
EBDT (Rs.)	70,000	76,000	80,000	60,000	52,000

Example 2.2

The corporate tax rate is 35 per cent and the company evaluates its investment projects at 12 per cent cost of capital. Advise the company whether the project should be accepted. (i) when there is no inflation and (ii) when there is inflation at the rate of 15 per cent per annum, and the stated gross earnings are also expected to grow at this rate of inflation.

Solution

Determination of NPV (No Inflation situation)

(Amount in rupees thousand)

Year	PBDT	Depre- ciation (200/5)	Taxable Income	Profit After Tax (Inc.x0.65)	Cash Flow After Tax (PAT+Dep)	PV Factor	Present Value
1	70	40	30	19.5	59.5	0.893	53.13
2	76	40	36	23.4	63.4	0.797	50.53
3	80	40	40	26.0	66.0	0.712	46.99
4	60	40	20	13.0	53.0	0.636	33.71
5	52	40	12	7.8	47.8	0.567	27.10
Gross present value							211.46
Less: Cash outflows							200.00
Net present value							11.46

Since the net present value is positive, the project is worth accepting in a non-inflationary scenario.

In an inflationary situation, PBDT are expected to grow at 15 per cent. PBDT can be determined (reflecting 15 per cent compound rate of growth) using the table. As amount of depreciation remains unchanged, taxable profits as well as taxes would go up as exhibited below:

<i>Year</i>	<i>PBDT</i>	<i>Compo- unding Factor At 0.15</i>	<i>Revised PBDT (PBDT X Com. Fac.)</i>	<i>Depre- ciation</i>	<i>Taxable Income</i>	<i>PAT</i>	<i>CFAT</i>
1	70	1.150	80.50	40	40.50	26.32	66.32
2	76	1.322	100.47	40	60.47	39.31	79.31
3	80	1.521	121.68	40	81.68	53.09	93.09
4	60	1.749	104.94	40	64.94	42.21	82.21
5	52	2.011	104.57	40	64.57	41.97	81.97

Since CFAT are inflated sums, they are to be deflated at the rate of inflation (15 per cent) to determine real cash flows. The relevant calculations are as follows:

Determination of Real Cash Flows

(Amount in thousand rupees)

<i>Year</i>	<i>CFAT</i>	<i>Discount/ deflated factor at 0.15</i>	<i>Real cash inflows (CFAT)</i>
1	66.32	$1/1.15 = 0.870$	57.50
2	79.31	$1/(1.15)^2 = 0.756$	59.96
3	93.09	$1/(1.15)^3 = 0.658$	61.25
4	82.21	$1/(1.15)^4 = 0.572$	47.02
5	81.97	$1/(1.15)^5 = 0.497$	40.74

The real cash flows are substantially lower than nominal cash flows. This is due to the fact that increased income (as depreciation charges do not change) is subject to higher amount of taxes. The corporate tax rate is more than twice (35 per cent) the inflation rate (15 per cent). The NPV and real cash inflows are shown in the following tables.

NPV Calculations

(Amount in thousand rupees)

<i>Year</i>	<i>Real CF</i>	<i>PV factor at 12%</i>	<i>Present Value</i>
1	57.70	0.893	51.53
2	59.96	0.797	47.79
3	61.25	0.712	43.61
4	47.02	0.636	29.90
5	40.74	0.567	23.10
Gross present value			195.93
Less: Cash outflows			200.00
Net present value			(4.07)

Since the NPV is negative under inflationary situations, the investment proposal is not acceptable. Thus, inflation results both in lower cash flows and lower real rates of

return. Example 2.2 highlights that firms (conscious of protecting the real purchasing power of their owners) may go for unprofitable investment projects, affecting the shareholders wealth adversely. It underlines the significance of incorporating the inflation factor in evaluating capital budgeting decisions, in particular for business firms interested in real returns.

Consistency warrants that the real cost of capital should be used to discount real cash inflows after taxes and the nominal cost of capital should be employed for nominal CFAT. This point is illustrated in Example 2.3. The investment data of Rajiv Company Ltd. Launching a new product and with 12 per cent cost of capital, is as follows:

<i>Particular</i>	<i>Amount</i>
Investment	Rs.7,00,000
CFAT: Year 1	5,00,000
2	4,00,000
3	2,00,000
4	1,00,000
5	1,00,000

Example 2.3

Assuming an inflation rate of 5 per cent, determine NPV of the project by using both the nominal rate of discount and the real rate of discount.

Solution

NPV Using Nominal Rate of Discount

Year	CFAT (Rs.)	PV factor at 0.12	Total PV (Rs.)
1	5,00,000	0.893	4,46,500
2	4,00,000	0.797	3,18,800
3	2,00,000	0.712	1,42,400
4	1,00,000	0.636	63,600
5	1,00,000	0.567	56,700
Gross present value			10,28,000
<i>Less:</i> Cash outflows			7,00,000
Net present value			3,28,000

The nominal rate of discount (n) is obtained by compounding the real rate (r) and inflation rate (i). In equations terms, it is

$$(1 + n) = (1 + r) (1 + i)$$

$$(1 + r) = (1 + n) (1 + i)$$

or

substituting the values,

$$(1 + r) = 1.12/1.05 = 1.0667$$

$$r = 0.0667 \text{ or } 6.67 \text{ per cent.}$$

or

Since the discount rate now to be used is the real discount rate, the CFAT should also be adjusted for inflation so that they too are expressed in real terms. In operational terms, CFAT will be deflated by the inflation rate (5 per cent). While Table 5.1 shows real/ deflated CFAT, NPV of real CFAT is provided in Table 5.2

Real Cash Flows

<i>Year</i>	<i>CFAT (Rs.)</i>	<i>Deflation factor at 0.05</i>	<i>Real CFAT (Rs.)</i>
1	5,00,000	$1/(1.05) = 0.952$	4,76,000
2	4,00,000	$1/(1.15)^2 = 0.907$	3,62,800
3	2,00,000	$1/(1.15)^3 = 0.864$	1,72,800
4	1,00,000	$1/(1.15)^4 = 0.823$	82,300
5	1,00,000	$1/(1.15)^5 = 0.784$	78,400

Table 5.1

NPV Using Real Rate of Discount

<i>Year</i>	<i>Real CFAT</i>	<i>PV factor at 6.67%</i>	<i>Total PV</i>
1	4,76,000	0.938	4,46,488
2	3,62,800	0.879	3,18,901
3	1,72,800	0.824	1,42,387
4	82,300	0.772	63,536
5	78,400	0.724	56,761
Gross present value			10,28,073
Less: Cash outflows			7,00,000
Net present value			3,28,073

Table 5.2

Please note that 'real cash flows discounted at the 'real' discount rate yield an identical amount of NPV that is obtained by discounting 'nominal' cash flows by the 'nominal' discount rate. When estimates of CFAT and cost of capital include inflation, they are said to be expressed in nominal terms; when such estimates exclude the impact of inflation, they are said to be shown in real terms. For correct analysis, these estimates should either be stated in nominal or real terms. It implies that capital budgeting decisions should either reckon the inflation factor in CFAT, as well as the cost of capital, or exclude it completely.

Chapter-6

Capital Budgeting under Risk and Uncertainties

Risk is used to describe the type of situation in which there are a number of possible states of nature, hence outcomes, but in which the decision maker can reasonably assess the probability of occurrence of each. Thus risk can be expressed in quantitative terms.

Under conditions of uncertainty, in contrast, it is recognised that several out-comes are possible, but the decision-maker is unable to attach probabilities to the various states of nature.

The liability is usually due to a lack of data on which to base a probability estimate. For instance, in launching a new product, the marketing manager may have an idea of what the sales in year 1 are likely to be, but he must accept that the actual level will be one of many possible levels. However, the marketing manager may be unable to specify the probability of each level being achieved, making it an uncertainty situation.

There is also, of course, the situation of complete certainty. This relates to a decision over which the decision-maker has complete control, and is thus likely to be confined to the production sphere. This is so because the existence of external agents in marketing and distribution means that knowledge is incomplete, and the creative aspect of R & D means that outcomes are unknown in advance.

If a finance manager feels he knows exactly what the outcomes of a project would be and is willing to act as if no alternative were in existence, he will be presumably acting under conditions of certainty. Thus, certainty is a state of nature, which arises when outcomes are known and determinate. In this state each action is known to lead invariably to a specific outcome. For example, if one invests Rs. 20,000 in five yearly central government bonds which is expected to yield 7 per cent tax free return, then the return on the investment @ 7 per cent can be estimated quite precisely. This is so because we assume the Government of India to be one of the most stable forces in this country. Thus, the outcome is known to have a probability of 1. Since we know how things are or will be, the decision strategy is deterministic, we simply evaluate alternative actions and select the best one.

Risk involves situations in which the probabilities of an event occurring are known and these probabilities are objectively or subjectively determinable. The main attribute of

risk situation is that the event is repetitive in nature and possesses a frequency distribution. It is the inability to predict with perfect knowledge the course of future events that introduces risk. As events become more predictable, risk is reduced. Conversely, as events become less predictable, risk is increased. Thus, if Rs. 10 lakhs is invested in stock of a company organised to extract coal from a mine, and then the probable return cannot be predicted with 100 per cent certainty. The rate of return on the above investment could vary from minus 100 per cent to some extremely high figure and *because* of this high variability; the project is regarded as relatively risky. Risk is then associated with project variability - the more variable the expected future returns from the project, the riskier the investment.

In contrast, when an event is not repetitive and unique in character and the finance manager is not sure about probabilities themselves, uncertainty is said to prevail. Uncertainty is a subjective phenomenon. In such situation no observation can be drawn from frequency distributions. We have no knowledge about the probabilities of the possible outcomes. It follows that if the probabilities are completely unknown or are not even meaningfully known the expected value of any decisions cannot be determined. Practically no generally accepted methods could so far be evolved to deal with situation of uncertainty while there are a number of techniques to deal with risk. In view of this, the term risk and uncertainty will be used interchangeably in the following discussion.

With the introduction of risk no company can remain indifferent between two investment projects with varying probability distributions as shown in Figure 6.1 Although each investment inflows of Rs. 5,000 in its three-year life.

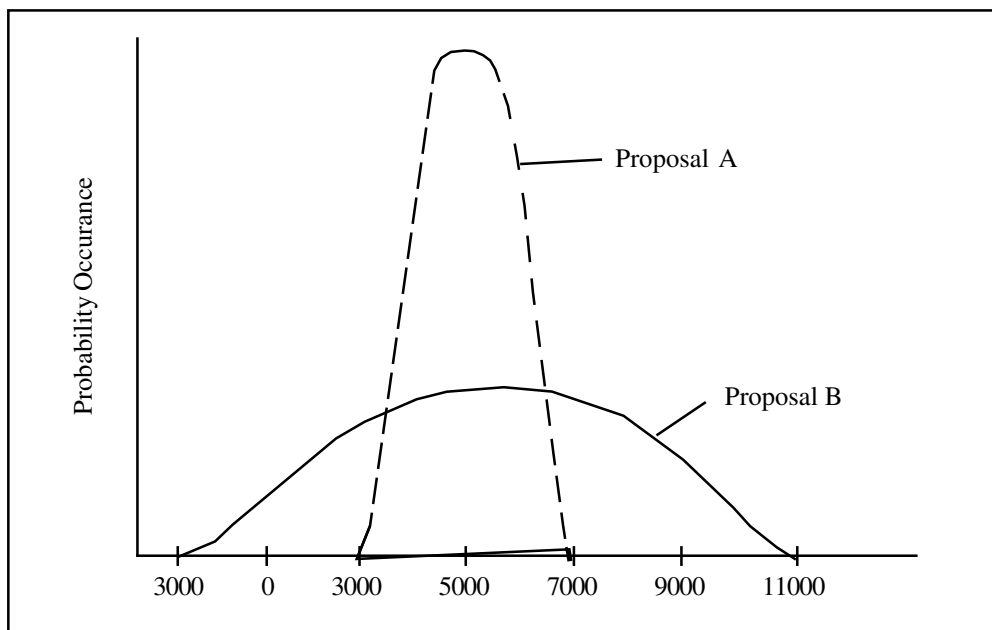

A look at the Figure 6.1 will make it crystal clear that dispersion of the probability distribution of expected cash flows for proposal B is greater than that for proposal A. Since the task is associated with the deviation of actual outcome from that which was expected, proposal B is the riskier investment. This is why risk factor should be given due importance in investment analysis.

Sources of Risk

The first step in risk analysis is to uncover the major factors that contribute to the risk of the investment. Four main factors that contribute to the variability of results of a particular investment are cost of project, investment of cash flows, variability of cash flows and life of the project.

1. Size of the Investment

A large project involving greater investments entails more risk than the small project because in case of failure of the large project the company will have to suffer considerably greater loss and it may be forced to liquidation. Furthermore, cost of a project in many cases is known in advance. There is always the chance that the actual cost will vary from the original estimate. One can never foresee exactly what the construction, debugging, design and developmental costs will be. Rather than being satisfied with a single estimate, it seems more realistic to specify a range of costs and the probability of occurrence of each value within the range. The less confidence the decision maker has in his estimate, the wider will be the range.

2. Reinvestment of Cash Flows

Whether a company should accept a project that offers a 20 per cent return for 2 years or one that offers a 16 per cent return for 3 years would depend upon the rate of return available for reinvesting the proceeds from the 20 per cent, 2-year period. The danger that the company will not be able to reinvest funds as they become available is a continuing risk in managing fixed assets and cash flows.

3. Variability of Cash Flows

It may not be an easy job to forecast the likely returns from a project. Instead of basing investment decision on a single estimate of cash flow it would be desirable to have range of estimates.

4. Life of the Project

Life of a project can never be determined precisely. The production manager should base the investment decision on the range of life of the project.

Techniques for Handling Risk and Uncertainty

Risk analysis is one of the most complex and slippery aspects of capital budgeting. Many different techniques have been suggested and no single technique can be deemed

as best in all situations. The variety of techniques suggested to handle risk in capital budgeting fall into two broad categories: (i) Approaches that consider the stand-alone risk of a project; (ii) Approaches that consider the risk of a project in the context of the firm or in the context of the market. Exhibit 6.2 classifies various techniques into these two broad categories.

This chapter discusses different techniques of risk analysis (except market risk analysis which is covered in the chapter on Cost of Capital), explores various approaches to project selection under risk, and describes risk analysis in practice. It is divided into nine sections as follows:

- Sensitivity analysis
- Scenario analysis
- Break-even analysis
- Hillier model
- Simulation analysis
- Decision tree analysis
- Corporate risk analysis

Project selection under risk. Risk analysis in practice.

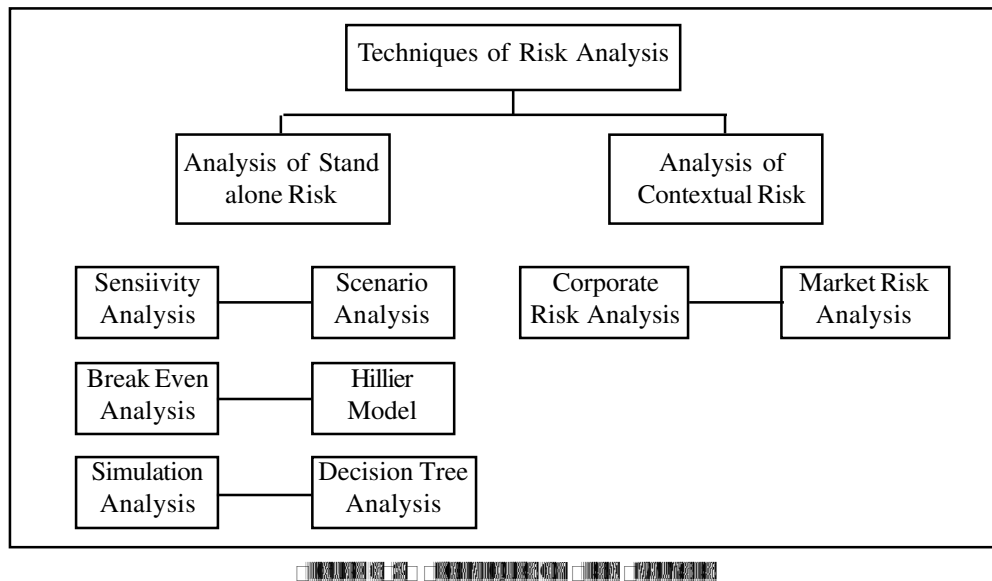

Sensitivity Analysis

Since future is uncertain, you may like to know what happens to the viability of a project when some variable like sales or investment deviates from its expected value. In other words, you would like to do sensitivity analysis. Also called “what if’ analysis it answers questions like:

What happens to net present value (or some other criterion of merit) if sales are only 60,000 units rather than the expected 75,000 units? What happens to net present value if the life of the project turns out to be only 8 years, rather than the expected 10 years?

Procedure

Fairly simple, sensitivity analysis consists of the following steps:

1. Set up the relationship between the basic underlying factors (like the quantity sold, unit selling price, life of the project, etc.) and net present value (or some other criterion of merit).
2. Estimate the range of variation and the most likely value of each of the basic underlying factors.
3. Study the effect on net present value of variations in the basic variables. (Typically one factor is varied at time.)

Illustration

Anischit Enterprises is analysing an investment proposal. The following net present value relationship has been set up:

$$NPV = \sum_{t=1}^n \frac{[Q(P - V) - F - D](1 - T) + D}{(1 + r)^t} + \frac{S}{(1 + r)^n} - I \quad \dots(8.1)$$

where NPV = net present value of the project

Q = number of units sold annually

P = selling price per unit

V = variable cost per unit

F = total fixed cost, excluding depreciation and interest

D = annual depreciation charge

T = income tax rate

r = cost of capital

n = project life in years

S = net salvage value

I = initial cost.

The range and most likely value of each of the basic variables are given in Table 6.3

TABLE 6.3: RANGE AND MOST LIKELY VALUE OF BASIC VARIABLES

Variables Rs.	Range Rs.		Most Likely Value
Q	1,000 -	2,000	1,600
P	600 -	1,000	750
V	300 -	500	400
F	120,000 -	120,000	120,000
D	160,000 -	160,000	160,000
T	0.60 -	0.60	0.60
r	0.08 -	0.11	0.10
n	5 -	5	5
S	400,000 -	400,000	400,000
I	1,200,000 -	1,200,000	1,200,000

Given the range and most likely value of basic variables, we can study the impact of variation in each variable on net present value, holding other variables constant at their most likely levels. To illustrate the nature of this analysis we shall look at the relationship between (i) r and NPV, and (iii) P and NPV.

r and NPV The relationship between r and NPV given the most likely values of other variables is

$$\begin{aligned}
 NPV &= \sum_{t=1}^5 \frac{[1,600(750 - 400) - 120,000 - 160,000](1 - 0.6) + 160,000}{(1 + r)^t} \\
 &\quad + \frac{400,000}{(1 + r)^5} - 120,000 \\
 &= \sum_{t=1}^5 \frac{272,000}{(1 + r)^t} + \frac{400,000}{(1 + r)^5} - 120,000
 \end{aligned}$$

The net present value for various values of r is shown below. The same relationship is shown graphically in Table 6.4

r	8%	9%	10%	11%
NPV	Rs. 158.080	118.080	79,552	42,700

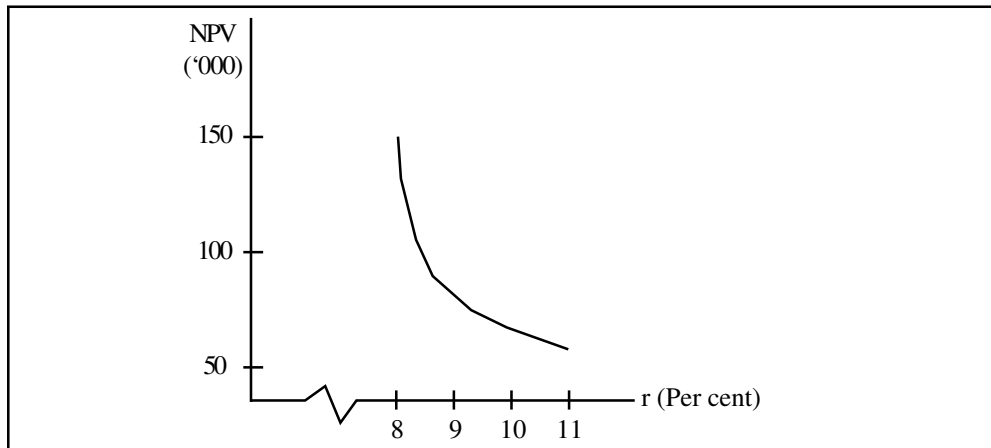

Table 6.4: NPV vs r

P and NPV The relationship between P and NPV, given the most likely values of other factors, is:

$$\begin{aligned}
 NPV &= \sum_{t=1}^5 \frac{[1,600(P - 400) - 120,000 - 160,000](1 - 0.6) + 160,000}{(1.10)^t} + \frac{400,000}{(1.10)^5} - 1,200,000 \\
 &= \sum_{t=1}^5 \frac{640P}{(1.10)^t} - \sum_{t=1}^5 \frac{208,000}{(1.10)^t} + \frac{400,000}{(1.10)^5} - 1,200,000
 \end{aligned}$$

the net present value for various values of P is shown below:

P	600	700	750	800	990	1,000
NPV	Rs. 284,384	-41,769	79,552	200,864	443,488	686,112

The same relationship is shown graphically in Table 6.4

Composite Picture

A useful way of presenting the results of sensitivity analysis is to shown how net present value behaves for different percentages of unfavorable changes (from their most likely values) in the basic variables. The behavior of net present value when there is 5 per cent, 10 percent, 15 per cent, and 20 per cent unfavorable change in r , other factors remaining unchanged at their most likely levels, is shown as follows:

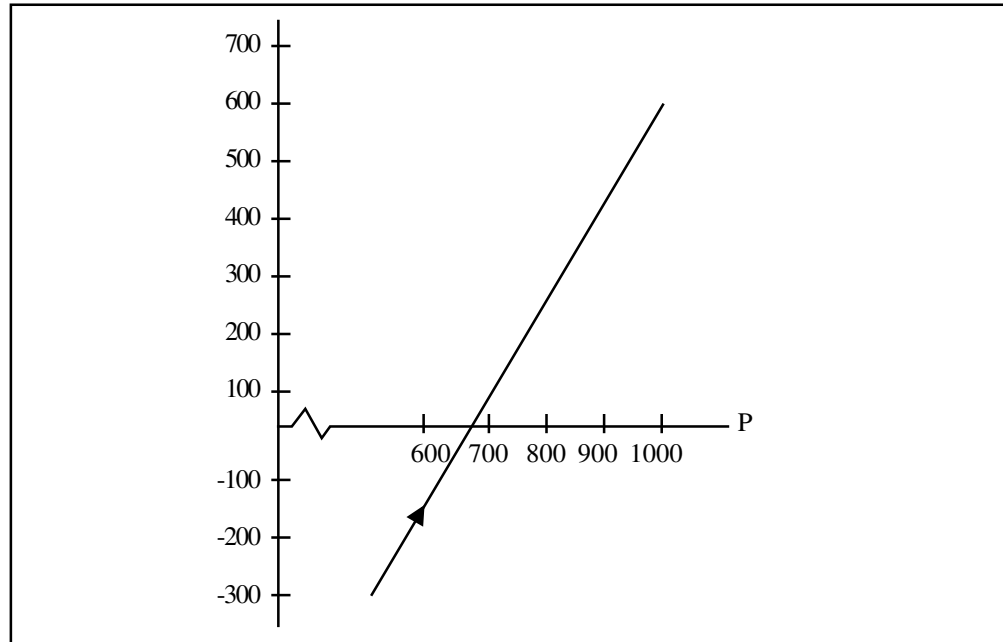

Percentage unfavourable variation	Value of r	Net present value
5	10.5	60,418
10	11.0	42,700
15	11.5	24,681
20	12.0	7,525

The behaviour of net present value when there is 5 percent, 10 percent, 15 percent and 20 percent unfavourable variation in P is shown as follows:

Percentage unfavourable variation	Value of P	Net present value
5	.713	(10,308)
10	.575	(102,500)
15	.638	(192,267)
20	.600	(284,384)

Exhibit 6.5 shows graphically the behaviour of net present value for various unfavourable percentage variations of r and P . Such a visual presentation is helpful in identifying variables, which are crucial for the success of the project.

Evaluation

Sensitivity analysis, a popular method for assessing risk, has certain merits:

- It forces management to identify the underlying variables and their inter-relationships.
- It shows how robust or vulnerable a project is to changes in the underlying variables.
- It indicates the need for further work. If the net present value or internal rate of return is highly sensitive to changes in some variable, it is desirable to gather further information about that variable.

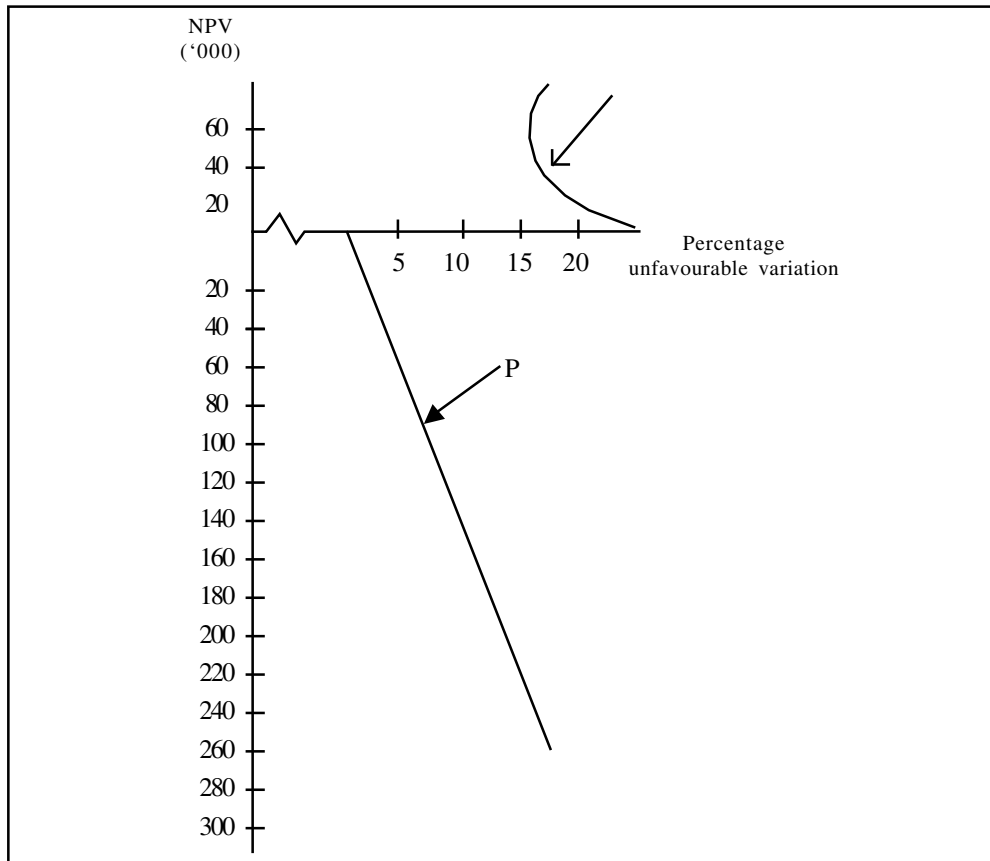

Sensitivity analysis, however, suffers from severe limitations:

- It may fail to provide leads-if sensitivity analysis merely presents a complicated set of switching values it may not shed light on the risk characteristics of the project.
- The study of the impact of variation is one factor at a time, holding other factors constant, may “not be very meaningful when the underlying factors are likely to be interrelated. What sense does it make to consider the effect of variation in price while holding quantity (which is likely to be closely related to price) unchanged?

Scenario Analysis

In sensitivity analysis, typically one variable is varied at a time. If variables are inter-related as they are most likely to be, it is helpful to look at some plausible scenarios, each scenario representing a consistent combination of variables.

Procedure

The steps involved in scenario analysis are as follows:

1. Select the factor around which scenarios will be built. The factor chosen must be the largest source of uncertainty for the success of the project. It may be the state of the economy or interest rate or technological development or response of the market, costs.
2. Estimate the values of each of the variables in investment analysis (investment outlay, revenues, cost, project life, and so on) for each scenario.
3. Calculate the net present value and/or internal rate of return under each scenario.

Illustration

Zen Enterprises is evaluating a project for introducing a new product. Depending on the response of the market—the factor which is the largest source of uncertainty for the success of the project—the management of the firm has identified three scenarios:

Scenario 1: The product will have a moderate appeal to customers across the board at a modest price.

Scenario 2: The product will strongly appeal to a large segment of the market which is highly price-sensitive.

Scenario 3: The product will appeal to a small segment of the market which will be willing to pay a high price.

(Rs. in million)

	Scenario 1	Scenario 2	Scenario 3
Initial investment	200	200	200
Unit selling price (in rupees)	25	15	40
Demand (in units)	20	40	10
Revenues	500	600	400
Variable costs	240	480	120
Fixed costs	50	50	50
Depreciation	20	20	20
Pre-tax profit	190	50	210
Profit after tax	95	25	105
Annual cash flow	95	25	105
Project life	115	45	125
Salvage value	10 years	10 years	10 years
Net present value	0	0	0
	377.2	25.9	427.4
(at a discount rate of 15 per cent)			



Best and Worst Case Analysis

In the above illustration, an attempt was made to develop scenarios in which the values of variables were internally consistent. For example, high selling price and low demand typically go hand in hand. Firms often do another kind of scenario analysis called the best case and worst case analysis. In this kind of analysis the considered:

Best Scenario High demand, high selling price, low variable cost, and so on.

Normal Scenario Average demand, average selling price average variable cost, and so on.

Worst Scenario Low demand, low selling price, high variable cost and so on.

The objective of such scenario analysis is to get a feel of what happens under the most favourable or the most adverse configuration of key variables, without bothering much about the internal consistency of such configurations.

Evaluation

Scenario analysis may be regarded as an improvement over sensitivity analysis because it considers variations in several variables together.

However, scenario analysis has its own limitations:

It is based on the assumption that there are few well-delineated scenarios. This may not be true in many cases. For example, the economy does not necessarily lie in three discrete states, viz., recession, stability, and boom. It can in fact be anywhere on the continuum between the extremes. When a continuum is converted into three discrete states some information is lost.

Scenario analysis expands the concept of estimating the expected values. Thus, in a case where there are 10 inputs the analyst has to estimate 30 expected values (3×10) to do the scenario analysis.

Break-even Analysis

In sensitivity analysis we ask what will happen to the project if sales decline or costs increase or something else happens. As a finance manager, you will also be interested in knowing how much should be produced and sold at a minimum to ensure that the project does not 'lose money'. Such an exercise is called *break-even analysis* and the minimum quantity at which loss is avoided is called the break-even point. The *break-even point* may be defined in accounting terms or financial terms.

Accounting Break-even Analysis

Suppose you are the finance manager of Naveen Flour Mills. Naveen is considering

setting up a new flour mill near Bangalore. Based on Naveen's previous experience, the project staff of Naveen has developed the figures shown in Exhibit 6.8

	('000)	
	Year 0	Years 1-10
1. Investment	(20,000)	
2. Sales		18,000
3. Variable costs (66+% of sales)		12,000
4. Fixed costs		1,000
5. Depreciation		2,000
6. Pre-tax profit		3,000
7. Taxes		1,000
8. Profit after taxes		2,000
9. Cash flow from operation		4,000
10. Net cash flow	(20,000)	4,000

Note that the ratio of variable costs to sales is 0.667 (12/18). This means that every rupee of sales makes a contribution of Rs 0.333. Put differently, the contribution margin ratio is 0.333. Hence the break-even level of sales will be:

$$\frac{\text{Fixed Costs} + \text{Depreciation}}{\text{Contribution are in Ratio}} = \frac{1 + 2}{0.333} = \text{Rs. 9 million}$$

By way of confirmation, you can verify that the break-even level of sales is indeed Rs 9 million.

	Rs. in Million
Sales	9
Variable Costs	6
Fixed Costs	1
Depreciation	2
Profit Before Tax	0
Tax	0
Profit After Tax	0

A project that breaks even in accounting terms is like a stock that gives you a return of zero per cent. In both the cases you get back your original investment but you are not compensated for the time value of money or the risk that you bear. Put differently, you forego the opportunity cost of your capital. Hence a project that merely breaks even in accounting terms will have a negative NPV.

Financial Break-even Analysis

The focus of financial break-even analysis is on NPV and not accounting profit. At

what level of sales will the project have a zero NPV?

To illustrate how the financial break-even level of sales is calculated, let us go back to the flour mill project. The annual cash flow of the project depends on sales as follows:

1. Variable costs : 66.67% of sales
2. Contribution : 33.33% of sales
3. Fixed costs : Rs. 1 million
4. Depreciation : Rs. 2 million
5. Pre-tax profit : (0.333 Sales) – Rs. 3 million
6. Tax (at 33.3%) : 0.333 (0.333 Sales – Rs. 3 million)
7. Profit after tax : 0.667 (0.333 Sales – Rs. 3 million)
8. Cash flow (4 + 7) : Rs. 2 million + 0.067 (0.333 Sales – Rs. 3 million)
= 0.222 Sales

Since the cash flow lasts for 10 years, its present value at a discount rate of 12 per cent is:

$$\begin{aligned} \text{PV(cash flows)} &= 0.222 \text{ Sales} \times \text{PVIFA (10 years, 12\%)} \\ &= 0.222 \text{ Sales} \times 5.650 \\ &= 1.255 \text{ Sales} \end{aligned}$$

The project breaks even in NPV terms when the present value of these cash flows equals the initial investment of Rs 20 million. Hence, the financial break-even occurs when

$$\begin{aligned} \text{PV (cash flows)} &= \text{Investment} \\ 1.255 \text{ Sales} &= \text{Rs. 20 million} \\ \text{Sales} &= \text{Rs. 15.94 million} \end{aligned}$$

Thus, the sales for the flour mill must be Rs 15.94 million per year for the investment to have a zero NPV. Note that this is significantly higher than Rs 9 million which represents the accounting break-even sales.

Hillier Model

Under certain circumstances, the expected net present value and the standard deviation of net present value may be obtained through analytical derivation. Two cases of such analysis are discussed here: (i) no correlation among cash flows and (ii) perfect correlation among cash flows.

Uncorrelated Cash Flows

When the cash flows of different years are uncorrelated, the cash flow for year t is

independent of the cash flow for year $i-r$. Put differently, there is no relationship between cash flows from one period to another. In this case the expected net present value and the standard deviation of net present value are defined as follows:

$$\overline{\text{NPV}} = \sum_{t=1}^n \frac{\overline{A}_t}{(1+i)^t} - 1$$

...(8.2)

$$\sigma(\text{NPV}) = \sum_{t=1}^n \left[\frac{\sigma_t^2}{(1+i)^{2t}} \right]$$

...(8.3)

where NPV = expected net present value

\overline{A}_t = expected cash flow for year t

i = risk-free interest rate

t = initial outlay

$\sigma(\text{NPV})$ = standard deviation of net present value

σ_t = standard deviation of the cash flow for year t.

Note that in the above formulae the discount rate is the risk-free interest rate because we try to separate the time value of money and the risk factor. This risk of the project, reflected in $\sigma(\text{NPV})$ is considered in conjunction with $\overline{\text{NPV}}$ computed with the risk-free discount rate. If $\overline{\text{NPV}}$ is computed using a risk-adjusted discount rate and then if this is viewed along with $\sigma(\text{NPV})$, the risk factor would be doubled counted.

Example: A project involving in outlay of Rs. 10,000 has the following benefits associated with it.

Year 1		Year 2		Year 3	
Net cash flow	Probability	Net Cash flow	Probability	Net Cash flow	Probability
Rs. 3,000	0.3	Rs. 2,000	0.2	Rs. 3,000	0.3
5,000	0.4	4,000	0.6	5,000	0.4
7,000	0.36	6,000	0.2	7,000	0.3

Calculate $\overline{\text{NPV}}$ and $\sigma(\text{NPV})$, assuming that i = 6 per cent

I

$$= \frac{5,000}{(1.06)} + \frac{4,000}{(1.06)^2} + \frac{5,000}{(1.06)^3} = 10,000 = 2,475$$

$$= \sigma(\text{NPV}) = \sum_{t=1}^n \left[\frac{\sigma_t^2}{(1+i)^{2t}} \right]$$

$$= \frac{2,400,000}{(1.06)^2} + \frac{1,600,000}{(1.06)^4} + \frac{2,400,000}{(1.06)^6} = \text{Rs. } 2,258$$

Perfectly Correlated Cash Flows

If cash flows are perfectly correlated, the behaviour of cash flows in all periods is alike. This means that if the actual cash flow in one year is *a* standard deviations to the left of its expected value, cash flows in other years will also be a standard deviations to the left of their respective expected values. Put in other words, cash flows of all years are linearly related to one another. The expected value and the standard deviation of net present value, when cash flows are perfectly correlated, are as follows:

$$\overline{\text{NPV}} = \dots(8.3)$$

$$\sigma(\text{NPV}) = \sum_{t=1}^n \left[\frac{\sigma_t}{(1+i)^t} \right] \dots(8.4)$$

Example: An investment project involves a current outlay of Rs 10,000. The mean and Standard Deviation of cash flows which are perfectly correlated, are as follows:

Year	\bar{A}_t	σ_t
1	5000	1500
2	3000	1000
3	4000	2000
4	3000	1200

Calculate $\overline{\text{NPV}}$ and $\sigma(\text{NPV})$, assuming a risk-free interest rate of 6 per cent.

$$\begin{aligned} \overline{\text{NPV}} &= \sum_{t=1}^4 \frac{\bar{A}_t}{(1+i)^t} - I \\ &= \frac{5,000}{(1.06)} + \frac{4,000}{(1.06)^2} + \frac{5,000}{(1.06)^3} + \frac{3,000}{(1.06)^4} = 10,000 = 3121 \\ \sigma(\text{NPV}) &= \sum_{t=1}^4 \frac{\sigma_t}{(1+i)^t} \\ &= \frac{1500}{(1.06)} + \frac{1000}{(1.06)^2} + \frac{2000}{(1.06)^3} + \frac{1200}{(1.06)^4} = \text{Rs. } 4935 \end{aligned}$$

Standardising the Distribution

Knowledge of $\overline{\text{NPV}}$ and $\sigma(\text{NPV})$ is very useful for evaluating the risk characteristics of a project. If the NPV of a project is approximately normally distributed, we can calculate the probability of NPV being less than or more than a certain specified value.

$$\sum_{t=1}^n \frac{\bar{A}_t}{(1+i)^t} - 1$$

This probability is obtained by finding the area under the probability distribution curve to the left or right of the specified value. Suppose the probability distribution of NPV is as shown in Figure 6.9. If we want to calculate the probability distribution curve to the left of 0, this is indicated by the shaded region on the left. If we are interested in finding the probability that NPV exceeds a certain value, say Rs. 4 million, we calculate the area under the probability distribution curve to the right of Rs. 4 million-this area is shown as the shaded region on the right.

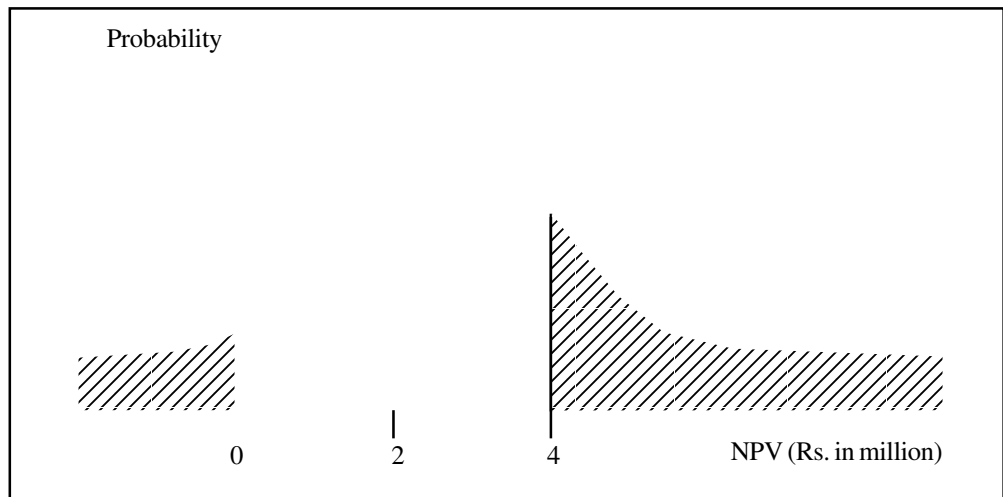

How can we calculate the area to the left or right of a specified point? To calculate the area to the left or right of a specified point, we use the following procedure.

Step 1 Standardise the difference between the specified point and *NPV*. To do this the difference between the specified point and *NPV* is divided by $\sigma(\text{NPV})$. The standardised difference may be referred to as *Z*. The purpose of standardisation is to transform the actual distribution of *NPV* into a standard normal distribution. The standard normal distribution *has* a mean of 0 and standard deviation of 1. Figure 6.10 shows the standard normal distribution.

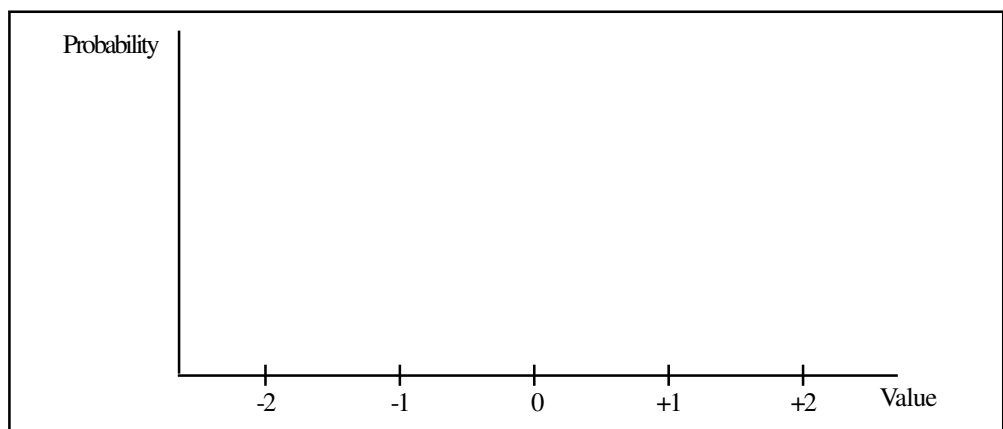

Step 2 Refer to the standard normal distribution table *and* find the probability to the left (or right depending on our interest) of the Z value obtained in step 1.

To illustrate the above procedure suppose that a project's \overline{NPV} and $\sigma(NPV)$ are Rs 96,000 and Rs 60,000 respectively and we want to find the *probability* that NPV will be less than 0. This may be done as follows:

Step 1 The standardised difference between the specified point (NPV = 0) and NPV = 96,000 is

Step 2 The cumulative probability up to $Z = -1.6$ as *seen* from the standard normal distribution given in Appendix A is 0.55. This means that there is a 5.5 per cent chance that NPV will be equal to or less than 0.

Simulation Analysis

Sensitivity analysis indicates the sensitivity of the criterion of merit (NPV, IRR, or any other) to variations in basic factors and provides information of the following type: If the quantity produced and sold decreases by 1 per cent, other things being equal, the NPV falls by 6 per cent. Such information, though useful, may not be adequate for decision making. The decision maker would also like to know the likelihood of such occurrences. This information can be generated by simulation analysis which may be used for developing the probability profile of a criterion of merit by randomly combining values of variables which have a bearing on the chosen criterion.

Procedure

The steps involved in simulation analysis are as follows:

1. Model the project. The model of the project shows how the net present value is related to the parameters and the exogenous variables. (Parameters are input variables specified by the decision maker and held constant over all simulation runs. Exogenous variables are input variables which are stochastic in nature and outside the control of the decision maker).
2. Specify the values of parameters and the probability distributions of the exogenous variables.
3. Select a value, at random, from the probability distributions of each of the exogenous
4. Determine the net present exogenous variables and pre-specified parameter values.
5. Repeat steps (3) and (4) a number of times to get a large number of simulated net present values.
6. Plot the frequency distribution of the net present value.

$$\frac{0 - 96000}{6000} = -1.6$$

Illustration

In real life situations, simulation is done only on the computer because of the computational medium involved. However, to give you a flavour of what goes on in simulation, we will work with a simple example where simulation has been done manually.

Zenith Chemicals is evaluating an investment project whose net present value has been modeled as follows:

$$NPV = \sum_{t=1}^n \frac{\text{Annual Cost Flow}}{(+\text{Risk} - \text{Free Rate})} - \text{Initial Investment} \quad \dots(8.5)$$

In the NPV model embodied in Eq. (8.5), the risk-free rate and the initial investment are parameters with the following values: risk-free rate = 10 per cent and initial investment = Rs 13,000. The annual cash flow and the life (n) are stochastic exogenous variables with the following distributions:

Annual Cash Flow		Project Life	
Value Rs.	Probability	Value	Probability
1,000	0.02	3 years	0.05
1,500	0.03	4	0.10
2,000	0.15	5	0.30
2,500	0.15	6	0.25
3,000	0.30	7	0.15
3,500	0.20	8	0.10
4,000	0.15	9	0.03
		10	0.02

The firm wants to perform 10 manual simulation runs for this project. To perform the *simulation* runs, we have to generate values, at random, for the two exogenous variables: annual cash flow and project life. For this purpose, we have to (i) set up the correspondence between the values of exogenous variables and random numbers, and (ii) choose some random number generating device. Exhibit 8.10 shows the correspondence between various variables and two digit random numbers. Exhibit 8.11 presents a table of random digits that will be used for obtaining two digit random numbers.

Now we are ready for simulation. In order to obtain random numbers from Exhibit 8.11 we may begin anywhere at random in the table and read any pair of adjacent columns (since we are interested in a two-digit random number) and read column-wise or row-wise.

For our example, let us use the first two columns of Exhibit 8.11. Starting 8.11. Starting from the top, we will read down the column. For the first simulation run we need two-

digit random numbers, one for the annual cash flow and the other for the project life. These number are 53 and 97 and the corresponding values for annual cash flow and project life are Rs. 3,000 and 9 years respectively. We go further in this manner. Table 6.11 shows the random numbers so obtained and the results of simulation.

Annual Cash Flow				Project Life			
Value	Probability	Cumulative Probability	Two digit random numbers	Value	Probability	Cumulative probability	Two digit random numbers
As				Years			
1,000	0.02	0.02	00 to 01	3	0.05	0.05	00 to 04
1,500	0.03	0.05	02 to 04	4	0.10	0.15	05 to 14
2,000	0.15	0.20	05 to 19	5	0.30	0.45	15 to 44
2,500	0.15	0.35	20 to 34	6	0.25	0.70	45 to 69
3,000	0.30	0.65	35 to 64	7	0.15	0.85	70 to 89
3,500	0.20	0.85	65 to 84	8	0.10	0.95	85 to 94
4,000	0.15	1.00	86 to 99	9	0.03	0.98	95 to 97
				10	0.02	1.00	98 to 99

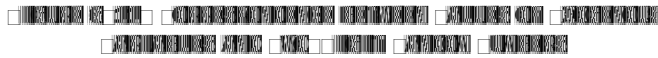

53479	81115	98036	12217	59526
97344	70328	58116	91964	26240
66023	38277	74523	71118	84892
99776	75723	03172	43112	83086
30176	48979	92153	38416	42436
81874	83339	14988	99937	13213
19839	90630	71863	95053	55532
09337	33435	53869	52769	18801
31151	58925	40823	41330	21093
67619	52515	03037	81699	17106



Annual Cash Flow			Project Life		
Run number	Random number flow	Corresponding value of annual	Random number project file	Corresponding value of	Net present value
1.	53	3,000	97	9	4277
2.	66	3,500	99	10	8506
3.	30	2,500	81	7	(829)
4.	19	2,000	09	4	(7660)
5.	31	2,500	67	6	(2112)
6.	81	3,500	70	7	4039
7.	38	3,000	75	7	1605
8.	48	3,000	83	7	1605
9.	90	4,000	33	5	2163
10.	58	3,000	52	6	66



Evaluation

An increasingly popular tool of risk analysis, simulation offers certain advantages:

- Its principal strength lies in its versatility. It can handle problems characterised by (i) numerous exogenous variables following any kind of distribution, and (ii) complex interrelationships among parameters, exogenous variables, and endogenous variables. Such problems often defy the capabilities of analytical methods.
- It compels the decision maker to explicitly consider the interdependencies and uncertainties characterising the project.
- Simulation, however, is a controversial tool which suffers from several shortcomings. It is difficult to model the project and specify the probability distributions of exogenous variables.
- Simulation is inherently imprecise. It provides a rough approximation of the probability distribution of net present value (or any other criterion of merit). Due to its imprecision, the simulated probability distribution may be misleading when a tail of the distribution is critical.
- A realistic simulation model, likely to be complex, would most probably be constructed by a management scientist, not the decision maker. The decision maker, lacking understanding of the model, may not use it.
- To determine the net present value in a simulation run the risk-free discount rate is used. This is done to avoid prejudging risk which is supposed to be reflected in the dispersion of the distribution of net present value. Thus the measure of net present value takes a meaning, very different from its usual one, that is difficult to interpret.

Decision Tree Analysis

The scientists at Vigyanik have come up with an electric moped. The firm is ready for pilot production which is estimated to cost Rs 8 million and take one year. If the results of pilot production are encouraging the next step would be to test market the product. This will cost Rs 3 million and take two months. Based on the outcome of the test marketing, a manufacturing decision may be taken. The firm may, however, skip the test marketing phase and take a decision whether it should manufacture the product or not. If the firm decides to manufacture the product commercially it is confronted with two options: a small plant or a large plant. This decision hinges mainly on the size of the market. While the level of demand in the short run may be gauged by the results of the test market, the demand in the long run would depend on how satisfied the initial users are.

If the firm builds a large plant initially it can cater to the needs of the market when demand growth is favourable. However, if the demand turns out to be weak, the plant would operate at a low level of capacity utilisation. If the firm builds a small plant, to

begin with, it need not worry about a weak market and the consequent low level capacity utilisation. However, if the market turns out to be strong it will have to build another plant soon (and thereby incur a higher total outlay) in order to save itself from competitive encroachment.

To analyse situations of this kind where sequential decision making in the face of risk is involved, decision tree analysis is a useful tool. This section discusses the technique of decision tree analysis.

Steps in Decision Tree Analysis

The key steps in decision tree analysis are:

1. Identifying the problem and alternatives
2. Delineating the decision tree
3. Specifying probabilities and monetary outcomes
4. Evaluating various decision alternatives.

Identifying the Problem and Alternatives To understand the problem and develop alternatives, information from different sources—marketing research, engineering studies, economic forecasting, financial analysis, etc.—has to be tapped. Imaginative effort must be made to identify the nature of alternatives that may arise as the decision situation unfolds itself and assess the kinds of *uncertainties* that lie ahead with respect to market size, market share, prices, cost structure, availability of raw material and power, technological changes, competitive action, and governmental regulation.

Recognising that risk and uncertainty are inherent characteristics of investment projects, persons involved in analysing the situation must be encouraged to express freely their doubts, uncertainties, and reservations and motivated to suggest contingency plans and identify promising opportunities in the emerging environment.

Delineating the Decision Tree The decision tree, exhibiting the *anatomy* of the decision *situation*, shows:

- The decision points (also called decision forks) and the alternative options available for experimentation and action at these decision points.
- The chance points (also called chance forks) where outcomes are dependent on a chance process and the and likely outcomes at these points.

The decision tree reflects in a diagrammatic form the nature of the decision situation in terms of alternative courses of action and chance outcomes which have been identified in the first step of the analysis.

A decision tree can easily become very complex and cumbersome if an attempt is *made* to consider the myriad possible future events and decisions. Such a decision tree, however, is not likely to be a very useful tool of analysis. Over-elaborate, It may obfuscate the critical issues. Hence an effort should be made to keep the decision tree somewhat simple so that the decision makers can focus their attention on major “future alternatives without being drowned in a mass of trivia. One must remember the advice

of Brealey and Myers.” Decision trees are like grapevines; they are productive only if vigorously pruned.

Specifying Probabilities and Monetary Values for Outcomes: Once the decision tree is delineated, the following data have to be gathered:

Probabilities associated with each of the possible outcomes at various chance forks.
Monetary value of each combination of decision alternative and chance outcome.

The probabilities of various outcomes may sometimes be defined objectively. For example, the probability of a good monsoon may be based on objective, historical data. More often, however, the possible outcomes encountered in real life are such that objective probabilities for them cannot be obtained. How can you, for example, define objectively the probability that a new product like an electric moped will be successful in the market? In such cases, probabilities have to be necessarily defined subjectively. This does not, however, mean that they are drawn from a hat. To be useful they have to be based on the experience, judgement, intuition, and understanding of informed and knowledgeable executives. Assessing the cash flows associated with various possible outcomes, too, is a difficult task. Again, the judgement of experts play an important role.

Evaluating the Alternatives: Once the decision tree is delineated and data about probabilities and monetary values gathered, decision alternatives may be evaluated as follows:

1. Start at the right-hand end of the tree and calculate the expected monetary value at various chance points that come first as we proceed leftward.
2. Given the expected monetary values of chance points in step 1, evaluate the alternatives at the final stage decision points in terms of their expected monetary values.
3. At each of the final stage decision points, select the alternative which has the highest expected monetary value and truncate the other alternatives. Each decision point is assigned a value equal to the expected monetary value of the alternative selected at that decision point.
4. Proceed backward (leftward) in the same manner, calculating the expected monetary value at chance points, selecting the decision alternative which has the highest expected monetary value at various decision points, truncating inferior decision alternatives, and assigning values to decision points, till the first decision point is reached.

Illustration

The technique of decision tree analysis may be explained with the help of an illustration. A wildcatter, evaluating a particular basin, is considering three alternatives: (i) He may drill. (ii) He may conduct a seismic experiment costing Rs 20,000 to find the nature of the underlying soil structure and decide on that basis. (iii) He may not do anything. If he drills, he is likely to find one of the following oil-bearing states: dry, wet, or soaking. A dry well hardly yields anything; a wet well provides a moderate quantity of oil; a soaking well generates a substantial quantity of oil.

If he conducts a seismic experiment, he can learn about the underlying soil structure before deciding whether to drill or not. The underlying soil structure in this case *may* be one of the following types: no structure, open structure, or closed structure. If no structure is discovered, the prospects of finding oil are bleak, if open structure is found the prospects of finding oil are fair, and if closed structure is discovered the prospects of finding oil are bright.

The decision tree corresponding to this situation is shown in Exhibit 6.13. It may be noted that, as a convention, a decision fork is represented *by* a square and chance fork by a circle.

The decision tree delineated, the next phase of analysis calls for gathering information about probabilities and monetary values associated with various outcomes in the decision tree. The wildcatter reviews his experiences, analyses statistics relating to oil discoveries, and consults geological experts. He comes up with the following information:

Probability for Various Oil Bearing States: If he drills without conducting seismic experiments probabilities for various oil bearing states are:

Oil bearing state	Probability
Dry	0.50
Wet	0.25
Soaking	0.25

Probabilities for Various Soil Structures: If he conducts a seismic experiment he is likely to find the underlying geological structures with probabilities mentioned against them:

Geological structure	Probability
No structure (NS)	0.40
Open structure (OS)	0.30
Closed structure (CS)	0.30

Relationship between the Underlying Structures and Oil Bearing States The relationship between the underlying geological structures and oil-bearing states expressed in terms of joint probabilities is as follows:

Oil Bearing State	Underlying Geological Structure			Marginal Probability of State
	No Structure	Open Structure	Closed Structure	
Dry	0.32	0.15	0.03	0.50
Wet	0.04	0.10	0.11	0.25
Marginal	0.04	0.05	0.16	0.25
Probability of geological structure	0.40	0.30	0.30	1.00

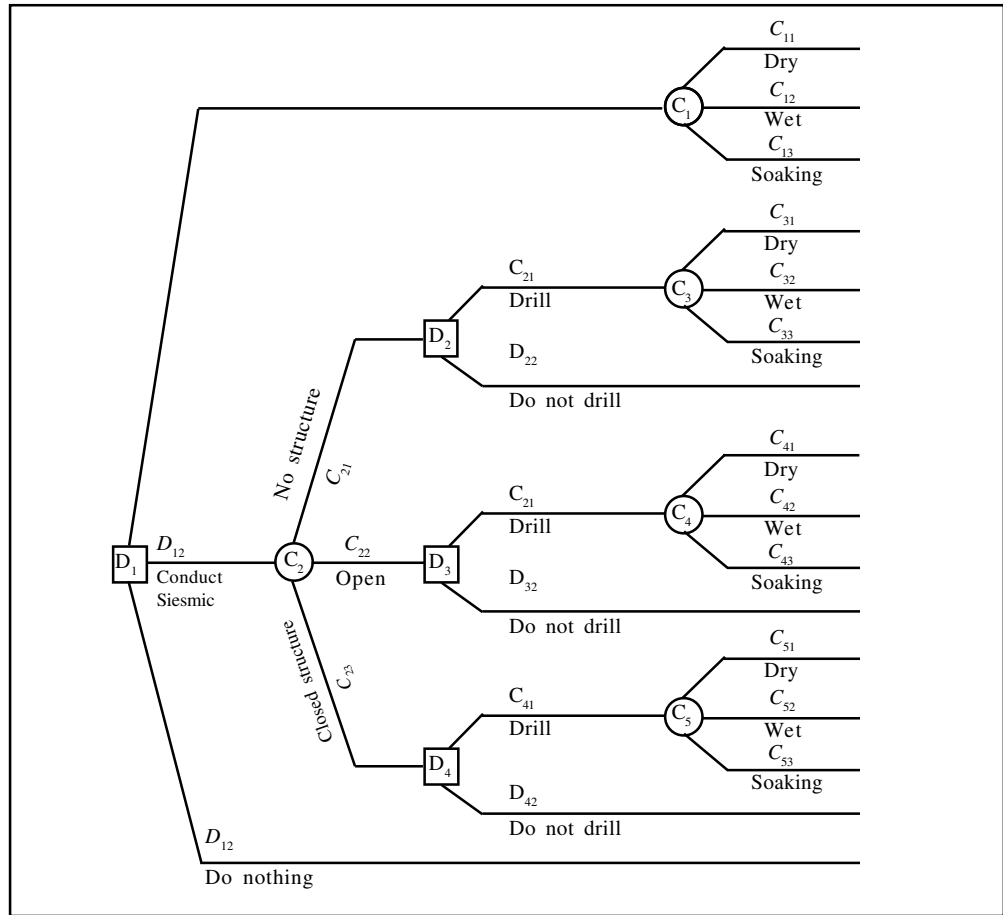

Monetary Values of Outcomes The net present value of cash flows, calculated at 12 per cent discount rate, associated with the three states for five years (which is the maximum duration of oil drilling) is given below:

State	Net present value (Rs. in million)
Dry	-0.6
Wet	0.8
Soaking	2.4

Exhibit 6.15 shows the decision tree incorporating information regarding probabilities and monetary values of outcomes discussed above. With this decision tree we evaluate the alternative courses of action as follows:

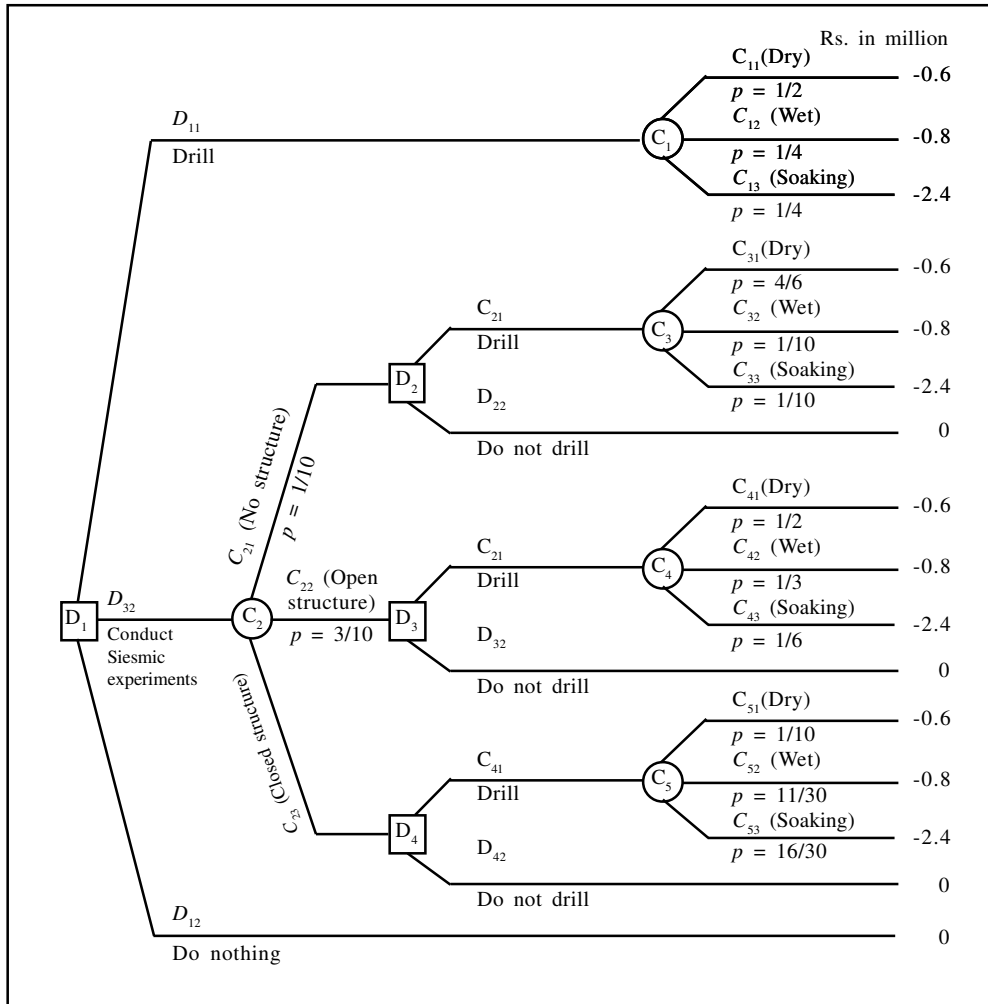

- Starting at the right-hand end of the tree, the expected monetary values (EMVs) at chance forks C_1 , C_3 , C_4 and C_5 , which come first at we proceed leftwards, are determined:

$EVM(C_1) = \text{Rs. } 0.5 \text{ million}$ $EMV(C_3) = \text{Rs. } -0.16 \text{ million}$

$EMV(C_4) = \text{Rs. } 0.367 \text{ million}$ $EMV(C_5) = \text{Rs. } 1.513 \text{ million}$

- Given the expected monetary values the alternatives at the last stage decision points and their expected monetary values are defined as follows:

Decision point	Alternatives (Rs. in million)	Expected monetary value
D_2	D_{21} (Drill)	-0.16
	D_{22} (Do not Drill)	0
D_3	D_{31} (Drill)	0.367
	D_{32} (Do not Drill)	0
D_4	D_{41} (Drill)	1.513
	D_{42} (Do not Drill)	0

3. On the basis of the above information, the alternatives selected at the decision points D_2 , D_3 and D_4 are D_2 (do not drill), D_{31} (drill), and D_{41} (drill) respectively. The values assigned to the decision points D_2 , D_{31} and D_4 are 0, Rs. 0.367 million, and Rs. 1.513 million respectively.
4. Proceeding leftward the expected monetary value at chance fork C_2 is calculated
- Expected monetary value at C_2 .
- $= 0.4 \times b + 0.3 \times 3.67 + 0.3 + 15.13$
- $= \text{Rs. } 0.564 \text{ million}$
5. Moving leftwards the first-state decision point is reached. The alternatives and their expected monetary values, at this decision point, are:

Alternatives	Expected Monetary Value (Rs. in million)
D_{11} (Drill)	0.5
D_{12} (conduct seismic experiments)	0.544
D_{13} (Do Nothing)	0

Looking at the expected monetary values as find that D_{12} (conduct seismic experiments) is the most desirable alternative at the first stage decision point.

Figure 6.16 shows the decision tree with expected values at chance points and decision points.

Based on the above evaluation of alternatives we find that the optimal decision strategy is as follows:

Choose D_{12} (conduct seismic experiment) at decision point D_1 and wait for the outcome at chance point C_2 . If the outcome at C_2 is C_{21} (no structure), then choose C_{22} (do not drill); if the outcome at C_2 is C_{22} (open structure), then choose D_{31} (drill), if the outcome at C_2 is C_{23} (closed structure), then choose D_{41} (drill).

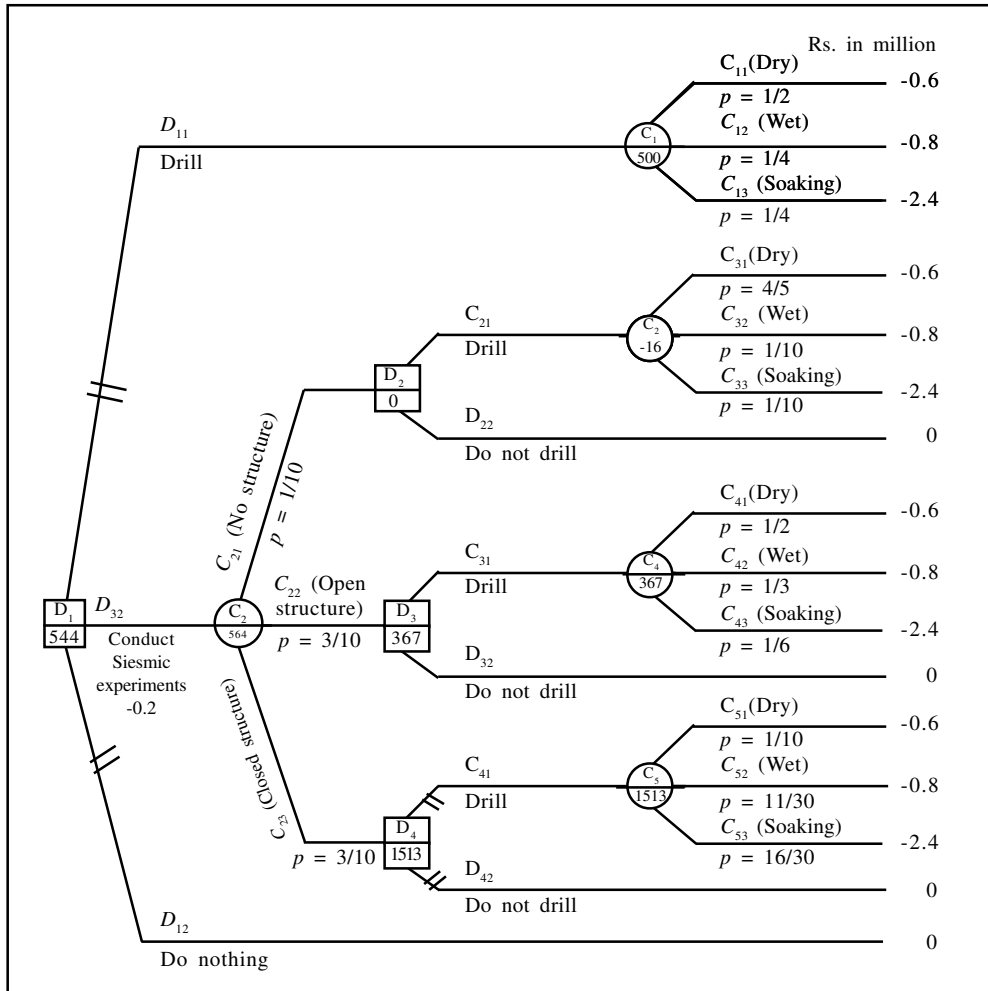

Following the above decision strategy, the decision maker, may, depending on the outcome at chance points, traverse paths as shown in Figure 6.17.

Path	Probability	Net present value (Rs.)
$D_{12} \rightarrow C_{21} \rightarrow D_{22}$	0.40	-20,000
$D_{12} \rightarrow C_{22} \rightarrow D_{31} \rightarrow D_{41}$	0.15	-620,000
$D_{12} \rightarrow C_{22} \rightarrow D_{31} \rightarrow D_{42}$	0.10	-780,000
$D_{12} \rightarrow C_{22} \rightarrow D_{31} \rightarrow D_{43}$	0.05	-2,380,000
$D_{12} \rightarrow C_{23} \rightarrow D_{41} \rightarrow D_{51}$	0.03	-620,000
$D_{12} \rightarrow C_{23} \rightarrow D_{41} \rightarrow D_{52}$	0.11	-780,000
$D_{12} \rightarrow C_{23} \rightarrow D_{41} \rightarrow D_{53}$	0.16	-2,380,000

Evaluation

Decision trees are useful for analysing a project that has the characteristics:

- Decision on continuing the project are made in well-defined stages.
- The outcomes at each stage fall into few broad classes.

- The probabilities and the cash flows associated with various outcomes can be specified at the beginning of the project. This means that the firm has experience of doing similar projects in the past.

Obviously, decision tree analysis requires enormous information before it can be applied. The oil drilling project is one case where the required information may be available. However, it may be much more difficult to apply decision tree analysis to a project where the product or service is new and the firm has very little information on how the market will respond to it. Decision trees are not easy to when investments are gradually made over a period of time rather than in a few well-defined stages.

Corporate Risk Analysis

A project's corporate risk is its contribution to the overall risk of the firm. Put differently, it reflects the impact of the project on the risk profile of the firm's total cash flows.

We know that the contribution of a security to portfolio risk depends on (i) the standard deviation of its returns and (ii) the correlation of its returns with the returns on the other securities included in the portfolio. In the same way, the corporate risk of a project depends on (i) the standard deviation of its returns and (ii) the correlation of its returns with the returns on the other projects of the firm.

On a stand-alone basis a project may be very risky but if its returns are not highly correlated or, even better, negatively correlated with the returns on the other projects of the firm, its corporate risk tends to be low.

Aware of the benefits of portfolio diversification, many firms consciously pursue a strategy of diversification. Hindustan Lever Limited, for example, has a diversified portfolio comprising, in the main, the following businesses: soaps and detergents, personal care products, edible oil, and tea.

The proponents of diversification argue that it helps in reducing the firm's overall risk exposure. As most businesses are characterised by cyclicalities it seems desirable that there are at least two to three different lines of business in a firm's portfolio. As someone put it vividly. "If you have three legs to your firm, you enjoy a reasonable degree of stability." This is simply another way of saying that don't put all your eggs in the same basket.

The logic of corporate diversification for reducing risk, however, has been questioned. Why should a firm diversify when shareholders can reduce risk through personal diversification. All that they have to do is to hold a diversified portfolio of securities or participate in a mutual fund scheme. Indeed, they can do it more efficiently.

There does not seem to be an easy answer. Although shareholders, can reduce risk through personal diversification there are some other benefits from corporate

diversification. Stable earnings and cash flows enable a firm to attract talent, to secure greater commitment from various stakeholders, to exploit tax shelters fully, and to check adverse managerial incentives. Hence most firms do look at the impact of investment proposals, particularly the major ones, on the overall risk profile of the firm.

Project Selection Under Risk

Once information about expected return (measured as net present value, or internal rate of return or some other criterion of merit) and variability of return (measured in terms of range or standard deviation or some other risk index) has been gathered, the next question is: Should the project be accepted or rejected? There are several ways of incorporating risk in the decision process: judgemental evaluation, payback period requirement, risk profile method, certainty equivalent method, and risk adjusted discount rate method.

Judgemental Evaluation

Often managers look at risk and return characteristic of a project and decide judgementally whether the project should be accepted or rejected, without using any formal method for incorporating risk in the decision making process. The decision may be based on the collective view of some group like the capital budgeting committee, or the executive committee, or the board of directors. If judgemental decision making appears highly subjective or haphazard, consider how most of us make important decisions in our personal life. We rarely use formal selection methods or quantitative techniques for choosing a career or a spouse or an employer. Instead, we rely on our judgement.

Payback Period Requirement

In many situations companies use NPV or IRR as the principal selection criterion, but apply a payback period requirement to control for risk. Typically, if an investment is considered more risky, a shorter payback is required even if the NPV is positive or IRR exceeds the hurdle rate. This approach assumes that risk is a function of time.

Ordinarily it is true that the further a benefit lies in future the more uncertain it is likely to be because economic and competitive conditions tend to change over time. However, risk is influenced by things other than the mere passage of time. Hence the payback period requirement may not be an adequate method for risk adjustment or control.

Risk Profile Method

To use this method, we first transform the probability distribution of net present value, an absolute measure, into the profitability distribution of profitability index, a relative measure. To illustrate this transformation, let us consider the profitability distribution of the net present value of a project, which involves an investment outlay Rs. 100,000

shown in Exhibit 6.17. Since profitability index is a linear transformation of net present value, the shape of its profitability distribution is identical to that of the probability distribution of net present value. The profitability distribution of profitability index for our project is shown in Exhibit 6.18. It should be noted that the x-axis of this exhibit shows the profitability index values corresponding to the net present values shown on the axis of Exhibit 6.18.

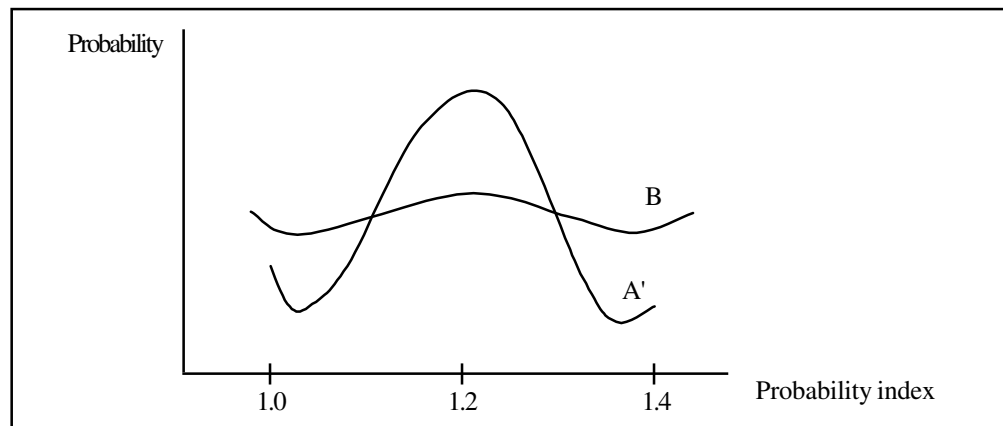
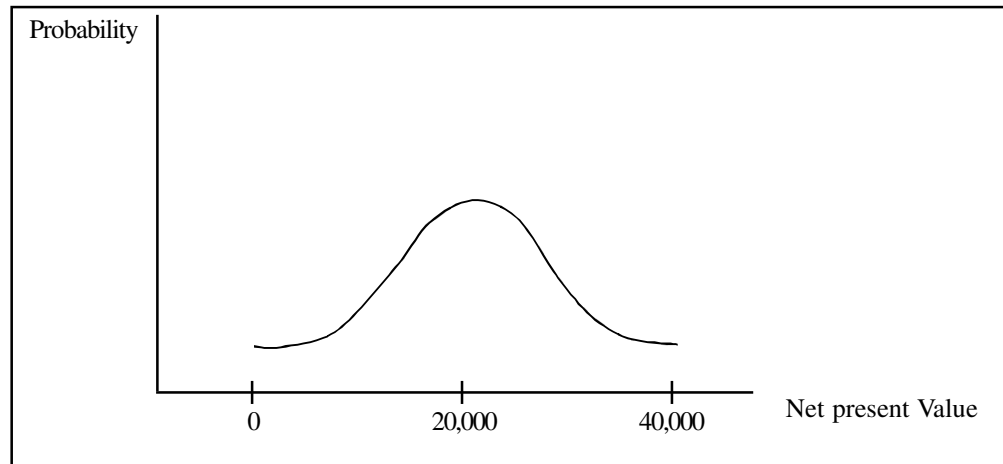

Having transformed the probability distribution of net present value into the probability distribution of profitability index, we compare the dispersion of the profitability index of the project with the maximum risk profile acceptable to management for the expected profitability index of the project. Suppose the maximum risk profile acceptable to management when the expected profitability index 1.20 is as shown by curve B in Exhibit 6.18. Comparing the dispersion of the profitability distributions A and B shown in Exhibit 6.18 we find the risk of the project is less than the maximal risk acceptable to management for the given level of expected profitability index. Hence the project is deemed worthwhile.

Note that the higher the expected value of profitability index, the greater the dispersion

that is acceptable to management. This is quite understandable. If the profitability index is high, one profitability that the net present value is negative (profitability index is less than 1) is negligible even if the dispersion is wide.

Risk Adjusted Discount Rate Method

The risk adjusted discount rate method calls for adjusting the discount rate to reflect project risk. If the risk of the project is equal to the risk of the existing investments of the firm, the discount rate used is the average cost of capital of the firm, if the risk of the project is greater than the risk of the existing investments of the firm, the discount rate used is higher than the average cost of capital of the firm; if the risk of the project is less than the risk of the existing investment of the firm the discount rate used is less than the average cost of capital of the firm. The risk adjusted discount rate is :

$$r_k = i + n + dk$$

where r_k = risk-adjusted discount rate for project k

i = risk-free rate of interest

n = adjustment for the firm’s normal risk

dk = adjustment for the differential risk of project k

It may be noted that $(1 + n)$ measures the firm’s cost of capital dk may be positive or negative depending on how the risk of the project under consideration compares with the existing risk of the firm.

The adjustment for the differential risk of project, k quite understandably, depends on management’s perception of the project risk and management’s attitude towards risk (risk return preference). A large pharmaceutical concern, for example, uses the following riskadjusted discount for various types of investments.

Investment category	Risk-adjusted discount rate
Replacement investments	Cost of capital
Expansion investments	Cost of capital + 3%
Investment in related lines	Cost of capital + 6%
Investment in new lines	Cost of capital + 10%

Once the project’s risk-adjusted discount rate (r_k) is specified, the project is accepted if its net present value, calculated as follows, is positive.

$$NPV = \sum_{t=1}^n \frac{\bar{A}_t}{(1 + r_k)^t} - I \quad \dots(8.7)$$

where NPV = net present value of project k

\bar{A}_t = expected cash flow for year t

r_k = risk adjusted discount rate for project k

Example The expected cash flows of a project, which involves an investment outlay of Rs. 1,000,000, are as follows:

Year	Cash flow Rs.
1.	200,000
2.	300,000
3.	400,000
4.	500,000
5.	200,000

The risk-adjusted discount rate for this project is 18 per cent. Is the project worthwhile?

The net present value of the project, using the risk-adjusted discount rate is:

$$\begin{aligned} \text{NPV} &= \frac{200,000}{(1.18)} + \frac{300,000}{(1.18)^2} + \frac{400,000}{(1.18)^3} + \frac{300,000}{(1.14)^4} + \frac{200,000}{(1.18)^5} - 1,000,000 \\ &= -\text{Rs. } 129,440 \end{aligned}$$

Since the net present value is negative the project is not worthwhile.

The risk-adjusted discount rate is commonly employed in practice. Firms use different discount rates, presumably related to the factor risk, for different types of investment projects. The discount rate is generally low for routine replacement investments, moderate for expansion investments, and high for new investments.

Despite its popularity, the risk-adjusted discount rate method suffers from two serious limitations: (i) It is difficult to estimate d_k consistently—often it is determined in an extremely *ad hoc* and arbitrary manner. (ii) This method assumes that risk increases with time at a constant rate. This assumption may not be very valid.

Certainty Equivalent Method

Before describing the certainty equivalent method let us understand the concept of certainty equivalent coefficient. Suppose someone presents you with a lottery the outcome of which has the following probability distribution.

Outcome Rs.	Probability Rs.
1,000	0.3
5,000	0.7

You are further asked: How much of a certain amount would you accept in lieu of this lottery? Let us say that your reply is: Rs. 3,000. This amount, Rs. 3,000 represents the certainty equivalent of the above lottery which has a expected value of Rs. 3,800 (Rs. $1,000 \times 0.3 + \text{Rs } 5,000 \times 0.7$) and a given distribution. The factor $3,000/3,800 (=0.79)$

is called the certainty coefficient. It reflects primarily two things: variability of outcomes and your attitude towards risk. Certainty equivalent coefficients transform expected values of uncertain flows into their certainty equivalents.

Under the certainty equivalent method, the net present value is calculated as follows:

$$NPV = \sum_{t=1}^n \frac{\alpha_t - \bar{A}_t}{(1+i)^t} - I \quad \dots(8.8)$$

where NPV = net present value

\bar{A}_t = expected cash flow for the year t

α_t = certainty equivalent coefficient for the cash flow of year t

i = risk free interest rate

I = initial investment (about which it is assumed that there is no uncertainty)

Example: Vazeer Hydraulics Limited is considering an investment proposal involving an outlay of Rs. 4,500,000. The expected cash flows and certainty equivalent coefficients are:

Year	Expected Cash Flow (Rs.)	Certainty Equivalent Coefficient
1	1000000	0.90
2	1500000	0.85
3	2000000	0.82
4	2500000	0.78

The risk-free interest rate is 5 per cent. Calculate the net present value of the proposal. The net present value is equal to:

$$\frac{1000000}{(1.05)} + \frac{1500000(0.85)}{(1.05)^2} + \frac{2000000(0.82)}{(1.05)^3} + \frac{2500000}{(1.05)^4} - 4500000$$

= Rs. 534570

The value of the certainty equivalent coefficient usually ranges between 0.5 and 1. A value of 1 implies that the cash flow is certain or the management is risk neutral. In industrial situations, however, cash flows are generally uncertain and managements usually risk-adverse. Hence the certainty equivalent coefficients are typically less than 1. An illustrative table of certainty equivalent coefficients for different types of investments is shown here.

	Certainty Coefficient		Equivalent	
	Year 1	Year 2	Year 3	Year 4
Replacement Investments	0.92	0.87	0.84	0.80
Expansion Investment	0.89	0.85	0.80	0.75
New Product Investment	0.85	0.80	0.74	0.68
R & D Investment	0.75	0.70	0.64	0.58

Replacement investments Expansion investments New product investments Research and development investments.

The certainty equivalent method is conceptually superior to the risk-adjusted discount rate method because it does not assume that risk increases with time at a constant rate. Each year's certainty equivalent coefficient is based on the level of risk characterising its cash flow. Despite its conceptual soundness it is not as popular as the risk-adjusted discount rate method. This is perhaps because it is inconvenient and difficult to specify a series of certainty equivalent coefficient but seemingly simply to adjust the discount rate. Notwithstanding *this* practical difficulty, the merits of the certainty equivalent method must not be ignored.

Analysis of Non Financial Aspects

Investment decisions are based on appraisal and evaluation techniques. Apart from technical and financial viability the project's economic and socio-political costs also matter.

Economic Aspects

Institutions and banks consider various economic factors before deciding to invest in a project. Various analytical tools exist to assist the decision maker in dealing with this situation. Among these tools are: cost-benefit analysis, risk-benefit analysis, risk-cost benefit analysis, project economic viability, opportunity cost and insurability limits. It is not suggested that these methods give exact results, but only that they reveal something of the nature of the underlying valuation.

For a completely satisfactory assessment of the cost and benefit aspects of the acceptability of risk, the assessment has to include evaluation of the following:

1. The total costs associated with each option.
2. The benefits in money terms associated with each option. It must be recognised that, at least initially, all the benefits may not be expressed directly in quantitative terms and there may be problems in converting qualitative statements about benefits into quantitative statements.
3. The costs in quantitative terms associated with the direct and indirect risks inherent in each option.
4. The errors and uncertainties associated with the estimates of costs and benefits.
5. The overall economic implications of the options considered.

Given the doubts about the feasibility of finding universal criteria for assessing the ranking that economic factors justify, it is suggested that for many cases ranking of acceptability of the economic factors could be made on the basis of the life cost and benefits, the calculation taking into account all direct and indirect costs and benefits. It

also has to be accepted that the calculation has to include a factor to allow for the risk of the project not being completed. Such a factor may be a compound factor, which includes allowance for all the features of the economic environment that may cause a project to fail.

It should be recognised that simply postulating a ranking criteria does not resolve the moral question of how the costs of benefits should be distributed, answer questions about the macro-economic significance of the proposal, or explain how the calculation should be made. The moral question is partly answered by assessing public reaction to a proposal and this point is discussed next under the heading of socio-political factors.

Socio-Political Aspects

When these decisions are considered from the point of view of society, they go beyond finding out cash inflows and outflows, the benefits to society are also worked out. For example, whenever a new capital intensive project is undertaken, its impact on the health of the society is seen in terms of environmental pollution, noise pollution, employment generation, etc.

Because of the nature of socio-political factors the problems involved in assessing their significance in decision making are quite different to the problems of assessing technical and economic factors. Socio-political aspects of a decision are concerned with what ought to be, and such decisions are quite different from technical judgements which are concerned with what can be done.

There are four methods for assessing acceptability of socio-political factors:

Method	Strengths	Limitation	Comment
Epidemiological studies	Relates what has already been accepted to environment of decision being considered	Past experience may not be relevant to the future. Does not represent a commitment by public involved	such studies identify past areas of concern, but do not predict present or future concerns or reaction to novel proposals
Consultation	Quick, provided appropriate machinery for consultation already exists. Can give a permanent form of contact between the public and the project and the decision makers	Those consulted may not represent the views of the whole community affected by the proposal in question. May be difficult to organise when national boundaries have to be crossed. Does not represent a commitment by the public involved	The success of this method depends upon those consulted being fully aware of the views of the community concerned and understanding the issues involved. Sometimes it can take two or three years to arrive at a view
Sampling	A sample survey can provide structured evidence about views on acceptability	Does not give every-one a chance to express their views about what is acceptable. Does not represent a commitment by	The sample surveyed must be taken directly from the population affected by the decision and for the results of

Contd...

		the public involved	the sampling process to really help the decision maker the population sampled must understand the issue involved
Voting	It is the most comprehensive way of establishing the views and wishes of a particular population	Not appropriate for all projects particularly small ones. Expensive and slow to arrange. Unless some form of compulsion is used not everyone will vote. Not necessarily binding on either party involved	If the result is clear it gives the decision maker positive guidance on the action the population consider should be taken. If the verdict is marginal the issue is not efficiently resolved for the decision maker

There are four methods for assessing acceptability of socio-political factors:

The conclusions that can be made about the problems of assessing socio-political factors are:

1. The socio-political factors related to complex decisions can be evaluated by carefully designed surveys.
2. Changes in opinion that take place over a period as short as two years can be detected by conventional survey methods.
3. Variations in views can be detected over a relatively small geographical area.
4. For an effective survey to be made the nature of the risk must be explained to the population being surveyed.
5. A sample opinion survey does not represent any kind of commitment by the people being surveyed, whereas voting procedures may be binding.
6. For the decision maker considering a major public project there may be considerable uncertainty about the viability of the assessment of public acceptability unless it is based on the results of a voting procedure.
7. For small non-conventional projects' surveys of the public's view of the acceptability of a proposal may not be justified.

Chapter-7

Working Capital Management

Concept, Need & Determinants

Working capital could be defined as the portion of assets used in current operations. The movement of funds from working capital to income and profits and back to working capital is one of the most important characteristics of business. This cyclical operation is concerned with utilisation of funds with the hope that they will return with an additional amount called Income. If the operations of a company are to run smoothly, a proper relationship between fixed capital and current capital has to be maintained.

Sufficient liquidity is important and must be achieved and maintained to provide the funds to pay off obligations as they arise or mature. The adequacy of cash and other current assets together with their efficient handling, virtually determine the survival or demise of the company. A businessman should be able to judge the accurate requirement of working capital and should be quick enough to raise the required funds to finance the working capital needs.

Working capital is often classified as Gross Working Capital and Net Working Capital. The former refers to the total of all Current Assets and the latter refers to the difference between Current Assets and Current Liabilities.

The maintenance of a sound Working Capital position is an important function of the Finance Department of the organisation. With the magnitude of business rising with globalisation, the quantum of working capital to be managed is on the increase. No wonder, working capital management is talked about more today than ever before.

Long-term investment decisions (capital budgeting) and long-term financing decisions are characterized by the facts that they (a) generally involve large amounts of money, and (b) are relatively infrequent occurrences. Decisions that come under the heading “short-term finance” are equally important, because, while typical decisions often don’t involve as much money, decisions are much more frequent. This is suggested in the results of a recent survey of CFOs.

	Ranked Greatest Importance	Average Time Allocated
Financial Planning	59%	35%
Working Capital Mgmt	27%	32%
Capital Budgeting	9%	19%
Long-Term Financing	5%	14%
Total	100%	

In defining short term finance, we focus on the cash flows connected with the operations of a company. Because the cash inflows and cash outflows are not synchronised, a company needs a temporary parking place for cash, which we can call a liquidity portfolio. This liquidity portfolio may consist of cash and marketable securities. Since cash flows for a company are uncertain, both in amount and timing, the amount of cash in temporary storage may not be adequate for all time periods. Thus, it is necessary to provide some backup liquidity for periods when the normal store of liquidity is insufficient.

Also there is a need to move cash from one point to another within a company. We need to have internal cash flows to connect these various inflows, outflows and sources of liquidity. The cash system of a company is the mechanism that provides the linkage between cash flows. The financial manager of the company has the responsibility, at least in part, to develop and maintain the policies and procedures necessary to achieve an efficient flow of cash for the company's operations.

Short term financial management thus encompasses decisions about activities that affect cash inflows, cash outflows, liquidity, backup liquidity, and internal cash flows. Many decisions of a company have a short term financial management aspect. For example, the decision to sell a bond issue in order to raise funds to finance an expansion in plant and equipment is clearly a long term decision. However, the decision on how to invest the proceeds from the bond issue until they are needed to pay for the construction is a short term financial decision.

The use of a 1-year time horizon to separate short term and long term decisions is arbitrary and, in some cases, ambiguous. To refine the definition of short term finance, it is helpful to examine the differences and interrelationships between the decisions that are classified as short term finance and those that are considered long term finance. Decisions usually classified as long term are difficult to reverse and essentially determine the basic nature of the business and how it will be carried out. Short term financial policies take the results of these decisions as a starting point and concentrate on how they can be efficiently and economically carried out. We can think of short term decisions as being more operational. Once implemented they are easier to change

Importance of Working Capital Management

Working capital management includes a number of aspects that make it an important topic for study, and we will now consider some of them.

Surveys indicate that the largest portion of a financial manager's time is devoted to the day-by-day internal operation of the firm; this may be appropriately subsumed under the heading "working capital management." since so much time is spent on working capital decisions, it is appropriate that the subject be covered carefully in managerial finance courses.

Characteristically, current assets represent more than half the total assets of a business firm. Because they represent a large investment and because this investment tends to be relatively volatile, current assets are worthy of the financial manager's careful attention.

Working capital management is particularly important for small firms. A small firm may minimize its investment in fixed assets by renting or leasing plant and equipment, but there is no way it can avoid an investment in cash, receivables, and inventories.' Therefore, current assets are particularly significant for the financial manager of a small firm. Further, because a small firm has relatively limited access to the long-term capital markets, it must necessarily rely heavily on trade credit by increasing current liabilities.

Relationship between Sales, Growth and current Assets

The relationship between sales growth and the need to finance current assets is close and direct. For example, if the firm's average collection period is 40 days and if its credit sales are 1,000 a day it will have an investment of 40,000 in accounts receivable. If sales rise to 2,000 a day the investment in accounts receivable will rise to 80,000. Sales increases produce similar immediate needs for additional inventories and, perhaps, for cash balances. All such needs must be financed, and since they arise so quickly, it is imperative that the financial manager keep himself aware of developments in the working capital segment of the firm. Of course, continued sales increases will require additional long-term assets, while must also be financed. However, fixed asset investments, while critically important to the firm in a strategic, long-run sense do not generally have the same urgency as do current asset investment

Original Concept of Working Capital

The term "working capital" originated at a time when most industries were closely related to agriculture. Processors would buy crops in the fall, process them, sell the finished product, and end up just before the next harvest with relatively low inventories. Bank loans with maximum maturities of one year were used to finance both the purchase and the processing costs, and these loans were retired with the proceeds from the sale of the finished products.

The situation is depicted in Figure 1. There fixed assets are shown to be growing steadily over time, While current assets jumps at harvest season, then decline during the year, ending at zero just before the next crop

is harvested. Short-term credit is used to finance current assets, and fixed assets are financed with long-term funds. Thus the top segment of the graph deals with working capital.

The figure represents, of course, an idealized situation- current assets build up gradually as crops are purchased and processed, inventories are drawn down less regularly, and ending inventory balances do not decline to zero. Nevertheless, the example does illustrate the general nature of the production and financing process, and working capital management consists of decisions relating to the top section of the graph- managing current assets and arranging the short-term credit used to finance them.

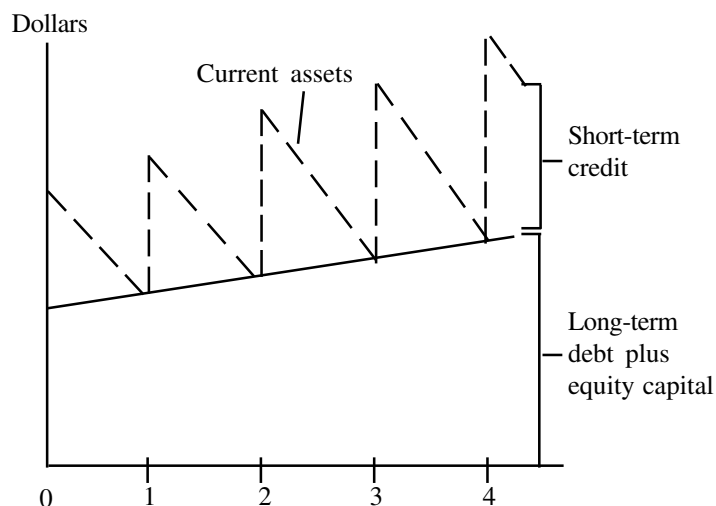

Extending The Working Capital Concept

As the economy became less oriented toward agriculture, the production and financing cycles of “typical” business changed. Although seasonal patterns still existed, and business cycles also caused asset requirements to fluctuate, it became apparent that current assets rarely, if ever, dropped to zero. This realization led to the development of the idea of “permanent current assets,” diagrammed in Figure -2. As the figure is drawn, it maintains the traditional notion that permanent assets should be financed with long-term capital, while temporary assets should be financed with short-term credit.

The pattern shown in Figures -1 and -2 was considered to be desirable because it minimizes the risk that the firm may be unable to pay off its maturing obligations. To illustrate, suppose a firm borrows on a one-year basis and uses the funds obtained to build and equip a plant. Cash flows from the plant (profit plus depreciation) are not sufficient to pay off the loan at the end of the year. So the loan, then the firm has problems. Had the plant been financed with long-term debt, however, cash flows would have been sufficient to retire the loan, and the problem of renewal would not have arisen. Thus, if a firm finances long-term assets with permanent capital and short-term assets with temporary capital, its financial risk is lower than it would be if long-term assets were financed with short-term debt.

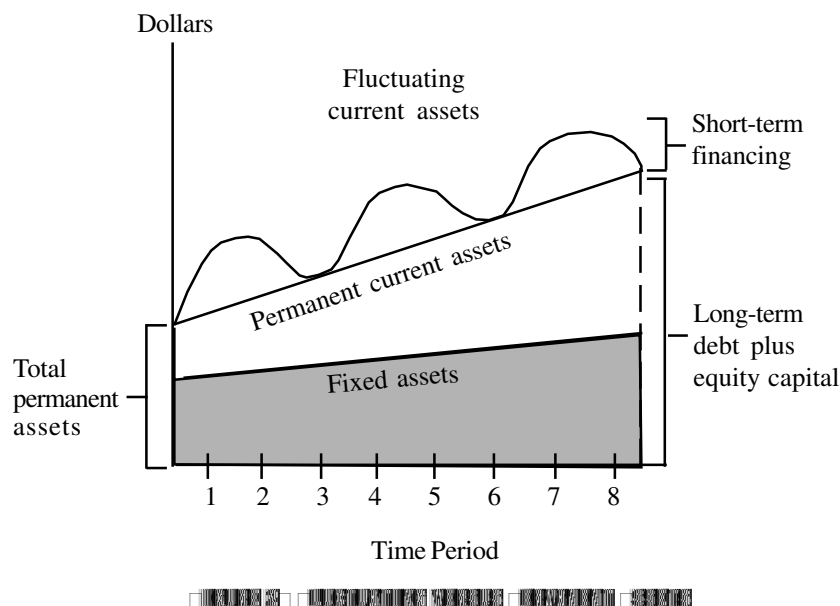

At the limit, a firm can attempt to match the maturity structure of its assets liabilities exactly. A machine expected to last for five years could be financed by a five-year loan ;a 20-year building could be financed by a 20-year mortgage bond; inventory expected to be sold in 20 days could be financed by a 20-day bank loan ;and so forth. Actually, of course, uncertainty about the lives of assets prevents this exact maturity matching . We will examine this point in the following sections.

Figure-2 shows the situation for a firm that attempts to match asset and liability maturity exactly. Such a policy could be followed, but firms may follow other maturity-matching policies if they desire. Figure-3, for example, illustrates the situation for a firm that finances all its fixed assets with –term capital but part of its permanent current assets with short-term credit.

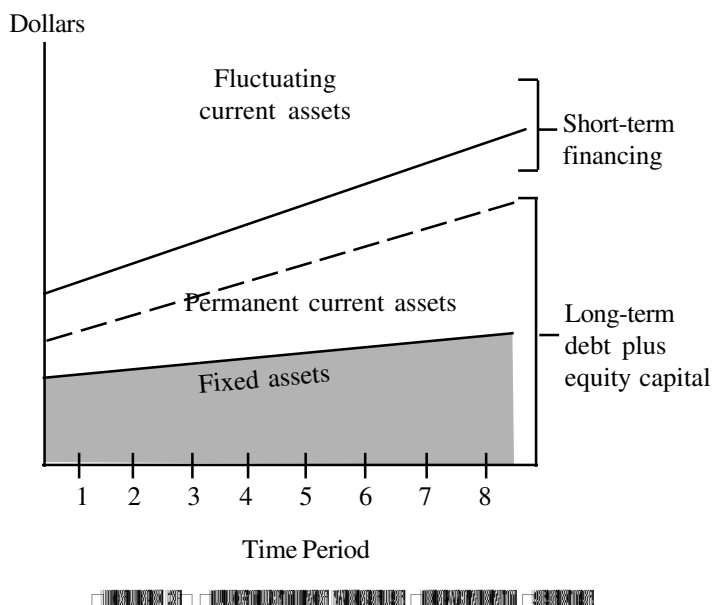

The dashed line could have even been drawn below the line designating fixed assets, indicating that all the current assets and part of the fixed assets are financed with short-term credit; this would be a highly aggressive, non-conservative position, and the firm would be very much subject to potential renewal problems.

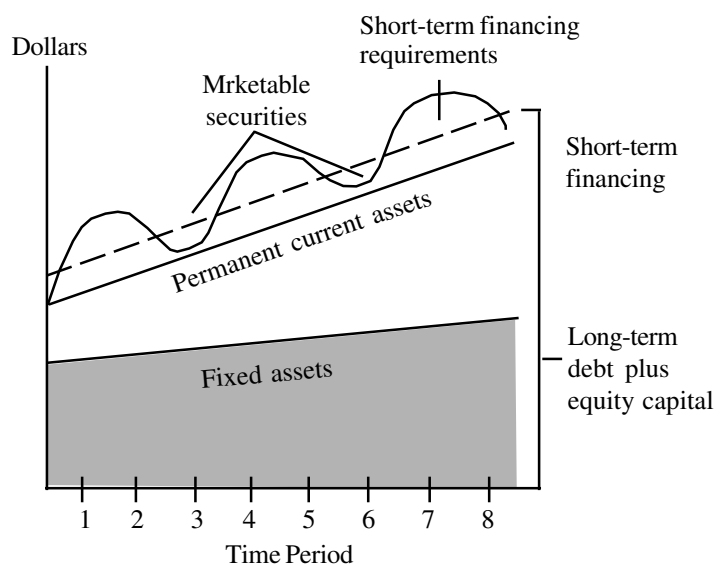

Alternatively, as in Figure-4, the dashed line could be drawn above the line designating permanent current assets, indicating that permanent capital is being used to meet seasonal demands. In this case, the firm used a small amount of short-term credit to meet its peak seasonal requirements, but it also meets a part of its seasonal needs by "storing liquidity" in the form of marketable securities during the off-season. The humps above the dashed line represent short-term financing, the troughs below the dashed line represent short-term security holdings.

Longer term versus Short-term Debt

The larger the percentage of funds obtained from long-term sources, the more conservative the firm's working capital policy. The reason for this, of course, is that during times of stress the firm may not be able to renew its short-term debt. This begins to explain why firms ever use short-term.

Concepts of Working Capital

There are two concepts of working capital- gross and net.

- **Gross working capital** refers to the firm's investment in current assets. Current assets are the assets which can be converted into cash within an accounting year (or operating cycle) and include cash, short-term securities, debtors, (accounts receivable or book debts) bills receivable and stock (inventory).
- **Net working capital** refers to the difference between current assets and current

liabilities. Current liabilities are those claims which are expected to mature for payment within an accounting year and include creditors (accounts payable), bills payable, and outstanding expenses. Net working capital can be positive or negative. A positive net working capital will arise when current assets.

The two concepts of working capital- gross and net – are not exclusive, rather they have equal significance from the management viewpoint. The gross working capital concept focuses attention on two aspects of current assets management; (a) How to optimise investment in current assets? (b) How should current be financed?

The consideration of the level of investment in current assets should avoid two dangers points- excessive and inadequate investment in current assets. Investment in current assets should be just adequate, not more not less, to the needs of the business firm. Excessive investment in current assets should be avoided because it impairs the firm's profitability, as idle investment earns nothing. On the other hand, inadequate amount of working capital can threaten solvency of the firm because of its inability to meet its current obligation. It should be realised that the working capital needs of the firm may be fluctuating with changing business activity. This may cause excess or shortage of working capital frequently. The management should be prompt to initiate an action and correct imbalances.

Another aspect of the gross working capital points to the need of arranging funds to finance current assets. Whenever a need of working capital funds arises due to the increasing level of business activity, or for any other reason, financing arrangement should be made quickly. Similarly, if suddenly, some surplus funds arise they should be allowed to remain idle, but should be invested in short-term securities. Thus the financial manager should have a knowledge of the sources of working capital funds as well as investment avenues where idle funds may be temporarily invested.

Net working capital is a qualitative concept. It indicates the liquidity position of firm and suggests the extent to which working capital needs may be financed by permanent sources of funds. Current assets should be sufficiently in excess of current liabilities to constitute a margin or buffer for maturing obligations within the ordinary operating cycle of a business. In order to protect their interests, short-term creditors always like a company to maintain current assets at a higher level than current liabilities. It is a conventional rule to maintain the level of current assets twice the level of current liabilities. However, the quality of current assets should be considered in determining the level of current assets vis-à-vis current liabilities. A weak liquidity position poses a threat to the solvency of the company and makes it unsafe and unsound. A negative working capital means a negative liquidity, and may prove to be harmful for the company's reputation. Excessive liquidity is also bad. It may be due to mismanagement of current assets. Therefore, prompt and timely action should be taken by management to improve and correct the imbalances in the liquidity position of the firm.

Net working capital concept also covers the question of judicious mix of long-term and short-term funds for financing current assets. For every firm, there is a minimum amount of net working capital which is permanent. Therefore, a portion of the working capital should be financed with the permanent sources of funds such as equity share capital, debentures, long-term debt, preference share capital or retained earnings. Management must, therefore, decide the extent to which current assets should be financed with equity capital and/or borrowed capital.

In summary, it may be emphasised that both gross and net concepts of working capital are equally important for the efficient management of working capital. There is no precise way to determine the exact amount of gross, or net working capital for any firm. The data and problems of each company should be analysed to determine the amount of working capital. There is no specific rule as to how current assets should be financed. It is not feasible in practice to finance current assets by short-term source only. 'Keeping in view the constraints of the individual company, a judicious mix of long and short-term finances should be invested in current assets. Since current assets involve cost of funds, they should be put to productive use.

The common definition and its implications

The most common definition of net working capital is *the difference between a firm's current assets and current liabilities*. As long as firm's current assets exceed its current liabilities, it has net working capital. Most firm must operate with some amount of net working capital; now much depends largely on the industry. Firms with very predictable cash flows, such as electric utilities, can operate with negative net working capital; however, most firms must maintain positive levels of net working capital.

The theoretical underpinning for the use of net working capital to measure a firm's liquidity is the belief that the greater the margin by which a firm's current assets cover its short-term obligations (current liabilities) the more able it will be to pay its bill as they come due. However, a problem arises because each current asset and current liability has a different degree of liquidity associated with it. Although the firm's current assets may not be converted into cash at precisely the point in time when it is needed the greater the amount of current assets present the more likely it is that some current asset will be converted into cash in order to pay a debt that is due.

It is the nonsynchronous nature of a firm's cash flows that makes net working capital necessary. The firm's cash outflows resulting from payment of current liabilities are relatively predictable. It generally learns when bills are due when an obligation is incurred. For instance, when merchandise is purchased on credit, the credit terms extended to the firm require payment at a known point in time. The same predictability is associated with notes payable and accruals, which have stated payment dates. What is difficult to predict are the firm's cash inflows. Predicting when current assets other

than cash and marketable securities will be converted into cash is quite difficult. The more predictable these cash inflows are the less net working capital a firm requires. It is because an electric utility has a very predictable pattern of cash inflows that it can operate with little or no net working capital. Firms with more uncertain cash inflows must maintain levels of current assets adequate to cover current liabilities.

It is the inability of most firms to match cash receipts and cash disbursements that makes sources of cash receipts, (current assets) that will more than cover current liabilities necessary. For example, if the GHI Company has the current position given in Table 1, the following situation may exist. All \$600 of the firm’s accounts payable, plus \$200 of its notes payable and \$100 in accruals, are due at the end of the current period. That this \$900 in outlays must be made is certain; how the firm will cover these outlays is not certain,. The firm can be sure that \$700 will be available since it has \$500 in cash and \$200 in marketable securities, which can be easily converted into cash. The remaining \$200 must come from the collection of an account receivable and/or the sale of inventory for cash. The firm cannot be sure when either a cash sale or the collection of an account receivable will occur. More uncertainty is associated with the collection of accounts receivable than with a cash sale. Although customers who have purchased goods on credit are expected to pay for them by the date specified in the credit arrangement, quite often they will not pay until a later date. Thus the cash flows associated with the purchases will not occur at the point in time they were expected.



<i>Current assets</i>		<i>Current liabilities</i>	
Cash	\$500	Accounts payable	\$600
Marketable securities	200	Notes payable	800
Accounts receivable	800	Accruals	200
Inventory	1,200	Total	\$1,600
Total	\$2,700		

Of course, some solution to this dilemma must exist. In order to have a higher probability of having sufficient cash to pay its bills, a firm should attempt to make sales, since in many cases they will result in the immediate receipt of cash and in other cases they will result in accounts receivable which will eventually be converted into cash. A level of inventory adequate to satisfy the probable demand for the firm’s products should be maintained. As long as the firm is generating sales and collecting receivables as they come due, sufficient cash should be forthcoming to satisfy its cash payment obligations. The GHI Company can increase the probability of its being able to satisfy its obligations by maintaining of some of these items into cash. The more accounts receivable and inventories there are on hand, the greater the probability that some of these items will be turned into cash. As a rule a certain level of net working capital

is often recommended in order to ensure that a firm will be able to pay bills. The GHI Company has \$1,100 of net working capital (\$2,700-\$1,600) which will most likely be sufficient to cover all its bills. Its current ratio of 1.69 (\$2,700/\$1,600), should provide sufficient liquidity as long as its accounts receivable and inventories are relatively liquid.

An alternate definition of net working capital

An alternate definition of net working capital is *that portion of a firm's current assets financed with long-term funds*. This definition can best be illustrated by a special type of balance sheet, like that for the GHI Company presented in Figure 5. The vertical axis of the balance sheet is a dollar scale on which all the major items on the firm's balance sheet are indicated.

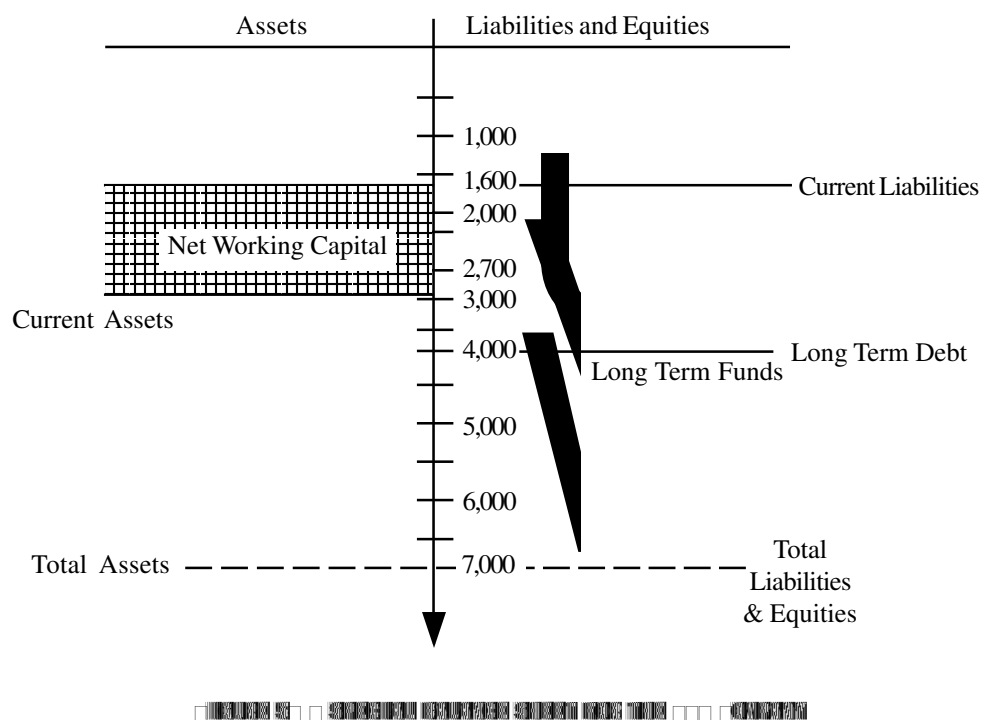

Figure 5 shows that the firm has current assets of \$2,700, fixed assets of 4,300 and total assets of \$7,000. It is also shows that the firm has current liabilities of \$1,600, long-term debts of \$2,400 (\$4,000-\$1,600), and stockholders' equity of \$3,000 (\$7,000-\$4,000). A firm's long-term debt plus its stockholders' equity represents its sources of long-term funds; the GHI Company's long-term funds equal \$5,400. The portion of the firm's current assets that was financed with long-term funds has been labeled "net working capital" in Figure 5. Analysis of this figure should enable the reader to better understand why a firm's net working capital can be thought of as the portion of current assets financed with long-term funds. Since current exceed current liabilities the amount of the excess must be financed with longer-term funds. The usefulness of this alternate definition will become more apparent in a later section of the chapter.

The Trade-off between Profitability and Risk

A trade-off exists between a firm's profitability and risk. *Profitability*, in this context, is measured by profits after expenses, while *risk* is measured by the probability that a firm will become technically insolvent (i.e., unable to pay bills as they come due). A firm's profits can be increased in two ways: (1) by increasing sales or (2) by decreasing costs. Both methods are discussed in the following pages. Costs can be reduced by paying less for an item or a service or by using existing resources more efficiently. Any reduction in costs should increase a firm's profits. Profits can also be increased by investing in more profitable assets, which are capable of generating higher levels of sales. An understanding of how profits are increased and reduced is critical to grasping the idea of a profitability-risk trade-off.

The risk of becoming technically insolvent is most commonly measured using either the amount of net working capital or the current ratio. In this chapter the amount of net working capital is used as a measure. It is assumed that *the greater the amount of net working capital a firm has, the less risky the firm is*. In other words, the more net working capital the more liquid the firm and, therefore, the less likely it is to become technically insolvent. The opposite is also considered to be true; lower levels of liquidity (i.e., net working capital) are associated with increasing levels of risk on the part of the business firm. The relationship between liquidity, net working capital, and risk is such that if either net working capital or liquidity increases the firm's risk decreases.

Some basic assumptions

In talking about a profitability-risk trade-off, a number of basic assumptions, which are generally true, must be made. The first concerns the nature of the firm being analyzed, the second concerns the basic differences in the earning power of assets, and the third concerns differences in the cost of various methods of financing. Each of these assumptions will be discussed separately.

The nature of the firm: The kind of firm we are talking about in this chapter is a *manufacturing firm*, not some type of merchandising or service organization. As we stated earlier in the text, the emphasis in this book is generally on manufacturing firms since they provide the best laboratory for investigating most of the basic principles of managerial finance.

The earning power of assets: A manufacturing firm is expected to be able to earn more on its fixed assets than on its current assets. Fixed assets represent the true earning assets of the firm. Plants, machines, and warehouses all enable the firm to generate finished products that can ultimately be sold for a profit. The firm's current assets, except for marketable securities, are not generally earning assets. Rather, they provide a buffer that allows the firm to make sales and extend credit. The importance

of current assets to the firm's operation was indicated in the preceding section; but without fixed assets to generate finished products that can be converted into cash, marketable securities, accounts receivable, and inventory, the firm could not operate. If the firm could earn more money by purchasing its inventory than by producing it or by investing its money in marketable securities then it should not be in the manufacturing business. In other words, if a firm cannot make more on fixed-asset investments than it makes on current-asset investments, it should sell all its fixed assets and use the proceeds to purchase current assets. In the following discussion it is assumed that *the firm can earn more on fixed assets than current assets*.

The cost of financing: The firm can obtain its required financing from either of two source: (1) current liabilities or (2) long-term funds. Current liabilities are sources of short-term funds; long-term debts and equity are sources of long-term funds. Since current liabilities generally consist of accounts payable, notes payable, and accruals, they are typically a cheap source of funds. Of the basic current liabilities, only notes payable normally have a stated cost. This is because notes payable represent the only *negotiated* form of borrowing. Accounts payable and accruals are cheaper sources of funds than notes payable since they do not normally have any type of interest payment associated with them.

Historically, in general, short-term funds cost less than long-term funds. In the recent past, interest rates have been increasing and people have expected higher interest rates in the future. Lenders with such expectations will typically provide short-term funds at rates below those charged for longer-term funds. They do this because short-term loans mature in less than a year, and they will get their money back in time to relend it at higher rates if interest rates do increase over the year. If interest rates are expected to increase in the future, a lender will charge a high enough rate of interest on a longer-term loan to compensate himself for tying up his money for a long period and losing future opportunities to lend money at increased rates.

Whenever lenders believe that future interest rates will rise, short-term borrowing rates are less than long-term rates. When future rates are expected to decline from a currently high rate, long-term rates are most often below short-term rates. Since increasing interest rates have prevailed in the most recent past, it is assumed in the following discussion that short-term funds are cheaper than longer-term funds. The fact that short-term sources of funds include not only notes payable but also accounts payable and accruals makes it much easier to accept this assumption, since accounts payable and accruals are virtually interest-free. The cheapest form of financing for the business firm is, therefore, short-term funds.

The nature of the trade-off between risk and profitability

If a firm wants to increase its profitability, it must also increase its risk. If it wants to

decrease risk, it must decrease profitability. The trade-off between these variables is such that regardless of how the firm increases its profitability through the manipulation of working capital the consequence is a corresponding increase in risk as measured by the level of net working capital. The effects of changing current assets and changing current liabilities on the firm's profitability-risk trade-off will be discussed separately prior to integrating them into an overall theory of working capital management.

Current assets The effects of the firm's level of current assets on its profitability-risk trade-off can be illustrated using a simple ratio—the ratio of the firm's current assets to its total assets. This ratio indicates what percentage of the firm's total assets are current. It may increase or decrease.

Effects of an increase As the ratio of current assets to total assets increases, both the firm's profitability and its risk decrease. Its profitability decreases because current assets are less profitable than fixed assets. The risk of technical insolvency decreases because, assuming that the firm's current liabilities do not change, the increase in current assets will increase its net working capital.

Effects of a decrease A decrease in the ratio of current assets to total assets will result in an increase in the firm's profitability since the firm's fixed assets, which “There have been periods when short-term rates have exceeded long-term rates, but these periods have been exceptions rather than the norm. The second quarter of 1974 through the first quarter of 1975 was a period during which the short-term were above long-term rates increase, generate higher returns than current assets. However, risk will also increase since the firm's net working capital will decrease with- the decrease in current assets. The consequences of a decrease in the ratio of current to total assets are exactly the opposite of the results of an increase in the ratio.

Example

The balance sheet for the GHI Company presented in Figure 5 indicated the following levels of assets, liabilities, and equity:

Assets		Liabilities and equity	
Current assets	\$2,700	Current liabilities	\$1,600
Fixed assets	4,300	Long-term debts	2,400
Total	\$7,000	Equity	3,000
		total	\$7,000

If the GHI Company earns approximately 2 percent on its current assets and 12 percent on its fixed assets, the current balance sheet configuration will allow it to earn approximate \$570 $[(2\% \cdot \$2,700) + (12\% \cdot \$4,300)]$ on its total assets. The firm's net working capital is currently \$1,100 $(\$2,700 - \$1,600)$. Its ratio of current assets to total assets is approximately .386 $(\$2,700 \div \$7,000)$.

If the firm decreases this ratio by investing \$309 more in fixed assets (and thus \$300 less in current assets), the new ratio of current to total assets is .343 $(\$2,400 \div \$7,000)$. The firm's profits on its total assets will then be \$600, $[2\% \cdot (\$2,400) + 12\% (\$4,600)]$.

Its net working capital will be-\$800, (\$2,400 — \$1,600). These results are tabulated in Table 2.

	Initial value	Value after change
Ratio of current to total assets	.386	.343
Profits on total assets	\$570	\$600
Net working capital	\$1,100	\$800

As Table 2 indicates, as the firm's ratio of current to total assets decreases from .386 to .343 its profits on its total assets increase from \$570 to \$600. Its risk, measured by the amount of net working capital, increases since its net working capital, and thus its liquidity, is reduced. This supports our earlier conclusions concerning the profitability-risk trade-off as related to the firm's current assets.

Current liabilities The effects of changing the level of a firm's current liabilities on its profitability-risk trade-off can also be demonstrated using a simple ratio—in this case, the ratio of the firm's current liabilities to its total assets. This ratio indicates the percentage of the firm's total assets that have been financed by current liabilities. It can either increase or decrease.

Effects of an increase As the ratio of current liabilities to total assets increases, the firm's profitability increases; but so does its risk. Profitability increases due to the decreased costs associated with using more short-term financing and less long-term financing. Since short-term financing involving accounts payable, notes payable, and accruals is less expensive than long-term financing, the firm's costs decrease, driving its profits higher. Assuming that the firm's current assets remain unchanged, its net working capital will decrease as its current liabilities increase. A decrease in net working capital means an increase in overall risk.

Effects of a decrease A decrease in the ratio of current liabilities to total assets will decrease the profitability of the firm, since a larger amount of financing must be raised using the more expensive long-term instruments. There will be a corresponding decrease in risk due to the decreased level of current liabilities, which will cause an increase in the firm's net working capital. The consequences of a decrease in the ratio of current liabilities to total assets are exactly the opposite of the results of an increase in this ratio.

Example

The balance sheet for the GHI Company in the preceding section can be used to show the effects of an increase in the firm's current liabilities. Initially the ratio of current liabilities to total assets is .229 ($\$1,600 \div \$7,000$). Assume that the firm's current liabilities cost approximately 3 per cent to maintain while the average cost of its ions-

term funds is 8 percent. Ignoring the changes made in the preceding example, the effect of shifting \$300 from long-term funds into current liabilities will increase current liabilities to \$1,900 (\$1,600 + \$300) and decrease long-term funds to \$5,100 (\$5,00 – \$300). The new ratio of current liabilities to total assets will be .271 (\$1,900 ÷ \$7,000). The result of this change will be a decrease in costs from the current level of \$480 [(3% · \$1,600) + (8% · \$5,400)] to \$465 [(3% · \$1,900) + (8% · \$5,100)]. The firm’s net working capital will decrease from the initial level of \$1,100 to \$800 (\$2,700 – \$1,900). These results of the increase in the ratio of current liabilities to total assets are tabulated in Table .3.



	Initial value	Value after change
Ratio of current liabilities to total assets	.229	.271
Cost of finance ^a	\$480	\$465
Net working capital	\$1,100	\$800

^aA decrease in any of the firm’s costs is equivalent to an increase in profitability by the same amount.

Table 3 illustrates that as the firm’s ratio of current liabilities to total assets increases from .229 to .271, the firm’s profits increase by \$15 (since its costs drop from \$480 to \$465). Meanwhile, the firm’s risk, measured by the level of net working capital, increases since its net working capital, or liquidity, decreases. This example illustrates only the effects of an increase in the ratio of current liabilities to total assets; a decrease would have an opposite effect.

Combined effects The combined effects of changes in current assets and changes in current liabilities can be measured by considering them simultaneously. In the preceding two examples, the effects of a decrease in the ratio of current to total assets and the effects of an increase in the ratio of current liabilities to total assets were illustrated. Both changes, considered independently, were shown to increase the firm’s profitability while increasing its risk. Logically, then, the combined effect of these actions should be to increase profits and risk and decrease net working capital. Table 4 illustrates the effects of combining the changes in current assets and current liabilities presented in Tables 2 and 3.



	Change in profits	Change in net working capital
Decrease in ratio of current to total assets	+\$30	-\$300
Increase in ratio of current liabilities to total assets	+\$15	-\$300
Net Effect	+\$45	-\$600

The value in Table 4 illustrate that the net effect of the two changes illustrated earlier is an increase in profits of \$45 and a decrease in net working capital (liquidity) of \$600. The trade-off here is obvious; the firm has increased its profitability by increasing its risk.

Table 4 shows that the firm's net working capital has been reduced from its initial level of \$1,100 to \$500. The firm's initial net profit can be thought of as the difference between the initial profits on total assets and the initial cost of financing. The initial profit on total assets was \$570, and the initial cost of financing was \$480. The initial net profit was therefore \$90 ($\$570 - \480). After the changes in current assets and current liabilities, the firm's profits on its total assets increased to \$600 while the cost of financing decreased to \$465. Its net profits, therefore, increased to \$135 ($\$600 - \465).

Finance Mix for working capital

The finance mix for workng capital is as follows:

- Current Assets (in descending order of liquidity):
 1. Cash
 2. Bank Balance
 3. Short term investments
 4. Trade Debtors
 5. Inventory
- Finished Goods
- Work in process
- Raw materials
- Stores & Spares
- 6. Pre-payments (Insurance, advances etc.)
- Current Liabilities:
 1. Trade Creditors
 2. Bank Overdraft or Cash Credit
 3. Short Term Borrowings
 4. Provision for taxes
 5. Provision for dividends

If current assets is the source from which current liabilities are to be met (as and when they fall due) during the course of business operations, then their strengths or weaknesses

will have significant bearing on the short run liquidity of the company. The importance of preserving this short term liquidity need not be emphasised and hence the need to manage the working capital.

Working parameters of a company influence the composition mix of various components of working capital. Whether the company is single product or multiple product? Whether the company does made-to-order work or it keeps stock in inventory? Whether it is a manufacturing company or a trading company? Whether it extends credit to its customers or does not? Whether it gets credit from its suppliers or does not? These are some of the questions that the company has to answer before it can really decide what levels of working capital that the company needs.

Single product companies normally operate with a lower quantum of working capital than a multi-product or multi-process companies. Trading operations, which get the payments in cash everyday, will necessarily have to manage their funds in a different way than a defence contractor who gets his payment after six months of the completion of the job. The management of funds will be altogether different for an infrastructure contractor whose payment terms are divided over a number of years.

Estimating working capital needs

The size of the company's investment in current assets is determined by its short-term financial policies. There are three types of policies that the company can use: 1) Flexible policy, 2) Restrictive policy and 3) A compromise policy that lies between the two.

- 1) A company keeping a flexible working capital policy means that the company is very liberal in its trade terms and has invested a large amount of funds in its operations. Flexible policy actions include:
 - Keeping large cash and securities balances
 - Keeping large amounts of inventory
 - Granting liberal credit terms
- 2) A company keeping a restrictive working capital policy is basically investing the lowest amount possible in the operations. for Restrictive policy actions include:
 - Keeping low cash and securities balances
 - Keeping small amounts of inventory
 - Allowing few or no credit sales
- 3) A company keeping a compromise working capital policy is realistically investing the money in the operations, neither has very large amount of cash nor runs always short of it like the restrictive policy does.

As the level of working capital increases, shortage costs go down while the carrying costs increase. This means that there would be a point where the sum total of carrying costs and the shortage costs would be the lowest. This is the optimum level of current assets that the company should keep.

In addition to the working parameters peculiar to a company that determine the quantum of required working capital, the following factors are also equally important:

1. **Profit levels:** A company earning huge amounts of profits can add to the working capital pool a larger quantum of funds. Such companies should, however, guard against the temptation of expanding beyond necessity and tying up the funds in unproductive capital expenditure or allow unnecessary increase in overheads. Generally it is seen that companies with high profit levels become lax in management of funds and usually mismanage by blocking funds excessively in stocks or debtors.
2. **Tax Levels and Planning:** Income Tax laws provide for payment of advanced tax in instalments. Excise and sales tax are payable at time of despatch of goods from the factory premises and the point of sales respectively. Any working capital management must make adequate and timely provision for the same as all of them involve cash outlays.
3. **Dividend Policies and Retained Earnings:** Dividend policy and retained earnings are directly related. There has to be a proper balance between the need to preserve cash resources and the obligation to satisfy shareholder expectations. Sometimes reserves are sacrificed for consistent dividends. Dividends once declared become a short time liability which has to be paid for in cash and this impact should be recognised in the working capital budget. On the other hand, it would be of little satisfaction to the general body of the shareholders to enjoy a liberal dividend at the expense of ploughing back the same for the growth of the company. Reserves in the form of retained earnings is a very important source of augmenting working capital.
4. **Depreciation Policy:** The extent to which depreciation provision is made during the course of making the financial statements has a direct bearing on the dividend policy and retained earnings. This so because a higher quantum of depreciation would leave lesser profits resulting in reduced retained earnings and dividends. The quantum of depreciation can be made to vary by choosing different methods to provide for the use of assets. As provisions for depreciation are actually only book entries and represent no cash flow at that time, they will have no bearing on working capital except to the extent they may hold back distribution of dividends.
5. **Expansion/Diversification Plans:** Addition of fixed assets to produce new

products, resorting to multiple shifts, or marginally adding to the plant and machinery are some of the common known ways to expand or diversify. Either of them represent an increase in production which calls for a higher quantum of spending of current assets, e.g. , you buy more raw material when you produce more and so on. In such situations, it is unwise to strain the internal resources for avoiding external funding.

6. **Price level changes in raw material and finished goods:** Inflation has got a direct bearing on the working capital. It depends to a large extent on the companies ability to readjust its own prices to cover the increase in the cost. In case the product or service requires government approval or is administered as far as the price is concerned, inflation may have a very significant bearing on the working capital needs. Inflation could be either recessive or expensive. During recessive inflation the companies are unable to sell more products due to lack of demand which results in the reduction of production. Inventories pile up and fixed expenses need a drastic reduction.
7. **Operating Efficiency of the company:** Operating efficiency of a company plays a major role in working capital management. An efficient company will have a shorter manufacturing period, long credit terms available from suppliers and minimal customers credit outstanding. If this is achieved then the quantum of working capital required will be naturally reduced.

The Working Capital Cycle

The Working Capital Cycle (or operating cycle) is the length of time between a company's paying for material entering into stock and receiving the inflow of cash from sales. The movements in the cycle are different for different types of companies and are dependent on the nature of the company.

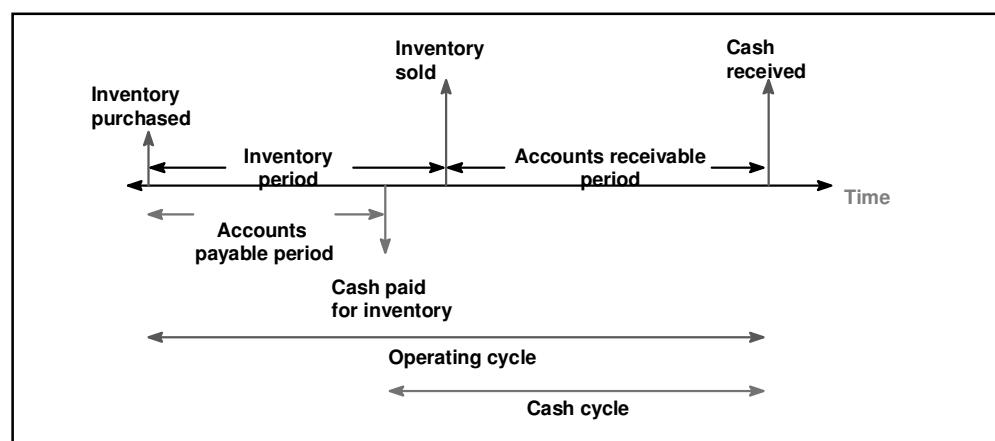

The operating cycle is the time period from inventory purchase until the receipt of cash. (Sometimes the operating cycle does not include the time from placement of the order until the arrival of stock.) The cash cycle is the time period from when cash is paid out, to when cash is received.

Computation of Working Capital

The two components of working capital (WC) are current assets (CA) and current liabilities (CL). They have a bearing on the cash operating cycle. In order to calculate the working capital needs, what is required is the holding period of various types of inventories, the credit collection period and the credit payment period.

Working capital also depends on the budgeted level of activity in terms of production/sales. The calculation of WC is based on the assumption that the production/sales is carried on evenly throughout the year and all costs accrue similarly. As the working capital requirements are related to the cost excluding depreciation and not to the sale price, WC is computed with reference to cash cost. The cash cost approach is comprehensive and superior to the operating cycle approach based on holding period of debtors and inventories and payment period of creditors. Some problems have been solved, however, using the operating cycle approach also. The steps involved in estimating the different items of CA and CL are as follows:

Estimation of Current Assets

Raw Materials Inventory The investment in raw materials inventory is estimated on the basis of Eq. 1.

Budgeted production (in units)	×	Cost of raw material(s) per unit	×	Average inventory holding period (months/days)
		12 months/365 days		(1)

Work-in-Process (W/P) Inventory The relevant costs to determine work-in-process inventory are the proportionate share of cost of raw materials and conversion costs (labour and manufacturing overhead costs excluding depreciation). In case, full unit of raw material is required in the beginning, the unit cost of work-in-process would be higher, that is, cost of full unit + 50 per cent of conversion cost, compared to the raw material requirement throughout the production cycle; W/P is normally equivalent to 50 per cent of total cost of production. Symbolically,

Budgeted production (In units)	×	Estimated work in-process cost per unit	×	Average time span of work-in-progress inventory (months/days)
		12 months/365 days		(2)

Finished Goods Inventory Working capital required to finance the finished goods inventory is given by factors summed up in Eq. 3.

Budgeted production (in units)	×	Cost of goods produced per unit (excluding depreciation)		Finished goods holding period (months/days)
		12 months/365 days		(3)

Debtors The WC tied up in debtors should be estimated in relation to total cost price (excluding depreciation, Symbolically,

Budgeted credit sales (in units)	×	Cast of sales per unit excluding depreciation	×	Average debt collection period (months/days)
		12 months/365 days		(4)

Cash and Bank Balances Apart from WC needs for financing inventories and debtors, firms also find it useful to have some minimum cash balances with them. It is difficult to lay down the exact procedure for determining such an amount. This would primarily be based on the motives for holding cash balances of the business firm, attitude of management toward risk, the access to the borrowing sources in times of need and past experience, and so on.

Estimation of Current Liabilities

The working capital needs of business firms are lower to the extent such needs are met through the current liabilities (other than bank credit) arising in the ordinary course of business. The important current liabilities (CL), in this context are, trade-creditors, wages and overheads:

Trade Creditors

Budgeted yearly production (in units)	×	Raw material requirement per unit	×	Credit period allowed by creditors (months/days)
		12 months/365 days		(5)

Note: Proportional adjustment should be made to cash purchases of raw materials.

Direct Wages

Budgeted yearly production (in units)	×	Direct labour cost per unit (months/days)	×	Average time-lag in payment of wages
		12 months/365 days		(6)

The average credit period for the payment of wages approximates to a half-a-month in the case of monthly wage payment: The first days' monthly wages are paid on the 30th day of the month, extending credit for 29 days, the second day's wages are, again,

paid on the 30th, extending credit for 28 days, and so on. Average credit period approximates to half a month.

Overheads (Other than Depreciation and Amortisation)

Budgeted yearly production (in units)	×	Overhead cost per unit	×	Average time-lag in payment of overheads (months/days)
		12 months/365 days		(7)

The amount of overheads may be separately calculated for different types of overheads. In the case of selling overheads, the relevant item would be sales volume instead of production volume.

The computation of working capital is summarised in following format

Format 7: Determination of Working Capital

(I) Estimation of Current Assets:

Amount

- (a) Minimum desired cash and bank balances
- (b) Inventories
 - Raw material
 - work-in-process
 - Finished Goods
- (c) Debtors
- Total Current Liabilities:

(II) Estimation of Current Liabilities:

- (a) Creditors**
- (b) Wages
- (c) Overheads
- Total Current Liabilities

(III) Net Working Capital (I-II)

Add margin for contingency

(IV) Net Working Capital Required

* If payment is received in advance, the Item would be listed in CL.

** If advance payment is to be made to creditors, the item would appear under CA. The same would be the treatment for advance payment of wages and overheads.

Examples

1. X & Y Ltd is desirous to purchase a business and has consulted you, and one point on which you are asked advise them. is the average amount of working capital which will be required in the first year's working.

You are given the following estimates and are instructed to add 10 per cent to your computed figure to allow for contingencies.

	Amount for the year
(i) Average amount backed up for stocks:	
Stocks of finished product	Rs 5,000
Stocks of stores and materials	8,000
(ii) Average credit given:	
Inland sales, 6 weeks' credit	3,12,000
Export sales, 1.5 weeks' credit	78,000
(iii) Average time lag in payment of wages and other outgoings:	
Wages, 1.5 weeks	2,60,000
Stocks and materials, 1.5 months	48,000
Rent and royalties, 6 months	10,000
Clerical staff, 0.5 month	62,400
Manager, 0.5 month	4,800
Miscellaneous expenses, 1.5 months	48,000
(iv) Payment in advance:	
Sundry expenses (paid quarterly in advance)	8,000
Undrawn profits on an average throughout the year	11,000

Set up your calculations for the average amount of working capital required.

Solution

Statement to determine Net Working Capital for X a Y Ltd

(a) Current assets:	
(i) Stock of finished product	Rs 5,000
(ii) Stock of stores and materials	8,000
(iii) Debtors:	
Inland sales (Rs 3,12,000 × 6/52)	36,000
Export sales, (Rs 78,000 × 3/104)	2,250
(iv) Advance payment of sundry expenses (Rs 8,000 × 1/4)	2,000
Total investment in current assets	53,250
(b) Current liabilities:	
(i) Wages (Rs 2,60,000 × 3/104)	7,500
(ii) Stocks/materials, (Rs 48,000 × 3/24)	6,000
(iii) Rent, royalties, (Rs 10,000 × 6/12)	5,000
(iv) Clerical staff (Rs 62,400 × 1/24)	2,600

(v) Manager (Rs 4,800 × 1/24)	200
(vi) Miscellaneous expenses (Rs 48,000 × 3/24)	6,000
Total estimate of current liabilities	<u>27,300</u>
(c) Net working capital:	
(i) Current assets-Current liabilities (A-B)	25,950
(ii) Add 10 per cent contingency allowance	2,595
Average amount of working capital required	<u>28,545</u>

Assumptions

- (i) A time period of 52 weeks/12 months has been assumed in year.
- (ii) Undrawn profit has been ignored in the working capital computation for the following reasons:
 - (a) For the purpose of determining working capital provided by net profit, it is necessary to adjust the net profit for income tax and dividends/drawings, and so on.
 - (b) Profit need not always be a source of financing working capital. It may be used for other purposes like purchase of fixed assets, repayment of long-term loans, and so on; Since the firm does not seem to have such uses, Rs 11,000 may be treated as source of working capital. But the WC will not change.
- (iii) Actual working capital requirement would be more than what is estimated here as the cash component of current assets is not known.

2. A Proforma cost sheet of a company provides the following particulars:

	Amount per unit
Elements of cost:	
Raw materials	Rs 80
Direct labour	30
Overhead	60
Total cost	<u>170</u>
Profit	30
Selling price	<u>200</u>

The following further particulars are available:

Raw materials in stock, on average, one month; Materials in process (completion stage, 50 per cent), on average, half a month; Finished goods in stock, on average, one month.

Credit allowed by suppliers is one month; Credit allowed to debtors is two months;

Average time-lag in payment of wages is 1.5 weeks and one month in overhead expenses; one-fourth of the output is sold against cash; cash in hand and at bank is desired to be, maintained at Rs 3,65,000.

You are required to prepare a statement showing the working capital needed to finance a level of activity of 1,04,00 units of production. You may assume that production is carried on evenly throughout the year, and wages and overheads accrue similarly.

Solution

Statement showing Determination of Net Working Capital

(A) Current assets:

(i) Stock of materials for 1 month: $(1,04,000 \times \text{Rs } 80 \times 4/52)$	Rs 6,40,000
(ii) Work-in-progress for 0.5 month:	
(a) Material $(1,04,000 \times \text{Rs } 80 \times 2/52) \times 0.50$	1,60,000
(b) Labour $(1,04,000 \times \text{Rs } 30 \times 2/52) \times 0.50$	60,000
(c) Overheads $(1,04,000 \times \text{Rs } 60 \times 2/52) \times 0.50$	1,20,000
(iii) Finished goods for 1 month: $(1,04,000 \times \text{Rs } 170 \times 4/52)$	13,60,000
(iv) Debtors for 2 months $(78,000 \times \text{Rs } 170 \times 8/52)$	20,40,000
(v) Cash in hand and at bank	3,65,000
Total investments in current assets	47,45,000

(B) Current liabilities:

(i) Creditor, 1 month's purchase of raw materials, (i.e. $1,04,000 \times \text{Rs } 80 \times 4/52$)	6,40,000
(ii) Average time-lag in payment of expenses	
(a) Overheads $(1,04,000 \times \text{Rs } 80 \times 4/52)$	4,80,000
(b) Labour $(1,04,000 \times \text{Rs } 30 \times 3/104)$	90,000
Total estimate of current liabilities	12,10,000

(C) **Net working capital** = Current; assets - Current liabilities(A-B) 35,36,000

Working notes and assumptions

- (i) 26,000 units have been sold for cash. Therefore, credit sales pertain to 78,000 units only.
 - (ii) Year has 52 weeks.
 - (iii) All overheads are assumed to be variable. Presence of depreciation element in overheads will lower the working capital requirement.
3. While preparing a project report on behalf of a client you have collected the following facts. Estimate the net working capital required for that project. Add 10 per cent to your compacted figure to allow contingencies:

	Amount per unit
Estimated cost per unit of production is:	
Raw material	Rs 80
Direct labour	30
Overheads (exclusive of depreciation, Rs 10 per unit)	60
Total cash cost	<u>170</u>

Additional information:

Selling price, Rs 200 per unit

Level of activity, 1,04,000 units of production per annum

Raw materials in stock, average 4 weeks

Work in progress (assume 50 per cent completion stage in respect of conversion costs and 100 per cent completion in respect of materials), average 2 weeks

Finished goods in stock, average 4 weeks

Credit allowed by suppliers, average 4 weeks

Credit allowed to debtors, average 8 weeks

Lag in payment of wages, average 1.5 weeks

Cash at bank is expected to be, Rs 25,000.

You may assume that production is carried on evenly throughout the year (52 weeks) and wages and overheads accrue similarly. All sales are on credit basis only.

Solution**Net Working Capital Estimate of a Project****(A) Current assets:**

(i) Raw materials in stock, $(1,04,000 \times \text{Rs } 80 \times 4/52)$	6,40,000
(ii) Work-in-progress	
(a) Raw material $(1,04,000 \times \text{Rs } 80 \times 2/52)$	3,20,000
(b) Direct Labour $(1,04,000 \times \text{Rs } 15 \times 2/52)$	60,000
(c) Overheads $(1,04,000 \times \text{Rs } 30 \times 2/52)$	1,20,000
(iii) Finished goods stock: $(1,04,000 \times \text{Rs } 170 \times 4/52)$	13,60,000
(iv) Debtors: $(1,04,000 \times \text{Rs } 170 \times 8/52)$	27,20,000
(v) Cash at bank	25,000
Total investment in current assets	<u>52,45,000</u>

(B) Current liabilities:

(i) Creditors, average 4 weeks: $(1,04,000 \times \text{Rs } 80 \times 4/52)$	6,40,000
(ii) Lag in payment of wages $(1,04,000 \times \text{Rs } 30 \times 3/104)$	90,000
Total current liabilities	<u>7,30,000</u>
(C) Net working capital: Current assets - Current liabilities	45,15,000
Add 10 per cent contingencies	4,51,000
	<u><u>Rs 49,66,500</u></u>

Working notes

A full unit of raw material is required at the beginning of the manufacturing process and, therefore, total cost of the material, that is, Rs 80 per unit has been taken into consideration, while in the case of expenses, viz. direct labour and overheads, the unit has been finished only to the extent of 50 per cent. Accordingly, Rs 15 and Rs 30 have been charged for direct labour and overheads respectively in valuing work-in-process.

4. A newly formed company has applied for a loan to a commercial bank for financing its working capital requirements. You are requested by the bank to prepare an estimate of the requirements of the working capital for the company. Add 10 per cent to your estimated figure to cover unforeseen contingencies. The information about the projected profit and loss account of this company is as under:

Sales		Rs 21,00,000
Cost of goods sold		<u>5,30,000</u>
Gross profit		<u>5,70,000</u>
Administrative expenses	Rs 1,40,000	
Selling expenses	<u>1,30,000</u>	
		<u>2,70,000</u>
Profit before tax		<u>3,00,000</u>
Provision for tax		1,00,000
Note: Cost of goods sold has been derived as follows:		
Materials used		8,40,000
Wages and manufacturing expenses		6,25,000
Depreciation		<u>2,35,000</u>
		17,00,000
Less stock of finished goods (10 per cent-not yet sold)		<u>1,70,000</u>
		<u><u>15,30,000</u></u>

The figures given above relate only to the goods that have been finished and not to work in progress goods equal to 15 per cent of the year's production (in terms of physical units) are in progress on an average, requiring full materials but only 40 per cent of other expenses. The company believes in keeping two months consumption of material in stock; Desired cash balance, Rs 40,000.

Average time-lag in payment of all expenses is 1 month; suppliers of materials extend 1.5 months credit; sales are 20 per cent cash; rest at two months credit; 70 per cent of the income tax has to be paid in advance in quarterly instalments.

You can make such other assumptions as you deem necessary for estimating working capital requirements.

Solution

Net Working Capital Estimate of a Company

(A) Current assets:

(i) Raw material in stock =: (Rs 8,40,000 × 2/12) Rs 1,40,000

(ii) Work-in-progress:

(a) Raw material (Rs 8,40,000 × 15/100) 1,26,000

(b) Wages and manufacturing expenses
=: (Rs 6,25,000 × 0.4 × 15/100) 37,500

(iii) Stock of finished goods:

[Rs 1,70,000 - Rs 23,500 (0.10 × Rs 2,35,000, depreciation) 1,46,500

(iv) Debtors

(a) Cost of goods sold Rs 15,30,000

Less depreciation (Rs 2,35,000 × 0.9) 2,11,500

13,18,500

(b) Administrative expenses 1,40,000

(c) Selling expenses 1,30,000

Total 15,88,500

Credit sales (4/5 of Rs 15,88,500) = Rs 12,70,800

(12,70,800 × 2/12) 2,11,800

(v) Cash required 40,000

Total investment in current assets 7,01,800

(B) Current liabilities:

(i) Average time-lag in payment of expenses:

(a) Wages and manufacturing expenses 6,25,000

(b) Administrative expenses	1,40,000	
(c) Selling expenses	1,30,000	
	8,95,000/12	74,583
(ii) Creditors (Rs 8,40,000 × 3/24)		1,05,000
Total current liabilities		1,79,583
(c) Net working capital: Current assets – Current liabilities (A-B)		
5,22,217		
Add 10 per cent contingencies		52,222
		5,74,439

Assumptions and working notes

- (i) Depreciation is not a cash expense and, therefore, excluded from cost of goods sold for the purpose of determining work-in-progress, finished goods and investment in debtors.
 - (ii) Since profit is not taken into consideration in our calculation as a source of working capital, income tax has been
5. From the following projections of XYZ & Ltd for the next year, you are required to determine the working capital required by the company.

Annual sales, Rs 14,40,000

Cost of production (including depreciation of Rs 1.20,000), Rs 12,00,000

Raw material purchases, Rs 7,05,000

Monthly expenditure, Rs 30,000

Estimated opening stock of raw materials, Rs 140,000

Estimated closing stock of raw materials, Rs 1,25,000

Inventory norms:

Raw materials, 2 months

Work-in-process, 1/2 month

Finished goods, 1 month

The firm enjoys a credit of half-a-month on its purchases and allows one month credit on its supplies. On sales orders, the company receives an advance of Rs 15,000.

You may assume that production is carried out evenly throughout the year and minimum cash balance desired to be maintained is Rs 35,000.

Chapter-8

Cash Management and Marketable Securities

A thorough understanding of why and how a firm holds cash requires an accurate conception of how cash flows into and through the enterprise. Figure depicts the process of cash generation and disposition in a typical manufacturing setting. The arrows in the Jingle show the flow is, whether the cash balance is being increased or decreased.

The firm experiences irregular increases in its cash holdings from several external sources. Funds can be obtained in the financial markets from the sale of securities, such as bonds, preference shares and equity shares or through debt contracts with lenders such as commercial banks. These irregular cash inflows do not occur on a daily basis. They tend to be episodic, in that the financing arrangements that give rise to them are effected at wide intervals. The reason is that external financing contracts usually involve huge sums of money stemming from a major need identified by the company's management, and these needs do not occur every day. For example, a new product might be in the process of launched, or a plant expansion might be required to provide added productive capacity.

In most organisations the financial officer responsible for cash management also controls the transactions that affect the firm's investment in marketable, securities. As excess cash becomes temporarily available, marketable securities will be purchased. When cash is in short supply, a portion of the marketable securities portfolio will be liquidated.

Whereas the irregular cash inflows are from external sources, the other main sources of cash to the firm arise from internal operations and occur on a more regular basis. Over long periods the largest receipts will come from accounts receivable collections and to a lesser extent from direct cash sales of finished goods. Many manufacturing concerns also generate cash on a regular basis through the liquidation of scrap or obsolete inventory. In the automobile industry large and costly machines called chip crushers grind waste metal fine scrap that brings considerable revenue to the major producers. At various times fixed assets may also be sold, thereby generating some cash inflow. This is not a large source of funds except in unusual situations where, for instance, a complete plant renovation may be taking place.

Apart from the investment of excess cash in near-cash assets, the cash balance will experience reductions for three key reasons. First, on an irregular basis withdrawals will be made to (1) pay cash dividends on preferred and common shares, (2) meet

interest requirements on debt, (3) repay the principal borrowed from creditors, (4) buy the firm's own shares in the financial markets for use in executive compensation plans or as an alternative to paying a cash dividend, and (5) pay tax. Again, by an "irregular basis" we mean items not occurring on a daily or highly frequent schedule. Second, the company's capital expenditure program will designate that fixed assets be acquired at various intervals. Third, inventories will be purchased on a rather regular basis to ensure a steady flow of finished goods off the production line. Note that the investment in fixed assets with the inventory account does involve depreciation. This indicates that a portion of the cost of fixed assets is charged against the product coming off the assembly line. This cost is subsequently recovered through the sale of finished goods inventory, as the product selling price will be set by management to cover all of the costs of production, including depreciation.

The variety of influences we have mentioned that constantly affect the cash balance held by the firm can be synthesized in terms of the classic motives for holding cash, as identified in the literature of economic theory.

Motives for Holding Cash

In a classic economic treatise John Maynard Keynes segmented the firm's or any economic unit's demand for cash into three categories: (1) the transactions motive, (2) the precautionary motive, and (3) the speculative motive.

Transactions Motive

Balances held for transactions purposes allow the firm to dispense with cash needs that arise in the ordinary course of doing business. Transactions balances would be used to meet the irregular outflows as well as the planned acquisition of fixed assets and inventories.

The relative amount of transactions cash held will be significantly affected by the industry in which the firm operates. If revenues can be forecast to fall within a tight range of outcomes, then the ratio of cash and near cash to total assets will be less for the firm than if the prospective cash inflows might be expected to vary over a wide range. In this regard, it is well known that utility concerns can forecast cash receipts quite accurately, owing to their demand for their services arising from their quasi-monopoly status. This enables them to stagger their billings throughout the month and to time to coincide with their planned expenditures. Inflows and outflows of cash are thereby synchronised. Thus, we would expect the cash holdings of utility firms relative to sales or assets to be less than those associated with a major retail chain that sells groceries. The concern experiences a large number of transactions each day, almost all of which involve an exchange of cash.

The Precautionary Motive

Precautionary balances are a buffer stock of liquid assets. This motive for holding cash related to the maintenance of balance to be used to satisfy possible, but as yet indefinite, needs.

In our discussion of transactions balances we saw that cash flow predictability could affect a firm's cash holdings through synchronisation of receipts and disbursements. Cash flow predictability also has a material influence on the firm's demand for cash through the precautionary motive. The airline industry provides a typical illustration. Air passenger carriers are plagued with a very high degree of cash flow uncertainty. The weather, rising fuel costs, and continual strikes by operating personnel make cash forecasting a most difficult activity for any airline company. The upshot of this problem is that because of all the things that might happen, the minimum cash balances desired by the management of the air carriers tend to be large.

In addition to cash flow predictability the precautionary motive for holding cash is affected by the firm's access to external funds. Especially important are those cash sources that can be tapped on short notice. Book banking relationships and established lines of credit can reduce the firm's need to keep cash on hand. This unused borrowing power will obviate somewhat the need to invest in precautionary balances.

In actual business practice the precautionary motive to a large extent by the holding of a portfolio of liquid assets, not just cash. In large corporate organisation, funds may flow either into or out of the marketable securities portfolio on a daily basis. Because actual rate of return can be earned on the near-cash assets, compared with a zero rate of return available on cash holding, it is logical that the precautionary motive will be met in part by investment in marketable securities.

The Speculative Motive

Cash is held for speculative purposes in order to take advantage of hoped for, profit making situations. Construction firms that erect private dwellings will at times accumulate cash in anticipation of a significant drop in lumber costs. If the price of building supplies does drop, the companies that build up their cash balances stand to profit by purchasing materials in large quantities. This will reduce their cost of goods sold and increase their net profit margin. Generally, the speculative motive is the least important component of a firm's preference for liquidity. The transactions and precautionary motive account for most of the reasons why a company holds cash balances.

Decisions that concern the amounts of liquid assets to hold rest with the financial officer responsible for cash management. A number of factors that can be expected to influence the financial officer's investment in cash and near cash have just been reviewed. Not

all of these factors affect every firm. Moreover, factors that do affect many companies will do so in differing degrees. Since the executives responsible for the ultimate cash management choices will have different risk-bearing preferences, we might expect that liquid asset holding among firms would exhibit considerable variation.

Cash Management Objectives and Decisions

Risk Return Trade off

A company wide cash management must be concerned with minimising the firm's risk of insolvency. In the context of cash management the term insolvency is used to describe the situation where the firm is unable its maturing liabilities on time in case the company is technically insolvent in that it lacks the necessary liquidity to make prompt payment on its current debt obligations. This problem could be met quite easily by carrying large cash balances to pay the bills that come due. Production, after all, would soon come to halt should payments for raw material purchases be continually late or omitted entirely. The firm's suppliers would cut off further shipments. In fact, the fear of irritating a key supplier by being past due on the payment of a trade payable does cause some financial managers to invest in too much liquidity.

The management of the company's cash position, though, is one of those major problem areas where you are criticized if you don't and criticized if you do. True, the production process will eventually be halted should too little cash be available to pay bills. If excessive cash balances are carried, however, the value of the enterprise in the financial marketplace will be suppressed of the large cost of Income forgone. The explicit return earned on idle cash balances is zero.

The financial manager must strike an acceptable balance between holding too much cash and too little cash. This is the focal point of the risk-return tradeoff. A large cash investment minimises the chances of insolvency but penalises company profitability. A small cash investment frees excess balances for investment in both marketable securities and longer-lived assets; this enhances company profitability and thereby the value of the firm's common shares but increases the chances of running out of cash.

Objectives

The risk-return tradeoff can be reduced to two prime objectives for the firm's management system:

1. Enough cash must be on hand to dispense effectively with the disbursement needs that arise in the course of doing business.
2. The firm's investment in idle cash balances must be reduced to a minimum.

Evaluation of these operational objective, and a conscious attempt on the part of management to meet them, gives rise to the needs for some typical cash management decisions.

Decisions

Two conditions would allow the firm to operate for extended periods with cash balances near a level of zero: (1) a completely accurate forecast of net cash flows over the planing horizon and (2) perfect synchronisation of cash receipts and disbursements.

Cash flow forecasting is the initial step in any effective cash management programme. This is usually accomplished by the finance function's evaluation of data supplied by the marketing and production functions in the company. The device used to forecast the cash flows over the planning period is the cash budget. Cash-budgeting procedure are explained in the latter part of new chapter it is emphasized though, that the net cash flows pinpointed in the formal cash budget are mere estimates, subject to considerable variation. Thus, a totally accurate cash flow projection is only an ideal, net a reality.

Our discussion of the cash flow process depicted in Figure 1 showed that cash inflows and outflows are not synchronised. Some inflows and outflows are irregular; other are more continual. Some finished goods are sold directly for cash but more likely the sales will be on account. The receivables, then will have to be collected before a cash inflow is realised raw materials have to be purchased, but several suppliers are probably used, and each may have its own payment date further, no law of doing business collections to coincide with raw material payments dates. So the second criterion that would permit operation of the firm with extremely low cash balances is not met in actual practice either.

Given that the will as a matter, of necessity, invest in some cash balances, certain types of decisions related to the size of those balances dominate the cash management process. These include formulation of answers to the following questions:

1. What can be done to speed up cash collections and show down or better control cash outflows?
2. What should be the composition of our marketable securities portfolio?
3. How should our investment in liquid assets be split between actual cash holdings and marketable securities?

Cash Forecasting

One objective of cash management is clearly to ensure that the business does not run short of cash. There must always be enough cash available to meet liabilities as they fall due. Equally the business should not have much more cash than what it requires. The financial manager must be alert for opportunities to make use of any cash temporarily in excess of current needs.

To ensure that these aims are met, it is necessary to know in advance as accurately as possible when cash shortages or cash surpluses are likely to occur, so that action can be planned to deal with these eventualities. Cash management depends on cash forecasting.

The most convenient type of cash forecast for this purpose is the receipts and payment forecast, because it built up in the same form as that used for recording actual transactions in the books of account. A typical form of receipts and payment forecast is illustrated below, and it covers a period of three months with monthly rests.

The first item, collection of debts, is derived from two sources:

- The outstanding debtors list at the commencement of the forecast period. Such lists should be under continuous review as part of the company's credit control procedure, and it should be possible to enter the expected collections under the various future months;
- Estimates of sales invoicing over the next three months. The invoice estimates will be converted into collection estimates using the company's normal credit period, with adjustments for any major items to which special credit terms apply, or where delays may be anticipated. The collaboration of the sales department is needed in developing these forecasts.

Other cash receipts may include cash sales (probably extrapolated from past experience), interest receivable at known due dates, and dividends receivable so far as these can be forecast.

A major item of cash outflow will be payments to suppliers. It will be convenient for control if all items that are dealt with through the purchase ledger are grouped together, though various managers will be involved in forecasting transactions of different types. Basically the purchasing manager must be required to prepare a forecast of purchase orders due to be placed month by month.

FORM OF RECEIPTS AND PAYMENTS FORECAST

Company..... Receipt and Payment Forecast
One Year.....19.....

(figures in Rs. thousands)	Quarter Total	1 st Month	2 nd Month	3 rd Month
Collection of Debt				
Due Now				
Future Invoicing by Quarter				
Other Income				
Total Income				
Payments				
Creditors Now				
Future Purchases by Quarter				
Quarterly Payroll				
Petty Cash Payments				
Periodic Payments				
Bank Charges				
Other Payments				
Total Outstandings				
Bank Overdraft – Opening				
-- Closing				

Similar to the debtors forecast, the payments to creditors forecast will start with a list of accounts payable outstanding at the commencement of the forecast period. This and the purchases forecast will have to be converted into a forecast of payment due dates, using the credit terms agreed by the purchasing manager.

The remaining payments will be forecast under the headings most suitable for comparison with source documents, for example:

- net wages and salaries for comparison with payrolls;
- petty cash items in total for comparison with the petty cash book;
- special cheque payments and bank standing orders (analysed by type of expense to ensure the none is forgotten), which will probably be compared with analysis column in the main cash book.

Each month the net cash flow inwards or outwards is calculated and adjusted on the previous month's cash balance to give the new month-end balance. It is thus possible to see whether at any time surplus funds will be available. If, on the other hand, the forecast shows excess demands which cannot be met from the available cash overdraft facilities, then it will be necessary to review the forecast and to make plans for modifying the timing of particular cash flows so as to restore an acceptable balance.

A monthly control report should be prepared. This will have the same line analysis as the forecast, and will set out the forecast and actual cash movements on each line and the variances between them. These variances must be analysed by cause and responsible factors so that action can be taken to improve cash control for the future.

The Cash Budget

When a cash forecast shows unsatisfactory cash balance throughout, it will probably be necessary to consider ways of obtaining additional capital. But as cash shortages are forecast only as short-term features within a general satisfactory trend, each item in the forecast should be scrutinised for possible modification to either:

- a) timing: or
- b) amount.

The possibility of changes in amount should be dealt with first, because an improvement in total collectibles or a reduction in total payables is of greater benefit to the business than the mere shifting of an item from one time period to another.

In relation to sales income, forecast sales quantities and prices could be reviewed, but care must be taken that this leads to a new figure which is genuinely expected to occur, and is not just a change from a moderate to an optimistic forecast.

Because of the variety of possibilities (and often their relatively small amounts), miscellaneous receivables may have been ignored by and it is possible that in total they could have a significant effect on the cash position. Three particular examples are:

- Sales of scrap, possibly after sorting and cleaning;
- Disposals of underutilised fixed assets;
- Sales of surplus stock.

In each case the potential sales proceeds have to be compared with the opportunity cost of relinquishing the assets.

In attempting to reduce the amount of proposed expenditure a good starting point is to classify the various items between those that are essential to current operations and those that are discretionary. Discretionary expenses may include such items as

subscriptions and donations, books and publications, advertising and publicity. Such expenditure can be reduced without causing short-term damage to the business.

There is nothing like shortage of cash (real or induced) to get every manager reviewing the effectiveness of his expenditure (though there must be strong central co-ordination to ensure that short-term savings do not lead to longer-term losses):

- Ensuring that responsibilities have been allocated for rigorous progress action on over-due or disputed customer accounts, and that the cash forecast incorporates the collection of such items at target dates;
- Scheduling the essential payments in such a way that the cash balance is preserved with the least impairment of good relations with the creditors.

Once we have the cash back, we have to manage it too till the time it is utilised in paying for the purchases and other expenses.

The primary purpose of cash in business is to make possible those transactions necessary to set up the business and run it day by day. Before discussing the control of cash, therefore, it is helpful to look at the various transactions in respect of which cash will be received or disbursed. We shall refer to this several times, but for our immediate purpose the important features are as follows:

- The total cash available in hand or in the bank at any time is represented by the large box left-centre of the diagram;
- The cash balance with which the business was first established will have been obtained by an injection of capital as shown in the top left-hand corner of the chart;
- During the course of the normal trading, manufacturing or service operations of the business, cash will be paid out for the purchase of goods, materials and supplies, for wages and salaries, and for various other expenses such as travelling, postage, insurance and so on;
- The marketable items or services emerging from this expenditure will be sold to customers who will pay for them and thus reinstate the cash balance;
- If this cycle of events happened instantaneously, then so far as operating transactions were concerned there would never be any shortage of cash.

Business Cash Flows

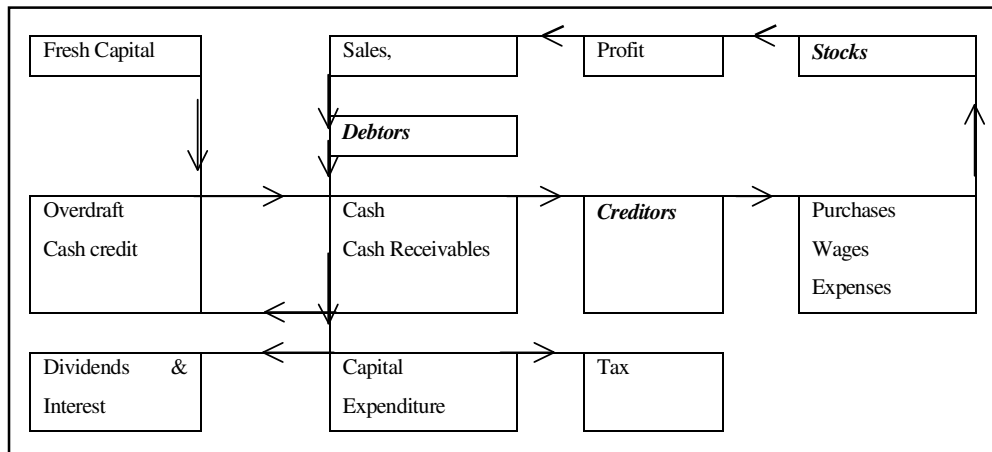

The net effect of these delays will have been mitigated because one must hope that sales values will have been in excess of the relevant outlays; i.e., they will have a mark-up for profit. This profit, however, has to cover three further items, listed below:

- The majority of businesses will require fixed assets—land, building, plant, machinery, motor vehicles, etc. (The outlay on these is shown at the bottom right of the chart as capital expenditure.) This disbursement has to be made before profits can be earned, and will only be recouped over a prolonged of time, the recovery being represented by a ‘depreciation’ charge in arriving at the profit mark-up. Although it is not shown on the chart it is possible to impose a delay factor on acquisition of fixed assets in various ways.
- Profit, after allowances for capital expenditure, will give rise to demand for tax. The tax payment will probably occur sometime after a profit has been earned, but will be eventually be a complete loss to the cash system of the business;
- The suppliers of capital to the business must be remunerated. Interest payments will be required periodically and regularly, although dividend payments will be made only if the profits are considered sufficient to justify them. But both types of payments will again be losses to the cash system.

Cash flows will be managed, therefore, by controlling:

1. Working capital the control of debtors, stock and creditors
2. Profit margins;
3. Capital expenditure
4. Taxation - tax management is a highly specialised subject outside the scope of this study

5. Interest and dividends dependent on the capital structure of the company.

The first and the biggest component of cash management is the level of cash which is supposed to come in. Cash forecasting was discussed earlier. Its importance in cash management cannot be undermined. Once we have forecasted the level of cash that is supposed to come in over the next few periods, then we can look at what is the base level we need for our operations.

Managing Collections and Disbursements

The size up our problem of cash management let us examine the flow of cash through a firm's accounts. It is useful to think of the process as cycle in which cash is used to purchase materials, from which are produced goods, which are then sold to customers, who later pay their bills. The firm receives cash from its customers and the cycle repeats.

Opportunities to improve efficiency in collecting and disbursing funds centre on flows through the current section of the balance sheet. Let us assume that XYZ Corporation orders raw materials at point A and receives them 14 days later at B. Terms of 2/10, net 30 are offered, so the firm pays the invoice 10 days later C. However, it takes 2 days for the cheque to clear, and XYZ's bank account is not changed until point D. XYZ turns its inventory six times per year, so 60 days after the materials are received, the product is sold and the customer is billed, the collection period is 30 days, 28 for the customer to pay and 2 for the cheque to arrive by mail(G). XYZ processes the payment and deposit it 2 days later at H. Another 2 days elapses while XYZ's bank collects the funds from the customer's bank.

The firm's total financing requirements is affected by the total time lag from point B to point J. The firm itself can control some factors that determine the various lags, but some it cannot. Some of the lags affect the cash balance, while others affect other components of working capital such as accounts receivable and inventory. In addressing ourselves to Cash management, we are concerned with time periods BCD and FGHI. Time period AB is beyond the firm's control and does not directly affect its financial statements, although it may affect production schedules. Time period DE is determined by the firm's production process and inventory policy, and affects the total investment in inventory. Time period EF is determined by the firm's credit terms and the payment policies of its customers, and affect the total investment in accounts receivable we will examine the management of inventory and accounts receivable in the next chapter.

Our present task is to examine what can be done to improve the efficiency of a firm's cash management. We will focus on three areas: concentrating working balances speeding collections, and controlling disbursements.

Concentrating Banking

Many firms need only a single bank account. Larger firms that operate over wide geographical areas usually need more than one, sometimes dozens. Where many accounts are needed, concentration accounts can be used to minimise the total requirement for working balances. Suppose a company has a number of branch offices, each with a local bank account. Branches collect accounts receivable and make deposits in their local accounts. Each days, funds above a certain predetermined minimum are transferred to a central concentration account, usually at the firm's headquarters. The daily transfer of funds can be made either by a depository transfer check or by wire transfer; the latter is faster but more expensive.

The funds transferred to the concentration account are available for disbursement for other purpose. As we will see later, the more variable a firm's cash flows, the higher the requirement for working cash balances.

By pooling its funds for disbursement in single account, the aggregate requirement for working balances is lower than it would be if balances were maintained at each branch office. Concentration in short, permits the firm to "store" its cash more efficiently.

Speeding Collections

Another means of conserving cash is to reduce the lag between the time the customer mails the cheque and the time the funds become collected, that is, from points F to J of the 6 days lag, 2 days are due to mail time, 2 days are due to processing time within XYZ Corporation, and 2 days are due to collection time within bank. We will have more to say later about collection within the banking system. Let us now focus on the 4 days lag from F to H.

Small firms that operate in limited geographical areas often can do little to reduce mail time. However, improvements often can be made in processing time within the firm. Suppose XYZ Corporation has credit sales of Rs 5 crore per year. With approximately 250 working days per year, XYZ's collections average Rs 20,000 per working day. If XYZ could reduce it by Rs 20,000, (XYZ's borrowing cost was 9 per cent) saving of about Rs 1,800 per year would be realised. These potential saving could be compared to the cost of faster processing to determine whether the change in processing should be made. We can conclude that internal processing should be speeded up to the point at which the costs of further improvement exceed the savings.

A second step that may be advantageous is to establish a lock-box system, which often can reduce mail and processing time still further. The firm first establishes a number of collection points, taking account of customer locations and mail schedules. At each location, the firm rents a post office box and instruments its customers to remit to the

box. The firm's local bank is authorised to pick up mail directly from the box. The bank does so, perhaps several times a day and deposits the cheque in the firm's account. The bank made a record of names and amounts and other data needed by the firm for internal accounting purpose, and immediately enters the cheques for collections.

The lock-box system results in two benefits to the firm: First, the bank performs the clerical tasks of handling the remittances prior to deposit, services which the bank may be able to perform at lower cost. Second, and often more important, the process of collection through the banking system begins immediately upon receipt of the remittance and does not have to wait until the firm completes its processing for internal accounting purpose. In the activity represented by HJ now takes place simultaneously with GH. The firm's processes remittances for internal accounting purpose using data supplied by the bank and can schedule this processing at any time without delaying collection. Using a lock-box system as much as 4 days in mailing and processing time can be reduced.

Banks charge for their services in connection with a lock-box plan either via fees or compensating balance requirements. Whether the savings will outweigh the costs for a particular company depends mainly on the geographical dispersion of customers the rupee amount of the average remittance, the firm's cost of financing.

We see that a major advantage of speeding collections is the free cash and thereby reduce the firm's total financing requirement. There are other advantages as well. By transferring clerical functions to the bank, the firm may reduce its costs, improve internal control, and reduce the possibility of fraud. By getting cheque to banks on which they are written sooner, the incidence of cheques dishonoured for insufficient funds may be reduced.

Collection Time in the Banking System

We have made several references to the time required to collect a cheque through the banking system but we have made no proposals to shorten it. Let us be more specific about what is involved. Suppose a customer in New Delhi, purchases electronics equipment from a firm in Mumbai, and remits with a cheque drawn on a New Delhi Bank. The seller deposit the cheque in a bank in Mumbai, but the funds are not available for use until the cheque has been presented physically to the New Delhi bank, a process that depends on mail service between the two cities and may take several days. A very extensive clearing network has been established in India that involves the commercial banks and the RBI. In the majority of cases, clearing times has been reduced to 2 days or less using the facilities of the direct inter-bank clearing. In the matter of cheque clearing, the banks are the experts, and firms usually can rely on their banks to minimise the time requirements.

Controlling Disbursements

Just as speeding collections turns accounts receivable into cash and thereby reduces the firm's financing requirements. Slowing disbursements does the same. In earlier chapter, we discussed trade credit as a source of funds. There we conclude that the proper policy was to pay within the terms agreed upon taking cash discounts when offered. We conclude also that is no point in paying sooner than agreed. By waiting as long as possible, the firm maximises the extent to which accounts payable are used as a source of funds, a source which requires no interest payment.

Firms with expense-generating activities that over a wide area often find it advantageous to make disbursements from a single central account. In that way, schedules can be tightly controlled and disbursements can be made on exactly the right day. An alternate arrangement is to disburse from decentralised locations, but to wire transfer the exact amount needed in each local account for all disbursement scheduled that day.

Some firms find it advantageous to exploit the "cheque book float", which is the time between the writing of a cheque and its presentation for collection, represented by CD . If this lag can be exploited, it offsets at least partially the lag in the other direction in collecting cheques from customer (HJ). Because of lag CD, a firm's balance on the bank's books is higher than in its own cheque book. Knowing this, a firm may be able to reduce its working cash requirements. Banks understand cheque book float also, and can be expected to set compensating balances and fees based on balances on their (the banks) books. If a firm exploits cheque book float too far, it increases the likelihood of cheques being dishonoured for insufficient funds and the accompanying displeasure of both bank and payee.

Determining the Appropriate Working Cash Balance

Let us assume the firm now is collecting, and disbursing its cash as efficiently as possible. Given its long-term financial structure fixed assets long-term liabilities, and equity its total cash position at any time is determined by its operating plan. Suppose total cash is more than the firm needs for operating purposes, if disbursements are made according to plan.

The Neptune Company projected a total cash balance as high as Rs 4,89,000 in November. Should all these funds be kept in Neptune's current account? Since current accounts earn no interest, it is to Neptune's advantage to leave only the amount necessary to operate, and to invest the remainder temporarily in interest-bearing liquid assets until needed.

Our problem, then, is to determine how much cash a firm should maintain in its current account as a working balance. We will address this question here, and in the next section discuss the investment of amounts above the working balance.

The working balance is maintained for transaction purposes for paying bills and collecting payments on accounts receivable. If the firm maintains too small a working balance, it runs out of cash. It then must liquidate marketable securities if available, or borrow.

Liquidating marketable securities and borrowing both involve transaction costs. If, on the other hand, the firm maintains too high a working balance, it foregoes the opportunity to earn interest on marketable securities, that is, it incurs what economists refer to as an opportunity cost. Thus, the answer we seek is the optimal working balance, rather than the minimum. Finding the optimum involves a tradeoff of transaction costs against opportunity costs. If a firm tries to keep its working balances low, it will find itself selling securities (and later repurchasing securities) more often than if it aims at a higher level of working balances, that is, transaction costs fall as the working balance level rises. Opportunity costs, on the other hand, rise as the level of working balances rises. There is one point where the sum of the two costs is at a minimum. This is the point efficient management should try to find.

Compensating Balance Requirements

If a firm uses bank credit as a source of financing, the question of the optimal current account balance may have a simple answer: it may be dictated by its compensating balance requirements to compensate for various services such as processing cheques and standby commitments to lend.

In some cases, a firm may determine with very little analysis that its optimal working balance is below the bank's compensating balance requirement. In such cases, the latter figure becomes the firm's minimum current account balance. In other cases, where the answer is not so clear or where compensating balances are not required. We must put pencil to paper to determine the appropriate working balance.

Finding the Optimal Working Balance

Having done all we can to improve our collection and disbursement procedures, let us now take the pattern of receipts and disbursement as given. Over any time period, a firm's beginning and ending cash balances are related as follows:

$$\text{Ending balance} = \text{Beginning balance} + \text{Receipts} - \text{Disbursement}$$

If receipts and disbursements were constant each day, we would know with certainty what each would be each day and our problem would be simple. Since receipts always would exceed disbursements by the same amount, we could withdraw the ending balance each day and use it for other purposes. In practice, we have two problems: variability

and uncertainty. In most firms, receipts and disbursements vary both over the month and over the year. Over a month, receipts and disbursements for current operating expenses are likely to show some variation, perhaps in a regular pattern. In seasonal firm, the amounts also will vary over the year less frequent outlays. Such as those for capital expenditure, taxes, and dividends, introduce still more variability. Some of this variability may be predictable, but some probable is not. Let us examine these two problems variability and uncertainty separately.

Variability

Suppose receipts and disbursements both vary and are not synchronised, but the variations are completely predictable. Determining the appropriate working balance in the face of non-synchronous but predictable cash flows is a problem of minimising total costs. If we set the balance too low, we incur high transaction costs; one might say we make too many trips to the bank. If we set the balance too high, we lose too much interest on marketable securities.

The determination of the optimal working balance under conditions of certainty can be viewed as an inventory problem in which we balance the costs of too little cash (transaction costs) against the costs of too much cash (opportunity costs). If the cash shortage becomes severe enough, we may begin to forego cash discounts on purchases, adding another element of opportunity cost.

Formal models of the cash balance problem have been developed using inventory theory. Inputs to such a model are the total net cash outflow over the period of time in question, the transaction costs of replenishing the cash balance by selling securities or borrowing, and the interest rate that can be earned on securities. The answer given by the model tells us how often and in what amounts funds should be transferred to the checking account from other sources.

Uncertainty

Receipt and disbursements are very seldom completely predictable. If we go to the opposite extreme and assume receipts and disbursements for the difference between them) to be completely random, a different kind of model can be developed using the technique of control theory. In addition to information on transaction costs and interest rates on securities, we need a measure of the variability of net cash flows. Using these data, we can determine the optimal maximum and minimum balances in the firm's checking account, denoted by levels X and Y .

In the firm's working cash balance fluctuates randomly in response to random inflows and outflows. At time t_1 , the balance reaches the upper control limit Y . At that

point, $(Y - X)$ money is transferred out of the cash account and into marketable securities. The balance continues to fluctuate, falling to zero at t_2 , at which time X value of marketable securities are sold and the proceeds transferred to the working balance. The control limit model thus gives an answer in terms of maximum and minimum balances and provides a decision rule, rather than a fixed schedule of transfers as did the simple inventory mode. One of the important insight of the control limit model is that, where cash flows are uncertain, the greater the variability the higher the minimum balance .

Using Mathematical Models

Formal mathematical models such as those mentioned above are useful for increasing our understanding of the cash management problem and providing insights and qualitative guidance. The models tell us which factors are important and make the tradeoffs explicit. We see, for example, that transaction costs play a central role. If transaction costs were zero, the firm would require no working cash balance at all; it simply would sell securities or borrow to pay every bill.

Are formal mathematical models also useful for quantitative applications? In practice, the cash flow patterns of most firms are partly predictable and partly random. Neither the inventory model nor the control limit model is strictly applicable. By combining the insights from formal models with the techniques of cash budgeting and pro forma analysis, many firms can arrive at reasonable answers by experience and experiment. In deciding how far to go in analysing the problem, we must consider the cost of the analysis. Except in the case of very large firms, quantitative solutions to the cash balance problem using formal mathematical models are likely to be uneconomical. Often, the cost of obtaining the necessary input data and operating the model exceeds the savings over solutions that can be attained by experience and experiment. As always, we must keep an eye on the cost of our analytical techniques as well as on the benefits.

Planning Cash Requirement

In most cases, to search for the optimal working cash balance probably overstates our capabilities; we must be content to get reasonably close. Perhaps we should substitute the word “appropriate” for “optimal.”

The current account balance that the firm should maintain is the compensating balance requirement, or the optimal working balance. Whichever is greater. Some firms, especially those with seasonal sales patterns, may find that the appropriate working balance varies somewhat over the year. As a firm grows, the appropriate working cash balance also will grow, although probably not proportionally.

Once we have settled on the appropriate balance to be maintained in the current account,

we can integrate cash management into the financial planning process. The projected current account balance goes into the pro forma balance sheet. Any excess cash over that figure then may be invested in interest-bearing assets.

Investing Idle Cash

Cash in excess of requirements for working balances normally is invested in interest-bearing assets that can be converted readily to cash. A firm might hold excess cash for two principal reasons; First, the firm's working capital requirement may vary over the year, perhaps in a fairly predictable manner if the variation is due to recurring seasonal factors. From the pro forma balance sheet, it was apparent that excess cash would build up during seasonal lows in accounts receivable and inventory, and would be needed later to finance a re-expansion of receivables and inventory during the next seasonal high. We can view the excess cash as a part of the firm's transaction balances. Even though the cash is temporarily idle, there is a predictable requirement for it later.

Second, excess cash may be held to cover unpredictable financing requirements. In a world of uncertainty, cash flows can never be predicted with complete accuracy. Competitors act, technology changes, products fail, strikes occur, and economic conditions vary. On the positive side, attractive investment opportunities may suddenly appear. A firm may choose to hold excess cash to finance such needs if and when they occur. We noted earlier that cash held for such purposes is referred to as a precautionary balance and usually is invested in interest-bearing assets until needed.

An alternative exists to the holding of excess cash for either of the two purposes described above. The firm can simply borrow short-term to finance variable requirements as they arise. Under such a policy, the firm would never hold excess cash. A firm's choice between short-term borrowing versus liquid assets as a means of financing variable requirements will depend on policy decisions with respect to the firm's long-term financial structure, particularly the mix of short-term and long-term funds. We will discuss overall financial structure and the relationship between maturity structure and liquidity later. Here, we take as given the long-term structure and the amount available for investment in interest-bearing assets.

Investment Criteria

A firm might invest excess cash in many types of interest-bearing assets. To choose among the alternatives, we must establish criteria based on our reasons for investing excess cash in the first place. We are investing either temporary transaction balances or precautionary balance or both. When we need the cash, we want to be able to obtain it-all of it-quickly. Given these objectives, we can rule out equity share and other investments with returns that are not contractual and with prices that often vary widely.

Debt securities, with a contractual obligation to pay, are our best candidates. In selecting among debt securities, there are three principal characteristics we should examine: default risk, maturity and marketability.

Default risk refers to the possibility that interest or principal might not be paid on time and in the amount promised. If the financial markets suddenly perceive a significant risk of default on a particular secular security. The price of the security is likely to fall substantially, even though default may not actually have occurred. Investors in general are averse to risk, and the possibility of default is sufficient to depress the price. Given our purposes in investing excess cash, we want to steer clear of securities that stand any significant chance of defaulting. In an uncertain world, there is no guarantee that is absolutely certain. With its capacity to create money. However, there are securities available with default risk that is sufficiently low to be almost negligible. In selecting securities, we must keep in mind that risk and return are related, and that low-risk securities provide the lowest returns. We must give up some return in order to purchase safety.

Maturity refers to the time period over which interest and principal payments are to be made. A 20 years bond might promise interest semiannually and principal at the end of the twentieth year. A 6-month bank certificate of deposit would promise interest and principal at the end of the sixth month.

When interest rates vary, the prices of fixed-income securities vary. A rise in market rates produces a fall in price, and vice versa. Because of this relationship, debt securities are subject to a second type of risk. Interest rate risk, in addition to default risk. A government bond, though free of default risk, is not immune to interest rate risk. The longer the maturity of a security, the more sensitive its price is to interest rate changes and the greater its exposure is to interest rate risk. For this reason, short maturities are generally best for investing excess cash.

Marketability refers to the ease with which an asset can be converted to cash. With reference to financial assets, the terms marketability and liquidity often are used synonymously. Marketability has two principal dimensions-price and time-that are interrelated. If an asset can be sold quickly in large amounts at a price that can be determined in advance within narrow limits, the asset is said to be highly marketable or highly liquid. Perhaps the most liquid of all financial assets are Treasury Bills. On the other hand, if the price that can be realised depends significantly on the time available to sell the asset, the asset is said to be illiquid. The more independent the price is of time, the more liquid the asset. Besides price and time, a third attribute of marketability is low transaction costs.

Yields

All the characteristics we discussed above—default risk, maturity, and marketability—affect yield. In general, the lower the default risk and the better the marketability, the lower the yield. Securities with these desirable characteristics have higher prices, and since price and yield are inversely related, lower yields.

The relationship between maturity and yields is more complex and changes over time. On an average, short maturities yields less, other factors being equal, because they are subject to less interest rate risk. Rates on short maturities, however, are more volatile than those on longer maturities, and at times exceed the latter.

At any point in time, rates on the major types of money-market securities discussed above are fairly close to one another. For equal maturities, the differentials usually are small and are due to small differences in default risk and marketability.

Over time, the entire structure of short-term rates varies significantly. Such variations are related to the business and monetary cycles, the demand for funds by individuals and firms, and the credit policies of the RBI.

Collection & Disbursement Systems

Primary objective of a collection system is to receive value from the buyer as quickly as possible. Secondary objective is to receive and process information associated with the payment. The longer the delays the more the funds that will be tied up in it.

If we define the system in terms of the linear programming model, the objective function that we need to minimise is:

Objective function:

Minimise

- Cost of collection float
- Value of payment information
- Value of relationship with payers
- + Collection system costs
- + Cost of losses through theft/ fraud

+ means that the function is to go with the objective (i.e., here to minimise) and - means that it has to go against the stated objective (i.e., to maximise rather than minimise in this case)

What is a float?

Float could be defined as the amount of funds represented by checks that have been issued but not yet collected.

OR

It could be defined as the time between the deposit of checks in bank and its payment.

Due to the time difference, many firms are able to “play the float,” that is, to write checks against money not presently in the firm’s bank account.

There are different kinds of floats that the firm has to encounter. These include:

Collection Float

Time taken to realise the money after the company has received the cheque from the debtors.

Mail Float

Time that elapses from the mailing of the cheque until its receipt.

Processing Float

Processing time after the cheque is received and before it is deposited with the bank.

Availability Float

Time taken from the deposit of the cheque to the funds being available in the bank.

The last two items together make up deposit float and all the three items make up the collection float.

Float measurement

Float is usually measured in rupee-days, which are calculated by multiplying the time lag in days by the rupee amount being delayed. Float can be measured either on each item that is processed or on an average daily basis.

Cost of Collection Float

The cost is determined by the following formula:

money in float * no. of days * daily interest rate * frequency of payment

Value of Payment Information

Matching payments to accounts in a timely and accurate manner. The biggest utilisation is to update the systems so that actual positions of funds in the accounts are available.

Value of Relationship with Payee

Delays in posting may send wrong information to customers. Could also cause delays

in shipments as you may be withholding shipments for the payments.

Collection System Costs

Costs of receiving the money from the customers till the time the payments reach the office and the cost of processing in the office.

Cost of losses from Fraud and Theft

Cash collection could involve frauds and thefts which could negate the effect of excellent collection systems.

Techniques of Cash Management and Marketable Securities

Cash Concentration Systems

There are three basic tasks of the cash concentration systems:

1. Receive Deposits
2. Transfer funds to disbursement banks
3. Serve as focal point of short term investments and credit transactions

Objective function

Minimise	Opportunity cost of excess balance + Transaction costs - Savings on dual balances + Administration costs + Control costs
----------	--

Disbursement Systems

Many times the cash is collected from several places where the customers are there but is disbursed from the factory premises or the corporate headquarters. So the objective function would be to maximise the disbursement floats available without straining the relationships with the suppliers.

Objective function:

Maximise	+ Value of disbursement float - Loss of discounts for early payment - Cost of excess balances in disbursement accounts - Transaction costs + Value of payee relations + Value from dual balances
----------	---

- Administration, information and control costs

Required Cash Balance

The question may be designed as whether it is possible to define the amount of cash which out to be held at any time? Cash is needed for three reasons:

1. To finance transactions (which was the main theme of the previous paragraphs):
2. As a precaution - a safeguard against the inaccuracies in cash forecasts - bearing in mind that every forecast, by its very nature, will be inaccurate.
3. For speculative purposes - to take advantage of any profitable opportunities that arise.

What average cash balance then should be held to finance normal transaction, including any necessary margin of safety? The word 'normal' is important because it may be assumed that small deviation from the norm will be covered by overdraft facilities.

This is a question closely akin to one we shall be asking about stockholdings in the next unit. Attempts are sometimes made to establish a equation based on:

- The 'holding cost' of cash (i.e., the opportunity cost of keeping the cash un-invested);
- The 'procurement cost' of cash (i.e., the transaction cost of converting securities into cash, or otherwise obtaining new funds).

The estimates used in such calculations are likely to be suspected, and the model to which they give rise is only applicable when the demand for cash is reasonably consistent from period to period.

There are two models used. The first one is Baumol Model which works exactly on the lines of inventory model and that is its biggest shortcoming. The second one is Miller-Orr model which specifies a minimum and a maximum level of cash in the system and expects the cash levels to move between the two.

Let us look at Miller-Orr model in slightly more detail. Figure below gives you the basic functioning of Miller-Orr model. We can see that The company has established upper and lower limits within which it allows the cash levels to operate. If the cash level touches the upper level, the company converts extra cash into securities so as to bring it to the target cash balance. It follows the same procedure for the lower limit where it sells securities instead of buying it. This makes it easy for the company to manage cash as the levels of cash is difficult to predict very accurately.

Note that the target cash balance point is at one-third of the distance between the lower and upper level, from the lower level instead of half-way between the two because

the company wants to minimise the cash it is holding. Their studies have shown that this level is the optimum level.

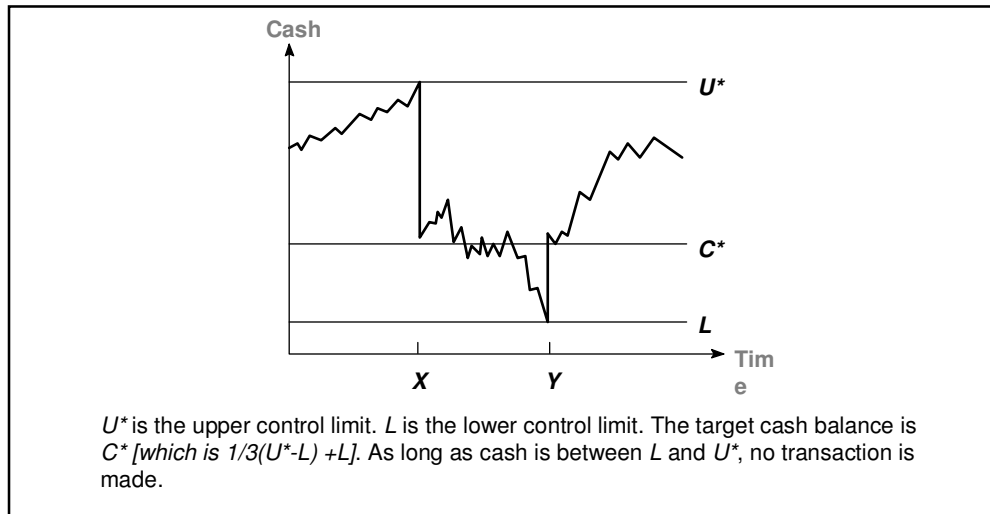

Other mathematical models, too, have been suggested by various authors, but they tend to be mainly of academic interest only.

A simpler approach to the definition of the required cash balance is by the use of ratios.

One such measure is the ratio between the sales of a period and the opening cash balance:

$$\text{Cash turnover} = \frac{\text{Sales for period}}{\text{Initial cash balance}}$$

This is sometimes called the cash velocity. (The resemblance to the stock turnover ratio will be obvious.)

As with all management ratios one is looking for consistency period by period within the company, or a trend of improvement which, in this case, would be higher sales per unit of cash held. If, for example, the cash velocity last period was:

$$\text{Cash turnover} = \frac{\text{Rs. 18,000}}{\text{Rs. 9,000}} = 20x$$

Then an increase of sales to Rs.2,25,000 without a change in cash holding would increase the velocity to 25x. In other words, the cash balance would have been kept to Rs.9,000 instead of rising to Rs.2,25,000/20 = Rs.11,250, so there would be saving of interest or a gain at the opportunity cost rate into Rs.2,250.

Again, like other ratios this ratio cannot be used in isolation. An increase in sales without an increase in cash balance might mean that the company had become less able to pay its debts as they fell due, possibly signifying that it was over-trading. It might be possible

to use this ratio for comparison with an average for the industry, but probably not with individual firms within the industry, since special factors might affect the balance held by a particular firm at its year-end date (especially if the businesses were seasonal, or if the firm under review were accumulating cash for a specific project).

A second ratio quite often found is that between the cash balance and the total current assets:

$$\text{Proportion of cash held} = \frac{\text{Cash balance}}{\text{Cash Assets}}$$

A wide range of figures between different industries will be found. Based on transaction analysis or past trends, the company could set a minimum proportion of cash holdings to current assets with the objective not of using this as an absolute limit but as an opportunity for reviewing the reasons for any deviation from the norm.

In general the use of simple ratios has a limited value in cash planning. There is no adequate substitute for detailed cash forecasts, possibly linked with a financial model of the business as a whole.

For an outside observer, and to some extent for the board of a company, useful information can be derived from a trend of liquidity ratios incorporating not merely cash but also those elements of working capital which are readily convertible into cash. This concept of liquidity was built into the source and application of funds statement described above.

Investing Surplus Funds

If the cash forecast for a business shows surplus funds becoming available, then plans should be made for putting them to use. However, the surpluses may be transitory, either because they are being accumulated deliberately for some purpose such as the purchase of plant or the payment of taxes, or because the business is seasonal and the funds will eventually be required to finance off-peak activities.

It is important to schedule in detail, with frequent reviews, how much money will be available for various period of times, so that it can be put to the best possible use. Small amounts which are required to be kept liquid are probably best placed on deposit with a clearing bank or other finance house. The rate of interest will be low, but only short notice is required for withdrawal. When large sums are available there is a greater range of investment alternatives.

Loans to local authorities or merchant banks or local authority bonds, have various terms from days upto five years, so they can be matched to the availability of funds, however, they are not readily negotiable. Negotiable certificates of deposit issued by the commercial banks overcome this disadvantage, offer a higher rate of interest and can cover a wide range of maturities from three months upwards.

The purpose of this type of investment is to squeeze extra profit out of money which is normally in use in the operations of the business. It does not give full scope for portfolio planning, which is essential when funds are available for investment over a long period.

The main principle involved in planning the investment of short-term cash surpluses is to match investment maturities with cash needs. Before considering investment, therefore, it is necessary to have reliable cash movements forecast, so that one knows with reasonable certainty how much cash will be spare for what period of time.

The second principle is to invest for as long as possible, because interest rates are higher for long periods. Opposed to this principle is the need to have a margin of safety, this may be a bank overdraft facility or may take the form of slightly more liquidity in the investment portfolio than the forecast strictly requires.

The size of the fund available for investment will have an effect on how profitably it can be used, both because large funds can bear the cost of a professional investment manager and because such funds can be placed directly on the money market rather than through the company's bank.

Cost of Holding Cash

Trading costs are increased when the firm must sell securities to establish a cash balance. Opportunity costs are increased when there is a cash balance because there is no return to cash. The tradeoff between the two results in an optimum point of holding cash, which becomes their target cash balance as depicted in figure.

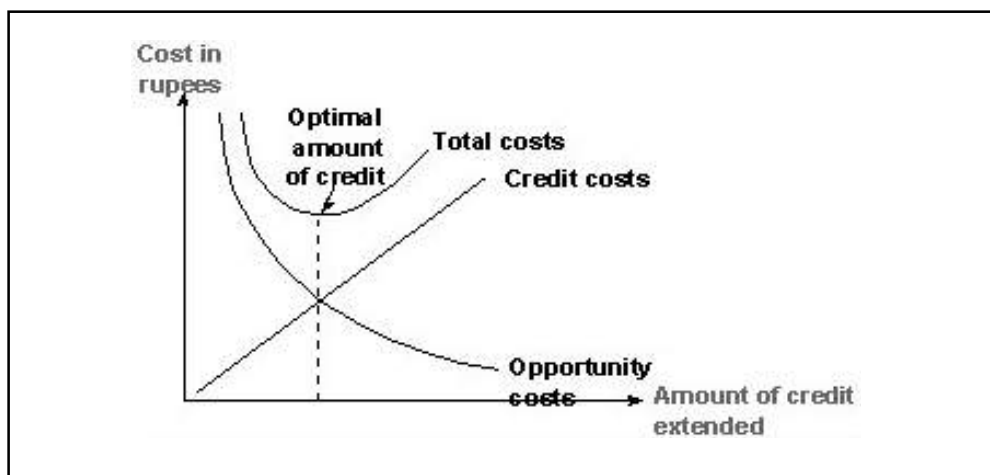

Cash Management in a Group of Companies

Within a group of companies it is often considered desirable for cash to be managed by a central department which will:

- Gather in all surplus funds from the various companies and redistribute them in accordance with the investment opportunities which best serve the group objectives;
- Dictate the dividend distributions of the subsidiary companies to ensure that funds are retained where they are needed within the group;
- Arrange the investment outside the business of funds which are temporarily surplus to group needs;
- Negotiate centrally any bank overdraft facilities, and the raising of new long-term capital.

With regard to internal investment it sometimes appears that priority is given to projects from those companies which are already profitable (since they are able to show better incremental returns than those which are currently less successful); and it is argued that the loss-making companies may well have the greater need for operations.

In relation to overdraft facilities, the argument for Group central negotiation is that only one banker (or a lead banker) will be involved who will be well informed on the whole of the group's activities, and that all the resources of the group will be available as security. This does, however, put the whole group at risk if credit facilities are reduced. If the various companies have a good local relationship with the banks they have used individually in the past, it can happen that the total of locally negotiated overdrafts is greater than could have been obtained centrally. While the withdrawal of one facility still leaves the other companies untouched.

The payment of creditor accounts centrally is easier to arrange, though it may involve delays in payment if involves first to be approved by local offices. Whether centralised purchasing is beneficial will depend on whether the advantages of standardised specifications and the negotiation of build discounts are offset by a loss of specialised purchasing skills for a diverse range of products and by delays in the procurement of urgently needed supplies.

The majority of the foregoing comments will apply equally to a single company having divisional profit centre in scattered locations.

Chapter-9

Management of Receivables

If we are getting trade credit to fund our needs, we also have to extend trade credit to our customers. A company grants trade credit to protect its sales from the competitors and to attract the potential customers to buy its products at favourable terms.

Extending trade credit creates receivables or book debts which the company expects to collect in the near future. The book debts or receivables arising out of trade credit has three characteristics:

1. **It involves an element of risk:** This should be carefully analysed. Cash sales are riskless, but not the credit sales as the cash is yet to be received.
2. **It is based on economic value:** To the buyer, the economic value in goods or services passes immediately at the time of sale, while the seller expects an equivalent amount of value to be received later on.
3. **It implies futurity:** The cash payment for the goods or services received by the buyer will be made by him in a future period. The customers from whom receivables or book debts are due are called “debtors” and represent the company’s claim or asset.

Let us take up an example to illustrate the benefit of providing trade credit.

Example

A company is planning to extend credit to its customers. The choice is between one month and two month’s credit. The first year’s results under the three alternatives, of providing no credit and one & two months credit, are tabulated below.

Note that we have not shown an ‘interest’ charge on the increased working capital because in due course the increase in stocks and debtors will in effect be financed out of the improved profits, and no specific borrowing may be needed. However, regardless of how the working capital is financed it must still produce the required rate of return.

The example makes the fairly obvious points that giving credit involves cost, including the opportunity cost of additional capital employed. In some cases these costs will cancel out or outweigh any gains from increased business like in the second alternative above. In some cases the granting of credit may not increase the sales of the business but may be justified because it will prevent a loss of sales to a competitor.

(Rupees)	No credit	One month's credit	Two month's credit
Sales	120,000	160,000	240,000
Debtors		13,333	40,000
Stocks (less creditors (Say, 1/12 of sales value))	10,000	13,333	20,000
Total	10,000	26,666	60,000
Increase in working capital through granting credit		16,666	50,000
Marginal contribution	30,000	40,000	60,000
Less: Cost of:			
Credit control		(6,000)	(6,000)
Bad debts		(1,600)	(4,800)
Relevant comparable profits	30,000	32,400	49,000
Increase in profits		2,400	19,200
But the company requires a return of 15% on the increase in capital employed; i.e.		2,500	7,500
The net advantage (or disadvantage) of the proposed changes in credit policy is therefore		(Rs.100)	Rs.11,700

There are two costs that we can associate with extending credit as: i) credit costs and ii) opportunity costs. Credit costs are the cash flows that must be incurred when credit is granted. They are positively related to the amount of credit extended. Opportunity costs are the lost sales from refusing credit. These costs go down when credit is granted.

This means that there is a point where the sum total of these two costs are minimum for the company. This point depicts the optimum credit policy that the company must follow.

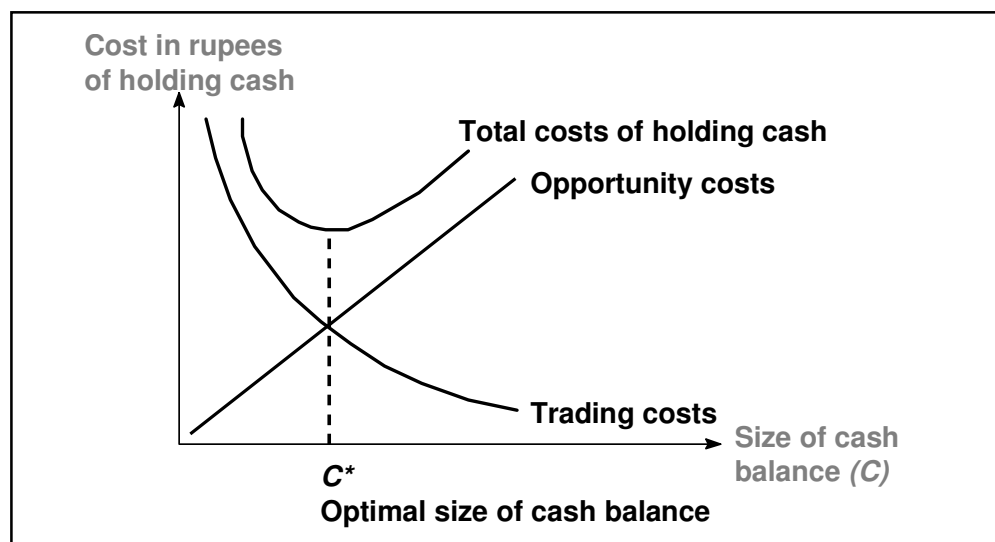

The above discussion will suggest three ways of management control in connection with credit policy:

- (a) Debtors expressed in relationship to sales - either as a percentage or as a number of weeks sales. This provides an overall confirmation that the business is effective in carrying out its own credit policy.

With a seasonal business, however, these calculations could be misleading. Another disadvantage of averages is that they may conceal the fact that some long-overdue debts are being compensated by quicker collections from other customers. For management control there is no substitute for a complete listing of debtor accounts, analysed by age, compiled every month.

- (b) Bad debts as a percentage of sales value, or reported otherwise in detail.
- (c) Credit control costs.

This means that credit control involves three types of action:

- (a) deciding the normal credit period to be allowed;
 - (b) establishing credit limits for individual customers;
 - (c) implementing the system (that is to say, ensuring that credit limits and the credit period are not exceeded).
- (a) **Deciding the Credit Period:** If a business is offering a unique product or service, or one for which demand exceeds supply, there may be no need to offer credit terms at all. In other cases the starting point in deciding credit policy is a review of the credit terms offered by competitors, and from this basis the credit terms of the particular business will be developed.

Other factors that affect the length of the credit period are the following:

- Buyer's inventory and operating cycle
- Perishability and collateral value
- Consumer demand
- Cost, profitability and standardisation
- Credit risk
- The size of the account
- Competition
- Customer type

Long credit period may be offered to the customers if this will enable the business to capture a larger share of the available market, or the break into a new market. The

initial effect of granting long credit periods may be adverse because of the extra costs involved but profits from increased volumes should more than offset the losses. If it does not there is no use in extending longer credit periods. Even otherwise it is necessary to look to the longer term where, among other possibilities, selling prices may be increased because smaller competitors have been eliminated in the 'credit war'.

Shorter credit may be imposed if demand is inelastic, so that the quantity sold will not be affected simply by changes in credit terms.

Influence of Credit Policy

Credit policy will directly influence sales, investment levels, bad-debt losses, and collection costs.

Sales: Sales vary directly with the extent to which credit terms are liberalised. The demand for a firm's product is greatly influenced by the ease with which the products can be purchased on credit. Sales will be at their lowest level if they are strictly for cash. Those who want to buy on credit will patronise other manufacturers who extend credit. Sales will start increasing as credit terms are liberalised. Sales will be at their maximum level when the firm does not screen buyers for credit worthiness. Rather, credit is extended to all who want to buy the firm's products.

Investment Levels: Sales on credit result in accounts receivable. As discussed above, sales are directly related to the liberality of credit terms. As credit terms are liberalised, sales increase and to service this increased level of sales properly, the firm needs to increase its investments in cash and inventories. Finally, if sales increase sufficiently, the firm may have to increase its productive capacity. As credit terms are made more liberal, the firm's investment in cash accounts receivable, inventories, and perhaps physical equipment increases in a complimentary fashion.

Bad-Debt Losses: Without credit sales the firm will not incur any bad-debt losses. With a very conservative credit policy, bad-debt losses will be nonexistent or minimal. As credit terms are liberalised, the firm begins to give credit to marginally less-credit-worthy clients. The liberalisation of credit terms result in increases in bad-debt losses.

Collection Costs: Collection costs are the clerical and administrative costs associated with granting credit and managing accounts receivable. When credit is not granted, collection costs are minimal. As credit terms liberalised, the firm's volume of accounts receivable increases. The clerical and administrative costs of invoicing, collecting, and book keeping also increase as credit terms are liberalised. A second type of collection cost is the one related to efforts to collect on delinquent accounts. As credit terms are liberalised, delinquent accounts increase and the costs of efforts to collect on these accounts also increases.

Credit Terms

As discussed previously, credit policy has a direct influence on sales, investment levels, bad-debt losses, and collection costs. From a managerial view-point and looking strictly at the relationship between credit policy and sales, one could conclude that a very liberal credit policy is highly desirable. However, the relationship between credit policy and investment levels, bad-debt losses, and collection costs implies that a very conservative credit policy is desirable. An appropriate credit policy balances profits from increased sales due to more liberal credit terms with increased costs due to increased investments, bad-debt losses, and collection costs. The ideal credit policy allows for the liberalisation of credit terms to the point where the marginal revenues from a new category of credit accounts is exactly equal to the marginal costs of selling and servicing accounts.

In practice it is not feasible to establish the ideal credit policy. However, firms do consider alternative credit terms to see what influence they have on profits. Our focus here will be to look at certain specific credit terms and see how they might affect profits and what guidelines a firm could use to enhance its profitability. The three specific components of credit terms are credit period, credit discount, and discount period.

Credit Period: The credit terms are specified on the invoices sent out by firms. A typical credit term may state: 2/10, net 30. The first number "2" is the credit discount and indicates that a 2 per cent discount may be taken if the invoice is paid within the number of days specified by the second term, or 10 days. The second term "10" is the discount period and indicates the number of days during which the credit discount can be taken. The last number "30" indicates the credit period. The credit period specifies the number of days that a firm can take to pay the invoice without being considered to be delinquent. With terms of 2/10, net 30 the credit period is 30 days and the full amount of the invoice is due within 30 days.

One way to liberalise credit terms is to increase the credit period. Conversely, credit terms can be tightened by shortening the credit period. Mitsui Corporation is currently selling on credit terms of 2/10, net 30. Its annual gross sales are at the Rs 36 crore level currently. All sales are for credit. Fifty per cent of its clients take the 2 per cent discount and pay on the tenth day. The other 50 per cent, who do not take the discount, on the average pay after 30 days. The sales volume between discount takers and non-discount takers is evenly divided. The company's management is considering two alternative credit plans: plan A would change the credit terms 2/10, net 45; plan B would extend the credit period even further, making the terms 2/10, net 60. plan A is expected to increase sales by 5 per cent from current levels, whereas plan B would increase sales by 7 per cent. Mitsui's margins on sales before credit-related costs and taxes are 20 per cent. Investments in accounts receivable carry a 12 per cent before tax cost.

In trying to decide whether to keep the present credit plan or switch to either of plans A or B, management recognises that an occasional result of extending the credit period

will be that more customers will take the discount. However, they feel that with the present plans there will be no change in the rupee volume of sales on which the discount is taken. That is, all incremental sales will be paid for after the 10-day discount period. In addition, management feels that 1 per cent of all incremental sales under plan A and 2 per cent under plan B will prove to be uncollectible. No additional credit costs will be involved in clerical or administrative functions. Which credit period policy appears to be the most desirable?

The variables to be considered in deciding between the present credit terms and plans A and B are profits on increased sales, increases in accounts receivables, increases in the cost of financing the additional receivables, and increased in bad-debt losses. The effects of the three credit terms on these variables are summarized in Table 1. The analytical approach is incremental. that is, given the existing credit terms we focus on the incremental profits and costs of plans A and B. Under plan A sales increase by 5 per cent or $0.05 \text{ per cent} \times \text{Rs } 36 \text{ crore} = \text{Rs } 1.8 \text{ crore}$. Sales would increase by Rs 2.52 crore under plan B. Marginal profits before taxes and credit-related expenses are $0.2\% \times \text{Rs } 1.8 \text{ crore} = \text{Rs } 3,60,000$ for plan A and Rs 504,000 for plan B.

Increases in accounts receivable cannot be calculated by just looking at incremental sales. The reason is that when the credit period is extended, the existing buyers who are not taking the discount and are paying after 30 days will also take advantage of the extended credit period and not pay for 45 days. Incremental investment in receivables is estimated by calculating total receivables first. For present credit terms, 50 per cent of sales are paid for in 10 days, the other 50 per cent in 30 days. The average sale is outstanding for $0.5(10) + 0.5(30) = 20$ days. Daily sales are $\text{Rs } 36 \text{ crore} / 360 \text{ days} = \text{Rs } 100,000$. Total accounts receivable equal $20 \text{ days} \times \text{Rs } 100,000 = \text{Rs } 2 \text{ crore}$.¹

TABLE 1
EFFECTS OF CREDIT POLICIES ON INCREMENTAL SALES, RECEIVABLES, INVESTMENT COSTS, BAD DEBT LOSSES, AND PROFITS

	Present	Plan A	Plan B
(d) Increase in sales (%)	0 %	5 %	7 %
(e) Increase in sales (Rs=1×Rs 36 crore)	Rs 0	Rs 1,800,000	Rs 2,520,000
(f) Margin on sales (%)	20%	20%	20%
(g) Marginal profits (Rs = 2 × 3) ^a	Rs 0	Rs 360,000	Rs 504,000
(h) Average sales outstanding	20 days	28.34 days	36.65 days
(i) Daily sales	Rs 100,000	Rs 105,000	Rs 107,000
(j) Total receivables (5 × 6)	Rs 2,000,000	Rs 2,975,000	Rs 3,921,600
(k) Increase in receivables	0	975,700	1,921,600
(l) Increase in investment costs (8×12 %)	0	117,084	230,592
(m) Increase in bad debt losses (2 × x%)	0	18,000	50,400
(n) Increase in costs (9+10)	0	135,084	280,992
(o) Increase in profits (4 – 11)	0	224,916	223,008

Under plan A total sales are Rs 36 crore + 1.8 crore = Rs 37.8 crore. The rupee amount subject to payment by the tenth day remains at Rs 18 crore or Rs 18 crore / Rs 37.8 crore = 47.6 per cent. The other 52.4 per cent now take 45 days to pay. The average sale will be outstanding for $0.476 (10 \text{ days}) + 0.524 (45 \text{ days}) = 28.34 \text{ days}$. Daily sales are Rs 37.8 crore/360 days = Rs 105,000. Total receivables are Rs 105,000 \times 28.34 days = Rs 2,975,700.

Under plan B total sales Rs 38.52 crore. The percentage of discount takers is Rs 18 crore Rs 38.52 crore = 46.7 per cent. The average sales is outstanding for $0.467 (10 \text{ days}) + 0.533 (60 \text{ days}) = 36.65 \text{ days}$. Daily sales are Rs 38.52 crore / 360 days = Rs 107,000 and receivables are Rs 107,000 \times 36.65 days = Rs 3,921,600.

Incremental receivables for plan A are Rs 2,975,700 - Rs 2,000,000 = Rs 975,700 and are Rs 1,921,600 for plan B. The before-tax cost of financing these receivables is 12 per cent. Therefore, the increase in investment costs for plan A is Rs 975,700 \times 0.12 = Rs 117,084 and is Rs 1,921,600 \times 0.12 = Rs 230,000 for plan A and $0.02 \times$ Rs 2.52 crore = Rs 50,400 for plan B.

The total incremental credit associated costs for plan A are Rs 117,084 + Rs 18,000 = Rs 135,084 and are Rs 280,992 for plan B. The incremental profits after adjusting for credit costs are Rs 224,916 for plan A and Rs 223,008 for plan B. Both plans are superior to the present plan. However, plan A is slightly preferable to plan B.

Credit Discount: The credit discount is offered as an inducement for the credit buyer to pay promptly. The credit buyer's opportunity cost of not taking the discount is given by:

$$\frac{360 \text{ days} \times \text{credit discount}}{\text{credit period} \quad \text{discount period}}$$

For terms of 2/10, net 30 the opportunity cost of not taking the discount is $360 \text{ days} \times 2 \text{ per cent} / (30 - 10) = 36 \text{ per cent}$. Obviously, this opportunity cost has to be high enough to motivate a financially strong credit buyer to take the discount. For example, terms of 1/10, net 70 imply an opportunity cost of 6 per cent. At this cost firms will prefer to use trade credit rather than borrow from banks and the credit discount is no longer a viable credit policy instrument.

Although changing the credit discount has some influence on demand, its most visible impact is on reducing the average collection period and the level of accounts receivable. Assume that Mitsui is considering changing its credit terms from 2/10, net 30 to 2.5/10, net 30 in plan C or 3/10, net 30 in plan D. Either of the new plans would not affect the sales volume. However, under plan C, 70 per cent of the credit buyers would take the credit discount and, under plan D, 90 per cent would take the discount.

Should Mitsui switch to either plan C or D if the previously given information on investments cost is applicable here?

The analysis here would be similar to the one done for the credit period. Gross sales volume under either the present credit terms or plan C or D remain at Rs 36 crore. Sales for which discounts are taken are 50 per cent or Rs 18 crore for the present plan, and Rs 25.2 crore and Rs 32.4 crore for plan C and D, respectively (see Table 2). The credit discount for the present plan is 2 per cent or $0.02 \times \text{Rs } 18 \text{ crore} = \text{Rs } 360,000$. For plan C it is $0.025 \times \text{Rs } 25.2 \text{ crore} = \text{Rs } 630,000$ and is Rs 972,000 for plan D. The incremental cost of going to a more liberal credit discount under plan C is $\text{Rs } 630,000 - \text{Rs } 360,000 = \text{Rs } 270,000$ and is Rs 612,000 for plan D.

The increase in credit costs due to giving a larger credit discount reduces the level of investments in accounts receivable. Total receivables under the present plan were calculated to be Rs 2 crore in Table 1. Under plan C the average collection period is $0.7 (10 \text{ days}) + 0.3 (30 \text{ days}) = 16 \text{ days}$. Since daily sales are Rs 100,000, total receivables are Rs 1.6 crore. Under plan D total receivables are $[0.9 (10 \text{ days})] \times \text{Rs } 100,000 = \text{Rs } 1.2 \text{ crore}$. Under plan C, receivables decrease by $\text{Rs } 2.0 \text{ crore} - \text{Rs } 1.6 \text{ crore} = \text{Rs } 400,000$. The decrease in investments under plan D is $\text{Rs } 2.0 \text{ crore} - \text{Rs } 1.2 \text{ crore} = \text{Rs } 800,000$.

The cost of investments in receivables is 12 per cent. Cost savings are $\text{Rs } 400,000 \times 0.12 = \text{Rs } 48,000$ for plan C and Rs 96,000 for plan D. Cost savings less increase in discount costs give increase in profits before taxes. As Table 2 shows, neither plan C nor plan D results in increasing profits over the present levels. Consequently, Mitsui should not implement either plan C or plan D.



^a Before credit related costs and taxes.

¹ Sales are assumed to be reasonably equally distributed among buyers. Also, it is assumed that the daily sales volume is constant.

Discount Period: The analysis of changing discount periods is very similar to the analysis for changing credit discounts. As the discount period is increased, the opportunity cost of not taking a discount increases. Therefore, it becomes more attractive for a credit buyer to take the discount. However, as the discount period is extended the existing discount takers take advantage of the liberalised credit terms and delay making their payments until the end of the new discount period. Whether extending the discount period is desirable is dependent on whether total receivables increase or decrease.

Continuing the Mitsui example, the firm can change credit terms to 2/12, net 30 or 2/15, net 30 under plans E and F, respectively. The per cent of sales subject to the discount would be 60 per cent in plan E and 80 per cent in plan F. Should Mitsui switch to either plan E or plan F? Gross sales would not be affected by these alternative plans.

	Present	Plan E	Plan F
(d) Gross sales volume	Rs 36,000,000	Rs 36,000,000	Rs 36,000,000
(e) Sales with discounts (%)	50%	60%	80%
(f) Sales with discounts (1×2)	Rs 18,000,000	Rs 21,600,000	Rs 28,800,000
(g) Credit discounts (Rs = 3×2%)	Rs 360,000	Rs 432,000	Rs 576,000
(h) Increase in discounts	0	Rs 72,000	Rs 216,000
(i) Total receivables	Rs 2,000,000	Rs 1,800,000	Rs 1,400,000
(j) Decrease in receivables	0	Rs 200,000	Rs 600,000
(k) Decrease in investment costs (7×12%)	0	Rs 24,000	Rs 72,000
(l) Increase in profits (8–5)	0	(Rs 48,000)	(Rs 144,000)

Sales subject to discounts would be Rs 18 crore, Rs 21.6 crore, and Rs 28.8 crore, for the present terms, plan E, and plan F, respectively. Credit discount at 2 per cent would be Rs 360,000 for the present plan and Rs 432,000 and Rs 576,000 for plans E and F, respectively. The increase in discounts for plan E would be Rs 72,000 and would be Rs 216,000 for plan F (Table 3).

The total receivables under plan E would be $[0.6 (10 \text{ days}) + 0.4 (30 \text{ days})] \times \text{Rs } 100,000 = 1.8 \text{ crore}$. The same entry would be $[0.8 (10 \text{ days}) + 0.2 (30 \text{ days})] \times \text{Rs } 100,000 \text{ Rs } 1.4 \text{ crore}$ for plan F. A decrease in investment costs due to a decrease in receivables is Rs 24,000 for plan E and Rs 72,000 for plan F. Taking into consideration the increased discounts being given, we find that neither of the two new plans is acceptable.

Simultaneous Changes in Credit Terms

Most firms, from a practical standpoint, will consider changes in all credit terms

simultaneously. For example, the Mitsui Corporation may seek to evaluate new credit terms in which the credit period, credit discount, and discount period all change simultaneously. As we have seen previously, extending the credit period influences sales most strongly, whereas changing the other two credit terms has a strong impact on the level of receivables outstanding. A firm considering changing all credit terms needs to carefully examine the potential impact of the changes on incremental profits. Assume that Mitsui is considering changing from terms of 2/10, net 30 either to 2/15, net 45 in plan G or 2.5/15, net 60 in plan H. Under plan G sales are expected to increase by 5 per cent, whereas with plan H sales would have a potential of increasing by 10 per cent. Marginal returns before credit-adjusted costs and taxes would be 20 per cent of sales.

Under the present credit terms, the average collection period is 20 days (as shown in Table 1). Under plan G, 45 per cent of sales would involve the discount. Those who take the discount would pay at the end of the discount period, on the average, pay by the end of the credit period. Bad-debt losses would increase by 1 per cent of incremental sales for plan G and 2 per cent of incremental sales for plan H. Collection costs would increase by Rs 10,000 and Rs 30,000 under plans G and H, respectively which credit term plan appears to be best for Mitsui.

Under plan G sales and marginal profits would increase by Rs 1.8 crore and Rs 360,000, respectively. For plan H sales would increase by Rs 3.6 crore and profits by Rs 720,000. These marginal profits are before credit adjusted costs and need to be adjusted for changes in the investment levels in receivables and in discount taken.

Given credit terms of 2/15, net 45, average collection period for plan G is $0.45 (15 \text{ days}) + 0.55 (45 \text{ days}) = 31.5 \text{ days}$. Since daily sales are $\text{Rs } 37.8 \text{ crore}/360 \text{ days} = \text{Rs } 105,000$. Total receivables for plan G would be $31.5 \text{ days} \times \text{Rs } 105,000 = \text{Rs } 3,307,500$. Similarly, total receivables for plan H would be $[0.40 (15 \text{ days}) + 0.6 (60 \text{ days})] = 42 \text{ days} \times 39.6 \text{ crore}/360 = \text{Rs } 4,620,000$ (see Table 4).

For plan G bad debt losses would be $\text{Rs } 1.8 \text{ crore} \times 0.01 = \text{Rs } 15,000$ and Rs 72,000 for plan H. Cost of giving discounts and increased collection costs are shown in Table 4. Given the total credit related cost increases of Rs 165,100 for plan G, its profitability before taxes is $\text{Rs } 360,000 - \text{Rs } 165,000 = \text{Rs } 194,900$. Similarly, plan H would increase pretax profits by Rs 267,600. Of these two plans, H is the better one. Plan H is also the best plan among all eight plans discussed in this section.

From total receivables we can calculate incremental receivables and the cost of increased investments in receivables, as shown in Table 4.



	Present	Plan G	Plan H
(d) Increase in sales (%)	0%	5%	10%
(e) Increase in sales (Rs = 1 × Rs 36 crore)	0	Rs 1,800,000	Rs 3,600,000
(f) Margin on sales (%)	20%	20%	20%
(g) Marginal profits (Rs = 2×3) ^a	0	Rs 3,60,000	Rs 720,000
(h) Average collection period	20 days	31.5 days	42 days
(i) Daily sales	Rs 100,000	Rs 105,000	Rs 110,000
(j) Total receivable	Rs 2,000,000	Rs 3,307,500	Rs 4,620,000
(k) Increase in receivable	0	Rs 1,307,500	Rs 2,620,000
(l) Increase in investment costs (8×12%)	0	Rs 156,900	Rs 314,400
(m) Increase in bad debt losses (2 × x%)	0	Rs 18,000	Rs 72,000
(n) Sales with discount (Rs)	18,000,000	17,010,000	15,840,000
(o) Credit discounts (%)	2%	2.5%	2.5%
(p) Credit discounts (Rs = 11 × 12)	360,000	340,000	396,000
(q) Increase in discounts	0	19,800	36,000
(r) Increase in collection costs	0	10,000	30,000
(s) Increase in credit costs (9 + 10 + 14 + 15)	0	165,100	452,400
(t) Increase in profit (4 – 16)	0	194,900	267,600

^a Before credit-related costs and taxes.

Collection Policy

When an account becomes delinquent, a firm can resort to a series of actions to try to collect on the account. These actions include writing a letter, calling on the phone, calling in person, using a collection agency, and legal action. The particular collection procedures followed have a direct impact on bad-debt losses and the average collection period. The firm has an obvious interest in reducing both bad-debt losses and the average collection period, which lower total receivables and average collection period, which lower total receivables and investment in receivables. In general, the more the firm spends on collection, the lower its delinquency costs (bad-debt losses) and the cost of maintaining excess receivables. However, the marginal productivity of collection expenditures decline as the firm expends more and more.

The discussion on collection policy has assumed that sales are independent of collection policy. Most firms recognise that instituting a very aggressive collection policy may be very irritating for some customers who are frequently slow in paying. An aggressive collection policy may therefore adversely affect sales. A second result of an aggressive collection policy may be to force more customers to prefer taking the discounts. These

two factors need to be recognised before a firm implements a collection policy that equates marginal collection expenditures with marginal reductions in delinquency costs.

Establishing Credit Limits

The fact that the business has a credit policy does not mean that credit terms will be granted to every customer. It is not always easy to decide whether a particular customer is 'credit worthy' in the sense that he has both the ability and the inclination to pay at the due date. Many companies require cash with order from new customers until their creditworthiness have been established.

Five Cs of Credit that a bank looks at are the ones that you should also look at while granting credit:

- **Character:** Willingness to pay back the credit
- **Capacity:** Ability to pay back
- **Capital:** Financial reserves including cash
- **Collateral:** What assets could be pledged or are pledged to others that hinder payments
- **Conditions:** Relevant economic conditions

That means that in assessing the creditworthiness of a customer two things are absolutely necessary:

- (a) Facts about his business, in particular whether it is profitable, whether it is generating or has access to sufficient cash to meet its liabilities, and whether it has suitable assets available to cover the claims of unsecured creditors in the event of winding up. In brief, it is necessary to analyse the accounts of the business. It is helpful also if the customer will supplement these with the sort of information they do not give; e.g., the current order book, any plans for future development, and the condition and market value of the assets owned by his business.
- (b) Opinions about the business and the people running it, formed from either personal contacts (director level, or at any reliable and knowledgeable level) or obtained from third parties such as business associates, mutual acquaintances or employees changing jobs.

There are other sources from which we can have information about the company as well as the industry that it is operating in:

- (a) Reports from the relevant trade protection association, if one exists;
- (b) Trade references from other companies with which the customer does business;

- (c) Bank references - these may not give a lot of information but they tend to use a series of standardised replies, and experience of these will indicate the relative credit grading of the customer in question;
- (d) Reports published in trade journals or the financial press dealing either with the customer company or with the type of business in which it is engaged.

In assessing the creditworthiness of overseas customers, reports from bankers are an important source of information. It is also necessary to weigh up the risks of the customer being prevented from paying either through political or exchange control restrictions. On all these matters the Export Credits Guarantee Department can usually give guidance.

If the customer's creditworthiness appears to be established, the next stage is to decide the amount of credit to be given.

Theoretically there are three possible ways of doing this:

- (a) The income or cash flow method, which requires knowledge of the amounts of cash becoming available to the customer, and how he proposes spending them, thus indicating his ability to pay the supplier's invoices - this method is possible between a bank manager and his client seeking an overdraft or loan, but seldom in business life;
- (b) The capital structure method, under which the value of uncharged assets in the customer's last balance sheet is established, and the credit limit will be a percentage of this value. This is a necessary calculation when the proposed value of future transactions will involve a major increase in the customer's total indebtedness, but it is not an indicator of liquidity, and is not particularly relevant to small transactions in the ordinary course of trade;
- (c) The requirement method, which is almost always used in practice. If the customer is creditworthy then we should be able to rely on him to pay any amounts arising from the ordinary course of business. The amount of credit granted, therefore, is based on the value of business which the customer expects to place with the supplier each month. The forecast monthly sales to the customer are multiplied by a number of months' credit laid down as company policy to give that customer's credit limit. If, for example, a customer proposed placing orders totalling Rs.1,500 per month with a supplier whose credit terms required payment by the end of the month following the date of invoice (say, two month's credit) the credit limit granted him might be $2 \times \text{Rs.}1,500 = \text{Rs.}3,000$ outstanding on the ledger accounts at any time.

For customers of international repute it may be decided that no limitation of credit is necessary, but the financial difficulties faced by several major companies in recent

years must be a warning against the automatic granting of unlimited credit.

Vetting Incoming Orders

The amount appearing on the customer's ledger account at any time will, of course, result from invoicing the orders he has placed, so that if the value of orders in any period were to exceed the original forecast this might not become apparent until after invoicing. At that time the outstanding balance on the ledger would suddenly be found to be in excess of the agreed limit.

To safeguard against this possibility an order register may be kept for each customer, showing the value of orders placed for delivery in particular months. Each incoming order will then be checked against the register to confirm that it will not cause the credit limit to be exceeded. This could be a cumbersome procedure, and normally it would only be used in respect of:

- (a) New customers' whose compliance with credit limits has not been established;
- (b) Customers who had consistently failed to adhere to their credit limits in the past. (It might be better in such cases to withdraw credit facilities completely).

All incoming orders should be checked to ensure that are placed on the customer's official order form and authorised by somebody purporting to have the power to place that type of order. Computerisation has made this task very easy.

Sales Invoicing

So far as the customer is concerned, the company's credit period does not begin until he receives an invoice. Even then his accounting procedures probably involve a monthly cut off date for the receipt of invoices, so that any invoice received after, say, the 28th day of the month will be treated as belonging to the succeeding month.

It is important, therefore, that delays in invoicing be kept to a minimum. The causes of delay are nearly all within the control of the company, and may include:

- (a) An inflexible routine in the sales invoicing department (perhaps invoices are issued only on certain days in the month);
- (b) A requirement for approval or signature of sales invoices by members of the sales staff who are often away from the office;
- (c) Failure to agree prices for special work; and
- (d) For job work, and in other cases where prices are linked with costs, excessively slow procedures for calculating costs.

Debt Collection

There must be no slackness in pursuing the collection of debts. In most business purely formal reminders are ineffective, and therefore a waste of money, when an account has passed its due date there should be early personal contact with the customer either by telephone or a salesman's visit or by a letter addressed to a named person in the customer company. If necessary, there may be a follow up at the higher level of authority. And this should be followed by a threat to cut off supplies.

The value of legal action against debtors needs to be assessed. When this stage is reached, the likelihood of the customer's paying is sharply reduced, and additional legal costs may never be recouped. On the other hand, the action may deter potential future defaulters.

From the point of view of the salesman every customer is valuable. From the financial director's standpoint the marginal contribution from goods sold to a late payer will be more profitable without sales to that particular customer.

Overdue debts should be the subject of formal discussion between the sales and financial managers. The reasons for delayed payment should be noted, and decisions should be minuted on the action to be taken in each case and the people responsible for taking it.

Although the salesman's job is not complete until his customer has paid the money due, it is often advantageous for the more rigorous collection procedures to be handled by finance staff, leaving the salesman free to exercise his persuasive influence with the customer's buying department.

Credit and Collection Procedures

In the previous section we considered the firm's overall credit and collection policies. In this section we shall discuss how these policies can be applied to individual accounts. In this section we shall first discuss sources of information and then the decision to grant credit. Finally, we shall look at specific procedures that could be utilised to collect delinquent accounts.

Sources of Information

An individual or firm is requesting credit. What sources of information are available to judge the credit worthiness of the applicant? Sources that can be utilised are financing statements, bank references, and credit bureaus.

Financial Statements: A vital source of information is the applicant's financial statements. An applicant who is in a financially sound position would have no hesitation in making available his or her financial statements. Interim reports, if available, are more desirable than annual reports. Audited and CPA certified reports are preferred to

unaudited reports. The financial statements are useful for calculating various liquidity, leverage, efficiency, and profitability ratios that may be used in evaluating credit risk. If the firm is using a credit scoring model (discussed later) or if the applicant is requesting a large amount of credit, financial statements are essential.

Credit Bureaus: Credit bureaus specialise in consolidating the experiences of other firms with the applicant. Credit bureaus compile a history of the applicant's credit payment performance as reported by the credit-granted firms. Financial information on a credit applicant may be obtained by credit bureau member firms who agree to provide credit bureaus with information on their clients.

In addition to these information sources, a firm may try to compile its own information. It may have its sales personnel prepare a report on the credit applicant. Alternatively, if the credit request is large enough, it may send a credit department employee to visit personally with the credit applicant and garner as much financial information as possible.

Credit Analysis and Credit Limit

A firm reviewing a request for credit needs to judge the credit applicant's willingness and ability to pay. If either of these two factors is missing, the firm would increase its chances of suffering losses on credit extended to the applicant. Willingness to pay is judged by the firm's past financial performance. Its ability to pay is judged by the strength of its financial statements in relation to the amount of credit desired. Either heuristic or statistical procedures could be utilised in credit analysis.

Heuristic Approach: The heuristic approach described here is based on a manufacturing company's actual experience. The formula or procedure described here has the weight of managerial experience and intuition behind it and therefore is heuristic in nature. There are eight factors that need to be considered in the decision to establish a credit limit and grant credit. The credit limit is the maximum amount of credit purchases allowed the credit applicant at any one time and is stated as a per cent of tangible net worth. The lower limit is minus 15 per cent and is tantamount to denying new credit to the applicant. The upper limit is 80 per cent and is equivalent to the sum of the maximum percentage points on the eight credit-granting factors.

Credit Requirements; The first factors is applicant credit requirements, (C). This factor is a measure of the applicant's dependency on the creditor. If the applicant plans to buy less than 25 per cent of his requirements from the creditor, he gets 0 per cent toward his credit line. If he plans to buy between 25 and 50 per cent, he gets a 5 per cent allowance. If the plans to buy over 50 per cent he gets a 10 per cent allowance (see Table 5).

Pay Habits: The second factor is pay habits (P) and is a measure of the willingness

and ability to pay. Payments during the discount period rate 10 per cent. Payments during the credit period are worth 5 per cent. Habitually late payments rate minus 5 per cent.

Years in Business: The third factor is years in business (Y) and is a measure of the ability of the firm to pay. Being in business less than 3 years has no effect on increasing the limits. If Y is between 3 and 10 years, the limit is increased by 5 per cent. If the firm has been in existence for more than 10 years, it rates 10 per cent.



CONTRIBUTING FACTOR	Rating	Contribution to Credit Limit : Per cent of Net Worth
Applicant credit requirements (C)	C < 25%	0
	25 < C < 50%	5
	C > 50%	10
Pay habits (P)	Take discount	10
	Pays on time	5
	Pays late	-5
Years in Business (Y)	Y < 3 years	0
	3 < Y < 10	5
	Y > 10	10
Profit Margin (M)	M < 5%	0
	5% < M < 14%	5
Current Ratio (R)	R > 2.2	10
	1.5 < R < 2.2	5
Total debt total assets (T)	T < 30%	10
	30% < T < 50%	5
Inventory Turnover (I)	I > 5	10
	I < 5	5
Qualitative (Q)	Q = high	10
	Q = average	5
	Q = low	-5

Profit Margin. The fourth measure is the profit margin (M). If margins are less than 5 per cent, 0 per cent is contributed to the credit limit. Margins in excess of 14 per cent contribute 10 per cent to the credit limit.

Current Ratios. The fifth measure is the current ratio (R). A current ratio of over 2.2 to 1 is considered to be a good indication of ability to pay and helps contribute 10 per cent toward the credit limit. A current ratio of less than 1.5:1 is considered to be relatively weak and does not help increase the credit limit.

Total Debt to Asset Ratio. The sixth measure is the ratio of total debt to total assets (T) and represents the ability to pay. If T is less than 30 per cent, the applicant is viewed to be conservatively leveraged and adds 10 per cent to the credit limit.

On the other hand, a T of over 50 per cent implies increased financial riskiness and rates a minus 5 per cent toward the credit limit.

Inventory Turnover. The seventh factor is the inventory turnover (I). A higher inventory turnover implies high efficiency; I can help contribute anywhere from 0 per cent to 10 per cent toward the credit limit, as shown in Table 5.

Qualitative Factor. The last factor is a qualitative factor (Q) and lets the credit manager use discretion in subjective evaluation of the credit applicant's willingness and ability to pay.

It should be kept in mind that the factors mentioned here and their contribution to the credit limit are based on a particular firm's actual experience. The factors and their contributions to the credit limit may vary from accounts payable, and the economic environment would also be considered in developing a heuristic credit evaluation decision model.

As an example we can apply the heuristic model presented here to evaluate Kartik Metal. Assume that Kartik is requesting a credit line to buy less than 25 per cent of its raw materials requirements. What is the maximum credit line to establish for Kartik? The contributions of the various factors to the credit limit are shown in Table 6. The last factor, Q, is rated average.

TABLE 6: CONTRIBUTIONS OF VARIOUS FACTORS TO THE CREDIT LIMIT

Factor	Kartik's Rating	Contribution to Credit Limit (per cent)
1. Kartik's requirement (C)	C < 25 %	0
2. Pay habits (P)	Takes discount	10
3. Years in business (Y)	Y > 10	10
4. Profit margins (M)	M = 4.6 % < 5 %	0
5. Current ratio (R)	R = 2.89 > 2.5	10
6. Total debt to total assets (T)	T = 0.28 < 0.3	10
7. Inventory turnover (I) a	I = 12 > 10	10
8. Quantitative (Q)	Average	5
Total Contribution		55

^a Based on sales; Rs 177, 250/Rs14, 619 = 12

Kartik's credit limit = Rs 42,961 0.55 = Rs 23,600.

Additional credit for Kartik = Rs 23,00 – Rs 7500 = Rs 16,100.

because of Kartik's dependence on only 12 customers. Total contribution of the eight factors to the credit limit is 55 per cent of tangible net worth, or Rs 42,961 × 0.55 = Rs 23,600. Since the existing credit lines total Rs 3,000 + Rs 2,500 = Rs 7,500. Kartik can be extended additional credit up to Rs 23,600 – Rs 7,500 = Rs 16,100.

Statistical Approach. In quantitative approaches to credit analysis, the firm relies on financial information as well as on the payment records of firms it granted credit in the

past. Past customers can be readily classified into good risk and bad risk categories. The financial information on customers is used in conjunction with a statistical procedure called multiple discriminant analysis to develop a statistical credit scoring model. Discriminant analysis first of all provides an indication of those measures which are most important in distinguishing between good risk and bad risk customers. That is, the firm may start out by using 30 ratios and variables in its analysis. Discriminant analysis might indicate that only five of these ratios and variables are important in characterising good risk and bad risk customers.

Second, discriminant analysis will develop weights for each ratio or variable to form a discriminant function that may look like:

$$\text{discriminant score} = 3.5 (\text{current ratio}) + 1.7 (\text{profit margins}) + 7.1 (\text{debt to assets}) + 0.3 (\text{inventory turnover}) + 1.9 (\text{quick ratio})$$

The 3.5, 1.7, and so forth, are weights developed by discriminant analysis. Current ratio, profit margins, and so forth, are discriminant variables identified as important by the model. The sum of the products of the weights and the variables is the discriminant score. The analysis selects weights such that discrimination between good risk and bad risk accounts is maximised. A perfect set of weights would create a discriminant score such that all bad risk firms would have scores on one side of the discriminant score. Once the discriminant credit scoring model has been developed, it can be applied to credit applicants. The weights can be used to calculate a score for the credit applicant. The credit applicant's score can be compared with the discriminant score to see whether the applicant falls in the good risk or bad risk category. If the applicant falls in the good risk category, a similar type of procedure to that described here can be used to establish a credit limit for the applicant.

A variety of collection procedures can be utilised by the firm in its efforts to collect on delinquent accounts. The initial efforts should be very low key and should become more strict as per the response from debtors. If payment is not received within a few days, one or more follow up letters should be sent demanding payment.

Telephone Call. If letters are unsuccessful, a credit department employee, preferably the manager, should call the delinquent debtor and ask for prompt payment. The credit manager may also wish to communicate that legal action may be taken if payment is not forthcoming.

Personal Call. Some firms have either collection personnel or sales representatives visit delinquent debtors. The firms feel that a face-to-face confrontation with a delinquent debtor provides them with an edge over other creditors.

Collection Agency. If the preceding measures are unsuccessful, the firm may consider the services of a collection agency. The collection agency fee is typically high-usually

50 per cent of the amount collected. For small delinquent accounts this may be the only feasible alternative.

Legal Action. Legal action is usually costly and there is no guarantee of a payment. If a firm is in a very weak financial position, legal action will force it into bankruptcy. The firm may choose to use legal action as a negotiating tool to deal with large delinquent accounts. With a very large delinquent account, the firm may use the threat of legal action to appoint more competent management.

Cost of Credit Control

The costs of credit control include the cost of:

- assessing and reviewing creditworthiness;
- checking incoming orders;
- sales ledger keeping, and invoicing
- debt collection.

These costs may occur in various departments of the business, but there should be some means of identifying them and collecting the total cost, which will have to be taken into account in reviewing the benefits of the credit policy.

Cash Discount

An alternative or supplement of a formal credit policy is to offer discount for prompt payment. In considering this possibility it is important to bear in mind that:

- (a) customers who normally pay promptly will now become entitled to discount, although there will be no improvement in the timing of their payments'.
- (b) some late payers will nevertheless deduct discount from their settlements, and there may be some practical difficulty in recovering these incorrect deductions.

There are various other ways in which a business can speed up its collection of cash without requiring the customer to pay any earlier. The most common examples are by using bills discounting or factoring both of which have been mentioned earlier.

Personal Guarantees

An alternative form of protection against bad debts is to take a personal guarantee in support of the customer's account. The value of personal guarantees varies considerably and they are likely to present two problems.

- it may be more difficult to assess the creditworthiness of an individual guarantor than of the trade customer;

- the guarantor does not normally expect to be called upon to pay, and there may be difficulties in obtaining money from him when the need arises.

These problems do not occur to the same extent when the guarantor is another company, often the parent company in the customer's group.

So the objective of the receivables management remains as the most effective way to receive the cash back without sacrificing the sales and future prospects of the company.

Factors affecting policies for managing accounts receivables

There are several affects of extending credit to the customers on various operating parameters of the company. These include:

1. **Revenue effects:** As the customers are extended credit, payment for goods is received later giving the customers time to generate sales from the goods and pay back the company. This may allow the company to charge a higher price and also the quantity sold may increase.
2. **Cost effects:** Extending credit means that the company has to maintain a credit department. This involves costs. Also collecting receivables has its own costs associated with it.
3. **The cost of debt:** If the company has to extend credit it must finance these receivables from its own money or from borrowings. Both of these methods involve costs.
4. **The probability of nonpayment:** The company always gets paid if it sells for cash but if it extends credit there is a probability that the customer may not pay. This means that the company may not get its payments resulting in a loss to the company.
5. **The cash discount:** The cash discount affects payment patterns and amounts that the company receives early. If the cash discount is high then there is higher probability that the company will get more cash upfront and vice versa.

Chapter-10

Inventory Management

The financial decisions relating to stockholding have certain special features, but looking first at saleable stocks (finished goods) we can postulate that the object of holding stocks is to increase sales, and that the object of increasing sales is to increase profit. We can then create a simple model similar to that for debtors.

Example

The Retail Company Ltd makes cash sales from stock and obtains an average rate of marginal contribution of 25% on sales value. When it holds stocks equivalent to one month's cost of sales it achieves sales of Rs.10,000 per annum.

It is estimated that by doubling the stock available an increase of 25% in sales value could be achieved; alternatively, if three months' stocks were held then sales could be increased by 35% from the present level. The effect on profits of these two alternatives, including any relevant changes in costs, is illustrated on the following page.

This somewhat exaggerated example draws attention to three points which are relevant to any further discussion of the financial implications of stockholding policy:

Rs.	No credit	One month's Credit	Two month's Credit
Sales	120,000	160,000	240,000
Debtors	13,333	40,000	
Stocks (less creditors (Say, 1/12 of sales value))	10,000	13,333	20,000
Total	10,000	26,666	60,000
Increase in working capital through granting credit		16,666	50,000
Marginal contribution	30,000	40,000	60,000
Less: Cost of:			
Credit control		(6,000)	(6,000)
Bad debts		(1,600)	(4,800)
Relevant comparable profits	30,000	32,400	49,000
Increase in profits		2,400	19,200
But the company requires a return of 15% on the increase in capital employed; i.e.		2,500	7,500
The net advantage (or disadvantage) of the proposed changes in credit policy is therefore		(Rs.100)	Rs.11,700

There are some points that you need to note here:

- There may be a point beyond which further increase in stock will not give rise to sufficient additional sales and gross profit to justify the additional costs involved.

- Purchase order processing costs per unit or Rs. value of purchases (and possibly even in total as shown) are likely to diminish as stock holdings are increased, because instead of having to frequent orders for the renewal of stocks, the company is now placing less frequent bulk orders i.e. one negotiation, one order and one progress action cover a large quantity of any particular item;
- Stock holding costs naturally increase with the size of stockholdings because:
 1. stocks occupy space which has to be purchased, rented or converted from some other use - that space has to be equipped with racks or containers;
 2. people are required to put the stocks into the warehouse, to withdraw them when needed (picking and packing), to record them, check their conditions and ensure they are not lost;
 3. stocks lose value if they deteriorate, are wasted in handling, pilfered, destroyed or allowed to become obsolete - it may be desirable to insure against some of these risks;
 4. stocks tie up money, involving interest charges or opportunity costs.

Why should increased stocks give rise to increased sales? One reason would be that the business may offer a wider range of goods and it diversifies its range. Another could be that with the existing range the business was offering a better level of service; i.e. it was less frequently out of stock of an item when it was required.

Stock Service Levels

In deciding on an inventory policy it is necessary to define the level of service to be offered to the customer, in the sense of the percentage of order which can be satisfied immediately from stock. This will depend on the nature of the business.

In some cases the company may be the monopoly supplier of certain goods, or may offer particular advantages of quality, reputation., reliability or after-sales services. Where such distinguishing features exist, it is possible that the customers will be prepared to endure occasional delays in meeting their requirements, and it would not be necessary to hold sufficient stocks to ensure immediate delivery.

In other cases quick delivery may be an essential feature of success in achieving sales. This would be the case, for example, if there was strong competition for a limited market, or if the failure to supply a spare part for installed equipment would cause significant loss to the customer while the equipment was out of use.

When the required level of service has been defined, the next problem is to decide how much stock is needed to meet that requirement. This will be the minimum holding, and

not the average holding which will be influenced by the stockholding costs illustrated in the previous paragraph.

Pattern of Procurement and Stockholding

Assuming that an item is in constant demand there are no difficulties in obtaining supplies, it would be normal to take a supply into stock and then use it up steadily until it was exhausted, when a new supply would be obtained. Taking the example from the paragraph on control of stock where sales were to be Rs. 1,35,000 per annum, assume, that this represents 1,35,000 units of an item of stock at Rs. 1 each. If demand is steady, the monthly usage of this item would be 11,250 units.

Now it would be possible to buy all 1,35,000 units at the beginning of the year and to use them progressively as shown in the following diagram:

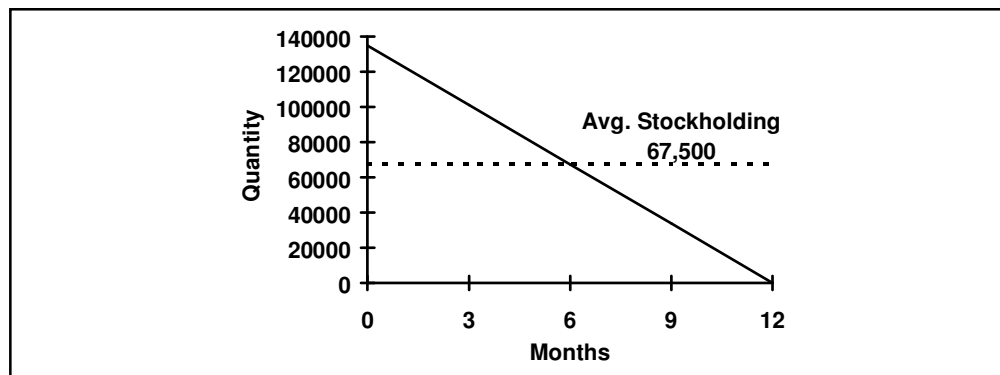

If this was done then:

- there would be only one purchase, so the related costs in the buying department would be low;
- the average stock holding would be 62,500 units, so there would be $62,500 \times 12 = 7,50,000$ unit-months to influence the costs of stock-holding.

An alternative action would be to buy twice during the year, as shown in the next diagram. This would double the procurement costs, but would reduce the average stockholding to 31,250 units so that stockholding costs would be determined by only half the previous number of unit-months.

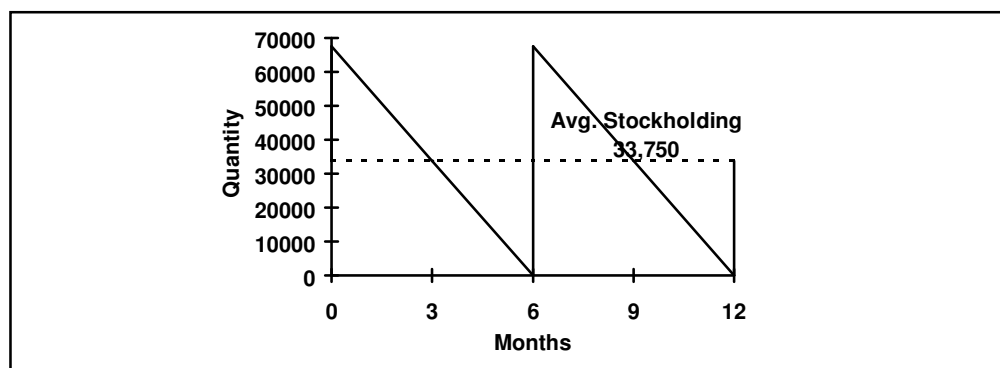

There is obviously a very large choice of procurement and stockholding patterns; what is needed is to find that pattern which keeps total procurement and holding costs at the lowest possible level.

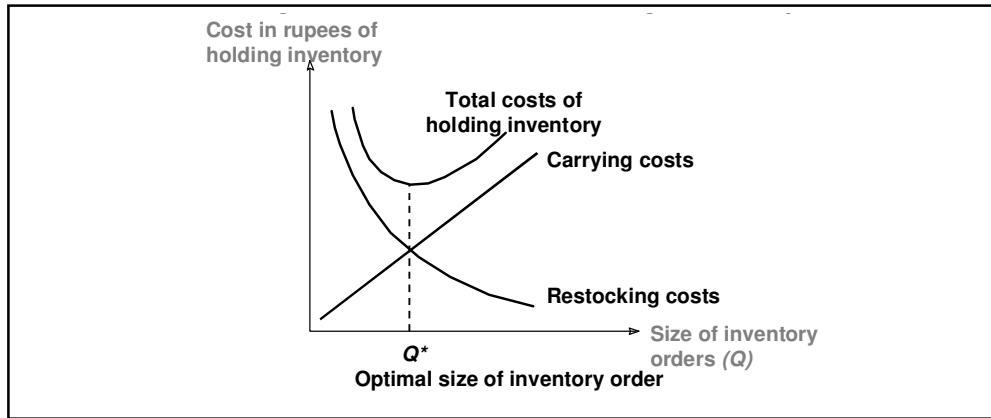

This means that carrying costs increase with the quantity of inventory on hand and as the inventory go down the carrying costs also go down. But with the declining amount of inventory held restocking costs go up as there are more number of orders and more number of receipts of orders. As total costs are the sum of the carrying and restocking costs we need to find a level where it is minimum. This is depicted graphically in the figure above.

Total Restocking Costs = Fixed Costs per order × Number of restocking times
 Mathematically speaking carrying costs are given by:

$$TRC = FC \times \frac{S}{Q}$$

Total Carrying Costs = Interest Costs × Cost per unit × Average Inventory

$$TCC = I \times P \times \frac{Q}{2}$$

Here $Q/2$ is the average inventory, I the interest rate and P the price per unit.

Similarly Restocking Costs are given by

Here S = total quantity consumed in a year.

As we know that total costs are a sum of these two individual costs. We can say

Total Costs = Carrying Costs + Restocking Costs

$$TC = TCC + TRC$$

$$TC = I \times P \times \frac{Q}{2} + FC \times \frac{S}{Q}$$

But this doesn't give us the optimum size of the inventory order. For finding the minimum costs we need to find the 'economic order quantity' for the particular item of stock under review. The effect of the combination of the various items of stock into the total business inventory will be discussed later.

Inventory Management Techniques

Economic Order Quantity (EOQ)

The economic order quantity is defined as a point where the total costs of restocking and carrying costs are the lowest.

EOQ is usually calculated by a formula based on differential calculus. Though we will not derive the formula we need to understand its working.

$$EOQ = \sqrt{\frac{2 \times FC \times S}{I \times P}}$$

There are four assumptions that we make in the EOQ model:

1. Sales can be forecasted perfectly,
2. Sales are evenly distributed throughout the year, and
3. Orders are received as soon as they are placed.

This set of assumptions mean is pretty restrictive and we will relax these assumptions slowly. Before we relax these assumptions there are two important things to note about the EOQ:

1. Although a mathematically precise EOQ can be calculated, in practice there is likely to be a range of order quantities within which total costs remain at a low level. The choice of order quantity within this low-cost range may not significantly affect the overall financial plan.
2. The key factor in the calculations is usually the cost of capital (interest on stockholdings). In times of high interest rates this is likely to outweigh all the other variables. The inventory holding costs will go up very steeply, and one's conclusion will be that stockholdings should be kept to the lowest figure possible having regard to any practical difficulties in obtaining frequent replacement supplies.

Optimum Order Quantity (OOQ)

The last comment above is a reminder that suppliers do not like handling small orders. The purchase price per unit, therefore, may vary with the size of the purchase order, and this will require a modification to our EOQ calculation.

The supplier might, for example, impose a 'minimum order value' so that for quantities below this limit the cost per unit would, in effect, be higher than normal. This would either impose a lower cut-off limit on the size of order placed, or would introduce an upward curve at the lower end of the holding cost line on the EOQ chart, since insurance and interest charges per unit would be relatively high until the small order limit was reached. For larger orders, on the contrary, there might be quantity discounts, and these would cause one or more downward steps at those points on the holding cost line where they began to operate.

This possibility can result in minimum total cost which differs from the position of the EOQ as originally calculated. This point is sometimes distinguished as the 'optimum order quantity'.

Safety Margins in Stockholding

So far we have assumed that a company will be placing purchase orders at regular intervals of time for a fixed quantity (the economic or optimal order quantity) of any particular item. The possibility of doing this depends on demand remaining constant from period to period and on supplies being available as and when required.

Sales demand, however, could show fluctuations around the normal level, so that in a period of high demand the available stock could be used up before fresh supplies are due. Similarly, in some periods deliveries from suppliers could be delayed so that even the normal sales demand could not be satisfied.

Against both these contingencies, it is necessary to hold a safety margin of stock. If it were necessary to hold a safety margin sufficiently large to cover the simultaneous occurrence of a peak in demand and a delay in supplies, then the minimum stockholding would form the greater part of the total stockholding.

Very little can be done to correct for random delays in supply, but it may be possible to anticipate changes in the trend of demand and to modify the purchasing procedure to meet them in one of the following ways:

- to order in economic order quantities but at varying time intervals according to the rate of demand currently being experienced, or anticipated in the near future - this is known as the fixed order quantity or re-order level system (for reasons which will be explained below);
- to order at regular intervals but in varying quantities determined by the current rate of demand - this is the fixed interval, or periodic review system.

Modified Ordering Systems

The re-order level system involves deciding a level of stockholding at which new purchase orders shall be placed. This will be decided in relation to the normal rate of issues during the normal purchasing lead time. The quantity to be ordered is constant, and an order for that quantity will be placed whenever stock falls to the pre-determined order level. The system thus responds quickly to variations in demand though there is a danger that in doing so it may reflect purely short term or random fluctuations in sales.

The operation of re-order level system include the use of:

- A maximum stock level. This would correspond to the normal peak holding under stable conditions. If the stockholding exceeds the peak level this provides a warning that demand has been running below the rate expected when the EOQ was fixed. The stock controller should then review the correctness of his standard purchase order quantity
- a minimum stock level which, as suggested above, is probably the amount of the safety margin.

The minimum stock level provides a warning of a potential out-of-stock position. When a stockholding falls to that level the stock controller will review his outstanding purchase orders and their due dates, and also the current trend of demand, and can then decide whether additional emergency procurement is necessary.

Under the periodic review system purchase orders are placed at fixed intervals of time but the quantity ordered can be modified to meet the rate of demand indicated by current experience. This gives an opportunity for analysing the trend of demand, and various techniques such as 'exponential smoothing' can be used in forecasting this trend. The system does not respond rapidly to immediate needs, and it may therefore necessitate a larger safety margin than the re-order level system.

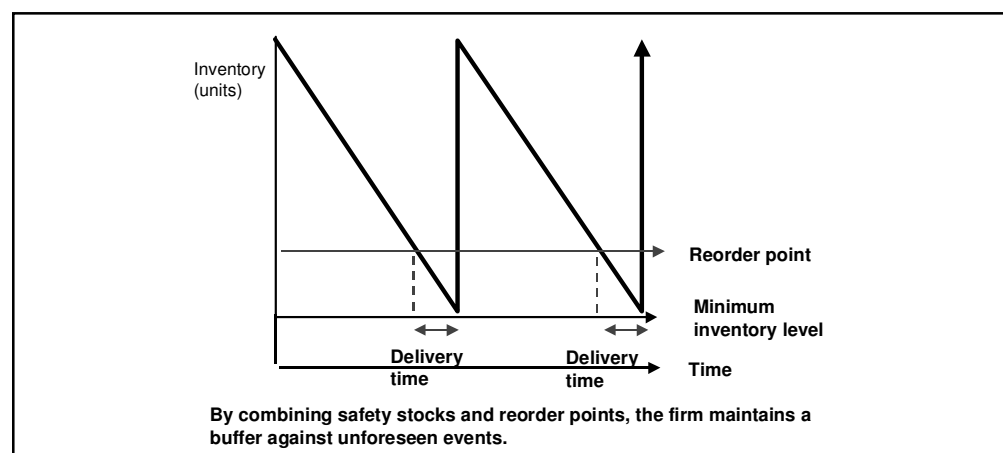

It is, in fact, a common experience that the re-order level system gives slightly lower average stock levels, and it is sometimes thought to be the cheaper system to operate because reordering is triggered automatically at the re-order levels, however, requires reviewing in the light of changes in the rate of demand. Any system can appear cheap in the short run if it is operated in a slovenly manner.

Infrequent and Seasonal Demand

In most inventories it will be necessary to carry items which are slow moving in the sense that units of demand are separated by significant intervals of time. These items may have high individual value but because they are demanded infrequently they will probably contribute only a small percentage of the total annual value of sales. The normal distribution of stockholdings would show that about 20% of the line items carried would contribute 80% of the total annual usage, though this relationship will vary between different types of business.

It may be decided not to hold stocks of some slow-moving items, but to procure them as and when they are required. If a stock is needed however the amount held will probably be limited to the quantity most likely to be next demanded, the occurrence of the demand being the signal for further procurement action. The quantity held may, however, be increased if the purchase price per unit is sufficiently lower for large quantities so as to offset any increase in holding costs for a larger stock holding. This could occur for example when the supplier imposed a minimum order value.

There should be a regular review of slow-moving items to identify stocks which have become technically obsolete or for which the demand has diminished to the point where stock holding is no longer justified.

In some businesses (for example, ladies fashion wear), it is necessary to place orders for the full seasonal requirement well in advance of the demand occurring, with a high probability that repeat orders will not be obtainable. In such instances the purchase and sale of each batch will be a separate project or venture dependent heavily on accurate forecasting of demand quantities and selling prices. In this case, the evaluation procedure applicable to stock holding for continuous demand will not apply.

Of a similar nature will be decisions like the following:

- to purchase goods in bulk in advance of demand arising in order to protect the business against anticipated price rises or shortages of supply;
- to purchase commodities forward at a fixed price for future delivery;
- to combine forward purchase options with forward sales options, so as to limit losses arising from price changes (including changes in currency exchange rates);

- to purchase foreign currency forward against specific overseas purchases, so as to minimise the effect of changes in exchange rates.

These are financial decisions quite separate from the routine problems of inventory control, and would be evaluated as investment projects.

The Total Inventory

The techniques described in the foregoing paragraphs all relate to single line items of stock; the assumption has been made that if each item is held at its own economic level then the overall holding of stock will be correctly balanced. This would be true provided that two conditions were satisfied.

- that there was enough space available to hold all the stocks required; and
- that enough money could be found to finance them.

Neither condition is likely to be fulfilled in practice, so some form of mathematical programme might be used to constrain the ideal unit quantities within the limiting factors. There are, however, a number of simple pragmatic approaches to inventory reduction, and these include:

- modifying the service level offered, either generally or in relation to selected items;
- letting the company's suppliers act as stockholders (possibly by placing bulk orders with schedules of call-off dates linked to sales demand);
- discontinuing those items which are the least profitable having regard to their marginal contribution and relevant fixed costs per unit of the limiting factor.

Raw Material Stocks and Work-In-Progress

So far, in considering inventory control we have been discussing saleable stocks, but the same principles apply to stocks of raw materials. The main difference is that demand for raw materials is not direct from the outside customers but indirect through the production plans of the factory using the raw materials.

In considering the scheduling of production the 'Economic Batch Quantity' (EBQ) corresponds to the EOQ for purchased items. Manufacture in small batches will be more costly than in larger batches because there will be greater repetition of planning and progress actions and of the setting up and breaking-down of machine tooling, and also because there will be less opportunity for an efficient momentum of work to be established. However, these batch processing costs (like procurement costs of stocks) will change inversely to the holding costs of the work-in-progress (floor space, insurance, interest on capital, etc.).

A big problem with work-in-progress is that work passes in sequence through a series of operations. What is an economic batch for lathe work may not be economic for drilling, milling or assembly operations. Applying EBQ calculation to one operation in isolation can cause bottlenecks in the flow or production - creating excessive holdings of partly-completed work because it could be produced cheaply in a large batch, even though there will be no demand for that work for some time ahead.

A similar problem is that of keeping skilled work people steadily occupied, since their wages are basically fixed in relation to time, even though outside customer demand may be seasonal or erratic.

Because these problems are concerned with the uneven timing of cash flows they are best solved by the use of discounted cash flow techniques. If, however, there is a capability of a rate of production which is in excess of a steady rate of demand (internal or external) then the problem is to decide what is the economic length of a production run, the facilities then being switched to other work until the next run is required.

As the number of items could be very large in case of raw materials it is necessary to find ways to selectively pay attention to those items that represent the highest value. A categorisation method known as ABC analysis is used for the same purpose. The idea behind ABC analysis is that attention is focussed on the highest value items that are usually small in number categorised as A-category items and the lowest value items are categorised as C and are ordered in more quantities so that less attention is required there.

For example in the figure 3.6 below, the A category items represent only 10 % of total inventory items but represent 57 % of the total value. While C category items represent 50 % of the total items but only 16 % of the value. By concentrating more on the A category items the company is able to manage its raw material inventory better.

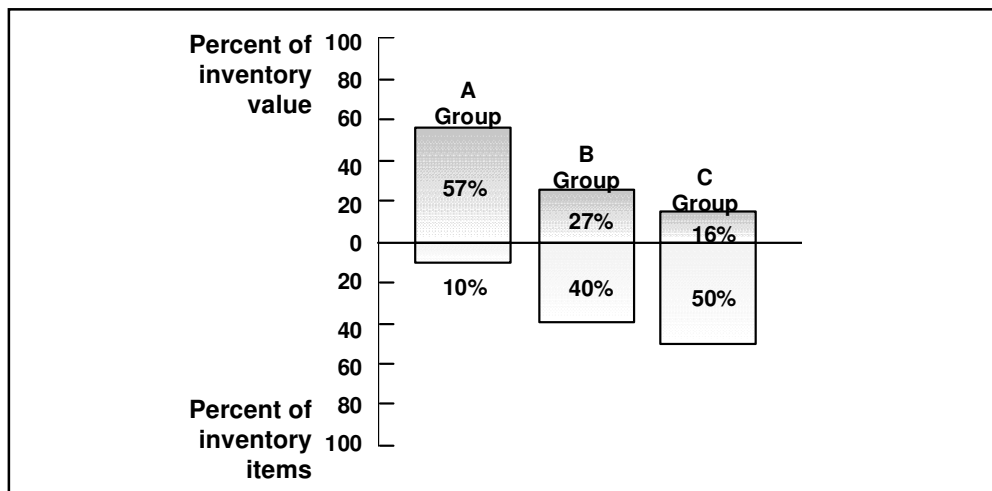

Integrated Working Capital Planning

Short-term financial planning is concerned with the management of the company's short-term, or current assets and liabilities. The most important current assets are cash, marketable securities, inventories and accounts receivable. The most important current liabilities are bank loans and accounts payable.

Current assets and liabilities are turned over much more rapidly than the other items on the balance sheet. Short-term financing and investment decisions are more quickly and easily reversed than long term decisions. Consequently, the financial manager does not need to look too far into the future when making them.

The nature of company's short term financial planning problem is determined by the amount of long term capital it raises. A company that issues large amounts of long term debt or equity, or which retains a large part of its earnings, may find that it has permanent excess cash. In such cases there is never any problem paying bills, and short term financial planning consists of managing the company's portfolio of marketable securities. Companies with permanent excess cash should look at the cost of funds and pay them out to the shareholders if they are earning less than the cost of funds.

Other companies raise relatively little long term capital and end up as permanent short term debtors. Most companies attempt to find a golden mean by financing all fixed assets and part of current assets with equity and long term debt. This may even be required by the bank to be so. Such companies may invest cash surpluses during part of the year and borrow during the rest of the year.

The starting point for short term financial planning is an understanding of sources and uses of cash. Companies forecast their net cash requirements by forecasting collections on accounts receivable, adding other cash inflows, and subtracting all forecasted cash outlays.

If the forecasted cash balance is insufficient to cover day-to-day operations and to provide a buffer against contingencies, you will need to find additional finance. It may make sense to raise long term finance if the deficiency is permanent and large. Otherwise you may choose from a variety of sources of short term finance.

In addition to the explicit costs of short term financing, there are often implicit costs. The financial manager must choose the financing package that has lowest total cost (explicit and implicit costs combined) and yet leaves the company with sufficient flexibility to cover contingencies.

Short Term Financial Planning Model

Working out a consistent short term plan requires burdensome calculations. Fortunately much of the arithmetic can be delegated to a computer. Many large companies have

built models to do this. Smaller companies do not face so much detail and complexity and find it easier to work with a spreadsheet programme on a personal computer.

In either case the financial manager specifies forecasted cash requirements or surpluses, interest rates, credit limits, etc. and the model grinds out a plan. The computer also produces balance sheets, income statements, and whatever special reports the financial manager may require.

Smaller companies that do not want custom built models can buy general purpose models offered by accounting companies, management consultants or specialised computer software companies.

Most of these models are simulation programmes. They simply work out the consequences of the assumptions and policies specified by the financial manager. Optimisation models for short term financial planning are also available. These models are usually linear programming models. They search for the best plan from a range of alternative policies identified by the financial manager.

Optimisation helps when the company faces complex problems with many interdependent alternatives and restrictions for which trial and error might never identify the best combination of alternatives.

Of course the best plan for one set of assumptions may prove disastrous if the assumptions are wrong. Thus, the financial manager has to explore the implications of alternative assumptions about future cash flows, interest rates and so on. Linear programming can help identify good strategies, but even with an optimisation model the financial plan is still sought by trial and error.

Solved Problems

1. The Classic Company offers trade credit to its customers of net 30. Credit sales average Rs 620,000 per day on which the company earns a contribution margin of 20 percent. The average accounts receivable collection period is 50 days. The appropriate after-tax discount rate for evaluating accounts receivable policy changes is 9 percent and the company's marginal tax rate is 40 percent.
 - a. What is the average balance in accounts receivable? What is the average investment in accounts receivable? What are the annual financing costs associated with the investment in receivables?
 - b. The sales manager believes she can implement a credit policy change that will reduce the average collection period by four days without affecting the level of sales. If this policy works as expected, what will be the company's investment in accounts receivable? What will be the net annual after-tax advantage to the company of adopting this policy?

- c. Suppose the credit policy change will also reduce sales by Rs 5,000 per day. What would be the company's investment in accounts receivable? What will be the expected effect of this policy change on the company's after-tax net income?

Solution

- a. The average balance of accounts receivable is:

$$\text{Average A/R balance} = (\text{Rs } 620,000/\text{day}) (50 \text{ days}) = \text{Rs } 31,000,000$$

$$\text{Average investment in A/R} = (\text{Rs } 31,000,000) (0.80) = \text{Rs } 24,800,000$$

The cost of financing the investment in receivables is:

$$\text{Cost of financing A/R} = (\text{Rs } 24,800,000) (.09) = \underline{\underline{\text{Rs } 2,232,000}}$$

Note: The financing cost of carrying receivables is based on the cost of sales since the cost of sales represents the cash paid out in advance of collections. The cash paid out creates a financing need.

- b. Reducing the collection period by 4 days will free up:

$$\text{Cash freed up} = (4\text{days}) (\text{Rs } 620,000 \text{ per day}) (0.80) = \text{Rs } 1,984,000$$

The net advantage is reduced financing cost of the cash freed up:

$$\text{Reduced financing cost} = (\text{Rs } 1,984,000) (0.09) = \text{Rs } 178,560 \text{ per year}$$

- c. If sales decrease and the average collection period is reduced,

$$\text{New investment in A/R} = (\text{Rs } 615,000)(0.80)(46) \quad \text{Rs } 22,632,000$$

$$\text{New financing cost of A/R} = (\text{Rs } 22,632,000)(0.09) = \text{Rs } 2,036,880$$

There are two effects on sales:

$$\Delta \text{ Financing cost of A/R} = (\text{Rs } 2,232,000 - \text{Rs } 2,036,880) \quad \text{Rs } 195,120$$

$$\Delta \text{ Net Profit from lower sales} = (-\text{Rs } 5,000/\text{day})(365)(0.20)(0.60) \quad 219,000$$

$$\Delta \text{ NIAT} \quad \text{-Rs } 23,880$$

Note: Here D means additional

Given the expected effects, the policy change would not be profitable.

2. Rupesh Goel, credit manager of Kalpana Company, is considering a change in the company's credit terms from net 60 to net 30. Kalpana has daily credit sales of Rs 50,000 and its variable cost ratio is 15 percent. Tightening credit standards would reduce the average collection period from 75 days to 40 days, reduce daily sales by Rs 2,000, and lower bad debts from 5 percent of sales to 3 percent of sales. The company's marginal tax rate is 40 percent and it uses an after-tax

discount rate of 12 percent to evaluate accounts receivable policy changes. How would the change in credit terms affect Kalpana's after-tax income?

Solution

To answer, first calculate the new and old investment in A/R

$$\text{Old investment in A/R} = (75 \text{ days})(\text{Rs } 50,000/\text{day})(0.85) = \text{Rs } 3,187,500$$

$$\text{New investment in A/R} = (40 \text{ days})(\text{Rs } 48,000/\text{day})(0.85) \quad \underline{1,632,000}$$

$$\Delta \text{ Investment in A/R} \quad \underline{\underline{\text{Rs } 1,555,500}}$$

There are three expected changes in after-tax net income:

$$\Delta \text{ Financing cost of A/R investment} = (\text{Rs } 1,555,500)(0.20) \text{ Rs } 186,660$$

Δ Bad debt expense

$$[(0.05)(\text{Rs } 50,000)(365) - (0.03)(\text{Rs } 48,000)(365)](0.60) \quad 232,140$$

$$\Delta \text{ Profit on sales} = (\text{Rs } 2000)(365)(0.15)(0.60) \quad (65,700)$$

$$\Delta \text{ Net Profit} \quad \text{Rs } 353,100$$

3. The Dryden Company currently offers trade credit to its customers on terms of net 30. Daily credit sales average Rs 250,000 on which the company earns a contribution margin of 25 percent. The average collection period of 45 days. The company's marginal tax rate is 30 percent and its after-tax discount rate for analyzing credit policy changes is 8 percent.
- Under the current policies, what is the company's investment in accounts receivable? What is the annual after-tax financing cost associated with the investment in account receivable?
 - The company is considering offering credit terms of 2/10, net 30. If the discount is offered, an estimated 85 percent of the company's customers will choose to take the discount and the average collection period will fall to 18 days. Assuming the change in credit policy has no effect on daily sales, what will be the effects on the company's after-tax net income?
 - Suppose the change in credit terms also reduces daily sales by Rs 4,000, lowers bad debt expenses from 5 percent to 2 percent of sales, and saves Rs 60,000 per year in credit department expenses. Will it be profitable to change the credit terms?

Solution

- a. Under current policies:

$$\text{Investment in A/R} = (\text{Rs } 250,000)(0.75)(45 \text{ days}) = \text{Rs } 8,437,500$$

$$\text{Cost of financing A/R} = (\text{Rs } 8,437,500)(0.08) = \text{Rs } 675,000$$

b. The new investment in accounts receivable will be

Δ Investment in A/R = (Rs 250,000)(0.75)(45-18) =	Rs 5,062,500
The changes in after-tax income are:	
Δ Cost of financing A/R=(Rs 5,062,500)(0.08)	Rs 405,000
Discounts accepted (0.02)(Rs 250,000)(0.85)(365)(0.60)	(930,750)
Δ NIAT	<u>(Rs 525,750)</u>

The proposed policy changes would be unprofitable.

c. The change in the investment in A/R is:

New investment in A/R=(18)(Rs 246,000)(0.75)	Rs 3,321,000
Δ Investment in A/R = (Rs 3,321,000 - 8,437,500) -	Rs 5,116,500
The changes in after-tax income are:	
Δ Cost of financing A/R = (-5,116,500)(0.08)	Rs 409,320
Lower profit on sales = (Rs 4000)(365)(0.25)(0.60)	(219,000)
Discounts accepted = (0.02)(246,000)(365)(0.60)	(1,077,480)
Δ Bad debt expense	
=[(0.05)(250,000)(365)-(0.02)(246,000)(365)](0.60)	1,660,020
Δ Credit department expenses = (0.60)(Rs 60,000)	36,000
Δ Net Profit	<u>Rs 808,860</u>

The change in credit policies would be profitable.

4. The Superb Company is evaluating its credit standards. The company's variable cost ratio is 78 percent of sales and its marginal tax rate is 40 percent. The appropriate after-tax discount rate for evaluating credit policies is 9 percent. Superb classifies customers into several credit classes depending on the risk of default. Based on the information given in the table, would Superb be better off not granting credit to the two customers in risk classes 4 and 5? (Evaluate the profitability of granting credit to each risk class separately.)

Risk Class	Average Collection period	Annual sales	Bad debts as percentage of sales	Additional annual credit department expenses
4	50 days	730,000	7%	Rs 35,000
5	65 days	580,000	12	62,000

Solution

For each risk class, the net advantage of granting credit is:

Risk class 4:

Profit on sales = (Rs 730,000)(0.22)(0.60)	Rs 96,360
Bad debt expense = (Rs 730,000)(0.07)(0.60)	(30,660)
Cost of financing A/R=(Rs 730,000/365)(50 days)(0.09)	(9,000)
Extra credit department costs (Rs 35,000)(0.60)	(21,000)
Δ NIAT	Rs 35,700

Risk class 5 :

Δ Profit on sales = (Rs 580,000)(0.22)(0.60)	<u>Rs 76,560</u>
Δ Bad debt expense = (Rs 580,000)(0.12)(0.60)	(41,760)
Cost of financing A/R=(Rs 580,000/365)(65 days)(0.09)	(9,296)
Extra credit department costs (Rs 62,000)(0.60)	(37,200)
Δ Net Profit	-Rs 11,696

Extending credit to risk class 5 appears unprofitable.

5. The Sunit Company currently carries Rs 12 million of inventory. The finance manager proposes a reduction in inventory to Rs 10 million. The sales and production managers estimate that the policy change will increase stockouts, costing the company sales of Rs 600,000 per year. Storage and spoilage costs should decrease by Rs 25,000 per year and the company's investment in accounts receivable will decrease by Rs 120,000. The variable cost ratio is 75 percent of sales. The company's marginal corporate tax rate is 30 percent and the appropriate after-tax discount rate for evaluating inventory policy changes is 8 percent.
- What are the financing costs to the company of its current inventory policies?
 - If the new policy is adopted, what will be the annual change in after-tax income?

Solution

- Financing cost of inventory = (12 million)(0.08)=Rs 960,000 per year.
- The policy changes will have the following effects on annual income.

Δ Financing of inventory = (Rs 2,000,000)(0.08)	Rs 160,000
Δ Stockout and spoiling cost = (Rs 25,000)(0.60)	15,000
Δ Financing of A/R = (Rs 120,000)(0.08)	9,600
Δ Profit on sales = (Rs 600,000)(0.25)(0.60)	(90,000)
Δ Net Profit	<u><u>Rs 94,600</u></u>

6. The Storage Corporation currently carries Rs 25 million of inventory. The finance manager is considering whether to recommend a reduction in inventory costs at the following information about inventory costs at various levels. The company's after-tax discount rate that is used to evaluate current asset policies is 6 percent. The company earns a contribution margin of 20 percent on sales.

	Rs 25 million	Rs 23 million	Rs 21 million
Storage costs	750,000	725,000	710,000
Spoilage costs	400,000	375,000	367,000
Daily sales	120,000	119,000	114,500

- a. Would it be profitable for the company to reduce its inventory from Rs 25 million to Rs 23 million? (Calculate the change in after-tax income.)
- b. Would it be profitable for the company to reduce its inventory to Rs 21 million? (Calculate the change in after-tax income.)

Solution

- a. Reducing inventory from Rs 25 to Rs 23 million causes net income to:

Δ Storage cost = (Rs 750,000 - Rs 725,000)(0.60)	Rs 15,000
Δ Spoilage cost = (Rs 400,000 - Rs 375,000)(0.60)	15,000
Δ Financing cost = (Rs 2,000,000)(0.06)	120,000
Δ Profit on sales = (Rs 120,000 - 119,000)(365)(0.20)(0.60)	(43,800)
Δ Net Profit	<u><u>Rs 106,200</u></u>

- b. To determine if it is profitable to reduce inventory to Rs 21 million, determine the change in profits associated with reducing from Rs 23 million. That is, you know that Rs 23 million is better than Rs 25 million and the decision is now whether to reduce further to Rs 21 million. Remember that decisions depend on incremental costs and benefits.

Reducing inventory from Rs 23 to Rs 21 million causes net income to:

Δ Storage cost = (Rs 725,000 - Rs 710,000)(0.60)	Rs 9,000
Δ Spoilage cost = (Rs 375,000 - Rs 367,000)(0.60)	4,800
Δ Financing cost = (Rs 2,000,000)(0.06)	120,000
Δ Profit on sales = (Rs 119,000 - 114,500)(365)(0.20)(0.60)	(197,100)
Δ Net Profit	<u><u>(Rs 63,300)</u></u>

Given the choices, Rs 23 million is the most profitable level of inventory.

7. The Phil Company expects to sell 30,000 lamps per month or 360,000 lamps per year. The carrying cost is Rs 1.20 per lamp and the fixed reorder cost is Rs 375.

- a. What is the annual before-tax cost of the current inventory policy?
- b. What is the optimal reorder quantity according to the EOQ model?
- c. If the company changes its reorder policy to conform with the EOQ model, what will be the net savings? (Round the number of reorders to the nearest integer.)

Solution

- a. The annual before-tax cost of the current policy are :

$$\begin{aligned}
 \text{Annual cost} &= \text{Ordering cost} + \text{Carrying cost} \\
 &= (12)(\text{Rs } 375) + (30,000)(1.20)/2 \\
 &= \text{Rs } 4,500 + \text{Rs } 18,000 = \text{Rs } 22,500
 \end{aligned}$$

- b. The optimal reorder quantity according to the EOQ model is:

$$Q^* = \sqrt{\left(\frac{2(375)(360,000)}{1.20}\right)} = 15,000$$

- c. To conform with the EOQ model, the company will place 24 orders per year [= (360,000)/15,000]. The average level of inventory will be 7,500 [= 15,000/2]. Thus the annual inventory costs will be:

$$\begin{aligned}
 \text{Annual cost} &= \text{Ordering cost} + \text{Carrying cost} \\
 &= (24)(\text{Rs } 375) + (7,500)(1.20) \\
 &= \text{Rs } 9,000 + \text{Rs } 9,000 = \text{Rs } 18,000
 \end{aligned}$$

The annual before-tax saving of following the EOQ model is Rs 4,500 [=Rs 22,500 - 18,000].

Chapter-11

Capital Structure Theories

There are basically three approaches to capital structure decision:

- Net income Approach
- Net Operating Income approach
- Modigliani Miller Approach

Net Income Approach

According to this approach, the cost of debt capital, K_d and the cost of equity capital K_e remains unchanged when D/S , the degree of leverage, varies. Here S stands for total capital employed = $D+E$). The constancy of K_d and K_e with respect to the degree of leverage means that K_o , the average cost of capital, measured by the following formula declines as the degree of leverage increases.

$$K_o = k_d * \frac{D}{(D + E)} + k_e * \frac{E}{(D + E)}$$

This happens because when the degree of leverage increases, K_d which is lower than K_e , receives a higher weight in the calculation of K_o .

This can also be illustrated by a graph shown in Figure 11.1.

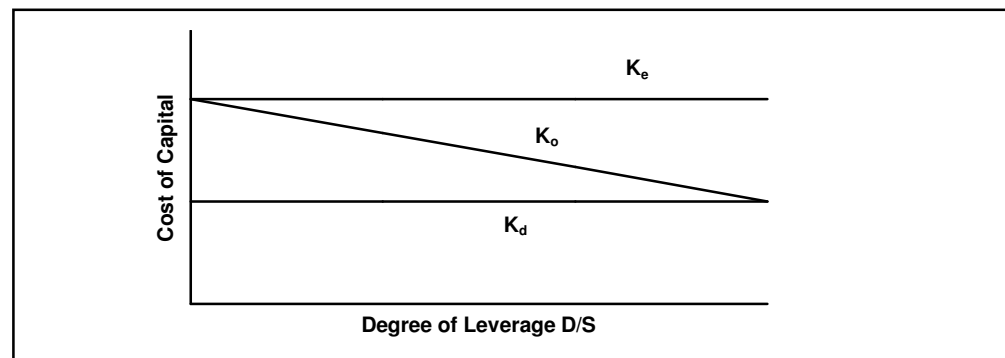

As our assumption is that the cost of debt and equity capital would not change with the change in the level of leverage, K_o is seen to go down with the increasing proportion of debt in the capital.

Note that we are talking about the market value of debt and the market value of equity. Many times we confuse it with the book values of debt and equity, a measure that always leads to problems in measuring the true costs of debt and equity.

Let us take a company that has an investment of Rs 1,00,000 and an net operating income of Rs 10,000. It is considering two scenarios: 1) no debt and 2) equal levels of debt and equity of Rs 50,000 each. Let us say that the company finds out that the cost of equity is 10% and the cost of debt is 6%.

Calculations show that equity earnings would be Rs 10,000 and Rs 7,000 respectively in the two scenarios as shown below. As the return expected on equity is 10%, we can say that this profit is 10% and therefore the market value of equity would be such that this return becomes 10% on the same. This means that the market value of equity would be Rs 1,00,000 and Rs 70,000 respectively in the two scenarios. Adding the market value of debt and the market value of equity gives us the total value of the firm in the market.

	Scenario A	Scenario B
Equity	1,00,000	50,000
Debt	0	50,000
Cost of equity	10%	10%
Cost of debt	6%	6%
Net operating income	10,000	10,000
Interest on debt	0	3,000
Equity earnings	10,000	7,000
Market value of equity	1,00,000	70,000
Market value of debt	0	50,000
Total value of firm	1,00,000	1,20,000

Average cost of capital:

Scenario A: $6\% * (0 / 100000) + 10\% * (100000 / 100000) = 10\%$

Scenario B: $6\% * (50000 / 120000) + 10\% * (70000 / 100000) = 8.33\%$

There are three points to be noted here.

1. As the cost of capital decreases the value of the firm would go up as it is dependent upon the return expected and the cost of capital. Inverse relationship exists between the value of the firm and cost of capital for any given level of return.

Let us repeat the example we discussed earlier in net income approach. Let us take a company that has an investment of Rs 1,00,000 and an net operating income of Rs 10,000. It is considering two scenarios: 1) no debt and 2) equal levels of debt and equity of Rs 50,000 each. Let us say that the company finds out that the overall cost of capital is 8% and the cost of debt is 6%.

Calculations show that equity earnings would be Rs 10,000 and Rs 7,000 respectively in the two scenarios as shown below. As the return expected on total capital is 8 per cent, therefore the market value of total capital would be such that this return becomes 8 per cent on the same. This means that the market value of capital would be Rs 1,25,000 in both the scenarios as our assumption in this case is that the total market value remains constant. Also the value of debt would also remain constant as the cost of debt remains constant. This means that the equity capitalisation can be calculated by subtracting the market value of debt from the total market value of the firm. Then the return on equity divided by the market capitalisation of equity would give us the cost of equity.

	Scenario A	Scenario B
Equity	1,00,000	50,000
Debt	0	50,000
Cost of debt	6%	6%
Net Operating income	10,000	10,000
Overall capitalisation rate	8 %	8 %
<i>Total market value</i>	<i>1,25,000</i>	<i>1,25,000</i>
Interest on debt	0	3000
Debt capitalisation rate	0.06	0.06
The equity capitalisation rates of scenario A and B are as follows :		
Market value of debt	= 0	= 50,000
Scenario A : Equity earnings	= 10,000	= 7,000
Market value of equity	= 1,25,000	= 75,000
Scenario B : Equity earnings	= 7,000	= 7,000
Degree of leverage	= 0.0	= 0.0933 = 9.33%
	Market value of equity	<u>75,000</u>

There are three points to be noted here.

1. As the cost of total capital and debt is constant, the cost of equity would go up or down with increasing or decreasing leverage, i.e., the amount of debt in the equity.
2. This means that as we increase the level of debt in the company, the value of the firm doesn't change and the company does not benefit by taking on debt. This would mean that the companies would like to employ as much equity as possible so as to reduce the risk of the company. Something that doesn't happen in the real world again, companies do benefit from taking on debt.
3. Note that we have still not considered the effect of taxes.

With these two scenarios in mind let us look at what one of the most surprising theories of finance say about the capital structure.

Modigliani Miller Approach

In 1958, Franco Modigliani and Merton Miller (MM) published one of the most surprising theories of the modern financial management - they concluded that the value of a firm depends solely on its future earnings stream, and hence its value is unaffected by its debt / equity mix. In short, they concluded that a firm's value stems from its assets, regardless of how those assets are financed. In other words, a variant of the net operating income approach discussed above. This finding had such widespread implications that the article was judged by the members of the Financial Management Association to have had more impact on financial management than any other published work.

In their paper, MM began with a very restrictive set of assumptions, including perfect capital markets (which implies zero taxes). And then they used an arbitrage proof to demonstrate that capital structure is irrelevant. Under their assumptions, if debt financing resulted in a higher value for the firm than equity financing, then investors who owned shares in a leveraged (debt-financed) firm could increase their income by selling those shares and using the proceeds, plus borrowed funds, to buy shares in an unleveraged (all equity-financed) firm. The simultaneous selling of shares in the leveraged firm and buying of shares in the unleveraged firm would drive the prices of the stocks to the point where the values of the two firms would be identical. Thus, according to MM Hypothesis, a firm's stock price is not related to its mix of debt and equity financing.

Modigliani and Miller have restated and amplified the net operating income position in terms of three basic propositions. These are as follows:

Proposition I

The total market value of a firm is equal to its expected operating income (EBIT when $\text{Tax} = 0$) divided by the discount rate appropriate to its risk class. It is independent of the degree of leverage.

$$V_L = V_U = \frac{EBIT}{k_{o,L}} = \frac{EBIT}{k_{e,L}}$$

Here the subscript L is used to denote Leveraged firm and subscript U is used to denote Unleveraged firm.

Since the V (Value of the firm) as established by the above equation is a constant, then under the MM model, when there are no taxes, the value of the firm is independent of its leverage. This implies that the weighted average cost of capital to any firm is completely independent of its capital structure and the WACC for any firm, regardless of the amount of debt it uses, is equal to the cost of equity of unleveraged firm employing no debt.

Proposition II

The expected yield on equity, K_e is equal to K_o plus a premium. This premium is equal to the debt-equity ratio times the difference between K_o and the yield on debt, K_d .

This means that as the firm's use of debt increases, its cost of equity also rises, and in a mathematically precise manner.

Proposition III

The cut-off rate for investment decision making for a firm in a given risk class is not affected by the manner in which the investment is financed. It emphasises the point that investment and financing decisions are independent because the average cost of capital is not affected by the financing decision.

Example

Let us take the case of two firms X and Y, similar in all respects except in their capital structure. Firm X is financed by equity only; firm Y is financed by a mixture of equity and debt. The financial parameters of the two firms are as follows :

Financial particulars of Firms X and Y

	<u>Firm X</u>	<u>Firm Y</u>
Total Capital Employed(Rs.)	1,000,000	1,000,000
Equity Capital(Rs.)	1,000,000	600,000
Debt (Rs.)	nil	400,000
Net operating Income (Rs.)	100,000	100,000
Debt Interest (Rs.)	0	20,000
Market Value of Debt (Rs.)	0	400,000
(Debt Capitalisation is 5%)		

	Firm X	Firm Y
Debt Interest (Rs.)	0	20,000
Market Value of debt (Rs.) (Debt capitalisation rate is 5%)	0	400,000
Equity earnings (Rs.)	100,000	80,000
Equity capitalisation rate	8%	12%
Market value of equity (Rs.)	1,250,000	666,667
Total Market value (Rs.)	1,200,000	1,066,667

From the above particulars, it can be seen that the value of leveraged firm Y is higher than that of the unleveraged firm. According to Modigliani Miller approach, such a situation cannot persist because equity investors would do well to sell their equity investment in firm Y and invest in the equity of firm X with personal leverage. For example, an equity investor who owns 1 % equity in firm Y would do well to:

- Sell his equity in firm Y for Rs. 6,667
- Borrow Rs. 4,000 at 5% interest on personal account and
- Buy 1.0667% of the equity of firm X with the amount of Rs 10,667 that he has.

Such an action will result in the following income :

	(Rs.)
Income on investment in firm X	1066.7
Less Interest (4000 x 0.5)	200.0
Net Income	866.7

This net income of Rs. 866.7 is higher than a net income of Rs.800 foregone by selling 1 percent equity of firm Y and the leverage ratio is the same in both the cases.

When investors sell their equity in firm Y and buy the equity in firm X with personal leverage, the market value of equity of firm Y tends to decline and the market value of equity of firm X tends to rise. This process continues until the net market values of both the firms become equal because only then the possibility of earning a higher income for a given level of investment and leverage by arbitraging is eliminated. As a result of this the cost of capital for both the firms is the same.

The above example explained that due to the arbitrage mechanism the value of a leveraged firm cannot be higher than that of an unleveraged firm, other things being equal. It can also be proved that the value of an unleveraged firm cannot be higher than that of leveraged firm, other things being equal.

Let us assume the valuation of the two firms X and Y is the other way around and is as follows:

	Firm X	Firm Y
Debt Interest (Rs.)	0	20,000
Market Value of debt (Rs.) (Debt capitalisation rate is 5%)	0	400,000
Equity earnings (Rs.)	100,000	80,000
Equity capitalisation rate	8%	12%
Market value of equity (Rs.)	1,250,000	666,667
Total Market value (Rs.)	1,200,000	1,066,667

If a situation like this arises, equity investors in firm X would do well to sell the equity in firm X and use the proceeds partly for investment in the equity of firm Y and partly for investment in the debt of firm Y. For example, an equity investor who owns 1 percent equity in firm X would do well to :

- Sell his 1 % equity in firm X for Rs 12,500
- Buy 1.01 % of equity and debt in firm Y involving an outlay of Rs 12,500.

Such an action will result in an increase of income by Rs 172 without changing the risk shouldered by the investor. When investors resort to such a change, the market value of the equity of firm X tends to decline and the market value of the equity of firm Y tends to rise. This process continues until the total market value of both the firms becomes equal.

Criticism of MM Hypothesis

The arbitrage process is the behavioural foundation for the M-M thesis. The shortcomings of this thesis lie in the assumption of perfect capital market in which arbitrage is expected to work. Due to the existence of imperfections in the capital market, arbitrage may fail to work and may give rise to discrepancy between the market values of levered and unlevered firms. The arbitrage process may fail to bring equilibrium in the capital market for the following reasons:

Lending and borrowing rates discrepancy The assumption that firms and individuals can borrow and lend at the same rate of interest does not hold good in practice. Because of the substantial holding of fixed assets, firms have a higher credit standing. As a result, they are able to borrow at lower rates of interest than individuals. If the cost of borrowings to an investor is more than the firm's borrowing rate, then the equalisation process will fall short of completion. If the cost of debt paid by the firm is less than that paid by the investor, then the value of the levered firm, V_p , must exceed

the value of the unlevered firm, V_u , for total return to be equal. For example, if the investors can borrow at 9 per cent, his returns after switching will be only Rs 550. Consequently, it does not follow that market opportunities and forces will lead V_l into equality with V_u .

Non-substitutability of personal and corporate leverages It is incorrect to assume that “personal (home-made) leverage” is a perfect substitute for “corporate leverage.” The existence of limited liability of firms in contrast with unlimited liability of individuals clearly places individuals and firms on a different footing in the capital markets. If a levered firm goes bankrupt, all investors stand to lose to the extent of the amount of the purchase price of their shares. But, if an investor creates personal leverage, then in the event of the firm’s insolvency, he would lose not only his principal in the shares of the unlevered company, but will also be liable to return the amount of his personal loan. Thus, if the investor keeps his investment in the levered firm, his loss in the event of bankruptcy will be Rs 6,000. But if he engages in the arbitrage transactions and invests in the unlevered firm, he can lose his principal investment of Rs 5,000 and will also be liable to return Rs 5,000 borrowed by him on the personal account. Thus, it is more risky to create personal leverage and invest in the unlevered firm than investing directly in the levered firm.

Transaction costs The existence of transaction costs also interferes with the working of arbitrage. Because of the costs involved in the buying and selling securities, it would become necessary to invest a greater amount in order to earn the same return. As a result, the levered firm will have a higher market value.

Institutional restrictions Institutional restrictions also impede the working of arbitrage. Durand points out that “home-made” leverage is not practically feasible as a number of institutional investors would not be able to substitute personal leverage for corporate leverage, simply because they are not allowed to engage in the “home-made” leverage.

Existence of corporate tax “The incorporation of the corporate income taxes will also frustrate M-M’s conclusions. Interest charges are tax deductible. This, in fact, means that the cost of borrowing funds to the firm is less than the contractual rate of interest. The very existence of interest charges gives the firm a tax advantage, which allows it to return to its equity and debt holders a larger stream of income than it otherwise could have. For example, suppose $X = \text{Rs } 10,000$, $k_d = 0.06$ and $D_t = \text{Rs } 20,000$. Let the corporate income tax rate equal 50 per cent. Thus, the unlevered firm will have Rs 5000 [= Rs 10,000 (1 – 0.50)] for distribution to its equity share-holders. The levered firm must pay a total tax of Rs 4,400 [= 0.50 (10,000 - Rs 1,200)] which leaves it Rs 5,600 to distribute to its equity and debt-holders (i.e., Rs 4,400 to equity-holders and Rs 1,200 to debt-holders). Thus, the total returns to debt and equity-holders from the unlevered firm are less than that of levered firm. Hence, the total market

value of a levered firm should tend to exceed that of the unlevered firm for this very reason. This point is elaborated further in the following section.

Relevance of Capital Structure: The MM-Hypothesis under corporate Taxes

M-M's hypothesis that the value of the firm is independent of its debt policy is based on the critical assumption that corporate income taxes do not exist. In reality, corporate income taxes exist, and interest paid to debt holders is treated as a deductible expense. Dividends paid to shareholders; on the other hand, are not tax-deductible. Thus, unlike dividends, the return to debt-holders is not subject to the taxation at the corporate level. This makes debt financing advantageous. In their 1963 article, M-M show that the value of the firm will increase with debt due to the deductibility of interest charges for tax computation, and the value of the levered firm will be higher than of the unlevered firm. Consider an example.

Illustration 6: Suppose two firms L and U are identical in all respects except the use of debt—firm U is an all-equity financed firm with Rs 10,000 equity capital while firm L employs Rs 5,000 equity and Rs 5,000 debt at a 14 per cent rate of interest. Both firms have an expected earning before interest and taxes of Rs 2,500, pay corporate tax at 50 per cent and distribute 100 per cent earnings as dividends to shareholders. The; after-tax earnings accruing to investors is shown in Table given below.

Note in Table that the liability of firm L is Rs 350 less than that of firm U. The total income of investors of firm L is more by that amount. This amount is the interest tax shield provided by the debt of firm L: $0.5 \times 0.14 \times 5,000 = 0.5 \times 700 = \text{Rs } 350$. Thus

$$\text{Interest tax shield} = \text{Tax rate} \times \text{Interest}$$

$$\text{INTS} = T \times \text{INT} = T \times (k_d D) \quad \dots(11)$$

where k_d is the cost of debt and D is the amount of debt.

Table: Income of investors of levered and Unlevered firm's under corporate income tax

<i>Income</i>	<i>Firm U</i>	<i>Firm L</i>
1. EBIT, X	2,500	2,500
2. Interest, INT = $k_d D$	0	700
3. Profit before tax, $(X - k_d D)$	2,500	1,800
4. Tax, $T = 0.5, T(-k_d D)$	1,250	900
5. Profit after tax, $(X - k_d D) - T(-k_d D) = (X - k_d D)(I - T)$	1,250	900
6. Dividends to shareholders, $(X - k_d D)(I - T)$	1,250	900
7. Interest to debt holders, $k_d D$	0	700
8. Total income to investors, $(X - k_d D)(I - T) + k_d D$ = $(1-T)X + Tk_d D$	1,250	1,600
9. Interest tax shield. $Tk_d D$	0	350

X

Interest tax shield (INTS) is an inflow to the firm and therefore, it is valuable. Suppose that firm L will employ debt of Rs 5,000 forever. If firm L's debt of Rs 5,000 is permanent, then the interest tax shield of Rs 350 is a perpetuity. What is the value of this perpetuity? For this, we need a discount rate which reflects the riskiness of those cash flows. The levered firm's after-tax earnings consist of operating income and interest tax shield as given below:

$$\begin{aligned} \text{After-tax earnings of all investors} &= \text{After-tax operating income} + \text{Interest tax shield} \\ &= (1 - T) + T k_d D \end{aligned}$$

In case of the unlevered firm, the after-tax earnings are simply: $(1 - T)$

The cash flows arising on account of interest tax shield are less risky than the operating income which is subject to business risk. Interest tax shield depends on the corporate tax rate and the firm's ability to earn enough profit to cover the interest payments. The corporate tax rates do not change very frequently, Firm L can be assumed to earn at least equal to the interest payable otherwise it would not like to borrow, Thus the cash inflows from interest tax shield can be considered less risky, and they should be discounted at a lower discount rate. It will be reasonable to assume that the risk of interest tax shield is the same as that of the interest payments generating them. Thus, the discount rate is 14 per cent, the rate of return required by debt-holders. The present value of firm L's perpetual interest tax shield of Rs 350 is:

$$\text{PV of interest tax shield} = \frac{350}{0.14} = \text{Rs } 2,500$$

Note that the government, through its fiscal policy, assumes 50 per cent (the corporate tax rate) of 0.14 firm L's Rs 5,000 debt obligation.

Under the assumption of the permanent debt, we can determine the present value of the interest tax shield as follows:

$$\text{PV of interest tax shield} =$$

$$\text{PVINTS} = \frac{350}{0.14} \dots(12)$$

Thus the present value of the interest tax shields (PVINTS) is independent of the cost of debt it is simply the corporate tax rate times the amount of permanent debt (TD).

What is the total value of firm L (that is, the levered firm)? It is the sum of the present value of the after-tax operating income and interest tax shield. The operating income, $R(1 - T)$, of the levered firm is equal to the after-tax earnings of the pure-equity (that is, unlevered) firm U. The equity-capitalisation rate (the opportunity cost of equity) of a pure-equity firm, k_e , should be used to discount the stream of operating income. Thus

the value of firm L (the levered firm) is equal to the value of the unlevered firm plus the present value of the interest tax shield as shown in Equation below:

Value of levered firm = Value of unlevered firm + PV of tax shield

$$V_l = v_u + TD \dots(13)$$

We can write Equation (13) in its expanded form as follows:

$$V_l = \frac{\bar{X}(1-T)}{k_u} + \frac{Tk_d D}{k_d} \dots(14)$$

where V_l is the value of the firm with debt, $X(I - T)$ is perpetual operating income stream of the pure-equity firm, k_u is the pure-equity capitalisation rate, k_d is the expected rate of return on debt, D is debt and T is the corporate tax rate.

Equation (13) implies that when the corporate tax rate, T , is positive ($T > 0$), the value of the levered firm will increase continuously with debt. Thus, theoretically the value of the firm will be maximum when it employs 100 per cent debt. This is shown in Figure 8.

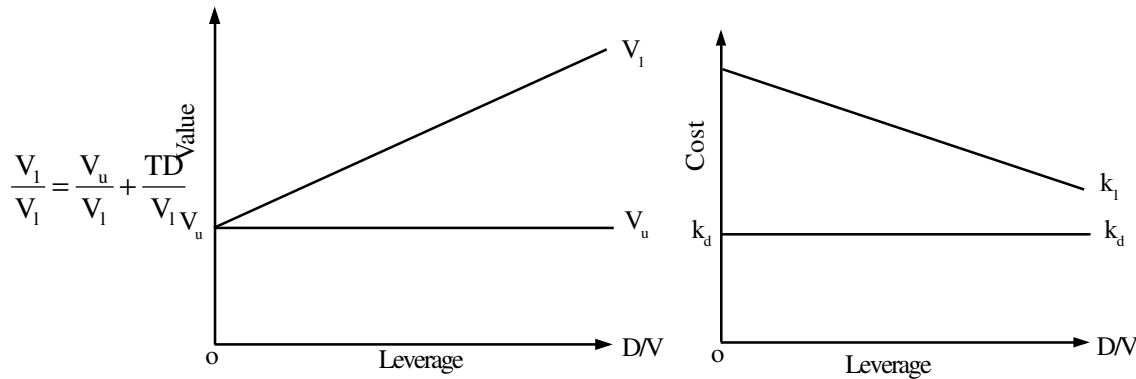

Figure 8: Value of levered firm Figure 9: Cost of capital of the levered firm

$$V_l = V_u + TD$$

$$1 = \frac{V_u}{V_l} + TL \quad (\text{setting } D/V_l = L)$$

$$V_l = \frac{V_u}{1 - TL} \quad \text{Thus, for } T > 0, V_l \text{ will be maximum when } L = 1.0.$$

Under the assumption of the M-M hypothesis with corporate taxes, the levered firm's cost of capital is given by the following formula:

$$k_l = k_u(1 - TL) \dots(15)$$

where k_l is the levered firm's cost of capital, k_u is the pure-equity capitalisation rate,

T is the corporate tax rate and L is debt ratio. The levered firm's cost of capital is shown in Figure.

The M-M's 'tax-corrected' view suggests that, because of the tax deductibility of interest charges, a firm can increase its value or lower its cost of capital continuously with leverage. Thus the optimum capital structure is reached when the firm employs 100 per cent debt. But the observed experience does not entirely support this view. In practice, firms do not employ large amounts of debt, nor are lenders ready to lend beyond certain limits. M-M suggest that firms would adopt a target debt ratio so as not to violate the limits of the debt level imposed by lenders. They state:

..... existence of a tax advantage for debt financing does not necessarily mean that corporations should at all times seek to use the maximum possible amount of debt in their capital structures... (T) here are, as we pointed out, limitations imposed by lenders, as well as many other dimensions in real-world problems of financial strategy which are not fully comprehended within the framework of static equilibrium models... These additional considerations, which are typically grouped under the rubric of the need for preserving flexibility, will normally imply the maintenance by the corporation of a substantial reserve of untapped borrowing power.

Why do companies not employ extreme level of debt in practice? There could be two possibilities: First, we need to consider the impact of both corporate and personal taxes for corporate borrowing. Personal income tax may offset the advantage of the interest tax shield. Second, borrowing may involve extra costs (in addition to contractual interest cost)—costs of financial distress—which may also offset the advantage of the interest shield. Let us examine these points in the following section.

Economy-wide Optimum Capital Structure: Miller's Hypothesis with Corporate and Personal Taxes

Investors are required to pay personal taxes on the income earned by them. Therefore, from investor's point of view, taxes will include both corporate and personal taxes. A firm should thus aim at minimising the total taxes (both corporate and personal) while deciding about borrowing. How do personal income taxes change investor's return and value? It depends on the corporate tax rate and the difference in the personal income tax rates of investors.

Consider an example. In Illustration 6 of firms L and U, let us add information about the personal taxes. Assume that both shareholders and lenders are required to pay 40 per cent tax on their income—respectively dividends and interest. The after-tax income accruing to investors is shown in Table

Income	Firm U	Firm L
1. EBIT,	2,500	2,500
2. Interest, INT = $k_d I$	0	700
3. Profit before tax, $I - k_d D$	2,500	1,800
4. Tax, $T(I - k_d D)$	1,250	900
5. Profit after tax $(I - k_d D) - T(I - k_d D) = (I - k_d D)(1 - T)$	1,250	900
6. Dividends to shareholders, $(I - k_d D)(1 - T)$	1,250	900
7. Personal taxes on dividends, $T_p [(I - k_d D)(1 - T)]$	500	360
8. Dividends after personal taxes, $(I - k_d D)(1 - T)(1 - T_p)$	750	540
9. Interest to debt-holders, $k_d D$	0	700
10. Personal taxes on interest, $T_p(k_d D)$	0	280
11. Interest after personal taxes, $(k_d D - T_p k_d D) = k_d D(1 - T_p)$	0	420
12. Total income to investors, $(8 + 11)(I - k_d D)(1 - T)(1 - T_p) + k_d D(1 - T_p)$	750	960
13. Interest tax shield after personal taxes, $k_d DT - k_d DT \times T_p = (1 - T_p)k_d DT$	-	210

Note that the after-tax income available to both shareholders and debt holders is less by 40 per cent on account of personal taxes. Further, you also notice that the interest tax shield after personal tax has reduced to: $Rs\ 350(1 - 0.4) = Rs\ 210$. What is the present value of this perpetual stream? We shall have to adjust the discount rate for the personal taxes. This is done because the cash flows arising from the interest tax shield are computed after personal taxes. The debt holders of firm L can obtain 14 per cent before tax, but only $0.14(1 - 0.4) = 0.08$ or 8.4 per cent after personal tax. Thus, the present value of interest tax shield is:

$$\frac{210}{0.084} = Rs\ 2,500$$

$$PVINTS = Rs\ 2,500$$

This present value is same as obtained earlier when the personal taxes were ignored. It is because both cash flows and discount rate have been reduced by the personal tax rate of 40 per cent. Thus

$$PVINTS = \frac{\text{Corporate tax rate} \times \text{Interest} \times (1 - \text{Personal tax rate})}{\text{Cost of debt} (1 - \text{Personal tax rate})}$$

$$= \frac{t \times k_d D \times (1 - T_p)}{k_d (1 - T_p)} = TD$$

...(16)

The value of the levered firm is still given by the following formula:

$$V_l = V_u + TD$$

In reality, however, dividends are treated differently from interest income for tax

purpose. In India, for example interest income is tax exempt upto Rs 7,000 for individuals. After this, they are required to pay tax at a marginal rate which can be as high as 30 per cent. Dividends in the hands of shareholders are tax exempt, and capital gains are treated more favourably for tax purposes. The tax rate on capital gains is 20 per cent. Tax on capital gains is paid only when they are realised. Thus, an individual can defer paying tax on capital gains for a long period if he does not realise them and thus, his tax on equity income will be zero. Interest income, whether received or accrued, is taxed in the hands of individuals, although it is exempted from tax at the corporate level. Dividends are taxed at the corporate level while it is possible to avoid tax on capital gains at the personal level and pay no tax on the current dividends. We may conclude that, in general, interest income is taxed at a higher rate than equity income at the personal level.

Consider an example. In our earlier illustration, let us assume that interest income is taxed at 40 per cent and equity income is not taxed at the personal level. The after-tax earnings of investors are shown in Table. It can be seen that corporate borrowing is still advantageous since an interest tax shield after personal taxes of Rs 70 is generated. Note that the interest tax shield is reduced by the personal tax on interest income (i.e. $k_d DT - k_d DT_{pb}$). But it is substantially less than the case where equity income was taxed at 40 per cent.

Income	Firm U	Firm L
1. EBIT, X	2,500	2,500
2. Interest, INT = k _d I	0	700
3. Profit before tax, $\bar{X} - k_d D$	2,500	1,800
4. Tax, T(X - k _d D)	1,250	900
5. Profit after tax ($\bar{X} - k_d D$) - T($\bar{X} - k_d D$) = ($\bar{X} - k_d D$) (1 - T)	1,250	900
6. Dividends to shareholders, ($\bar{X} - k_d D$) (I - T)	1,250	900
7. Personal taxes on dividends, T _p [($\bar{X} - k_d D$) (I - T)]	0	0
8. Dividends after personal taxes, ($\bar{X} - k_d D$) (I - T) (I - T _p)	1,250	900
9. Interest to debt-holders, k _d D	0	700
10. Personal taxes on interest, T _p (k _d D)	0	280
11. Interest after personal taxes, (k _d D - T _p k _d D) = k _d D (I - T _p)	0	420
12. Total income to investors, (8 + 11) (X - k _d D) (I - T) (I - T _p) + k _d D (I - T _p)	1,250	1,320
13. Interest tax shield after personal taxes, k _d DT - k _d DT × T _p (I = T _p) k _d DT	-	70

The present value of this perpetual stream of interest tax shield is:

PVINTS =

Thus the formula for PVINTS in the case of a positive personal tax rate for lenders and no personal tax rate for shareholders can be written as follows:

$$\begin{aligned}
 \text{PVINTS} &= \frac{\text{Corporate tax rate} - \text{Lender's Personal tax rate}) \times \text{Interest}}{\text{Cost of debt} (1 - \text{Lender's Personal tax rate})} \\
 &= \frac{(T - T_{pb})k_d D}{k_d(1 - T_{pb})} = \left[\frac{T - T_{pb}}{1 - T_{pb}} \right] D \quad \dots(17)
 \end{aligned}$$

The total earnings of a firm will be distributed either as interest income or equity income. The personal tax rate on interest income is T_{pb} and on equity income T_{pe} . T_{pe} is unlikely to be equal to T_{pb} , mostly it will be less than T_{pb} , and in extreme cases it will be equal to zero. Comparing the income tax shields in Tables we can see that corporate borrowings is advantageous if

$$(1 - T_{pb}) > (1 - T_{pe})(1 - T)$$

Thus a firm should stop borrowing when $(1 - T_{pb})$ becomes equal to $(1 - T_{pe})(1 - T)$. In practice, the finance manager will find it difficult to arrive at the numerical values of T_{pb} and T_{pe} since the firm will have a large number of shareholders and debt holders in different tax brackets.

70
0.084
83
85
86
87
88
89
90
91
92
93
94
95
96
97
98
99
100
101
102
103
104
105
106
107
108
109
110
111
112
113
114
115
116
117
118
119
120
121
122
123
124
125
126
127
128
129
130
131
132
133
134
135
136
137
138
139
140
141
142
143
144
145
146
147
148
149
150
151
152
153
154
155
156
157
158
159
160
161
162
163
164
165
166
167
168
169
170
171
172
173
174
175
176
177
178
179
180
181
182
183
184
185
186
187
188
189
190
191
192
193
194
195
196
197
198
199
200
201
202
203
204
205
206
207
208
209
210
211
212
213
214
215
216
217
218
219
220
221
222
223
224
225
226
227
228
229
230
231
232
233
234
235
236
237
238
239
240
241
242
243
244
245
246
247
248
249
250
251
252
253
254
255
256
257
258
259
260
261
262
263
264
265
266
267
268
269
270
271
272
273
274
275
276
277
278
279
280
281
282
283
284
285
286
287
288
289
290
291
292
293
294
295
296
297
298
299
300
301
302
303
304
305
306
307
308
309
310
311
312
313
314
315
316
317
318
319
320
321
322
323
324
325
326
327
328
329
330
331
332
333
334
335
336
337
338
339
340
341
342
343
344
345
346
347
348
349
350
351
352
353
354
355
356
357
358
359
360
361
362
363
364
365
366
367
368
369
370
371
372
373
374
375
376
377
378
379
380
381
382
383
384
385
386
387
388
389
390
391
392
393
394
395
396
397
398
399
400
401
402
403
404
405
406
407
408
409
410
411
412
413
414
415
416
417
418
419
420
421
422
423
424
425
426
427
428
429
430
431
432
433
434
435
436
437
438
439
440
441
442
443
444
445
446
447
448
449
450
451
452
453
454
455
456
457
458
459
460
461
462
463
464
465
466
467
468
469
470
471
472
473
474
475
476
477
478
479
480
481
482
483
484
485
486
487
488
489
490
491
492
493
494
495
496
497
498
499
500
501
502
503
504
505
506
507
508
509
510
511
512
513
514
515
516
517
518
519
520
521
522
523
524
525
526
527
528
529
530
531
532
533
534
535
536
537
538
539
540
541
542
543
544
545
546
547
548
549
550
551
552
553
554
555
556
557
558
559
560
561
562
563
564
565
566
567
568
569
570
571
572
573
574
575
576
577
578
579
580
581
582
583
584
585
586
587
588
589
590
591
592
593
594
595
596
597
598
599
600
601
602
603
604
605
606
607
608
609
610
611
612
613
614
615
616
617
618
619
620
621
622
623
624
625
626
627
628
629
630
631
632
633
634
635
636
637
638
639
640
641
642
643
644
645
646
647
648
649
650
651
652
653
654
655
656
657
658
659
660
661
662
663
664
665
666
667
668
669
670
671
672
673
674
675
676
677
678
679
680
681
682
683
684
685
686
687
688
689
690
691
692
693
694
695
696
697
698
699
700
701
702
703
704
705
706
707
708
709
710
711
712
713
714
715
716
717
718
719
720
721
722
723
724
725
726
727
728
729
730
731
732
733
734
735
736
737
738
739
740
741
742
743
744
745
746
747
748
749
750
751
752
753
754
755
756
757
758
759
760
761
762
763
764
765
766
767
768
769
770
771
772
773
774
775
776
777
778
779
780
781
782
783
784
785
786
787
788
789
790
791
792
793
794
795
796
797
798
799
800
801
802
803
804
805
806
807
808
809
810
811
812
813
814
815
816
817
818
819
820
821
822
823
824
825
826
827
828
829
830
831
832
833
834
835
836
837
838
839
840
841
842
843
844
845
846
847
848
849
850
851
852
853
854
855
856
857
858
859
860
861
862
863
864
865
866
867
868
869
870
871
872
873
874
875
876
877
878
879
880
881
882
883
884
885
886
887
888
889
890
891
892
893
894
895
896
897
898
899
900
901
902
903
904
905
906
907
908
909
910
911
912
913
914
915
916
917
918
919
920
921
922
923
924
925
926
927
928
929
930
931
932
933
934
935
936
937
938
939
940
941
942
943
944
945
946
947
948
949
950
951
952
953
954
955
956
957
958
959
960
961
962
963
964
965
966
967
968
969
970
971
972
973
974
975
976
977
978
979
980
981
982
983
984
985
986
987
988
989
990
991
992
993
994
995
996
997
998
999
1000

How does leverage affect the firm value when the personal tax rates of shareholders and debt-holders differ? We have already shown that the value of the firm will be reduced when the personal tax rate of lenders is higher than that of shareholders. Miller has provided a formal answer to this question. As we know, the interest tax shield (INTS) which is the gain from leverage is the difference between the value of the levered and unlevered firm, and is also given by the product of the corporate tax rate and the amount of debt under the assumption of perpetual debt and no personal taxes:

$$\begin{aligned}
 \text{INTS} &= k_d D T \\
 \text{PVINTS} &= k_d D T / k_d \\
 \text{PVINTS} &= V_t - V_u = T D \quad \dots(18)
 \end{aligned}$$

Miller introduced personal taxes in the model and modified it. In the unlevered firm where equity income is taxed at T_{pe} personal tax rate, the shareholder's earnings will be:

$$\bar{X} (1 - T) (1 - T_{pe}) \quad \dots(19)$$

and when we discount these earnings at the pure-equity capitalisation rate, k_e , the value of the unlevered firm will be:

$$\dots(20)$$

In case of the levered firm, the shareholder's earnings will be:

$$(\bar{X} - k_d D)(1 - T)(1 - T_{pe}) \quad \dots(21)$$

and the debt-holders' earnings after personal taxes at a rate equal to T_{pb} Will be:

$$k_d D(1 - T_{pb}) \quad \dots(22)$$

The total income of both types of investors (shareholders and debt-holders) will be:

$$\begin{aligned} & (\bar{X} - k_d D)(1 - T)(1 - T_{pe}) + k_d D(1 - T_{pb}) \\ & (1 - T)(1 - T_{pe}) - k_d D(1 - T)(1 - T_{pe}) + k_d D(1 - T_{pb}) \quad \dots(23) \end{aligned}$$

Note that the first term of Equation (23) is equal to the shareholder's earnings of an unlevered firm and therefore, it can be discounted at k . The remaining terms have the same risk as the interest payments, and therefore, they can be discounted at $k(1 - T_{pb})$. Thus the value of the levered firm is:

$$= V_y + \left[1 - \frac{(1 - T)(1 - T_{pe})}{(1 - T_{pb})} \right] D \quad \dots(24)$$

The second term of Equation (24) is the gain from leverage (viz. the present value of the interest tax shield):

$$PVINTS = \left[1 - \frac{(1 - T)(1 - T_{pe})}{(1 - T_{pb})} \right] D \quad \dots(25)$$

Applying Equation (25) to data in Table 18.8, we obtain:

$$PVINTS = \left[1 - \frac{(1 - 0.5)(1 - 0)}{(1 - 0.4)} \right] 5,000 = \left[1 - \frac{0.3}{0.6} \right] 5,000 = \text{Rs } 2,500$$

and when applied to data of Table we obtain:

$$PVINTS = \left[1 - \frac{(1 - 0.5)(1 - 0)}{(1 - 0.4)} \right] 5,000 = \left[1 - \frac{0.5}{0.6} \right] 5,000 = \text{Rs } 833$$

We can generalise the following from Equation (25)

- If $T_{pe} = T_{pb} = 0$, then the present value of the interest tax shield is equal to: TD (corporate tax rate T times the amount of debt, D).
- If $T_{pb} > T_{pe}$ which is a reasonable assumption given the personal tax laws in India, then the present value of the interest tax shield will be less than TD : $PVINTS < TD$.
- If $(1 - T_{pb}) = (1 - T)(1 - T_{pe})$, then the advantageous of leverage will be completely lost.

In terms of the corporate borrowing, Miller's model [Equation (25)] indicates the following. If the personal tax rate on equity income is zero, except the tax-exempt debt-holders, nobody would be interested in lending to the firm. But, from the firm's point, there is a strong incentive to borrow as the corporate taxes are reduced. Therefore, to induce debt-holders to lend to the firm, the firm will have to offer a higher before-tax interest rate. This implies that if the rate on the debt of tax-exempt investors is, say, I , then debt-holders with a personal tax rate of T_{pb} , will have to be at least offered a rate of interest equal to $i_0/(1 - T_{pb})$, otherwise they will not lend. The personal income tax system is generally progressive. Therefore, the firms will have to keep the interest rate rising to attract investors in high tax brackets. Firms will be motivated to keep the interest rate rising if the corporate tax saving is greater than the personal tax loss. They will stop borrowing once the-corporate tax rate, T , equals the personal tax rate, T_{pb} . Thus, in the equilibrium, the interest rate should be equal to: $i_0/(1-T)$. Let us verify this point. Assume that the personal tax rate on equity income is zero: $T_{pe} = 0$, then Equation (25) can be written as follows:

$$PVINTS = \left[1 - \frac{(1-T)}{(1-T_{pb})} \right] D \quad \dots(26)$$

The advantage from leverage will become zero once the interest rate offered (i.e., the supply rate) becomes equal to tax exempt rate grossed up for taxes, $i_s = i_0 (1-T)$. The supply rate i_s is equal to the demand rate i_d , in equilibrium:

$$i_s = \frac{i_0}{1-T} = i_d = \frac{i_0}{1-T_{pb}} \quad \dots(27)$$

and consequently, $(1 - T) = (1 - T_{pb})$, and $PVINTS = 0$. If $i_s < i_0 (1 - T)$, the $PVINTS > 0$ and firms will attempt to reach 100 per cent debt in their capital structures. This is shown in Figure 11.3.

Miller's model has two important implications:

- There is an optimum amount of debt in the economy which is determined by the corporate and personal tax rates. In other words, there is an optimum debt-equity ratio for all firms in the economy.
- There is no optimum debt-equity ratio For a single firm. There are hundreds of firms which have already induced 'tax-exempt' and 'low tax bracket' investors. Therefore, a single firm can-not gain or lose by borrowing more or less.

Miller's model has certain limitations:

- It implies that tax-exempt persons/institutions will invest only in debt securities and 'high-tax bracket' investors in equities. In practice, investors hold portfolio of debt and equity securities.

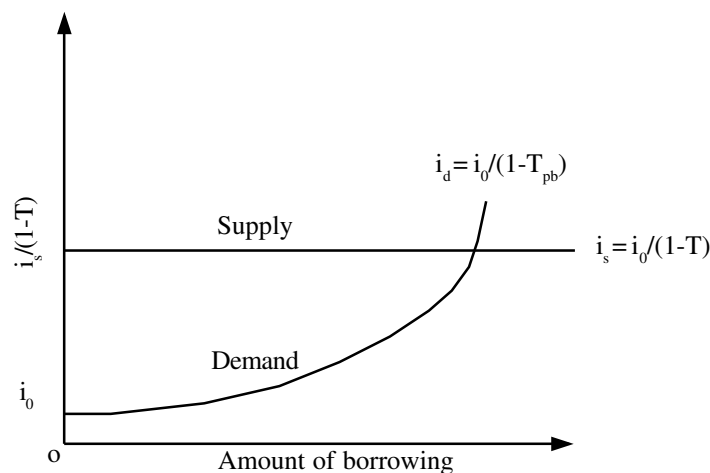

- The personal tax rate on equity income is not zero. Firms do pay dividends. If T_{pe} is positive, more investors can be induced to hold debt securities. Assume $T = 0.25$ and $T = 0.5$. Then the total tax on equity income is: $0.5 + 0.25(1 - 0.5) = 0.625$ or 62.5 per cent. More debt can be raised until investors in 62.5 per cent tax brackets are covered.
- Investors in high-tax brackets can be induced to invest in debt securities indirectly. They can invest in those institutions wherefrom income is tax exempt. These institutions, in turn, can invest in the corporate bonds.

We can summarise our discussion of M-M's and Miller's models as follows. Under M-M's model, the existence of the corporate taxes provide a strong incentive to borrow. In fact, it is ideal for a firm to have 100 per cent debt in its capital structure. They ignore personal taxes. Miller's model considers both the corporate as well as the personal taxes. It concludes that the advantage of corporate borrowing is reduced by the personal tax loss. The important implication of the model is that there is no optimum capital structure for a single firm, although for the economy as a whole, there does exist equilibrium amount of aggregate debt. From a single firm's point of view, therefore, the capital structure does not matter. Miller's model is based on some controversial assumptions, and therefore, most people still believe that in balance, there is a tax advantage to corporate borrowing.

Financial Distress

We have argued earlier that it is difficult to believe that a firm should have 100 per cent debt because of tax advantage. Why don't firms in practice borrow 100 per cent? What are the offsetting disadvantages of debt? The offsetting disadvantages are grouped under the term financial distress. A firm exposed to higher business risk faces a greater chance of financial distress. The business risk of a firm depends on operating risk, intensity of competition, price elasticity, economic conditions, the size of the firm,

extent of diversification etc. Financial distress occurs when the firm finds it difficult to honour the obligations of creditors. The extreme form of financial distress is insolvency. Insolvency could be very expensive. It involves legal costs. The firm may have to sell its assets at ‘distress’ prices. More important consideration is the inflexibility of raising funds when needed if the firm has already used heavy amount of debt. Non-availability of funds on acceptable terms could adversely affect the operating performance of the firm.

Financial distress has many indirect costs as well. It has a great effect on the attitude of management. The shareholders may like the management to invest in risky, marginal projects so that debt holder’s wealth is transferred. Management may also avoid investment in profitable projects since, under an insolvency or financial distress, debt holders are likely to benefit more from such investments. Creditors lose their patience when a firm faces financial problems. They force the firm into liquidation to realise their claims. A financially distressed firm also has a tendency to emphasise short-term profitability at the cost of long-term sustainability and profitability.

Financial distress reduces the value of the firm. Thus, the value of a levered firm is given as Value of levered firm = Value of unlevered firm + PV of tax shield - PV of financial distress

$$V_l = v_u + TD - PVFD \quad ..(28)$$

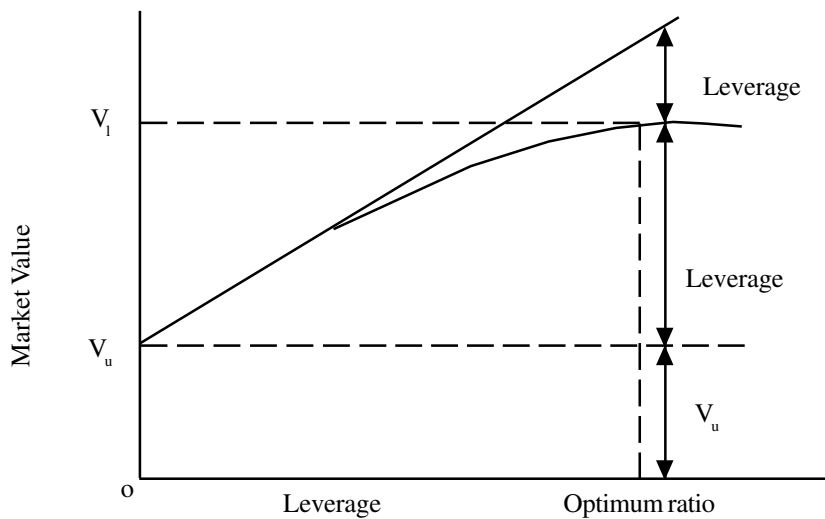

Figure 11.4 shows the capital structure of the firm is determined as a result of the tax benefits and the costs of financial distress. The present value of the interest tax shield increases with borrowing but so does the present value of the costs of financial distress. However, the costs of financial distress are quite insignificant with moderate level of debt, and therefore, the value of the firm increases with debt. With more and more debt, the costs of financial distress increases and therefore, the tax benefit

shrinks. The optimum point is reached when the present value of the tax benefit becomes equal to the present value of the costs of financial distress. The value of the firm is maximum at this point.

CAMP and Capital Structure

Leverage causes variability in the shareholder's return (EPS or ROE). This adds financial risk. As a consequence, the beta of a firm's equity will increase as it introduces debt in its capital structure. We know that a portfolio consists of individual securities. Each security has its beta, and the beta of the portfolio is the weighted average beta of individual securities in the portfolio. Similarly, a firm is a portfolio of assets, and therefore, the asset beta of a firm, β_a , is the weighted average of betas of individual assets. Thus,

$$\beta_a = \beta_1\omega_1 + \beta_2\omega_2 + \beta_3\omega_3 + \dots$$

$$\beta_a = \sum_{i=1}^n \beta_i\omega_i \quad \dots(29)$$

where β_a is the weighted average beta of assets, β_i is the beta of i th asset and ω_i is the weight of i th asset.

A firm's assets are financed by debt and equity. Therefore, a firm's asset beta will also equal to the weighted average of the firm's equity beta and debt beta. Assuming no corporate tax, the beta of assets will be as follows:

$$\beta_a = \beta_e\omega_e + \beta_d\omega_d \quad \dots(30)$$

where β_e is equity beta, ω_e is weight of equity, β_d is debt beta and ω_d is weight of debt. Weight of equity is equal to the market value of equity (S) divided by the total value of the firm (V) and the weight of debt will be equal to the market value of debt (D) divided by the total value of the firm (V).

Thus,

$$\beta_a = \beta_e \left(\frac{S}{S+D} \right) + \beta_d \left(\frac{D}{S+D} \right) \quad \dots(31)$$

What is beta of equity for a levered firm? We can derive equity beta from Equation (31) as follows:

$$\beta_e \left(\frac{S}{S+D} \right) = \beta_a - \beta_d \left(\frac{D}{S+D} \right)$$

$$\beta_e = \beta_a \left(\frac{S+D}{S} \right) - \beta_d \left(\frac{D}{S+D} \right) \left(\frac{S+D}{S} \right)$$

$$= \beta_a \left(1 + \frac{D}{S}\right) - \beta_d \left(\frac{D}{S}\right) = \beta_a + (\beta_a - \beta_d) \frac{D}{S} \quad \dots(32)$$

We can observe from Equation (32) that the equity beta increases linearly with leverage (D/S) since it adds financial risk to the shareholder’s return.

Illustration 1: Unlevered Firm has no corporate tax. The observed beta on its equity is 1.20. The beta of debt is 0.20. The company has a debt-equity ratio of 0.40. Calculate the company’s asset beta.

$$\begin{aligned} \beta_e &= \beta_a + (\beta_d - \beta_e) D/S \\ 1.20 &= \beta_a + (\beta_a - 0.20) 0.40 \\ \beta_e + 0.4\beta_a &= 1.20 + 0.08 \\ \beta_a &= 1.28/1.4 = 0.914 \end{aligned}$$

Debt has low risk. If we assume that debt is risk-free, then $\beta_d = 0$. If $\beta_d = 0$, then β_a (asset beta) is given as follows:

$$\begin{aligned} \beta_e &= \beta_a + (\beta_d - \beta_e) D/S \\ \beta_e &= \beta_a + \beta_a D/S \quad (\text{since } \beta_d = 0) \\ \beta_a &= \frac{\beta_e}{1 + D/S} \quad \dots(33) \end{aligned}$$

Corporate Tax and Interest Tax Shield

Firms in practice pay taxes, and interest paid on debt is tax deductible. The asset beta should be adjusted for the tax effect. The adjustment factors will be the tax rate and the firm’s leverage (debt ratio). The adjusted beta will be as follows:

$$\dots(34)$$

where V is total market value of debt and equity (i.e. S + D).

As we have stated earlier, the risk of debt holders is quite low. If they have no risk, they will earn risk-free rate and β_d will be zero. Thus, Equation (34) can be expressed as follows:

$$\beta_a = \frac{\beta_e(SV)}{[1 - (D/V)T]} \quad (\text{since } \beta_d = 0) \quad \dots(35)$$

where L is D/V. From Equation (35), we can express β_e as follows:

$$\beta_e = \beta_a \left[\frac{(1-LT)}{(1-L)} \right] \quad \dots(36)$$

Illustration 2: Nicole Publishing Company's market value of shares and debt is Rs 50 crore and Rs 15 crore respectively. The beta of the company's share is 1.32. The expected corporate tax rate for the company is 35 percent. Calculate Nicole's asset beta.

Total value of the firm, $V = 50 + 15 = \text{Rs } 65 \text{ crore}$

Value of shares, $S = \text{Rs } 50 \text{ crore}$

Value of debt, $L = \text{Rs } 15 \text{ crore}$

Debt ratio, $D/V = L = 15/65 = 0.23$

$$\beta_a =$$

$$\frac{\beta_e(1-L)}{(1-LT)} = \frac{1.32(1-0.23)}{(1-0.23 \times 0.35)} = \frac{1.016}{0.9195} = 1.10$$

It is not difficult to appreciate that for an unlevered firm (a firm without any debt), the asset and equity bet will be the same. For a levered firm, the cost of equity under CAPM will be as follows:

$$k_e = r_f + (r_m - r_f) \beta_e \quad \dots(37)$$

$$= r_f + (r_m - r_f) \beta_a \quad \dots(38)$$

where β_a is the asset beta of an unlevered firm.

Illustration 3: Chemicals has an equity beta of 1.25 and debt ratio of 0.5. The risk-free rate is 9 per cent and the expected market rate of return is 20 per cent. The corporate tax rate is 35 percent. What is Desai chemical's required rate of return on equity?

If we use Equation (37), we obtain:

$$k_e = 0.09 + (0.20 - 0.09)1.25 = 0.09 + 0.1375 = 0.2475 \text{ or } 24.75\%$$

The asset beta is:

$$\beta_a =$$

Using Equation (37), we obtain:

$$\begin{aligned} k_e &= 0.09 + (0.20 - 0.09)0.758 && = 0.09 + (0.20 - 0.09)0.758 \times 1.65 \\ &= 0.09 + (0.20-0.09)1.25 = 0.2475 \text{ or } 24.75\% \end{aligned}$$

Cost of Equity and Beta of a Division

It has been argued that in evaluating a division’s investment, its cost of capital should be used as the discount rate. The risk of the division may not be the same as the risk of the firm. The beta of the division may, therefore, be higher or lower than the firm’s beta. We also explained that in practice, a division’s beta may be approximated by finding out the betas of the comparable firms in the same industry to which division belongs. However, the comparable firms may have different levels of debt. Before using the beta of a comparable firm (or weighted average betas of the comparable firms) to a division, adjustment for leverage should be made. The following steps are involved:

- Identify comparable firms in the same industry as the division.
- Calculate the betas of the comparable firm.
- Estimate the comparable firms asset betas by adjusting them for leverage and tax. (This process is called ‘unlevering’ the beta) ,
- Calculate the average beta from the comparable firms’ asset betas that can be used as the beta for the division,

Illustration 10: A large engineering company wants to diversify into fertiliser business organise it as a new division. The company found a comparable fertiliser company that has an equity beta of 1.35, and debt ratio of 0.72. The corporate tax rate is 35 per cent. The engineering company will have a debt ratio of 0.50 for proposed fertiliser business. Calculate the beta for the proposed new division.

First, we shall ‘unlever’ the equity beta (that is, calculate the asset beta) of the comparable firm:

$$\beta_a = \beta_e$$

Second, se can now ‘lever’ the equity beta for the division by incorporating its debt ratio:

$$\beta_e = \beta_a \left[\frac{(1-L)}{(1-LT)} \right] = 0.51 \left[\frac{1 - 0.50 \times 0.35}{1 - 0.50} \right] = 0.51 \times 1.65 = 0.84$$

The equity beta for the division is lower than that of the comparable firm since it will employ less debt.

Adjusted Present Value

Equation (14) gives the value of a levered firm:

$$V_l = V_u + TD = \frac{\bar{X}(1-T)}{k_u} + \frac{Tk_d D}{k_d} \quad \dots(14)$$

Recall that k_U is the cost of capital of an all-equity (unlevered) firm, it $\bar{X}(1-T)$ is perpetual after-tax cash flows (net operating income) of an all-equity firm and $Tk_d D$ is a perpetual stream of interest tax shield, Equation (14) implies the following required rate of return for a levered firm:

$$k_l = V_u (1-TL)$$

where k_l is the cost of capital of the levered firm and L is debt ratio (D/V).

We can use k_l as the discount rate for those investment projects that generate perpetual cash flows (perpetual after-tax all-equity cash flows and perpetual interest tax shields). In practice, it not common to find projects with perpetual cash flows. Projects have finite life, and firms are able to raise funds from financial institutions or public which are tied to specific projects. This is more so under project financing. Thus, the amounts of interest and principal repayments are predetermined, and they are accounted for within the life of the project. Such projects have their unique capital structure.

How can we evaluate the net present value of projects that are not perpetual investments and that do not have constant capital structure? It is not possible to estimate the weighted cost of capital for such projects. We can use the adjusted present value (APV) method for evaluating such investments.

We can rewrite Equation (14) for valuing an investment project with finite cash flows as follows:

$$APV =$$

$$\dots(39)$$

In practice, a project may get many other benefits (or involve penalties) in addition to the interest tax shield. Equation (39) can be extended to incorporate the value of such benefits (or costs). There is no method available to adjust such items in estimating the weighted average cost of capital.

Illustration 4: Gujarat Engineering Company is considering a new project to manufacture steel tubes. The estimated project outlay is Rs 64 crore which will be raised by issuing equity of Rs 40 crore and borrowing a 15 per cent loan of Rs 24 crore from a financial institution for eight years. The loan will be repaid in three equal instalments at the end of years 6, 7 and 8. The project is expected to generate an annual after-tax cash flow of Rs 12 crores over the eight-year life of the project. The all-equity required rate of return is 18 per cent. The corporate tax rate is 35 percent. The terminal value of the project is assumed to be zero. Should the company make investment to manufacture steel tube? We can use APV method for evaluating the project.

The project is expected to generate an after-tax annuity of Rs 12 crore for 8 years. The interest tax shield is calculated as follows:

Year	Loan at the Beginning	Interest	Principal Repayment	Loan at the End	Interest Tax Shield
0	-	-	-	24	-
1	24	3.60	-	24	1.26
2	24	3.60	-	24	1.26
3	24	3.60	-	24	1.26
4	24	3.60	-	24	1.26
5	24	3.60	-	24	1.26
6	24	3.60	8	16	1.26
7	16	2.40	8	8	0.84
8	8	1.20	8	0	0.42

The project’s APV can be calculated by using Equation (40):

$$\begin{aligned}
 APV &= \sum_{t=1}^8 \frac{12}{(1.18)^t} \left[\sum_{t=1}^6 \frac{1.26}{(1.15)^t} + \frac{0.84}{(1.15)^7} + \frac{0.42}{(1.15)^8} \right] \\
 &= (12 \times 4.0776) + [1.26 \times 3.7845 + 0.84 \times 0.3759 + 0.42 \times 0.3269] \\
 &= 48.93 + [4.77 + 0.32 + 0.141] = 48.93 + 5.23 = \text{Rs } 54.16
 \end{aligned}$$

The adjusted net present value (ANPV) is:

$$ANPV = APV - \text{Initial Cost} = 54.16 - 64 = - \text{Rs } 9.84$$

Since ANPV is negative, the project should not be accepted.

What will happen to the project’s ANPV if the company is able to negotiate loan of Rs 24 crore at concessional interest rate of 10 per cent from the government if it agrees to start the project in a backward area? If the market interest rate is assumed to be 15 per cent, the project gets a ‘subsidy’ of 5 percent. Also, it will get interest tax shield. The interest subsidy and interest tax shields are calculated as follows (assuming that loan is repaid in equal instalments at the end of years 6, 7 and 8):

Year	Interest Subsidy	Interest Tax Shield
1.	$(0.15 - 0.10) 24 = 1.20$	$0.35 \times 0.10 \times 24 = 0.84$
2.	$(0.15 - 0.10) 24 = 1.20$	$0.35 \times 0.10 \times 24 = 0.84$
3.	$(0.15 - 0.10) 24 = 1.20$	$0.35 \times 0.10 \times 24 = 0.84$
4.	$(0.15 - 0.10) 24 = 1.20$	$0.35 \times 0.10 \times 24 = 0.84$
5.	$(0.15 - 0.10) 24 = 1.20$	$0.35 \times 0.10 \times 24 = 0.84$
6.	$(0.15 - 0.10) 24 = 1.20$	$0.35 \times 0.10 \times 24 = 0.84$
7.	$(0.15 - 0.10) 16 = 1.20$	$0.35 \times 0.10 \times 16 = 0.84$
8.	$(0.15 - 0.10) 8 = 1.20$	$0.35 \times 0.10 \times 8 = 0.84$

The project APV will be:

$$\begin{aligned}
 APV &= \sum_{t=1}^8 \frac{12}{(1.18)^t} + \left[\sum_{t=1}^6 \frac{0.84}{(1.15)^t} + \frac{0.56}{(1.15)^7} + \frac{0.28}{(1.15)^8} \right] + \left[\sum_{t=1}^6 \frac{1.20}{(1.15)^t} + \frac{0.80}{(1.15)^7} + \frac{0.40}{(1.15)^8} \right] \\
 &= 48.93 + [3.18 + 0.21 + 0.09] + [4.54 + 0.3P + 0.13] \\
 &= 48.93 - 3.48 + 4.97 - 57.38
 \end{aligned}$$

The project's ANPV is:

$$ANPV = 57.38 - 64$$

The project, in spite of the benefit of interest subsidy, is still unattractive.

Illustrative Problems

Problem 1: Kelley Manufacturing Co. has a total capitalisation of Rs 10,00,000, and it normally earns Rs 1,00,000 (before interest and taxes). The Financial manager of the firm wants to take a decision regarding the capital structure. After a study of the capital market, he gathers the following data:

Amount of Debt Rs.	Interest Rate %	Equity Capitalisation Rate (at given level of debt) %
0	-	10.00
1,00,000	4.0	10.50
2,00,000	4.0	11.00
3,00,000	4.5	11.60
4,00,000	5.0	12.40
5,00,000	5.5	13.50
6,00,000	6.0	16.00
7,00,000	8.0	20.00

- What amount of debt should be employed by the firm if the traditional approach is held valid?
- If the Modigliani-Miller approach is followed, what should be the equity capitalisation rate?

Assume that corporate taxes do not exist, and that the firm always maintains its capital structure at book values.

Solution

- As per the traditional approach, optimum capital structure exists when the weighted average cost of capital is minimum. The weighted average cost of capital calculations at book value weights are as follows:

k_e (1)	W_e (2)	k_d (3)	W_d (4)	$k_e W_e$ (5)	$k_d W_d$ (6)	k_0 (7)=(5)+(6)
0.100	1.0	-	-	0.100	-	0.1000
0.105	0.9	0.040	0.1	0.095	0.0040	0.0985
0.110	0.8	0.040	0.2	0.080	0.0080	0.0960
0.116	0.7	0.045	0.3	0.082	0.0135	0.0947
0.124	0.6	0.050	0.4	0.074	0.0200	0.0944
0.135	0.5	0.055	0.5	0.065	0.0275	0.0950
0.160	0.4	0.060	0.6	0.060	0.0360	0.1000
0.200	0.3	0.080	0.7	0.060	0.0560	0.1160

The firm should employ debt of Re 4,00,000 as the weighted average cost of capital is minimum at this level of debt.

- (b) According to the M-M approach, the cost of capital is a constant, and the cost of euqity increases linearly with debt. The equilibrium cost of capital is assumed to be equal to pure equity capitalisation rate, which is 10 per cent in the present problem. The equity capitalisation rate is given by the following formula:

$$k_e = k_0 + (k_0 - k_d) \frac{\text{Debt}}{\text{Equity}}$$

The equity capitalisation rates will be:

Debt Rs	k_d	k_0		$(k_0 - k_d)$	Debt/Equity	k_e
0	-	0.10	+	(0.10-0.000)	0	= 0.1000
1,00,000	0.040	0.10	+	(0.10-0.040)	1,00,000/9,00,000	= 0.1067
2,00,000	0.040	0.10	+	(0.10-0.040)	2,00,000/8,00,000	= 0.1150
3,00,000	0.040	0.10	+	(0.10-0.045)	3,00,000/7,00,000	= 0.1236
4,00,000	0.050	0.10	+	(0.10-0.050)	4,00,000/6,00,000	= 0.1333
5,00,000	0.050	0.10	+	(0.10-0.055)	5,00,000/5,00,000	= 0.1450
6,00,000	0.060	0.10	+	(0.10-0.060)	6,00,000/4,00,000	= 0.1600
7,00,000	0.080	0.10	+	(0.10-0.080)	7,00,000/3,00,000	= 0.1467

Problem 2: The Levered Company and the Unlevered Company are identical in every respect except that the Levered Company has 6 per cent Rs 2,00,000 debt outstanding. As per the NI approach, the valuation of the two firms is as follows:

	Unlevered Co. Rs	Levered Co. Rs
Net operating income, X	60,000	60,000
Total cost of debt, $k_d D$	0	12,000
Net earnings, NI	60,000	48,000
Equity capitalisation rate, k_e	0.100	0.111
Market value of shares, S	6,00,000	4,32,000
Market value of debt, D	0	2,00,000
Total value of the firm, V	6,00,000	6,32,000

Mr X holds Rs 2,000 worth of the Levered Company's shares. Is it possible for Mr X to reduce his outlay to earn same return through the use of arbitrage? Illustrate.

Solution

Through arbitrage it is possible for Mr X to reduce his outlay and earn the same return.

1. Mr X would sell his shares in the Levered Company for Rs 2,000.
2. He would create a personal leverage equal to his share of debt in the Levered Company by borrowing Rs 926 (= Rs 2,000 x Rs 2,00,000/Rs 4,32,000).
3. He would buy Rs 2,778 (= Rs 6,00,000 x Rs 2,000/Rs 4,32,000) of the Unlevered Company's shares His return is:

Return on the Unlevered Co.'s shares: Rs 2,778 × 10%	Rs 2,77.80
Less: Interest, Rs 926 × 6%	55.56
Net return	Rs 2,22,24

His return from the Levered Co. is Rs 2,000 x 11.1% = Rs 222.22, same as in the Unlevered Co. However, the funds involved in the Unlevered Co are Rs 2,778 - Rs 926 = Rs 1,852 which is less than Rs 2,000 cash outlay involved in the Levered Company.

Problem 3: Firms A and B are similar except that A is unlevered, while B has Rs 2,00,000 of 5 per cent debentures outstanding. Assume that the tax rate is 40 per cent; NOI is Rs 40,000 and the cost of equity is 10 per cent. (i) Calculate the value of the firms, if the M - M assumptions are met. (in Suppose $V_B = Rs 3,60,000$. According to M-M. do these represent equilibrium values? How will equilibrium be set? Explain.

Solution

- (i) The value of the unlevered firm is:

$$V_A = \frac{(1-T)\bar{X}}{k} = \frac{(1-0.4)Rs\ 40,000}{0.10} = Rs\ 2,40,000$$

The value of the levered firm is:

$$\begin{aligned} V_B &= V_A + TD = Rs\ 2,40,000 + 0.4\ \text{of}\ Rs\ 2,00,000 \\ &= Rs\ 2,40,000 + Rs\ 80,000 = Rs\ 3,20,000 \end{aligned}$$

- (ii) These do not represent the equilibrium values. Firm B is overvalued by Rs 40,000 (= Rs 3,60,000 - Rs 3,20,000). The arbitrage process with taxes will work as follows to restore equilibrium

Assume an investor owns and return is 10 per cent of B Co.'s shares. His investment is:

$$0.10 \times (\text{Rs } 3,60,000 - \text{Rs } 2,00,000) = 0.10 \times \text{Rs } 1,60,000 = \text{Rs } 16,000$$

and return is

$$0.10 \times [(\text{Rs } 40,000 - \text{Rs } 10,000) (1-0.4)] = 0.10 \times \text{Rs } 13,000 = \text{Rs } 1,800$$

The investor can get the same income by shifting his investment to A Co. He would sell his holdings in B Co. for Rs 16,000 and borrow on personal account Rs. 12,000, which is his percentage holdings in B Co.'s debt i.e., 0.10 (1-0.4) Rs 2,00,000 = Rs 12,000. He would then, purchase 10 per cent of A Co.'s share: 0.10 × Rs 2,40,000 = 24,000. His return and outlay would be:

	Rs
Return 0.10(1-0.4) 40.000	24,000
Less: cost of personal debt 0.05 x Rs 12,000	600
Net return	1,800
Total funds available at his disposal:	
From sale of B Co.'s shares	16,000
Borrowed funds	12,000
	28,000
Total cash outlay in A Co.'s shares	24,000
Uncommitted funds	4,000

Through arbitrage and the substitution of personal for corporate leverage, the investor can switch from B Company to A Company, earn the same total return of Rs 1,800, and have funds left over to invest elsewhere. This process would continue till the equilibrium is restored.

Problem 4: The following are the costs and values for the firms A and B according to the traditional approach:

	A Rs	B Rs
Total value of firm, V	50,00	60,000
Market value of debt, D	0	30,000
Market value of equity, S	50,000	30,000
Expected net operating income, \bar{X}	5,000	5,000
Cost of debt, $INT = k_d D$	0	1,800
Net income, $- k_d D$	5,000	5,000
Cost of equity, $k_e = (- k_d D)/S$	10.00%	10.70%
Debt-equity ratio, D/S	0	0.5
Average cost of capital, k_0	10.00%	8.33%

Compute the equilibrium value for Firms A and B in accordance with the M-M thesis. Assume that (i) taxes do not exist and (ii) the equilibrium value of k_0 is 9.09 per cent.

Solution

The equilibrium values are shown below:

for Firms A and B in accordance with the M-M thesis. Assume that (i) taxes do not exist and (ii) the equilibrium value of k_0 is 0.09 per cent.

	A Rs	A Rs
Expected net operating income,	5,000	5,000
Total cost of debt, $INT = k_d D$	0	1,800
Net income, $E = E - k_d D$	5,000	3,200
Average cost of capital, k_0	0.909	0.909
Total value of firm, $V = E / k_0$	55,000	55,000
Market value of debt, D	0	30,000
Market value of shares, $S = V - D$	55,000	25,000
Cost of equity, $k_e = (E - k_d D) / S$	0.909	0.128

Asymmetric Information Theory

Also called the pecking order theory, this theory is based on the assumption that managers have better information than investors, postulates that there is a preferred "pecking order" of financing: first use retained earnings (and depreciation), then debt, and, finally, as a last resort only, issue new common stock. This theory leads to the conclusion that firms should maintain a borrowing capacity reserve so that they can always issue debt on reasonable terms rather than have to issue new stock at the wrong time.

Another important point that needs to be remembered is that the optimal capital structure is structured by the managers in terms of book value rather than market value terms. As book values reflect the historical costs of the assets, these have little to do with the ability to produce cash flows and debt servicing capability. As the main focus of analysing capital structure is to find a structure which maximises the firm's market value, and hence its stock prices, so it can only be analysed by an analysis of the market values. But the problem with using the market values is that they are unpredictable, so managers tend to use book values which are far easier to predict.

Another point that is not considered is of the growth of the firm. Growth rates have implications on the marketing approach, investments, organisation size, structure and capital requirements. When the projected growth is rapid, the capital structure has to be flexible enough to vary within a certain range of debt and equity ratio to accommodate funds requirements for the future growth of the firm. A contracting market for the company's products may indicate a need to move away from debt. This is because in case of reduced sales and hence lower profits, the risk of the firm defaulting on debt

servicing is high so the interest rates charged by the creditors increase to reflect the changing risk profile of the company.

Sometimes promoters having management capability and experience in high growth potential areas are lacking in financial strength. These companies, if they have to raise funds in the market will have to financially leverage their meagre capital contribution by a high incidence of debt. Here, the need to retain management control limits the amount of equity that can be raised and subsequently the debt that can be raised, too.

Taxation and capital structure

In 1963, MM added corporate taxes to their model. With corporate taxes considered, a firm's stock price was shown to be directly related to its use of debt financing -- higher the percentage of debt financing, the higher the stock price. Under the MM with tax theory, firms should use virtually 100% debt financing. The reason for this result is the corporate tax structure - returns to stockholders come from after-tax earnings, but returns to creditors are paid before tax. The effect of this tax treatment is that more of a company's operating income is left for investors when more debt financing is used.

Modigliani and Miller basic propositions with corporate taxes are as follows:

Proposition I

The total market value of a leveraged firm is equal to (1) the value of an unleveraged firm in the same risk class plus (2) the gain from leverage, which is the value of the tax savings due to debt financing and which equals the corporate tax rate times the amount debt the firm uses.

$$V_L = V_U + T_D$$

With zero debt the value of the unleveraged firm is equal to the value of its equity

$$E = V_U =$$

Proposition II

The cost of equity of a leveraged firm is equal to (1) the cost of equity of an unleveraged firm in the same risk class plus (2) a risk premium, whose size depends on the differential between the costs of equity and debt to an unleveraged firm, the amount of financial leverage and the corporate tax rate.

This means that as the firm's use of debt increases, its cost of equity also rises but at a slower rate now because of the effect of $(1-T)$ which is less than 1.

Empirical Evidence Against MM Hypothesis

In spite of the MM arguments, firms do not usually use anywhere close to 100% debt

financing. In an attempt to modify MM's model to make it more consistent with actual behaviour, many of their assumptions were relaxed in papers by other authors. In particular, the possibility of financial distress drastically changed the MM results. In the modified model, tax savings cause the value of a firm to rise as more and more debt is used, but at some point (the optimal structure), the value of the firm begins to fall with additional debt because the tax benefits are more than offset by the increasing costs of potential financial distress.

The MM model as modified to include financial distress suggests to managers

- that a certain amount of debt is good
- that too much debt is bad, and
- that there is an optimal amount of debt for every firm.

Thus, the modified MM theory, which is called the trade-off theory of capital structure, provides useful insights into the factors that affect a firm's optimal capital structure. Here the marginal costs and benefits of debt financing are balanced against one another, and the result is an optimal capital structure that fall somewhere between zero and 100% debt.

Tax Perspective

Both Debt or Equity require the company to service the same. Interest is paid on debt and dividends on equity. Interest, which is 100% deductible for Income Tax purposes, provides the company a tax shield for the amount of interest being charged.

Let us take an example to compare two modes of financing:

	Case 1	Case 2
Company	ABC Ltd.	XYZ Ltd.
Equity (Rs. Mn)	10	30
Debt (Rs. Mn)	20	nil
Turnover (Rs. Mn)	100	100
Cost of Goods sold (Rs. Mn)	50	50
Other Expenses (Rs. Mn)	40	40
Interest (Rs. Mn)	2	Nil
Profit Before Tax (Rs. Mn)	8	10
Tax (Rs. Mn)	2.4	3.0
PAT (Rs. Mn)	5.6	7.0

Company XYZ enjoys a tax shield of Rs 0.6mn. Assuming that the above capital structure remains unchanged for 3 years, then at the current level of profitability, after 3 years company ABC would have paid Rs 6mn as interest whereas the company XYZ would have paid Rs 4.2 mn thus saving Rs 1.8mn in taxes in 3 years.

However, a major drawback with debt is that it entails a liability for the company for a particular period of time and thus might act as a drawback in improving profitability during the lean phase of business. However, equity doesn't have the above mentioned disadvantage. During stable market conditions, debt is perhaps the cheapest mode of raising capital from external sources. But in volatile market conditions, equity is perhaps the safest mode.

Normally a company wishes to raise capital by way of both equity and debt because of the several constraints mentioned below. To make the task easier in deciding what to raise and how much to raise, we use a technique known as EBIT-EPS analysis. This analysis helps us to understand how sensitive is EPS to changes in EBIT under different financing alternatives. It is also possible to calculate the break even EBIT level (for two alternative financing plans), i.e., the level of EBIT for which the EPS is the same. The EBIT indifference point between the two alternative plans can be obtained mathematically by solving the following equation for EBIT:

$$\frac{(\text{EBIT} - I_1)(1 - t)}{n_1} = \frac{(\text{EBIT} - I_2)(1 - t)}{n_2}$$

Where,

EBIT = indifference point between the two alternative financing plans

I_1, I_2 = interest expenses before taxes under financing plans 1 and 2

t = income tax rate

n_1, n_2 = number of equity shares outstanding after adopting financing plans 1 and 2.

Below this level of EBIT it would be useful to raise money from equity only and above this level of EBIT, raising money from debt would be a suitable alternative.

Assessment of Debt Capacity & Planning The Capital Structure

At the optimum capital structure the value of an equity share is the maximum and the average cost of capital is the minimum. A capital structure is considered to be appropriate if the following conditions are met:

1. Profitability: The capital structure should result in maximum profitability.

2. Solvency: Company should not run the risk of insolvency because of the increased debt in the balance sheet.
3. Flexibility: The capital structure should provide enough flexibility to the company to raise additional funds whenever required without constraints.
4. Control: Control of the company should not be lost because of the high dilution of equity.

This means that the finance manager has to make a compromise between the best capital structure and the peculiar needs of the company.

Factors Influencing Capital Structure

In the real world taking decisions on capital structure is not so easy as it is made out till now. In deciding the capital structure of a company, the following points need to be considered:

Corporate Strategy

Corporate strategy is the main factor determining the financial structure of a company. The market growth rates form a basis for defining the Organisation structure, Investment in Assets and Overall Capital Intensity (Debt/Equity Financing). The fact that the company has to source funds from the markets, makes it imperative to factor in the market responsiveness to the company's call for funds. Capability to service the funds, both debt and equity and the growth phase of the business have to be considered in tandem. Other strategic decisions like management control level, risk averseness or risk taking nature of the management, etc. have also to be considered.

Ultimately, the most appropriate capital structure will be the one, which most closely supports the strategic direction of the business with the least cost and at a reasonably acceptable risk level.

Nature of the Industry

The nature of the industry plays an important role in capital structure decisions.

Capital Intensity: Capital structure should factor in the type of the assets being financed. Capital intensive firms rely mostly on long term debt and equity. Generally speaking, long term assets should be financed by a balance between term debt and equity and short term assets should be financed less by long term sources (like term debt and equity) and more by short term debt. The terms current (short term) and fixed (long term) assets are determined by the nature of the industry and the business itself. For example, a rapidly growing non-seasonal and non-cyclical business may regard part of its investments in short term assets like inventories and accounts receivable, as permanent

investments and fund it by long term sources. If on the other hand, the business is seasonal in nature, the seasonal peaks fund requirements may have to be funded by short term debt.

Cyclical Business: In businesses like construction, capital and higher consumer goods their volumes, and hence requirements of funds, are affected by the changes in the national and global scene. Businesses subject to such variations need a capital structure that can buffer the risks associated with such swings. Again manoeuvrability of capital structure, is at a premium during times of contraction.

Competition: The degree of competition is also a major factor to be considered in deciding the capital structure. In highly competitive industry with low entry barriers, companies with deep pockets can only survive in the long run.

Product or business life cycle: During the initial phase of the growth curve of a business/product the risk is high. Debt is hard to come by due to the riskiness of the venture and funding has to be through the venture capital equity. Financial leverage is low, which could be increased as the product/business establishes itself. As the business matures, increased cash flows may reduce the need for debt funds.

Current and Past capital Structure

Current capital structure of a company is determined largely by past decisions. Investment decisions of the past, acquisitions, take-overs, financing policy, dividends etc. go into forming the current capital structure which is difficult to change overnight. Altering current capital structure can be done by raising capital, retiring debts, buying back shares, taking on debt, altering dividend payout policies, alteration in earning capacity, etc. Also, as past decisions decide current capital structure, current changes in the capital structure decide the future capital structure. Hence, utmost care has to be exercised in decision and implementation of changes in the capital structure.

While making the capital structure decisions, the company has to consider the different life cycle stages which are :

- the pioneering stage
- the expansion stage
- the stagnation/stabilisation stage

The pioneering stage is one of rapid increase in demand for the products/services of the company. The risk is highest at this stage of the life cycle of the company and the efficient companies are the ones to survive. The financial cost of borrowing is very high at this stage, due to the risk perception about the company. To survive this the capital structure should orient more towards equity and if available utilise soft loans from the government.

The expansion stage is the next stage, during which the strong companies survive the competitive struggle and aim to expand their market share and volumes. During this stage, huge investments are made to expand production/service capacity. Requirement of funds is high during this stage. Subject to the corporate strategy of funding projects and the market conditions, the company may raise capital at the lowest possible cost. As the earnings stabilise, the company will be in a position to weather any small variations in business, then it can seek to financially leverage itself within a pre-fixed ceiling, by bank loans or financial institutional loans. It is during this stage that companies are typically expected to reward their investors with dividend and stock dividend/splits.

Stabilisation/stagnation stage is the last and final stage. A dynamic management will always be on the lookout for expansion/diversification into new projects. It could, again depending on corporate strategy, go in for green-field projects or take over existing units, seek mergers, acquisitions and strategic alliances, etc. Usually a recession in economy opens up a vast number of such opportunities which cash rich companies can take advantage of. In case of lack of such opportunities, the company could reduce the financial leverage and save on interest and if possible down size the equity by buy back of shares. Buy back of shares acts to boost investor confidence in the company and also makes equity serviceable during recession.

EBIT - EPS Analysis & ROI - ROE Analysis

As a method to study the effect of leverage on capital structure, EBIT - EPS analysis essentially involves the comparison of alternative methods of financing under various assumptions of EBIT. A firm has the choice to raise funds for financing its investment proposals from different sources in different proportions. For instance, it can (i) exclusively use equity capital (ii) exclusively use debt, (iii) exclusively use preference capital, (iv) use a combination of (i) and (ii) in different proportions; (v) a combination of (i), (ii) and (iii) in different proportions, (vi) a combination of (i) and (iii) in different proportions, and so on. The choice of the combination of the various sources would be one which, given the level of earnings before interest and taxes, would ensure the largest EPS. Consider Example 4.3.

Suppose a company has a capital structure exclusively comprising of equity shares amounting to Rs.10,00,000. The firm now wishes to raise additional Rs. 10,00,000 for expansion. The firm has various alternatives, three of them are given below:

- (A) It can raise the entire amount in the form of equity capital.
- (B) It can raise 50 per cent as equity capital and 50 per cent as 5% debentures.
- (C) It can raise the entire amount as 6% debentures.

Further assume that the existing EBIT is Rs.1,20,000, the tax rate is 35 per cent, outstanding shares 10,000 and the market price per share is Rs.100 under all the three alternatives.

Which financing plan should the firm select?

Solution

EPS Under Various Financial Plans

<i>Particulars</i>	<i>Financing Plans</i>		
	<i>A</i>	<i>B</i>	<i>C</i>
EBIT	Rs 1,20,000	Rs 1,20,000	Rs 1,20,000
Less: Interest	-----	25,000	60,000
Earnings before taxes	1,20,000	95,000	60,000
Taxes	42,000	33,250	21,000
Earnings after taxes	78,000	61,750	39,000
Less: Preference dividend	-----	-----	-----
Earnings available to ordinary shareholders	78,000	61,750	39,000
Number of shares	20,000	15,000	10,000
Earnings per share (EPS)	3.9	4.1	3.9

The calculations in Table reveal that given a level of EBIT of Rs.1,20,000, the financing alternative B, which involves 50 per cent ordinary shares and 50 per cent debt, is the most favourable with respect to EPS.

Table also indicates that the annual before-tax costs of the various financing plans are:

1. Financing Plan B Rs.25,000
2. Financing Plan C 60,000

Financing plan A involves no cost as there is no fixed financial charge. That the financing plan involves a specific amount of cost, is another way of saying that an equal amount of earnings before interest and taxes is necessary to cover the fixed financial charges. Earnings per share would be zero for plans B, C for the EBIT level of Rs.25,000, Rs.60,000 respectively. This level of EBIT may be termed as financial break even (BEP) level of earnings before interest and taxes because it represents the level of EBIT necessary for the firm to break even on its fixed financial charge. In other words, it is the level of EBIT at which the firm can satisfy all fixed financial charges (i.e. interest and preference dividend). EBIT less than this level will result in negative EPS. The financial break-even point can be determined by Eq.

$$\text{Financial break-even point} = \frac{I + D_p}{1 - t}$$

where I = Annual interest charges

DP = Preference dividend

T = Tax rate

Equation gives before - tax earnings necessary to cover the firm's fixed financial obligations. As fixed financial charges are added, the break-even point for zero EPS is increased by the amount of the additional fixed cost. Beyond the financial break-even point, increase in EPS is more than the proportionate increase in EBIT. This is illustrated in Table, which presents the EBIT-EPS relationship for the data in Example under the various EBIT assumptions given in the box

(i)	Rs.80,000 (4 per cent return on total assets)
(ii)	Rs.1,00,000 (5 per cent return on total assets)
(iii)	Rs.1,30,000 (4 per cent return on total assets)
(iv)	Rs.1,60,000 (4 per cent return on total assets)
(v)	Rs.2,00,000 (4 per cent return on total assets)

EBIT-EPS Analysis under Various EBIT Assumptions for the three financing Plans of Example

(i) EBIT = Rs. 80,000 (4 percent return on investments)

<i>Particulars</i>	<i>Financing Plans</i>		
	<i>A</i>	<i>B</i>	<i>C</i>
EBIT	80,000	80,000	80,000
Less: Interest	-----	25,000	60,000
EBIT	80,000	55,000	20,000
Less: Taxes	28,000	19,250	7,000
EAT	52,000	35,750	13,000
Less: Preference dividend	-----	-----	-----
EAT for equity-holders	52,000	35,750	13,000
EPS	2.6	2.38	1.3

(ii) EBIT = Rs. 1,00,000 (5 percent return)

<i>Particulars</i>	<i>Financing Plans</i>		
	<i>A</i>	<i>B</i>	<i>C</i>
EBIT	1,00,000	1,00,000	1,00,000
Less: Interest	-----	25,000	60,000
EBIT	1,00,000	75,000	40,000
Less: Taxes	35,000	26,250	14,000
EAT	65,000	48,750	26,000
Less: Preference dividend	-----	-----	-----
EAT for equity-holders	65,000	48,750	26,000
EPS	3.25	3.25	2.6

(iii) EBIT = Rs. 1,30,000 (6.5 percent return)

<i>Particulars</i>	<i>Financing Plans</i>		
	<i>A</i>	<i>B</i>	<i>C</i>
EBIT	1,30,000	1,30,000	1,30,000
Less: Interest	-----	25,000	60,000
EBIT	1,30,000	1,05,000	70,000
Less: Taxes	45,500	36,750	24,500
EAT	84,500	68,250	45,500
Less: Preference dividend	-----	-----	-----
EAT for equity-holders	84,500	68,250	45,500
			4.55
EPS	4.22	4.55	

(iv) EBIT = Rs. 1,60,000 (8 percent return)

<i>Particulars</i>	<i>Financing Plans</i>		
	<i>A</i>	<i>B</i>	<i>C</i>
EBIT	1,60,000	1,60,000	1,60,000
Less: Interest	-----	25,000	60,000
EBIT	1,60,000	1,35,000	1,00,000
Less: Taxes	56,000	47,250	35,000
EAT	1,04,500	87,750	65,000
Less: Preference dividend	-----	-----	-----
EAT for equity-holders	1,04,500	87,750	65,000
EPS	5.2	5.8	6.5

(v) EBIT = Rs. 2,00,000 (10 percent return)

<i>Particulars</i>	<i>Financing Plans</i>		
	<i>A</i>	<i>B</i>	<i>C</i>
EBIT	2,00,000	2,00,000	2,00,000
Less: Interest	-----	25,000	60,000
EBIT	2,00,000	1,75,000	1,40,000
Less: Taxes	70,000	61,250	49,000
EAT	1,30,000	1,13,750	91,500
Less: Preference dividend	-----	-----	-----
EAT for equity-holders	1,30,000	1,13,750	91,500
EPS	6.5	7.6	9.1

Table shows that when the EBIT level exceeds the financial break-even level (Rs.25,000, Rs.60,000 for financing alternatives, B, C respectively) EPS increases. The percentage increase in EPS is the greatest when EBIT is nearest the break-even point. Thus, in

Plan C, an increase of 25 per cent in EBIT (from Rs.80,000 to Rs.1,00,000) results in a 100 per cent increase in EPS (from Re 1.3 to Rs.2.6), whereas the percentage increase in EPS is only 40 per cent (from Rs.6.5 to Rs.9.1) as a result of the change in EBIT at higher levels from Rs.1,60,000 to Rs.2,00,000 (i.e. 25 per cent increase).

Tables show that the EPS for different financing plans at a given level of EBIT is equal. At EBIT levels above or below the given levels, the EPS is higher or lower. Thus, for alternatives A and C at the EBIT level of Rs.1,20,000 the EPS is the same, that is, Rs. 3.9. If EBIT is below this level, alternative A (ordinary shares) will provide higher EPS; above this level, the debt alternative (C) is better from the viewpoint of EPS.

The earnings per share (EPS) in alternatives A and B are the same at EBIT level of Rs.1,00,000. Above this, B plan would lead to higher EPS; at levels lower than this, financing plan A would provide higher EPS.

The debt alternative (B) gives higher EPS; at levels lower than this, financing plan A would provide higher EPS.

Operating Conditions and Business Risk

One very important factor on which the variability of EPS depends is the growth and stability of sales. As you may recall that EPS will fluctuate with fluctuations in sales. The magnitude of the EPS variability with sales will depend on the degrees of operating and financial leverages employed by the company. Firms with stable sales and favourable cost price structure and successful operating strategy will have stable earnings and cash flows and thus, can employ a high degree of leverage as they will not face difficulty in meeting their fixed commitments. The likely fluctuations in sales increase the business risk. A small change in sales can lead to a dramatic change in the earnings of a company when its fixed costs and debt are high. As a result, the shareholders perceive a high degree of financial risk if debt is employed by such companies. A company will get into a debt trap if operating conditions become unfavourable and if it lacks in focussed strategy:



The fluctuating raw materials and component prices cause ups and downs in the revenues and profits of a ship-building company. With the right operating strategy and appropriate prudent financing, a company can manage to sail safely. Hindustan Shipyard Limited (HSL), however, is finding it quite difficult to come out of the troubled waters due to huge borrowings. It has a total outstanding of Rs 554 crore: working capital loan Rs 138 crore, development loan for modernisation Rs 69 crore, and outstanding interest on these loans Rs 160 crore; cash credit Rs 62 crore, outstanding interest, cash credit Rs 65 crore and penal interest Rs 60 crore. How did this happen? HSL's trouble began when, between 1981 and 1982, Japanese and South Korean shipbuilders started offering "heavily subsidised rates" against the rates fixed by the Indian

government; based on international parity price. In effect, building ships turned out to be unviable for the yard. Further, HSL's overtime bill soared up, being a highly overstaffed company. It had 11,000 workers in 1990. A lack of strategy paved way for unchecked downfall. Orders continued declining, and became almost nil by 1988 and 1989. To tide over this, company borrowed funds, and since operating performance did not improve, the company fell deeper and deeper into debt trap. HSL is technically insolvent. The capital restructuring plan are on to put the company back on its feet.

Source: Messias Lionel, Hindustan Shipyard: A Dead Weight Debt, The Economic Times, 15 Feb, 1994.

Sales of the consumer goods industries show wide fluctuations; therefore, they do not employ a large amount of debt. On the other hand, the sales of public utilities are quite stable and predictable. Public utilities, therefore, employ a large amount of debt to finance their assets. The expected growth in sales also affects the degree of leverage. The greater the expectation of growth, the greater the amount of external financing needed since it may not be possible for the firm to cope up with growth through internally generated funds. A number of managers consider debt to be cheaper and easy to raise. The growth firms, therefore, may usually employ a high degree of leverage. Companies with declining sales should not employ debt in their capital structures as they would find difficulty in meeting their fixed obligations. Non-payment of fixed charges can force a company into liquidation. It may be noted that sales growth and stability is just one factor in the leverage decision; many other factors would dictate the decision. There are instances of a large number of high growth firms employing no or small amount of debt.

Cost of Capital and Valuation Approach

The cost of a source of finance is the minimum return expected by its suppliers. The expected return depends on the degree of risk assumed by investors. A high degree of risk is assumed by shareholders than debt-holders. In the case of debt-holders, the rate of interest is fixed and the company is legally bound to pay interest whether it makes profits or not. For ordinary shareholders, the rate of dividends is not fixed and the board of directors has no legal obligation to pay dividends even if the profits are made by the company. The loan of debt-holders is returned within a prescribed period, while shareholders will have to share the residue only when the company is wound up. This leads one to conclude that debt is a cheaper source of funds than equity. This is generally the case even when taxes are not considered. The tax deductibility of interest charges further reduces the cost of debt. The preference share capital is also cheaper than equity capital, but not as cheap as debt. Thus, using the component, or specific, cost of capital as a criterion for financing decisions and ignoring risk, a firm would always like to employ debt since it is the cheapest source of funds.

Pecking Order Hypothesis

The cost of equity includes the cost of new issue of shares and the cost of retained earnings. The cost of debt is cheaper than the costs of both these sources of equity funds. Considering the cost of new issue and retained earnings, the latter is cheaper because personal taxes have to be paid by shareholders on distributed earnings while no taxes are paid on retained earnings as also no floatation costs are incurred when the earnings are retained.

As a result, between the two sources of equity funds, retained earnings are preferred it has been found in practice that firms prefer internal finance. If the internal funds are not sufficient to meet the investment. outlays, firms go for external finance, issuing the safest security first. They start with debt, then possibly hybrid securities such as convertible debentures, then perhaps equity as a last resort. Myers has called it the pecking order theory since there is not a well-defined debt-equity target and there are two kinds of equity, internal and external, one at the top of the pecking order and one at the bottom.

Trade-off Theory

The specific cost of capital criterion does not consider the entire issue. It ignores risk and the impact on equity value and cost. The impact of financing decision on the overall cost of capital should be evaluated and the criterion should be to minimise the overall cost of capital, or to maximise the value of the firm. If we consider the tax shield advantage of debt (on account of interest tax deductibility), then debt would have a favourable impact on value and would help to reduce the overall cost of capital. It should, however, be realised that a company cannot continuously minimise its overall cost of capital by employing debt. A point or range is reached beyond which debt becomes more expensive because of the increased risk (financial distress) of excessive debt to creditors as well to shareholders. When the degree of leverage increases, the risk of creditors increases, and they demand a higher interest rate and do not grant loan to the company at all, once its debt has reached a particular level. Further, the excessive amount of debt makes the shareholders' position very risky. This has the effect of increasing the cost of equity. Thus, up to a point the overall cost of capital decreases with debt, but beyond that point the cost of capital would start increasing and, therefore, it would not be advantageous to employ debt further. So, there is a combination of debt and equity which minimises the firm's average cost of capital and maximises the market value per share. In practice, there is generally a range of debt-equity ratio within which the cost of capital is minimum or the value is maximum. As stated earlier in this chapter, for individual companies, this range can be found out empirically and the firm can operate safely within that range.

The valuation framework makes it clear that excessive debt will reduce the share price (or increase the cost of equity) and thereby lower the overall return to shareholders, despite the increase in EPS. The return of shareholders is made of dividends and appreciation in share prices, not of EPS. Thus, the impact of debt - equity ratio should be evaluated in terms of value, rather than EPS.

The difficulty with the valuation framework is that managers find it difficult to put into practice. It is not possible for them to quantify all variables. Also, the operations of the financial markets are so complicated that it is not easy to understand them. But this kind of analysis does provide insights and qualitative guidance to the decision maker.

The trade-off between cost of capital and EPS set the maximum limit to the use of debt. However, other factors should also be evaluated to determine the appropriate capital structure for a company.

Cash Flow Approach

One of the features of a sound capital structure is conservatism. Conservatism does not mean employing no debt or small amount of debt. Conservatism is related to the fixed charges created by the use of debt or preference capital in the capital structure and the firm's ability to generate cash to meet these fixed charges. In practice, the question of the optimum (appropriate) debt-equity mix boils down to the firm's ability to service debt without any threat of insolvency and operating inflexibility. A firm is considered prudently financed if it is able to service its Fixed charges under any reasonably predictable adverse conditions.

The fixed charges of a company include payment of interest, preference dividends and principal, and they depend on both the amount of loan securities and the terms of payment. The amount of fixed charges will be high if the company employs a large amount of debt or preference capital with short-term maturity. Whenever a company thinks of raising additional debt, it should analyse its expected future cash flows to meet the fixed charges. It is mandatory to pay interest and return the principal amount of debt. If a company is not able to generate enough cash to meet its fixed obligation, it may have to face financial insolvency. The companies expecting larger and stable cash inflows in the future can employ a large amount of debt in their capital structure. It is quite risky to employ fixed charge sources of finance by those companies whose cash inflows are unstable and unpredictable. It is possible for a high growth, profitable company to suffer from cash shortage if its liquidity (working capital) management is poor. We have examples of companies like BHEL, NTPC etc., whose debtors are very sticky and they continuously face liquidity problem in spite of being profitable. Servicing debt is very burdensome for them.

One important ratio which should be examined at the time of planning the capital structure

is the ratio of net cash inflows to fixed charges (debt-servicing ratio). It indicates the number of times the fixed financial obligations are covered by the net cash inflows generated by the company.

The greater the coverage, the greater is the amount of debt a company can use. However, a company with a small coverage can also employ a large amount of debt if there are not significant yearly variance in its cash inflows and a small probability of the cash inflows being considerably less to meet fixed charges in a given period. Thus, it is not the average cash inflows but the yearly cash inflows which are important to determine the debt capacity of a company. Fixed financial obligations must be met when due, not on an average or in most years but, always.' This requires a full cash flow analysis.

Debt Capacity

The technique of cash flow analysis is helpful in determining the firm's debt capacity. Debt capacity is the amount which a firm can service easily even under adverse conditions; it is the amount that the firm should employ. There may be lenders who are prepared to lend to you. But you should borrow only if you can service debt without any problem. A firm can avoid the risk of financial distress if it can maintain its ability to meet contractual obligation of interest and principal payments. Debt capacity, therefore, should be thought in terms of cash flows rather than debt ratios. A high debt ratio is not necessarily bad. If you can service high debt without any risk, it will increase shareholders' wealth. On the other hand, a low debt ratio can prove to be burdensome for a firm which has liquidity problem. A firm faces financial distress (or even insolvency) when it has cash flow problem. It is dangerous to finance a capital intensive project out of borrowings which has built in uncertainty about the earnings and cash flows. National Aluminium Company is an example of a wrong initial choice of capital structure, without analysing the company's debt servicing ability.



National Aluminium Company (NALCO), started in 1981, is the largest integrated aluminium complex in Asia of total investment of Rs 2,408 crore, borrowings from a consortium of European banks financed to the extent of \$ 830 million or Rs 1,119 crore (46.5 per cent). The loan was repayable by 1995. Aluminium is an electricity-intensive business; each tonne of aluminium needs over 15,000 kw of electricity. Since its commissioning in 1988, Nalco has exported substantial portion of its production since the domestic demand has been very low than what the company had projected at its inception. The falling international prices in last few years have eroded the company's profitability. The net profit of Rs 172 crore in 1989 dropped to Rs 14 crore in 1991-92. The 1,119 crore Eurodollar loan has appreciated to Re 2,667 crore inspite of having repaid Rs 644 crore. Due to profitability and liquidity problem and hit by the depreciating rupee and the liberalised exchange mechanism, the company is

forced to reschedule repayments of its debt by the year 2003 instead of 1995. Nalco's debt-equity ratio has increased from 1 : 1 to 2.7 : 1. The reasons for Nalco's plight is its decision to go for the production of aluminium which consumes heavy electricity in addition to alumina. The problem of power shortage led to the setting up of power plant which is proving very costly to the company. The overcapacity of aluminium production world wide and highly competitive prices have added to Nalco's woes. Nalco is trying to get out of its problems by attempting to diversify into value-added products. Nalco's fate can change if the domestic demand for aluminium picks up and international prices rise. The mounting debt of the company poses a question: Should you use heavy dose of debt (since it is available from certain sources) to finance investments in a business like aluminium which has worldwide over capacity, fluctuating international prices and expensive and short supply of electricity in the country in which it is set up? Debt would accentuate the financial crises when a company has built-in operating uncertainties

Source: Based on an article by Sudipt Dutta, NALCO: under a Debt Mountain, Business India, August 17-30, 1992, pp. 77-78.

Components of Cash Flows

The cash flows should be analysed over a long period of time, which can cover the various adverse phases, for determining the firm's debt policy. 'The cash flow analysis can be carried out by preparing proforma cash flow statements to show the firm's financial conditions under adverse conditions such as a recession. The expected cash flows can be categorised into three groups.

- Operating cash flows
- Non-operating cash flows
- Financial flows.

Operating cash flows relate to the operations of the firm and can be determined from the projected profit and loss statements. The behaviour of sales volume, output price and input price over the period of analysis should be examined and predicted.

Non-operating cash flows generally include capital expenditures and working capital changes. During a recessionary period, the firm may have to specially spend for the promotion of the product. Such expenditures should be included in the non-operating cash flows. Certain types of capital expenditure cannot be avoided even during most adverse conditions. They are necessary to maintain the minimum operating efficiency. Such irreducible, minimum capital expenditure should be, clearly identified.

Financial flows include interest, dividends, lease rentals, repayment of debt etc. They are further divided into: contractual obligations and policy obligations. Contractual obligations include those financial obligations, like interest, lease rentals and principal

payments, that are matters of contract and should not be defaulted. Policy obligations consist of those financial obligations, like dividends, that are at the discretion of the board of directors. Policy obligations are also called discretionary obligations.

The cash flow analysis may indicate that a decline in sales, resulting in profit decline or losses, discretionary obligations, may not necessarily cause cash inadequacy. This may be so because cash may be realised from permanent inventory and receivable. Also, some of the permanent current liabilities may decline with fall in sales and profits. On the other hand, when sales and profits are growing, the firm may face cash inadequacy as large amount of cash is needed to finance growing inventory and receivable. If the profits decline due to increase in expenses or falling output prices, instead of the decline in the number of units sold, the firm may face cash inadequacy because its funds in inventory and receivable will not be released. The point to be emphasised is that a firm should carry out cash flow analysis to get a clear picture of its ability to service debt obligations even under the adverse conditions, and thus, decide about the proper amount of debt in the capital structure. This can be done by examining the impact of alternative debt policies on the firm's cash flow ability. The firm should then choose the debt policy which it can service.

Cash Flow Analysis Versus EBIT-EPS Analysis

Is cash flow analysis superior to EBIT-EPS analysis? How does it incorporate the insights of the finance theory? The cash flow analysis has the following.

- It focuses on the liquidity and solvency of the firm over a long-period of time, even encompassing adverse circumstances. Thus, it evaluates the firm's ability to meet fixed obligations. It goes beyond the analysis of profit and loss statement and also considers changes in the balance sheet items.
- It identifies discretionary cash flows. The firm can thus prepare an action plan to face adverse situations.
- It provides a list of potential financial flows which can be utilised under emergency.
- It is a long-term dynamic analysis and does not remain confined to a single period analysis.

The most significant advantage of the cash flow analysis is that it provides a practical way of incorporating the insights of the finance theory. As per the theory, debt financing has tax advantage. But it also involves risk of financial distress. Therefore, the optimum amount of debt depends on the trade-off between tax advantage of debt and risk of financial distress, financial distress occurs when the firm is not in a position to meet its contractual obligations. The cash flow analysis indicates when the firm will find it difficult to service its debt. Therefore, it is useful in providing good insights to determine the debt capacity which helps to maximise the market value of the firm.

Cash Flow Analysis Versus Debt-Equity Ratio

The cash flow analysis clearly reveals that a higher debt-equity ratio is not risky if the company has the ability of generating substantial cash inflows in the future to meet its fixed financial obligations. Financial risk in this sense is indicated by the company's cash-flow ability, not by the debt-equity ratio. To quote Van Home;

...the analysis of debt-to-equity ratios alone can be deceiving, and analysis of the magnitude and stability of cash-flows relative to fixed charges is extremely important in determining the appropriate capital structure for the firm. To the extent that creditors and investors analyse a firm's cash-flow ability to service debt, and management's risk preferences correspond to those of investors, capital structure decisions made in this basis should tend to maximise share price.

The cash flow analysis does have its limitations. It is difficult to predict all possible factors which may influence the firm's cash flows. Therefore, it is not a fool-proof technique to determine the firm's debt policy.

EBIT-EPS Analysis

The EBIT-EPS analysis, as a method to study the effect of leverage, essentially involves the comparison of alternative methods of financing under various assumptions of EBIT. A firm has the choice to raise funds for financing its investment proposals from different sources in different proportions. For instance, it can (i) exclusively use equity capital (ii) exclusively use debt,

(iii) exclusively use preference capital, (iv) use a combination of (i) and (ii) in different proportions; (v) a combination of (i), (ii) and (iii) in different proportions, (vi) a combination of (i) and (iii) in different proportions, and so on. The choice of the combination of the various sources would be one which, given the level of earnings before interest and taxes, would ensure the largest EPS. Consider Example 2.

Example 2:

Suppose a firm has a capital structure exclusively comprising of ordinary shares amounting to Re 10,00,000. The firm now wishes to raise additional Rs 10,00,000 for expansion. The firm has four alternative financial plans:

- (A) It can raise the entire amount in the form of equity capital.
- (B) It can raise 50 per cent as equity capital and 50 per cent as 5% debentures.
- (C) It can raise the entire amount as 6% debentures.
- (D) It can raise 50 per cent as equity capital and 50 per cent as 5% preference capital.

Further assume that the existing EBIT are Rs 120, 000, the tax rate is 35 per cent, outstanding ordinary shares' 10,000 and the market price per share is Rs 100 under all the four alternatives.

Which financing plan should the firm select?

Solution

EPS under Various Financial Plans

	Financing plans			
	A	B	C	D
EBIT	1,20,000	1,20,000	1,20,000	1,20,000
Less Interest	-	25,000	60,000	-
Earnings before taxes	1,20,000	95,000	60,000	1,20,000
Taxes	42,000	33,250	21,000	42,000
Earning after taxes	78,000	61,750	39,000	78,000
Less preference dividend	-	-	-	25,000
Earnings available to ordinary shareholders	78,000	61,750	39,000	53,000
Number of Shares	20,000	15,000	10,000	15,000
Earnings per share (EPS)	3.9	4.1	3.9	3.5

The calculations in above table reveals that given a level of EBIT of Rs 1,20,000, the financing alternative B, which involves 75 per cent ordinary shares and 25 per cent debt, is the most favourable with respect to EPS. Another disclosure of the table is that although the proportion of ordinary shares in the total capitalization under the financing plan D is also 75 per cent, that is, equal to plan B, EPS is considerably different (lowest). The difference in the plans B and D is due to the fact that interest on debt is tax-deductible while the dividend on preference shares is not. With 35 per cent income tax, the explicit cost of preference shares would be higher than the cost of debt.

Table also indicates that the annual before-tax costs of the various financing plans are:

1. Financing Plan B Rs 25,000
2. Financing Plan C 60,000
3. Financing Plan D 38,426

Financing plan A involves no cost as there is no fixed financial charge. That the financing plan involves a specific amount of cost, is another way of saying that an equal amount of earnings before interest and taxes is necessary to cover the fixed financial charges. Since preference dividend is not tax-deductible, we must divide the total dividends by one, minus the tax rate, in order to obtain the EBIT necessary to cover these dividends as a financial charge. Assuming a 35 per cent tax rate, preference dividend of Rs 25,000 can be paid on EBIT of Rs 38,462. The fixed financial charge would, therefore, be higher. Earnings per share would be zero for plans B, C and D for the EBIT level of

Rs 25,000, Rs 60,000 and Rs 38,462 respectively. This level of EBIT may be termed as financial break even level of earnings before interest and tares because it represents the level of EBIT necessary for the firm to break even on its fixed financial charge. In other words, it is the level of EBIT at which the firm can satisfy all fixed financial charges (i.e. interest and preference dividend). EBIT less than this level will result in negative EPS. The financial break-even point can be determined by Eq.

$$\text{Financial break-even point} = I + \frac{PD}{1 - t}$$

where I = Annual interest charges

PD = Preference dividend

t = Tax rate

Equation gives before-tax earnings necessary to cover the firm's fixed financial obligations. As fixed financial charges are added, the break-even point for zero EPS is increased by the amount of the additional fixed cost. Beyond the financial break-even point, increase in EPS is more than the proportionate increase in EBIT.

- (i) Rs 80,000 (4 per cent return on total assets)
- (ii) 1,00,000 (5 per cent return on total assets)
- (iii) 1,30,000 (6.5 per cent return on total assets)
- (iv) 1,60,000 (8 per cent return on total assets)
- (v) 2,00,000 (10 per cent return on total assets)



Assumptions for the four Financing Plans

(i) EBTT a Re 80,000 (4 per cent return on investments) Financing Plans

	A	B	C	D
EBIT	80,000	80,000	80,000	80,000
Less interest	-	25,000	60,000	-
EBT	80,000	55,000	20,000	80,000
Less taxes	28,000	19,250	7,000	28,000
EAT	52,000	35,750	13,000	52,000
Less preference dividend	-	-	-	25,000
Ear for equity number	52,000	35,750	13,000	27,000
EPS	2.6	2.38	1.3	1.8

(ii) EBIT = Rs 1,00,000 (5 per cent return)

EBIT	1,00,000	1,00,000	1,00,000	1,00,000
Less interest	-	25,000	60,000	-
EBT	1,00,000	75,000	40,000	35,000
Less taxes	35,000	26,250	14,000	35,000
EAT	65,000	48,750	26,000	65,000
Less preference dividend	-	-	-	25,000
EAT for equity holders	65,000	48,750	26,000	40,000
EPS	3.25	3.25	2.6	2.67

(iii) EBIT = Rs 1,30,000 (6.5 per cent return)

EBIT	1,30,000	1,30,000	1,30,000	1,30,000
Less interest	-	25,000	60,000	-
EBT	1,30,000	1,05,000	70,000	1,30,000
Less taxes	45,500	36,750	24,500	45,500
EAT	84,500	68,250	45,500	84,500
Less preference dividend	-	-	-	25,000
EAT for equity holders	84,500	68,250	45,500	59,500
EPS	4.22	4.55	4.55	3.97

(iv) EBIT a Rs 1,60,000 (8 per cent return)

EBIT	1,60,000	1,60,000	1,60,000	1,60,000
Less interest	-	25,000	60,000	-
EBT	1,60,000	1,35,000	1,00,000	1,60,000
Less taxes	56,000	47,250	35,000	56,000
EAT	1,04,000	87,750	65,000	1,04,000
Less preference dividend	-	-	-	25,000
EAT for equity holders	1,04,000	87,750	65,000	79,000
EPS	5.2	5.8	6.5	5.3

(v) EBIT = Rs 2,00,000 (10 per cent return)

EBIT	2,00,000	2,00,000	2,00,000	2,00,000
Less interest	-	25,000	60,000	-
EBT	2,00,000	1,75,000	1,40,000	2,00,000
Less taxes	70,000	61,250	49,000	70,000
EAT	1,30,000	1,13,750	91,000	1,30,000
Less preference dividend	-	-	-	25,000
EAT for equity holders	1,30,000	1,13,750	91,000	1,05,000
EPS	6.5	7.6	9.1	7

It can be seen from above Table that when the EBIT level exceeds the financial break-even level (Rs 25,000, Rs 60,000 and Rs 38,462 for financing alternatives, B, C and D' respectively) EPS increases. The percentage increase in EPS is the greatest when EBIT is nearest the break-even point. Thus, in Plan C an increase of 25 per cent in EBIT (from Rs 80,000 to Rs 1,00,000) results in a 100 per cent increase in EPS (from Re 1.3 to Rs 2.6), whereas the percentage increase in EPS is only 40 per cent (from Rs 6.5 to Rs 9.1) as a result of the change in EBIT at higher levels from Rs 1,60,000 to Rs 2,00,000 (i.e. 25 per cent increase).

We can also see from Tables that the EPS for different financing plans at a given level of EBIT is equal. At EBIT levels above or below the given level, the EPS is higher or lower. Thus, for alternatives A and C at the EBIT level of Rs 1,20,000 the EPS is the same, that is, Rs 3.9. If EBIT is below this level, alternative A (ordinary shares) will provide higher EPS; above this level, the 1 debt alternative (C) is better from the viewpoint of EPS.

Between preference share (D) and ordinary share (A) alternatives, the EPS is equal (Rs 5.2) at Rs 1,60,000 EBIT level. above this level alternative D will give better EPS; while below it, alternative A. The earnings per share (EPS) in alternatives A and B are the same at EBIT level of Re 1,00,000. Above B would provide higher EPS.

The debt alternative (B) gives higher EPS for all levels of EBIT as compared to the preference share alternative (D).

Indifference Point

The EBIT level at which the EPS is the same for two alternative financial plans is referred to as the indifference point/level. The indifference point may be defined as the level of EBIT beyond which the benefits of financial leverage begin To operate with respect to earnings per share (EPS). In operational terms, if the expected level is to exceed the indifference level of EBIT, the use of fixed-charge source of funds (debt) would be advantageous from the viewpoint of EPS, that is, financial leverage will be favourable and lead to an increase in the EPS available to the shareholders. The capital structure should include debt. If, however, the expected level of the EBIT is less than the indifference point, the advantage of EPS would be available from the use of equity capital.

The indifference point between two methods of financing can be obtained mathematically (algebraic approach) as well as graphically.

Algebraic Approach Mathematically, the indifference point can be obtained by using the following symbols:

X = earnings before interest and taxes (EBIT) at the indifference point

- N_1 = number of equity shares outstanding if only equity shares are issued
 N_2 = number of equity shares outstanding if both debentures and equity shares are issued
 N_3 = number of equity shares outstanding if both preference and equity shares are issued
 N_4 = number of equity shares outstanding if both preference shares and debentures are issued
 I = the amount of interest on debentures
 P = the amount of dividend on preference shares
 t = corporate income tax rate
 Dt = tax on preference dividend

For a New Company The indifference point can be determined by using the following equations:

- (i) Equity shares versus debentures:

$$\frac{X(1-t)}{N_1} = \frac{(X-1)(1-t)}{N_2} \quad (a)$$

- (ii) Equity shares versus preference shares:

(b)

- (iii) Equity shares versus preference

(c)

- (iv) Equity shares versus preference shares and debentures:

(d)

For an Existing Company If the debentures are already outstanding, let us assume

i_1 = interest paid on existing debt, and I_2 = interest payable on additional debt, then the indifference point would be determined by Equation (e)

(e)

Example 3:

The financial manager of a company has formulated various financial plans to finance Rs 30,00,000 required to implement various capital budgeting projects:

- (i) Either equity capital of Rs 30,00,000 or Rs 15,00,000 108 debentures and Rs 15,00,000 equity;
- (ii) Either equity capital of Rs 30,00,000 or 13% preference shares of Rs 10,00,000 and Rs 20,00,000
- (iii) Either equity capital of Rs 30,00,00 or 13% preference capital of Rs 10,00,000, (subject to dividend tax of 10 per cent), Rs 10,00,000 1046 debentures and Rs 10,00,000 equity; and
- (iv) Either equity share capital of Rs 20,00,000 and 104b debentures of Rs 10,00,000 or 13% preference capital of Re 10,00,000. 10% debentures of Rs 8,00,000 and Rs 12,00,000 equity.

You are required to detetmine the indifference point for each financial plan, assuming 35 per cent corporate tax rate and the face value of equity shares, as Rs 100.

Solution

TABLE: Determination of Indifference Point

$$\frac{X(1-0.35) + 0.65(15,00,000)}{30,00,000} = \frac{X(1-0.35) + 1.3(15,00,000)}{15,00,000}$$

(i)

or

or

or $0.65X = 1.3X - \text{Rs } 1,95,000$

or $-0.65X = - \text{Rs } 1,95,000$

$$X = \frac{\text{Rs } 1,95,000}{0.65} = \text{Rs } 3,00,000$$

Confirmation table

	Equity financing	Equity + debt financing
EBIT	Rs 3,00,000	Rs 3,00,000
Less interest	-	1,50,000
Earning before taxes	3,00,000	1,50,000
Less taxes	1,05,000	52,500
Earnings for equity holders	1,95,000	97,500
Number of equity shares	30,000	15,000
EPS	6.5	6.5

$$(iii) \quad \frac{X(1-t)}{N_1} = \frac{X(1-I)(1-t)}{N_3}$$

or

or

or $X = \text{Rs } 6,00,000$ **Confirmation Table**

	Equity financing	Equity+Preference financing
EBIT	Rs 6,00,000	Rs 6,00,000
Less taxes	2,10,000	2,10,000
Earning after taxes	3,90,000	3,90,000
Less dividends on preference shares	-	1,30,000
Earnings for equity holders	3,90,000	2,60,000
Number of equity shares	30,000	20,000
EPS	13	13

$$(iii) \quad \frac{X(1-t)}{N_1} = \frac{(x-I)(1-t) - P(1+Dt)}{N_4}$$

or

or

$$X = \text{Rs } 4,80,000$$

Confirmation table

	Equity financing	Equity+debt+ Preference financing
EBIT	Rs 4,80,000	Rs 4,80,000
Less interest	-	1,00,000
Earning before taxes	4,80,000	3,80,000
Less taxes	1,68,000	1,33,000
Earnings after tax	3,12,000	2,47,000
Less dividends including dividend tax on preference shares	-	1,43,000
Earnings available for equity holders	3,12,000	1,04,000
Number of equity shares	30,000	10,000
EPS	10.4	10.4

$$(iv) \frac{(X - I)(1 - t)}{N_1} = \frac{(x - I)(1 - t) - P}{N_4}$$

or

$$\text{or } X = \text{Rs } 5,50,000$$

Confirmation table

	Equity financing	Equity + Preference + Debentures financing
EBIT	Rs 5,50,000	Rs 5,50,000
Less interest	1,00,000	80,000
Earning before taxes	4,50,000	4,70,000
Less taxes	1,57,500	1,64,500
Earnings after tax	2,92,500	3,05,500

Less dividends preference shares	-	1,30,000
Earnings for equity holders	2,92,500	1,75,500
Number of equity shares	20,000	12,000
EPS	14.625	14.625

Graphic Approach The indifference point can also be determined graphically. Figures 1 and 2 portray the graphic representation of financial plans (i) and (ii) of Example 7. The horizontal X-axis represents EBIT while EPS is represented on the Y-axis.

In order to graph the financial plan, two sets of EBIT-EPS coordinates are required. The EPS values associated with EBIT values of Rs 2,00,000 and Rs 6,00,000 are calculated and plotted on the graph paper under each financial plan in case of Figure 1. It may be noted that 100 per cent equity financing plan starts from origin (O) because EPS would be zero if EBIT is zero. However, EBIT required to have the value of the EPS as zero is Rs 1,50,000, that is, the interest charges payable on 105 debentures of Rs 15,00,000. Therefore, the starting point of 50 per cent equity financing plan is away from the point of the origin (i.e. it starts from Rs 1.5 lakh). The point at which the two lines intersect is the indifference point (IP). When we draw a perpendicular to the X-axis from the point of intersection, we have EBIT required for the IF. A line drawn from the point of intersection and joined with the Y-axis determines the EPS at the indifference point -



An important point to be remembered in relation to the drawing of 33 per cent preference share financial plan (Fig. 2) is that EPS would not be zero if the firm's EBIT is Rs 1,30,000, because dividend payable on preference share is not tax-deductible. The firm must earn so much more than

Rs 1,30,000 that it is left with Rs 1.30,000 after paying taxes. This amount can be calculated dividing by $(1 - t)$. The required amount is Rs 2,00,000 $(Rs\ 1,30,000) \div$

(1-0.35). Thus, the starting point of preference share financial plan would be Rs 2 lakh.

The indifference points of Figs. 1 and 2 correspond to what we have determined through the algebraic approach. But the utility of the EBIT-EPS chart lies in its being more informative regarding the EBIT-EPS relationship. It gives a bird's eye view of EPS at various Levels of EBIT. The EPS value at the estimated level of EBIT can be promptly ascertained. Moreover, it more easily explains why an equity financing plan is better than other plans requiring debenture and/or preference shares for the EBIT level below the BEP. For instance, Fig 2. indicates that for all EBIT levels below Rs d lakh, the EPS under equity alternative is greater than 33 per cent preference share financing plan and for all EBIT levels above Rs 6 lakh, the EPS is greater under 33 per cent financing plan than 100 per cent equity financing. The IP can be compared with the most likely level of EBIT. If the likely level of EBIT is more than the IF, the use of fixed cost financing plan may be recommended, otherwise equity plan would be more suitable. To sum up, the greater the likely level of EBIT than the indifference point, the stronger is the case for using levered financial

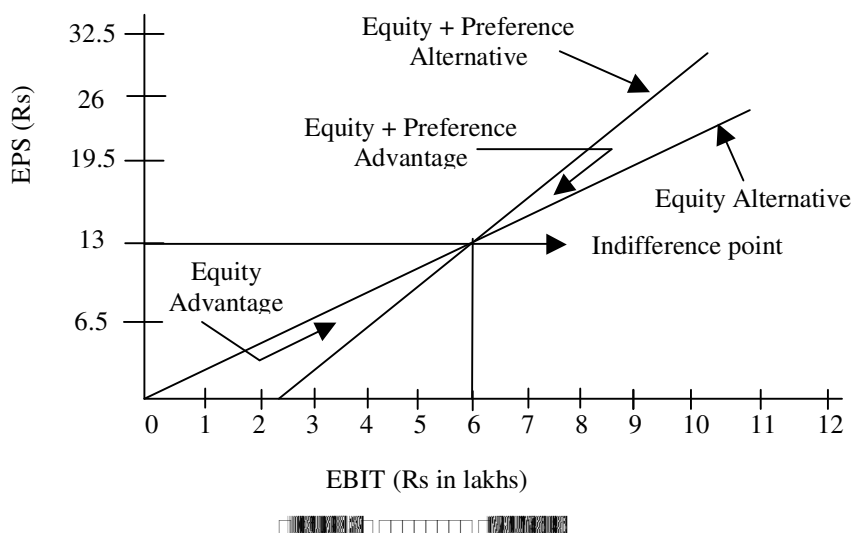

plans to maximise the EPS. Conversely, the lower the likely level of EBIT in relation to the indifference point. the more useful the unlevered financial plan would be from the view point of EPS. In other words, financial leverage will be favourable and shareholders will get higher EPS if the return on total investment is more than the fixed cost (interest and preference dividend). If the return is less than the fixed financial charge, the EPS will decline with the use of debt and the leverage will be unfavourable. The financial leverage will have no effect on EPS in case the return on investment is exactly equal to the fixed financial costs.

The indifference point may be computed in another way using market value as the basis. Since the operational objective of financial management is the maximisation of share prices, the market price of shares of a firm with two different financial plans

should be identical. Thus, on the basis of level of EBIT which ensures identical market price for alternative financial plans, the indifference point can be symbolically computed by following Equation.

$$P/E_1 \left[\frac{X(1-t)}{N_1} \right] = P/E_2 \left[\frac{(x-1)(1-r) - D_p}{N_2} \right]$$

where PE1 = P/E ratio of levered plan and P/E2 = P/E ratio of unlevered plan.

Determine the indifference point at which market price of equity shares of a corporate firm will be the same from the following data:

1. Funds required, Rs 50,000.
2. Existing number of equity shares outstanding, 5,000 @ Rs 10 per share.
3. Existing 10% debt, Rs 20,000
4. Funds required can be raised either by (a) issue of 2,000 equity shares, netting Rs 25 per share or (b) new 15 per cent debt.
5. The P/E ratio will be 7 times in equity alternative and 6 times in debt alternative.
6. Corporate tax rate, 35 per cent.

Solution

$$P/E_1 \left[\frac{(x - I_1)(1-t)}{N_1} \right] = P/E_2 \left[\frac{(x - 1 - I_2) - (1-t)}{N_2} \right]$$

$$7 \left[\frac{(x - \text{Rs } 2,000)0.65}{7,000} \right] = 6 \left[\frac{(x - \text{Rs } 9,500)0.65}{5,000} \right]$$

$$\text{or } \frac{0.65x - \text{Rs } 1,300}{7,000} = \frac{0.65x - \text{Rs } 6,175}{5,000}$$

$$\text{or } 5(4.55x - \text{Rs } 9,100) = 7(3.9 \times \text{Rs } 37,050)$$

$$\text{or } 4.55x = \text{Rs } 2,13,850, \text{ i.e. } x = \text{Rs } 47,000$$

Confirmation table

	15% Debt issue	Equity issue
EBIT	Rs 47,000	Rs 47,000
Less interest	9,500	2,000
Earning before taxes	37,500	45,000

Less taxes	13,125	15,750
Earnings after tax	24,375	29,250
Number of equity shares	5,000	7,000
Earnings per share	4.875	4.18
P/E ratio (times)	6	7
Market price of the share	29.25	29.25

ROI-ROE Analysis

In the preceding section we looked at the relationship between EBIT and EPS under alternative financing plans. Pursuing a similar line of analysis, we may look at the relationship between the return on investment (ROI) and the return on equity (ROE) for different levels of financial leverage.

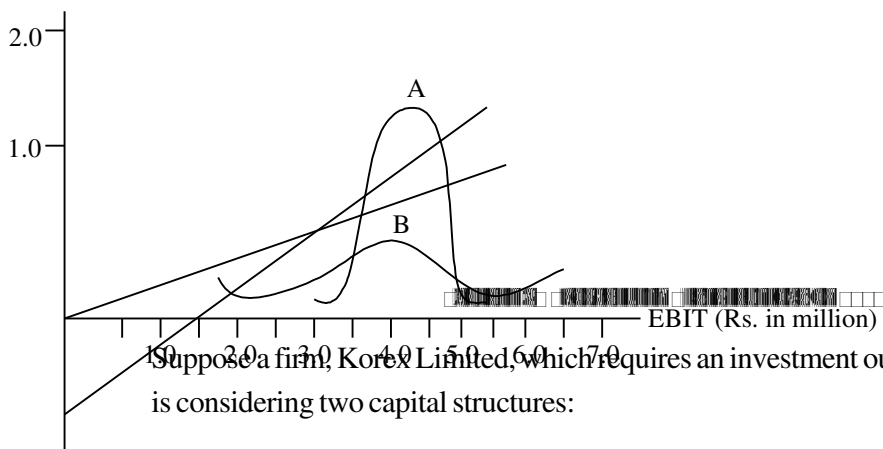

Capital Structure A (Rs in million)		Capital Structure B (Rs in million)	
Equity	100	Equity	50
Debt	0	Debt	50

While the average cost of debt is fixed at 10 per cent, the ROI (defined as EBIT divided by total assets) may vary widely. The tax rate of the firm is 50 per cent.

Based on the above information, the relationship between ROI and ROE (defined as equity earnings divided by net worth) under the two capital structures, A and B, would be as shown in Exhibit graphically the relationship is shown in Exhibit

	Capital Structure A					Capital Structure B				
ROI	5%	10%	15%	20%	25%	5%	10%	15%	20%	25%
EBIT (Rs in million)	5	10	15	20	25	5	10	15	20	25
Interest	0	0	0	0	0	5	5	5	5	5
Profit after tax	5	10	15	20	25	0	5	10	15	20
Tax	2.5	5	7.5	10	12.5	0	2.5	5	7.5	10
Profit after tax	2.5	5	7.5	10	12.5	0	2.5	5	7.5	10
Return an equity	2.5%	5%	7.5%	10%	12.5%	0%	5%	10%	15%	20%

Relationship between ROI and ROE Under Alternative Capital Structure

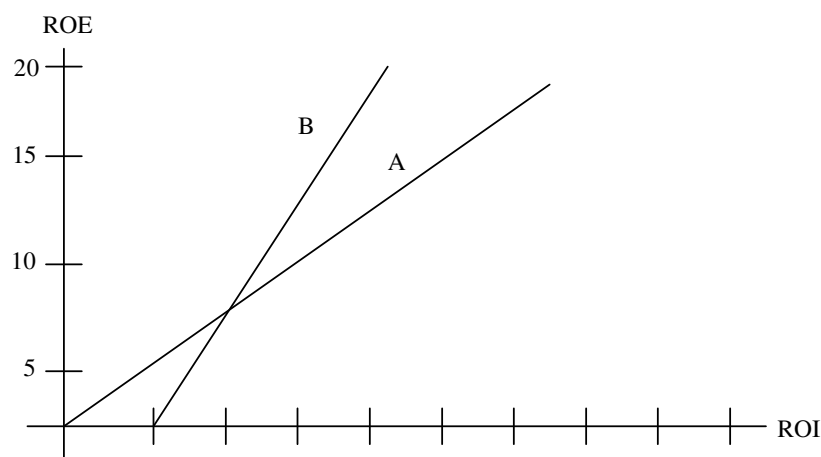

Looking at the relationship between ROI and ROE we find that:

1. The ROE under capital structure A is higher than the ROE under capital structure B when ROI is less than the cost of debt.
2. The ROE under the two capital structures is the same when ROI is equal to the cost of debt. Hence the indifference (or breakeven) value of ROI is equal to the cost of debt.
3. The ROE under capital structure B is higher than the ROE under capital structure A when ROI is more than the cost of debt.

Mathematical Relationship

The influence of ROI and financial leverage on ROE is mathematically as follows:

$$\text{ROE} = [\text{ROI} + (\text{ROI} - r) D/E] (1 - t)$$

where ROE = return on equity

ROI = return on investment

r = cost of debt

D/E = debt-equity ratio

t = tax rate

Applying the above equation to Korex Limited when its D/E ratio is 1, we may calculate the value of ROE for two values of ROI, namely, 15 per cent and 20 per cent.

ROI = 15%

ROE = $15 + (15 - 10) \cdot 1 \cdot (0.5) = 12.5\%$

ROI = 20 per cent

ROE = $[20 + (20 - 10) \cdot 1] \cdot (0.5) = 15.0\%$

These results, as expected, are in conformity with our earlier analysis.

Assessment of Debt Capacity

Employment of debt capital entails two kinds of burden: interest payment and principal repayment. To assess a firm's debt capacity we look at its ability to meet these committed payments. This may be judged in terms of:

- Coverage ratios
- Coverage Ratios
- Inventory of resources

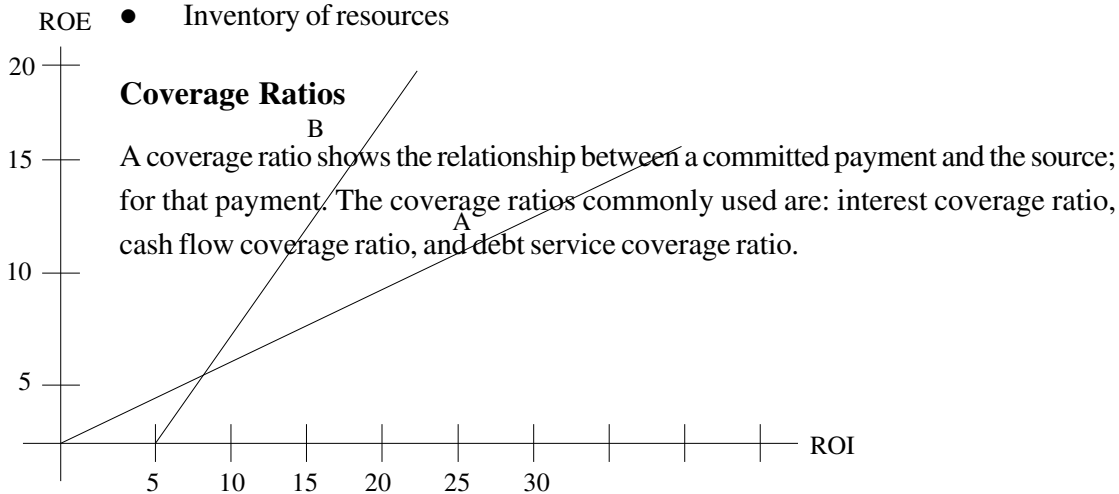

Interest Coverage Ratio The interest coverage ratio (also referred to as the times interest earned ratio) is simply defined as:

$$\frac{\text{Earnings before interest and taxes}}{\text{Interest on debt}}$$

To illustrate, suppose the most recent earnings before interest and taxes (EBIT) for Vitrex Company were Rs. 120 million and the interest burden on all debt obligations were Rs. 20 million. The interest coverage ratio, therefore, would be $120/20 = 6$. What does it imply? It means that even if EBIT drops by 83% per cent, the earnings of Vitrex Company cover its interest payment.

Though somewhat commonly used, the interest coverage ratio has several deficiencies: (i) It concerns itself only with the interest burden, ignoring the principal repayment obligation. (ii) It is based on a measure of earnings, not a measure of cash flow. (iii) It is difficult to establish a norm for this ratio. How can we say that an interest coverage ratio of 2, 3, 4, or any other is adequate?

Cash Flow Coverage Ratio This may be defined as:

$$\frac{\text{EBIT} + \text{Depreciation} + \text{Other non-cash charges}}{\text{Interest on debt} + \frac{\text{Loan repayment instalment}}{(1 - \text{Tax rate})}}$$

To illustrate, consider a firm:

Depreciation	Rs. 20 lakhs
EBIT	Rs. 120 lakhs
Interest on debt	Rs. 20 lakhs
Tax rate	50%
Loan repayment instalment	Rs. 20 lakhs

The cash flow coverage ratio for this firm is:

It may be noted that in calculating the cash flow coverage ratio the loan repayment amount in the denominator is adjusted upward for this tax factor because the loan repayment amount, unlike the interest, is not a tax-deductible payment.

The cash flow coverage ratio is a distinct improvement over the interest coverage ratio in measuring the debt capacity; it covers the debt's service burden fully and it focuses on

cash flows. However, it too is characterised by the problem of establishing a suitable norm for judging its adequacy.

Debt Service Coverage Ratio Financial institutions which provide the bulk of long-term debt finance judge the debt capacity of a firm in terms of its debt service coverage ratio. This is defined as:

$$DSCR =$$

where DSCR = debt service coverage ratio,

PAT_i, = profit after tax for year i

DEP_i, = depreciation for year i

INT_i = interest on long-term loan for year i

LRI_i = loan repayment instalment for year i

n = period of the loan

To illustrate the calculation of debt service coverage ratio, consider a project with the following financial characteristics.

	<i>(Rs. in lakhs)</i>									
Year	1	2	3	4	5	6	7	8	9	10
Profit after tax	-2.0	10.0	20.0	25.0	30.0	40.0	40.0	50.0	55.0	55.0
Depreciation	12.0	10.8	9.72	8.75	7.87	7.09	6.38	5.74	5.17	4.65
Interest on long-term loan	17.6	17.6	17.05	14.85	12.65	10.45	8.25	6.05	3.85	1.65
Loan repayment Instalment	-	-	20	20	20	20	20	20	20	20

$$DSCR = \sum_{i=1}^{10} \frac{PAT_i + DEP_i + INT_i}{INT_i + LRI_i} / 10 = 19.65 / 10 = 1.965$$

Normally, financial institutions regard a debt service coverage ratio of 2 as satisfactory. If this ratio is significantly less than 2 and the project is otherwise desirable, a term loan of a longer maturity may be provided. By the same token, if this ratio is significantly more than 2, the maturity period of the loan may be shortened.

Probability of Cash Insolvency

In assessing the debt capacity of a firm the key question is whether the probability of cash insolvency associated with a certain level of debt is acceptable to the management and not so much whether a particular coverage norm is satisfied. Gordon Donaldson, advocating the use of such an approach, has suggested that the analysis of debt capacity may broadly involve the following steps:

1. Determination of the tolerance limit on the probability of cash insolvency.
2. Specification of the probability distribution of cash flows under adverse conditions (recessionary conditions).
3. Calculation of the fixed charges associated with various levels of debt,
4. Estimation of the debt capacity of the firm as the highest level of debt which is acceptable, given the tolerance limit, the probability distribution, and the fixed charges defined above,

This kind of analysis may be illustrated with the help of information for Phoenix Limited which is given below:

Tolerance Limit The management of the company does not want the likelihood of cash insolvency to exceed 5 per cent even in adverse (recessionary) conditions.

Probability Distribution Under adverse (recessionary) conditions the company would have an expected cash inflow of Rs. 50 million with a standard deviation of Rs. 30 million. The cash inflow would be normally distributed. The initial cash balance of the company is Rs. 1.26 million.

Fixed Charges The annual fixed charges associated with various levels of debt would be as follows:

Level of Debt	Annual Fixed Charges
Up to Rs. 5 million	Rs 0.25 million for every Rs 1 million of debt
Between Rs. 5 million and Rs. 10 million	Rs 0.26 million for every Rs. 1 million debt
Between Rs. 10 million and Rs. 15 million	Rs 0.27 million for every Rs. 1 million of debt.

Debt Capacity Given the above information the debt capacity may be established as follows:

1. Since the cash inflow is normally distributed the following variable has a standard normal distribution (Z distribution):

$$\frac{\text{Cash inflow} - \text{Mean value of cash inflow}}{\text{Standard deviation of cash inflow}}$$

2. The Z value corresponding to 5 per cent cumulative probability (which reflects the risk tolerance of the management) is - 1.653
3. Since $m = \text{Rs. } 50 \text{ million}$, $s = \text{Rs. } 30 \text{ million}$, and the Z value corresponding to the risk tolerance limit is -1.645, the cash available from the operations of the firm to service the debt is equal to X: which is defined as:

$$\frac{X - 50}{30} = -1.645$$

This means $X = \text{Rs. } 0.65$ million

4. The total cash available for servicing the debt will be equal to:

Rs 0.65 million (cash available from operations)

Rs. 1.26 million (initial cash balance)

= Rs. 1.91 million.

5. The level of debt that can be serviced with Rs. 1.91 million is as follows:

Amount	Annual fixed charges
Rs. 5.00 million	$0.25 \times 5.00 = \text{Rs. } 1.25$ million
Rs. 2.54 million	$0.26 \times 2.54 = \text{Rs } 0.06$ million
Rs. 7.54 million	Rs. 1.91 million

Inventory of Resources

Normally, when a firm's debt capacity is being assessed, certain coverage ratios, as discussed above, are looked into. In addition, firms resorting to more sophisticated analysis try to estimate the likelihood of cash insolvency (or cash inadequacy under recessionary conditions for different levels of debt for establishing their? debt, capacity it would be helpful to supplement such analyses by estimating potential sources of liquidity available to the firm to meet possible cash drains. These sources, as suggested by Gordon Donaldson, may be divided into three categories:

Uncommitted Reserves These are reserves maintained primarily as an insurance against adverse developments and not earmarked for any specific purpose. Usually these reserves can be tapped at a relatively short notice.

Reduction of Planned Outlays Resources may be made available by effecting reductions and cuts in proposed outlays and disbursements. Typically such reductions and cuts, while they release resources, tend to impair the profitability

Liquidation of Assets In order to tide over an unmanageable drain of cash, the firm may raise resources by liquidating some of its assets.

Following Table drawn from an article written by Gordon Donaldson' shows the above mentioned categories along, with their subclassifications.

Table: Inventory of Resources

Capital Structure Policies in Practice

There is clearly some value to debt financing, and firms use different amounts of debt depending on their tax rates, their asset structures, and their inherent riskiness.

Unfortunately, capital structure theory does not provide neat, clean answers to the question of the optimal capital structure. Thus, many factors must be considered when actually choosing a firm's target capital structure, and the final decision will be based on both analysis and judgement.

If a firm has perpetual cash flows, then a relatively simple model can be used to value the firm at different capital structures. In theory, this model can be used to find the capital structure that maximises the firm's stock price. However, the inputs to the model are very difficult, if not impossible, to estimate. Further, most firms are growing, so they do not have constant cash flows.

Since one cannot use only quantitative models to determine the optimal capital structure, managers must also consider such qualitative factors as long-run viability, managerial conservatism, lender institutions attitudes, reserve borrowing capacity, managerial constraints, control, asset structures, profitability and taxes.

Wide variations in capital structure exist, both across industries and among individual firms within industries. The variations across industries can be explained to a large extent by the economic fundamentals of the industry and the variations across companies in the same industry by their operating fundamentals and management decisions.

- Indian corporates employ substantial amount of debt in their capital structure in terms of the debt-equity ratio as well as total debt to total assets ratio. Nonetheless, the foreign controlled companies in India use less debt than the domestic companies. The dependence of the Indian corporate sector on debt as a source of finance has over the years declined particularly since the mid-nineties.
- The corporate enterprises in India seem to prefer long-term borrowings over short-term borrowings. Over the years, they seem to have substituted short-term debt for long-term debt. The foreign controlled companies use more long-term loans relatively to the domestic companies.
- As a result of debt-dominated capital structure, the Indian corporates are exposed to a very high degree of total risk as reflected in high degree of operating leverage and financial leverage and, consequently, are subject to a high cost of financial distress which includes a broad spectrum of problems ranging from relatively minor liquidity shortages to extreme cases of bankruptcy. The foreign controlled companies, however, are exposed to lower overall risk as well as financial risk.
- The debt service capacity of the sizeable segment of the corporate borrower as measure by (i) interest coverage ratio and (ii) debt service coverage ratio is inadequate and unsatisfactory.
- Retained earnings are the most favoured source of finance. There is significant difference in the use of internally generated funds by the highly profitable corporates relative to the low profitable firms. The low profitable firms use different form of debt funds more than the highly profitable firms.
- Loan from financial institutions and private placement of debt are the next most widely used source of finance. The large firms are more likely to issue bonds in the market than small corporates.
- The hybrid securities is the least popular source of finance amongst corporate India. They are more likely to be used by low growth firms. Preference shares are used more by public sectors units and low growth corporates.

Chapter-12

Dividend Decisions

Once a company has been formed and continues in operation, it should have earnings to retain or to distribute to the owners. This disposition of these earnings is a fundamental problem of financial management. In organisations, which are closely held, the problem is not there because the shareholders run the organisation themselves and can dictate the terms. In large organisations, however, the situation is different. Here the policy concerning the distribution of earnings is normally delegated to the directors of the company by the shareholders. However, they retain the final approval authority and the dividend is paid only after final approval of the shareholders in the Annual General Meeting. Once it is approved in the AGM, the dividend cheque is sent to the shareholders within a month and is normally payable in the city of residence of the shareholder so as to expedite the payment to him.

The management of an enterprise has an important financial decision to decide about the disposition of income left after meeting all business expenses. Generally, of the total business profits, a portion is retained for reinvestment in the business and rest is distributed to shareholders as dividend.

Organisations finance a large portion of their needs internally, that is, from retained earnings and from non-cash charges, such as depreciation, to the extent that they are covered by earnings. To the extent that the organisations are dependent on internal funds to meet their capital and other requirements, there could be a concern that the funds retained may not be used as productively as they might be elsewhere. In a small concern (especially proprietorship/ partnership) the owners are very likely to compare the return to be gained from retained earnings in the business and the return that they might make from some other investment of equivalent risk. Because they do not participate directly in formulating dividend policy, shareholders in large companies do not have the chance to make this direct comparison. Thus earnings that are retained in many companies have not met a "market test" and therefore we may not be sure that they should have been retained.

The objective of the dividend policies should be to divert funds from the less productive operations to more productive ones. But it is very difficult for the directors and the management to accept the fate of a declining company and to allow the gradual liquidation of their company, as would be suggested by economic thought. If the management

finds itself in a declining industry, they want to retain more funds for the business operations and pay out less so as to conserve the funds. Something that is not beneficial for the shareholders. They also try to retain more to fund other more profitable investments so the continuity of the corporation can be maintained.

The important issue is to decide the portion of profit to declare for dividend pay out and for retaining in business. The dividend policy decision involves two questions:

- What fraction of earnings should be paid out, on average, over time? and
- Should the firm maintain a steady, stable dividend growth rate?

Before we try and answer these questions, let us look at the theories related to dividend decisions. After that we will look at the empirical evidence of the same.

Theories of Dividends

Traditional Position: MM Model

Dividend Irrelevance: Miller and Modigliani

Miller and Modigliani developed the dividend irrelevance theory, which holds that a firm's dividend policy has no effect either on the value of the firm or on its cost of capital (Do you remember the capital structure theories?). MM used the same five assumptions as they used in the debt policy:

1. There are no personal or corporate income taxes.
2. There are no share floatation or transaction costs.
3. Investors are indifferent between a rupee of dividends and a rupee of capital gains.
4. The firm's capital investment policy is independent of its dividend policy.
5. Investors and managers have the same set of information (symmetric information) regarding future investment opportunities.

The above assumptions that give us MM1 actually yield a far more powerful result than just the irrelevancy of debt policy. They imply that the entire financial policy followed by the organisation is irrelevant for its valuation; all that matters is the organisation's portfolio of investment projects. Hence, capital structure, dividend policy and risk management activities (among other things) are all ineffectual in altering organisation's value.

Consider a firm that has fixed its investment policy. In each period, it is left with a net cash flow, which is simply the difference between operating income and investment costs. A straightforward corporate dividend policy would just be to pay out this net

cash flow to the holders of the equity. However, consider a firm that desires to pay a dividend in excess its cash flow. In order to do this, the firm can raise funds by issuing new equity. Alternatively, the firm could borrow money, which assuming perfect capital markets is a transaction with the NPV of zero. Conversely, a firm wishing to pay a smaller dividend might spend the balance of its net cash flow on repurchasing equity. The key idea here is that a firm can choose whatever pay-out policy it desires, funding the policy through share issues/ repurchases; hence; dividend policy is irrelevant.

In other words, they reasoned that the value of a firm is determined by its basic earning power and its risk class, and, therefore, that a firm's value depends on its asset investment policy rather than on how earnings are split between dividends and retained earnings. MM demonstrated, under the light of above mentioned assumptions, that if a firm pays higher dividends, then it must sell more shares to new investors, and the value of the shares given to the new investors is exactly equal to the dividends paid out.

From the individual investor's point of view we can show that the dividend policy is irrelevant too. To do this we can use a similar argument to that employed when we said that shareholders are indifferent to capital structure changes; shareholders are indifferent to dividend policy as, through appropriate purchases or sales of shares, they can replicate any dividend policy they wish. Hence, investors will not value a firm paying a particular dividend policy different to any other firm such that firm value does not depend on dividends.

The MM assumptions are not realistic, and they obviously do not hold precisely. Firms and investors do pay income taxes, firms do incur floatation costs, and investors do incur transaction costs. Further, managers often have better information than outside investors. Thus, MM's theoretical conclusions on dividend irrelevance may not be valid under real-world conditions.

Radical Models

Bird-in-the-hand Theory: Gordon and Lintner

Gordon and Lintner argue that the cost of equity increases as the dividend payout is reduced, because investors can be more sure of receiving dividends than the capital gains that are expected to result from retained earnings. Therefore, the theory holds that the value of the firm will be maximised by a high dividend payout ratio, because investors regard actual dividends as being less risky than potential capital gains.

This means that this theory is in direct contrast with MM theory of dividend irrelevance.

Tax Preference Theory: Litzenberger and Ramaswamy

If a firm retains its earnings then the share gains in value in the market which results in capital gains for the shareholder. If the company pays out dividend the share value does not increase but the shareholder gains cash. In case of getting dividends the shareholder has effectively paid only 10% tax while in the case of capital gains he would be in the 20% tax bracket. This means that he would prefer to get dividends rather than get capital gains but if the capital gains are disproportionate he would prefer capital gains rather than dividends.

The tax preference theory holds that the value of the firm will be maximised by a low dividend payout, because investors pay lower effective taxes on capital gains than on dividends internationally. In India the situation is different and the shareholder would prefer dividends rather than capital gains.

The above analysis suggests that there is a preference for current dividends - that, in fact, there is a direct relationship between the dividend policy of a firm and market value. The argument goes on the lines that investors are generally risk averse and therefore attach less risk to current as opposed to future dividends or capital gains. In the words of John E. Kirshmann "Of two stocks with identical earnings, records and prospects but the one paying a larger dividend than the other, the former will undoubtedly command a higher price merely because shareholder's prefer present to future values. Myopic vision plays a part in the price-making process. Stockholders often act upon the principle that a bird in hand is worth two in the bush and for this reason are willing to pay a premium for the stock with the higher dividend rate, just as they discount the one with the lower dividend rate."

Benjamin Graham and David L. Todd, authors of the well-known security valuation book 'Security Analysis' also say that "The typical investor would most certainly prefer to have his dividend today and let tomorrow take care of itself. No instances are on record in which the withholding of dividends for the sake of future profits has been hailed with such enthusiasm as to advance the price of the stock. The direct opposite has invariably been true. Given two companies in the same general position and with the same earnings power, the one paying the larger dividend will always sell at the higher prices."

These observations are supported by the share valuation models that have been developed using the dividend payouts. Walter's model (which is actually an adaptation of the Gordon's model) are given below.

Walter's Model

Walter's model is one of the earliest dividend models is adapted from the Gordon's model for valuation of an equity share.

Gordon's model gives us the cost of internally generated common equity, k_s

$$k_s = \frac{\text{dividend in year 1}}{\text{market price}} + \left(\frac{\text{annual growth}}{\text{in dividends}} \right)$$

$$k_s = \frac{D_1}{P_0} + g$$

which can also be written as:

$$P_0 = \frac{D_1}{K_s - g}$$

Hence the dividend growth rate can be subtracted from the cost of equity capital to get the present value of the share price which should be the market price according to the formula.

Walter adjusted the above formula to reflect the earnings retention and rewrote the equation as:

$$P_0 = \frac{D_1}{K_s - rb}$$

Here, b is the percentage of earnings retained, and r is the expected rate of profitability from the retained earnings.

It follows from the formula that if the earnings retained gives you a higher return than the cost of capital, you would get a positive return and the share price would go up and otherwise the share price would come down because of the higher earnings retained.

Walter's formula highlights the return on retained earnings relative to the average market rate of return on investment (market capitalisation rate) as the critical determinant of dividend policy. A high rate of return on retained earnings indicates a low payout ratio, whereas a low rate relative to the market average indicates the desirability of a high payout ratio to increase the price of the equity shares.

Therefore to increase the share valuation a company may go in for a higher payout in the form of a dividend. But this reduces the growth rate of the dividends (keeping all other things constant) bringing it back to square one.

Also a high dividend policy may force the firm to go to the capital markets more often. In practice, most firms try to follow a policy of paying a steadily increasing dividend. This policy provides investors with stable, dependable income, and if the signalling theory is correct, it also gives investors information about management's expectations for earnings growth.

Most firms use the residual dividend model to set a long run target payout ratio which permits the firm to satisfy its equity requirements with retained earnings.

Factors Affecting Dividend Policies

Fund Requirements: Generally, the firms that have substantial investment opportunities and consequently considerable funding needs to keep their payout ratio rather low to conserve resources for growth. On the other hand, firms which have rather limited investment avenues usually pursue a more generous payout policy.

Bond indentures: Debt contracts often restrict dividend payments to earnings generated after the loan was granted. Also, debt contracts frequently stipulate that no dividends can be paid unless the current ratio, the interest coverage ratio, and other safety ratios exceed stated minimum values.

Preference share restrictions: Typically, equity dividends cannot be paid if the company has omitted (not paid) dividend on its preference shares. The preference dividends arrears must be paid before equity dividends can be resumed.

Availability of cash: Cash dividends can only be paid with cash. Thus, a shortage of cash in the bank can restrict dividend payments. However, unused borrowing capacity can offset this factor.

Control: If the management is concerned about maintaining control, it may be reluctant to sell new shares, hence it may retain more earnings than it otherwise would. This factor is especially important for small, closely held firms.

Differences in the cost of External equity and Retained Earnings: Cost of external equity is obviously more than the cost of retained earnings due to the floatation costs of raising the former. Therefore, if the company has some expansion plans which involves capital expenditure it is very likely that it would prefer a low dividend payout ratio.

Signalling: As we have noted earlier, managers can and do use dividends to signal the firm's situation. For example, if management thinks that investors do not fully understand how well the firm is doing, and how good its prospects are, it may increase the dividend by more than that was anticipated in an effort to boost the stock price.

Shareholder Preference: When equity shareholders have greater interest in current dividend vis-a-vis capital gains, the firm may be inclined to follow a liberal dividend payout policy. While the preference of equity shareholders has some influence over the dividend policy of the firm, the dividend policy may have a greater impact on the kind of shareholders who are attracted towards it. Each firm is likely to draw itself a "clientele" which finds its payout policy attractive.

As mentioned above certain formal and casual empirical observations point in the opposite direction. Perhaps the most famous set of results on actual dividend policy was compiled and presented by John Lintner. Lintner interviewed the management of a sample of US corporations in order to determine what lay behind their dividend-setting decisions. His research led to the four following stylised facts:

- Managers seem to have a target dividend pay-out level.
- This pay-out level is determined as a proportion of long run (i.e. sustainable) earnings of the firm.
- Managers are more concerned with changes in dividends rather than the actual level of dividends.
- Managers prefer not to make dividend changes that might need to be reversed (e.g. cutting dividends after having raised them in the previous period).

As the second fact implies, it is not current but long-run earnings that matter in setting dividends such that dividends can be seen to be smoothed relative to earnings.

There are three basic types of dividend policies that are used by the companies. They are

1. Stable dividends
 2. Target Payout Ratio and
 3. Regular and extra dividends
1. **Stable dividends:** A company following this type of a policy maintains a constant dividend rate irrespective of the actual earnings level and the company tries to maintain it even when during the recession the earnings go down below the actual dividends pay, trying to signal to the investor that this is a temporary phase and earnings will be back up when the economy revives.

Companies expect that the investors will place a premium on the shares of a company which pays stable dividends and only increases its dividend payment when it believes that increase can be maintained. A stable dividend policy

irrespective of fluctuating earnings also is beneficial because many institutions take decisions based on the actual payout by the companies. Signalling effect of this type has already been mentioned above.

This is the most favoured type of dividend policies adopted by the companies the world over.

2. **Target Payout Ratio:** Although there is a reason to believe that stable dividends have a positive effect on a company's share price, many firms set a bench-mark target payout ratio (or range). They only deviate from this target to achieve relatively stable dividends or stable and occasionally increasing ones. Lintner contents that companies seek to maintain a target dividend payout ratio over the long run, but only with a lag. For example, a company may decide that it will pay around 40 per cent of its earnings as dividends and only increase it when this ratio falls to 30 per cent of the earnings that the company is reasonably sure of. This is especially applicable in case of companies with stable earnings and earnings growth for only they can sustain a target payout ratio in the long run.
3. **Regular and extra dividends:** Especially when a company earns above average earnings because of any reason but which is non-recurring in nature, it proposes a extra dividend over and above the regular dividend it pays. This extra earnings could be due to divestment of a plant or business operations and the company has no possible utilisation of the same. In line with the recommendations that investors like to receive the money back from the company rather than the company utilising that money in non-business activities, the companies usually return the money back to the shareholders. This labelling of extra dividends or one-time dividends is given to help the investors appreciate the fact that extra dividends are non-recurring in nature and this is the only year this is being paid.

There are other ways of returning cash to shareholders and one of the biggest ones is gaining ground in India recently. This is share buyback.

Stock Dividends and Stock Splits

An integral part of dividend policy of a firm is the use of bonus shares and stock splits. Both involve issuing new shares on a pro rata basis to the current shareholders while the firm's assets, its earnings, the risk being assumed and the investors percentage ownership in the company remain unchanged. The only definite result from either a bonus share or share split is the increase in the number of shares outstanding. Table illustrates their effect on the capitalization of the firm. Part one of the table shows the equity of the balance sheet before the bonus issue and part two after the issue. The effect of share splits is shown in part three.

1.	Equity portion before the bonus issue: Equity share capital (30,000 shares of Rs.100 each) Share premium (@ Rs.25 per share) Retained earnings Total equity	Rs. 30,00,000 7,50,000 62,50,000 1,00,00,000
2.	Equity portion after the bonus issue (1 : 2 ratio): Equity share capital (45,000 shares of Rs.100 each) Share premium (45,000 shares X Rs.25) Retained earnings (Rs.62,50,000 – 15,000 shares × Rs.125) Total equity	45,00,000 11,25,000 43,75,000 1,00,00,000
3.	Equity portion before the share splits (10 : 1 ratio): Equity share capital (3,00,000 shares of Rs.10 each) Share premium Retained earnings Total equity	30,00,000 7,50,000 62,50,000 1,00,00,000

TABLE Effect of Bonus Shares and Shares Splits

From Table it is clear that a share split is similar to bonus issue from the economic point of view though there are some difference from the accounting point of view. In the equity portion of the firm, a bonus issue reduces the retained earnings and correspondingly increases paid-up equity and share premium, if any, whereas stock/share split has no such effect. The economic effect of both is to increase the number of equity shares outstanding.

As pointed out earlier, no major economic benefit results from bonus shares and share splits. Yes, certain advantages are associated with them. In the first place, the issue of bonus shares / share splits would have the effect of bringing the market price of shares within more popular range as a result of larger number of shares outstanding. The larger number of outstanding shares will also promote more active trading in the shares due to availability of floating stock. Yet another advantage might relate to the informational content of bonus/split announcement. The announcement is perceived as favourable news by the investors in that with growing earnings, the company has bright prospects and the investors can reasonably look for increase in future dividends. Moreover, it enables the conservation of corporate cash. If the bonus share is an effort to conserve cash for profitable investment opportunities, the share prices will tend to rise and the shareholders benefit. However, if the move to conserve cash relates to financial difficulties within the firm, the market price will most likely react adversely. Finally, bonus / split announcements improve the prospect of raising additional funds particularly through the issue of convertible debentures.

Repurchase of Stock

As an alternative to paying cash dividends, a company may distribute income to its

shareholders by repurchasing its own shares. Assuming that the repurchase does not adversely affect the firm's earnings, the earnings per share on the remaining shares will increase, resulting in a higher market price per share, which means that the capital gains will have been substituted for dividends.

A repurchase that is part of capital restructuring is different from a regular repurchase mentioned above. In a capital restructuring repurchase plan asset sales and issuance of debt are used to bring in additional capital and then this capital is distributed to shareholders through a major, one-time share repurchase.

Disadvantages/ Advantages of Share Repurchases

1. Repurchase announcements are viewed as positive signals by investors because the repurchase is often motivated by management's belief that the firm's shares are undervalued.
2. The shareholders have a choice to sell or not to sell in share repurchase situation. So those who prefer capital appreciation can get the same and those who prefer cash can sell the shares.
3. Repurchase can help reduce the supply of shares in the market, thereby increasing the value of the share.
4. Management dislikes increasing cash dividend as it sends positive signals about future profitability and if the company cannot maintain the same in the future it may result in a sharp fall in the share price. Therefore, if the earnings increase is only temporary then the management may prefer to make the distribution in the form of a share repurchase.
5. It can help in drastically changing the capital structure of the company, which is otherwise very difficult.

There are certain disadvantages too:

1. The shareholder may benefit more from cash dividends than share repurchase if the market discounts the earnings more than a given level.
2. The selling shareholder may lose because of the share repurchase plan as he would get the long term benefit of share repurchase.
3. The company may pay too high a price for share repurchase, resulting in a reduction in value for existing shareholders.

All this means that share repurchases on a systematic, dependable basis is probably not a good idea. However, it can be given careful consideration if the market is not discounting the share in a proper manner and the company has extra cash that it can utilise for the same. Repurchases can be especially valuable to a firm that wants to make a large shift in its capital structure within a short period of time.

Procedural and Legal Aspects of Dividends

The amount of dividend that can be legally distributed is governed by company law, judicial pronouncements in leading cases, and contractual restrictions. The important provisions of company law pertaining to dividends are described below.

1. Companies can pay only cash dividends (with the exception of bonus shares). Apart from cash, dividend may also be remitted by cheque or by warrant. The same may also be transmitted electronically to shareholders after obtaining their consent in this regard to the bank account number specified by them. The step has been proposed by the Department of Company Affairs to avoid delay in the remittance of dividend.
2. Dividends can be paid only out of the profits earned during the financial year after providing for depreciation and after transferring to reserves such percentage of profits as prescribed by law. The Companies (Transfer to Reserve) Rules, 1975, provide that before dividend declaration, a percentage of profit as specified below should be transferred to the reserves of the company.
 - a. Where the dividend proposed is up to 10 per cent of the paid up capital, no amount of the current profits need to be transferred.
 - b. Where the dividend proposed exceeds 10 per cent but not 12.5 per cent of the paid-up capital, the amount to be transferred to the reserves should not be less than 2.5 per cent of the current profits.
 - c. Where the dividend proposed exceeds 12.5 per cent but not 15 per cent, the amount to be transferred to reserves should not be less than 5 per cent of the current profits.
 - d. Where the dividend proposed exceeds 15 per cent but not 20 per cent, the amount to be transferred to reserves should not be less than 7.5 per cent of the current profits.
 - e. Where the dividend proposed exceeds 20 per cent, the amount to be transferred to reserve should not be less 10 per cent.
 - f. A company may voluntarily transfer a percentage higher than 10 per cent of the current profits to reserves in any financial year provided the following conditions are satisfied:
 - (i) It ensures that the dividend declared in that financial year is sufficient to maintain average rate of dividend declared by it over three years immediately preceding the financial year.
 - (ii) In case, it has issued bonus shares in the year in which dividend is declared or in the three years immediately preceding the financial year, it maintains the amount of dividend equal to the average amount of

dividend declared over the three years immediately preceding the financial year.

However, maintenance of such minimum rate or quantum of dividend is not necessary if the net profits after tax in a financial years are lower by 20 per cent or more than the average profits after tax of the two immediately preceding financial years.

- g. A newly incorporated company is prohibited from transferring more than then percent of its profits to reserves. The 'current profit' for the purpose of transfer to reserves will be profits after providing for statutory transfer to the Development Rebate Reserve and arrears of depreciation if any.
3. Due to inadequacy or absence of profits in any year, dividend may be paid out of the accumulated profits of previous years. In this context, the following conditions, as stipulated by the companies (Declaration of Dividend out of Reserves) Rules, 1975, have to be satisfied.
 - a. The rate of the declared dividend should not exceed the average of the rates at which dividend was declare by the company in 5 years immediately preceding that year or 10 per cent of its paid-up capital, whichever is less.
 - b. The total amount to be drawn from the accumulated profits earned in previous years and transferred to the reserves should not exceed an amount equal to one-tenth of the sum of its paid-up capital and free reserves and the amount so drawn should first be utilized to set off the losses incurred in the financial year before any dividend in respect of preference or equity shares is declared.
 - c. The balance of reserves after such drawal should not fall below 10 per cent of its paid-up capital.
 4. Dividends cannot be declared for past years for which accounts have been adopted by the shareholders in the annual general meeting.
 5. Dividend declared, interim or final, should be deposited in separate bank account within 5 days from the date of declaration and dividend will be paid within 30 days from such a date.
 6. Dividend including interim dividend once declared becomes a debt. While the payment of interim dividend cannot be revoked, the payment of final dividend can be revoked with the consent of the shareholders.

Procedural Aspects

The important events and dates in the dividend payment procedure are:

1. **Board Resolution:** The dividend decision is the prerogative of the board of

directors. Hence, the board of directors should in a formal meeting resolve to pay the dividend.

2. **Shareholder Approval:** The resolution of the board of directors to pay the dividend has to be approved by the shareholders in the annual general meeting. However, their approval is not required in the case of declaration of interim dividend. Further, it should be noted that the shareholders in the annual general meeting have neither the power to declare the dividends (if the Board of Directors do not recommend it) nor to increase the amount or dividend. However, they can reduce the amount of the proposed dividend.
3. **Record Date:** The dividend is payable to shareholders whose names appear in the register of members as on the record date.
4. **Dividend Payment:** Once a dividend declaration has been made, dividend warrant must be posted within 30 days. Within a period of 7 days, after the expiry of 30 days, unpaid dividends must be transferred to a special account opened with a scheduled bank.

In case the company fails to transfer the unpaid dividend to the 'unpaid dividend account' within 37 days of the declaration of dividend, an interest of 12 per cent per annum on the unpaid amount is to be paid by the company. The interest so accruing is to be paid to the shareholders in the proportion of the dividend amount remaining unpaid to them.

The dividend will be paid to the registered shareholder or to his order or to his banker or in case a share warrant has been issued to the bearer of such a share warrant. In the case of joint-holders, the dividends should be paid to the first joint-holder.

Further, as per the notification issued by the Department of Company Affairs, the payment of dividend to the shareholders involving the fraction of 50 paise and above be rounded off to the rupee and the fraction of less than 50 paise may be ignored.

In the case of dematerialized shares (i.e., the shares held in electronic form), the corporate firms are required to collect the list of members holdings shares in the depository and pay them the dividend.

5. **Unpaid dividend:** If the money transferred to the 'unpaid dividend account' in the scheduled bank remains unpaid / unclaimed for a period of 7 years from the date of such transfer, the company is required to transfer the same to the 'Investor, Education and Protection Fund' established for the purpose.

Dividend Policies in Practice

To learn about the dividend policies of business firms, the author asked the chief finance executives of 20 large-sized business undertakings, representing a wide cross-section of industries, the following question: What is your dividend policy? The responses obtained are reproduced below (the lengthier ones have been paraphrased).

Nature of Industry Response

Electrical	"We try to maintain a ten per cent dividend rate. That is what the government expects from us."
Chemicals	"Dividend policy is concerned primarily with the welfare of shareholders. When earnings position permits we declare good dividends. Otherwise, we don't. We don't think of accumulating surplus and declaring bonus shares."
Tea	"In the last ten years the parent company has not been insisting on any dividend rate. Whatever has been paid out is accepted. Our payout has been 30 to 50 per cent."
Fertiliser	"Though we are a joint sector project, our dividend policy is governed by commercial considerations. Of course, we are a bit conservative."
Toothpaste	"We believe in rewarding shareholders generously - both in dividends and bonus shares. Our payout has been very high."
Aluminium	"We pay dividend whenever we can afford it. When performance or liquidity unsatisfactory we skip dividend to preserve strength our financial strength."
Chemical	"Our dividend policy is to pay a fixed rate of dividend and issue bonus shares when we are eligible to. The purpose is to ensure that shareholders retain shares to enjoy capital gains."
Automobile	"We like to maintain a dividend rate of 15 per cent. This seems to be a fair return to investors."
Shipping	"In the past when the going was good, we paid good dividends and issued bonus shares periodically. The last few years were rough. We had to suspend dividend for some time. We are now recovering. We will try to follow the past policies, provided business conditions are good."
Leasing	"We would like to declare as high a dividend as we can. If share prices rise due to that, we can raise relatively easily more funds by issuing convertible debentures."

Diversified	"We regard shareholders as partners. They deserve handsome returns. We give good dividends and periodic bonus issues."
Diversified	"We have a very conservative dividend policy. Our dividend rate which used to be 10 per cent four years ago has now been raised to 15 per cent. We won't probably consider a change for the next few years."
Truck	"The company follows a conservative dividend policy which aims at protecting the interests of the shareholders and the company by (a) providing a consistent and reasonable return to the (b) shareholders, and (c) ploughing back profits to take care of contingencies and to improve the equity base."
Pharmaceuticals	"We distribute about 30 per cent of our earnings. We maintain our dividend around 18 per cent. When the reserves position permits and the earnings potential justifies, we issue bonus shares."
Diversified	"We don't have a specific dividend policy. When the profits are good and liquidity satisfactory we give 12 per cent to 15 per cent as dividends."
Textiles	"Due to drop in profits we have skipped dividends. We will try to restore it-when I don't know."
Storage	"We have been paying steadily about 20 per cent as dividends." "Of course, our bonus record is poor. In the foreseeable future there may be very little change."
Diversified	"The investor is the king. Unless he is rewarded, we can't get the funds for our growth. So, we try to benefit him by dividends, bonus issues, and rights issue."
Consumer Electronics	"We paid good dividends a profits were high. We will try to maintain the same. Of course, profitability will be the key factor."
Diversified	"We have, if you permit me to say, an obsession with 20 per cent dividend rate. We don't want to raise it to 25 or 30 per cent as this connotes super profits--but we would like to declare bonus shares. Our planning revolves around this compelling goal-dominant

Some Types

On the basis of the above responses we find that most of the firms pursue three types of policies:

Generous Dividend and Bonus Policy Firms which follow this policy reward shareholders generously by stepping up total dividend payment over time. Typically, these firms maintain the dividend rate at a certain level (15 to 25 per cent) and issue bonus shares when the reserves position and earnings potential permit. Such firms naturally have a strong share holder orientation.

More or Less Fixed Dividend Policy Some firms have a target dividend rate which is usually in the range 10 per cent to 20 per cent which they consider as a reasonable compensation to equity shareholders. Such firms normally do not issue bonus shares frequently, may be once in few years, the dividend rate may be raised slightly to provide somewhat higher compensation to equity shareholders to match the higher returns from other forms of investment.

Erratic Dividend Policy Firms which follow this dividend policy seem to be indifferent to the welfare of equity shareholders. Dividends are paid erratically whenever the management believes that it will not strain its resources.

Tax Aspects

With effect from financial year 2003-4, dividend income from domestic companies and mutual funds is exempt from tax in the hands of the shareholders / investors / unit-holders. However, the domestic companies will be liable to pay dividend distribution tax at the rate of 12.5 per cent (plus surcharge) on dividends paid after April 1, 2003.

Chapter-13

Working Capital Financing

Accruals, trade credit, commercial Banks advances, public deposits, Inter Corporate Deposits, Short Term Loans from Financial Institutions, Debentures for working capital, Commercial Paper, Factoring, Regulation of Bank Finance – Recommendation of Latest Committee.

This chapter discusses sources of financing. By convention all sources of financing that must be repaid within one year are considered to be short-term, those that must be repaid in one to five years are intermediate term, and all sources with maturities longer than five years are classified long-term.

Two major issues are involved in managing the firm's use of short-term financing:

(1) How much short-term financing should the firm use? and (2) What specific sources of short-term financing should be selected? The earlier chapter used the bedding principle of working-capital management to answer the first of these two questions. Basically, that involved an attempt to match temporary needs for funds with short-term sources of financing and permanent needs with long-term sources.¹ The objective of this chapter will be to answer the second of the above questions:

How should the financial manager select a source of short-term credit?

In general, three basic factors should be considered in selecting a source of short-term credit: (1) the effective cost of credit, (2) the availability of credit in the amount needed and for the period of time when financing is required, and (3) the influence of the use of a particular credit source on the cost and availability of other sources. We discuss the problem of estimating the cost of short-term credit before.

Introducing the various sources of credit, as the procedure used is the same for all. The second and third factors listed above are each discussed as they pertain to the individual sources of short-term credit.

Estimating the Cost of Short-Term Credit

¹ Temporary needs for funds arise in response to a temporary need for current assets. These include current assets that the firm does not plan to hold throughout the indefinite future. Permanent needs for funds arise in conjunction with a permanent need for certain assets. These assets consist of fixed assets plus the firm's minimum level of investment in current assets. Thus, when discussing working-capital management we abandoned the current-fixed assets classification in favour of the more useful concept of temporary and permanent assets.

Approximate Cost-of-Credit Formula

The procedure used in estimating the cost of short-term credit is a very simple one and relies on the basic interest equation.

(8-1) Interest = principle \times rate \times time

Where interest is the amount of interest on a principal that is borrowed at some annual rate for a fraction of a year (represented by time). For example, a six-month loan for Rs 1000 at 8 per cent interest would require interest payments of Rs 40:

$$\text{Interest} = \text{Rs } 1000 \times .08 \times 1/2 = \text{Rs } 40.$$

The problem faced in assessing the cost of a source of short-term financing, generally involves estimating the annual effective rate (RATE) where the interest amount, the principal sum, and the time for which financing will be needed are known.

Thus, solving the basic interest equation for RATE produces

$$(8-2) \quad \text{Rate} = \frac{\text{Interest}}{\text{Principal} \times \text{Time}}$$

$$\text{or} \quad \text{Rate} = \frac{\text{Interest}}{\text{Principal}} \times \frac{1}{\text{Time}}$$

Example: The SKC Corporation plans to borrow Rs 1000 for a 90-day period. At maturity the firm will repay the Rs 1000 principal amount plus Rs 30 interest. The effective annual rate of interest for the loan can be estimated using the RATE equation as follows:

$$\begin{aligned} \text{Rate} &= \frac{\text{Rs } 30}{\text{Rs } 1000} \times \frac{1}{90/360} \\ &= .03 \times \frac{360}{90} = .12, \text{ or } 12 \text{ per cent} \end{aligned}$$

The effective annual cost of funds provided by the loan is therefore 12 per cent.

The Annual Percentage Rate Formula

Compound interest was not considered in the simple RATE calculation. To consider

the influence of compounding we can use the following equation:

$$(3-3) \quad \text{APR} = (1 + r/m)^m - 1$$

Where APR is the annual percentage rate, r is the nominal rate of interest per year (12 per cent in the above example) and m is the number of compounding periods within a year ($m = 1/\text{TIME} = 1/(90/360) = 4$ in the example above). Thus, the effective rate of interest on the example problem, considering compounding, is

$$\text{APR} = (1 + .12 / 4)^4 - 1 = .126, \text{ or } 12.6 \text{ per cent}$$

The effect of compounding is to raise the effective cost of short-term credit. Since the differences between the two methods for periods less than one year are usually small, the simple interest version of RATE discussed above will be used.

Sources of Short-Term Credit

Short-term credit sources can be classified into two basic groups: unsecured and secured. Unsecured loans include all those sources that have as their security only the lender's faith in the ability of the borrower to repay the funds when due. There are three major sources of unsecured short-term credit: trade credit, unsecured bank loans, and commercial paper. Secured loans involve the pledge of specific assets as collateral in the event the borrower defaults in payment of principal or interest. The principal suppliers of secured credit include commercial banks, finance companies, and factors. The primary sources of collateral include accounts receivable and inventories.

Accruals

Internal accruals is one of the major sources of funds for most companies and is derived from the retained earnings. Profits left after paying dividends are primarily used for working capital financing.

Trade credit

In any normal business practice, buyers are not generally required to pay cash on delivery for the goods and services they order. Instead, the sellers "invoice", or bill the buyers on delivery according to the terms of the particular 'trade' or line of business. That is, sellers extend credit to buyers, and this extension of credit provides a temporary source of funds to the buyer in the form of accounts payable. Because suppliers are generally more liberal in extending credit than banks are, trade credit has become the most important source of short-term business funds in terms of total volume of credit supplied.

Forms of Trade Credit

There are three avenues of trade credit extension: (1) the open account, which is by far the most common; (2) the promissory note; (3) the trade acceptance.

Open-account credit is ordinarily extended only after the seller conducts a fairly extensible investigation of the buyer's credit standing and reputation. The open account derives its name from the fact that the buyer does not sign a formal debt instrument evidencing the amount he owes the seller, as would be the case if he applied for and obtained bank credit. The only evidence the seller has that credit has been extended is the buyer's purchase order, a copy of the invoice showing that merchandise was shipped,

and an entry in his accounts receivable ledger. It is indicative of the extent to which a “credit economy” has developed in this country that, when most trade credit is arranged, this is all that is done and all that is required to be done to establish legal evidence of indebtedness.

In some situations, however, a promissory note may be used in the transaction. A promissory note is written promise by one person to another to pay on demand or at a fixed or determinable future time a certain sum of money to order of bearer. The promissory note is generally an interest-bearing instrument. Buyers are required to sign such notes most often in cases where their open accounts have become delinquent and the seller wishes to obtain a formal acknowledgement of the debt, a definite maturity date, and, at times, a return in the form of interest on the funds thus committed. Promissory notes appear on the seller’s balance sheet as “notes receivable” of course.

In some lines of business, trade acceptances are used in place of the open account. A trade acceptance is generated when a seller, after receiving a purchase order from a customer, draws a time draft on that customer in the amount of the order. A time draft is an unconditional order to pay a certain sum of money at a fixed or determinable future time. The seller then sends the draft through his own bank, together with an order bill of lading from the carrier by which the goods are shipped, for presentation to and acceptance by the customer. An order bill of lading must be presented to the carrier to secure the release of the goods shipped at their destination. The seller’s bank forwards the draft and bill of lading to its correspondent bank in the city in which the customer is located; and this bank presents the draft to him for acceptance. The customer accepts the draft simply by signing, dating, and writing the word “accepted” across the face of the draft.

After accepting the draft, the customer receives the order bill of lading from the bank and is able to secure his shipment of goods from the issuing carrier. The accepted draft, now a trade acceptance, is then returned to the seller’s bank and then to the seller, he may either hold it to maturity or ask his bank to discount it for him, since as a trade acceptance it is a full fledged negotiable instrument. In either event, it will be presented to the buyer for payment on its due date.

Terms of Trade Credit

Promissory notes and trade acceptances are both used rather sparingly in commercial transactions; therefore, the more relevant terms of trade credit are those pertaining to open accounts. Three aspects of this form of credit warrant discussion:

- (1) the size of the cash discount, if any, from the net invoice price which is given for making cash payment within a specified period;

- (2) the period within which payment must be made if the cash discount is to be allowed; and
- (3) the maximum period that can elapse before payment of the net invoice price is required if the cash discounts is not taken.

It is important to distinguish a cash discount — from both a quantity discount and a functional discount. A quantity discount generally expressed as a percentage reduction from a list price-is given for purchasing certain minimum amounts of a particular item. Functional discounts are differential discounts given to different types of customers — a wholesaler, for example, may be given a larger discount than a retailer.

Terms of trade credit, which vary from industry to industry, are specified on each invoice and may be categorised according to both the net period within which payment is expected and the terms of the cash discounts allowed. In general, cash discounts could be set as high as 10 % but the average is closer to 2 to 6 percent; the discount periods are usually fairly short, in most cases 10 or 20 days.

CBD And COD

“Cash before delivery (CBD)” and “Cash on delivery (COD)” are two common forms of payment. Under CBD, as buyer must pay for the goods before the supplier will ship them, when a supplier imposes these terms, he either knows nothing at all about the buyer’s creditworthiness or, more frequently, he knows “too much” about the customer’s unreliability in managing his business affairs. In the latter circumstances, to eliminate the risk of non-payment completely, he may even wait for the customer’s check to clear even before shipping the order. Under COD, supplier will ship the goods ordered, but the buyer must pay for them before taking possession. The only risk involved with COD is that the customer may refuse the shipment and the seller will have to pay shipping costs both ways. Transactions completed under either CBD or COD terms are considered cash transactions since suppliers are required to extend no credit at all.

Net-terms, no cash discount

When net terms are quoted, the supplier specifies the period permitted for payment in full payment. For example, “net 30” means that the amount of net invoice must be paid in full within 30 days. If the seller bills on a monthly basis, he may stipulate such terms as “net 15 EOM,” meaning that all goods shipped before the end of the month must be paid for in full by the fifteenth of the following month. Sometimes, “bill-to bill” terms are specified, that is, the bill for a previous delivery is collected at the time a new delivery is made.

Cash discount terms

In addition to extending credit on net terms, suppliers may offer a cash discount for payment more prompt than the net terms require. The terms' "2/10, net 30," for example, indicate that the buyer is offered a 2 per cent discount for payment within 10 days of the date of the invoice. If this discount is not taken, the full amount is due within 30 days. When the buyer is far removed from the seller, or the method of shipping the goods is slow, terms may be "2/10, net 30 AOG". That arrangement affords the buyer the opportunity of inspecting the goods before paying for them. More important, it provides all buyers with an equal opportunity to earn the cash discount, regardless of the transit time required for the goods to reach them.

Rationale for trade credit terms

The variation in trade credit terms described above have a rationale. First; the period of time for which credit is granted is related to the nature of the commodity sold. High-style items or perishable merchandise are generally sold on fairly short credit terms because of the high turnover of the items.

Second, the estimated degree of credit risk is generally reflected in the terms of sale. Retail shops in the apparel trades are characterised by a rather high rate of failure and if not failure a exceptionally long credit period (six months on an average), for example. This may explain the rather large cash discounts usually allowed to such retailers - the size of the discount reflecting supplier's desires to be paid as quickly as possible.

Third, the nature and extent of competition among suppliers is expressed in credit terms as well as in prices and service. When a product is new, or if a supplier is soliciting business from a new account, granting more liberal credit terms than are customary may be one way of generating additional sales.

Fourth, a supplier short of working capital may offer rather large cash discounts to his customers to induce them to settle their accounts quickly. In this way, the supplier reduces his collection period and thus reduces his total working capital requirements. A thinly capitalised supplier may find that the cost of offering large cash discounts is less than the cost of borrowing or raising additional equity capital to meet his working capital needs.

Finally, the financial strength of the supplier relative to that of his customers is also a determinant of credit terms. Although it might appear that a financially strong supplier could dictate stringent terms, by doing so he may succeed only in losing some customers and possibly even putting others out of business.

In reality, in many lines of business, smaller companies are “carried” by their suppliers.

Trade credit as a source of funds

Since buyers generally do not pay for goods until some time after they are delivered, trade credit is a short-term source of business funds. If a firm “automatically” pays all its bills a certain number of days after the invoice date becomes a built-in source of financing that varies with the production cycle. As the firm increases its level of production, and thus its purchases, accounts payable increase commensurately providing some of the funds needed to finance the increase in production. Similarly, as production decreases, purchases, and thus account payable, decrease.

Although change in the size of a firm’s account payable may not be able to move with inventory adjustments, there will ordinarily be a strong degree of correspondence between the two. If a firm adheres strictly to the practice of always paying its bills a certain number of days after invoice date, trade credit cannot be considered a discretionary source of financing.

Instead, it becomes determinate insofar as it is dependent on the purchasing plan of the firm which, as we discussed earlier, is dictated largely by its production cycle. Although prompt payment of such obligations is generally to be commended, certain advantages may be gained from using trade credit as a discretionary source of short-term financing.

When the company gets the trade credit, it would like to pay back as late as possible, because these are the funds that require no interest payments and are free of cost. Right. Wrong, these funds are not free of cost because the sale price of these already includes the cost of the time for which the credit is given.

Cost of Trade Credit

For purposes of measuring the true cost, or the effective annual rate of interest associated with use of trade credit as a discretionary source of short-term business funds, it is necessary to consider the effects of its use both when :

- (1) a company fails to take its cash discounts but nevertheless pays within the net period, and
- (2) a company fails to take its discounts and allows its payable to become overdue.

These two situations are the only ones that involve an actual cost to the debtor. If no cash discount is offered, then there is no cost for the use of credit during the “net” period, however long it may be. By the same token, if a discount is available and the buyer takes it, there is also no cost for the use of credit during the discount period. However, if a cash discount is offered and is not taken, there is an explicit opportunity cost for the use of third credit.

For example, the Road Company purchases its raw materials on terms of 2/10 net 30. It thus has the option of using the funds for 20 days after the discount period if it “passes” the discount but pays on the final day of the net period. Road Co., however, must pay 2% of the privilege of using the funds for 20 days. It is given by the equation:

$$R = \frac{C(365 D)}{D (100-C)}$$

where

C = the cash discount

D = the number of extra days Road has the use of the supplier’s funds

R = the annual interest rate for the use of these funds

In our example, C = 2 percent, D = 20: the effective annual interest rate for the company would be

$$R = \frac{2(365)}{20 (100-2)} \quad 37.24 \text{ per cent}$$

Thus, we see that passed discounts can transform trade credit from a normally easy source of funds into a very expensive form of short-term financing. Therefore, if other financing is available even though with high interest rates, say 20 or 24%, Road’s financial administrator would be well advised to borrow in sufficient time so that it can take advantage of any cash discounts offered by its suppliers.

Sometimes companies that are short of cash and lack reserve borrowing power may be forced to not only pass up cash discounts but also postpone payment beyond the net period. This practice is referred to as “stretching” accounts payable or “riding” trade creditors.

There are two types of costs incurred by a company that stretches its accounts payable

- (1) the explicit cost of discounts foregone, as outlined above, and
- (2) the implicit cost of permitting its trade credit rating to deteriorate.

If a company rides its creditors excessively, so that its trade payable become noticeably delinquent, its credit rating among all suppliers in the trade will surely suffer. They will view the company as increasingly risky to sell to and may quickly begin to impose rather strict terms of sale, up to and including COD or CBD.

Proper Use of Trade Credit

As compared with other kinds of short-term business credit — bank loans, for example — trade credit is almost automatic. And because it may be much more readily acquired,

business companies must exercise continuing care to avoid falling into the habit of using trade credit to excess.

Because suppliers regard the extension of trade credit as a part of their overall sales promotion programs, they often extend trade credit to many marginally creditworthy companies—small, new companies and old, declining companies—that do not qualify for and consequently cannot obtain credit from other sources of short-term funds. It is also quite easy to get into debt through the use of trade credit.

A company needs only to order additional goods from its suppliers; and if it is occasionally late in making payment, the sales promotion aspect of trade credit extension may prompt suppliers to “look the other way,” so that the company’s credit reputation may suffer no immediate harm.

Finally, trade credit is exceedingly useful and valuable precisely because business companies can usually obtain it when, as, and to the extent that it is needed. When inventory should be increased to anticipate the seasonal expansion of sales, for example trade credit will automatically finance a part of the increase. Then, as the seasonal sales convert into cash through collections, the company may use the funds to reduce trade payable. For this reason, trade credit is often termed a “spontaneous” source of funds.

Thus, a company’s financial officer while assuring that his company benefits from the availability of trade credit in every legitimate way, should always maintain the business liquidity required to pay all his company’s bills as they come due. Beyond this, even considering the extremely high cost of passing discounts, he should certainly plan to pay all of his company’s trade bills within the discount period. Doing so will have favourable results, not only on the company’s credit reputation in the trade but, more important, on its current and long-run profitability as well.

In a negative but equally significant sense, doing so will automatically avoid the possible financial over extension of the company that could result from its succumbing to the temptation to use trade credit excessively “because it is there”.

Commercial Banks advances

Bank credit is the most basic and the most widely used method of short term finance (apart from trade credit) because of the availability of funds and relatively permanent source of funds as compared to the trade credit. We will discuss the requirements of the banks which they take into consideration before accepting the corporate as a client, then we take a look at RBI Guidelines governing the same including the methods of calculating the amount that the bank is going to finance and lastly we take a look at some of the recent issues concerning bank finance.

A business firm may have diverse credit needs and may require either (1) a revolving credit arrangement, (2) a seasonal line of credit, (3) funding on a transaction basis, or (4) get its bills discounted. Banks will take care that it meets the kind of requirements that the company has and not push their own systems of financing. Banks do participate even in financing some of the money market instruments (like CPs) but the basic funding remains through the working capital loans only.

A line of credit is simply a formal or informal agreement between a commercial bank and a borrowing customer regarding the maximum amount of credit the bank is willing to extend to that customer over a given number of months usually a quarter. These limits are usually rollable from year to year after reassessment of the requirements.

Seasonal business borrowers commonly request seasonal lines of credit. By preparing and analysing cash budget reflecting his firm's operations over some period, the financial administrator estimates the patterns of his seasonal financing needs and arranges a line of credit with the firm's bank, the upper limit of which equals the firm's forecasted peak requirements, as shown in his cash budget.

The seasonal build up of inventories, accounts receivable, or both create needs for funds, the firm simply signs promissory notes for the amounts required at the times they are required, and the bank credits the firm's account in the proper amounts. Subsequently, the post seasonal shrinkage in working capital needs permits the firm to repay the advances with funds generated from the sale of inventories and the collection of accounts receivable. (for example in sugar industry where demand for WC builds up for six months and comes down in the rest six months).

Banks usually access the peak seasonal demand and off-season demand separately and sanction credit on this basis.

Revolving Credit Agreements

Earlier the whole working capital loan was revolving credit in the sense that the company could repay whatever part of the loan it wanted to.

Revolving lines typically were continuous and were negotiated as formal commitments to lend by the bank, and a commitment fee was charged on any portion of the line that lied unused. The main problem was that the bank had to keep aside a huge portion of funds, which, in the case of corporates not utilising them, were not earning any return except the return from the call money markets (which were very low as compared to the returns from the loans).

To rectify this problem the banks divided the working capital loans into two parts, demand loan and cash credit in a ratio of 80:20. Demand loan became the fixed portion of the bank working capital financing and only the cash credit was allowed to be kept fluctuating.

Transaction Basis

When a firm borrows only occasionally, for specific purposes that may differ from time to time, it will generally negotiate each loan with the bank as a separate transaction.

Bill Discounting

Under this a borrower can obtain the bank credit through the bank's purchase of (or discount of) its bills. The amount covered under this agreement is covered within the overall working capital limits. Before purchasing or discounting the bills the bank satisfies itself with the creditworthiness of the drawer. In practice, the banks hold the bills as security against the credit it gives to the company.

Cost of Bank Credit

Interest rates on bank loans to business are determined through negotiation between borrower and lender. The rate charged tends to vary directly with the credit quality, or the credit-worthiness, of the borrower. The largest, soundest companies possessing the highest credit quality are able to borrow at the prime rate, the lowest rate charged on business loans at any point in time.

The prime rate is the one at which the nation's largest banks lend to their biggest and best business-borrowing customers. It is the connecting link between a commercial bank's loan rates and short-term, open-market money rates. The prime rate measures, in effect, the opportunity cost to banks of lending rather than investing in short-term, open market instruments. Since the latter are virtually risk less, it follows that prime-rate borrowers must possess credit qualities of the very highest order to qualify for the lowest bank loan rate.

This rate is usually used for the working capital financing, while for extending short-term credit (especially in commercial paper) this rate is almost never used as the benchmark and banks frequently lend below this rate.

Example: M&M Beverage Company has a Rs 300,000 line of credit which requires a compensating balance equal to 10 per cent of the loan amount. The rate paid on the loan is 12 per cent per annum, Rs 200,000 is borrowed for a six-month period, and the firm does not, at present, have a deposit with the lending bank. The cost of the loan includes the interest expense and, in addition, the opportunity cost of maintaining an idle

2 Although technically incorrect, the same answer could have been obtained by assuming a total loan of Rs 200,000 of which only 90 per cent of Rs 180,000 was available for use by the firm; that is,

$$\text{RATE} = \frac{\text{Rs } 12,000}{\text{Rs } 180,000} \times \frac{1}{18/360} = 13.33 \text{ per cent}$$

Interest is now calculated on the Rs 200,000 loan amount (Rs 12,000 = Rs 200,000 × .12 × 1/2).

cash balance equal to the 10 per cent compensating balance. To accommodate the cost of the compensating balance requirement, assume that the added funds will have to be borrowed and simply left idle in the firm's checking account. Thus, (a) the amount actually borrowed (b) will be larger than the needed Rs 200,000. In fact, the needed Rs 200,000 will comprise 90 per cent of the total borrowed funds due to the 10 per cent compensating balance requirement, hence $90B = \text{Rs } 200,000$, such that $B = \text{Rs } 222,222$. Thus, interest is paid on a Rs 222,222 loan $\text{Rs } 222,222 \times .12 \times \frac{1}{2} = \text{Rs } 13,333.32$, of which only Rs 200,000 is available for use by the firm.² The effective annual cost of credit therefore is

$$\text{RATE} = \frac{\text{Rs } 13,333.32}{\text{Rs } 200,000} \times \frac{1}{18/360} = 13.33 \text{ per cent}$$

If the firm normally maintains at least Rs 200,000 (or 10 per cent of the needed funds) in a demand deposit with the leading bank, then the cost of the credit is,

$$\text{RATE} = \frac{\text{Rs } 12,000}{\text{Rs } 200,000} \times \frac{1}{18/360} = 12 \text{ per cent}$$

In the M&M Beverage Company example the loan required the payment of principal (Rs 222,222) plus interest (Rs 13,333.32) at the end of the six-month loan period. Frequently, bank loans will be made on a discount basis. That is, the loan interest will be deducted from the loan amount before the funds are transferred to the borrower, extending the M&M Beverage company example to consider discounted interest involves reducing the loan proceeds (Rs 200,000) in the previous example by the amount of interest for the full six months (Rs 13,333.32). The effective rate of interest on the loan is now:

$$\text{RATE} = \frac{\text{Rs } 13,333.32}{\text{Rs } 200,000 - \text{Rs } 13,333.32} \times \frac{1}{18/360} = .1429, \text{ or } 14.29 \text{ per cent}$$

The effect of discounting interest was to raise the cost of the loan from 13.33 per cent to 14.29 per cent. This results from the fact that the firm pays interest on the same amount of funds as before (Rs 222,222); however, this time they get the use of Rs 13,333.32 less, or $\text{Rs } 200,000 - \text{Rs } 13,333.32 = \text{Rs } 186,666.68$.³

³ If M&M needs the use of a full Rs 200,000, then they will have to borrow more than Rs 222,222 to cover both the compensating balance requirement and the discounted interest. In fact, the firm will have to borrow some amount B such that

$$B - .10 B - (.12 \times \frac{1}{2}) B = \text{Rs } 200,000$$

$$.84 B = \text{Rs } 200,000$$

$$B = \frac{\text{Rs } 200,000}{.84} = \text{Rs } 238,095$$

The cost of credit remains the same at 14.29 per cent, as we see below:

$$\text{RATE} = \frac{\text{Rs } 14,285.70}{\text{Rs } 238,095 - \text{Rs } 23,810 - \text{Rs } 14,285.70} \times \frac{1}{18/360} = .1429, \text{ or } 14.29 \text{ per cent}$$

Compensating Balances

Banks require client firms with a line of credit or a revolving credit arrangement to maintain a current account or demand deposit balance that is related either to the credit limit or to the amount borrowed. The required balances are called compensating balances and under some circumstances have the effect of raising the interest rate on the loan. The usual practice is for banks to require that 10 to 20 per cent of the borrowed on a line of credit be kept as a demand deposit balance.

Assume that a firm borrows Rs 2 crore on a line of credit and the lending bank requires a 15 per cent credit balance; 15 per cent of this Rs 2 crore loan, or Rs 30,00,000, will have to be kept in the firm's current account at the bank to meet the compensating balance requirement. Whether this compensating balance raises the interest rate on the loan is dependent on whether the firm has a need to maintain a cash balance of Rs 300,000. Assume that the interest rate on the loan is 8 per cent. The firm wants to maintain a minimum balance of Rs 37,00,000 in its unit account. In this case meeting the compensating balance requirement does not increase the interest rate on the credit line.

Next, assume that the firm has no need to maintain any unit account balance at the lending bank. By maintaining a compensating balance of 15 per cent of the loan, it is effectively getting to use only $100 - 15 = 85$ per cent of the loan. However, the interest rate is applicable on 100 per cent of the loan. Therefore, the effective interest is higher than 8 per cent and is given by effective interest rate

= stated interest rate / $1 - \text{compensating balance fraction}$

= $8\% / 1 - 0.15 = 9.4\%$

The effective interest rate is 9.4 per cent.

Firms borrowing on a line of credit can try to reduce the effective interest rate by shifting some of their cash maintenance needs to the bank where they have their line of credit. The effective interest rate can also be lowered by securing a line of credit at the bank where the firm conducts the majority of its cash receipts and disbursements transactions.

Interest Rates on Unsecured Loans

Interest rates on unsecured loans are negotiated between the bank and the client firm. In general, though, the interest rate is related to the client's credit worthiness. The most creditworthy clients pay the *prime rate*. The prime rate is the lowest rate applicable to business loans. The lower the credit worthiness of the firm, the higher the interest rate the bank is going to charge on unsecured loans. The interest rates applicable to a firm's are determined by the bank's risk classes and loan pricing matrix.

Risk Classes. Bank typically classify credit applicants into a series of risk classes. The balances may also use Credit Rating Agencies ratings to supplement than credit worthiness. Selected risk categories which may be maintenance as follows:

- Class 1. Highest rated. Long-term debt is AAA or AA rated. Stable cash flows, interest coverage.
- Class 2. High quality. Long-term debt is rated A. Good interest coverage.
- Class 3. Upper-medium quality. Debt is rated A. Interest coverage, though good, may be impaired under adverse economic conditions.
- Class 4. Medium quality. Debt is rated BBB. Adequate interest coverage. Access to alternative financial markets limited except during favourable economic periods.
- Class 5. Lower-medium quality with debt rated at BB or B. Interest coverage is acceptable but is subject to severe fluctuations.
- Class 9. Collections of loans is questionable. Not enough collateral to cover existing debt.
- Class 10. Debt is not collectible.

Loan Pricing Matrix. Once a credit applicant has been assigned a risk class, the interest rate applicable will be established from using a loan-pricing matrix. The loan-pricing matrix of a bank is shown in Table 3. According to this loan pricing matrix, a firm in risk class 3 that borrows on a line of credit would be paying the prime rate plus 0.7 per cent as interest rate on its loan. A firm in risk class 4, seeking an unsecured transaction loan for 60 days, would incur an interest rate of prime plus 1.5 per cent.

The assignment to risk classes is based strictly on conservative financial considerations. On occasions the bank may feel that the need to develop the market for the bank’s commercial lending practices requires that marketing considerations be given precedence over financial considerations. A risk class 2 firm may find that a bank, eager to land its borrowing business, is willing to assign the firm to risk class 1. However, very rarely if ever will a bank be willing to treat a risk class 9 or 10 firm as a risk class 5 firm.



Type of Loan Rick Class

Type of Loan	Rick Class				
	1	2	3	4	5
Unsecured for up to 90 days	P	P	P + 1.50	P + 1.50	P + 2.25
Secured, for up to 90 days	P	P	P + 1.00	P + 1.00	P + 1.50
Unsecured, for 90 days to 1 year	P	P + 0.25	P + 1.75	P + 1.75	P + 2.50
Secured, for 90 days to 1 year	P	P + 0.25	P + 1.50	P + 1.50	P + 2.25

^a P stands for the lending rate at the time loan is issued. Interest rate are in per cent.

Concept of Credit Quality

The credit quality of a prospective business borrower is revealed to the lending banker through inquiries made of the company's trade creditors; through reports requested of credit-rating agencies; through analysis of the company's financial statements; and by "trade comparison" - comparisons of the prospective borrower's financial situation with that of other similarly sized firms in the same general line of business activity.

Required Security

There are four basic types of securities the bank can ask for:

1. **Hypothecation:** A charge that is made against movable property (like inventory) for an amount of debt where neither the ownership nor possession is passed to the creditor. Banks generally grant hypothecation on the basis of its satisfying itself with the quality of the assets.
2. **ledge:** Under this arrangement the borrower is required to transfer the physical possession of the property offered as a security to the bank to obtain credit. The bank retains the right to sell off the property to recover its dues if its loans are not paid on time.
3. **Mortgage:** It is the transfer of legal or equitable interest in a specific immovable property for the payment of debt. In case of mortgage, the physical possession of the property may remain with the borrower with the lender getting the full legal title.
4. **Lien:** Lien means right of the lender to retain property belonging to the borrower until he repays credit. It can be a particular lien in which the right is retained until the claim associated with the property is fully paid. General lien, on the other hand, is applicable till all dues of the lender are paid. Banks usually enjoy the facilities of general lien so as to more securely safeguard their interests.

A combination of 1 and 4 above is used in India.

Public deposits

Public deposits, also known as fixed deposits, had been an important source of raising money for working capital. But because of many scams of the finance companies, the term fixed deposits earned so much bad publicity that it is now only used by companies with good credit standing. However, the market is quite small now compared to the one that existed earlier.

Inter Corporate Deposits

One of the most utilised money market instruments, ICDs are the hallmark of lending and borrowing between companies and high-networth individuals. Usually backed by a security, (typical security being shares) ICD is normally for three months, but higher and shorter periods are also prevalent depending upon the needs. Normally the maximum time frame of an ICD is six months. But ICDs are rollable (turned over from one period to another) and can extent to any period with the mutual consent of the lender and the borrower.

It is one of the instruments which many cash rich corporates like to park their funds in as the security is good and the interest rate is much higher than what they would get from banks for the same time period. Risks of default are also much higher and it is normally not possible to offload the securities in the market, as the market may not be able to absorb the same.

Importance of personal contacts cannot be denied as this market operates from word of mouth and no advertising is done because it could harm the reputation of the corporate borrowing through ICDs. One of the top criteria for getting ICDs is the credibility of the company in the market, the lessor the credibility the lower the chances of getting the ICDs and the higher the interest rate the company may have to pay.

Short Term Loans from Financial Institutions

Although Bank Finance is one of the most important source of working capital funds, money market is no less important. Money market is useful when the company does not require a continuous source of working capital and is need of funds for only some time. For this short term needs, which are over and above its normal needs of working capital, going to banks is infeasible because either the limits with the banks have already been exhausted or the process is so long that by the time the bank sanctions, the situation for which the funds were required may already be gone.

Short term loans can be raised using highly liquid debt securities that have short terms until they mature. They are known as money market instruments. All money market instruments are debts that mature within 364 days or less.

Money market securities normally pay fixed rate of interest that is above the rate paid by them for normal working capital financing. This is because the need is for shorter duration and the risk of default is higher.

Money market instruments can pay interest, to their investors, as a discount from their face (or maturity) values or on the maturity return both the principal and the interest together.

A short-term loan is one having a maturity of less than one year. Loans maturing within 1 to 10 years are considered to be intermediate-term or *term loans*. Sources for term loans are banks, insurance companies, and pension funds. Some of the more important characteristics of term loans are discussed in the following paragraphs.

Characteristics of Term Loans

Term loans are different from other types of loans in a variety of ways including maturity, repayment schedule, collateral, costs, and provisions.

Maturity. As stated previously, the maturity for a term loan varies from 1 to 10 years. The 10-year limit is somewhat arbitrary in classifying a loan as a term loan. However, in recent years financial institutions are becoming less reluctant to issue term loans with maturities up to 10 years. The classification of loans with maturities of up to 10 years as term loans is becoming very common. The maturity of a term loan is dependent upon the financial institution lending the funds. Banks are generally reluctant to issue term loans with maturities in excess of 5 to 6 years. On the other hand, insurance companies and pension funds frequently underwrite term loans with maturities of 10 years.

Repayment Schedule. Short-term loans are generally repaid as the firm generates excess cash flows. Long-term loans are generally repaid in full at maturity. Term loans are typically repaid according to a specified schedule. The most typical situation requires fixed payments, which include both principal and interest, on a monthly, semiannual, quarterly, or annual basis. The size of the periodic payment is such that when the last payment is made, the loan is fully paid and the lender is provided his required return. The repayment of term loans is discussed in the following section.

The particular procedure of making equal payments periodically to repay a loan is called loan amortisation. For example, a company borrows Rs 800,000 for 10 years and makes year-end equal payments of Rs 124,655.25 every year for 10 years. At the end of the tenth year the loan will have been fully repaid and will have provided the lender a 9 per cent interest rate. On rare occasions the loan amortisation is such that only a portion of the loan is repaid, leaving a large or “balloon” final payment. For example, the lender and borrower by mutual agreement may amortise only Rs 600,000 of the Rs 800,000 loan. In this case the 10 annual payments would be Rs 111,491.44 each. The borrower would also have to repay the unamortised Rs 200,000 portion of the loan at the end of the tenth year. Both of these examples are explained in the next section.

Collateral. Financial institutions underwriting term loans generally require collateral on the loans. Since these loans are used for specific purposes such as purchase of computers

machinery, and so forth, the loans can be readily secured by the new equipment being purchased. Occasionally, stocks bonds, real estate, and other assets are also used as collateral for term loans.

Costs. The interest rate on a term loan is usually higher than the interest rate on short-term loans. Term loans rates also reflect the credit worthiness of the borrower and the liquidity and marketability of the collateral used to secure the loan. For a financially sound borrower, the term loan rate will be about 0.5 per cent higher than the prime lending rate.

Interest rates on term loans can either remain fixed for the duration of the loan or vary with changes in the prime rate. If the term loan has a variable interest rate, then the loan agreement may also specify the “floor” and “ceiling” rates. For example, a term loan agreement may provide that the interest on the unamortised portion of the loan will be at a prime plus 0.5 per cent rate but in no case will be higher than 10 per cent or lower than 7 per cent. In this case the 7 and 10 per cent rates are the floor and ceiling rates, respectively.

In addition to interest expense, term loans may entail other costs. The lending institution may charge a moderate loan commitment fee. Occasionally, the lending institution may require that warrants or options to buy common stock at specified prices be provided by the borrower. This allows the lender to participate in the anticipated growth of the borrower’s business. Insurance companies providing term loans prefer to use this device to gain additional returns.

Provisions. Financial institutions making term loans need to assure themselves that the borrower continues to have the potential to make interest and principal payments at the scheduled intervals. This need to secure their financial position leads term lenders to incorporate a variety of provisions in the lending agreement. These provisions are designed to provide the lender with timely financial information about the borrower and to impose certain restrictions on the borrower. For example, the lending arrangement may require the borrower to maintain a *minimum current ratio*. If the borrower’s current ratio falls below the minimum level, then, at its option, the lender may require immediate payment of the unamortised portion of the term loan.

Another provision regulates the amount of new long-term debt that the borrower can acquire. This provision typically requires that the borrower must secure the lender’s approval before the borrower can issue any new long-term debt or sign leases. This provision allows the lender to exercise control over the borrower’s indebtedness and to keep the borrower from becoming too indebted.

Another common term loan provision requires the borrower to provide the lender with

periodic sheets, income statements, cash budgets and sources, and uses of funds statements. This allows the lender to monitor the borrower's financial condition and to take or suggest corrective actions when needed.

Finally, the term loan agreement may also require the borrower to not make changes in its executive ranks without the lender's permission. The lender may also require sufficient life insurance on the borrower's key managerial personnel. These provisions are designed to protect the lender from losses resulting from unforeseen changes in the borrower's important personnel.

Repaying Term Loans

Term loans are generally repaid on a periodic, systematic basis. Term lenders prefer this procedure because it enhances the borrower's capability to repay the loan. A large lump-sum loan repayment at maturity may place a heavy financial burden on the borrower, whereas with small periodic payments the borrower is not unduly financially burdened. A second reason for amortising loans has to do with the use of funds from the loans. Term loans are usually obtained for purchasing equipment. Loan amortisations are more desirable because loan repayments can be geared to the cash flows being generated by the equipment.

In this section two different loan amortisation procedures will be considered full amortisation and one that results in a balloon payment.

Full Amortisation. Under full amortisation, the borrower makes periodic payments until the loan and interest is fully paid. To explain the example cited previously, assume that Central Manufacturing Corporation borrows Rs 800,000 for 10 years at an interest rate of 9 per cent. The interest rate is the effective interest rate on the remaining balance. In addition, the bank making this term loan requires that the loan be repaid in 10 equal installments which would include interest as well as payment on the principal.

The annual payment required to repay this loan can be determined by using Equation. 8, which we renumber 1 for convenience.

$$P_0 = P \times IFAP_{n/i} \quad (1)$$

where P_0 is the present value of an annuity of P rupees receive every year for N years and discounted at one per cent. In the term loan situation the annual payment is P rupees and is found by

$$P = P_0 \times IFA_{n/i} \quad (2)$$

In the example cited, P_0 is Rs 800,000. The annuity factor, rounded off to four decimal places, for Re 1 received every year for 10 years and discounted at 9 per cent is shown as 6,4177 in Appendix B. Then P is

$$P = \text{Rs } 800,000 / 6.4177 = \text{Rs } 124,655.25.$$

After Central has made 10 annual payments of Rs 124,655.25, it will have fully repaid the term loan and the bank will have been provided with its 9 per cent interest rate.

Table 4 shows how this annual payment is divided between interest and payment on principal. At the time of loan, or at time O, the beginning balance is Rs 800,000. At the end of the first year an annual payment of Rs 124,655.25 is made. This amount includes interest of $\text{Rs } 800,000 \times 0.09\% = \text{Rs } 72,000$. The remaining payment, $\text{Rs } 124,655.25 - \text{Rs } 72,000 = \text{Rs } 52,655.25$ is applied to the beginning balance to pay off a portion of the loan. The first-year ending balance is $\text{Rs } 800,000 - \text{Rs } 52,655.25 = \text{Rs } 747,344.75$. The first-year ending balance becomes the second-year beginning balance. Interest on this is computed at 9 per cent. The difference between the second-year payment and interest is used to reduce the second-year beginning balance. This process continues until the final payment is made at the end of the tenth year and the loan is completely repaid.

1	2	3	4=2×0.09	5=3-4	6=2-5
End of Year Balance	Beginning Balance	Annual Payment	Interest at 9 %	Loan Repayment	Ending Balance
0	Rs 800,000.00	Rs –	Rs –	Rs –	Rs –Rs 800,000.00
1	800,000.00	124,655.25	72,000.00	52,655.25	747,344.75
2	747,344.75	124,655.25	67,261.03	57,394.22	689,950.53
3	689,950.53	124,655.25	62,095.55	62,559.70	627,390.83
4	627,390.83	124,655.25	56,465.17	38,190.08	559,200.75
5	559,200.75	124,655.25	50,328.07	74,327.18	484,873.57
6	484,873.57	124,655.25	43,638.62	81,016.63	403,856.94
7	403,856.94	124,655.25	36,347.12	88,308.13	315,548.81
8	315,548.81	124,655.25	28,399.39	96,255.86	219,292.95
9	219,292.95	124,655.25	19,736.37	104,918.88	114,374.07
10	114,374.07	124,655.25	10,281.18 ^a	114,374.07	—

^a For the tenth year only, interest is the difference between annual payment balance. This rounding-off error exists because only four decimals were utilised in the annuity factor used in computing the annual payment.

One word of caution related to Table 4 has to do with the rounding-off error. We used a rounded-off annuity factor of 6.4177 from Appendix B. the actual annuity factor is 6.4176550. Rounding off the annuity factor changes the annual payment slightly. The net cumulative result is that when one calculate the interest for the last year, it becomes $\text{Rs } 114,374.07 \times 0.09\% = \text{Rs } 10,293.67$. It should be recognised that minor errors are caused by rounding-off annuity and discount factors. This error is remedied by either using more significant decimals or by treating interest expense in the last year as a

residual item—the difference between the annual payment and the tenth-year beginning balance.

Balloon Payment Amortisation. On occasion firms prefer to amortise less than the full amount of the loan. Amortising only a portion of the term loan results in the firm's making a relatively large or “balloon” payment when the loan matures. One reason for doing this may be that the unamortised portion of the loan on maturity may equal the anticipated salvage value of the equipment to be purchased with the term loan. Another reason is that with a balloon payment the firm's annual payments are smaller, except of course for the last payment, which includes the unamortised loan. A firm may choose a balloon payment with the idea of refinancing the unamortised loan at maturity.

Assume that Central Manufacturing and the lending bank agree to amortise Rs 600,000 of the Rs 800,000, with the unamortised portion or Rs 200,000 due at the end of the tenth year. One way to evaluate this term loan is to view it as two separate loans—one for Rs 600,000 and one for Rs 200,000. The annual payment for Rs 600,000 portion is determined by using Equation 2;

$$P = \text{Rs } 600,000 / 6.4177 = \text{Rs } 93,491.44$$

The Rs 200,000 portion is not repaid until the last year. Interest due every year for 10 years on this amount is $\text{Rs } 200,000 \times 0.09\% = 18,000$. Total annual payment for the first 9 years on this loan is $\text{Rs } 93,491.44 + \text{Rs } 18,000 = \text{Rs } 111,491.44$. The tenth and final payment would include the unamortised portion of the loan also and would equal $\text{Rs } 111,491.44 + \text{Rs } 200,000 = \text{Rs } 311,491.44$.

In this section we have considered two alternative, term loan repayment procedures. Variations would include situations in which the applicable interest rate is not fixed or the annual payment amount is not fixed. The technique for amortising term loans of these types is similar to the procedure outlined in Table 4.

Advantages and Disadvantages of Term Loans

As with any financing procedure, term loans are not without their advantages and disadvantages.

Advantages. The relationship between borrower and lender is one-to-one, and it is easy for them to negotiate loans terms that meet the special need of the borrower. Repayment schedules, annual payments, and maturity date can be negotiated to meet the borrower's needs. The borrower also finds it easy to negotiate with one lender and does not have to go through a Securities and Exchange Commission registration as is the case with typical bond financing. The lending institution also may not seek certain financial information that the firm may be hesitant to divulge. Term loans can be arranged

more quickly than long-term loans. The firm or borrower is assured to funds for a number of years, which is not the case with borrowing on a credit line. Finally, smaller firms with limited access to capital markets find term loans very convenient.

Disadvantages. The borrower may feel that, at times, term loan provisions are too restrictive. The limitations on issuing new debt may hinder the firm's ability to finance future growth. Another disadvantage of term loans is that at times the cost may be high. If the loans involve issuance of options on warrants that are exercised, then the affective cost of the loan to the borrower increases. Despite these disadvantages, term loans are a major source of financing.

Debentures for working capital

Debentures have been traditionally used for long term funding the capital projects, but they can also be used for funding short term requirements of working capital and become the part of long sources used for funding working capital requirements. Funding is used by corporates for a medium time frame and hence are a stable source of funds.

Commercial Paper

CP refers to the short-term promissory notes issued by "blue-chip" corporations - large, old, safe, well known companies like TISCO, ONGC, SAIL, etc. The maturities normally vary from 90 to 180 days as compared to US where the maturity period ranges from 5 days to 270 days, and the denominations are for a minimum of Rs 10 lac or more - usually more. These notes are backed only by the high credit ratings (normally P1+ the highest grade available) of the issuing corporations which means that there is no security given by the company when issuing CP.

CPs are normally issued at a discount to its face value and are redeemed at the face value.

Credit Terms

The maturity of this credit source is generally six months or less, although some issues carry 270-days maturities. The interest rate on commercial paper is generally slightly lower (one-half to one per cent) than the prime rate on commercial bank loans. Also, interest is usually discounted, although commercial paper is available at times that is interest bearing.

New issues of commercial paper are either directly placed (sold by the issuing firm directly to the investing public) or dealer placed. Dealer placement involves the use of a commercial paper dealer, who sells the issue for the issuing firm. Many of the major finance companies place their commercial paper directly. The volume of direct versus

dealer placements is roughly four to one in favour of direct placements. Dealers are used primarily by industrial firms that make only infrequent use of the commercial paper market or that, owing to their small size, would have difficulty placing the issue without the help of a dealer.

Commercial Paper as a Source of Short-term Credit

A number of advantages accrue to the user of commercial paper:

Using commercial paper for short-term financing, however, involves a very important risk. That is, the commercial paper market is highly impersonal and denies even the most creditworthy borrower any flexibility in terms of repayment. When bank credit is used, the borrower has someone with whom he can work out any temporary difficulties he might encounter in meeting a loan deadline. This flexibility simply does not exist for the user of commercial paper.

Estimating the Cost of Commercial Paper

The cost of commercial paper can be estimated using the simple effective cost of credit equation (RATE). The key points to remember are that commercial paper interest is usually discounted and that if a dealer is used to place the issue a fee must be paid. Even if a dealer is not used, the issuing firm will incur costs associated with preparing and placing the issue, which also must be considered in estimating the cost of credit.

Example: The EPG Mfg. Company uses commercial paper regularly to support its needs for short-term financing. The firm plans to sell Rs 100 crore in 270-day-maturity paper on which it expects to have to pay discounted interest at an annual rate of 12 per cent per annum. In addition, EPG expects to incur a cost of approximately dealer placement fees and other expenses of issuing the paper. The effective cost of credit to EPG can be calculated as follows:

$$\text{RATE} = \frac{\text{Rs 9 crores}}{\text{Rs 100 crores} - \text{Rs 100,000} - \text{Rs 9 crore}} \times \frac{1}{270/360} = .1320, \text{ or } 13.20 \text{ per cent}$$

Where the interest cost is calculated as $\text{Rs 100 crore} \times .12 \times 270/360 = \text{Rs 9}$. Thus, the effective cost of credit to EPG is 13.2 per cent.

CPs have to be credit rated in India. The highest credit rating holder corporates are issuing CPs at around 8-12 % at this moment, which is much lower than the interest rate they would have paid if they had gone through either the ICD market or the bank finance route. Still CPs are not utilised to their maximum possible extent as the banks do not like to fund through them because they lose on the interest they could have charged if the corporates went through bank finance instead.

Pledging Accounts Receivable

After cash and marketable securities, accounts receivable are considered to be the most liquid assets on a firm's balance sheet. A financial institution such as a bank or finance company will readily make a loan secured by accounts receivable. The lender will evaluate the quality of the receivable to be pledged and the average size of account pledged. Once these have been established, the pledging procedure can be implemented. These steps are explained in the following paragraphs.

Quality of Receivables Pledged. The lending institution is gone to evaluate thoroughly the quality of the receivables the borrower wants to pledge. If, on the average, the receivables appear to be of very high quality with almost a 100 per cent probability of payment, the lender may loan up to 90 per cent of the face amount of the receivables pledged. If the receivables appear to be of relatively low quality, the lender may be willing to lend only 25 per cent of the face value of the receivables. The higher the receivable quality, the higher their loan value.

Although a lender may be willing to lend anywhere from 25 to 90 per cent of the face value of the receivables pledged, he retains the right to reject any receivable that he does not wish to accept as a pledge. In addition, the lender holds the borrower liable for any accounts that become delinquent or default after they have been pledged.

Size of Accounts. Pledging receivables involves a considerable amount of record keeping for the lender. These record-keeping costs remain relatively constant irrespective of the rupee amount of the account being pledged. Smaller-size accounts cost more per rupee of loan than larger-size accounts. A firm with a lot of small-size accounts receivable will find it difficult to raise funds by pledging receivable at a reasonable cost. A firm may be able to negotiate a "floating lien" loan with a lending institution. With a floating lien the lender does not maintain records on individual accounts. Rather, a general lien is assigned to all receivables. Since the lender is not tracking individual accounts under a floating lien the chances of fraud by the borrower are higher than with specific pledging of accounts. As a precaution against exposing itself to undue risk, a lender will rarely lend more than 25 per cent of the face amount of receivables subject to a floating lien.

Pledging Procedure. Once the loan value of receivables has been established, the borrower sends to the lender a list of accounts, billing dates, and amounts involved. Assume that the lender has agreed to lend 80 per cent of the face value of receivables pledged. The borrower sends to the lender a schedule of accounts totalling Rs 1 crore. The borrower is now eligible to borrow any amount up to 80 per cent of Rs 1 crore, or Rs 80,00,000, upon signing a promissory note.

Pledging of receivables can be either on a notification or non-notification basis. On a *notification* basis the borrower notifies its accounts that payments on the receivables are to be made directly to the lender. On a *non-notification* basis the account is not informed of the financial arrangements between borrower and lender. The account remits payments to the borrower, who forwards it to the lender. The lender then checks the payment against the schedule provided by the borrower and reduces the borrower's loan balance by a corresponding amount. When pledging receivables is on a non-notification basis, the lender relies on the borrower to forward account payments to him. Should the borrower keep the checks, the lender would be ultimately holding "receivables" that have been paid. To prevent fraud of this nature, non-notification pledging allows the lender to randomly audit the borrower's books to see that payments on all pledged accounts are being forwarded to the lender.

The lender will also adjust the rupee value of accounts pledged for any discrepancies between the amount invoiced and the amount paid. These discrepancies are caused by the account taking a cash discount for early payment, taking credit for merchandise returned or adjusting for other invoice errors.

Interest Rates. Interest rates with pledged receivables financing are 2 to 4 per cent higher than the prime-lending rate. The lending institution may also charge a processing fee, which may equal 1 to 3 per cent of the average annual loan. Commercial finance companies charge rates that are higher than the rates charged by banks. The total effective interest with this type of receivables financing will vary from 10 to 20 per cent. This high interest rate does not imply that secured loans are more expensive than unsecured loans. The rates are high because the borrower is risky and does not have access to normal sources of unsecured loans.

Factoring

Factoring is an arrangement between the company and the factor (another company providing factoring services) in which the factor agrees to buy the bills receivable of the company for a commission and an interest for the period for which he is expected to keep the bills before receiving payments from the parties on whom the bill is drawn.

Factoring can be on recourse basis (in which the risk of default is borne by the company) or without recourse (in which the risk of default is borne by the factor himself). The biggest benefit of factoring is that the receivables can be converted into cash and redeployed into the business. The most negative aspect is that the interest rate is higher than most other short-term debt instruments because it depends upon the quality of the parties on which the bills are drawn (except ICDs where it is equivalent). Hence company going in for factoring is looked down upon considering the fact that the company was

not able to mobilise the required funds from the normal short-term sources.

While the book debt purchasing is fundamental to the functioning of factoring, the factor can provide three other basic services to the companies:

- Sales ledger administration and credit management
- Credit collection and protection against default and bad debt losses
- Financial accommodation against the assigned book debts

In developed countries like the US the factors provide various other services in addition to the basic services mentioned above. They include:

- i. Providing information on the prospective buyers
- ii. Credit risk management
- iii. Financial counselling

There are seven different types of factoring services available abroad. The brief comparison of them is tabulated below:

Types of Factoring	Types of Services				
	Availability of Finance	Protection against bad debts	Notification to debtors	Sales ledger administration	Collection
1. Full non-recourse factoring	Y	Y	Y	Y	Y
2. Recourse factoring	Y	N	Y	Y	Y
3. Bulk factoring	Y	N	Y	N	N
4. Maturity factoring	N	Y	Y	Y	Y
5. Agency factoring	Y	S	Y	S	N
6. Invoice discounting	Y	N	N	N	N
7. Undisclosed factoring	Y	S	N	N	N

Y = Provided, N = Not Provided, S = Sometimes Provided

Factoring is different from bill discounting in the aspect that bill discounting is just providing a credit on the bills without any onus on the company providing the credit to collect or manage the receipts. Bill discounting is termed as Invoice discounting in the above table and you can yourself see that apart from providing finance it offers no other service which full non-recourse factoring provides.

Still the biggest benefit of going for factoring to a specialist organisation is that the

company gets specialised service in credit management which helps it save costs in credit administration as also helps the company concentrate on other areas of operations.

Inventory Loans

Inventory loans provide a second source of security for short-term secured credit. The amount of the loan that can be obtained depends on both the marketability and perishability of the inventory. Some items, such as raw materials (grains, oil, lumber, and chemicals), serve as excellent sources of collateral, since they can easily be liquidated. Other items, such as work-in-process inventories, provide very poor collateral, owing to their lack of marketability.

There are several methods by which inventory can be used to secure short-term financing. These include a floating or blanket lien, chattel mortgage, field warehouse receipt, and terminal warehouse receipt.

Floating Lien Agreement

Under a floating lien agreement the borrower gives the lender a lien against all his inventories. This provides the simplest but least secure form of inventory collateral. The borrowing firm maintains full control of the inventories and continues to sell and replace them as it sees fit. Obviously, this total lack of control over the collateral greatly dilutes the value of this type of security to the lender. Correspondingly, loans made with floating liens on inventory as collateral are generally limited to a relatively modest fraction of the value of the inventories covered by the lien. In addition, floating liens usually include future as well as existing inventories.

Chattel Mortgage Agreements

The lender can increase his security interest by having specific items of inventory identified (by serial number or otherwise) in the security agreement. Such an arrangement is provided by a chattel mortgage. The borrower retains title of the inventory but cannot sell the items without the lender's consent. This type of agreement is very costly to implement, as specific items of inventory must be identified; thus, it is used only for major items of inventory such as machine tools or other capital asset.

Field Warehouse Financing Agreements

Increased lender control over inventories used as loan collateral can be obtained through the use of a field warehouse agreement. Here the inventories used as collateral are physically separated from the firm's other inventories and placed under the control of a third-party field warehousing firm. Note that the inventories are not removed from the borrower's premises, but they are placed under the control of a third party who is

responsible for protecting the security interests of the lender. This arrangement is particularly useful where large bulky items are used as collateral. For example, a refinery might use a part of its inventory of fuel oil to secure a short-term bank loan. Under a warehousing agreement the oil reserves would be set aside in specific tanks or storage vessels, which would be controlled (monitored) by a field warehousing concern.

The warehousing concern, upon receipt of the inventory, takes full control of the collateral. This means that the borrower is no longer allowed to use or sell the inventory items without the consent of the lender. The warehousing firm issues a warehouse receipt for the merchandise, which carries title to the goods, represented therein. The receipt may be negotiable, in which case title can be transferred through sale of the receipt, or nonnegotiable, whereby title remains with the lender. With a negotiable receipt arrangement the warehouse concern will release the goods to whoever holds the receipt, whereas with a nonnegotiable receipt the goods may be released only on the written consent of the lender.

The cost of such a loan can be quite high, since the services of the field warehouse company must be paid for by the borrower.

Example: The M.M. Company follows a practice of obtaining short-term credit based on its seasonal finished goods inventory. The firm builds up its inventories of outdoor furniture throughout the winter months for sale in spring the summer. Thus, for the two-month period ended March 31, it uses its fall and winter production of furniture as collateral for a short-term bank loan. The bank lends the company up to 70 per cent of the value of the inventory at 14 per cent interest plus a fixed fee of Rs 2000 to cover the costs of a field warehousing arrangement. During this period the firm usually has about Rs 200,000 in inventories, which it borrows against. The annual effective cost of the short-term credit is therefore.

$$\text{RATE} = \frac{\text{Rs } 3267 + \text{Rs } 2000}{\text{Rs } 140,000} \times \frac{1}{60/360} = 22.57 \text{ per cent}$$

where the financing cost consists of two month's interest $\text{Rs } 140,000 \times .14 \times 60/360 = \text{Rs } 3267$) plus the field warehousing fee of Rs 2000.

Terminal Warehouse Agreements

The terminal warehouse agreement differs from the field warehouse agreement just discussed in only one respect. Here the inventories pledged as collateral are transported to a public warehouse that is physically removed from the borrower's premises. An added degree of safety or security is provided to the lender, as the inventory is totally removed from the borrower's control. Once again the cost of this type of arrangement

is increased by the necessity for paying the warehouse concern; in addition, the inventory must be transported to and eventually from the public warehouse.

The same warehouse receipt procedure described earlier for field warehouse loans is used. Again, the cost of this type of financing can be quite high.

Lease Financing

Firms are generally interested in acquiring the use of equipment. One way to acquire use is to buy the equipment. The same result can also be achieved by leasing the equipment. A lease is a contractually established obligation by the lessee to pay the lessor a series of payments for the use of certain assets. In this section we shall consider types of leases, lease capitalisation's, and the advantages and disadvantages of leasing.

Type of Leases

There are two major types of leases—operating and financial.

Operating Lease. An operating or service lease is one that allows the lessee at his convenience. Telephone service is an example of an operating lease. The telephone user can, at his or her convenience, discontinue telephone service. Another example of a service lease is leasing copying equipment from companies such as Xerox Corporation and A. B. Dick Corporation. These companies typically lease their equipment on a 30 day cancellation notice basis. If a lessee cancels a service lease, the equipment is leased to another lessee. The lessor expected to recover the costs plus profits over the economic life of the equipment. Operating lease payments usually include charges for servicing and maintaining the leased equipment.

Financial Lease. A financial lease is a non-cancelable, contractual obligation of the lessee to pay the lessor a fixed amount for a specified time period for the use of certain assets. A financial lease includes the following features:

1. The lease is non-cancelable. The lessee cannot “walk away” from the lease without becoming liable for the remaining lease payment.
2. The lease is fully amortised. A fully amortised lease is one that returns to the lessor all his costs plus a reasonable return.
3. A financial lease does not include repair and maintenance services. A variation of the financial lease in which the lessor pays the maintenance and insurance costs is called a maintenance lease.

A special type of financial lease is a sale and leaseback arrangement. In a sale and leaseback a firm sells an asset to another firm, who leases the asset back to the first firm. Special features of a sale and leaseback arrangement are as follows:

1. Assets involved can be either old or new. A firm could sell an old fully depreciated plant and then lease it back. Another firm could buy a new IBM computer, sell it to a finance company, and then lease it right back.
2. Assets are sold at or close to appraised market value.
3. The leaseback arrangement calls for lease payments that return all costs plus a fair return to the lessor. That is, the lease is fully amortised.

Sale and leaseback arrangements and financial leases are identical. The practical distinction is that financial leases involve assets new to the firm whereas sale and leasebacks typically involve assets that the firm is already using.

Internal Revenue Service Lease Requirements

The total amount of a lease payment is tax deductible, provided that the lease qualifies as a bonfire lease. Without this IRS safeguard some firms would have a tendency to call an installment sale a lease, say an equipment has a useful life of 20 years and is being purchased on a 10-year installment loan plan. The company conceivably could write up the sale as a lease with the installment loan payments being called lease payments. When the installment loan is fully paid—that is, when the “lease” obligations are met—the buyer could buy the residual rights to the equipment for a nominal amount of Re. 1. If the IRS were to let this installment sale qualify as a lease, it would put other firms at a competitive disadvantage. The reason is that while other firms are writing off the asset over 20 years, this firm by expensing the “lease” payments would be depreciating the asset over 10 years. It would be underpaying its taxes and increasing its net cash flows. To prevent this type of abuse, the IRS requires that the following criteria be met before a “lease” qualifies as a lease and not an installment loan:

1. Lease obligation must be for less than 30 years.
2. The lease must provide a fair return to the lessor.
3. Any lease renewal option granted to the lessee must not be different than one that would be provided to a third party.
4. Any purchase option granted to the lessee must not be different than one that would be provided to a firm not a party to the lease.

If these criteria are not met, the lease does not qualify as a bonfire lease and the lease payments are not fully tax deductible. A leasing arrangement that does not meet IRS criteria for a lease is treated as a purchase financed through an installment loan. The tax deductions are the same as for any other equipment purchase, that is, depreciation, interest expense, and so forth.

Lease Capitalisation's

Financial leases call for the lessee to make periodic payments to meet contractual obligations. As such it is not conceptually different from a loan. Lease capitalisation involves capitalising the lease payments at an appropriate capitalisation rate and showing the capitalised amount as a liability. An entry equal to the capitalised lease obligations is shown on the assets side of the balance sheet.

The capitalisation rate is generally equal to the lessee's marginal cost of borrowing. For example, a corporation leases a computer system for 6 years. Lease payments are to be made in six annual payments of Rs 340,000 each. The first payment is made on the day that the computer is installed. The second payment is due 2 years from today, and so on. Payments three through six are capitalised at the firm's marginal borrowing rate of 9 per cent. The capitalised value of payments 3 through 6 is $\text{Rs } 340,000(0.84168 + 0.77218 + 0.70843 + 0.64993) = \text{Rs } 1,010,555$. The balance sheet entry for this leasing transaction would be

Assets		Liabilities	
Net leased assets	Rs 1,350,555	Current liabilities	
		Lease obligation	Rs 340,000
		Long-term liabilities	
		Lease capitalisation	Rs 1,010,555

These entries would be adjusted each year as the firm makes its lease payment.⁴ keep in mind that the net capitalised value of the lease of $\text{Rs } 1,350,555 + \text{Rs } 340,000 = \text{Rs } 1,690,555$.

Cost of Leasing

The typical situation in leasing involves a decision either to borrow and buy or to lease the equipment. The best alternative of buying or leasing is the one with the highest net present value. This situation is discussed in the last section of the chapter. Another situation could be when the item available is for lease only and cannot be purchased. Here the leasing analysis becomes intermingled with the capital budgeting decision itself. All leases, however, involve, a rate of return to the lessor. One way to conceptualise a before-tax cost of leasing is to view the lessor's cost of leasing. Consider the computer system lease example given previously. Assume that the computer system costs the lessor Rs 1.68 crore and that the investment tax credit is passed along to the lessee. Maintenance and service costs are also borne by the lessee. From the lessor's viewpoint, the lease involves an outflow of Rs 1.68 crore at $t = 0$ for the purchase, an inflow of Rs

340,000 at $t = 0$ from the first lease payment, another Rs 340,000 at $t = 1$ for the second payment, and so on. The rate of return for the lessor is that discount rate which equates the sum of the present values of lease payments with Rs 1.68 crore. Or

$$\begin{aligned} \text{Rs } 1,680,000 &= E^5_{t=0} \text{Rs } 340,000 (1+r)^{-t} = \text{Rs } 340,000 (E^5_{t=0} (1+r)^{-t}) \\ &= \text{Rs } 340,000 (1 + E^5_{t=1} (1+r)^{-t}) \quad (3) \\ &= \text{Rs } 340,000 (1 + \text{IFA}_{5/r}) \end{aligned}$$

Equation 3 can be restated in terms of the annuity factor IFA as

$$\text{IFA}_{5/r} = (\text{Rs } 1,680,000 / \text{Rs } 340,000 - 1) = 3.94118 \quad (4)$$

From Appendix B IFA (5 year/8 per cent) is 3.99271 and IFA (5 year/9 per cent) is 3.88965. By interpolation r is found to be 8.5 per cent. A way of identifying the leasing cost is to consider this 8.5 per cent return to the lessor as the lessee's cost of leasing. It should be recognised that in calculating the cost of leasing this way, we are ignoring tax effects and consequently depreciation as a tax shield. This method, however, does provide us with a reasonable perspective on leasing cost.

Equation 4 can be generalised to estimate the lessor's rate of return on any lease. If it is assumed that the first lease payment is made at the time the equipment is installed, then

$$\text{IFA}_{n-1/r} = C/L - 1 \quad (5)$$

Where

n = length of lease

C = cost of equipment

L = annual lease payment

r = lessor's rate of return on the lease

The annuity factor can be used in conjunction with Appendix B to solve for r as shown in the example given previously.

One interesting factor to note is that the gross lease capitalised value does not necessarily have to equal the cost of the equipment being leased. The answer lies in the fact that the lessors' rate of return is generally different from the lessee's lease capitalisation rate.

Advantages and Disadvantages of Leasing

Leasing equipment possesses a variety of advantages and disadvantages for the lessee.

Advantages of Leasing. Lease financing is viewed to possess a number of advantages for the lessee. Perhaps one of the major advantages of leasing is that it provides for the use of equipment with 100 per cent debt financing. That is, a firm that is leasing equipment does not have to make a down payment. Such is not the case when a firm borrows to buy the same equipment. Very rarely will a lending institution provide a loan equal to the purchase price of the equipment. More typically, it will require the firm to take an equity position equal to 10 or 20 per cent of the equipment's purchase price. Some, however, argue that this advantage may be illusory, because 100 per cent financing provided by leasing uses up more of the firm's debt capacity than buying the equipment with an 80 per cent loan.

The current trend in financial reporting is toward full disclosure of financial obligations created by leasing arrangements. Once firms are required to capitalise lease obligations and to integrate lease capitalisation's fully into their financial statements, the advantage of 100 per cent financing in leasing will diminish significantly.

Another advantage of leasing is that it provides the lessee with flexibility in acquiring the use of specialised equipment that may become obsolete for the lessee but may be still a productive asset for another firm. Items such as lessee but may be still a productive asset for another firm. Items such as computers and copying machines fall in this category. A third generation IMB equipment may become obsolete as far as a large manufacture is concerned but may be readily utilised by a small manufacturer. A firm may prefer to lease a computer and then let the lessor handle the subsequent lease of the computer to another firm. The lessor has specialised skills in doing this and can do a better job of leasing the equipment again.

Another advantage of leasing is that the provisions typically associated with term loans are not present in lease financing. A firm that does not wish to conform to minimum current ratio requirements, and so forth, may find the lack of these restrictions in lease financing to be a starring enough motive to prefer leasing to borrowing.

A final advantage in leasing is that the lessor and lessee can negotiate over who utilises the investment tax credit. A firm that is not able to fully utilise the tax credit may let the lessor retain the credit and settle for lower annual lease payments. This planning flexibility is not available with borrowing and buying when the tax credit goes to the buyer.

Disadvantages of Leasing. The major disadvantage of leasing is that the residual value of the leased asset at the termination of the lease belongs to the lessor. The typical leasing arrangement calls for a full amortisation of the cost of the equipment. One frequently encounters examples where the cost of leasing an automobile covers complete amortisation over 4 years of the automobile cost. If, after 4 years, the lessor

can sell the leased automobile for more than zero rupees, he or she gained at the expense of the lessee. Another example is full amortisation of costs in a sale and leaseback of a building and the land on which it is constructed. While the building will generally depreciate in value, very rarely will the land value decline to its eventual fully amortised cost of zero rupees.

Another disadvantage of leasing is that typically the lessor's rate of return is higher than the lessee's cost of borrowing.

This makes borrowing a more desirable alternative than leasing.

Regulation of Bank Finance – Recommendation of Latest Committee

Banks were tied by the guidelines issued by the Reserve Bank of India (RBI), which in turn has been influenced by various committees appointed by it from time to time. Now the RBI has considerably relaxed the rules, but the banks still stick to the guidelines to a high degree because shifting from protected to totally open environments is not easy and banks want to make the transition smoothly. We will first discuss the development of the guidelines through various committees.

The norms of working capital finance followed by banks since mid-70's were mainly based on the recommendations of the Tandon Committee. The Chore Committee made further recommendations to strengthen the procedures and norms for working capital finance by banks.

Chapter-14

Regulation of Bank Finance

Traditionally, industrial borrowers enjoyed a relatively easy access to bank finance for meeting their working capital needs. Further, the cash credit arrangement, the principal device through which such finance has been provided, is quite advantageous from the point of view of borrowers. Ready availability of finance in a fairly convenient form led to, in the opinion of many informed observers of the Indian banking scene, over-borrowing by industry and deprivation of other sectors.

Concerned about such a distortion in credit allocation, the Reserve Bank of India (RBI) has been trying, particularly from the mid-sixties onwards, to bring a measure of discipline among industrial borrowers and to redirect credit to the priority sectors of the economy. From time to time, the RBI has been issuing guidelines and directives to the banking sector toward this end. Important guidelines and directives have stemmed from the recommendations of certain specially constituted groups entrusted with the task of examining various aspects of bank finance to industry. In particular, the following committees have significantly shaped the regulation of bank finance for working capital in India: the Dehejia Committee, the Tandon Committee, the Chore Committee, and the Marathe Committee. The key elements of regulation are discussed below:

Norms for Inventory and Receivables

In the mid-seventies, the RBI accepted the norms for raw materials, stock-in-progress, finished goods, and receivables that were suggested by the Tandon Committee for fifteen major industries. These norms were based, *inter alia*, on company finance studies made by the Reserve Bank of India, process periods in different industries, discussions with industry experts, and feedback received on the interim reports. These norms represented the maximum levels for holding inventory and receivables in each period.

From the mid-1980s onwards, special committees were set up by the RBI to prescribe norms for several other industries and revise norms for some industries covered by the Tandon Committee. However, these norms are now regarded as indicative. Banks have a discretion to deviate from the norms. Still banks often look at them.

$$0.75 (CL) - CA = 0.75 (100) - 50 = 25$$

This means that the current liabilities including MPBF will be: $50 + 25 = 75$. Hence, the current ratio works out to $100/75 = 1.33$.

Forms of Assistance

Traditionally, bank credit to industry has been mainly in the form of cash credit which was introduced by the Scottish bankers. Under the cash credit system, the bank bears the responsibility of cash management because the borrowers have the freedom to determine their drawals within the cash credit limit provided by the bank.

With a view to bringing about a better discipline in the utilisation of bank credit, in 1995 a “loan” system for delivery of bank credit was introduced. Under the new dispensation, within the MPBF so arrived at in terms of the extant guidelines, banks/consortia/syndicates are required to restrict sanction of cash credit limits to borrowers up to a certain portion (which is currently 25 per cent) of the MPBF. Where borrowers desire to avail of bank credit for the balance portion (which is currently 75 per cent) of the MPBF, or any part thereof, this will be considered on merit by banks/consortia/syndicates in the form of a short-term loan (or loans) repayable on demand for working capital purpose for a stipulated period. Banks/consortia/syndicates will have the discretion to stipulate repayment of the short-term loan for working capital purposes by a borrower in instalments or by way of a “bullet” or “balloon” payment. In case the loan is repaid before the due date, it will be credited to the cash credit account.

Information and Reporting System

While banks can devise their own information and reporting system they largely follow the system recommended by the Chore Committee. Its key components are as follows:

1. **Quarterly Information System—Form I** This gives (i) the estimates of production and sales for the current year and the ensuing quarter, and (ii) the estimates of current assets and liabilities for the ensuing quarter.
2. **Quarterly Information System—Form II** This gives (i) the actual production and sales during the current year and for the latest completed year, and (ii) the actual current assets and liabilities for the latest completed quarter.
3. **Half-yearly Operating Statements—Form III** This gives the actual operating performance for the half-year ended against the estimates for the same.
4. **Half-yearly Funds Flow Statement—Form IIIB** This give the sources and uses of funds for the half-year ended against the estimates for the same.

The thrust of the information and reporting system is (i) to strengthen the partnership between the borrower and the banker, (ii) to give the banker a deeper insight into the operations and funds requirements of the borrower, and (iii) to enable the banker to

monitor closely the performance and efficiency of the borrower.

Public Deposits

Many firms, large and small, have solicited unsecured deposits from the public in recent years, mainly to finance their working capital requirements.

Cost

The interest rate payable on public deposits was subject to a ceiling of till mid-1996. Just before the ceiling was withdrawn, it was 15 per cent. When the ceiling was withdrawn in 1996, companies started offering higher returns. Some of the NBFCs offered about 20 per cent. Due to unhealthy competition, RBI has re-imposed the ceiling of 15 per cent.

Regulation

The Companies (Acceptance of Deposits) Amendment Rules 1978 governs fixed deposits. The important features of this regulation are:

- Public deposits cannot exceed 25 per cent of share capital and free reserves.
- The maximum maturity period permitted for public deposits is 6 months and the maximum maturity period allowed is 3 years. For non-banking financial corporations (NBFCs) however, the maximum maturity period is 5 years. A minimum maturity period of 3 months, however, is allowed for deposits amounting to 10 per cent of share capital and free reserves.
- A company which has public deposits is required to set aside, as deposit or investment, by 30th April of each year, an amount equal to 10 per cent of the deposits maturing by 31st March of the following year. The amount so set aside can be used only for repaying such deposits.
- A company inviting deposits from the public is required to disclose certain facts about its financial performance and position.

Evaluation

Public deposits offer the following advantages to the company:

- The procedure for obtaining public deposits is fairly simple.
- No restrictive covenants are involved.
- No security is offered against public deposits. Hence the mortgageable assets of the firm are conserved.
- The post-tax cost is fairly reasonable.

The demerits of public deposits are:

- The quantum of funds that can be raised by way of public deposits is limited.

- The maturity period is relatively short.

Inter-Corporate Deposits

A deposit made by one company with another, normally for a period up to six months, is referred to as an inter-corporate deposit. Such deposits are usually of three types:

- **Call Deposits** In theory, a call deposit is withdrawable by the lender on giving a day's notice. In practice, however, the lender has to wait for at least three days. The interest rate on such deposits may be around 12 per cent annum.
- **Three-months Deposits** More popular in practice, these deposits are taken by borrowers to tide over a short-term cash inadequacy that may be caused by one or more of the following factors: disruption in production, excessive imports of raw material, taxpayment, delay in collection, dividend payment, and unplanned capital expenditure. The interest rate on such deposits is around 14 per cent annum.
- **Six-months Deposits** Normally, lending companies do not extend deposits beyond this time frame. Such deposits, usually made with first-class borrowers, carry an interest rate of around 16 per cent per annum.

Characteristics of the Inter-Corporate Deposit Market

It may be of interest to note the following characteristics of the inter-corporate deposit market.

- **Lack of Regulation** The lack of legal hassles and bureaucratic red tape makes an inter-corporate deposit transaction very convenient. In a business environment otherwise characterised by a plethora of rules and regulations, the evolution of the inter-corporate deposit market is an example of the ability of the corporate sector to organise itself in a reasonably orderly manner.
- **Secrecy** The inter-corporate deposit market is shrouded in secrecy. Brokers regard their lists of borrowers and lenders as guarded secrets. Tightlipped and circumspect, they are somewhat reluctant to talk about their business. Such disclosures, they apprehend, would result in unwelcome competition and undercutting of rates.
- **Importance of Personal Contacts** Brokers and lenders argue that they are guided by a reasonably objective analysis of the financial situation of the borrowers. However, the truth is that lending decisions in the inter-corporate deposit markets are based on personal contacts and market information which may lack reliability. Given the secrecy that shrouds this operation and the non-availability of hard data, can it be otherwise?

Short-term Loans from Financial Institutions

The Life Insurance Corporation of India, the General Insurance Corporation of India, and the Unit Trust of India provide short-term loans to manufacturing companies with an excellent track record.

Eligibility

A company to be eligible for such loans should satisfy the following conditions:

- It should have declared an annual dividend of not less than 6 per cent for the past five years. (In certain cases, however, this condition is relaxed provided the company has paid an annual dividend of at least 10 per cent over the last three years.)
- The debt-equity ratio of the company should not exceed 1:5:1.
- The current ratio of the company should be at least 1:33.
- The average of the interest cover ratios for the past three years should be at least 2:1.

Features

The short-term loans provided by financial institutions have the following features:

- They are totally unsecured and are given on the strength of a demand promissory note.
- The loan is given for a period of 1 year and can be renewed for two consecutive years, provided the original eligibility criteria are satisfied.
- After a loan is repaid, the company will have to wait for at least 6 months before availing of a fresh loan.
- The loans carry an interest rate of 18 per cent per annum with a quarterly rest, which works out to an effective rate of 19.29 per cent per annum. However, there is a rebate of 1 per cent for prompt payment, in which case the effective rate comes down accordingly.

Rights Debentures for Working Capital

Public limited companies can issue “rights” debentures to their shareholders with the object of augmenting the long-term resources of the company for working capital requirements. The key guidelines applicable to such debentures are as follows:

- The amount of the debenture issue should not exceed (a) 20 per cent of the gross current assets, loans, and advances minus the long-term funds presently available for financing working capital, or (b) 20 per cent of the paid-up share capital, including preference capital and free reserves, whichever is the lower of the two.

- The debt: equity ratio, including the proposed debenture issue, should not exceed 1:1.
- The debentures shall first be offered to the existing Indian resident shareholders of the company on a *pro rata* basis.

Commercial Papers

An emerging source of financing working capital requirements of corporate enterprises is Commercial Paper (CP). Commercial paper is a short-term money market instrument, consisting of unsecured promissory notes with a fixed maturity, usually between seven days and three months, issued in bearer form and on a discount basis. Issue may be made on an interval basis or more generally under revolving underwriting facility extended by banks, tailored to the needs of the cash flow requirements of the issuer. Thus, commercial paper is a Certificate evidencing an unsecured corporate debt of short maturity. It represents a promise by the borrowing company to repay loan at a specified date. In law, the CP comes closest to a “Promissory note.”

Since CP represents unsecured, short-term promissory notes, only the highly reputed and creditworthy companies are able to take advantage of this source of funds.

Commercial paper can be sold directly by issuing company or through commercial paper dealers who either act as broker or purchase the paper outright for quick resale. Issuing companies tailor both the maturity and the amount of the notes to the needs of the investors. Thus, the maturities and amounts of the notes to the needs of the investors. Thus, the maturities and amounts of directly placed paper cover a wide range of combinations.

Commercial paper is different from banker’s acceptance. Thus, in the former it is the obligation of the issuing company while in the case of the latter both the drawer and the accepting bank have obligations. Another major difference is that issues of commercial paper do not have to be tied to a specific transaction whereas in most of the circumstances banker’s acceptances have to be tied to a specific transactions.

Genesis of Commercial Paper

The genesis of commercial paper is to enable highly rated Corporate borrowers to diversify their sources of short-term borrowings and also to provide an additional instrument to investors. A CP is not tied to any specific trade transaction.

It differs from other money market instruments like bankers’ acceptances in the sense that it is an obligation of the issuer only, whereas acceptances are obligations of both the drawer and the accepting bank. A CP does not carry any underlying collateral security.

Basically, the issue of CPs is an important step in financial disintermediation bringing the borrower and the investor in touch with each other, without the intervention of the banking system as financial intermediary. However, to the extent CPs substitute the working capital loan, the banking system would lose its loan portfolio and probably would lose its deposits as well, if the funds were with the banking system before investment in CP. The banks end up losing both the asset and the liability through this disintermediation process and the profit margin earned on the margin would vanish. Theory suggests that the CPs would be predominantly funded by the short-term surplus of the corporate sector. This is unlikely to be true in India, especially when the market expands. The corporate sector will continue to issue CPs, intercorporate loans and portfolio management scheme for employing their surplus and in the long run, it is the money in the banks that will find its way to the CP market. Further CP facilitates securitisation of loans resulting in creation of a secondary market for the paper and efficient movement of money providing cash surpluses to cash deficit entities. In international context, securitisation of debt paves way to globalisation of loan assets.

Potentiality of Commercial Paper as a Source of Corporate Finance

Commercial paper serves as a very useful instrument for meeting working capital needs of firms. However, only large and well established business enterprises with a track record of high creditworthiness can make use of CP as a means of financing their short-term needs because CP is an unsecured promissory note and does not carry any tangible security. Basic reason for popularity of CP as a means of financing is that it is usually less expensive than short-term bank credit by about 1 to 2 per cent and cost differential increases in periods of easy money. Since no compensating balance requirements are associated with the issuing of CP, cost of its issue would further be lower than that of the bank credit. Another reason for the usefulness of CP as a source of financing is that by means of this instrument firms can raise large amount of funds which they cannot take from a single bank. CP provides sufficient flexibility in business financing in as much as issuing firm may decide the quantum of CP and its maturity on the basis of its future cash flows. Financially, use of CP adds to the prestige of the issuing company, it seems more likely that the prestige was there before the paper was sold.

A significant drawback of this source of financing is that it is less reliable source of credit than bank loans. Because of the impersonal nature of the market, a buyer of commercial paper feels no obligation “to see the borrower through” a period of hard times or tight money. Buyers of CP simply look for the best yield possible for a short-term investment at a minimum risk. Thus, alacrity with which buyers of CP will switch to more attractive investments leaves firms high and dry in hard days when money market condition becomes tight forcing the management to seek funds from banks. It is

generally noted that banks do not look favourably on credit requests only in periods of tight money. A firm relying too heavily on CP may, therefore, find itself shut off from an important source of capital in future periods of need. Therefore, a finance manager must be careful not to impair relations with its bank. He must maintain lines of credit of commercial banks in order to tide over money market conditions. Another limitation is that CP must be paid when due. There is no extension of maturity, as in the case of a short-term bank loan.

Growth of Commercial Paper Market

The roots of commercial paper can be traced back in the early 19th century when the firms in the U.S.A. began selling open market paper as a substitute for a bank loan needed for satisfying short-term financial requirements. These firms facing great problem in getting loan from banks because of the existence of the unit-banking system were compelled to go to the market directly to raise resources from cities like New York.

During the first hundred years or so, the CPs were issued by non-financial business firms only. But subsequently, consumer financial companies also began issuing the paper, first through dealers and later directly with investors. By early 1950s, the U.S.A. had a large market for CPs. The commercial paper market in the U.S.A. is highly organised and sophisticated and the paper must be sold in denomination of \$ 100,000. The issuing companies tailor both the maturity and the amount of the paper to the needs of the investors. Thus, the maturities and amounts of directly placed paper cover a wide range of combinations. Most U.S. papers are exempted from registration under the U.S. Securities Act, 1933. They have a maturity span of 270 days or less which is longer than the Indian paper. Under Section 3(a) (3), CPs are sold only to accredited investors to finance non-current transactions.

The U.S. marketed commercial paper worth \$ 323 billion in 1986 accounting for over 90 per cent of the value of issues outstanding with all national CP markets is by far the largest in the world.

The U.K. CP market is modelled after the U.S. CP market. The Bank of England has prescribed that the issuer of the sterling CP must have net assets of at least U.K. Pound 50 million with shares listed in the Stock Exchange in London or be a wholly owned subsidiary guaranteed by a parent which fulfils this criteria. Further, only a public limited company can issue CP. The maturity period of CPs range between 7 and 364 days.

In Canada, the second most important and the oldest commercial paper market where CP was launched in the early fifties, the CPs are generally issued for a term ranging from 7 to 364 days. CP issued by a Canadian company is generally secured by the pledge of assets.

In Japan Yen paper was issued in 1987. It carries maturities ranging from two weeks to nine months. Normally maturity period varies between 3 months and 4 months.

In Hongkong commercial paper market was opened in 1979 when MTRC (Mass Transit Railway Corporation) issued CPs. In Singapore CP was introduced for the first time in 1980 when the Singapore merchant bank, DBS Daiwa, issued a CP on behalf of C.I. to, a Japanese trading company.

Commercial paper in India came into existence in early 1990 following striking developments in Indian money market. In recent few years, there was unprecedented transformation in the money market from a highly regulated, narrow illiquid and shallow market to a highly liberalised, substantially deregulated vibrant market blessed with new money market instruments. The new monetary policy adopted by the Reserve Bank of India to update and upgrade the existing money market in India, gave birth to the 182 days treasury bills, Inter Bank participations, Certificates of Deposits and Commercial Papers. A highly specialised money market institution, 'Discount and Finance House of India Ltd.', was set-up. Ceiling on the rates in the call money market was removed. The new financial services market came into existence with a large number of banks permitted to set-up their subsidiaries for promoting merchant banking, investment banking, equipment leasing, venture capital finance, etc. It was in the wake of these developments that CP was launched in our country.

Since the inception of CPs scheme in India in January, 1990, 23 companies issued CPs worth Rs. 419.4 crores (50 issues) till June 30, 1991. There has been phenomenal progress in the CP market in recent years in as much as it rose from Rs. 4,000 crores in December, 1993 to Rs. 9,000 crores in June 1994. Although the maturity period of CPs issued by the companies varied from three to six months, the majority of CPs were issued with a maturity of six months. The effective interest rates were in the range of 11.7 to 18.50 per cent.

Regulatory Framework for Commercial Paper

Following the recommendation of the Vaghul Committee on the development of the money market in January, 1987, the RBI announced the broad scheme of CP in its Credit policy in March, 1989. In January, 1990 the RBI issued detailed guidelines for the issue of CP. These guidelines were modified in April, 1991.

The major features of these guidelines are:

- (i) (a) An issuing company must have a tangible network of at least Rs. 10 crores.
- (b) The company must enjoy a fund-based Working Capital limit of Rs. 10 crores and above.
- (c) Have a minimum Current ratio of 1.33:1.

- (d) The Company must obtain a PI rating from Credit Rating and Information Services of India Ltd. which should not be more than 2 months old at the time of issue.
- (e) The company must have Health Code No. 1 raising from the Company's brokers.
- (f) The company must have got its shares listed on atleast one stock exchange.
- (ii) Minimum size of a CP issue is Rs. 25 lakhs and the face value of each CP instrument should be Rs. 5 lakhs.
- (iii) The maximum amount that can be issued by issue of CP will be 30% of the fund-based working capital limit. Once the issue is placed in the market, the fund-based working capital limit of the company will be correspondingly reduced.
- (iv) The issuing company has to get the RBI permission every time it issues CP and the RBI will operate a queue system to regulate the CP market.
- (v) CP may be issued to any person or corporate bodies registered or incorporated in India (including banks) as well as unincorporated bodies.
- (vi) The issue of CP cannot be underwritten or coaccepted in any manner.
- (vii) The paper being a usance promissory note, will be negotiable by endorsement and delivery'. The discount rate shall be determined by the free market.

Recently, RBI liberalised the terms of issue of CP to come into force retrospectively from May 30, 1991. According to the liberalised terms, proposals by eligible companies from the issue of CP would not require prior approval of the RBI. Such companies would have to submit the proposals to the financing banking company which provided working capital facility either as a sole banker or as a leader of the Consortium. The Bank on being satisfied of the compliance of then norms would take the proposal on record before the issue of CP.

In its attempt to boost up commercial paper market in the country the RBI further relaxed rules in June, 1992. Thus, the minimum working capital limit required by a company to issue CPs has been slashed to Rs. 5 crores from Rs. 10 crores. The minimum rating required from CRISIL has been lowered to P_2 from P_1 while the minimum rating needed from ICRA is now A_2 instead of A_1 . Further the ceiling on the aggregate amount which can be raised through CP has been raised to 75% of the working capital from 30%. A closely held company has also been permitted to borrow CPs provided all the criteria are met.

According to the RBI's monetary policy for the second half of 1994-95, the stand-by facility for commercial paper (CP) has been abolished. As per the policy when CPs are issued, banks will have to effect a pro rata reduction in the cash credit limit and it will no

longer be necessary for banks to restore the cash credit limit to meet the liability on maturity of CPs. This will impart a measure of independence to CP as a money market instrument. The intrinsic strength of the issuing company will be reflected from the ratings of its CP.

Although CP has been delinked from working capital limits, the ceiling of 75 per cent of maximum permissible bank finance continues. Thus, with the revised guidelines an issuing company will have to approach the bank every time to have a higher cash credit limit, once it issues CP and its cash credit limit is brought down to that extent. Now, CP will not be a self-liquidating arrangement. Earlier, there was a virtual guarantee by the bankers to adjust the CP on maturity which definitely was an added advantage.

Future of Commercial Paper in India

Commercial paper as vibrant instrument of financing working capital needs has a very bright future in changing economic scenario in view of growing liberalisation and decontrol and widening openings for the private sector even in strategic sectors of the economy. Corporate enterprises requiring burgeoning funds to meet their expanding needs will find it easier and cheaper to raise funds from the market by issuing commercial paper. Furthermore, use of this instrument provides greater degree of flexibility in business finance to the issuing company in as much as it can decide the quantum of CP and its maturity on the basis of its future cash flows.

Fears are expressed in some quarters that popularity of CP will adversely affect the banks' business. However, the situation will not be as alarming as is made out. It must be noted that the use of CP is restricted only to highly creditworthy and large profitable organisations. Medium and small enterprises will, therefore, have no alternative but to resort to banks for their working capital needs. Demand for bank loans will certainly surge in future owing to massive expansion that is likely to take place in small sector in view of the current industrial policy of the Government. In the events of any loss of income the same may be effected by fees earned by the banks in their capacity as issuing and paying agents of the papers.

However, the popularity of CP as the most lucrative means of short-term finance will pass through the acid test in view of delinking of CPs from cash credit facilities. With the delinking, CP will not be a self-liquidating arrangement. In the changed situation, corporates will prefer the cash system of CP as against issuance of CPs which will result in better utilisation of cash credit limits. There can be two probable ways to increase the credit off take. One way of giving impetus to cash credit could be by offering a finer rate to the borrowers who on an average avail themselves of 70 per cent or above of cash credit limits.

As a corollary to this, a commitment fee of 1.5 to 2 per cent on the utilised cash credit limits on the unutilised cash credit limits will be added to the cost of funds being raised through commercial papers offsetting, to some extent, the lowered interest rate on CP. Further, the issuing companies will now no longer have banks' funds as stand-by facility and they can no longer place reliance on the banks' working capital limits to meet the liability on maturity of CPs. Under the circumstances CPs will continue to be issued but will be restricted only to good companies with inherent strength.

Although CPs have made a good start, its future will depend on a number of factors. First such factor is conditionalities imposed on issue of CPs. Too many restrictions presently clamped on issuing companies are likely to kill the potentiality of CP as a source of corporate financing. For instance, companies in India do not have the discretion about the timing of CP issues and their roll overs. It is the RBI which decides in these matters. Further, the companies would find it impossible to roll over the CP issue in view of the queue system operated by RBI for CP issues. For instance, CP issue by a company is dated 11th March, 1991. After six months, the instrument matures and the company has to get into the queue system for the next CP issue. The stipulation that only companies rated PI are eligible to issue CPs is much too harsher. There are some good companies with PI rating who have been deprived of opportunities to issue CP. The highly rigid liquidity norms do ensure impeccable quality standards but they suffocate the growth. For commercial paper market to grow, issuers must have option to offer CPs with attractive terms including maturity range, denominational range and interest rate range. Indian CP as such is not going to attract investors of varied notions and preferences. The minimum time limit of 3 months does not seem to be short enough and funds will unnecessarily be tied. It is felt that the inactivity period should be as less as 15 days. It would indeed be a milestone in corporate financing if a tax exempt commercial paper is introduced in the market. Such paper could be issued by public sector undertakings, mutual funds, all-India financial institutions etc. Further the short-term paper through regular roll overs can ensure regular supply of funds.

The RBI should explore the possibility of opening the door of the commercial paper market to international investors on the same lines as offshore mutual funds. Initially the profitable public sector undertakings may be allowed to issue foreign currency denominated paper only to international institutions, pension funds, provident funds and development banks.

In sum, commercial paper as an instrument of corporate finance has tremendous scope if structural rigidities are removed and only such regulatory measures are taken by the RBI as are justifiable to issuers, investors, dealers and other concerned parties to the paper.

Factoring

Backdrop

With growing industrialisation and consequential growth in the volume of industrial production and sales, timely collection and efficient management of receivables has assumed importance. In the buyer's market of today, it seems to go without observing that one should demand credit on one's purchases and give credit on sales. The system feeding on itself is self-perpetuating. Since sales always exceed purchases during a given period, a larger amount of credit is given than taken and if collections are delayed, liquidity of the firm is badly affected. The problem becomes more serious for smaller enterprises due to their relatively weak financial position and limited access to capital market.

To handle this problem and prompted debt collections, companies in the USA, UK and most European countries have resorted to factoring services in one form or the other as an alternative method of converting accounts receivable into cash. These services have recently been extended in some South American countries as well as countries in the south Eastern and Far Eastern parts of Asia. Factoring in these countries covers both domestic and international trade. The USA and European Countries account for nearly 90 per cent of global factoring turnover at present. In India need for introducing factoring is being keenly felt.

Concept of Factoring

Factoring is a method by which a businessman can obtain cash for invoices he sends to his customers in respect of supply of goods and services to them. Factoring is also termed as 'Invoice Discounting.' Factoring involves the sale of receivables to a financial institution such as an old line factor—a commercial financial company or one of a few commercial banks. The factor purchases accounts acceptable to him generally without recourse; if the customer does not pay, the factor takes the loss. The client no longer carries factored account receivable on his balance sheet, in effect having converted them into cash. Firms owing the accounts receivable to client firms are notified that the account has been sold to the factor and are asked to remit directly to the factor.

It is noteworthy that the factor seldom agrees to buy all of the accounts receivable of a client firm; instead, he retains the right to screen the accounts and selects those acceptable to him. The client firm can continue to sell to customers whose accounts are unacceptable to the factor, but it must carry them itself and assume all risks on them.

Factoring involves rendering of services varying from the bill discounting facilities offered by commercial banks to a total takeover of administration of the sales ledger and credit control functions, from credit approval to collecting cash, credit insurance and provision of finance. Factoring agreement is normally continuous. As new receivables arise, they

are regularly sold to the factor. Under the typical factoring arrangement the client maintains a running account with the factor. As receivables are sold to the factor, the proceeds are put at the client's disposal in this account. Often, clients are given the privilege of overdrawing their account with the factor, or, in effect, of borrowing on an unsecured basis, in addition to drawing against the proceeds of the factored accounts. Also, interest is normally credited by the factor on funds left with him.

Functions of Factoring

A factor performs a number of functions for his client. These functions are:

1. Maintenance of Sales Ledger

A factor maintains sales ledger for his client firm. An invoice is sent by the client to the customer, a copy of which is marked to the factor. The client need not maintain individual sales ledgers for his customers. On the basis of the sales ledger the factor reports to the client about the current status of his receivables, as also receipt of payments from the customers and as part of a package, may generate other useful information. With the help of these reports, the client firm can review its credit and collection policies more effectively.

2. Collection of Accounts Receivables

Under factoring arrangements a factor undertakes the responsibility of collecting the receivables for his client. Thus, the client firm is relieved of the rigours of collecting debts and thereby enables to concentrate on improving the purchase, production, marketing and other managerial aspects of the business. With the help of trained manpower backed by infrastructural facilities a factor systematically undertakes follow up measure and makes timely demand on the debtors to pay the amounts.

Normally, debtors are more responsive to demands or reminders from a factor as they would not like to go down in the esteem of credit institution as a factor.

3. Credit Control and Credit Protection

Another useful service rendered by a factor is credit control and protection. As a factor maintains extensive information records (generally computerised) about the financial standing and credit ratio of individual customers and their track record of payments, he is able to advise its client on whether to extend credit to a buyer or not and if it is to be extended the amount of the credit and the period therefore. Further, the factor establishes credit limits for individual customers indicating the extent to which he is prepared to accept the client's receivables on such customers without recourse to the client. This specialised service of a factor assists clients in handling far greater volume of business with confidence than would have been possible otherwise.

In addition, factor provides credit protection to his client by purchasing without recourse to him every debt of approved customers (within the stipulated credit limit) and assumes the risk of default in payment by customers only in case of customers' financial inability to pay.

4. Advisory Functions

At times, factors render certain advisory services to their clients. Thus, as a credit specialist a factor undertakes comprehensive studies of economic conditions and trends and thus is in a position to advise its clients of impending developments in their respective industries. Many factors employ individuals with extensive manufacturing experience who can even advise on work loan analysis, machinery replacement programmes and other technical aspects of a client's business.

Factors also help their clients in choosing suitable sales agent because of their close relationships with various individuals and non-factored organisations.

Types of Factoring

Over a period of time, the factors world over have devised different types of factoring services to suit the requirements of their clients. On the basis of the nature of the services, factoring may be categorised as:

1. Full Factoring
2. Recourse Factoring
3. Maturity Factoring
4. Advance Factoring
5. Undisclosed Factoring
6. Invoice Discounting
7. Buyer-based Factoring
8. Seller-based Factoring

1. Full Factoring

Under full factoring arrangement, a factor renders services of collection of receivables and maintains sales ledgers, credit control and credit protection. On the basis of credit worthiness of the firm a monetary limit is fixed upto which trade credit provided by the client will be taken over by the factor without recourse to the client. The liability of the factor is limited only to the defaults arising out of customers' financial inability to pay. If the payment is withheld for reasons of dispute regarding inherent defect in goods, quality, quantity, counter claim, etc., recourse will be available to the factor against the client.

2. Recourse Factoring

In this type of factoring the factor does not provide any protection to the client against a customer's failure to pay debts. It may, therefore, not be necessary for the factor to either approve the customer or fix a credit limit. If the customer does not pay the invoice on maturity for any reason, the factor is entitled to recover from the client the amount paid in advance.

3. Maturity Factoring

This type of factoring involves no financing *ab initio* and hence no drawing limit is made available to the client. But the factor administers the client's sales ledger and renders debt collection services. The amount of each invoice is made over to the client at the end of the credit period on an agreed maturity date, less the factor charges. The maturity date is decided upon at the commencement of the agreement by reference to the average-time taken by the client to collect a debt. The maturity date bears no relation to the date on which the receivable is actually due for payment as it is a 'estimated data of collection.'

Such factoring could be with or without recourse. If it is without recourse, the amount will be made over to the client regardless of whether the factor has been able to collect the invoice or not. If the debtor becomes insolvent, on proof of involency, payment will be made to the client even before maturity. In with recourse factoring, the factor will either pay the client on collection of invoice or on maturity date with recourse later on.

4. Advance Factoring

In this kind of factoring, factor is prepared to pay for debts in advance of receiving the payment due from the customers. This is only a prepayment and not an advance. A drawing limit is made available to the client as soon as the invoice is accounted for.

5. Undisclosed Factoring

Unlike all other types of factoring, in undisclosed factoring customers are not informed about the arrangements between the factor and the client. The factor maintains the sales ledger on the basis of the copy of invoice. He provides the client with either debt default cover or finance or both as desired. Debt collection is done by the client who makes over payment of each invoice to the factor. The factor keeps a check on its risk by receiving from the client on age-wise analysis of debts at regular intervals. The types of services which may be offered under an undisclosed arrangement are very flexible. This may be on non-recourse basis and/or seasonal and/or selective basis.

6. Invoice Discounting

Under this arrangement the factor buys all or selected invoices of its client at a discount. The factor neither maintains sales ledger for his client nor undertakes debt collection function. He only provides finance to his client.

7. Buyer-based Factoring

Buyer-based factoring involves factoring of all the buyer's payables. Thus, the factor would maintain a list of 'approved buyers' and any claims on such buyers (by any seller) would be factored without recourse to the sellers.

8. Seller-based Factoring

In this type of factoring the factor takes over the credit function of the seller entirely. After invoicing his customer (who should be previously cleared by the factor), the seller submits a copy of the invoice, the delivery, challan, the buy-sell contract and related papers like quality stipulations and test certificate to the factor who takes over the remaining operations like reminding the buyer for payment, maintaining his account and collecting the amount. The seller closes his transaction after assigning the debt to the factor, by treating the transaction as a cash sale. In such a case, the factor is also able to supply additional information to the management, viz., approved, unapproved and disputed claims outstanding, sales analysis by area, by salesman, by products, etc., excise and sales tax payments and the like.

Modus Operandi of a Factor

Where a firm has decided to factor its receivables, it submits particulars such as list of customers, amount of the order, terms of sales, etc., in the case of 'approved' buyers and 90% of the invoice less commission to the factor before despatching any merchandise to its customers. The factor scrutinises each customer's account of the client firm to make a decision whether to 'accept' or 'reject.' A decision may also be taken to 'limit' purchases on account of a single 'buyer.' The factor returns to the client the list submitted with these orders. The client is free to supply to a customer, who has been rejected by the factor at his own risk.

After the goods are despatched, the client firm prepares an assignment schedule and attaches a copy of invoice and deliver challan. In this assignment schedule, complete details about the sale, such as the customer's name, address, terms of sale, due dates and amounts of invoices are recorded. The invoices are stamped before being sent to the buyer directing him to make the payment to the factor. Sufficient copies of each instrument are made out in advance so that all the parties involved have records.

The factor scrutinises the assignment schedule to segregate 'approved' and 'unapproved' buyers. The client company's account is then credited with the entire amount of the invoice less commission, in the case of 'approved' buyers and 90% of the invoice less commission, for 'unapproved buyers.'

The factor prepares on 'accounts current' at the end of the month to reveal the exact financial standing the client has with him. The interest charges and commissions are also recorded therein.

Potentiality of Factoring as a Source of Short-term Finance

Factoring is becoming popular all over the world in view of the variety of services rendered by factors to business organisations. Its importance has tended to increase in recent years owing to growing industrialisation and consequential growth in the volume of industrial production and sales. A factor, by dint of the function of buying debts without recourse, not only provides financial support to his client firm and meets a portion of its working capital, but also relieves the latter of the botheration of collecting the receivables from the customers and suffering losses due to bad debts. The firm may also avoid the necessity of operating a credit department for analysis and collection.

In addition to rendering financial assistance, a factor assists his client in credit planning and control. On the basis of the information and assessment of creditworthiness of potential customers, a factor is able to advise his client whether to extend credit to a particular buyer or not, and if it is to be extended, the amount and period therefor.

A factor may also generate other useful information for his clients. The factor, on account of a large volume of transactions handled by him, is in a position to computerise the operations and hence is equipped to perform book-keeping services for more efficiently and expeditiously than an average business concern.

It is important to note that firms that are small or have seasonal sales patterns may realise substantial savings in credit and collections because the factor serving a large number of accounts can realise economies of scale and also can achieve better diversification with respect to default risk.

However, the most critical fall-out of factoring is institutionalisation and perpetuation of credit and perhaps even delayed payments. Further, any tough stance taken by the factor against a defaulting buyer may have its direct impact on such borrower cutting short his orders on the particular seller. In a buyer's market, few sellers can afford to irritate customers.

Need for Factoring in India

At present the commercial banks in India provide working capital finance through purchasing/discounting of receivables allowing over-draft/cash credit • against hypothecation of outstanding book debts, allowing over-draft/cash credit against bills sent for collection through the bank and allowing overdraft/cash credit against amounts due from Government/Semi-government agencies in respect of supplies made to them. While the banks do finance the receivables, such finance is with recourse to the supplier who bears the risk of default by the debtor. The bank's credit support to the supplier is, thus, for a limited or pre-determined period and on the expiry of the said period, if the dues are not realised, it generally calls upon the supplier/borrower to repay the finance. Thus, the bank finance is always with recourse to the seller, i.e., if the buyer fails to make payment for any reason, the bank recovers the amount involved from its customer, viz., the seller.

Further, banks provide collection services only in respect of bills purchased/discounted or not. But they do not undertake collection of book debts (open account sales) of their customers.

The existing arrangements are not adequate to cater to all the requirements of seller in present conditions. Thus, the basic problems faced by sellers is the growing pressure on their working capital resources on account of their inability to obtain timely payment for their credit sales. While for sales on open element for the period the credit is normally expected to be outstanding, often interest is realised for the period the payments are delayed for the estimated time. Due to growing competition sellers hardly insist on payment of overdue interest and hence frequently suffer erosion in profit margins and working capital deficits.

Delayed payment spanning up to 5 month or more is fairly widespread. At times delayed payment is due to problems experienced by buyers in realising their own dues, thus indicating inter-dependence of different sectors in ensuring timely payments.

The problem of delays could be mitigated to a great extent if there is an efficient system of receivables management and collection machinery. At present only large organisations have separate credit management departments exclusively to attend to these matters. SSI units can hardly afford a separate staff for the purpose. Quite often, when required to attend to their recovery personally. Consequently, they are unable to give due attention to improving their products and enlarging their markets.

While some information on creditworthiness and reliability of buyers in far off places could be obtained through the banks, the information so available is not adequate for the supplier to know the operational, financial and market status of the buyer to decide upon credit terms which may be offered. As a result, they follow cautious approach.

In view of the above, desirability and usefulness of factoring services to suppliers of goods of services in India was considered by the Reserve Bank of India in January, 1988 when it appointed a study group under the chairmanship of Mr. C. S. Kalyansundaram, Ex-managing director of State Bank of India, to examine the feasibility and mechanics of starting factoring organization in India and recommending for their constitution, organisational set-up, scope of activities and other related matters.

While recognising the need for specialised agencies for handling factoring business, the group has cautioned that factoring *per se* would not be a complete solution for delays and defaults in payments. However, it feels that the professional approach of factor in credit assessment, debt collection, management of sales ledger, etc. should bring about a noticeable improvement in the payment culture.

The group has estimated the aggregate potential demand for factoring services at about Rs. 4,000 crores, it is of the view that in the early years, demand for factoring services would mainly emerge from the SSI sector and those medium and large units, which are

experiencing collection delays particularly in industries such as light engineering, textile, consumer durables, automobile ancillaries and chemicals.

Pricing of Factoring Services

A factor charges fee for the services rendered by it to the client. The fee charged varies depending on the type of services and creditworthiness, quality of portfolio and turnover of the clients. Normally the factoring fee in the U.S., U.K. and European Countries ranges between 1 and 3% of the face amount of the receivables purchased.

If funds are advanced to the seller before the receivables are collected by the factor, an additional interest charge is levied that is normally tied to, and above the prime rate.

In India, while a similar consideration can hold good, the base level of charges of the factors would depend upon the various costs to be borne by him, which in turn depend upon the cost of funds and the cost of management.

The RBI group feels that the price for factoring services may be around 16 per cent per annum for financing and 2.5 to 3 per cent for other services. It feels that such pricing should enable the factors to reach a level of business which will generate reasonable rate of return on their investment. It has emphasized that the factors will have to become more efficient than banks in handling the receivables of their clients.

Factoring Organisation in India

In most of the developed countries commercial banks have set-up their subsidiaries to perform the factoring functions in view of the fact that banks have considerable experience and have easy access to credit information on both sellers and buyers. Their large network of branches as also availability of sufficient financial resources provide them additional advantages. A few banks in India are expected to set-up subsidiaries to provide factoring services soon.

The RBI study group has suggested that only select promoter institutions, groups of individuals with good trust record in finance and management should be permitted into this new field, at least in the early years. This is considered necessary since such institutions have to set-up good standards and inspire confidence in the public.

The group has further suggested that initially the organisations may be promoted preferably on zonal basis such as one each for north, east, south and west. As regards ownership of such institutions, it feels that factoring organisations in the private sector may not be able to raise sufficient resources at competitive cost for handling business of the expected magnitude. .

The report of the Working Group on Money Market (Vaghul Committee) constituted by the Reserve Bank of India has also recommended that banks should be encouraged to

set-up factoring divisions which could play a vital role in accelerating efficient and speedy flow of resources to the corporate entities.

Accordingly, Reserve Bank of India has, of late, allowed Canara Bank to set-up Corporate subsidiary with Rs. 10 crore Capital in co-operation with Andhra Bank and small Industries Development Bank to render factoring services in southern region. State Bank of India and Punjab and Sind Bank have been permitted to form subsidiary to provide factoring services in Northern region. With a view to catering to the needs of eastern region United Commercial Bank, United Bank of India and Allahabad Bank have been permitted to float subsidiary with Rs. 5 crores.

India's first factoring company was set-up jointly by Canbank Financial Services Ltd., and Rashtriya Chemical and fertilizers Ltd., to act as a specialised agency to dealers in fertilizers and farmers using the fertilizers through factoring of trade bills and receivables.

Bank Guarantees

Bank guarantee is one of the facilities that the commercial banks extend on behalf of their clients in favour of third parties who will be the beneficiaries of the guarantees. In fact when a bank guarantee is given no credit is extended and banks do not part with any funds. There will be only a guarantee to the beneficiary to make payment in the event of the customer on whose behalf the guarantee is given, defaulting in his commitment. So, if the customer fails to pay as per the terms of the guarantee, the banker giving the guarantee has to pay and claim reimbursement from his client. The banker's liability arises only if his customer fails to pay the beneficiary of the guarantee. That is why bank guarantee limits are known as non-borrowings limits or non-fund limits.

Important features - The following points are to be considered regarding bank guarantee:

- Guarantees should be for a definite period and as far as possible should not run for more than one year.
- The guarantees should be in respect of a definite object or enforceable on happening of a definite event.
- Guarantee should be in respect of transactions which arise out of trade and commerce, or any other genuine business.
- Guarantees should be specific as to amount.
- Guarantees should be covered by a counter guarantee by a customer giving the bank absolute right of payment under guarantee on the happening of contingency guaran-teeed against.

- Reliable credit reports should be obtained on the customers for whom the guarantee is given. Such reports should be kept upto date.
- The guarantees should as far as possible relate to the normal business of the customers. The banks will insist the customer to deposit the margin, depending on case to case, before the issue of bank guarantees. The banks will charge commission on bank guarantees issued or extended.

Asset securitisation

The emerging financial scenario has created a fierce competition among the companies to raise funds through innovative financial products from the capital and/or money markets. Additional source of capital can be accessed through securitisation relieving the normal receivable/deposit collection process for finance companies and banks, without disturbing the liabilities side of the balance sheet. Companies can raise finance and increase their lending activity thus enhancing the profitability.

Meaning - The term ‘Securitisation’ refers to both switching away from bank intermediation to direct financing *via* capital market and/or money market, and the transformation of a previously illiquid asset like automobile loans, mortgage loans, trade receivables, etc., into marketable instruments.

“Securitisation is a process of transformation of illiquid asset into security which may be traded later in the open market.”

“Securitisation is the process of transforming the assets of a lending institution into negotiable instruments.”

For banks and financial institutions, securitisation, fundamentally, involves conversion of long-term assets into a current asset. It is a structured transaction whereby the bank transfers or sells loans of a particular portfolio to a specially created trust which breaks the loan into convenient amounts and raises money from the investors by selling the instruments which represent the loan amounts.

In India, ICICI has paved the way by securitisation of bills of exchange in 1991, and later HDFC and a few other finance companies have adopted this method. At present a number of other companies are adopting this procedure.

The illiquid assets such as mortgage loans, into loan receivable, cash credit receivables, etc., on the balance sheet of the originator (such as Finance Companies, Financial Institutions, Banks, etc.) are packaged, underwritten and sold in the form of securities to investors through a carefully structured process.

These securities could be in the form of commercial paper, participation certificates, Notes or any other form of security permissible under the legal frame work of the country. In a securitisation process, the underlying assets are used both as a collateral and also to generate the income to pay the principal and interest to the investors of the asset backed securities.

Securitisation process

- Firstly, assets have to be originated through trade receivables, lease rentals, housing loans, automobile loans, etc., according to their maturity pattern and interest rate risk and formed into a pool.
- Secondly, a trust has to be established solely to purchase receivable from the originator, create instruments according to the maturity period and risk of the asset, sell instruments and transfer the funds to the originator. The trust may also act as a receiving and paying agent.
- For this purpose, the trust has to obtain credit rating to make the transactions more attractive to the investor (although the rating is not mandatory).
- The trust would have to obtain some form of liquidity support from a third party lender to cover the possibility that the loan portfolio would generate insufficient payment when due. The trust may also have to obtain insurance cover, often provided by a pool insurance policy.
- It has to appoint a merchant banker or syndicate of merchant bankers for underwriting the whole issue.
- The securities have to be sold to the investors either by a public issue or by private placement.

Obviously, the good quality loans will be eligible for securitisation. The repayment pattern of assets in particular will be the deciding factor to structure the instruments.

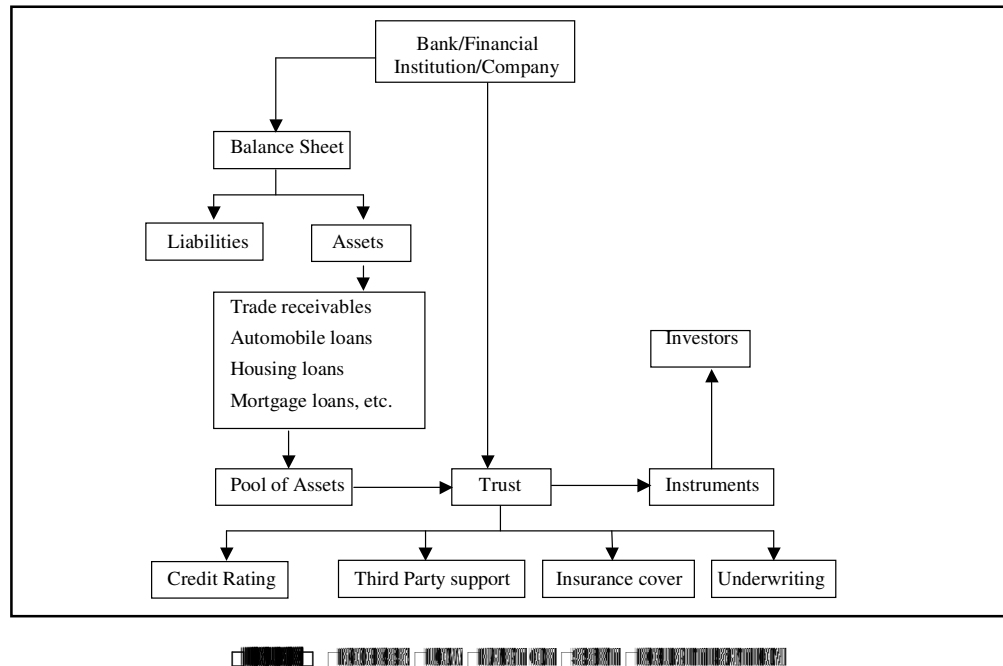

Advantages

- The main benefit to the originator is the additional source of capital can be accessed through securitisation relieving the normal receivable, deposit collection process.
- Without disturbing the liabilities side of the balance sheet the originator can raise finances and increase their activity of lending which enhances the profitability.
- The originator can reduce their existing debtors and can reduce their risk.
- By selling the debtors in the form of securities, liquidity of the entity/bank can be enhanced.
- Cash coming in from sale of assets can be used to fund either capital and reserves or to lend again.
- In case cash is used to fund capital and reserves, it results in lowering the debt-equity ratio.
- If in case cash is lent, it increases the turnover and profit ultimately for the business.
- Securitisation also improves the income to asset ratio by increasing income on the one hand and reducing the total volume of assets on the other.
- The main benefit to an investor is that he gets a security which is backed by adequate collateral and has credit enhancement.
- Most of such securities are rated by credit rating agencies. Hence, it becomes

relatively easier for an investor to compare the risk-return profile of asset backed securities with other investible instruments and make an informed choice.

- In a securitisation exercise the credit risk is shifted partially, or even completely from the issuer of securities to the securitised asset and/or third parties depending on the structure of the transaction. The security, thus, is insulated from other risks associated with the originator or the issuer.

The recent RBI directive that Banks shall extend 40% of the *maximum permissible bank finance* (MPBF) for amounts above Rs. 20 crores, by way of short-term loans repayable within one year, makes them an ideal asset for debt securitisation.

Loan transfers

This type of transaction, where loans are transferred to an existing third party without the creation of a new company, the issuer, as a vehicle for the deal. Technically loans cannot be sold in the same way as tangible assets, but there are three main ways in which the benefits and risks under the loan agreement can be sold to a third party.

- **Novation :** The rights and obligations attached to the loan are cancelled and replaced by new ones whose main effect is to change the identity of the lender.
- **Assignment:** Loans may be assigned by either a statutory or equitable assignment.
- **Sub-participation:** Rights and obligations are not transferred, but the lender enters into a non-recourse, back to back agreement with a third party, the sub-participant whereby the latter pays the lender some or all of the amount of the loan in return for a share of the cash flows.

In this type of transaction the original lender:

- has no residual beneficial interest in the principal of the loan and that the sub-participant has
no formal recourse to the lender for losses.
- has no obligation to provide further finance.
- does not intentionally bear any losses from interest rate changes.

Hedging approach to working capital financing

Under *hedging approach* to financing working capital requirements of a firm, each asset in the balance sheet assets side would be offset with a financing instrument of the same approximate maturity. The basic objective of this method of financing is that the permanent component of current assets, and fixed assets would be met with long-term funds and the short-term or seasonal variations in current assets would be financed with short term debt. If the long term funds are used for short-term needs of the firm, it can identify and take steps to correct the mismatch in financing.

Consortium lending and loan syndication by banks

When the individual bank finds it difficult to meet the huge financial requirements of a borrower, it gives rise to multiple banking which may be in the forms (i) Consortium lending or (ii) Loan syndication.

Consortium lending- When the financial needs of a single unit are more than a single bank can cater the needs, then more than one bank come together to finance the unit jointly spreading the risk as well as sharing the responsibilities of monitoring and finance. The arrangement is called the '*consortium lending*' and it enables the industrial units to mobilise large funds for its operations. This is generally formalised by a consortium agreement. RBI has advised that banks which are lending to units requiring large outlay of funds form a consortium arrangement among banks. Borrowers enjoying funds based limits of Rs. 50 crores and above from more than one bank should be brought under the above arrangement. There is no ceiling or number of banks in consortium. However the share of each bank should be a minimum of five per cent or Rs. one crore whichever is more. It will not be permissible for any bank outside the consortium to extend any additional credit facility or open current account for the borrowers without the knowledge and concurrence of the consortium members.

Loan syndication - On the recommendations of Narasimhan Committee, 1991, and further reviewed by a Committee under the Chairmanship of Mr. J. V. Shetty, then CMD, Canara Bank. Recently RBI guidelines signalled formation of *loan syndication* as a part of lending system. There are two methods of syndication direct lending and through participation.

- **Direct lending:** In respect of "*direct lending*" all the lenders sign the loan agreement independently with the borrower and agree to lend upto their respective share. The obligations of the syndicate members are several and they do not underwrite one another.
- **Through participation:** In this method of lending the lead bank is the only lending bank, so far as the borrower is concerned, that approaches the other lenders to participate in the loan. This normally takes place without the knowledge of the borrower. The lead bank grants a certain portion of the loan to each participant as agreed. It also agrees to pay to the participants a *pro rata* share of receipts from the borrower.

Types of participation - There can be four types of participation :

- **Substitution :** There is an agreement the borrower and the lead bank and other participants to permit the lead bank to disburse the loan on behalf of the participants.
- **Undisclosed agency:** Here, the lead bank is appointed as agent by the syndicate before the loan is signed, but does not disclose this fact to the borrower. It is, therefore, the principal as far as the borrower is concerned.

- **Sub-loan:** Under this method, each participant grants a loan directly to the lead bank on the condition that the lead bank repays only to the extent of receipts from the borrower.
- **Assignment:** The lead bank assigns a proportion of the loan and of the benefit of the loan agreement to the participants in consideration of the Purchase price or pro rata share of the loan to be contributed by them.

Non performing assets

Under the new RBI monitoring system, Bank's performances have been crucially dependent on recognition of income and non-performing assets. On the recommendations of high level committee under the Chairmanship of Sri M. Narasimhan, the RBI had issued circulars from time to time under the heading "*income recognition, asset classification, provisioning and other related matters*". The recommendations of the Committee highlights that the policy of income recognition should be based on objective and based on recovery rather than any subjective consideration.

The non-performing asset, as used in banking parlance, mean an asset the income (interest) of which is overdue for at least two quarters. Banks are not permitted to book income on accrual basis on such assets but only on realisation basis in respect of non-performing assets. For provisioning, the assets (loans and advances) are to be classified as (i) Standard (ii) Sub-standard (iii) Doubtful, and (iv) loss as per the RBI circular issued in this regard. The RBI has also introduced similar circular for revenue recognition, classification of assets, provisioning and other related matters applicable to Non-banking Finance Companies (NBFCs) registered with RBI.

Security for short-term financing

In normal course of business, the short-term loans will be provided by the banks against on some specific assets offered to the lender as security for repayment. Accounts receiv-ables and inventory are two types of current assets offered for financing working capital requirements. The following points are worthnoting in providing security of the above current asset.

Pledge of accounts receivables

- The lender evaluates the quality of receivables and the risks involved taking accounts receivable as security.
- Generally the security will be given on the balances lying in debtors in the Books of Account. In specific cases, any special accounts may be pledged to the lender for a particular loan.
- The borrower will continuously reporting the lender of the debtors paid and new debtors balances added in the records.

- Even though the lender have claim on the book debts, only the borrower will collect the receivables and the lenders right will arise when the borrower fails to repay the loans.
- If a loan is made on the notification basis, the notified debtor will directly pay his due amount to the lender instead of the borrower.

Charge on inventory - The manufacturing and trading companies, generally create charge on their stocks against working capital facilities provided by the Banks or Finance companies. The charge is created on the inventory items in the following ways :

- **Floating charge** : With creation of floating charge on the stocks, the borrowing firm gives the lender a general claim against the entire class of assets which are moving items. The lender's right on the stocks will be crystallised only when the borrower defaults in payment of his dues.
- **Charge against trust receipts**: When the items in inventory are easily identifiable, such as goods having serial numbers, a trust receipt can be eyed to guarantee a loan. A trust receipt is an agreement between the borrower and lender under which the borrower holds the goods in inventory and immediately forwards any sale proceeds from the sale of the inventory to the lender.
- **Pledge of Warehouse receipts** : When the inventory is kept at borrower's warehouse, but which is separated from other inventories can be pledged separately for specific loan purpose based on the warehouse receipt. If inventory is kept at third party warehouse then, there will be cost of warehousing also. The borrower can deal with or operate with the inventory pledged on warehouse receipt only when the charge is lifted by payment or otherwise.

Recommendations various committees Bank Financing

Dehejia Study Group

The National Credit Council constituted, in October 1968, a study Group under the Chairmanship of Shri V.T. Dehejia to examine the subject of the extent to which credit needs of industry and trade are likely to be inflated and how such trends could be checked. Since the bulk of bank credit is short-term, the Group's enquiry was primarily concerned with the inflation of the short-term bank credit. The credit needs of industry or trade may be considered to be inflated or either of the two sectors may be regarded to have received credit in excess of its genuine requirements (i) if, over a period of years, the rise in short-term credit is found to be substantially higher than the growth in the value of industrial production; (ii) if the rise in short-term credit is appreciably higher than the increase in inventories with industry or trade, (iii) if there is a diversion of short-term bank borrowings of concerns in industry for building up of fixed assets or other non-current assets such as loans and investments, (iv) if there is double or multiple financing of the same stocks; (v) if the period of credit is unduly lengthened.

The Group submitted its report in September, 1969.

Major Findings

The major finding of Dehejia Study Group are listed below:

Expansion of Bank Credit to Industry in Excess of Output

The Group found that the bank credit during the period from 1960-61 to 1966-67 expanded at a higher rate than the rise in industrial output. This finding was supported by the available data on inventories in relation to short-term bank credit. Between 1961-62 and 1966-67, the rise in the value of inventories with industry was 80% while the rise in short-term bank credit was as much as 130%. The ratio of short-term bank borrowings to inventories went up from 40% in 1961-62 to 52% in 1966-67. A similar analysis showed that some industries, particularly those in the traditional group, and several industrial units obtained credit from banks over and above the rise in their production. The Group therefore came to the conclusion that in the absence of specific restraints, there was a tendency on the part of the industry generally to avail itself of short term credit from banks in excess of the amount based on the growth in production and/or inventories in value terms.

Fixing Credit Limits by Banks

The basis on which banks fix credit limits had an important bearing on the size of bank credit in relation to the requirements of individual borrowers. For fixing credit limit banks generally took into account several features of the working of the loanee concerns, such as production, sales, inventory levels, past utilisation etc. The prevalent practices of banks in this regard were so varied that they were unlikely to prevent the emergence of excess demand for credit from certain borrowers. By and large, the scheduled banks were inclined generally to relate their credit limits to the security offered by their constituents but many do not appear to make any attempt to assess the overall financial position of the borrowers through a cash flow analysis and in the light of this study fixed their credit limits.

Valuation of Stocks and Margin Requirements

Banks did not generally adopt a uniform method of valuation of stock. The usual method, for indigenous goods was based on 'cost' or 'market value' whichever is lower and for imported goods on landed cost. Similarly, there was considerable divergence in practice as regards the prescription of margins by the banks. Some banks stipulated a lower margin or pledge advances against hypothecation of stocks, while a few others did not make this distinction. In the opinion of the Group, the varying practice could not be said to constitute an important factor in the emergence of excess credit.

Diversion of Short-term Credit to Acquisition of Long-term Assets

A study of 255 companies over the period from 1961-62 to 1966-67 showed a deterioration in their current ratio and the increase in short-term liabilities was utilised for financing the gap between long-term assets and long-term liabilities. One-fifth of the gross-fixed assets of these companies was financed by expansion in short-term liabilities including the bank loans.

The tendency on the part of a number of industrial units to utilise short-term bank credit and other current liabilities for acquisition of non-current assets was, in the Group, due to (a) generally sluggish condition in the capital market since 1962 (b) the limited nature of the appraisal of applications for short term loans as compared to medium term loans and (c) stipulation of repayment schedules for medium loans.

Lending System

The Group considered that the lending system, as was prevalent in Indian banking, would have appear greatly assisted prevalent in Indian banking, would have appear greatly assisted certain units in industry on increased reliance on short-term debt to finance their non-current investment. The working capital advances of banks were granted by way of cash credit limits which were only technically repayable on demand. The system was found convenient in view of the emphasis placed by banks on the security aspect. These short-term advances though secured by current assets were not necessarily utilised for short-term purposes. The result was that cash credit advances had no longer remained a short-term or self-liquidating in as much as although cash accruals arising from sales were adjusted in a cash credit account from time to time. The Group found that on a large number no credit balance emerged or debt balances fully wiped out over a period of years as the withdrawals were in excess of receipts. The possibility of heavy reliance on bank credit by industry arose mainly out of the way in which the system of cash credit—which accounted for about 70% of total bank credit had been operated.

Suggestions

The Group was of the opinion that unless measures were taken to check the tendency for diversion of bank credit for acquiring long term assets, it might assume wider dimensions. The Group made following suggestions for a change in the lending system.

Method of Appraisal of Credit Applications

The appraisal of credit applications should be made with reference to the total financial situation, existing and projected, as shown by cash flow analysis and forecasts submitted by borrowers. This would help a diagnosis of the extent to which current liabilities of industrial units had been put to non-current use and the manner in which liabilities and assets of borrowers were likely to move over a period of time. Initially, advances of,

say Rs. 50 lakhs and over should be analysed this way and then the system may gradually be extended to borrowers with advances of over Rs. 10 lakhs.

Segregation of the Credit Market

The outstandings in the existing as well as further cash credit accounts should be distinguished as between (i) 'the hard core' which would represent the minimum level of raw materials, finished goods and stores which the industry was required to hold for maintaining given level of production and (ii) the strictly short-term component which would be the fluctuating part of the account. The latter part of the account would represent the requirements of funds for temporary purchases, e.g. short-term increase in inventories, tax, dividend and bonus payments etc., the borrowing being adjusted in a short period out of sales. In the case of financially sound companies, the Group was of the opinion to segregate the hard core element in the cash credit borrowings and put on a formal term loan basis and subject to repayment schedule. But when the borrowers' financial position was not too good or the size of the hard core, was so large that repayment could not be expected within 7/10 years, it would be difficult for the banks to continue to carry these liabilities over a long period of time. The possible solutions to be attempted would be: the bringing in of long-term deposits and unsecured loans by the promoters and their friends, additional issue of equity or preference capital, a debenture issue with a long maturity. When the hard core was to be placed on a formal term loan basis, the proposal should be subject to a detailed appraisal. The documents should contain covenants in regard to the end-use of the loan, maintenance of minimum financial ratios, repayment obligations restrictions on investments on shares and debentures. To determine the hard core element of the cash credit account, the Group considered that it would be worthwhile to attempt to study of industry-wise norms for minimum inventory levels.

Double or Multiple Financing

Double or multiple financing may result where credit facilities are granted against receivables either by way of documents against acceptance bills or drawing against book debts; the purchase is also in a position to obtain bank credit by way of hypothecation/pledge of the stocks which have not been paid for. For eliminating double or multiple financing, the Group suggested that a customer should generally be required to confine his dealings to one bank only. In case the credit requirements of borrowers were to be large and could not be met out of resources of one bank, the Group has commended the adoption of 'consortia' arrangement.

Period of Trade Credit

To prevent undue longation of the period of trade credit and the tying up of resources of banks for unproductive purpose, the group suggested that the period of trade credit should not normally exceed 60 days and in special circumstance up to 90 days (excluding

sales of capital equipment on deferred payment terms). The undue delay in the settlement of bills by governments could be discouraged by stipulating that the latter should pay interest on bills if they were not paid within 90 days after their receipt.

Commitment Charges on Unutilised Limits

As a complementary measure to check the extension of extra credit, the group suggested that a levy of commitment charge on unutilised limited coupled with, if necessary, a minimum interest charge could be considered. The commitment levy might be progressively raised with the size of the unutilised limits. As the initial stages, limits sanctioned upto Rs. 10 lakhs might be exempted from the point of view of administrative convenience.

Need for Greater Recourse to Bill Finance

The Study Group emphasised the need for greater recourse to bill finance. The Group recommended that commercial banks, industry and trade should try, where feasible and administratively convenient, to initiate and develop the practice of issuing usance bills as this would not only impose financial discipline, on the purchaser but also help supplier or producer to plan his financial commitments in a realistic manner. An adequate growth in the volume of usance bills would also facilitate the development of a genuine bill market in India. With a view to encouraging the development of such bill market a reduction in the stamp duty on usance bill was recommended by the Group to the government. The Group believed that the loss in revenue following a reduction in stamp duty would be more than made good by the resultant larger volume of usance bills.

Inventory Control

With regard to inventory control, the Group considered that as an integral part of restraining the demand for bank credit by industry, adequate attention should be paid to the question of adequacy or otherwise of stocks of inventories held by various industries and the scope for minimising the stocks needed by industry.

Implications

Financial discipline implicit in Dehejia Study Group was intended to help the corporate and other borrowers in formulating financial plans, regulating production on a more rational basis and economising the demand for bank credit. As regards banks, a periodical release of the part of the resources otherwise locked up in 'roll over' cash credit/ overdraft to industry would enable them to meet to this extent further demands of priority sectors of the economy and to diversify their loan transactions. This, in turn, would increase the scope for mobilisation of deposits. Commercial banks would thus be able to play a more effective role in serving the community and the ends of social justice.

Tandon Study Group

The Reserve Bank of India constituted a Study Group to frame guidelines for follow up of bank credit in July 1974 under the Chairmanship of Shri Prakash Tandon. The terms of reference of the Group were:

- (i) To suggest guidelines for commercial bank to follow-up and supervise credit from the point of view of ensuring proper end-use of funds and keeping a watch on the safety of the advances and to suggest the type of operational data and other information that may be obtained by banks periodically from such borrowers and by the Reserve Bank of India from the leading banks.
- (ii) To make recommendations for obtaining periodical forecasts from borrowers of (a) business/production plans, (b) credit needs,
- (iii) To make suggestions for prescribing inventory norms for different industries both in the

private and public sectors and indicate the broad criteria for deviating from these norms.

- (iv) To suggest criteria regarding satisfactory capital structure and sound financial basis in relation to borrowings.
- (v) To make recommendations regarding the sources for financing the minimum working capital requirements.
- (vi) To make recommendations as to whether the existing pattern of financing working capital requirements by cash credit/overdraft system etc. requires to be modified, if so, to suggest suitable modifications.
- (vii) To make recommendations on any other related matter as the Group may consider germane to the subject of enquiry or any other allied matter which may be specifically referred to it by the Reserve Bank of India.

Observations and Recommendations

The Study Group submitted its report to the RBI in August 1975. The summary of the Group's main observations and recommendations is given below:

Supply of and Demand for Funds

Nationalisation of the major commercial banks in 1969 raised expectations of a new sense of direction in bank lending, and indeed advances to new claimants of credit, and especially to small industry and agriculture had since gone up. The public sector has emerged as an important user of credit due both to its growing dominance and its turning increasingly to commercial banks for its working capital finance instead of relying on government. Another new source of demand was the growing awareness of the need to achieve an equitable geographical development of industry, and in its

distribution of credit. Though industrial production increased at a slow pace but the call on bank credit essentially for maintaining inventories even at the same level had gone up with rising prices. If the growth process is resumed then the volume of inventory required to maintain a higher level of production will increase and correspondingly the demand for bank credit.

This state of affairs caused no problem in the year when the credit-deposit ratio in the banking system was low and a sudden spurt in credit demand could easily be taken care of and access to refinance from the Reserve Bank was easy. With control on monetary expansion as part of anti-inflationary policy and a use in demand for funds—both from the old and the new claimants—the existing system of bank lending came under considerable strain and the fundamental weakness of the system had been exposed.

Cash Credit System and Financial Indiscipline

The problem of potential imbalance in demand for and supply of funds is accentuated by the manner in which banks extend credit under the present cash credit system of lending, where a banker sanctions a maximum limit within which the borrower can draw at his will. Under this procedure, the level of advances in a bank is determined not by how much a banker can lend at a particular point of time by the borrower's decision to borrow at the time. When the borrower's need for funds is low, the banker is faced with the problem of large unutilised funds, and when the borrower's need for funds, the banker faces the problem of meeting the demand without notice. In fact, availability of funds with the bank and the customers need do not always match.

The weakness of the cash credit system can be illustrated by taking the following example of a borrower's financial position;

Current Liabilities		Current Assets	
Bank borrowings	Rs. 75,000	Inventory	Rs. 1,00,000
Other current	Rs. 10,000	Other current assets	Rs. 10,000
liabilities	Rs. 85,000		Rs. 1,10,000

Let us assume that the entrepreneur has raised equity and term loans for covering the cost of fixed assets as well as a portion of current assets. The banker's function is perceived as providing funds required for carrying the balance of the current asset. Against the total inventory of Rs. 1,00,000, an advance of Rs. 75,000 is sanctioned by way of cash credit. The advance is secured by a charge over inventory with an appropriate margin—in this case 25%—the margin representing the borrower's contribution to carry the current assets.

So long as there is security, which is declared in the periodical stock statements, the borrower is permitted to draw up to the drawing limit, computed on the basis of the value stocks less stipulated margin, or the sanctioned limit, whichever is lower.

Under this system, it is possible for a borrower to draw against available security and utilised the funds for purposes other than increasing his current assets of repaying his other current liabilities; he can, for instance, use the funds for acquiring fixed or non-current assets, as the following example illustrates:

Current Liabilities		Current Assets	
Creditors for purchase	Rs. 50,000	Inventory	Rs. 1,00,000
Bank borrowings	Rs. 75,000	Other current assets	Rs. 10,000
Other Current liabilities	Rs. 10,000		
	Rs. 1,35,000		Rs. 1,10,000

Inventory of the value of Rs. 1,00,000 is carried to the extent of Rs. 50,000 by creditors for purchases; but the borrower is enabled to borrow up to Rs. 75,000 on the security of stocks worth Rs. 1,00,000 less the prescribed margin of 25%, the drawing limit being Rs. 75,000. Had the customer drawn genuinely for meeting his current assets requirements only, his maximum eligibility (assuming nil contribution from him to carry the current assets) would have been Rs. 50,000; the excess of Rs. 25,000, he can divert to non-approved uses without the banker's knowledge.

Such diversion of bank funds was made possible by the banker's fixation on security under the cash credit lending system. To the extent that outstandings in a cash credit account never fell below certain level during the course of a year, there was an element of what is called a 'hard core' borrowings which was in reality a quasi-permanent lock-up of bank funds in the borrower's business. The time is now opportune to review the existing system and effect changes in such a way that under the new system the borrower could plan his credit needs and the banker would be able to plan his deposit credit function to assure finance to industry for its genuine production needs.

Norms of Inventories and Receivables

According to the Study Group, the main function of a banker is only to supplement the borrower's resources to carry a reasonable level of current assets. The Study Group has, therefore, stipulated norms for 15 major industries. Not only will the bank credit be regulated according to the norms but the units in these industries (except cotton and jute) themselves are not supposed to carry inventories/receivables in excess of the stipulated norms. In the case of cotton and jute industries, while stocks would be maintained according to the permission of the Textile or Jute Commissioner, the bank credit would be regulated according to the norms.

- Bunched receipt of raw materials including imports.
- Power cuts, strikes and other unavoidable interruptions in the process of production.
- Transport delays and bottlenecks.

- Accumulation of finished goods due to non-availability of shipping space for exports or other disruptions in sales but not under circumstances where a sales stimulation is needed through reduction in prices.
- Build up of stocks of finished goods, such as machinery due to failure on the part of purchasers for whom these were specifically manufactured to take delivery.
- Need to cover full or substantial requirements of raw materials for specific export contract of short duration.

For the industries, for which no norms have been stipulated banks are expected to keep in view the purpose and spirit behind the norms exercise and prevent excessive build-up of inventories receivables.

Working Capital Gap and Bank Finance

The Group has identified working capital gap viz., the borrower's requirements of finance to carry current assets (based on norms) other than those financed out of his other current liabilities, could be bridged partly from his owned funds and long term borrowings and partly by bank borrowings.

The maximum permissible level of bank borrowings could be worked out in three ways:

- (i) Bank can work out the working capital gap, i.e., total current assets less current liabilities other than bank borrowing and finance a maximum of 75% of the gap; the balance to come out of long-term funds, i.e., owned funds and term borrowings.
- (ii) Borrower to provide for a minimum of 25% of total current assets out of long-term funds, i.e., owned funds plus term borrowings. A certain level of credit for purchases and other current liabilities will be available and the bank will provide the balance. Total current liabilities inclusive of bank borrowings will not exceed 75% of current assets.
- (iii) Same as (ii) above, but excluding core current assets from total current assets on the theory that core current assets should be financed out of long-term funds, i.e., owned funds plus term borrowing.

The three alternatives may be illustrated by taking the following example of a borrower's financial position, projected at the end of the next year:

TABLE-1: Balance Sheet

Current Liabilities		Current Assets*	
Creditors for purchase	100	Raw materials	200
Other current liabilities	50	Stocks-in-process	20
	150	Finished goods	90
		Receivables including bills discounted with bankers	50
Bank borrowings, including bills discounted with bankers	200		
	350	Other current assets	10
			370

* As per suggested norme or past practice, whichever is lower in relation to projected production for the next year.

The 1st Method would mean the banker financing upto a maximum of 75% of the working capital gap of 220, i.e., 165 and the borrower providing at least 55 out of his long-term funds, i.e., owned funds plus long-term borrowings. This method will give a minimum current ratio of 1:1.

The 2nd Method would mean the borrower financing a minimum of 25% of total current assets (92) through long-term funds and the gap, i.e., maximum of 128 (278-150), will be provided by the bank. This will give a current ratio of at least 1.3:1.

TABLE-2: Permissible Levels of Bank Finance

1st Method		2nd Method		3rd Method	
Total current assets	370	Total current assets	370	Total curreni assets	370
Less: Current Liabilities other than bank borrowings	150	Less: 25% of above from long-term sources	92	Less: Core current assets (Illustrative figure) from long-term sources	95
	----		----		----
Working capital gap	220		278		275
		Less: current liabilities other than bank borrowings		Real current assets	275
				Less: 25% of above from long-term sources	69
					206
Less: 25% of above from long-term sources	55	Working capital gap	220	Less: current liabilities other than the bank borrowings	150
					56
Maximum bank borrowings permissible	165	Maximum bank borrowings permissible	128	Working capital gap	220
				Maximum bank borrowings permissible	56
Excess borrowings	35	Excess borrowings	72	Excess borrowings	144
Current ratio 1.17:1		Current ratio 1.33:1		Current ratio 1.79:1	

The 3rd Method would mean a further reduction in bank borrowing and strengthening of the current ratio.

It is important to note that in an exercise like this for computing the level of bank finance, the classification of current assets and current liabilities should be made as per the usually accepted approach of bankers and not as per definitions in the Companies Act. For instance, instalments of term loans payable within 12 months from the date of balance sheet are classified by the banker as current liabilities while it is not so in the balance sheet prepared in accordance with the requirements of the Companies Act. These differences in classification have been brought out in the form for analysis of balance sheet prescribed by the Reserve Bank under its Credit Authorisation Scheme.

The 3rd Method will provide the largest multiplier of bank finance; however, to avoid hardship to borrowers, a beginning may be made with the 1st Method, placing all borrowers in this method within a period of about one year, and the ideal of the 3rd Method may be reached in stages. The liberal approach under the 1st Method has been suggested as the first step, particularly to facilitate financial structuring of new companies, setting up projects in backward areas and also for flexibility in restructuring of existing companies with a weak financial base.

Style of Credit

Once the quantum of bank funds to finance a reasonable level of current assets is agreed to, there is also need to change the style of extending bank credit. Instead of making available the entire credit limit as a cash credit for a year, it may be bifurcated into a loan and a demand cash credit, which will be reviewed annually. The loan component would comprise the minimum level of borrowing which the borrower expects to use throughout the year, while the cash credit part could take care of his fluctuating requirements. As the loan would carry interest throughout the year, it will induce a discipline in the customer to plan his need carefully to ensure that as little of it as possible lies idle.

The demand cash credit should be charged a slightly higher rate of interest than the loan component. This approach will give the borrower an incentive for good planning. In order to ensure that customers do not use the new cash credit facility in an unplanned manner, the financing should be placed on a quarterly budgeting-reporting system for operational purposes.

Bill Finance

Apart from loan and demand cash credit, a part of the total requirements within the overall eligibility, could also be provided by way of bill limits to finance receivables. It is desirable that, as far as possible, receivables should be financed by way of bills rather than cash credit against book debts, though the latter cannot be altogether eliminated, particularly when the period of credit is short and the amount is small. These bills could be on a demand basis or on a usance basis depending on the marketing practice in the industry.

To the extent feasible, the banking system should move towards financing the purchaser, who is in fact the debtor, rather than the seller, who is the creditor. In other words, the seller will be paid off immediately after the sale and the bank credit will be extended only to the purchaser. As regards financing of the purchaser, however, there are two different points of view. One view is that purchases should also as far as possible, be on the basis of bills, for the following reasons:

- the amount will be drawn only at the time of actual need.
- the end-use of credit is automatically taken care of,
- credit to purchaser is directly related to his actual need, which is not the case with the seller's bills, where credit is extended as a measure of sales promotion irrespective of the purchaser's ability to pay or his need for credit.
- a bill enables discipline to be imposed in respect of payments for purchases-it ensures timely payment to suppliers, which a system of book entries does not always ensure.

It is argued on the other side that under the proposed revised system, the cash credit mode of financing is superior to bill financing in respect of the borrower's purchase operations for the following reasons:

- drawals for non-approved purposes will be detected by the new information system proposed and by scrutiny of cheques; end-use of credit will be effectively taken care of by the proposed information system,
- the cost of operations to the borrower and the banker will be high; borrower will have to pay more for cost of stamp duty which the banker's administrative cost will go up because of additional paper work without the assistance of mechanisation or computerisation, and
- the advantages of centralised borrowing by way of a close watch over aggregate outstandings, debit and credit summations and borrowing trends would be lost.

In view of the foregoing, it seems desirable that each banks should take its own decision, in consultation with the borrower, having regard to the size of his operations, the individual transactions and the administrative set-up obtaining in the bank.

Coverage of the Proposed Approach

The proposed approach to lending and the style of credit may be extended to all borrowers having credit limits in excess of Rs. 10 lakhs from the banking system, while the information system may be introduced, to start with, in respect of borrowers with limits of Rs. 1 crore and above from the entire banking system. Progressively, banks should extend this system, first to borrowers with limits of Rs. 50 lakhs to Rs. 1 crores and next to those enjoying limits of Rs. 10 lakhs to Rs. 50 lakhs.

Information System

To meet the specific requirement of the new ventures and to ensure the end-use and safety of bank advance, the borrower is expected to subject himself to the budgeting and reporting system. The borrower will supply appropriate operational data and figures relating to financial position at periodical intervals on the prescribed forms which have been devised for the purpose. The information so furnished by the borrower will have to be screened thoroughly and speedily and a view taken of his total activities.

All borrowers with total credit facilities from the Banking System in excess of Rs. 10 lakhs should submit (i) Operating Statement (ii) Funds Flow Statements (iii) Peak Level Balance Sheet and Proforma Balance Sheet for the ensuing year at the ensuing year at the time of submitting the loan application (whether for renewal/enhancement of fresh limits). The borrower with aggregate credit facilities from the banking System exceeding Rs. one crore should submit (i) quarterly operating statement (ii) quarterly funds flow statement and (iii) current assets and current liabilities every quarter for the purpose of follow-up.

Follow-Up

A bank has to follow-up and supervise the use of credit to verify first, whether the assumptions on which the lending decision was taken continue to hold good, both in regard to the borrower's operations and the environment, and second, whether the end-use is according to the purpose for which the credit was given. From the quarterly forms, the banker will verify whether the operational results confirm to earlier expectations and signs, if any, of significant divergence reading as red signals to both the banker and the customer. However, variance of say +10% may be treated as normal. In addition to the quarterly data, the larger borrowers should submit a half-yearly proforma balance sheet and profit and loss account within two months from the end of the half year.

Management Efficiency

Management competence is an important factor, in the efficiency of operations. reflected in profitability and working capital and financial management. The banker should be kept in mind appraisal of management may be essential particularly when more emphasis has been on viability and development rather than on security alone. Further, changes in ownership or managerial pattern may also have to be watched, where circumstances warrant.

Inter-firm Comparison

To facilitate inter-firm and industry-wise comparison for assessing efficiency, it would be of added advantage if companies in the same industry could be grouped under three or four categories, say, according to size of sales and the group wise

financial ratios compiled by the Reserve Bank of India, for furnishing to banks. Besides examining financial and operating ratios, certain productivity ratios may also be examined to determine efficiency in use of resources—*man, money, machines* and materials. A banker can choose his own criteria, but some useful ones are: labour efficiency; capital efficiency and fixed assets efficiency.

Classification of Customers

For purposes of better control, there should be a system of borrower classification in each bank, within a credit-rating scale. Such a system of classification according to credit-risk will facilitate easy identification of the borrower whose affairs require to be watched with more than ordinary care. An incidental advantage of such classification will be the formulation of a rational base for purpose of fixing the rates of interest for the respective borrowers.

Norms for Capital Structure

The debt-equity relationship is a relative concept that depends on several factors and circumstances such as the state of the capital market at any one time, government policy on created money, the need to maintain current assets at a specified level (which again is contingent on other factors), marginal efficiency of capital or the opportunity cost, etc. The experience of other countries in this matter may not be of much assistance in formulating guidelines in the Indian context. In discussing norms for capital structure, the Group kept in mind both the relationships—long-term debt to equity and total outside liabilities to equity. Where a company's long-term debt-net worth and total outside liabilities-net worth ratios are worse than the medians, the banker would endeavour to persuade the borrower to strengthen his equity base as early as possible. This would be a more practical approach for the banker than attempting to legislate absolute standards of long-term debt—net worth and total outside liabilities—net worth ratios for all industries or even industry by industry.

The impact of taxation in considering this subject is also important for, under the tax structure, it is advantageous to trade as much as possible on borrowed capital to maximise earnings per share. The higher the level of borrowings, or the financial leverage, the greater is the advantage in view of this and coupled with the cheap money policy, there may be limited incentive to the borrower for efficient management of funds. Introduction of higher interest rates in the banking system has changed this position. In fact, the lending banker likes to see as high an equity stake as possible because it makes advances safer and, in times of credit shortage, makes available bank funds so further. However, one cannot lose sight of the need to promote the capital market while resolving this dichotomy of interest between the banker and borrower as the ultimate goal being to assist in maximising investment and production. If the end-product of industry has to be sold at a cheaper price and adequate dividends are also to be given to make equity

attractive to the investor, no company can afford, even if it were possible, to trade entirely on owned funds, nor rely too heavily on borrowed funds. There has thus to be a balance between the two—what the company provides and what it borrows.

Problems in Implementing Tandon Committee Report

The Reserve Bank of India in its notification dated August 21, 1975 considered some of the main recommendations of the Group and advised the banks accordingly. The scheme was required to be implemented at the micro-level where advances were made to the borrowers. But a thorough understanding of the scheme required knowledge about the analysis of financial statements and credit appraisal by the officers at branch level. This knowledge was slowly spreading and till the officers at the grass root level were equipped with the basic knowledge of credit appraisal, the implementation was bound to be quite slow.

Another problem was that of gearing the attitudes of the bankmen to this new scheme being something new as being not in the routine nature of credit appraisal, it was difficult task to kindle the interest of the staff to study the Tandon Scheme for enforcing it in the case of big industrial customers. In addition, the new scheme also called for in-depth knowledge about each industry and various units in each industry so that the norms could be realistically applied in each case to determine the level of current assets, working capital gap and the style of credit.

It's not only the bankers but also the customers were required to be trained in understanding the implications of the norms and the quarterly information system, an innovation brought in by the Tandon Committee. No doubt the big parties had the qualified staff to give the data in forms prescribed on quarterly basis, but these forms were not forthcoming in time. If they were submitted each time after the current quarter or even much later upon reminder, the very purpose of calling for quarterly data were to be defeated as in that event follow-up supervision and control were difficult or not possible.

In the case of some of the big parties, it had been found that they were run like family concerns on partnership or proprietary basis and they did not maintain proper books of accounts. Such parties were likely to plead inability to furnish the data as per the Tandon form. To make matter worse or difficult for banks, they maintained account in regional language too. Even if the forms were coming with lot of persuasion and understanding from the borrowers, it was difficult to convince them in individual cases to abide by the norms for carrying current assets if they were already above the norms. No doubt, ultimately it was the banker's judgement that should prevail in credit decisions after a dialogue with the parties, but in super-imposing such decisions over the customers' judgement, there was likely to be misunderstanding or clash sort of thing with the borrowers. It was quite possible that aggrieved borrowers getting lesser limit might perhaps consider higher limits.

Another problem which was no less important could be about the manipulation in the figures of “other current assets”, “other current liabilities” etc. as the permissible bank finance was based on figure work only. Further it was felt that the calculation of excess finance poses a realistic problem because while the working capital gap was computed on the basis of the projected net current assets, the figures of liability were the existing ones and not the projected levels. For growing higher levels of current assets, the Committee provided exceptions where under higher holdings might be permitted. It was feared that each party might argue to be brought within the exceptions to circumvent the rigours of the norms.

However, in order to improve the operational efficiency and to develop a better understanding of the new lending system of banks, if all the banks are serious in implementing the Tandon Scheme and if they are able to get the cooperation from their customers, the problem areas are nothing and can be ignored. On the other hand, if unwarranted concessions and deviations are shown by banks against the ethics of the implementation of the scheme as a whole, the very philosophy of the Tandon Scheme will be defeated and it will create a situation in which the scrupulous banks will regret for going the Tandon way.

Chore Committee

While reviewing the monetary and credit trends in March 1979 the Governor of the Reserve Bank of India stressed the need for exercising continued restraint on expansion of credit. He also indicated in his meeting with bankers the need for considering certain long-term issues relating to banking operations. In his letter dated 16th March 1979 to all scheduled commercial banks, he indicated:

“I would like to initiate action on certain structural matters which need further examination. It is necessary to take a fresh look at another major problem faced by banks in implementing the credit regulatory measures, viz., the extensive use of the cash credit system. Its drawbacks have been pointed out by the various Committees in the past including the Tandon Committee, which suggested the bifurcation of credit limits into a demand loan and a fluctuating cash credit component. Although the banks were advised to implement this recommendation, I am afraid, the progress achieved has been very slow. Clearly, this problem needs to be looked into further and for this purpose I propose to set up immediately a small Working Group, to report to me.....on the reforms to be introduced”.

It was in this context that the Reserve Bank of India appointed the Working Group under the Chairmanship of Shri K.B. Chore to review the system of credit in all aspects. The term of reference of the Working Group were as follows:

- (1) To review the operation of the cash credit system with reference to the gap between sanctioned credit limits and the extent of their utilisation;

- (2) In the light of the review, to suggest:
 - (a) modifications in the system with a view to making the system more amenable to rational management of funds by commercial banks, and/or
 - (b) alternative types of credit facilities, which would ensure greater credit discipline and also enable banks to relate credit limits to increase in output or other productive activities; and
- (3) To make recommendations on any other related matter as the Group may germane to the subject.

The Group made following recommendations in its final report. Recommendations

Credit System

The advantages of the existing system of extending credit by a combination of the three types of lending, viz., cash credit, loan and bill should be retained. At the same time, it is necessary to give some directional changes to ensure that wherever possible the use of cash credit would be supplanted by loans and bills. It would also be necessary to introduce necessary corrective measures to remove the impediments in the use of bill system of finance and also to remove the drawbacks observed in the cash credit system.

Bifurcation of Credit Limits

Bifurcation of cash credit limit into a demand loan portion and a fluctuating cash credit component has not found acceptance either on the part of the banks or the borrowers. Such bifurcation may not serve the purpose of better credit planning by narrowing the gap between sanctioned limits and the extent of utilisation thereof. It is not likely to be voluntarily accepted and it does not confer enough advantages to make it compulsory.

Reducing Over-dependence on Bank Borrowings

The need for reducing the over-dependence of the medium and large borrowers—both in the private and public sectors—on bank finance for their production/trading purposes is recognised. The net surplus cash generation of an established industrial unit should be utilised partly at least for reducing borrowing for working capital purposes.

Enhancement of Owner's Contribution

In order to ensure that the borrowers do enhance their contributions to working capital and to improve their current ratio, it is necessary to place them under the Second Method of lending recommended by the Tandon Committee which would give a minimum current ratio of 1.33:1. As many of the borrowers may not be immediately in a position to work under the Second Method of lending, the excess borrowings should be segregated and treated as a working capital term loan which should be made repayable in instalments. To induce the borrowers to repay this loan, it should be charged a higher rate of interest. For the present, the Group recommends that the additional interest may

be fixed at 2% per annum over the ratio applicable on the relative cash credit limits. This procedure should be made compulsory for all borrowers (except sick units) having aggregate working capital limits of Rs. 10 lakhs and over.

Peak Level and Normal Non peak Level Limits to be Separate

While assessing the credit requirements, the bank should appraise and fix separate limits for the 'normal non-peak level' as well as for the 'peak level' credit requirements indicating the periods during which the separate limits would be utilised by the borrower. This procedure would be extended to all borrowers having working capital limits of Rs. 10 lakhs and above. One of the important criteria for deciding such limits should be the borrowers' utilisation of credit limits in the past.

Financing Temporary Requirements through Loan

If any ad-hoc or temporary accommodation is required in excess of the sanctioned limit to meet unforeseen contingencies the additional finance should be given, where necessary, through a separate demand loan account or a separate 'non-operatable cash credit account'. There should be a stiff penalty for such demand loan or non-operatable cash credit portion, at least two per cent above the normal rate, unless Reserve Bank exempts such penalty. This discipline may be made applicable in cases involving working capital limits of Rs. 10 lakhs and above.

Penal Interest

The borrower should be asked to give his quarterly requirement of funds before the commencement of the quarter on the basis of his budget, the actual requirement being within the sanctioned limit for the particular peak level/non peak level periods. Drawing less than or in excess of the operative limit so fixed (with a tolerance of 10% either way) but not exceeding sanctioned limit would be subject to a penalty to be fixed by the Reserve Bank from time to time. For the time being the penalty may be fixed at 2% per annum. The borrower would be required to submit his budgeted requirements in triplicate and a copy each would be sent immediately by the branch to the controlling office for record. The penalty will be applicable only in respect of parties enjoying credit limits of Rs. 10 lakhs and above, subject to certain exemptions.

Information System

The non-submission of the returns in time is partly due to certain features in the forms themselves. To get over this difficulty, simplified forms have been proposed. As the quarterly information systems, is part and parcel of the revised style of lending under the cash credit system, if the borrower does not submit the return within the prescribed time, he should be penalised by charging the whole outstanding in the account at a penal rate of interest, 10% per annum more than the contracted rate for the advance from the due date of the return till the date of its actual submission.

Relaxation from Norms

Requests for relaxation of inventory norms and for ad-hoc increase in limits would be subjected by banks to close scrutiny and agreed to only in exceptional circumstances.

Toning Up-Assessment Technique

The banks should devise their own check lists in the light of the instructions issued by the Reserve Bank for the scrutiny of data at the operational level.

Delays in Sanction

Delays on the part of banks in sanctioning credit limits could be reduced in cases where the borrowers cooperate in giving the necessary information about their past performance and future projections in time.

Bill System

As one of the reasons for the slow growth of the bill system is the stamp duty on usance bills and difficulty in obtaining the required denominations of stamps, these questions may have to be taken up with the state governments.

Sales Bill

Bank should review the system of financing book debts through cash credit and insist on the conversion of such cash credit limits into bill limits.

Drawee Bill System

A stage has come to enforce the use of drawee bills in the lending system by making it compulsory for banks to extend at least 50% of the cash credit limit against raw materials to manufacturing units whether in the public or private sector by way of drawee bills. To start with, this discipline should be confined to borrowers having aggregate working capital limits of Rs. 50 lakhs and above from the banking system.

Segregation of Dues of Small Scale Industries

Banks should insist on the public sector undertakings/large borrowers to maintain control accounts in their books to give precise data regarding their dues to the small units and furnish such data in their quarterly information system. This would enable the banks to take suitable measures for ensuring payment of the dues to small units by a definite period by stipulating, if necessary, that a portion of limits for bills acceptance (drawee bills) should be utilised only for drawee bills of small scale units.

Discount House

To encourage the bill system of financing and to facilitate call money operations an autonomous financial institution on the lines of the Discount Houses in UK may be set up.

Correlation between Production and Bank Finance

No conclusive data are available to establish the degree of correlation between production and quantum of credit at the industry level. As this issue is obviously of great concern to the monetary authorities the Reserve Bank may undertake a detailed scientific study in this regard.

Communication of Credit Control Measures to Branches and Follow-up

Credit control measures to be affective will have to be immediately communicated to the operational level and followed up. There should be a 'Cell' attached to the Chairman's office at the Central Office of each bank to attend to such matters. The Central Offices of banks should take a second look at the credit budget as soon as changes in credit policy are announced by the Reserve Bank and revise their plan of action in the light of the new policy and communicate the corrective measures to the operational levels as quickly as possible.

Monitoring of Key Branches and Critical Accounts

The banks should continuously monitor the credit portfolio of the 'key' branches irrespective of the fact whether there is a change in credit policy or not. For effective credit monitoring, the number of critical accounts should be kept under a close watch over the utilisation of limits and inventory build up.

Delay in Collection of Bills/Cheques

To reduce the delay in collection of bills and cheques, return of documents by the collecting branches, etc, the Group suggested to tone up the communication channels and systems and procedures within the banking system.

Bill Facilities and Current Accounts with other Banks

Although banks usually object to their borrower's dealing with other banks without their consent, some of the borrowers still maintain current accounts and arrange bill facilities with other banks. Apart from diluting the control over the advance by the main banker, this practice often enables the borrower to divert sales proceeds for unapproved purposes without the knowledge of his main banker. Banks should be suitably advised in this matter by the Reserve Bank to check this unhealthy practice.

Marathe Committee

With the incorporation of the guidelines of the Tandon Committee and the Chore Committee, bank lending to industry came increasingly under the direct supervision of the Reserve Bank of India. In 1982 it was felt that an independent review of the Credit Authorisation Scheme (CAS) which had been in operation for several years would be useful and accordingly the Reserve Bank of India appointed a Committee in November 1982 to review the working of the Credit Authorisation Scheme. The Committee which

came to be referred as the Marathe Committee submitted its report in July 1983. The starting point for the Marathe Committee's work provided by the objectives of the CAS, was enlarged and re-defined and noted by the Committee as follows:

- (a) To ensure that additional bank credit is in conformity with the approved purposes and priorities and that the bigger borrowers do not pre-empt scarce resources.
- (b) To enforce financial discipline on the larger borrowers where necessary, on uniform principles;
- (c) Where a borrower is financed by more than one bank, to ensure that the customer's proposal is assessed in the light of the information available with all the banks; and
- (d) To bring about improvement in the techniques of credit appraisal by banks and their system of follow-up.

Recommendations

The Marathe Committee which was given wide terms of reference to examine the Credit Authorisation Scheme from the point of view of its operational aspects stressed that the CAS is not to be looked upon as a mere regulatory measure which is confined to large borrowers. The basic purpose of CAS is to ensure orderly credit management and improve quality of bank lending so that all borrowings, whether large or small, are in conformity with the policies and priorities laid down by the Central Banking Authority. If the CAS scrutiny has to be limited to a certain segment of borrowers, it is only because of administrative limitations or convenience; and it should not imply that there are to be different criteria for lending to the borrowers above the cut off point as compared to those who do not come within the purview of the Scheme. Further, the Committee was of the view that it is not possible to avoid delays or improve quality of lending merely by concentrating on a single point. The borrowers have to do their bit by providing all the necessary and relevant information in time and in adequate detail. The long time taken in commercial banks in processing applications has to be reduced by suitable organisational changes. Similarly the time taken for scrutiny in the Reserve Bank also requires attention partly because it is the last stage of the process, and because of earlier delays, it is found more irksome by the borrower. Improvements in the system as a whole has to be a conscious and continuous process in order to achieve the desired result. The major recommendation of the Marathe Committee was in the area of providing an incentive for the borrowers to comply with all the requirements of the scheme including the information system and for the banks to improve the quality of credit appraisal. It recommended that 'banks be allowed discretion to deploy credit in CAS cases which fulfil the following requirements, without RBI's prior authorisation:

- (i) The estimates/projections in regard to production, sales, chargeable current assets, other current assets, current liabilities (other than bank borrowings) and

net working capital are reasonable in terms of past trends and norms (wherever specified), and assumptions regarding most likely trends during the future projected period.

- (ii) The classification of assets and liabilities as 'current' and 'non-current' is in conformity with the guidelines issued by RBI.
- (iii) The borrower has been submitting quarterly operating statements for the past 6 months within the stipulated time and undertakes to do so in future also,
- (iv) The borrower undertakes to submit his annual accounts promptly and the bank carries out the annual review of facilities irrespective of the fact whether the borrower needs enhancement in credit facilities or not.

The progress made in the adoption of the 'fast track' represented by the above recommendation of the Marathe Committee has been rather slow. This is not perhaps surprising, as the five eligibility conditions which have been laid down are quite comprehensive and further the sanction of credit facilities under the 'fast track' would still come under post-disbursal scrutiny of the RBI as in the case of sanction of credit facilities above Rs. 1 crore and below the cut-off point (now Rs. 4 crores for prior authorisation).

The Marathe Committee envisaged that the need for a regulatory role for the Reserve Bank in respect of individual credit limits will diminish, if not disappear if the banks are able to evolve an operational culture which will be immune to unhealthy pressures and which will have an in-built discipline in conforming to the broader parameters of policy laid down by the Central Banking Authority. It however, cautioned that the "gradual diminution of the area in which prior authorisation by the Reserve Bank is needed before banks can disburse credit to individual parties should not, therefore, mean any erosion of its role"

The basic approach to regulation of credit to industry and trade adopted by the Reserve Bank over the years as briefly reviewed above may be broadly summed up as follows:

- (a) The basis of bank lending should be changed from security-based lending to lending based on funds flow.
- (b) Credit needs are to be assessed and met by banks based on industry-wise working capital norms, deviations 'from these norms beyond the prescribed tolerance limits being seen as evidence improper credit use by the borrower requiring prompt rectification.
- (c) Reliance of borrowers on bank finance for financing working capital should be progressively reduced by insistence on maintenance of a current ratio of 1,33:1 by a growing segment of borrowers, the minimum acceptable ratio being 1:1.
- (d) Assessment of credit needs should be made on the basis of detailed information

to be provided by borrowers on past performance and future projections of working capital needs and overall performance.

- (e) Final clearance by RBI of credit requests for amounts above the cut-off point under CAS was an essential element in the credit allocation system as banks were not always in a position to resist pressures from their larger clients, nor adequately equipped to undertake scrutiny of credit requests with the required degree of thoroughness.
- (f) Continuous efforts are to be made by the borrowers, banks and the Reserve Bank to improve the information system which is seen as the key to the success of the approach to credit allocation outline above.

The borrowing community has over the years argued strongly against what it considers as the inflexibility and other inadequacies of the system of working capital financing adopted by the banks and the Reserve Bank of India. They have had the opportunity to present their views, in writing and during discussions, to the various committees and Study Groups appointed by the Reserve Bank of India to improve the methods of bank lending to industry and trade. Their criticism of the credit appraisal system as it has evolved over the past two decades covers conceptual as well as procedural aspects of the system. Some of these criticisms voiced by them are pointed out below.

Variation in Inventory level: The norms evolved by the Tandon Committee for assessing working capital requirements of different industries have been criticised by borrowers on the ground that the norms do not provide for variations in inventory levels occasioned by the operation of several commercial factors, apart from locational factors and impact of unforeseen developments. For example, it is pointed out that in the case of industrial units located in areas with inadequate transport facilities inventory levels would reflect the longer lead time for supply of raw materials and despatch of finished goods. It has also been argued that the norms which may be valid under ideal conditions, do not distinguish between different units and variations in market conditions overtime.

The levels of inventories in particular and the level of total working capital requirements also depend on a host of *extraneous factor* in the economy over which the borrower, has no control. These factors are inadequate and uncertain availability of power affecting production schedules, transport bottlenecks resulting from non-availability of railway wagons, non-availability of shipping space in the case of exports, changes in import policy, bottlenecks at the ports, bunching of imports, unanticipated changes in prices of raw materials and products made available by the public sectors canalising agencies, government policies regarding the permitted level of stocks in specific industries, *ad hoc* allocations by canalising agencies of scarce raw materials, strikes and disturbed industrial relations affecting purchase of supplies or sales of finished goods, uncertainties associated with imposition of duties in the annual budget of the government, sudden

changes in supply schedules prescribed by large public sector buyers, and so on. Under these circumstances borrowers point out that with the best of efforts they cannot project their working capital requirements even for one quarter, let alone for a year, with any degree of certainty. The management of these uncertainties itself consumes considerable time and efforts, and sanction of credit based on rigid norms compounds the difficulties in managing the industrial unit. These problems get magnified in the case of smaller borrowers as they are less able to determine the terms of purchase or sale of goods and have a weaker financial structure as compared to the larger borrowers.

Specification of different norms for different stages of production and marketing, detailed instructions regarding classification of items as current liabilities and current assets, difficulties in assessing the validity of projections of working capital requirements based on uncertainties referred to above, all combine to make the credit appraisal process a difficult and time consuming exercise. Again it is stated that during the protracted time over which credit appraisal is being undertaken, unforeseen developments occur, prices and market situation change, monetary policy stance may change, resulting in a need to revise earlier projections which leads to another cycle of delays. This brings in a tendency to inflate the amount of credit sought in the original application for sanction of credit limits.

Long-term Resources Contribution: The main thrust of the Chore Committee recommendations was on bringing a larger segment of borrowers under the Method II of lending wherein the borrowers are required to contribute long term resources through their own funds and term loans to the extent of 25 per cent of total current assets as against Method I of lending where their contribution would be no more than 25 per cent of the difference between current assets and current liabilities excluding bank borrowings. The borrowers are of the view that a rigid enforcement of this change would hurt industrial units. The resources at the disposal of the borrowers are limited and the application of Method II of lending should be gradual and based on the capacity of the units to augment their internal resources and term loans in situation where the financial strength and industry characteristics of different borrowers vary widely, and the state of the capital market is also not uniform over the years. Borrowers have argued that they need funds for modernisation, expansion and diversification, and further many of them need to improve their capacity utilisation which calls for higher levels of working capital. While term lending financial institutions insist on greater contributions by the borrowers towards the cost of fixed investment in projects being financed by them, bank insist on higher contributions by borrowers for financing their working capital requirements. The borrowers feel that both these demands can hardly be met by them at the same time with their limited resources.

Form of Bank credit: Bank credit sanctioned to borrowers takes the form of cash credit loans and bill financing. While cash credit is the more favoured form of financing,

banks specify separate limits for each type of assistance. The Chore Committee particularly stressed the need to insist on providing a part of the assistance by way of drawee bill limits. Separate limits are also specified for raw materials, finished products and receivables. The borrowers point out that this compartmentalisation hampers their ability to make the best use of the credit sanctioned to them and should therefore, be dispensed with, particularly since the components of working capital undergo changes in the course of operations. The banks too have to spend considerable time and effort to monitor the use of bank credit in accordance with the various sub-limits specified by them. There is no doubt that the importance of timely availability of credit should be reflected in the credit appraisal process at all stages, and borrowers should facilitate quick decisions by promptly providing the information called for by banks.

Margin requirements: Long term financial institutions have reason to be concerned that their relatively cheaper assistance is diverted to building up of working capital. At the same time banks are vigilant that borrowers do not appropriate larger than justified bank credit by diverting their own resources for expansion, modernisation or inter-corporate transactions. New companies find it difficult to have adequate margin for working capital as they are expected to conform to Method II of lending by banks from the time they start operations. Borrowers with a pronounced seasonal operation also face difficulties in meeting margin requirements during the peak season even when they are able to bring in their contribution during the year as a whole as required under Method II of lending. These factors appear to have complicated the financing of industrial operations.

Tax Concessions: Tax concessions available on additional fixed investment are attractive to industrial concerns who are naturally keen on availing of these concessions to the maximum extent possible, even if it means that they do not maintain margins stipulated by the bankers or margins for working capital at levels which they estimated while working out their project cost. Only when the borrowing concerns improve turnover of their capital, strengthen their equity base and obtain long term funds from the capital market will they be able to maintain adequate working capital margins on a regular basis. These options are open more to the larger companies who have a good past record of operations than to others, including new companies who are not well known in the capital market.

Credit Utilisation: The overall credit limit for a borrower is determined on the basis of Tandon/Chore norms and is generally thought of as being based on cash flow projections. But this is not really the case. The approach outlined by the Tandon Committee rests on the use of balance sheet data and the norms, therefore, are derived on the basis of funds flow statements. As a result, the true cash requirements of a borrower are not properly discernible in the statements provided to the banker for assessment of credit limits. The extent of mismatch between credit limits and the credit requirements of the

borrower would necessarily vary according to the scale of activity and seasonal factors. There is another aspect of credit limits which needs to be highlighted. The credit limit sanctioned to a borrower which is valid until it is reassessed, does not represent the extent of credit which the borrower is free to avail of at any point in time. The utilisation of credit limit depends on the borrower having the necessary drawing power as computed from the stock statements submitted to the bank periodically. This means that the utilisation of credit limits is related, through the application of margin requirements, to the level of inventories, book debts and other eligible assets indicated in the stock statement available to the banker. This is so because the operating banker prefers to base his decision to lend on a legal document such as the stock statement rather than on funds flow or even a cash flow statement indicating credit requirements for a given future period generally of three to six months. Bank lending, therefore, essentially retains its security orientation despite the application of more sophisticated norms. Credit limits based on Tandon/Chore norms serve the purpose of providing a ceiling to the utilisation of credit based on drawing power. Thus the quantum of credit that can be utilised by a borrower at any given time is equal to the drawing power or the credit limit, whichever is lower. The present credit appraisal procedures do not prevent utilisation of credit facilities over and above what is justified on the basis of a cash flow analysis, so long as the drawing power is not exhausted. As the stock statements are available once a month or less frequently, and their submission can be delayed if it suits the borrower, the drawing power based on the latest available stock statement does not necessarily represent current credit requirements. Moreover, banks are often obliged to condone excess drawals when they are in the nature of *fait accompli*, these being detected with a lag when the stock statement for the relevant period is submitted.

Information System: One of the major causes of delay in sanctioning of credit limits by banks has been the failure of borrowers to submit the quarterly statements under the prescribed information system in the time and in adequate detail. This is so even after the Chore Committee revised the formats relating to the information to be submitted which were introduced when the Tandon Committee recommendations were implemented. Even in the case of larger borrowers whose credit requests were subject to prior authorisation of the Reserve Bank of India, it was found that out of the 2321 applications processed by the Reserve Bank of India in 1982, further particulars were sought in as many as 702 cases. The Marathe Committee has noted “while there has been considerable improvement in the commercial bank’s appraisal systems, there are still wide variations as between banks and sometimes, in the quality of proposals put up by the same bank. There are delays, often inordinate, in processing applications. Similarly, among the borrowers also many have introduced modern techniques for the management of working capital and finance. In several cases, tools like planning for working capital, cash budgeting and management information systems are increasingly being used. But

here again there is considerable variation even amongst large borrowers; and the relatively smaller ones are still way behind, Altogether, while the working of the CAS has contributed a great deal and the banks as well as the borrowers have in many cases improved their systems, there is still long way to go.” Considering that the CAS has been in operation since 1965, these observations of the Marathe Committee are not encouraging. The reluctance of borrowers to comply with the requirements of the information system which constitutes a critical element for the success of the present system of credit appraisal is a real hurdle in the way of achieving the objectives of the credit appraisal system. The use of the funds flow approach based on balance sheet information in setting credit limits instead of a cash flow approach also makes monitoring of credit limits over the short term a difficult task.

The operation of the credit appraisal system since the introduction of the Tandon Committee norms has evidently succeeded in reducing dependence of industrial borrowers on bank finance for meeting their working capital requirements. In the case of medium and large public limited companies in the manufacturing sector the ratio of bank finance to total current assets declined from 30.1 per cent in 1974-75 to 26.8 per cent in 1980-81, as revealed in the regular suryes of the finances of such companies undertaken by the Reserve Bank of India. In the case of large public limited companies in the manufacturing sector for which survey results are available, it is seen that the ratio job bank finance to total current assets declined from 26.9 per cent in 1980-81 to 26.3 per cent in 1981-82 and further to 23.1 per cent in 1982-83.

The reduced reliance on bank finance has been made possible for the better established companies since 1980 by either greater access to the capital market facilitated by modifications in the official guidelines for the issue of convertible and non-convertible debentures. For the bulk of the lesser known industrial borrowers however, this would not be the case. The latter have responded of stricter credit appraisal by banks by resorting to ways and means in increasing their current liabilities. The RBI survey indicates that to 1980-81 the ratio of current liabilities excluding bank borrowing in current assets was 53.3 per cent for large public limited companies in the manufacturing sector. In comparison the ratio was 45.5 per cent for the medium and large public limited companies in 1980-81 having risen from 36.9 per cent in 1974-75. This is not a surprising finding and one can reasonably surmise that the effect of stricter credit appraisal was being passed on successively by the larger borrowers to the smaller and weaker borrowers, to greater or lesser degree depending on prevailing economic conditions and the stance of monetary policy.

Burden of Financing Sales: The transmission mechanism of the impact of stricter enforcement of working capital norms in financing the larger borrowers noted above is suggestive of a similar transmission of the burden of financing sales to government and semi-government agencies and public sector organisations who as a group are considered

to be slow in releasing payments for supplies. The industrial units whose funds are locked up for long periods due to delayed payment by government agencies would perforce delay, in turn, their payments to their own suppliers, starting off a chain of events resulting in an extra burden of financing being placed on the small scale industries who generally are unable to obtain their supplies other than against cash payment. This problem has been recognised for quite some time now and not much progress has been made in evolving a suitable solution. Even the Tandon Committee came up against this problem while it was laying down norms for working capital financing. It noted that “like the public sector, government purchase agencies are the biggest buyers in the country. Today payments by Government and public sector will only increase the level of receivables of industry and consequently the working capital requirements from banks for productive purpose. It would be useful if the Reserve Bank could initiate discussions on this matter. We also feel that Government should, pending streamlining its procedures, agree to pay interest on established delayed payments.” Even after a period of almost ten years since the Tandon committee made these remarks, no improvement in the position was noticeable. The Tandon Committee itself did not provide any cushion for such delayed payments from government agencies in evolving working capital norms, even though their recommendations were meant to cover all borrowers with credit limits of Rs. 10 lakhs or more, thereby including a large number of small scale industrial units.

It is a matter of concern that the combined effect of stricter enforcement of credit norms in the case of the larger borrowers, and delayed payments by public sector and government agencies and other large units would be such as to place a heavy financial burden on the suppliers in the small scale sector, who are as a consequence driven to take recourse to credit from outside the organised sector at relatively higher cost as compared to bank finance. Remedial measures by way of earmarking credit limits for making payments to ancillaries and small scale industries have been thought of but are still an insignificant element in the present system of credit allocation and perhaps not easy to implement.

Like the small scale industries sector, another sector which finds itself at a considerable disadvantage in the present system of credit allocation, is the trade and distribution sector. As regards its role as a supplier of raw materials to the industrial sector it shares to some extent the problems faced by the small scale industries in regard to working capital finance, though not all units in the trade sector are small or financially vulnerable, or weak in terms of bargaining power. The trade sector, in addition, has also to face a different kind of problem in regard to working capital finance.

Kannan Committee Report (The Latest Committee)

With a view to free the banks from rigidities of the Tandon Committee recommendations in the area of Working Capital Finance and considering the ongoing liberalisation in the financial sector, IBA constituted, following a meeting of the Chief Executives of selected public sector banks with the Deputy Governor of Reserve Bank of India on 31.8.96, a committee on 'Working Capital Finance' including Assessment of Maximum Permissible Bank Finance (MPBF), headed by K. Kannan, Chairman and Managing Director of Bank Baroda.

The Committee examined all the aspects of working capital finance and gave far reaching recommendations on the modalities of assessment of working capital finance in its report submitted to IBA on February 25, 1997. It observed that since commercial banks in India are undergoing a metamorphosis of deregulations and liberalisations, it is imperative that micro-level credit administration should be handled by each bank individually with their own risks-perceptions, risks-analysis and risks-forecastings. The final report of the Committee was submitted to RBI for its consideration in March, 1997. In its final report, the Kannan Committee also pointed that alongwith modification of existing systems of working capital assessment and credit monitoring, certain undermentioned areas require to be given greater attention:

- (1) Regular interface with the borrower to have a better understanding of (i) his business/activity; and, (ii) problems/constraints faced by him and the future action plan envisaged;
- (2) Periodical obtaining of affidavits from the borrowers, declaring highlights of their assets, liabilities and operating performance (in lieu of subjecting even the high rated/high valued borrowers to several routine inspections/verifications) in order to bestow faith-oriented, rather than *ab initio* doubt-oriented, approach in monitoring the credit dispensation.
- (3) Periodical exchange of information between/among financing banks/financial institutions to pick-up the alarm signals at the earliest.
- (4) Establishing, within, a time bound programme, a "Credit Information Bureau" to provide updated information of existing/new borrowers before taking a credit decision. (Modality of Information Bureau in advanced countries may be taken' as a guide for floating an appropriate Credit Information Bureau).

Accordingly, the Kannan Committee recommended that the arithmetical rigidities, imposed by Tandon Committee (and reinforced by Chore Committee) in the form of MPBF-computation, having so far been in vogue, should be given a go-by. The committee also recommended for freedoms to each bank in regard to evolving their own system of working capital finance for a faster credit delivery in order to serve more effectively various segments of borrowers in the Indian economy.

Concurring with recommendations of the Kannan Committee, Reserve Bank of India (vide circular No. IECN No. 23/08.12.01/96 dated 15.04.1997) advised to all the banks, *inter-alia*, as under:

It has now been decided that the Reserve Bank of India shall withdraw forthwith the prescription in regard to assessment of working capital needs based on the concept of maximum permissible bank finance (MPBF) enunciated by Tandon Working Group. Accordingly, an appropriate system may be evolved by banks for assessing the working capital needs of borrowers within the prudential guidelines and exposure norms already prescribed”.

The turnover method, as already prevalent for small borrowers, may continue to be used as a tool of assessment for this segment: since major corporates have adopted cash budgeting as a tool of funds management, banks may follow cash budget system for assessing the working capital finance in respect of large borrowers; there should also be no objection to the individual banks retaining the concept of the present maximum, permissible bank finance, with necessary modifications or any system”.

Reserve Bank of India further directed that: Working capital credit may henceforth be determined by banks according to their perception of the borrower and the credit needs. Banks should lay down, through their boards, transparent policy and guidelines for credit dispensation in respect of each broad category of economic activity.

New System of Assessment of Working Capital Finance

Considering that Indian economy has already ushered into shores of liberalisation and deregulations necessitating the banks in India to expeditiously integrate with global trends, followed by an ongoing process of elimination of barriers between operational areas of development banks and commercial banks, the Kannan Committee could not find any convincing justification to continue with separate assessment/fixations of jargon of various sub-limits, within overall working capital requirements, such as pre-sale finance, post-sale finance, domestic credit, export/import credit, fund based limits and non-fund based limits. Instead, the Committee felt that *Line of Credit System (LCS)*, as is prevalent in many advanced countries, should replace the existing system of assessment/fixation of sub-limits within total working capital credit requirement. Under LCS, the borrower’s working capital credit requirement is assessed at an outer limit (i.e., the maximum limit) which is flexible enough to be used in one or more of the following forms as selected by the borrower in lieu of his requirements from time to time. In other words, the Line of Credit is not a credit facility *per se*, but, is an outer limit for total (funded and non-funded) working capital finance, and within this outer limit, various types

of working capital funded and non-funded credit facilities (illustrative list furnished in Table-1) with appropriate limits shall be made available to the borrower.

TABLE 1

Note: The directive of Reserve Bank of India for Loan Delivery System in Working Capital finance are to be complied with scrupulously.

The Committee noted:

Entire Current Assets are to be the prime security for the confirmed Line of Credit—LCS (i.e., fixed/outer limit of working capital finance—whether funded finance or non-funded finance) and any excess drawings/requirement over and above the confirmed LCS may be subjected to additional rate of interest, say, upto 2.00%, to take care of the bank's cost of managing the uncommitted funds/obligation. However, specific long term working capital requirements such as (Sales to Electricity Boards, Bills Discounting under IDBI/SIDBI scheme etc. guaranteed by State/ Central Government is proposed to continue to be separate as is at present. The financing pattern in this regard would continue to be assessed taking into account quantum of Deferred Receivables as is the practice at present.

In the above context, the committee suggested that the existing system of assessment of working capital finance (based on MPBF-computations of Tandon Committee recommendations) may be replaced by a new system of assessment of working capital finance, embodying essence of the deeply considered recommendations of the committee. The new system is proposed for all borrowers engaged in legally permitted economic/ financial activities excepting the following give in Table 2.

TABLE 2

1. NBFCs (Non banking Finance Companies)	for whom, separate guidelines for assessment of W/C finance are devised by RBI;
2. Construction Companies/Contractors	for whom, separate guidelines for assessment for assessment of W/C finance are suggested by RBI;
3. Tea Companies	for whom. Cash Budget system is used to assess W/C finance
4. Ship breaking companies	Existing system of W/C finance is to be continued.

5. Diamond Industry	Existing system of W/C finance is to be continued.
6. Small Scale Industrial Undertakings requiring W/C funded finance upto Rs. 2 crores;	for whom, RBI has directed to use "Turnover Method" propounded by Nayak Committee"
7. Small borrowers (all sectors) requiring: Working Capital finance upto Rs. 2.00 Lacs (Rupees Two Lacs)	Most of such borrowers are usually covered under one or the other Schemes Sponsored by various Governments/local bodies. Therefore, financing— requirements of such borrowers shall be met as per the directives of the relevant sponsored scheme.
8. Specific Long term working capital requirements such as Bills Discounting under IDBI/SIDBI— schemes etc.	Existing separately set out guidelines to continue to be in force.

****Note:** In Case of All Non-Priority Sector Borrowers, not covered under above points from '1' to '8', the Working Capital Credit requirement shall be assessed as per the Turnover Method applicable for SSI-Borrowers requiring W/C-finance upto Rs. 200.00 lacs.

As a consequence of the proposed withdrawal of the existing system of working capital finance based on "MPBF-system", though a large leeway is available to the bank to adopt a new method/system, the committee envisaged to retain, with appropriate modifications, strengths, and to remove weaknesses, of existing MPBF-system simultaneously doing away with its rigidities as regards (i) computation of working capital bank finance, and (ii) supervision and monitoring of the credit dispensed by the banks so that the proposed new system ensures faster credit delivery with inherent need and merit based flexibilities. Therefore, the committee proposed to shift emphasis from the "Liquidity Level Lending (which is *de facto* security based lending— practised and stipulated so far by the banks), to the "Cash Deficit Lending" (which is in essence *need based lending*—indicating the financial support required by a borrower). The cash deficit lending has been aimed at to *perceive the borrower's requirement*, rather than to assess, after the deserving risk-analysis and risk-forecasting on case to case basis with perusal of the acceptability of the borrower's overall financial status, projected level of liquidity and activity, market reports, industry/activity profile and the economic strata which a particular borrower belongs to. As such, the new system of working capital finance may be called as *Desirable Bank Finance* (DBF). The committee recommended to put DBF—method in force immediately with the aim to make it fully operational over a period of 3-4 months, i.e., with effect from April 1, 1998 in order to afford, wherever necessary, adequate breathing time to bank staff and borrowers for developing familiarity with DBF method and also to coincide with start of new financial year for most of the borrowers as well as for the bank to afford operational convenience.

- The outlines of the DBF-method, as conceived by Kannan Committee, are discussed hereunder:

1. General Guidelines

1. The DBF method shall be applicable to working capital finance granted by a bank whether it is in sole banking or in multiple banking or in consortium banking arrangements. In multiple banking or consortium banking, there may be a situation where other banks are following a different method of working capital finance. In such a case:.
 - (a) if a bank is leader or holding the highest share in total working capital finance (i.e., total of funded and non-funded finance), the bank shall adopt the DBF-method and other banks shall be requested to accept the same;
 - (b) if a bank is not a leader or holding smaller percentage shares in total working capital finance (i.e., total of funded and non-funded finance), the bank may accept the assessment done by the consortium leader or the bank having largest share in the working capital financing, as the case may be, provided the bank is *prima facie* satisfied with efficacy of the method adopted by the consortium leader or the bank having largest share; otherwise, the bank shall follow DBF-method.
- (2) Wherever any of borrower is having multi-division activities/businesses, the working capital credit requirement shall be perceived/assessed separately for each of the division as is done at present.
- (3) At present, classification of Current Assets and Current Liabilities for the purpose of arriving at current ratio and for computing MPBF are different and the dual approaches often causes misunderstandings and confusions. Therefore, the committee proposed that, henceforth, there will be only one single classification of Current Assets and Current Liabilities and will be substantially be the same as is directed in the Form No. 111 (i.e., the extant CMA-guidelines for classification of C/As and C/Ls for the purpose of arriving at Current Ratio) subject to the changes briefed out hereunder:
 - (a) The components of the inventory procured under any of the Non-funded limits (viz., Letter of Credit and Guarantee) shall form part of Total Current Assets and the corresponding outstanding liabilities for payments therefore shall be added to Total Current Liabilities so as to arrive at the real financial position and short term solvency position of the borrower.
 - (b) Accordingly, the cash margins for L/Cs and Guarantees shall be part of total Current Assets.
 - (c) The amount of the Inter- corporate Deposits (ICDs), repayable by the

borrower within a period of 12-months, shall be treated part of Total Current Liabilities. Similarly, if the borrower has made investments in ICDs for a period lesser than-12-months, then, such ICDs shall be treated as Current Assets and the other ICDs shall be treated as Non-current Assets.

- (d) The instruments/outstandings, such as, Commercial Paper (CP), Certificate of Deposits (CD) and other money market instruments, represent temporary (for a period less than 12 months) parking of the funds by the borrower. Such instruments/outstandings are to be treated as Current Assets.
- (e) However, ICDs, investments in shares and debentures (including in associates and subsidiaries), even held for a period of less than 12 months, shall be treated as Non-current Assets.
- (f) Wherever, DBF-method envisages any item's classification different, from the extant CMA-guidelines, the classification of Current Assets and Current Liabilities shall be done in conformity with the DBF-method.
- (4) Before sanction of any adhoc/excess over the sanctioned limit (whether funded or non-funded facility), the borrower shall be asked to submit a proper Cash Flow statement so as to satisfy timely adjustment/liquidation of the adhoc-excess. The adhoc-excess may be subjected, at the discretion of the sanctioning authority, to levy of additional interest upto 2.00% p.a. to moot the cost of arranging additional funds/obligations for the adhoc/excess.
- (5) Banks' instructions on follow-up and supervision of working capital finance shall continue to be in force, mutatis mutandis with DBF-method and its guidelines narrated hereinafter.
- (6) There shall be no commitment charge on unutilised portion of working capital finance. However, on a persistent default in availing at least 80% of the sanctioned limit, the Branches, where such accounts are maintained, shall ensure to review/to get reviewed, as the case may be, the borrower's working capital credit requirement by the competent authority for necessary revision/modification in the sanctioned limit.
- (7) At the time of fresh sanction and sanction for review with modifications in the existing limits, and also for modifications in any of the stipulated terms and conditions, the borrowers are at present required to furnish following forms to which following modifications are proposed in Table-3

TABLE 3

Forms Nos	Existing particulars	Proposed Particulars	Remarks
I.	Particulars of existing/proposed limits from the banking system	Particulars of existing/proposed limits/facilities/finance from: (a) each banks; (b) each financial institution for working capital credit requirement; (c) NRFCS; (d) ICDs.	Applicable to all the borrowers irrespective of the size of the finance required.
II.	Operating Statement	Operating statement with additional particulars required under the DBF-method.	{ { { {
III.	Analysis of Balance Sheet	Analysis of Balance Sheet with additional particular required under the DBF-method.	Operational guidelines and the applicability criterion for the
IV.	Comparative statement of Current Assets and Current Liabilities	Comparative Statement of Current Assets and Current Liabilities with additional particulars required under DBF-method.	various borrowers shall be formulated separately in the micro-level details and guidelines/
V.	Computation of MPBF for Working Capital	Cash Budgets as required under the DBF-method	instructions. { {
VI.	Funds Flow Statement	Report on Financial indicators as required under the DBF-method.	{ {

- (8) As already discussed above, under the DBF-method, a Line of Credit (i.e., the outer limit for entire working capital finance) shall be fixed, within which, the borrowers shall be given freedom to select, for full one year or for a part of the year, sub-limits in one or more out of the various existing types of credit facilities. In other words, the line of credit is not a credit facility or credit delivery mode *per se*, but, is an outer limit of total (funded and non-funded) working capital finance, and within this outer limits, various existing types of working capital funded and non-funded credit facilities with appropriate limits shall be made available to the borrower at the discretion of the sanctioning authorities.
- (9) RBI had advised that in the interest of developing “bills” culture in the system, out of the total inland credit purchases of the borrowers, not less than 25%, should be through bills drawn on them by concerned sellers. Accordingly, the RBI had again urged to ensure that with effect from January 1, 1998, of the total credit purchases of the borrowers, not less than 25 per cent, should be through bills drawn on them by concerned sellers. The Committee supported the above instruction fully.
- (10) The Drawing power shall continue to be calculated with periodical statements

of stock, book-debts etc. as per bank's extant guidelines. However, the care has to be taken for fixation of the "margin" to ensure that against the adequate holding of stocks, book-debts etc., the aggregate drawing power does not become short of the Line of Credit, i.e., the outer limit fixed for total working capital limit. In other words, the existing discrepancy of the drawing power usually being less than the MPBF should not happen while working out the drawing power under the proposed DBF—method.

Categorisation of Borrowers According to Size of Working Capital Finance

1. *For Non-SSI borrowers requiring working capital finance over Rs. 2.00 lacs and upto Rs. 10.00 lacs from the banking system:* Considering size of the limit (extent of funded W/C—finance) required by such borrowers, and also the operational vagaries these borrowers are constrained to face and as also their *en mass* contribution to micro-level economic strata, the Committee proposed a simplified turnover-based method of perceiving W/C credit requirement for such borrowers as per the Annexure-
2. *For Non-SSI borrowers requiring working capital finance over Rs. 10.00 lacs and upto Rs. 500.00 lacs, and SSI borrowers requiring working capital finance over Rs. 200.00 lacs but upto Rs. 500.00 lacs from the banking system:* For this segment of the borrowers also, the Committee proposed to adopt turnover based method of perceiving W/C credit requirement. Nevertheless, since this segment of borrowers are pre-supposed to have a better data base of their operations and of financial health and, size of the limit to these borrowers demands a high level of bank-exposure, the committee proposed relatively detailed analysis and supervision. Therefore, the method enunciated as per the Annexure-2 is proposed.
3. *For all borrowers requiring W/C finance over Rs. 500.00 lacs but upto Rs. 1000.00 lacs (for both SSI as well as Non-SSI borrowers) from the banking system:* The borrowers requiring the above said size of limit are either corporate or likely to graduate to corporate-constitution in near future and, as such, are believed to have a better data-base of their operations. Moreover, the aggregate of the limits under the above said size puts the bank's exposure as a whole at a substantial level. Therefore, the committee proposed that assessment of working capital finance within this size of limit should continue to be on the basis of holding of Current Assets/Liabilities at present and later on switch over to the method of Cash Deficit financing when it is stabilised fully of higher scale of working capital finance. Accordingly, the Annexure-
4. *For all borrowers requiring W/C finance over Rs. 1000.00 lac (for both SSI as well as Non-SSI borrowers) from the banking system:* The borrowers,

requiring this size of limit, (i) are in upper strata of the economy; (ii) are predominantly corporates, and therefore, are statutorily required to maintain various financial data base and statements (such as, balance sheet, profit and loss Account, Fund Flow statements etc.) as per the proforma prescribed under the relevant statutes/Acts apart from being statutorily subjected to at least annual audits; (iii) have in-built system to maintain easily and promptly retrievable wide data-base to facilitate in-depth analysis and understanding of the borrower's profile; and, (iv) usurp a lion's share of the bank's lendable resources in the arena of working capital finance. Such borrowers do not generally run out of adequate holding level of inventory and/or receivables but suffer more from the cash deficits arising from time to time. Further, because of the mammoth size of the finance required by such borrowers, the banks are more required to vigil their funds-managing ability to timely resource the funds-availability as well as to conceive a proper funds-deployment.

In view of the above, arriving at a merit based credit decision necessitates a closer risk-forecasting—derived from:

- (i) detailed risks-analysis carried out with the intra-firm comparison, and inter-firm comparison if necessary, of the borrower's financial and operational statements and projections; and,
- (ii) risk-perceptions based on the interface with the borrowers, the market reports, industry/activity-profile, managerial competence, government policies and cross-country risks (wherever applicable).

In this context, the committee suggested that the quantum of working capital finance should be decided based on perception of the cash-deficit likely to be experienced by the borrower over the foreseeable/predictable near future as per the Cash Budget—proformae on the Annexure-4A. However, since the cash deficit system is to have its induction for the first time, the committee suggested the banks to satisfy upon the veracity of the “perceptions”, generated out of the aforesaid, with a list of financial indicators.

It may be noted that reasonableness of Current ratio and Debt equity ratio (DER) as well as margin and holding level of inventory/receivables shall be at the discretion of the sanctioning/recommending authorities as per individual merits on case to case basis. Nevertheless, wherever the sanctioning authorities acquiesces to (i) Current Ratio (a) less than 1.17 for working capital finance less than Rs. 10.00 lacs, and (b) less than 1.33 for working capital finance of and above Rs. 10.00 lacs; and, (ii) Debt equity ratio more than 2:1, necessary justification for accepting lower current ratio and/or higher DER is to be elucidated. However, periodical verification of current assets/liabilities is to be done by the bank's official(s) and/or, subject to approval of the sanctioning authority

and generally on half-yearly basis, by a practising Chartered Accountant (other than the company's statutory/internal auditors). However, wherever the branch-official picks up any alarm signal and consider it necessary that a detailed inspection/verification of the securities charged to the bank is required to be carried out by a Chartered Accountant or approved valuer/engineer, they may do so (in consultation with the next higher authority) without waiting for formal approval of the sanctioning authority provided the branch seeks confirmation for this action within a period of-15-days of having initiating the said inspection/verification.

Some of the recommendations with suitable modification have already been accepted by Reserve Bank for implementation. While announcing the Monetary and Credit Policy for the first half of 1997-98 on 15th April, 1997, Reserve Bank of India *inter-alia* spelt out various measures relating to credit dispensation by the banks. Full freedom has since been given to banks to frame its own methods for assessment of working capital needs of the borrowers. The details of important measures announced by Reserve Bank are as under:

- (i) Prescription as regards to assessment of working capital needs based on the concept of Maximum Permissible Bank Finance (MPBF) enunciated by Tandon Working Group has been withdrawn. Banks may evolve an appropriate system for assessing working capital needs of the borrowers, within the prudential guidelines and exposure norms which have already been prescribed by Reserve Bank of India.

Prudential exposure norms as per extant guidelines of Reserve Bank of India provide that the maximum exposure of a bank for all its fund based and non-fund based credit facilities, investments, underwriting, investment in bonds and commercial paper and any other commitment should not exceed 25 per cent of its (bank's) networth to an individual borrower and 50 per cent of its networth to a 'group'. It may however, be noted that while calculating exposure, the non-fund based facilities are to be taken at 50 per cent of the sanctioned limit.

To illustrate the point let us consider the following examples:

Example 1.	
Net worth of the bank	<i>Rs. in crore</i>
	700
Maximum exposure permitted for an individual Borrower (25% of networth of the bank)	175
Maximum exposure permitted for all borrowers under the same group (50% of net worth of the bank)	350
Example 2.	
Limits sanctioned to a borrower	
(i) Fund Based	100

(ii) Non Fund Based	100
Total	200
Total Exposure	
(i) For fund Based limits @ 100% of limits	100
(ii) For Non-funds Based limits @ 50% of limits	50
	150

Total credit limits to the above borrower are Rs. 200 crores which are in excess of the maximum exposure norm of Rs. 175 crores. But for the purpose of determining exposure we have taken non-fund based limits at 50 per cent of its value and total exposure is taken at 150 cores which is well within the norm.

As per a recent classification of Reserve Bank, loans and advances against bank's own deposits may not be included while arriving at over all exposure to a borrower.

Total exposure to group is permitted upto 60 per cent if the additional exposure is on account of finance to infrastructure finance. However, exposure norm to individual borrower remains restricted to 25% only even in such cases.

- (ii) The turn over method, as already prevalent for small borrowers, may continue to be used as a tool of assessment for this segment. For small scale and tiny industries etc., this method of assessment may be extended upto total credit limits of Rs. 2.00 crores as against existing cut-off point of Rs. 1.00 crore.
- (iii) Banks may adopt cash budgeting system for assessing the working capital finance in respect of large borrowers.

Reserve Bank of India has however, not suggested any specific form for assessment of working capital based upon cash budgeting. 'Kannan Groups' has given a form which may be adopted by the banks with suitable modifications. In any case it has been left to the banks to evolve their own method/form for this purpose.

- (iv) The banks may also retain the concept of the present maximum permissible bank finance with necessary modification or any other system as they deem fit.
- (v) Banks should lay down with due approval of their boards, transparent policy and guidelines for credit dispensation in respect of each broad category of economic-activity.
- (vi) Reserve Bank's instructions relating to directed credit (such as priority sector, export etc.), quantitative limits on lending (such as against shares and for consumer durables etc.) and prohibitions of credit (such as bridge finance, re-discounting of bills earlier discounted by NBFCs etc.) shall continue to be in force.

- (vii) The present reporting system to Reserve Bank of India under the Credit Monitoring Arrangement (CMA) shall also continue in force.

MPBF system as per the recommendation of Tandon Committee report was introduced in November, 1975 and has been well established by now. Despite its prescription being withdrawn by Reserve Bank, most of the banks are still continuing with this approach.

Cash budgeting system will require many changes in the accounting system being present adopted by the borrowers and a new information system, the transition to the new system is, therefore going to be slow and perhaps no Indian Bank has adopted this system of assessment of working capital needs so far in the real sense.

Many banks have however, adopted turnover method for assessment of working capital needs upto Rs. 2.00 crores in respect of all borrowers.

Recent RBI Guidelines Regarding Working Capital Finance

The following recent changes have been made by RBI in the guidelines for bank lending for working capital purposes and by way of term loans. These measures are set out below:

(i) Lending Norms for Working Capital

- (a) Banks would henceforth decide the levels of holding of individuals item of inventory as also of receivables, which should be supported by bank finance, after taking into account the production/processing cycle of an industry as well as other relevant factors. RBI would no more prescribe detailed norms for each item of inventory as also of receivables; it would only advise the overall levels of inventory and receivables for different industries to serve as broad indicators for guidance of banks.
- (b) Banks would be free to sanction ad hoc credit limits to borrowers, where considered necessary and charging of additional interest for this purpose is no longer mandatory.
- (c) Other aspects of the lending discipline, viz., maintenance of minimum current ratio, submission and use of data furnished under quarterly information system, etc. would continue, though with certain modifications, which would make it easier for smaller borrowers, to comply with these guidelines.

ii. Treatment of term loan instalments for assessment of working capital purposes

Hitherto term loan instalments falling due for repayment in the next twelve months were treated as part of current liabilities for assessment of maximum permissible bank finance (MPBF). In terms of current policy, which was implemented in stages, such instalments are not required to be treated as an item of current liabilities for the limited

purpose of assessing MPBF. These instalments continue to be treated as current liabilities for all other purposes including for calculation of current ratio.

iii. Export Credit

- (i) In order to ensure that the credit requirements of exporters are promptly met and their additional credit requirements out of firm orders/confirmed letters of credit, not taken into account while fixing their regular credit limits, the banks were advised in December 1992 to sanction such additional credit limits, even in excess of maximum permissible bank finance (MPBF).
- (ii) Borrowing units engaged in export activities need not bring in any contribution from their long-term sources towards financing that portion of current assets as is represented by export receivables.
- (iii) Banks were also advised not to apply the Second Method of Lending for assessment of MPBF to those exporter borrowers, who had to their credit export of not less than 25 per cent of their total turnover during the previous accounting year provided their aggregate fund-based working capital limits from the banking system were less than Rs. 1 crore.

While announcing the credit policy for the first half of 1997-98 (April-Sept.), the RBI has withdrawn its earlier instructions regarding MPBF and has given freedom to banks to determine working capital requirements of the borrowers on their own. The cash credit to loan ratio in the working capital limit has been fixed as follows:

Category of Borrower	Cash Credit to Loan Ratio
(i) Borrowers with a credit limit of less than Rs. 10 crore	Bank and the Borrower can settle freely
(ii) Borrowers with credit limit between Rs. 10 and 20 crore	25 : 75
(iii) Borrowers with credit limit Rs. 20 crore and more	20:80