



PDHonline Course G177 (4 PDH)

A Guide for Interior Design

Instructor: A. Bhatia, B.E.

2020

PDH Online | PDH Center

5272 Meadow Estates Drive
Fairfax, VA 22030-6658
Phone: 703-988-0088
www.PDHonline.com

An Approved Continuing Education Provider

Design Guide for Interiors



US Army Corps
of Engineers®

DG 1110-3-122
SEPTEMBER 1997

Foreword



**US Army Corps
of Engineers®**

The USACE *Design Guide for Interiors* provides a comprehensive reference document to assist USACE designers; Major Army Commands; Directorates of Public Works; facility users; and contract architectural, engineering, and interior design firms in the development of excellent interiors. It complements other criteria such as Architectural and Engineering Instructions, Design Criteria, DA Standard Designs, Engineering Regulations (ER), and selection resources, and is applicable to new construction, renovation, and maintenance and repair of building interiors.

This design guide was prepared by the U.S. Army Engineer District, Omaha, Technical Center of Expertise for Interior Design, utilizing a contract with Leo A. Daly Planning/Architecture/Engineering/Interiors, Omaha, Nebraska.

Following initial distribution, copies of this document will be available from the USACE Publications Depot, 2803 52nd Avenue, Hyattsville, Maryland 20781; telephone number 301-394-0081. This document supersedes the *Design Guide for Interiors, December 1982*.

We will continue to work to improve interior design criteria and the process for procuring interior finishes and furnishings. This design guide is a living document and users are requested to address recommendations for changes and improvements, with their rationale for proposed changes, to HQUSACE, ATTN: CEMP-EA, Washington, DC 20314-1000.

For The Director Of Military Programs

A handwritten signature in black ink, appearing to read 'Kisuk Cheung'.

Kisuk Cheung, P.E.
Chief, Engineering Division
Directorate of Military Programs

Contents



Guide to Excellent Interiors

Chapter

1

Introduction

Chapter

2

Human Behavior and the Interior Environment

Chapter

3

Light and Color

Chapter

4

Design Basics

Chapter

5

Building Systems and Components

Chapter

6

Materials

Chapter

7

Furnishings

A^A

Appendix A: Army Interior Design Process

A^B

*Appendix B: Planning for Administrative
Work Environments*

G

Glossary

B

Bibliography

I

Index

Guide to Excellent Interiors



US Army Corps
of Engineers®

Guide to Excellent Interiors



Lobby, Gunter AFB



Dining, Reynolds Army Hospital



Shop, Mountain Home AFB



Medical, Reynolds Army Hospital

Value of Interior Design

We all expect a facility to be functional and maintainable. Achieving coordination of the building interior and furnishings, meeting human ergonomic and psychological needs, and providing optimum aesthetic effect are identifiable and attainable goals for every interior design project.

People's reactions to interior environments is critical to the success of every facility type. These reactions were first identified in healthcare facilities, where color, texture, lighting, furnishings, and finishes all contribute to creating an environment which supports patient recovery and well-being.

Training, maintenance, laboratories, logistic support, medical, administrative, residential, morale, welfare and recreation facilities all have unique functional and aesthetic requirements. When these requirements are satisfied, workers, residents, and customers react positively, take pride in their contributions and in the facility, and perform to their maximum potential.

Why should you insist on comprehensive interior design in your facilities?

- To improve the morale and increase the productivity of the people in your facility.
- To use your space and financial resources in the most cost effective manner.
- To assure the health, safety and welfare of facility occupants.
- To project a professional image of your organization.
- To provide appropriate and maintainable building materials, finishes, furniture, and furnishings.



Atrium, Minot AFB



Office, Maxwell AFB

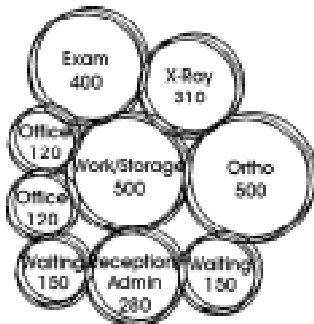

Program Bubble Diagram

Team Roles and the Design Process

To create high quality interior environments requires that the user, installation maintenance staff, commands, programmers, designers, engineers, construction workers, and suppliers work together toward clearly defined statements of design excellence.

- **Programming** is the first step in this process. Programming involves defining the project requirements and providing the financial resources to support them. This is where the user first forms a concept of what is needed.
- At **concept development** designers become fully involved in translating the user's operational and maintenance concepts into a built form. Designers work with the user to understand the reasons behind requirements and to give them form in terms of size, shape, and space layout.

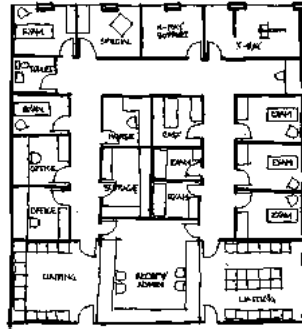

Conceptual Plan

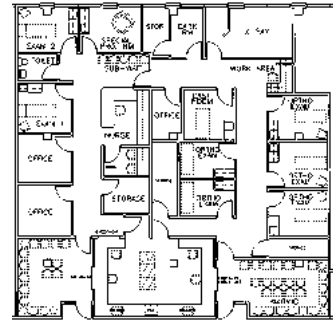

Working Drawings



Tele-Conferencing
Wright-Patterson AFB

- As the design is developed into **contract documents** and **procurement information**, the designer works with the user to specify requirements for construction, furniture, finishes, and furnishings. The documents created are the master plan for bringing the project to reality. They give the building, its interior spaces, furniture, and furnishings a coordinated form and aesthetic expression.



Library, Robins AFB



Fitness Center, Redstone Arsenal



Auditorium, USMA Westpoint



Child Development Center
Wright-Patterson AFB

- **Execution** involves guiding the work of those who construct the building and providing the furniture and furnishings. Attention to detail during building construction, as well as during procurement and installation of furnishings, is critical to the achievement of excellence.

Creating stimulating, comfortable, and appropriate environments for living and working is an achievable goal when the user and the design and construction team work together as partners.

Ensuring Excellence

The photographs in this guide represent the successful partnership between users, installation managers, designers, construction workers, and suppliers to bring about excellence in interior design. The photographs represent a broad range of facility types, locations, and design, construction, and furnishing techniques.

In every case, an involved user initially defined the concept in terms of functional requirements and financial resources and demanded excellence pivotal to the success of these projects. Proper programming ensures the allocation of adequate military construction funds for building, and adequate maintenance funds to provide for furniture and furnishings. Superior programming results from having a clear vision of what the project is to be. Designers can be of assistance in defining the needs but the vision starts with the user.

Superior programming enables excellence in design and construction. Excellence in design and construction results in facilities which optimize functional and aesthetic requirements and enable people to perform to their maximum potential.



Clinic Waiting, Minot AFB



Clinic Waiting,
Madigan Army Medical Center



Auditorium, Gunter AFB



Snack Shop, Gunter AFB



Atrium, Ft. McNair

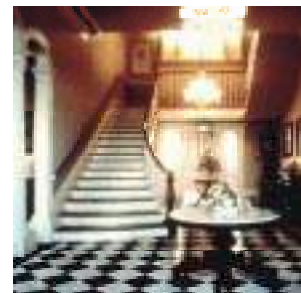

Visitor Center, Tenn-Tom
Waterway



**US Army Corps
of Engineers®**

PHOTO CREDITS

Cover

1. Lobby, Senior NCO Academy. Gunter AFB, AL.

p.i

1. Lobby, Senior NCO Academy. Gunter AFB, AL.
2. Dining, Reynolds Army Hospital. Fort Sill, OK.
3. Aircraft Engine Test Shop. Mountain Home AFB, ID.
4. Birthing Room, Reynolds Army Hospital. Fort Sill, OK.

p.ii

1. Atrium, Composite Medical Facility. Minot AFB, ND.
2. Wing Commander's Office, Consolidated Support Complex. Maxwell AFB, AL.
3. Teleconferencing Center, Stewart Hall, Acquisition Management Complex. Wright-Patterson AFB, OH.

p.iii

1. Library, Personnel Services Center. Robins AFB, GA.
2. Fitness Center, John J. Sparkman Center for Missile Excellence. Redstone Arsenal, AL.
3. Auditorium, Cullum Hall. U.S. Army Military Academy, West Point, NY.
4. Child Care Development Center, Logistics Command. Wright-Patterson AFB, OH.

p.iv

1. Clinic Waiting, Composite Medical Facility. Minot AFB, ND.
2. Medical Mall, Madigan Army Medical Center. Ft. Lewis, WA.
3. Auditorium, Senior NCO Academy. Gunter AFB, AL.
4. Snack Bar, Senior NCO Academy. Gunter AFB, AL.
5. Atrium, Marshall Hall, National Defense University. Fort McNair, DC.
6. Visitor Center, Tenn-Tom Waterway. Aliceville Lake, AL.

Design
Guide
for
Interiors

DG 1110-3-122
SEPTEMBER 1997

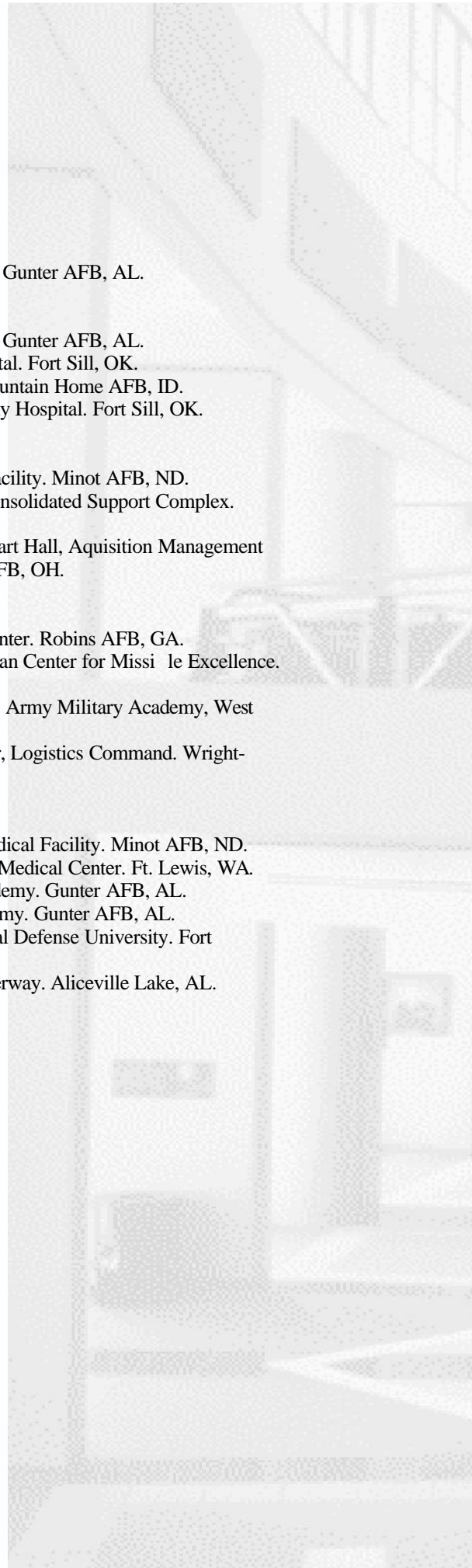

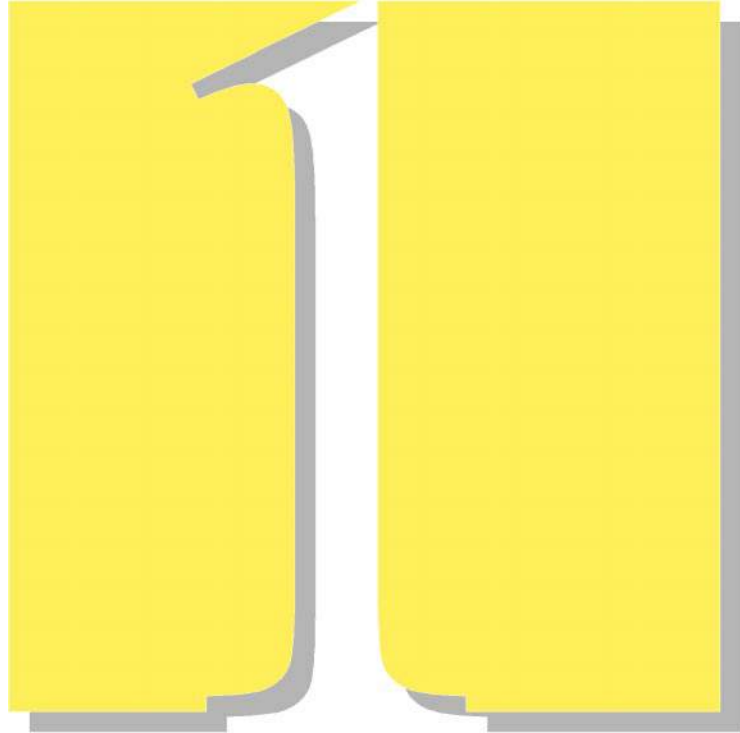

Introduction



Applicability of the Design Guide for Interiors	1.1
Organization of the Design Guide for Interiors	1.3

Introduction



Design Guide for Interiors

The purpose of the *Design Guide for Interiors* is to provide support to customers and designers in the creation of functional and aesthetic interior designs for facilities. The design guide addresses the full spectrum of design-related issues before the interior designer, with discussions of design theory, building technology, material resources, application, and criteria for selection of materials and products. The intent is to provide a common basis to communication and understanding of critical subject matter for the architectural and interior designer, so that facilities may be made harmonious in function and appearance.

Applicability of the Design Guide for Interiors

The *Design Guide for Interiors* is written to be applicable to three different audiences with varying needs. The pull-out "**Guide to Excellent Interiors**" gives Commanders an overview of the value and need for excellence in interior design. The remainder of the design guide provides USACE personnel having building design and construction responsibilities with information on a broad range of topics which impact the interior environment. The design guide also provides users and installation DEH/DPW staff with a general knowledge base, enabling them to perform minor renovations of interior spaces independently when professional interior design services are not available.

Design service providers are selected from in-house staff, architect-engineer (A-E) contracts, separate interior design contracts, or open-end interior design contracts. To be selected, an interior designer should have a record of functional, aesthetic design for similar projects, demonstrating efficient management and adherence to budgetary limits.

During the initial design phase, the designer should research the applicable criteria, regulations, architectural and engineering instructions, technical manuals, standard designs, codes, and industry resources. Army interior design definitions, processes, and responsibilities are derived primarily from the following documents.

- **AR 415-15, Army Military Construction Program Development and Execution.** Appendix H, Equipment Installation, defines installed building equipment, personal property (fixed), and personal property (movable). These definitions are important to planning, funding, programming, designing, and constructing or procuring interior features.

- **ER 1110-345-122, Engineering and Design, Interior Design,** derives from AR 415-15. The ER defines projects requiring interior design, design requirements and responsibilities of participants, and methods and funding for execution of interior design. Central to the understanding of this design guide are the definitions of building-related and furniture-related interior design.



Building-related interior design¹



Furniture-related interior design²

- **Building-related interior design** applies to all facilities and requires the design and selection of interior surface materials and items permanently attached to the structure. Layout for anticipated furniture and equipment will also be provided. Building-related interior design services are an integral part of project design and facility construction.

- **Furniture-related interior design** applies to facility types where the selection and arrangement of furniture and furnishings determines the functionality of the building. Furniture-related interior design involves the selection and layout of furniture and furnishings, which are not provided from construction funds. Furniture-related interior design services must be requested by the using activity. The using activity is normally required to fund furniture-related interior design services. In addition, the using activity must provide appropriate funds for procurement and installation of furniture and furnishings.

Responsibilities of the designer and the using activity are further delineated in ER 1110-345-122 *Engineering and Design, Interior Design*. Interior design solutions should be planned concurrently with architectural development to ensure appropriate design, finish, and layout. Project development that does not address interior design needs

¹ Security Operations Training Facility, Fort Devons, Massachusetts.

² Building 32, Wright-Patterson AFB, Ohio.

until the completion of architectural design can result in unaesthetic, inefficient, or costly facilities because the designer is restricted in choice of finishes and furniture arrangements. Coordination is especially important in the planning of lighting, communication, and electrical solutions; as well as the design and placement of heating, ventilating and air conditioning systems. The design of permanent fixtures, equipment, and built-in casework impacts multiple design disciplines, and necessitates that the interior designer be an integral part of the project team.



Guide to Excellent Interiors

Organization of the Design Guide for Interiors

The *Design Guide for Interiors* begins with a brochure entitled "**Guide to Excellent Interiors.**" This is a stand-alone overview of the value and process of interior design, and the role of the interior designer. "Guide to Excellent Interiors" is also available separately for distribution to facility users, to aid them in their involvement in the interior design process.

Chapter Two of the *Design Guide for Interiors* discusses the relationship between **Human Behavior and the Interior Environment**—how we perceive space, and how we react to it. Chapter Three is a technical discussion of **Light and Color**—two of the primary elements which are used to define space. Chapter Four addresses **Design Basics**—elements and theories of composition.

The next three chapters discuss the physical makeup of interior space—**Building Systems and Components** which give space structure and convenience; and **Materials and Furnishings** which form the interior designer's primary palette.

Appendix A, **Army Interior Design Process**, provides guidelines on the procedure to be followed in executing an interior design project. Appendix B, **Planning for Administrative Work Environments**, outlines the design process for a specific application.

The **Glossary** explains many of the design-specific terms used in the guide. The **Bibliography** lists the source of those works referenced herein. The **Index** provides a detailed directory of text subjects.

Supplemental tabs numbered one through seven hundred are provided for cataloging additional information from the user's own resources by construction category codes. This information may include major command and installation criteria and guidelines, or notes from facilities classes.

The *Design Guide for Interiors* is meant to be a ready reference. It is neither a textbook nor a design solution. It attempts to cover in some detail those issues which might arise during the design process and which might otherwise be left unaddressed for lack of such a reference.

The *Design Guide for Interiors* will prove helpful for anyone unfamiliar with interior design terminology and application. These users should begin by reading Chapters 2, 3, and 4, which cover theoretical aspects of design. The remaining chapters may then be referred to, as needed, for answers to questions pertaining to building construction, finishes and furnishings.

No one source can substitute for the knowledge gained through education and experience. For persons seeking additional information, the bibliography contains names of texts which provide more detail on any of the topics addressed herein. It is intended that the *Design Guide for Interiors* provide not a comprehensive reference, but sufficient resources to begin the interior design process.



Human Behavior and the Interior Environment



Sociological Human Need	2.1
Psychological Human Response	2.3
Perception and Aesthetic	2.3
Human Response to the Interior Environment	2.4

Human Behavior and the Interior Environment

This chapter examines the relationship between individuals and their environment—how they perceive space and how they react to it. Perception of one's environment is affected by sociological needs, psychological state, and individual differences. The environment itself also influences human behavior. Both mental and physical stimuli affect behavioral responses. In this chapter material is presented which will help the reader to be more aware of the matters which affect the occupants of a space.

Sociological Human Need

People's perception of their environment influences their social interaction within that environment. Social interaction can be discussed in terms of four concepts: privacy, personal interaction levels, territoriality, and crowding.

Privacy is a central regulatory human process by which persons make themselves more or less accessible to others. In an office environment, privacy may be manipulated through the use of partitions which protect the individual from physical, visual and acoustical intrusion. The plan of an office environment establishes the privacy level at which the office functions.

Definition of an individual's **interaction levels** is one mechanism used in achieving a desired level of privacy. Besides needing enough space to move about and perform various tasks, each person moves within a domain that expands and contracts to meet individual needs and social circumstances. The size of a space determines perceptions, experiences, and uses of that particular environment.

People inherently discern their relationship with others in terms of distances, or spaces, between them. Edward T. Hall defines four distinct distances at which interpersonal transactions normally take place. These are

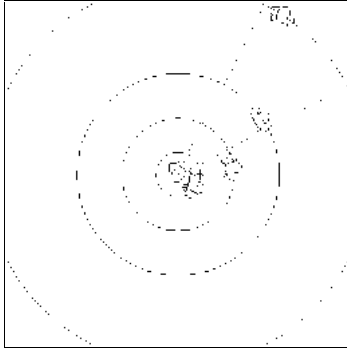

Fig. 1 Levels of space: intimate, personal, social, and public.

categorized as intimate, personal, social, and public¹ (Fig. 1).

- **Intimate space** is that area immediately surrounding the individual's body. This area is the most private and involves both physical and emotional interactions.
- **Personal space** is that area within which a person allows only select friends, or fellow workers with whom personal conversation is mandatory.
- **Social space** is that area within which the individual expects to make purely social contacts on a temporary basis.
- **Public space** is that area within which the individual does not expect to have direct contact with others.

The more intimate the spatial relationship, the more people resist intrusion by others. Personal space factors are important in establishing privacy requirements for interior design.²

Territoriality is a means of achieving a desired level of privacy. It involves the exclusive control of a space by an individual or group. This control implies privileges and may involve aggressive actions in its defense. For the individual, territorial control provides security and identity and is communicated through personalization and definition.

Crowding occurs when personal space and territoriality mechanisms function ineffectively, resulting in an excess of undesired external social contact. Sociologically, people respond to crowding in different ways depending upon the situation. Sometimes humans tolerate crowding, though it may be unpleasant, because they know it is only temporary. In some situations crowding may be considered desirable, it may even be sought after if it is perceived as "part of the fun" or the expectation within a social setting. In either situation, however, psychological discomfort may be experienced if the crowding is perceived as too confining.

¹ Edward T. Hall, *The Hidden Dimension* (Garden City, NJ: Doubleday & Co., 1990), pp. 122-125.

² Hall, pp. 7-10.

People respond to their environment based upon perception, cognition and spatial behavior.

Psychological Human Response

Responses to the environment are complex and best understood in terms of three psychological stages of human behavior: perception, cognition, and spatial behavior.

Perception of the environment, in its most strict sense, refers to the process of becoming aware of a space by the acquisition of information through the sensations of sight, hearing, smell, touch, and taste. **Cognition** is the mental processing of this sensory information. This may involve the activities of thinking about, remembering, or evaluating the information. **Spatial behavior** refers to responses and reactions to the environmental information acquired through perception and cognition.

The designer creates environmental stimuli to direct these psychological stages as well as the secondary processes of motivation, effect and development. **Environmental expectations**, another determining element to be considered by the interior designer, are developed over time through experience and interaction with the environment. Sensations, in combination with expectations of the environment, define one's perception of a space.

Perception and Aesthetic

As stated above, perception of the environment, and consequently the aesthetic appeal of that environment, involves the acquisition of information through our five senses. A person's experience in the environment is very complex. Individual differences such as sex, age and health, to name a few, are important determinants of behavioral responses to an environment. The designer must take into consideration the individuality of various occupants of an environment, their likes, dislikes and personal histories.

Color proves to be an important factor in the perception of an environment's aesthetic. If used carefully and skillfully, it can positively influence mood and behavior. A full range of psychological and emotional effects can be achieved through use of color. Color selection is an integral part of any project design, whether painting

walls, installing floor coverings, upholstering furniture, or selecting art, plants, or graphics.

Perception of the relative size and appearance of a space is often related to color. The following are some generalities to remember about color, human perception and aesthetics. (See Chapters 3 and 4 for additional information.)

Color may be used in various ways to influence our perception of space.

- Certain colors may make a space appear larger than it actually is, while others cause spaces to appear smaller.
- Certain colors may cause a space to seem warm, while others may make it seem cold.
- Colors have a definite effect on the mood of the observer. Some colors are stimulating, others are relaxing.
- Colors that clash with each other may produce feelings of irritation or uneasiness.

Human Response to the Interior Environment

Each person responds uniquely when confronted with a specific situation or experience. These responses fall into three categories—sociological, psychological and physiological—all of which are influenced by factors within the interior environment.

Sociological determinants relate to the social needs and problems of the occupants. Factors that pertain to these sociological responses, including group dynamics and communication, should be considered during planning.

Sociological determinants such as group dynamics and communication affect personal interactions within an environment.

Group dynamics (the interpersonal relationships among members of a small group) are a result of the personality and cultural backgrounds of the individuals involved, their task, and the nature of the physical setting. Spatial arrangements in small groups are functions of environment, task, and personality. Various cultures respond differently to the amount and arrangement of space.

In determining the physical arrangement of an interior space, the interaction distances between work groups and the tasks to be performed are very important to successful communication and social relationships. The

study of small group ecology is important not only from the standpoint of understanding the impact of social relationships, but also from the practical standpoint of designing and maintaining a variety of functional spaces in which various relationships can be fostered.

Studies of **communication** reveal that, in conversation, people prefer to sit across from one another rather than side by side. If the distance between conversing people becomes too great however, they will usually choose to sit side by side rather than across from one another.

The scale of a room—it's size relative to the occupants—also influences conversational distance. As room scale diminishes, people tend to sit closer together. Likewise, increased noise levels and distractions drive people to sit closer together.

Psychological determinants affect an individual's sense of well being in the environment.

Psychological determinants in the planning of an interior environment relate to the psychological needs and concerns of the occupants. Visual privacy, acoustic privacy, and aesthetic factors are key determinants to be considered.

Visual privacy addresses the ability to limit other's view of oneself. Inherent in human behavior is the tendency to avoid situations in which one can be watched without being aware of who is watching. Visual privacy can be achieved through the use of furnishings, partitions or walls. In a private space or an office, people will often orient their desk in order to visually control the doorway and achieve a visually private space on one side of the desk (Fig. 2). Similarly, people prefer to sit with a protected back, controlling the area they cannot see directly. In restaurants, the first seats to be filled are usually those along the walls. In outdoor spaces, people tend to sit against or beside objects such as trees and bushes rather than in the open.

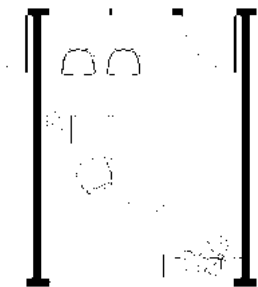

Fig. 2 Visual control is a key to visual privacy

Acoustic privacy in an interior space results from effective treatment of the acoustic environment as an interrelationship of many components: ceiling, partitions, furniture, equipment, and floor. A complete acoustic system will generally provide adequate speech privacy. Speech privacy is achieved when there is sufficient acoustic shielding to allow conversation to be unheard beyond the participants of the conversation. A high quality of speech privacy will contribute

significantly to a desirable level of communication, social interaction, and productivity. An appropriate relationship between background noise and that produced within the activity space is conducive to speech privacy.

Aesthetic appreciation is both expressed in and influenced by the environment. To define aesthetic qualities, the designer needs to understand that the concept of beauty differs with time and place, purpose and context. Values captured under the label "aesthetic" can best be understood at a universally comprehensible level. These aspects of a design go beyond the functional and constructional concerns, and are associated with the specific way the design presents itself to the human senses. The designer uses an object to serve some need or want. When we look at an object, its physical appearance causes a sensory experience in us above and beyond its mere utility. The designer's appreciation of this experience helps him to communicate his intent and understanding to the user.

Physiological determinants relate to physical needs of the occupants. Factors to be considered during the planning phase that deal with physiological responses include functionality, ergonomics, life safety, and health concerns.

Functional efficiency relates to the degree to which physiological needs are supported in the interior space plan. These needs, which are physical in nature, relate to human body requirements. Interior environments must respond to basic human functional needs—vision, hearing, stability, and mobility—to achieve both comfort and efficiency.

Physiological determinants affect our physical comfort in a space.

The ability to comprehend one's environment as well as to perform tasks within it are strongly dependent upon **vision**. The critical variables in human vision are visibility, legibility and recognition. **Hearing** is critical because it not only affects ability to communicate but also the general capacity to perform other tasks. The critical variables in human hearing are audibility, intelligibility, signal-to-noise ratio, and noise annoyance. **Stability** refers to elements that support individuals as they walk and move about or perform functional or manipulative tasks. Some of the elements that need to be

considered in terms of **mobility** include slope of floors, width of walkways, depth of stair treads, location of handrails, and height of door thresholds. All physiological needs affect how a person perceives and reacts to an environment. When these needs are appropriately met, the user will perceive the environment as successful.

Studies show that a worker's productivity increases with an improved environment. Emphasis upon the following specific environmental conditions contribute to improved worker efficiency.

- Proper illumination for each task.
- A suitable acoustic environment that allows ease of communication, limited intrusive noise (and resultant distraction), and protection from ear damage where appropriate.
- Human/facility interface features designed to be used within human mobility and strength limits. (Special attention should be given to the removal of accessibility barriers for the handicapped worker.)
- Physical features of the facility that are compatible with typical human expectations and comprehension.
- A plan that conserves human energy.
- An environment that allows workers to function within their most productive range of motion.

Ergonomic design recognizes that the environment significantly influences and impacts human behavior. Each aspect of the interior design—including space, furnishings, and environmental variables such as temperature, sound, humidity, and ventilation—needs to be carefully assessed in terms of its compatibility with the purpose for which it is intended: to conform to the human body. The challenge is to plan for the intended activities, furnishings, and finishes that are appropriate for the purpose of the expected user. Ergonomics combines **anthropometrics** (human body measurement data), physiology, and psychology in response to the needs of the user in the environment. This data is used by the designer to create interior designs which are both humanistic and functional in nature.

The success of any design depends upon the degree to which it creates an interface between users and the environment.

Life safety and health concerns are primarily focused on human response to negative stimuli; the natural responses when an individual sense danger—generally referred to as fight or flight. Life safety centers on the ability of an individual to vacate a facility in a timely manner when necessary. Generally this is accomplished through an assurance of adequate travel path capacity for the occupants of the space, and a clear indication of a safe means of egress. In a panic or emergency situation, people generally do not have the opportunity to decipher codes which may indicate safe passage at an abstract level. It is imperative that the guide mechanisms be highly visible and clearly stated. Obviously this impacts the designer's desire to control the visual environment as completely as possible. It is therefore in the designer's (as well as the user's) best interest to be aware, from the outset, of the regulatory and common sense criteria that guide the development of egress systems; to work with them to enhance the overall plan, as opposed to applying them at the end over an executed design concept.

Health concerns are often less obvious than life safety. Ergonomic design is an aspect of health consciousness. If a space functions properly for the task, it is less apt to cause physical harm—such as repetitive strain injury (carpal tunnel syndrome) or simple backache. Health concerns also factor into the selection of materials. Fumes from paints or carpet adhesives may cause severe bronchial stress or headaches in some individuals. Often, odors of even non-toxic elements may raise concerns that will foster absence among workers. The designer cannot control all such contaminants, but must be conscious of the range of possible impacts of material selections, and avoid such occurrences when possible.

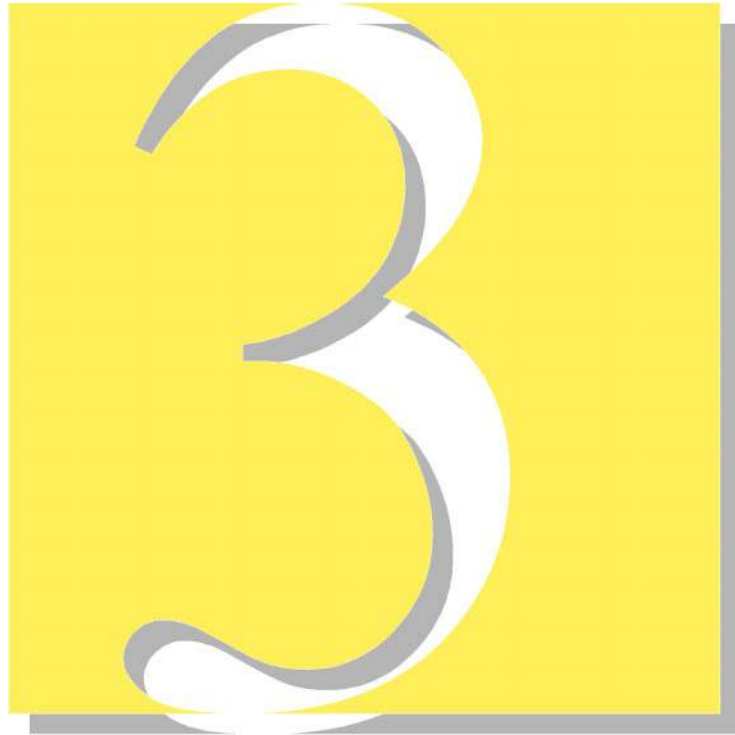

Light and Color



Introduction to the Science of Light and Color	3.1
The Luminous Environment	3.3
The Nature of Color	3.6

Light and Color

Light and color play an important role in the design of interior environments. To use them effectively, the designer must have a working knowledge of the science of light and color and how they work together. This chapter discusses light and color terminology in order to give a better understanding of how to use them to their fullest potential.

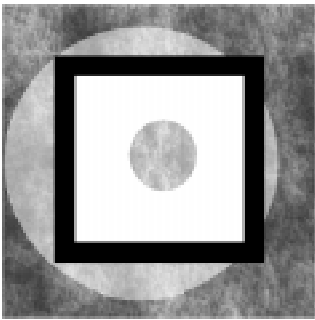

Fig. 1 White light on a white board with a hole.

Introduction to the Science of Light and Color

Visual perception requires the interaction of a light source, an object, the eye, and the brain. Light energy is the medium of communication between the object and the eye. We may observe energy radiating directly from a source (such as the sun), or only that which is reflected from some object in the path of the light.

When light strikes an object, some of its energy is absorbed; we see only that light which is reflected back from the object. The light-reflective property inherent in an object that determines its color is its **pigmentation**. Commonly we refer to the pigmentation of an object as its color. A white board in space with a hole in the middle of it reflects back all light incident upon it, and thus appears white (Fig. 1). The hole "absorbs" all light incident upon it, and thus appears black.

Quantity of light is the amount of light energy present in an environment. It is described in terms of energy incident per unit area, and is quantified in footcandles or lumens. Quality of light is most often described in terms of color temperature, quantified in degrees Kelvin. The temperature referred to is that of a "blackbody radiator," one which is black when cool, but heats to red-orange, yellow, and eventually blue-white. The color change is due to the increased energy output of the heated body and the shift in wavelength of the light energy being produced. Our eyes interpret the various wavelengths of light as color.

White light contains the full spectrum of visible light. Objects perceived as white are those which reflect all colors (Fig. 2). An object may be perceived as red for one of two very different reasons. The light source may

An object's apparent color is dependent upon both the pigmentation of the object and the color of the light shining upon it.

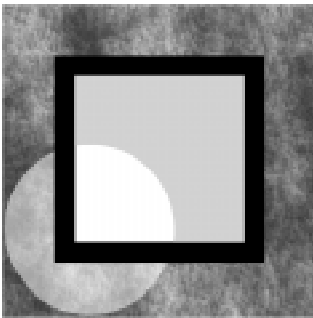

Fig. 2 White light on a white board.

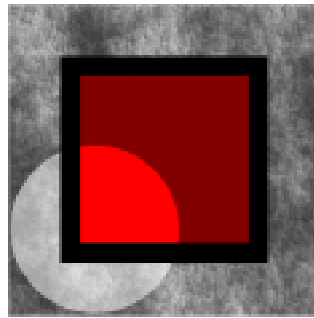

Fig. 3 White light on a red board.

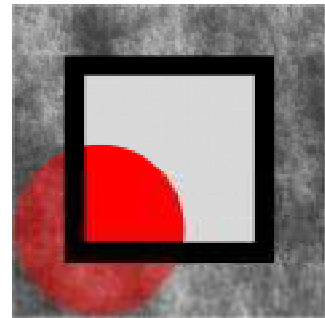

Fig. 4 Red light on a white board.

be white, while the object reflects only red (Fig. 3); or the object may be white, but be illuminated only by red light (Fig. 4). The result is the same: we see a red object.

Perceived color is also dependent upon the ability of the receiver to distinguish between wavelengths of light. Red-green color blindness is a relatively common malady which limits the ability of the subject to perceive the difference between red and green. Similarly, a black and white television receives the same information as a color television; but is unable to process it, and thus produces a different image.

Spatial Perception and Definition

Distance is a critical factor in one's perception of space. **Perspective** describes our perception of objects over a distance, and is defined in part by the clarity, quantity, and intensity of light received from an object. Because light emanates radially from any given source, and its total energy remains constant; the farther we are from an object, the less light we receive from it. Through experience we are conditioned to perceive dimmer objects as farther away and brighter objects as closer.

Darker colors tend to recede from view (Fig. 5), lighter to encroach (Fig. 6). Similarly, when colors are placed closer to the viewer, they appear more brilliant, more intense than the same colors placed at a greater distance.

Our perception of space is also affected by shading, the way that light is captured or reflected by an object. At a distance, or when lit from behind, a sphere and a disk may appear to be identical (Fig. 7); however, when nearby and illuminated by a direct source from any direction other than behind, the way light reflects off of

the object gives us additional information about its true shape (Fig. 8).

Dark colors recede while lighter colors encroach; thus, the box on the left appears deeper than the one of the right.

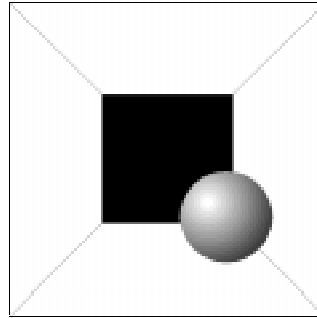

Fig. 5 Dark surfaces recede.

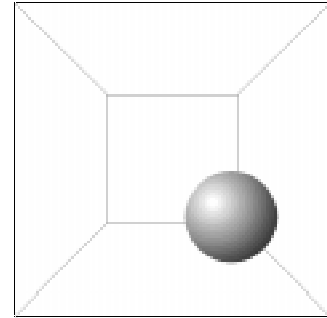

Fig. 6 Light surfaces encroach.

Lighting location may dramatically affect perception of an object or space.

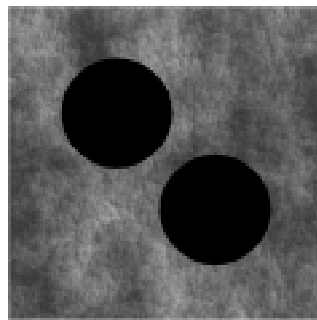

Fig. 7 Objects illuminated from the rear.

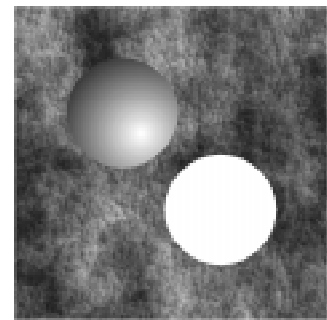

Fig. 8 Objects illuminated from the front.

The Luminous Environment

The quality of an illuminated environment is established through the manipulation of light to communicate specific information. In achieving a design which responds meaningfully to aspects of human behavior, designers must recognize that light affects how well work tasks can be seen (visibility), and subsequently how well they are performed (productivity). Of equal or even greater importance is how light affects visual quality and the sense of well-being experienced by users of a space.

In any given environment, the user should be able to see easily, comfortably and accurately. The illumination level required to achieve these results will vary based on a number of factors related to the user and the given activity taking place. The illumination level required for most spaces and environments is a function of the following:

- the type of activity,
- the characteristics of the visual task (importance, difficulty), and
- the age of the user (as the eye ages, it requires more light for visual tasks).

The Illuminating Engineering Society of North America (IESNA) has developed recommended ranges of lighting levels needed for many visual tasks, activities, and the general illumination of spaces. A sample schedule of ranges is given in Chapter 5. For a more complete understanding of this subject, please refer to the *Lighting Handbook, Reference & Application* by the IESNA.

Quality and Quantity

In order to understand how visual quality and quantity of light affect the experience of users of a space, one must first understand the concepts of brightness and reflectance.

Brightness refers to how much light energy is *reflected by a surface*. The degree of brightness of an object depends upon the color value and texture of its surface. Brightness can be relative or measured. When a gray object is viewed first on a black background and then on a white background, the brightness level appears different (Fig. 9). However, the measured brightness, or luminance, of the object would be equal.

Reflectance is defined as the *ratio of light incident upon a surface* to that reflected. Reflectance of major surfaces in a space is critical to achieving intended brightness ratios.

Brightness ratios are critical to the understanding of the visual field required for a specific task. Brightness is of significant benefit to the viewer, as ability to distinguish fine detail increases with object brightness. Of equal importance is relative brightness between objects being viewed and their surroundings. Some degree of contrast in brightness is required. For example, it is very difficult to see any object against a similarly colored background (Fig. 10).

A maximum brightness ratio of 3:1 between the task surface and background is recommended by the IESNA.

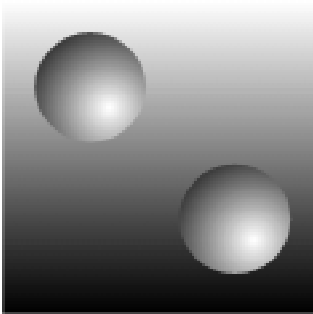

Fig. 9 Relative brightness is dependent upon context.

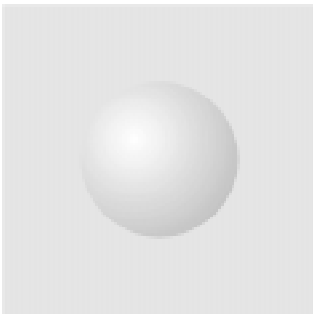

Fig. 10 Low-contrast figure.

Between the task area and darkest part of the surrounding space, the brightness ratio should not exceed 5:1. Brightness ratios higher than these values can lead to glare, visual fatigue, and loss of performance.

Contrast between objects and their background is especially critical for visual tasks that require discrimination of shape and contour. This need is easily understood on the printed page where dark letters can best be read when printed on light paper. For visual tasks requiring that one see surface texture and detail, less contrast between the surface and its background is desirable because the eye will adjust automatically to the average brightness of a scene. A brightly illuminated background serves to silhouette any object seen against it. **Glare** is the result of too much contrast between objects within the field of vision.

Undesirable glare-producing conditions include two types: direct and reflecting. **Direct glare** (Fig. 11) is caused by the brightness of light sources within the normal field of vision. **Reflecting glare** (Fig. 12) may be caused by the same source as direct glare, but results from light reflecting off the task surface. The term **veiling reflection** is sometimes used to describe this type of glare because the reflection of the light on the surface veils the task and obscures the image. Reflecting glare is most severe when the task or viewing surface is shiny—has a high specular reflectance value.

A single source may cause glare in different ways.



Fig. 11 Direct glare.

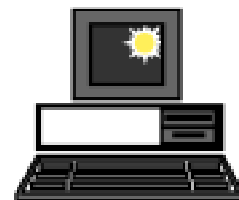

Fig. 12 Reflecting glare.

Light in Relation to Surface

The surface texture of an object will affect the distribution of light reflected from that object. Surface textures can be classified into one of three categories: specular, semi-specular and matte. **Specular reflection** (Fig. 13) redirects light without diffusing it—the angle of reflection equals the angle of incidence. **Semi-specular reflection** (Fig. 14) diffuses light but still maintains the cohesiveness of the light pattern, thus maintaining the general direction but “spreading” the light a little. **Matte reflection** (Fig. 15) diffuses a light

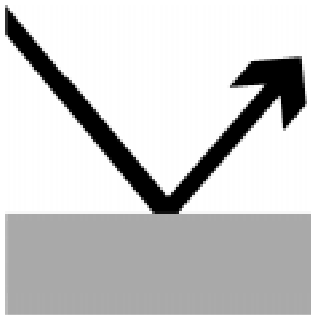

Fig. 13 Specular reflection

Specular, semi-specular and matte surfaces differ in the way they reflect light.



Fig.14 Semi-specular reflection

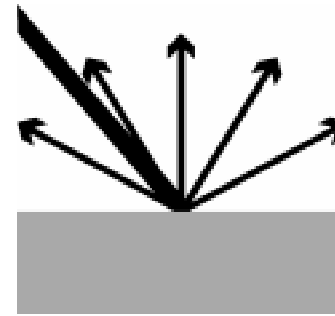

Fig. 15 Matte reflection

beam, causing the incident light to be reflected in all directions.

The color of objects often appears to change with surface finish. Specular reflections from glossy surfaces may increase the saturation and darkness of colors at one angle while obscuring colors and causing glare at others. Matte finishes of highly diffusing materials (such as velvet and deep pile carpeting) cause shadows within the surface that make the materials appear darker than smooth surface materials (such as satin, silk and plastic laminates) of the same color.

The Nature of Color

When discussing color, the three qualities of hue, value and chroma need to be defined. Hue, value and chroma together form a complete description of any color. **Hue** (Fig. 16) relates to the distinctive characteristics of a color as described by a basic color name or a particular position in the spectrum. **Value** (Fig. 17) is the relative lightness or darkness of a hue in relation to a scale of

grays ranging from black to white. Light values are called **tints**, dark values are **shades**. **Chroma** (Fig. 18)

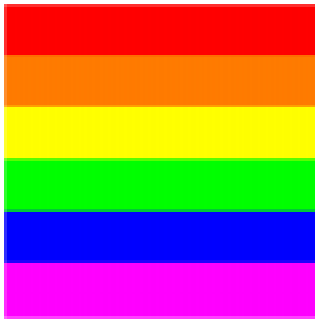

Fig. 16 Hue

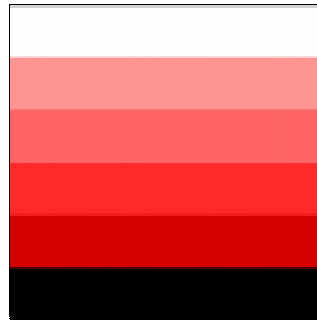

Fig. 17 Value



Fig. 18 Chroma

refers to a hue's purity or saturation. Adding a color's complement, decreases its chroma, as the purity of the original color is diminished.

The **color wheel** (Fig. 19) is a circular representation of hues arranged according to their relative position when a beam of light passes through a prism. The color spectrum is organized first by the three **primary colors**—red, yellow, and blue—located equidistant from each other on the color wheel (Fig. 20). Between the three pure hues fall the **secondary colors** (Fig. 21). Green,



Fig. 19 Color wheel

violet, and orange are each created by the combination of two primaries. The **tertiary colors** (Fig. 22) are created

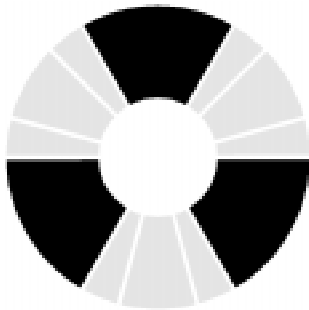

Fig. 20 Primaries

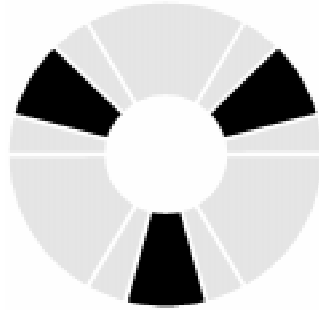

Fig. 21 Secondaries

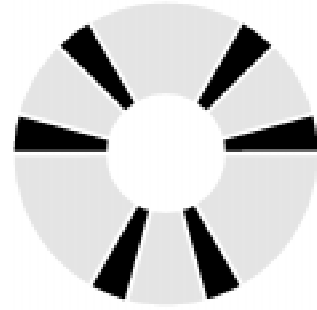

Fig. 22 Tertiaries

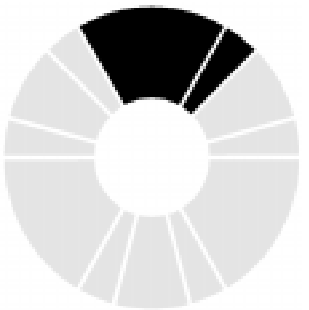

Fig. 23 Analogous

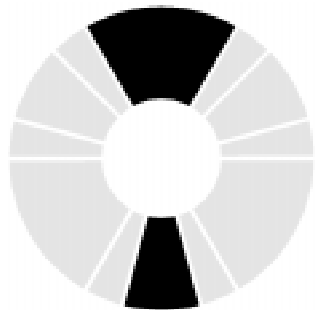

Fig. 24 Complementary

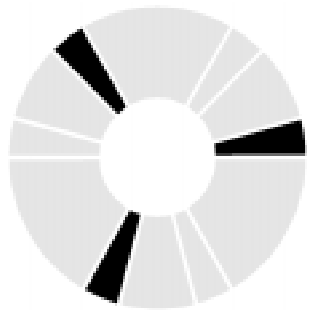

Fig. 25 Triad

The color wheel may be used to show color families and relationships.

when a primary and related secondary combine. Yellow-green, blue-green, blue-violet, red-violet, red-orange, and yellow-orange constitute the tertiary hues.

The hues of the color wheel can be discussed in terms of their relationships to one another. **Analogous colors** (Fig. 23) are those adjacent on the color wheel. **Complementary colors** (Fig. 24) are two colors located opposite one another on the color wheel. A **color triad** (Fig. 25) consists of three colors spaced equidistant from each other on the color wheel.

An understanding of the theories of light and color is essential to our ability to work with these most important components of design. In Chapters 4 and 5 we continue our discussion of light and color from the perspectives of conceptual application, and the technical means of achieving the desired affects.

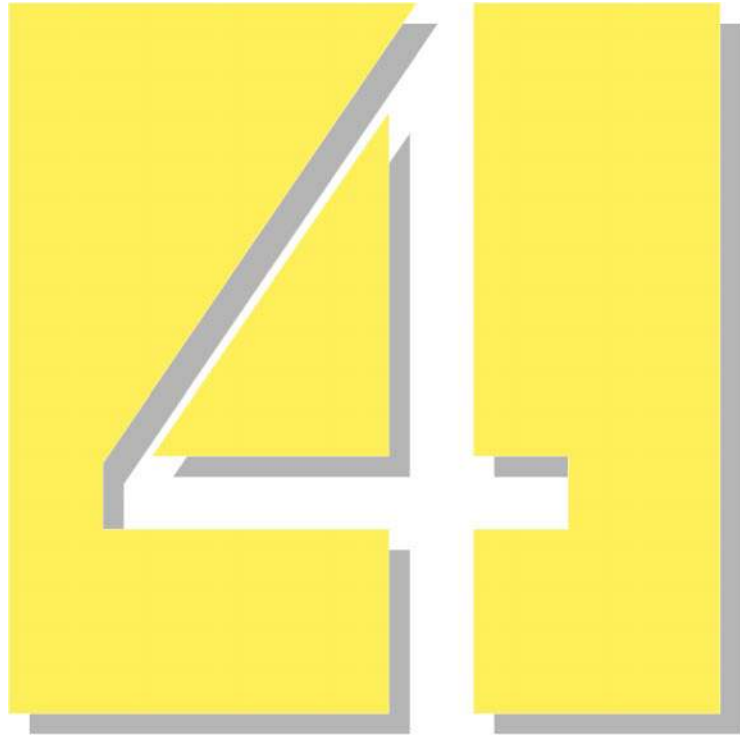

Design Basics



Elements of Design	4.1
Principles of Design	4.4
Workplace Design with Color and Light	4.6
Developing a Color Scheme	4.9

Design Basics

A knowledge of design basics is key to the successful planning and implementation of any interior design project. The **elements** and **principles** of design represent general, universal ideas that refer to every aspect of design. Once designers understand how people perceive and react to their environments (as discussed in Chapter 2), they can use the elements and principles of design to form a whole composition. This chapter discusses the elements and principles individually in order to fully understand each one and its respective potential in a design.

Elements of Design

The **elements** of design provide a framework for problem solving in the design process. Form, texture and color are the components brought together to create an environment.

Form encompasses the spatial definition of a thing, its extent in one, two, or three dimensions. In mathematics, form is spoken of in terms of point, line, and plane. In design, we speak of line, shape, and volume.

- **Line**, by definition, is the extension of a point. It can be straight or curved. Line can express various feelings and emotions—a smooth, delicate line seems serene and soothing while a heavy, frantic line can signify anger or energy. One of the most expressive qualities of line is its direction. Vertical lines evoke aspiration, stability and ascendancy. Horizontal lines express feelings of rest and relaxation. Diagonal lines suggest movement and activity (Fig. 1). Large upward curves suggest gentle, relaxed movement. Downward curves seem serious and sad. Small curves denote playfulness and humor.

- **Shape** refers to two-dimensional forms created by intersecting lines. Shape can be simple geometric forms such as a square, triangle or circle, or they can be irregular and amorphous, conforming to no particular definition. Simple geometric forms tend to evoke



Fig. 1 Diagonal lines bring dynamics to a static space.¹



Fig. 2 A composition of irregular shapes becomes a landmark.²

¹ Dependent Youth Activities Center. Ft. Meade.

² Fitness Center. John J. Sparkman Center for Missile Excellence, Redstone Arsenal, Alabama.

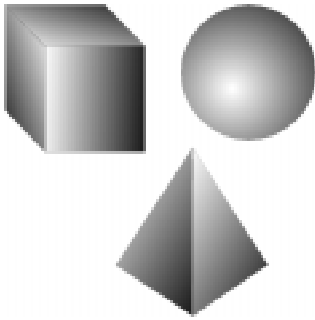

Fig. 3 Volume extruded, rotated and mapped

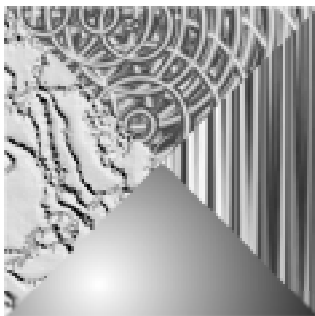

Fig. 4 Texture tactile and visual

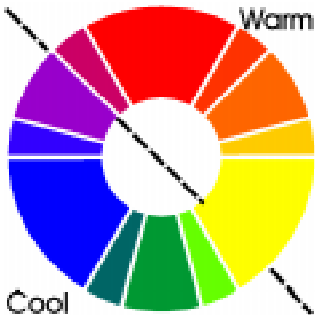

Fig. 5 Warm and cool colors on the color wheel

stability and completeness while irregular shapes may appear more dynamic and interesting (Fig. 2). Either, used in excess, may create boredom or unease.

- **Volume** refers to the extension of shape into three dimensions (Fig. 3). In an interior environment volume is typified by objects, such as furniture, and by residual space—that defined by structure and captured by columns, doors, etc. Space defined by walls is the most common volume in interior design. As with shape, volumes can be either geometric in nature or free-flowing and irregular. Totally geometric spaces can seem formal or restrictive while free-flowing spaces can feel open or confusing.

- **Space** is the infinite extension of a three-dimensional field. Not only is space the realm where shape and volume exist, but it also determines their aesthetic qualities. Sculpture, pottery, jewelry, and architecture all use space in their design. Designs in space require interaction when viewing or experiencing, whether walking around a sculpture, wearing a piece of jewelry, or living in a piece of architecture.

Texture is essentially a tactile characteristic, but may be perceived by either touch or sight (Fig. 4). Texture may be rough, smooth, bumpy, fuzzy, grooved, or prickly. Tactile texture is felt, while visual texture is seen, imparting impressions of textures. Visual texture is often referred to as pattern. A pine cone has a texture one can feel as well a pattern one can see. Texture can be used to create different feelings in an environment—smooth textures seem cold and impersonal while rough textures seem warm and natural.³

Color encompasses both art and science. Chapter 3 discussed the science of color, here it is discussed as an element of design. Because color evokes such strong emotional responses, it is one of the most important elements of design.

- Hues on the color wheel can be divided into two categories: warm and cool (Fig. 5). Red, orange, and yellow constitute the warm hues which tend to stimulate and excite. Warm colors can elevate the apparent

³Marjorie E. Bevin, *Design Through Discovery* (New York: Holt Rinehart and Winston, 1989) pp. 99-100.

temperature of a room and make interiors seem cozy and friendly. The cool colors—blue, green and violet—tend to soothe and relax. They elicit feelings of formality and reserve and can seem refreshing on a hot day.⁴

• **Color harmonies** are pleasing combinations of color. In theory any hue can be made to harmonize with any other hue by manipulating its value and chroma. Color harmonies typically fall into two categories: related or contrasting. **Related color schemes** are composed of one or several neighboring hues and promote harmony and unity. **Contrasting color schemes** are based on hues

Color combinations related...

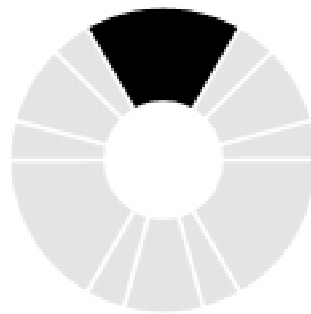

Fig. 6 Monochromatic

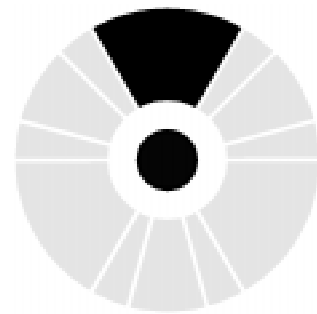

Fig. 7 Monochromatic plus black

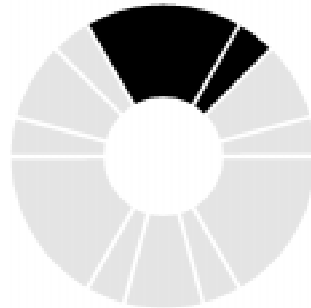

Fig. 8 Analogous

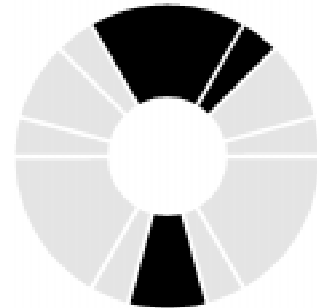

Fig. 9 Analogous plus complementary accent

located far apart on the color wheel. These offer variety and balance.

Some color harmonies form the basis of **technical color schemes**, which identify particular combinations of pure hues. These serve as guides in developing a color palette for an interior environment. The schemes do not imply that the pure hues of color systems are the only hues that can create a scheme, they simply provide a place to start. The technical color schemes include

⁴ Bevlin, p. 133.

monochromatic, monochromatic plus black, analogous, analogous plus a complementary accent, complementary,

...and contrasting

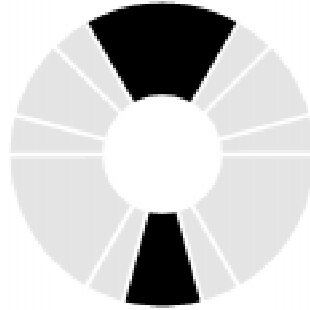

Fig. 10 Complementary

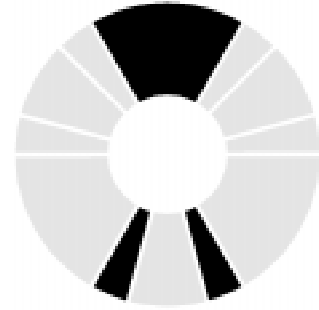

Fig. 11 Split complementary

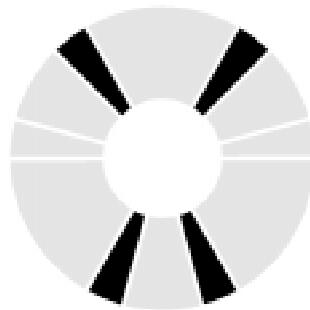

Fig. 12 Double split complementary

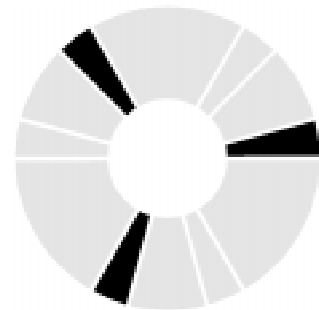

Fig. 13 Triad

near or split complementary, double split complementary, and triads (Figs. 6-13).

Principles of Design

The **principles** of design are used to organize individual elements into a workable, aesthetic design concept. They include balance, rhythm, emphasis, harmony, proportion, and scale.

- **Balance** results from the interaction of inter-playing forces, attractions, and weights. Balance strives for a state of equilibrium in order to create a sense of tranquility. Balance can be achieved in varying ways (Fig. 14). **Symmetrical balance** deals with designs whose halves are mirror images of one another. This type of balance usually connotes feelings of formality, security, and stability due to its predictability. **Asymmetrical balance** deals with designs whose visual weights are equivalent but not identical. This balance is informal and active in nature, it suggests movement and

spontaneity. Asymmetrical balance tends to be more interesting than symmetrical balance and more difficult to achieve. **Radial balance** occurs when elements repeat around a central point (Fig. 15). The chief characteristic is a circular movement away from, toward, or around a focal point. Radial balance can sometimes be symmetrical if, when divided along a line piercing the center, the halves are identical mirror images.

- **Rhythm** provides an underlying unity and evolving variety. Continuity, recurrence, or organized movement constitute rhythm. Repetition and progression are two

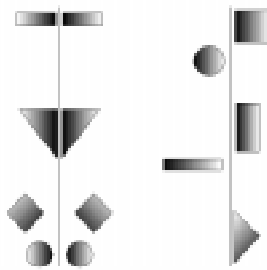

Fig. 14 Symmetrical (left) and asymmetrical (right) balance

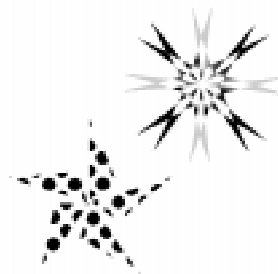

Fig. 15 Radial (left) and radial symmetrical (right) balance

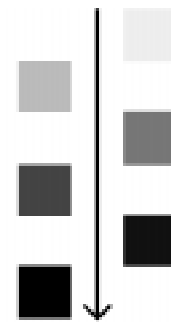

Fig. 16 Progressive rhythm

primary ways of developing rhythm. **Repetition** of an identical form, shape, line or color gives a unifying characteristic to an environment. In **progression**, ordered systematic change develops movement by modifying one or more of the spatial elements to create a sequence or transition (Fig. 16). Because it suggests motion, progression can be more dynamic than simple repetition.

- **Emphasis** deals in terms of dominance and subordination. Properly used, it calls attention to the more important elements of a space (Fig. 17). It helps to define focal points, visual rest areas and progressive degrees of interest in between. Emphasis can be achieved through position, light, shape, or contrast.

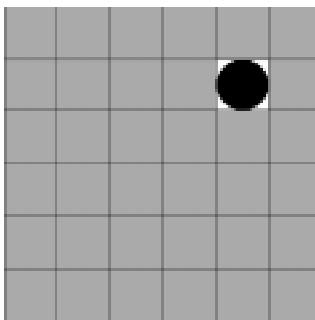

Fig. 17 Emphasis

- **Harmony** is marked by a consistent, pleasing interaction of spatial elements. In achieving harmony, the elements and principles working in a space must relate to each other and to the overall design concept. **Unity** describes elements of a whole which are in accord. Unity makes for ease of identification, but proves dull when unrelieved. **Variety** modifies parts of



Fig. 18 Proportion

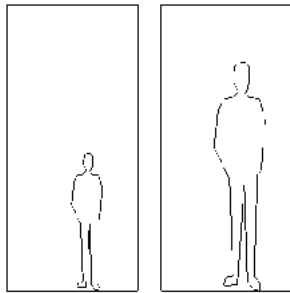

Fig. 19 Scale

an environment by means other than progression. Without some unifying factor such as color, shape, pattern, or theme, variety can be discordant.

- **Proportion** is the desired relationship of parts to the whole (Fig. 18). Related to size, it deals with magnitude, quantity, or degree. The relationship between parts is such that if one part varies, another varies in a ratio to the first. While a well-proportioned room seems just right, and a poorly-proportioned room seems too long or too wide; no indisputable system for determining proper proportions exists.

- **Scale** conveys the relative size of an object that has been measured by a dimension of comparison, such as the human body (Fig. 19). Oftentimes, scale is used to demonstrate the relationship between man and his environment. Large scale usually denotes power, formality, security, and elegance by feeding the human ego. Smaller scale does just the opposite and can denote child-like wistfulness.

The elements of design are the building blocks used in creating an interior. The principles of design are the methods in which those building blocks are arranged. All of the elements and principles must work together in order to create a pleasing, aesthetic environment. The designer must have an understanding of the essence of each, as well as knowledge of how each works in an interior environment. This knowledge allows the designer to utilize his or her imagination in creating unique environments that satisfy various needs and desires.

Workplace Design with Color and Light

In the design of the optimum workplace, job performance, as it relates to employee satisfaction, is enhanced by colors that are stimulating, cheerful, and comforting. Because the work environment has a direct relationship to employee efficiency, colorless offices can be counterproductive. Off-white, buff and gray need to be balanced by additional colors to stimulate the user. Muted colors occurring in nature tend to produce comfortable office environments.

Specific areas of interior environments require special attention. Cool hues should be used in areas where a great deal of concentration is necessary. Similarly, calming colors should be used in high stress areas.

The colors of furnishings are also important because they contribute to the balanced contrast between black and white. Gray may be ideal for desk tops and work surfaces since it is a neutral color and not distracting. It creates a good balance in contrast with either black or white, and it helps maintain a comfortable and uniform brightness level.

Color palettes and combinations affect different users of a space in different ways. It is up to the designer to develop a basic knowledge of the most common human responses to different colors and color combinations and then to determine those responses specific to the end-user.

The following is a list illustrating some of the most common human responses to different colors and color combinations.

- Reds are associated with tension and danger. They may add life and cheer to blends of blues and greens; but they generate unpleasant tensions when used with strong greens.
- Oranges share qualities of reds. They may be used to stimulate or modify otherwise neutral or cool color schemes.
- Yellows are the mildest of the warm colors and are often associated with cheerfulness.
- Greens are the cool colors closest to the warm on the color wheel. They are often perceived as peaceful.
- Blues are the coolest of the cool colors, suggesting rest, repose, calmness, and dignity. If overused they may be perceived as depressing and gloomy. Intense blue in small areas can be a helpful accent in warm and warm-neutral color schemes.
- Violets fall between cool and warm colors. They are often perceived as artistic, suggestive, and sensitive but may be perceived as ambiguous or too strong.

Colors of walls, floors, ceilings and furnishings all play a vital role in influencing our perception of a space.

Although these color responses are common, care must be taken when working outside of one's own cultural environment to ensure the intended interpretation.

- Black is a powerful accent color. It is often associated with—and suggests—weight, dignity, formality, and solemnity.
- Neutral colors tend to convey, in milder form, impressions of the hues that they contain. Neutral grays make background colors easy to live with but are subject to dullness, and sometimes appear monotonous.
- Whites and near whites suggest clarity, openness, and brightness. Whites are generally safe colors and can be used in large areas to a highly satisfactory effect if offset with small areas of chromatic color. Too much white can produce glare.

The nature of emotional responses to the environment will depend heavily on the value and saturation level of the hues. Greens and blues, thought to be calming, become very effective when used in high-stress areas such as doctors' offices. More saturated colors, such as deep greens and purples, are often used as accents to give a feeling of status and dignity, for example in executive offices or reception areas.

Color is one of the first elements that people respond to when presented with a design concept. Each individual will respond uniquely to a color presented them based upon upbringing, education and socio-economic background. As a designer, it is important to determine the impact of color within the essence of the space.

Color and light are effective means by which space may be articulated or defined. The surface treatment of walls, floors, and ceilings articulates the spatial boundaries of a room. Color, texture, light, and pattern affect our perception of relative positions in space and, therefore, our awareness of a room's dimension, scale and proportion. Spaces may be made to appear larger than they are by unifying them with color and light that blend surfaces rather than fragment them.

The effect of color and light on the perception of space (the apparent, versus the actual, size and distance of objects from a viewer) will vary among individuals; however, the following are some general guidelines of how color and light may be used in the design of a space.

- Light, cool spaces are generally perceived as expansive; dark, warm spaces as diminishing.

Color in combination with light can redefine our perception of space.

- A strong, warm color on an end wall will shorten the apparent length of a room by drawing that wall forward. Cooler colors will cause the plane to recede, thereby expanding our perception of the room.
- Dark ceilings will lower the apparent height of a room. Light ceilings will raise the apparent height of a room. However, a combination of a dark floor and ceiling can greatly reduce the apparent height and may seem oppressive.
- Strong-valued ceilings and floors may help to unify a space.
- A brightly colored wall will appear larger than it actually is.

In addition to aesthetics, two safety color codes are currently being used by professionals in the design field: those of the **Occupational Safety and Health Administration (OSHA)** and **American National Standards Institute (ANSI)**. Both share some of the same conventions, such as the use of the color red for indicating fire protection equipment. For detailed specifics regarding the application of either system, the designer should refer directly to an OSHA or ANSI guidebook.

Developing a Color Scheme

The development of a color scheme involves four phases: analysis, schematic design, design development, and documentation. Each of these phases can be broken down into various steps for the designer to follow.

During the **analysis phase** the designer examines the factors which will impact the color choices in a space.

- Proposed use of the space.
- Size of the space.
- Directional orientation of the space.
- Ages and types of people occupying the space.
- Time of day the space will be used and the activities to occur at those times.
- Existing color surrounding the space.

- User's color preference.

During **schematic design**, the designer develops a color palette based on the results of the above analysis phase and the following procedures.

- Determine the technical color scheme.
- Determine actual colors and their tints and shades.
- Evaluate the scheme for appropriateness.
- Evaluate the colors and their compatibility.
- Evaluate the colors in relation to natural and artificial light.
- Modify the color selections if necessary.

During the **design development phase** the designer researches available products that complement the chosen color scheme.

- Investigate the market for wood, wallcoverings, furniture, fabrics, carpets, and other interior materials suitable for the space.
- Evaluate the findings from above and modify the color plan as necessary.

The **documentation phase** involves recording the findings and design decisions to ensure proper execution of the design. The design must accurately communicate color specifications to those who order materials through drawings and specifications.

During the course of a project, the designer will present the interior design to the using agency. The method of presentation should be clear and concise to avoid any misunderstanding. Such presentation may also include sample boards with all related finishes displayed and identified in an orderly manner. The presentation boards serve as an explanation of the color concept and the relations of new and existing items. The designer must be certain to re-state all criteria impacting the project and present solutions that satisfy the established criteria.

Color scheme development is, like all design, an iterative processes. It involves a cycle of analysis, solution, and evaluation. The starting point may be completely arbitrary, but the final solution must stand up to the criteria upon which it will be judged.



Building Systems and Components



Architectural	5.1
Structural	5.10
Mechanical	5.12
Electrical	5.19

Building Systems and Components

Building systems are those primary elements which together define the shape, utility, and comfort of built space. They are classified by discipline: Architectural, Structural, Mechanical, and Electrical. These systems must be planned and designed in concert; individually, they are composed of lesser components, such as interior framing systems, air-conditioning units and plumbing fixtures. Knowledge of how these systems coordinate and interconnect, as well as familiarity with the individual component systems and disciplines is essential for the successful integration of these items. Their coordination is critical to the overall appearance and operation of the completed interiors project.

Architectural

Architectural systems define the volumes and functions of a building. Every project begins with a statement of needs, developed by the end-user and designer, from which an initial space plan is developed. This plan sets the course for the rest of the project, including the locations of mechanical rooms, electrical closets, plumbing shafts, and data/communications shafts within the space. The development of other systems follows the architectural lead. Architectural systems are primarily concerned with enclosure (walls, roof), and definition (partitions, floors, ceilings). For interiors, definition is the primary concern.

Spatial Definition is accomplished primarily by establishing a series of planes in space which organize our understanding of a place.

The primary system of organizing or defining architectural space is the **partition**. Partitions (or more commonly "walls") define and divide space. In modern construction, the stud-framed partition, either metal or wood, is most prevalent. In commercial construction metal is most frequently used (Fig. 1). A typical partition consists of studs at 400 mm (16 inches) on center with gypsum wallboard on each side. The partition may bear directly on structure, or sit on the finished floor, and may extend to the ceiling or beyond - depending upon various requirements placed on the wall to control thermal variance, acoustics, firespread, etc. Its thickness may range from 65 mm (2-1/2 inches)

to more than 300 mm (12 inches) depending on what services are contained within, or what other

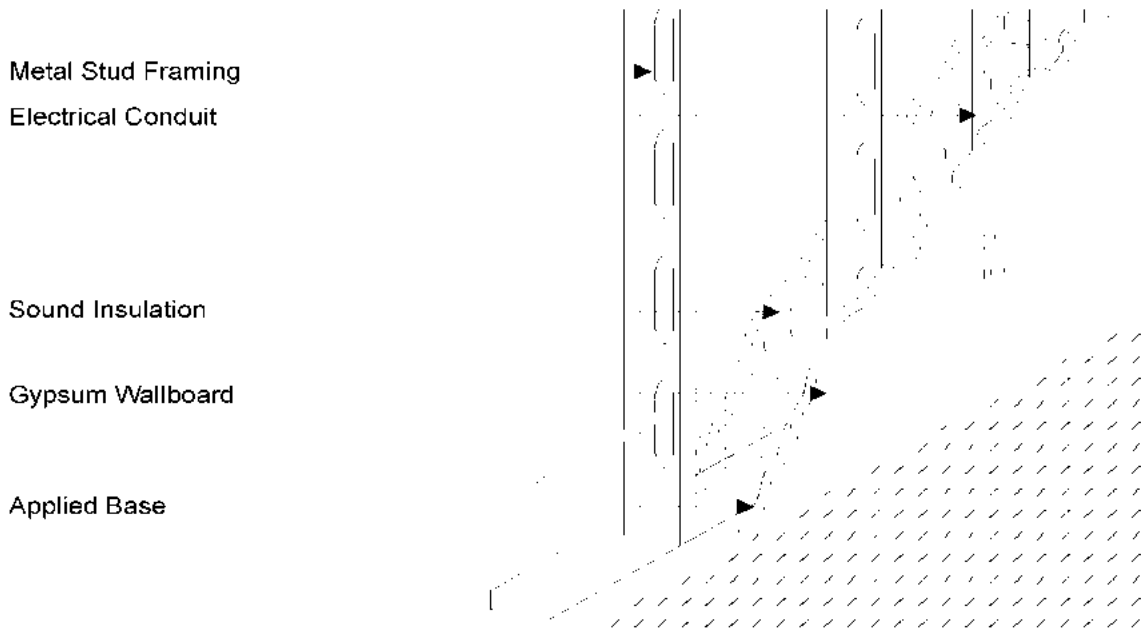

Fig. 1 Stud partition

requirements are placed upon it. Stud partitions are basically hollow, thus providing opportunity for distribution of power, communications and tempering systems. In addition, they may be filled or insulated for increased thermal and acoustical performance.

Partitions may be pre-constructed or demountable—built in factories to modular sizes and shipped to a jobsite for installation. In addition to gypsum wallboard and wood or metal studs, partitions may be glass, wood, metal, or masonry. In each case, the only requirement is that the partition satisfy the demands placed upon it, and that the existing structure be able to support it.

Floors and ceilings also define architectural spaces. Although partitions in the strict sense of the word, they are not typically referred to as partitions except in specific instances. (When *partitioning* off a space, the ceiling is a part of that *partition* and must therefore meet code *partition* requirements; however, it is still generally referred to as the ceiling.)

Together, floor and ceiling planes make up the largest share of an interior environment. Floors are typically flat but level changes can be added for spatial separation or aesthetic variety. Floors in commercial structures are

typically constructed of concrete, or concrete on metal deck. This can be left exposed, as in industrial facilities, or totally covered with another floor covering such as carpeting, wood flooring, or vinyl tile.

Many times, ceilings are overlooked in the design of an interior environment. They are left bare and used simply as overhead protection. The ceiling is, however, an important part of the overall design of an environment. By changing the angle of the ceiling plane, piercing it with windows, or adding soffits and coves, the designer can make the ceiling an active part of the design. The

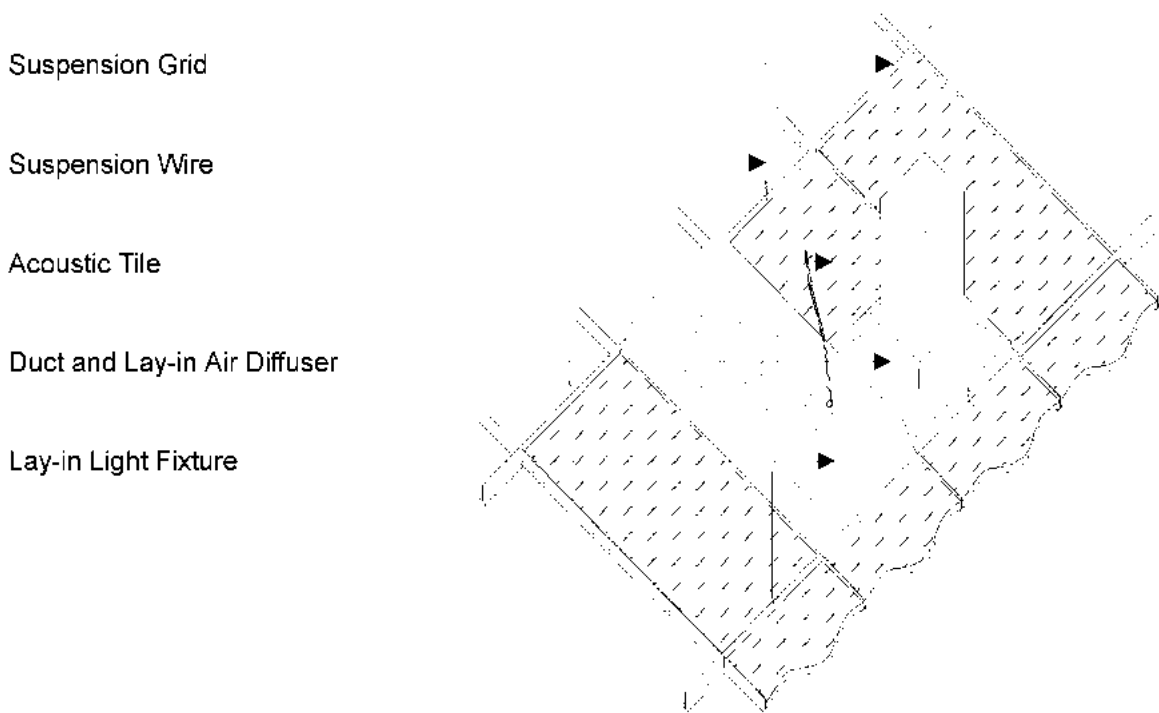

Fig. 2 Suspended ceiling

ceiling can be left smooth or fitted with light fixtures, vents and decorative elements. Ceilings can be constructed from a variety of materials: plaster and lath, gypsum board, wood, suspended ceiling systems (Fig. 2), metal, or glass.

Millwork, as a part of architectural systems and componentry, encompasses standing and running trim, paneling, doors, and windows. Broadly speaking, millwork is any ready-made product that is manufactured at a wood mill or woodworking plant. This is generally construed as piece goods. For a

Millwork may be functional or decorative, largely dependent upon the designer's intent.

discussion of wood types, and casegoods construction, see chapter seven. For a discussion of wood finishes, see chapter six.

Architectural millwork has three primary functional origins. The first is one of necessity: doors and windows have traditionally been constructed from wood due to its wide availability and ease of workability. Millwork is also a decorative solution to concealing the construction of a space. Wood-paneled rooms were originally conceived as elegant woodgrained renditions of the expressed structure of a space. Finally, millwork serves a use which is a cross between the decorative and the functional, depending upon the intent of the user: baseboards, door trim and ceiling moldings are often the most expeditious way to close the joint that exists between two construction elements. Whether the piece becomes decorative or not is the designer's choice.

Standing and running trim refers to two distinct classes of wood trim. Standing trim refers to fixed length trim such as door and window casing, window stoops and door thresholds. Running trim is continuous trim used to form baseboards, cornice moldings, chair rails, etc. Almost any shape is available in wood trim, especially if custom trim is an option. Each millwork house or trim manufacturer offers its own standard profiles, which are then the most readily available and economical.

Paneling is the term used for wood applied to a wall surface. It may be assembled from rails and panels of solid wood, or from plywood. Simply stated, paneling is any flat assembly of wood members applied to a vertical surface.

Doors (which, like walls and ceilings, are an architectural space organizer) are typically one of two kinds. The **flush door** is available in solid or hollow core construction. Flush doors are typically constructed of two veneered faces glued to a frame which contains either a honeycomb core of kraft paper (hollowcore); or a solid core of industrial board or laminated wood staves (solid core). Solid core construction is heavier, stronger, and more resistant to the passage of sound than hollow core doors, and is generally more expensive. Flush doors

of either type are available in a variety of veneer species, the least expensive of which are intended to be painted.

Stile and rail doors are traditionally constructed of a wood framework of vertical (stile) and horizontal (rail) members infilled with shaped wood panels. Today the look of stile and rail doors is available in traditional construction, stamped metal, stamped hardboard, or veneered structural plastic. The traditional wood construction stile and rail door is still the most appropriate for commercial use where the look of stile and rail is desired. Stamped metal and structural plastic tend to be limited in use to exterior applications. Stamped hardboard is simply a shaped hollow core door used primarily for economy in residential applications. Many of the problems typically associated with stile and rail doors, due to movement of the panel and loosening of joints, have been eliminated or minimized with new construction technologies and materials, and as a result, a quality stile and rail door today is nearly as stable as a solid core door.

Construction and Life Safety

In addition to giving definition to a space, the architect or interior designer needs to provide for the safety of the occupants within the space. The means of construction contribute to the total life safety package. Walls, floors, ceilings, doors, and windows are all required to provide protection from fire, environmental contaminants, and the elements. Standards for construction, as published in building codes and technical manuals dealing with specific construction materials and techniques, have been rigorously tested and confirmed to meet stringent requirements. Even minor variances in the construction of a building can change its resistance to these factors in unforeseen ways.

Acoustics

Besides providing protection, the envelope that defines interior space also affords a tempering of the environment, through acoustic and thermal control. Both sound and heat are transferable energy. Thermal requirements for an interior space are generally contained within the shell of the structure and will not be

dealt with here. Acoustic control is the more pertinent topic.



Fig. 3 Elimination

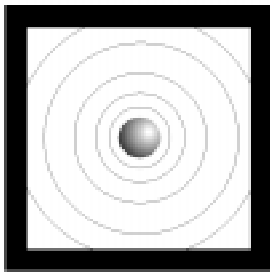

Fig. 4 Isolation

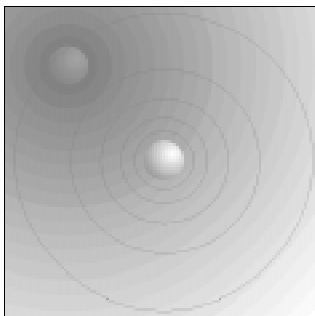

Fig. 5 Masking

Acoustics as an environmental variable significantly impacts the human impression of an interior environment. Productivity, speech intelligibility, privacy, safety, positive user attitude and response, and environmental “comfort” all depend on proper acoustic design. The interior designer is concerned with reducing unwanted noise and preserving desirable sound in a space. Enhancing the quality of communication through the use of reflective surfaces, and reducing undesirable noise through the use of absorptive surfaces is achieved by the specification of finishes, furnishings, equipment, and specially designed assemblies. Sound can be controlled in three ways.

- Eliminate the source (Fig. 3).
- Isolate the source—provide a barrier between the user and the source (Fig. 4).
- Mask the offending sound—if not possible to isolate the sound, minimize its impact on the user (Fig. 5).

In addressing acoustics and communication within an environment, it is necessary to consider levels of speech intensity. For example, intensity levels are likely to be greater among occupants over the span of a conference table than over an executive desk in a private office. Optimum planning for open areas will include consideration of background noise, and use of absorptive ceiling, flooring, and furnishing elements. With enclosed space, the noise reduction capabilities of construction between rooms significantly influences speech privacy.

Sound is measured on a relative scale, in decibels (dB or dB), with 0 dB being the threshold of audibility, and 130 dB the threshold of pain. In an office, a general noise level of 45 to 55 dB is considered satisfactory. This level will help reduce the distraction associated with squeaky chairs, opening and closing drawers, and ringing phones. It also allows for easy conversation in normal tones at close range. Other noise levels of varying activities are given in the chart shown in Figure 6.

In dealing with acoustics in an environment two major topics need to be addressed: excessive noise and sound

Pressure Level in Decibels	Example	Subjective Impression
140	Jet Plane Takeoff	(Short Exposure Can Cause Hearing Loss)
130	Artillery Fire	Deafening (Threshold of Pain)
120	Jet Plane (Passenger Ramp)	
110	Hard Rock Band	(Threshold of Discomfort)
100	Power Lawnmower	Very Loud (Intolerable for Phone Use)
90	Kitchen Blender	
80	Noisy Office	
70	Average Street Noise	Loud
60	Normal Conversation	Usual Background
50	General Office	
40	Private Office	Noticeably Quiet
30	Quiet Conversation	
20	Whisper	Very Quiet
10	Human Breathing	
0 dB		Intolerably Quiet (Threshold of Audibility)

Fig. 6 Decibel Pressure Levels of Common Environmental

transmission from one area to another.

Excessive noise within an environment includes opening/closing drawers, squeaky chairs, printers or

copiers, shuffling feet, etc. Excessive noise is all noise beyond that which provides an ambient level conducive to normal conversation. All surfaces within an interior can contribute to the Noise Reduction Coefficient (NRC) of a space. The NRC indicates how well a material will absorb sound on a scale of 0.00 to 1.00, with 1.00 being total absorption. The most common use of the NRC rating appears on ceiling materials. Most acoustic ceilings have NRC ratings between 0.50 and 0.90. The minimum recommended NRC rating for acoustic material in open plan offices is 0.80. Generally, the thicker, softer and more porous a material is, the greater

Material	NRC
Bare Concrete Floor	.05
Tile or Linoleum on Concrete	.05
Carpet - 1/8" (3 mm) pile	.15
Carpet - 1/4" (6.5 mm) pile	.25
Carpet - 3/8" (9.5 mm) pile	.37
Plaster Ceiling	.45
Metal Pan Acoustic Ceiling	.60
Systems Furniture Partition Surface	.65
Carpet over Padding	.65
Suspended Mineral Board Acoustic Ceiling	.90

Fig. 7 Noise Reduction Coefficients of Common Finish Materials

its NRC. The table in Figure 7 shows NRC levels for different interior materials.

Sound transmission deals with noises coming outside the occupied space. Typically sound transmission is dealt with during construction, through use of heavy building materials or double-wall construction. However, once the structure is complete, interior materials can give some improvement. The Sound Transmission Class (STC) indicates a material's effectiveness in preventing sound transmission. The following table gives STC

ratings for varying materials; the higher the number, the better noise is blocked (Fig. 8).

The selection of materials for wall finishes, floor covering and ceilings must be coordinated to assure the desired level of acoustic control. Additionally, providing window coverings over large expanses of interior/exterior window wall glazing, and/or the installation of an electronic sound masking system will contribute to a successful level of acoustic control.

Material	STC
5 mm (3/16") Plywood	19
Open-Plan Furniture Screen Panel (Typical)	21
16 mm (5/8") Gypsum Wallboard	27
22-Gauge Steel Plate	29
120 mm (nominal 2 x 4) Wood Stud Partition with One Layer 16 mm (5/8") Wallboard Each Side	37
170 mm Staggered Wood (nominal 2 x 4) Stud Partition with One Layer 16 mm (5/8") Wallboard Each Side	45
150 mm (6") Concrete Block Wall	46
150 mm (3-1/2:") Steel Stud Partition with Two Layers of 16 mm (5/8") Wallboard Each Side	55

Fig. 8 Sound Transmission Coefficient of Common Building Assemblies

Among interior surfaces, the ceiling is the largest surface affecting noise reflection and absorption. In a standard office environment, the ceiling system should produce minimal sound reflectance. Systems that reduce sound reflectiveness are flat, absorbent ceiling panels, baffles and vaulted ceiling components. The size, shape, number, and placement of luminaires, as well as the shape of other hard-surface ceiling components such as diffusers, will increase the specular, or mirror-like, reflectiveness of the ceiling.

The floor is the second largest surface area for absorption or reflectance of sound. Carpeting will absorb a significant amount of impact sounds such as chair movements and shuffling feet as well as other office sounds. Cut pile carpeting absorbs more sound than loop pile carpeting; the greater the pile height and weight in cut pile carpets the greater the absorption.

The degree of treatment of wall surfaces depends on the intensity of the sound and the distance between the sound source and the surface. Generally, fewer vertical surfaces will have to be treated in a large room than a small one. The larger room has more volume to dissipate the sound and a greatly diminished wall to floor and ceiling surface ratio. Besides providing sound insulation within partition cavities, draperies covering windows or walls, panels of acoustic material hung on the walls, and acoustic material (panels and paints) applied to interior walls all are effective treatments in minimizing noise reflectance.

Structural

The structure is the skeleton of the building. The structural plan is often the first component reviewed by the designer, especially if interior wall relocation is being considered. The structural module, a geometric increment, is the base unit of organization utilized by the structural engineer in setting the structural system for a building. In addition to providing definition and clarity to the work of the structural designer, the resultant expression of the module—whether the repetitive spacing of ceiling joists or pans, or the regular placement of columns—provides a framework for the organization of the interior spaces. The overlaid spatial organization should integrate the lighting layout, ceiling grid, mechanical systems, partition planning, and furniture layout within this larger framework. Interior columns that define bays may be concealed by integration into partitions, or left exposed within the space and used to provide reference points for the occupants, or to define specific zones of activity.

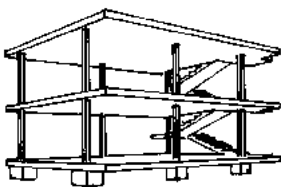

Fig. 9 Maison Domino

The paradigm of the modern building is the simple **Maison Domino** (Fig. 9), Le Corbusier's diagram of the skeletal "machine for living". It consists of a field of

regularly spaced columns and floor plates. An actual structure may not be much more complicated, with greater definition given only to the structure of the floor (larger spans may require a framework of joists and beams to support the floor slabs), and to lateral bracing (to prevent the structure from rocking under wind load or other horizontal force).

The primary structural information an interior designer must be aware of is what elements of the space provide the structural support, and how do those elements interrelate (Fig. 10). A few basic guidelines will help.

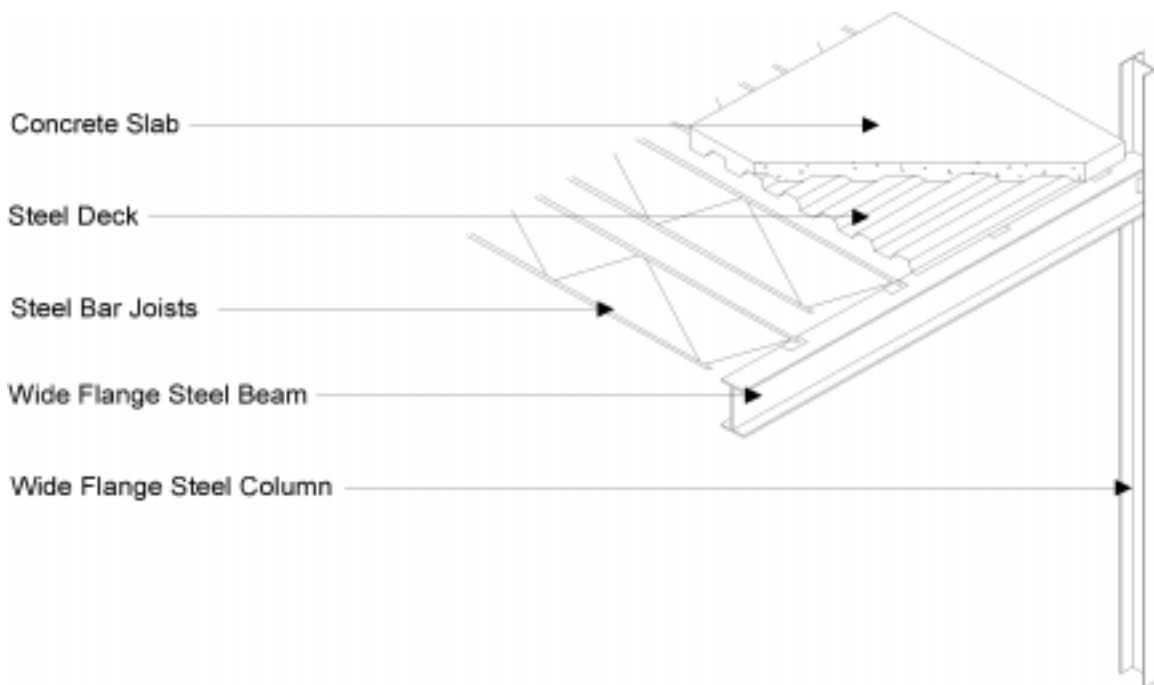

Fig. 10 Modern construction members

- Modern structures are primarily steel or concrete. The choice is based upon the availability of materials and structural constraints of the individual materials.
- Vertical support members, columns and structural walls carry loads, and are generally not modified after construction.
- Beams may be solid or trussed construction. Trussed beams have openings in them which may be used for the passage of building systems. Solid beams may be penetrated for such passage, but this is primarily done in the initial design of the building and seldom after construction. Beams join columns in perpendicular

connections critical to the overall integrity of the structure. Whenever modifications are to be made to a beam, it is imperative that a structural engineer be consulted.

- Joists are smaller beam elements that carry the floor loads to other, larger, beams. The rules stated above for beams also apply to floor joists.
- Floor slabs are generally concrete, either formed over a temporary framework, or over a steel pan which remains in place and provides some portion of the structural capacity of the floor. Services may be run through floors with relative ease. Large openings may require the addition of supplementary joists to support the edges of the opening. Smaller openings require coordination to avoid interference with the supporting structure. Additional small openings for the passage of plumbing and electrical services are commonly required during the fit-out of spaces.
- Structural systems may not always be what they appear to be. A simple stud partition which terminates at the ceiling may not be a structural member, but it may in fact conceal lateral bracing for the structure. As with all systems discussed in this chapter, elements exist which may be concealed; and before proceeding with any significant reorganization of a space, it is best to ask the opinion of a structural engineer or architect.

Mechanical

The mechanical systems in a building are designed to perform a variety of functions. They are responsible for heating, ventilating and cooling the environment as well as supplying fresh water and disposing of waste water. The designer must have a basic knowledge of these systems and equipment functions to understand their impact on interior design.

Heating, Ventilating and Air Conditioning (HVAC)

HVAC system concerns for the interior designer relate not only to the visible elements such as radiators, convectors, registers, outlet grilles, or ducts—which are the end nodes of the systems—but also to the infrastructure that supplies those elements. Two primary

types of systems exist: central and local. Central systems provide either tempered air or water throughout the facility from a single location. Local systems are generally stand-alone and receive their energy via gas or power lines. While central systems provide an economy of scale in operation, local systems may allow for greater comfort and economy if demand is not uniform throughout a facility.

Central air distribution systems (Fig. 11) circulate tempered air from a central plant through ducts which are typically located above the ceiling. Return air may also be carried through ducts or may travel through an open ceiling plenum.

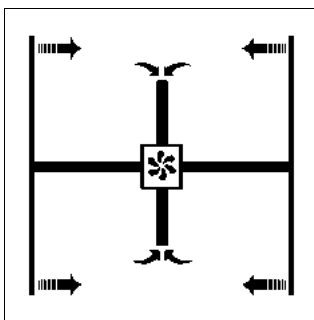

Fig. 11 Central air distribution system

Air systems may be configured as one or two duct systems: hot *or* cold, or hot *and* cold. Ductwork design plays a critical role in the planning of a space, particularly as it affects ceiling clearances. The main duct line that feeds directly from the central plant may be quite large, but as it branches out, the end-ducts require less space.

Friction within the ductwork affects the efficiency of the system. It is determined by length and difficulty of travel for the air stream. Straight travel, with no turns vertically or horizontally, through square or circular ducts is preferred. Rectangular ductwork is more common due to size limitations.

Economy of scale and ease of introducing fresh air are the primary reasons for choosing a central air distribution system. Conversely, these systems may create undesirable linkages—acoustically as well as environmentally—between spaces which, ideally, should be separated.

Central water distribution systems (Fig. 12) circulate tempered water or steam through a series of branching pipes. Relative to air ducts, these conduits are fairly small—only 200 mm (8 inches) or less in diameter. Travel distance and configuration are not as critical as in air systems. Water systems may be configured as two (hot or cold, and return), three (hot, cold, and return), or four (hot, hot return, cold, and cold return) pipe systems. Two pipe systems require central switching from heating to cooling, and are less flexible than three or four pipe

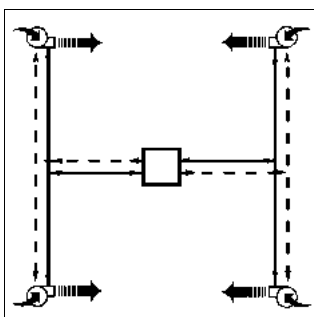

Fig. 12 Central water distribution system

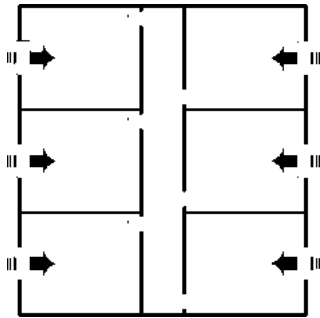

Fig. 13 Local distribution system

systems, which can deliver both heating and cooling at the same time.

Local distribution systems (Fig. 13) are typically electric or gas powered fan or radiant units. If fresh air is required, it must also be brought in locally. This system is best used in facilities which have a relatively high perimeter to floor area ratio. Local systems are commonly found in motels, where each room has an individual heating/cooling system. Computer rooms also commonly utilize local, stand-alone units to maintain a temperature and humidity level which is different from the surrounding spaces.

Hybrid distribution systems combine either central air or water distribution with localized reheat, cooling, and/or ventilation to take advantage of the benefits of each components' specific application.

Delivery systems—the final means of transfer from distribution system to room—also vary, but fall generally into three categories: forced air, convection, and radiation. **Forced air** systems (Fig. 14) literally replace the air in a space with tempered air, and then

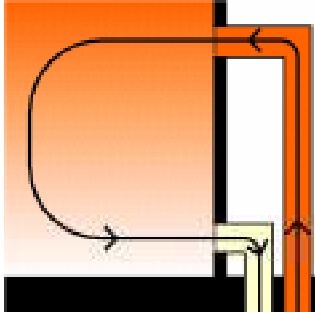

Fig. 14 Forced air heat transfer

Once a system is in place and running, controls must be provided to deal with pollutants and humidity.

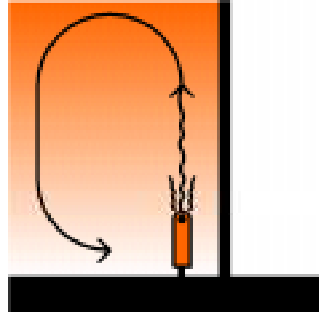

Fig. 15 Convection heat transfer



Fig. 16 Radiant heat transfer

retemper or exhaust displaced air. **Convection** systems (Fig. 15) rely on the natural movement of warm air to heat a space, and are typically located at the perimeter where convection units (or radiators) are placed below windows, to counter conductive transfer. **Radiant** systems (Fig. 16) rely on heat energy radiated by a warm source to condition not the air, but the occupants or objects within a space. Radiant heat, while efficient as a means of delivery, is hampered by the line-of-sight operation of the delivery system. If an object cannot see the source, it cannot feel the heat. Radiant transfer is also ineffective at cooling a space for human occupancy.

Ventilation provides fresh air to replace air contaminated by smoke, grease, pollen, dust, heat, odors, or carbon monoxide.

Humidity control prolongs the life of wood, metal and painted surfaces. Too much moisture may cause condensation on cool surfaces, wood warpage, mildew propagation, rust, musty odors, and peeling wallcoverings. Lack of moisture dries wood, leather and adhesives, causing splitting and separation, and increases **static electricity** transfer from carpets. Too little moisture also causes human discomfort by parching delicate respiratory membranes and aggravating allergies.

Humidity also affects the loss of body heat. High moisture levels in the air slow evaporation of skin moisture, keeping the body warm, while low humidity levels increase skin moisture vaporization, cooling the body. **Relative humidity** is a measure of the percentage of humidity in the air relative to the maximum possible at a given temperature. Relative humidity determines the rate at which evaporation can take place in an environment as well as its net effect on the occupant. A relative humidity range of 20 to 60 percent is within the range of comfort for most people.

In buildings with central HVAC systems, humidity is controlled by two separate mechanisms. Humidifiers add moisture to the air. Cooling coils provide a surface for transfer of heat from the air but also provide a surface for condensation of moisture—dehumidification. Self-contained dehumidifiers are used in spaces where additional dehumidification may be required. In bathrooms, laundries and kitchens exhaust fans are most often used to remove excess humidity generated by use. Natural flow ventilators which simply provide a means for moisture to escape are used in basements, crawl spaces, tunnels, and attics.

Sick Building Syndrome

In recent years, buildings have been designed to retain tempered and conditioned air. As a result, problems with ventilation and the accumulation of air pollutants have increased. These problems lead to lower levels of indoor air quality and cause decreases in perceived levels of comfort for the users of the space. Physical symptoms

*When a building's occupants complain about acute discomfort for an extended period of time and most of their discomfort ends when they leave the building, **Sick Building Syndrome** is suspected.*

may include headaches, fatigue, eye irritation, memory loss, and respiratory irritation. The predominant cause of indoor air contamination is inadequate ventilation. Contaminants from activities taking place in or around the building or inappropriate environmental controls and maintenance may be causes. Off-gassing of building materials, microbial sources within the building, and soil contaminants around a building are a lesser concern due to their infrequent occurrence.

The interior designer must understand the potential problems that arise from the use of specific materials, processes and installations. Some guidelines for dealing with Sick Building Syndrome include the following.

- Increase fresh air supply.
- Ensure that fresh air is free from pollutants from the interior (kitchens) and exterior (exhaust fumes).
- Improve maintenance operations on air distribution equipment—particularly fans, ducts, filters.
- Install plants to condition interior air

Plumbing

A basic knowledge of the workings of a plumbing system is critical to making decisions about the efficient arrangement of such utilities within a facility.

The vertical movement of water through a building is accomplished by **risers**: vertical lines of pipe running through a building, typically located adjacent to groupings of water-using spaces such as restrooms, kitchens, laundry rooms, etc. (Fig. 17). Risers are connected to the branch pipes, which run horizontally to the fixtures. Pipes may be concealed in walls, under floors, above ceilings, or in specially built enclosures or chases.

In most buildings, hot and cold water are supplied by a pressurized system. Branch supply pipes are typically quite small - 19 mm (3/4-inch) or so - making it easy to supply water to new locations.

Drain pipes are dependent upon gravity—not pressure—to move water. As drain pipes must slope downward, they figure more greatly in determining where wet facilities can be located than pressure systems. Drains from lavatories, disposers and sinks need only slope down at a gentle angle; larger soil pipes must slope sharply to discourage sedimentation and clogging. When adding wet facilities during remodeling where new risers are not feasible, these new facilities must be placed close enough to existing risers to achieve the required slope without interfering with spaces below.

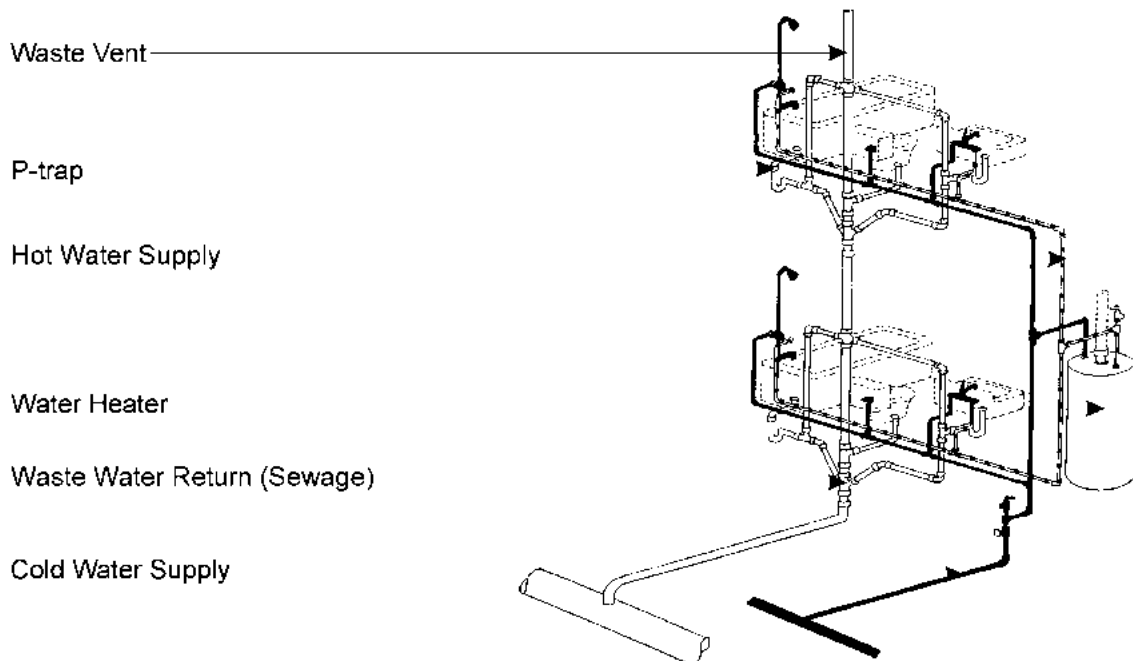

Fig. 17 Plumbing system showing risers, branch pipes, drain pipes, traps, vents

Traps and vents, which prevent gases in drainage pipes from entering living spaces, and allow for free flow of effluence without obstruction by trapped gases, are additional details which add to the complexity of a plumbing system.

When locating new plumbing services, consideration must be given to the feasibility of routing both the supply and return systems and the impact of the installation and repair on adjacent space. Basic design guidelines include locating pipes away from places where a leak might cause danger or damage, and locating

access panels or pipes in closets or other semi-hidden spaces that can be easily identified.

Fire Protection

The most common method of fire protection within buildings is the sprinkler system. **Automatic sprinkler systems** generally consist of two types: wet and dry. **Wet pipe** sprinkler systems contain water in both main and distribution pipes. **Dry pipe** sprinklers are charged with a gas which is released upon activation, after which water flows through the system. Wet pipe systems are the simplest and most common, but pose a threat of damage due to leakage. Dry pipe systems are generally used where the threat of damage due to leakage is considered too great, such as in electrical control and computer rooms. Halon systems, which were once common in computer rooms, are largely being replaced by dry pipe systems. Halon, a chloro-fluorocarbon is harmful to the environment as well as directly hazardous to persons exposed to it upon release. Dry pipe systems reduce the risk of leakage, and additional preactivation controls increase the safety of the system relative to damage from accidental discharge. Preactivation systems require multiple releases, both automatic and manual, prior to release.

Automatic sprinkler systems consist of horizontal distributions of pipes generally located above the ceiling. Sprinkler heads are fused so that open automatically to spray water when temperatures reach 60 to 70° C. Spacing of sprinkler heads depends upon the number of occupants, use of the space, construction of the building, and partition placement.

A sprinkler system is typically fed by a water source that is supplemental to the domestic (drinking water) source within a building to ensure sufficient pressure and supply during a fire. This may be a separate reserve such as tanks or an artificial lake.

Fire hose stations, a frequent supplement to a sprinkler system, are located at or near stairwells to allow fire fighters to approach a fire. **Standpipes** provide a back-up water supply system—an independent water delivery system for access to a supplementary source of water during a fire. Often this water is provided by connection

to a pumper truck or direct connection to an external hydrant.

Electrical

The primary electrical systems seen in facilities today are electrical power supply and data/communications or signal systems. Electrical power supply in the United States is available in a number of configurations, the most common of which are 120/240 volt single-phase three wire, 120/208 volt 3-phase 4-wire, and 277/480 volt 3-phase 4-wire. The first is used primarily for small scale and residential projects, the second for the majority of commercial projects and the last for very large-scale projects which have intensive fluorescent lighting and 480v machinery use. In all cases the service voltage supplied to a typical wall receptacle is 120 volts. The source voltage is used to power permanently-wired equipment and lighting. The criteria used for determining the system selected are the size of the project and the ratio of 120 volt usage to the total. While the higher voltage systems dictate equipment costs which are higher than those of lower voltage systems, this is compensated for through reduced installation and operating costs.

Data and Communications

Many specific electrical and communication systems other than power are used in a building. Although these systems require electricity for operation, they are often of a specialized electrical nature, independent of the primary electrical system. Some, such as emergency lighting and intercoms, are permanently installed, but others, such as telephones and computer data systems, can be easily relocated.

Communications systems may enter a building as an independent, low voltage electrical current, or—in the case of fiber-optic systems—as pulsed light. Specialized telephone wiring or fiber optic cables are routed throughout the structure from primary entrance to regional distribution points, and terminate at telephone receptacles located per specific telephone requirements. Wireless transmission stations may also be employed for use with portable or cellular phones. These systems are

changing rapidly and range from phones which may work on a global basis to those which operate only within a few hundred feet of a single base sending unit. Communications systems handle the transport of voice and data; e.g. telephone conversation, facsimile transmission, video teleconferencing and data transfer.

Alarm systems commonly detect entry, monitor activity, and sense heat or smoke; and sound an alarm or initiate some other action when required. These systems generally operate off a low voltage supply, and require back-up power in the event of a system power failure. Signal transmission is most often handled locally by an independent network, and then relayed to a central watch station over a shared or dedicated telephone line.

Data and Communication Systems

Data and communication systems are constantly changing. The expanding fields of electronics, fiber optics, light-wave technology, low voltage circuitry, and satellite links continually create new modes of communication and data transfer. Increasingly, these are being handled as a networked communication system.

The interior designer faces the responsibility of specifying and designing around these communication systems as they shape interior spaces.

Distribution Systems

Distribution of electrical and electronic systems through a building is generally accomplished through branched distribution. A central chase or trunk will run the length or height of the facility, then horizontal distribution systems run from a central connection closet to the end-user. This distribution may be overhead or underfoot, and in many instances is a combination of the two.



Fig. 18 Overhead distribution

Overhead cables (Fig. 18) installed in the ceiling plenum are the most common means of distribution of electrical systems. Depending upon the specific application, cables may be laid directly over the ceiling membrane (for some telephone systems), or they may need to be run in conduit (as is often the case regarding electrical wiring). They may also be laid in raceways or cable trays specifically designed to ease the maintenance of electronic systems. From the ceiling space,

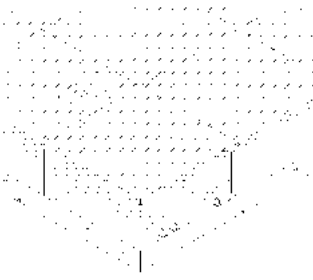

Fig. 19 Raised access flooring

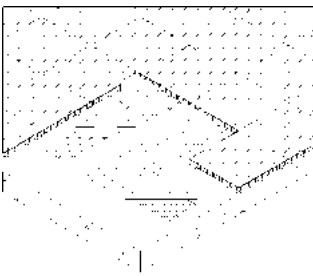

Fig. 20 Flat wire distribution

distribution is made through wall or partition cavities to equipment. The **power pole** is a direct method of distribution from the ceiling plenum by means of vertical poles or flexible conduit located at workstations. While providing unlimited flexibility, pole locations must be coordinated with furniture and partition systems in order to avoid undesirable visual results.

Raised access flooring, (Fig. 19) a system of interconnecting floor panels raised sufficiently above the structural floor, allows for installation of electrical, mechanical, and/or air distribution systems beneath it. Virtually unlimited access flexibility allows for a total integration of distribution systems with furniture. Due to the expense of this system, application is generally limited to areas where ease of access is essential, such as spaces with intensive computer and communication needs. Common uses are computer rooms and training facilities.

Flat wire (Fig. 20) is an electrical distribution system in which continuous flat wire cabling is located directly beneath modular carpeting. Relocation can be completed by maintenance personnel if new power connections are not required. However, significant disadvantages are associated with flat wire cable as well.

- Due to requirements for accessibility, broadloom carpet cannot be used over flat wire. Only polyvinyl chloride (PVC) backed carpet tiles are permitted by building codes.
- Flat wire cable cannot withstand long-term heavy traffic or local concentrated loads such as casters.
- Telephone cable lengths are limited to 35 feet.
- Ripples in carpet tiles may be visible at cable locations.

For these reasons, flat wire electrical distribution systems are typically not used.

In **integral distribution systems**, steel raceways are incorporated into the structural floor. Commonly found in steel framed buildings, ducts are made part of the steel pan that forms the bottom of the structural floor. Junction boxes at key points along the ducts have removable covers to allow full access. Covers are level

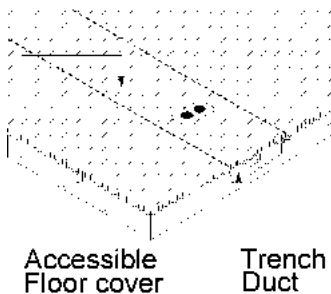

Fig. 21 Trench duct distribution

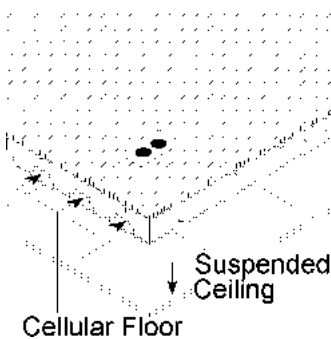

Fig. 22 Cellular floor distribution

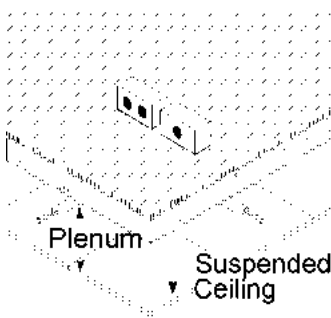

Fig. 23 Poke-through distribution

with the finished floor and can be finished to match. Also called **underfloor duct systems**, common types include trench duct and cellular floor.

Trench duct systems (Fig. 21) utilize ducts which are flush with the surface of a floor slab as raceways. These often serve as feeders for the cells of a cellular steel floor system as well as self-contained raceway systems for computer areas, laboratories and hospital X-ray rooms. The trench duct may have either single or multiple compartments, providing for different services and access along the full length of the system. The pre-established grid system will influence the subsequent furniture layout.

Cellular floor systems (Fig. 22) take advantage of the cavities within corrugated steel decking, using these as the branches of a distribution system. Headers, typically fastened to the surface of the decking but still buried beneath the finish slab, provide the main trunk distribution. The cells are accessed by a grid of regularly spaced access ports.

The purpose of any integral system is to establish a supply grid which allows easy access to power and communication distribution. The grid system provides a matrix of regularly spaced access points at appropriate locations around the floor.

Poke-through systems (Fig. 23) are not considered integral systems and are essentially the same as above ceiling distribution systems. The primary horizontal distribution is made through a ceiling plenum; however, instead of feeding down from the ceiling above, the distribution travels up from the plenum below through penetrations in the floor. Although aesthetically preferable to power poles for connection to free-standing equipment, the system becomes costly because the poke-through connections require alterations to the floor slab and fire separation.

Combined distribution systems often employ poke-through feeds for free-standing elements where visual clarity is valued, in conjunction with overhead distribution for ease of maintenance where feeds may be carried through existing architectural elements such as partitions.

The choice of an electrical distribution system requires consideration of both the initial cost of installing the system as well as the cost of maintaining it. Dynamic systems may warrant the increased initial expense of a flexible installation, whereas stable systems may be satisfied by more permanent configurations.

Lighting

The final quality and quantity of light present in an interior is directly related to the process which has guided the interior designer. In order to successfully plan for the lighting of a space, the designer must possess an understanding of the principles and processes of visual perception, comfort and the nature of human need for visual information (see Chapter 3).

When designing with light, emphasis is placed on focal elements and drawn away from those of lesser interest. The nature of the patterns of light sources and their relationships to other elements in the visual field largely determines the overall quality of the luminous environment. The distribution and characteristics of the illumination, the information conveyed by the pattern of the light sources and the degree to which they reinforce or contradict the relationships to the architecture, and the planned activities also affect the overall quality of light in an environment. At the same time, one-quarter to one-third of the energy consumption of a building is in lighting. Lighting design, therefore, must be a study of both art and technology.

Lamp Types

Through continued research and technological advancements, thousands of lamp types are available to serve a great spectrum of users. General application lamps are currently classified into three basic categories: incandescent, fluorescent and high intensity discharge. Each category has its own unique operating characteristics, special considerations, and applications. Figure 28 provides a summary of the lamp types as discussed below.

Incandescent

Incandescent sources come in a variety of forms and shapes (Fig. 24). Their versatility is enhanced by their availability in a wide range of wattages. Incandescent light emanates from a relatively small source; because some lamps themselves are quite small, their light distribution can be controlled easily. Incandescents are easy to install, are not adversely affected by frequent switching, and can be easily dimmed.

General service lamps—A, S, P, PS, and T—are most suitable for lighting public spaces and are used in table

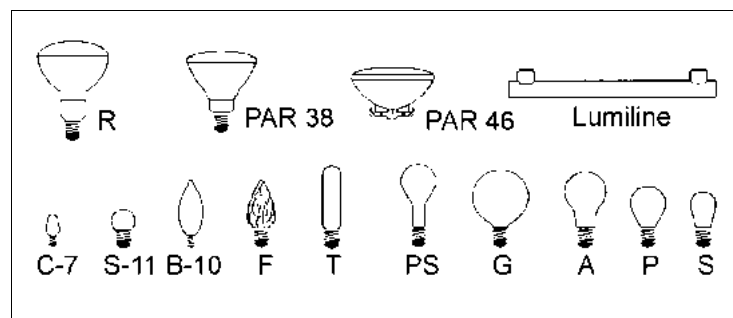

Fig. 24 Standard incandescent lamp types

lamps and many fixtures with reflectors. The S and P lamp types have a shorter neck than the standard A lamp, which makes them better for use in smaller sources. The PS lamps, having a slightly longer neck, are sometimes used in downlighting fixtures. T lamps are used for reflective lighting, often in display case lighting.

Decorative lamps —F, G, C, and B—radiate light in all directions. They are used in decorative applications such as chandeliers, sconces, lamp posts, and vanities.

Reflector lamps—R, ER, and PAR—are designed with built-in reflectors. They are constructed to cause light to be emitted in a particular direction and specific beam spread. R lamps are designed for indoor application only. Their reflectors are not very precise and can only be made in flood or spot beams. R lamps are best used in recessed downlights or track applications that do not require precise beam control. The ER lamp, a modification of the R lamp, has an ellipsoidal reflector. Its unique shape concentrates the light beam into a small area in front of the lamp and spreads the light into a wider beam, improving efficiency. PAR lamps have a parabolic shaped design which yields better control of

the beam. They offer the opportunity to develop a number of lens patterns, thus increasing the variety of beam spreads. They are most effective in indoor track and accent lighting.

Tungsten-halogen lamps (Fig. 25) are more energy efficient than standard incandescent lamps. For the same amount of electricity, they generate up to 30 percent more lumens per light, up to 22 lumens per watt. Also, because tungsten-halogen bulbs blacken much less than standard incandescents, they stay almost continuously bright as they age. The brilliant light and small size

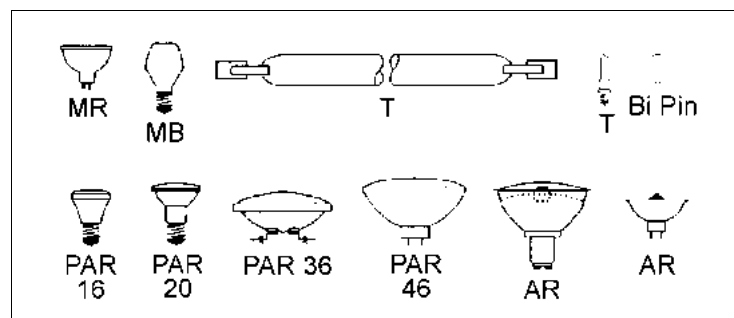

Fig. 25 Standard tungsten halogen lamp types

makes halogens ideal for activity and accent lighting. The typical life ranges from 2,000 to 4,000 hours with wattage ranges of 5 to 300 watts. Other benefits include brilliant, intensely focused light and ease of use with dimmers for energy savings.

PAR 36's, MR 16's and MR 11's are all **low voltage lamps**. The low voltage lamp, running on only 12 volts of electricity instead of the household standard of 120 volts, requires a transformer for operation. A smaller lamp than most, with a very small filament, these low voltage lamps allow the light to be precisely focused by a reflector or other optical system. The precise beams of light are ideal for lighting small objects or where a long throw of light is necessary. Low voltage lamps are available in both tungsten-halogen and general incandescent. Some contain their own integral reflectors while others are designed to be placed in a luminaire to properly focus the light output.

Much of the energy consumed by incandescent lighting produces heat as a by-product of light. This lost energy makes incandescent lighting one of the least efficient light sources. In addition, the heat produced increases

the air-conditioning load of the building, requiring additional energy to be spent on cooling. Incandescent lighting, therefore, is most often used for residential lighting or the aesthetic display of merchandise.

Fluorescent

Fluorescent lamps are low-pressure discharge light sources. The typical fluorescent lamp is comprised of a cylindrical glass tube, sealed at both ends, which contains a mixture of an inert gas and low-pressure mercury vapor. Cathodes at the tube's ends emit a stream of electrons, activating the phosphor coating on the

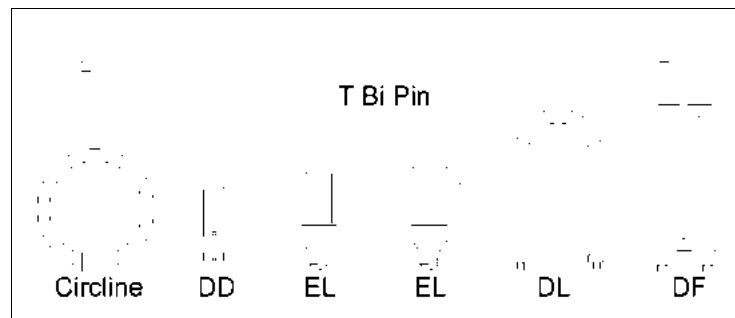

Fig. 26 Fluorescent lamp types

inside of the tube, thus producing light. Fluorescent lamps have a long life, typically lasting 10 to 15 times longer than incandescent lamps, while producing about four times as much light per watt (60 to 80 lumens per watt). They come in a wide variety of size, wattage and color choices (Fig. 26).

Straight-linear fluorescent "T" lamps are the most common, available in over one hundred configurations ranging in length from 75-2440 mm (3 to 96 inches) and wattage from 4 to 75. Other shapes include the **U-shaped** and **circle-shaped** lamps, developed in response to a desire to minimize fixture size.

Compact fluorescent lamps have been developed to fit into the space of the conventional 25 to 100 watt incandescent lamp. These fluorescents provide longer life and high energy savings, as much as 82 percent over incandescents, while approaching the preferred color of incandescent light. Now they include sizes and colors to replace conventional fluorescent lamps in reduced size luminaires as well. Compact fluorescent lamps are available in a number of formats for dedicated

fluorescent fixtures (DD, DL, DF); as well as for retrofitting standard incandescent fixtures (globe, EL), with screw-in bulbs and globes. Although the lamps cannot be dimmed, their life—9 to 13 times longer than comparable incandescent lamps—will be maximized if used in locations where the light remains on for long periods of time.

While fluorescent lamps have a longer life, produce more light and save more energy than incandescent lamps do, some disadvantages to their use exist. They can produce a flat, diffuse light which may appear monotonous and tiring. Also, large tube sizes limit optical control. A disadvantage with compact fluorescent appears in the mounting positions: some compact lamps require specific mounting positions (e.g. vertical-base up).

High Intensity Discharge (HID)

Whereas fluorescent lamps rely on the interaction between an energized gas and the reactant coating on the inside of the lamp, HID lamps produce light through the direct excitement of a pressurized gas (Fig. 27). HID sources tend to be extremely efficient and long-lived, but typically have long start-up times and operate with poor color rendition and consistency.

Mercury vapor lamps were the first HID source developed but are used less frequently than other HID sources. They produce light by passing an electron stream through a gas vapor. Advantages of **mercury vapor lamps** include excellent maintained light output, high light output in relation to energy use, low cost, and

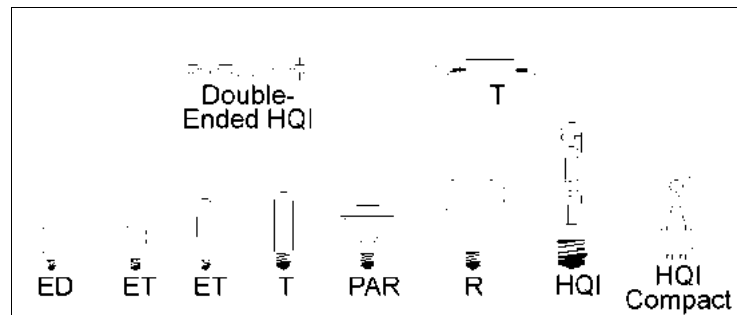

Fig. 27 Standard HID lamp types

exceptionally long life. Warm-up time before full brightness, time to cool down before restarting if power

is interrupted and high heat output are a few disadvantages. Exterior landscape lighting makes the best use of mercury vapor lamps as the color rendition emphasizes the greens of landscape. Due to limited color rendering and mercury content, mercury vapor lamps are seldom used any longer.

LAMP TYPE	Incandescent		Fluorescent	HID
	120 volt Tungsten	12 volt Halogen		
Initial Cost	Low	High	Moderate	Very High
Efficiency	5 - 20 Lumens per Watt	10-20 Lumens per Watt	60-90 Lumens per Watt	40-80 Lumens per Watt
Operating Cost	High	Moderate	Low	Very Low
Life Cycle Cost	High	Moderate	Low	Moderate
Life	1000 - 2000 Hrs	2000 - 4000 Hrs	8000 - 10,000 Hrs	6000 - 30,000 Hrs
Lumen Maintenance	Low	High	High	High
Flexibility of Application	Very High	High	Limited	Limited
Color	Good	Superior	Varied	Poor
Color Rendering Index	100	100	70-85	30-75
Auxiliary Circuiting Requirements	None	Minimal	Moderate	Moderate
Dimming Abilities	Yes	Yes	Limited	No
Start up & Restrike	None	None	0 - 15 Seconds	0 - 10 Minutes
Heat Output	High	Very High	Limited	Moderate
Glare Potential	Yes	High	Limited	Yes
Circuiting	120v	12/120v	120/277v	120/277/480v
Recommended Application	Accent Task	Accent Task	Accent Task Ambient	Ambient

Fig. 28 Lamp Type Attributes

Metal halide lamps work in much the same way as mercury vapor lamps. The primary difference is the addition of metal halides to the mercury or argon in the metal halide arc tube. Metal halides have superior efficiencies, high light, better color rendering, and precise beam control (due to their small size). Disadvantages to

these lamps include shorter life, lower lumen maintenance (light output decreases faster), and certain restrictions on the positions in which the lamps may be burned. If operated improperly metal halide lamps may explode, thus they require fixtures with protective lenses. These lamps work well in offices, retail spaces and public interiors.

High Pressure Sodium (HPS) lamps are the newest addition to the HID field. The lamps have efficacies of 60 to 140 lumens per watt and rated lives of 10,000 to 24,000 hours. Unlike metal halide lamps, they are not as sensitive to burning position. While normally the light source has a yellow-orange glow, recent improvements have resulted in a white color-rendering property. Unfortunately, improvement of color rendering results in lower lamp life and efficacy. Due to its thin, linear shape, the HPS provides excellent optical control. The two distinct disadvantages are shorter life compared to other HID sources and severely distorted salmon-appearing color output among non-color-corrected lamps. HPS lamps have generally been used for street lamps, but even then have limited application.

Lamps and their Effect on Color

In selecting a lamp for a particular space, two primary criteria must be considered. The **Correlated Color Temperature (CCT)** describes the color of the light given off by the lamp, while the **Color Rendering Index (CRI)** describes the effect that the light source has on the apparent color of an object.

Color temperature is measured in degrees Kelvin (K), ranging from 9,000K to 1,500K (Fig. 29). The greater the number, the cooler the lamp color; the smaller the number, the warmer the lamp color. Most light sources fall in the middle range, leaning either toward cool or warm. Generally, a lamp source should be selected to suit the color scheme of the space: warm range lights for warm color schemes and cool range lights for cool color schemes. Predominantly neutral or gray color schemes can be lit with either to accentuate or draw the scheme one way or another, or may employ a more neutral, mid-range light.

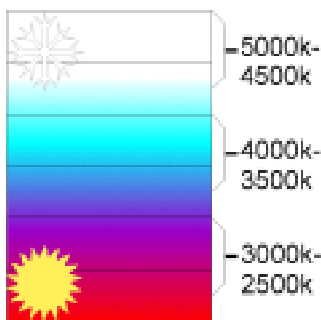

Fig. 29 Common correlated color temperature ranges

The second consideration when selecting a light source is the CRI. Color rendering is measured on a scale of 0

to 100 (Fig. 30). A CRI of 100 indicates no color shift in the object when compared to a reference source. The lower the CRI the more pronounced the color shift will be. CRI values are only taken into consideration once a color temperature range has been determined; however, the temperature effect cannot be discounted when assessing CRI.

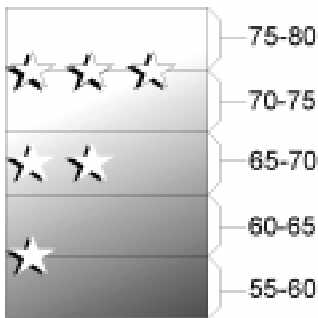

Fig. 30 Color rendering index

Incandescent sources radiate energy throughout the visible spectrum but with a greater proportion in the yellow-red range. A standard incandescent lamp has a color temperature of 2,700 K and appears yellow-white. When the incandescent lamp is dimmed, the color of the light shifts to the red end of the spectrum, making reds appear more saturated while greens and blues become grayed. A **tungsten-halogen lamp** may have a color temperature in the range of 3,000 to 3,200K and appear brilliant white. These lamps render all colors very close to their actual hue.

Fluorescent lamps are available in many different “whites”, each with a different color temperature. Their color relates directly to the type of phosphor used to coat the inside wall of the tube. Red, green and blue phosphors are blended to achieve the desired shade of white. Thus, color rendering capabilities vary among fluorescent sources.

High intensity discharge sources produce light in a rather narrow range of the spectrum. Mercury lamps produce a bluish-white light. Because of the strong blue, green, and yellow rendition of the mercury, objects of these colors are enhanced under this source, while red and orange objects appear brown. The addition of phosphors activates energy in the red portion of the visible spectrum and enhances the overall color of light by improving the color rendition of red and orange objects. Metal halide lamps already produce a better color rendition than mercury lamps, emphasizing the colors that tend to create a cool visual atmosphere: hues of blue-purple through blue-green to yellow-green. High pressure sodium lamps produce a yellow-orange light that, while intensifying yellow-orange objects, distorts other colored objects.

Designing with Light

Designers define, articulate, or manipulate a space using various forms of light. Common terminology employed

- *Types of lighting*

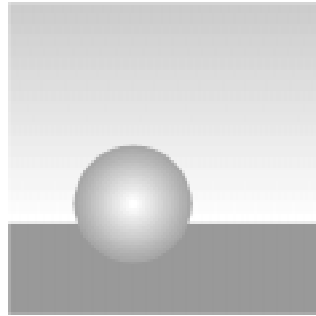

Fig. 31 Ambient light

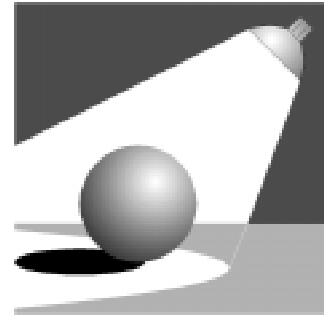

Fig. 32 Task light

in the discussion of lighting follows.

Ambient (Fig. 31) lighting involves a uniform light with no apparent single source. It provides a low level of overall diffuse lighting adequate for circulation needs and for preventing areas of darkness.

Task (Fig. 32) lighting is a focused light utilized for a specific task. This approach to lighting is based upon illuminating a task in an appropriate manner while balancing the illumination of surrounding areas (ambient light).

The major advantages of task lighting include:

- highly controllable and user-friendly sources,
- energy savings possible through lower overall ambient light level,
- wide range of sources and models,
- highly portable and adjustable, and
- can be used to create high local light levels where necessary.

The major disadvantages of task lighting include:

- expense in terms of capital investment,
- requirement for multiple power outlets,
- wide assortment of models can lead to problems with aesthetics, coherence, and maintenance,
- desk versions can be space consuming,
- poor adjustment can lead to glare for colleagues, and

- undershelf models may produce glare for user.

Direct (Fig. 33) light refers to light which has traveled in a straight line from its source. This type of light creates highlights and shadows which emphasize texture, identity and aesthetics of mass and form. Spaces can be made to look smaller or more intimate by the use of direct shielded luminaires recessed in ceilings or surface mounted on walls or ceilings. Other visual effects achieved with direct light include high contrast, vibrant color, and glitter.

Indirect (Fig. 34) light, sometimes referred to as a

Methods of distributing light from an artificial source

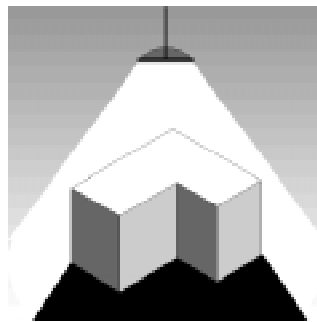

Fig. 33 Direct Light

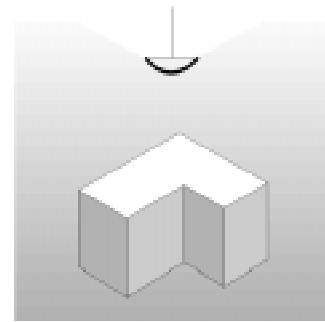

Fig. 34 Indirect Light

diffuse or “soft” light, tends to minimize shadows and contributes to a more relaxing and less visually dynamic environment. Indirect light is reflected off a single surface or multiple surfaces to diffuse the light and make it appear more uniform in nature. When used alone, the result can be very monotonous and uninteresting.

Brightness, duration, size, and contrast are important factors when determining the appropriate amount of light for an environment. Specific recommended illuminance categories have been prepared by the Illuminating Engineering Society of North America (IESNA) and may be found in their *Lighting Handbook, Reference Application*, an excerpt from which is shown in Figure 35.

Lighting "Rules of Thumb"

In the design of lighting for various spaces, some general guidelines should be considered.

- To see the detail of an object, contrast between the object and its background is necessary.

- Luminance of surfaces in the area surrounding an object can adversely affect a person's ability to see surface detail of the object.

Type of Activity	Illuminance Category	Range of Illumination in Lux	Reference Work-Plane
Public Spaces with Dark Surroundings	A	20-50	General Lighting Throughout Spaces
Simple Orientation for Short Temporary Visits	B	50-100	General Lighting Throughout Spaces
Working Spaces Where Visual Tasks are Only Occasionally Performed	C	100-200	General Lighting Throughout Spaces
Performance of Visual Tasks of High Contrast or Large Size	D	200-500	Illuminance on Task
Performance of Visual Tasks of Medium Contrast or Small Size	E	500-1000	Illuminance on Task
Performance of Visual Tasks of Low Contrast or Very Small Size	F	1000-2000	Illuminance on Task
Performance of Visual Tasks of Low Contrast or Very Small Size over a Prolonged Period of Time	G	2000-5000	Illuminance on Task Obtained by Combination of General and Supplementary Lighting
Performance of Very Prolonged and Exacting Visual Tasks	H	5000-10,000	Illuminance on Task Obtained by Combination of General and Supplementary Lighting
Performance of Very Special Visual Tasks of Extremely Low Contrast and Small Size	I	10,000-20,000	Illuminance on Task Obtained by Combination of General and Supplementary Lighting

Fig. 35 Illuminance categories and values for generic interior activities

- When a space is to be illuminated directly, the lighting should emphasize the prominent characteristics—module, shape and material—in a consistent and complimentary fashion.
- To conform with expectations, use light sources of relatively low color temperature at low levels of illumination, and sources of higher color temperature at higher levels of illumination.
- In general, illuminate continuous elements such as walls evenly or with even gradients so they appear continuous.

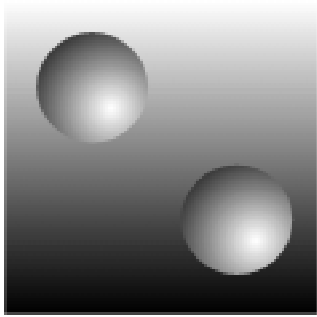

Fig. 36 Simultaneous contrast

- Because of adaptation and time orientation, the same amount of artificial lighting in interior spaces will appear much brighter at night than during the day.
- Because of simultaneous contrast and adaptation, objects with identical levels of illumination appear brighter when seen against a darker background (Fig. 36).
- When illumination levels must be low, emphasize potentially dangerous edges in circulation paths by changes in material, the use of color, or definitive shadows.
- Grazing lighting (lighting at a shallow angle of incidence) always highlights irregularities in the surface upon which it falls.

Design Checklist

<p style="text-align: center;">Architectural Systems and Components</p> <p>How do they affect the way the space is defined?</p>	<p>Construction</p> <ul style="list-style-type: none"> Walls Interior Perimeter Ceilings Floors <p>Acoustical Concerns</p> <ul style="list-style-type: none"> Privacy Communication Isolation
<p>Structural Systems and Components</p> <p>How do they affect architectural definition, utility, and mechanical and electrical systems distribution?</p>	<p>Location of Bearing Walls, Structural Members</p> <ul style="list-style-type: none"> Depth of Ceiling Structure Type of Floor Construction How does it affect allowable loads/acceptable uses How does it affect location of penetrations for systems distribution
<p style="text-align: center;">Mechanical Systems and Components</p> <p>How do they affect architectural definition, and utility?</p>	<p>HVAC System</p> <ul style="list-style-type: none"> Type of System Spatial Requirements for Distribution Vertical Horizontal Ventilation Requirements Humidity Control Requirements <p>Plumbing</p> <ul style="list-style-type: none"> Spatial Requirements for Distribution Chase Dimensions Location of Chases to Ensure Adequate Slope
<p>Electrical Systems and Components</p> <p>How do they affect architectural definition? How are they limited by architecture and structure?</p>	<p>Primary Distribution System</p> <ul style="list-style-type: none"> Power Requirements Data and Communications Requirements <p>Auxiliary Systems</p> <ul style="list-style-type: none"> Lighting Lamp Type Lighting Method Spatial Requirements



Materials



Primary Interior Finish Materials	6.1
• Concrete	6.1
• Masonry	6.1
• Stone	6.2
• Metals	6.2
• Wood	6.3
• Plastic	6.7
• Glass	6.8
• Wall Board	6.9
• Tile	6.10
• Terrazzo	6.10
• Acoustic Ceiling systems	6.11
• Resilient Flooring	6.11
• Carpet	6.12
• Paint and Other Film-Applied Finishes	6.21
• Wallcovering	6.24
• Fabric and Textiles	6.25
Application Guidelines	6.31

Materials

This chapter discusses primary interior finish materials—their make-up, application, maintenance, appropriate uses, and consequences of selection. It begins with a discussion of common finish materials and ends with application guidelines for each.

Primary Interior Finish Materials

The following descriptions address only the most common of finish materials and cannot address all pertinent details. For more detailed information, consult general reference texts, or contact specific manufacturers.

Concrete

Concrete is a cast or poured material composed of an aggregate, typically sand or gravel, and a binder, typically cement. Concrete is extremely hard and resistant to weathering. It is most often used in areas requiring very high utility, or areas where a continuity between the exterior and interior environment is desired. Concrete is typically used in the architectural and structural definition of a space, rather than strictly as a finish material, but can be used for most any application from floors to walls to furnishings.

Masonry

Masonry, a broad material category, consists primarily of earthen building units including concrete block, clay tile, brick, and stone. Masonry walls are typically used where safety, security or durability is a primary concern or where a particular aesthetic is desired. They may also be used in solar heating applications where mass is needed for solar heat storage. Masonry walls are heavy and not easily modified. Their weight is clearly a limiting factor in some applications. They take longer to construct than a typical gypsum board partition and their cost is a premium.

Stone

Stone is a valued construction material because of its aesthetic appearance, durability and relative ease of maintenance. All three families of stone—igneous, sedimentary and metamorphic—are used in the construction trade.

Igneous stones are produced under intense heat and include **granites**. They are dense, hard and durable; may be fine or course-grained; and are found in shades of green, pink, yellow, white, and black. They may be finished in numerous ways: polished, honed, flamed, or hammered. Granite is used for wall cladding, tabletops, flooring, and other applications that require considerable resistance to wear and staining. Granite, however, is susceptible to heat and spalls when exposed to fire and so cannot be used in interior structural applications.

Sedimentary stones, such as slate and limestone, are formed by sediment deposits in the earth. These stones tend to be soft and are easily cleft and hammered. They have a limited finish availability and do not polish well or retain detail when worked. Sedimentary stones are not as durable as igneous stones. Slate ranges in color from blue to orange, is brittle, and easily splits into sheets. It is used mostly for tabletops, flooring and roofing.

Metamorphic stones such as marble, result from the crystallization of limestone. They are relatively hard, but have a venal structure which is prone to fracture. They tend to be translucent, are available in many colors, and may be polished into shiny, smooth surfaces, or honed to a matte finish. Metamorphic stones are porous and will absorb oils; therefore they must be sealed for most uses. **Marble** is used for decorative wall panels, tabletops, fireplaces, countertops, and flooring.

Metals

Metals are extremely durable materials easily formed through a number of processes. They may be drawn into wire, rolled into sheets, cast, or stamped into many useful and decorative objects. They vary in reactivity to water, oils and chemicals. Stainless steel and chrome resist most reactants encountered in interior environments quite well; therefore, wet rooms and clean

rooms commonly utilize these metals. Brass and bronze are generally given a protective coat to prevent their natural oxidation due to exposure. Finish techniques for metals include hammering, brushing, polishing, and etching. Metals can be used in ceilings and countertops as well as walls and other vertical surfaces.

Wood

Wood has been used for centuries as the primary construction material for buildings and furniture. It is a renewable material and is easy to work. Lumber quality varies, relating directly to the method of sawing, seasoning and surfacing.

Most lumber intended for use in the framing of buildings is **plain sawn**, a method of dividing the log that produces the maximum yield and the greatest economy (Fig. 1). The varying grain orientation of plain sawn lumber causes the pieces to distort during seasoning, and to have very different surface appearances from one piece to the next. Occasionally these variations may cause problems, especially for interior trim, finish flooring, and furniture. For these purposes, wood is typically **quarter sawn** (Fig. 7) to produce lumber with a more consistent vertical grain orientation and a tighter, more pleasing figure. These boards also tend to remain flat despite changes in moisture content and have an improved wearing quality.

Seasoning, either natural or kiln-processed, reduces the moisture content of lumber to a specified level appropriate for the application; for example, 19 percent or less for framing. This process is critical to the strength, dimensional stability, stiffness, and weight of the material. **Surfacing** makes a board smooth and dimensionally precise. Surfaced lumber is easier to work with because it is more square and uniform in dimension and less damaging to the hand. **Grading** of lumber is performed either for appearance or structural strength and stiffness, depending upon its intended use.

Softwoods, such as pine, redwood, and cedar, come from coniferous trees and have a relatively simple microstructure, consisting mainly of large longitudinal cells. Softwood lumber generally has a coarse and relatively uninteresting grain structure. **Hardwoods** such

as cherry, mahogany and oak, come from broadleaf trees and are more complex in structure than softwoods. They have smaller diameter fibers and larger diameter pores. For fine furniture, interior finish details and finish flooring, hardwoods are most often used. Most lumber used for building framing comes from softwoods which are comparatively plentiful and inexpensive. Other uses for softwoods are paneling, moldings, window and door frames, finish flooring, shingles, siding, and outdoor structures where decay resistance is required.

Solid wood lumber is available as either nominal or dimensional material. **Nominal** sizes are generally used to refer to lumber used for rough construction and framing. A 2x4 has a nominal dimension of 2"x4" but measures less. **Dimensional** sizes are specified for finish work where the wood is required to be a specific or minimum dimension. Solid wood lumber is unpredictable in terms of appearance and behavior: it depends largely on the natural growth of the source tree. It is susceptible to seasonal movement due to swelling and shrinking of the wood cells with humidity in the air. A primary advantage to solid wood however, is that it is homogeneous and may be thoroughly sanded in refinishing.

Wood Interiors Products

Laminated wood products—in which several layers of wood are glued together—are available for structural or finish work when solid wood lumber is neither available nor appropriate. Laminated beams allow the use of structural wood members which would not be possible or economical in solid wood. Plywood, formed of sheets of wood laminated with grain run in perpendicular directions, allows larger panel sizes and reduces distortion and warping by setting the wood structure in balance against itself. Lamination also allows a combination of woods to be used to derive maximum benefit from the characteristics of each of the component pieces. Laminated wood may be superior to solid in terms of stability and size availability, but is more limited in terms of wear due to the thinner finish face thickness.

Veneers are thin sheets or leaves of wood produced by slicing a log, usually to maximize the utility of a piece of fine wood. Veneer-faced lumber products have

essentially the same characteristics as their lumber core. They can, however, be produced very economically through a higher degree of mechanization and material usage.

Four primary veneer cuts exist: plain (or flat) sliced, rotary, quarter sawn, and rift cut. These four cuts vary significantly in their display of the wood grain and their economy of production. **Plain slicing**, the most common cut (Fig. 1 and Fig. 2), is done parallel to a line through the center of the log. A cathedral display characterizes its grain, with marked progression in graining among the

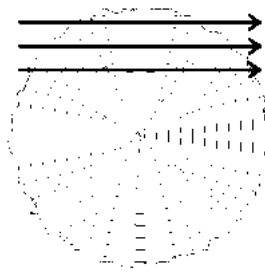

Fig. 1 Plain sawing or slicing

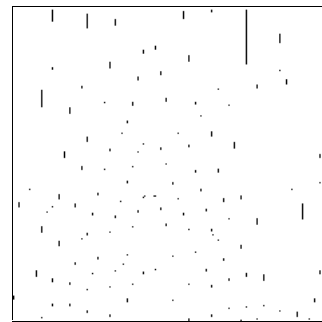

Fig. 2 Plain sliced veneer

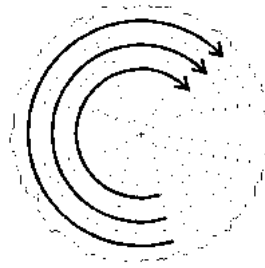

Fig. 3 Rotary slicing

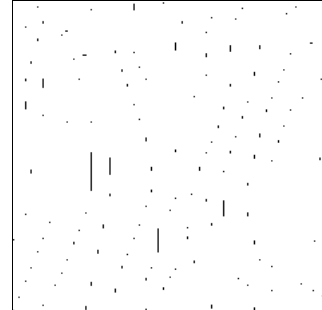

Fig. 4 Rotary sliced veneer

leaves as they approach and then depart the center of the log. **Rotary cut**, peeling the log about its core, is the most economical cut of veneer but yields a very irregular grain pattern (Fig. 3 and Fig. 4). This cut is used primarily for structural (commodity grade plywood) and paint grade veneers.

Quarter sawn veneers are one of the two premium class veneers as veneer leaves tend to be small and the loss of log considerable (Fig. 5 and Fig. 6). By cutting the log into quarters and then slicing, a narrow striped grain pattern is revealed, and the cross-growth structure of the

wood is accentuated, resulting in a display of the medullary rays in wood species such as oak. (It is these

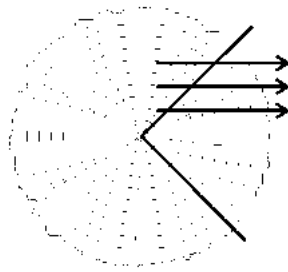

Fig. 5 Quarter sawing or slicing

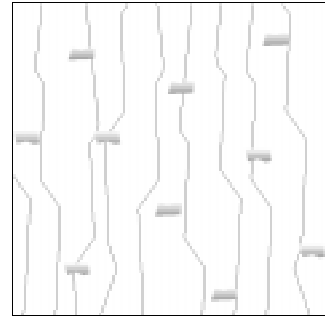

Fig. 6 Quarter sliced veneer

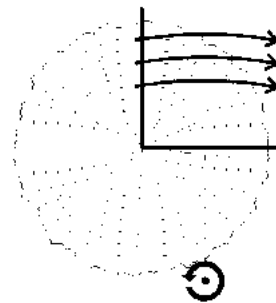

Fig. 7 Rift slicing

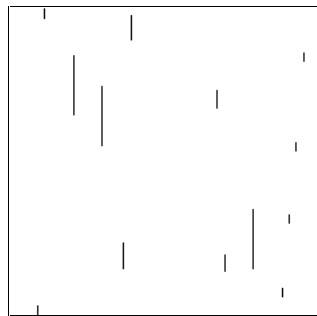

Fig. 8 Rift sliced veneer

medullary rays which give Mission oak its characteristic grain pattern.) **Rift cut** veneers produce the most controlled grain patterns, with narrow striped graining and reduced display of the medullary rays (Fig. 7 and Fig. 8).

Matching of wood veneers is performed with the ordered leaves taken from a single or multiple logs. As leaves are cut from a log, they are held in sequence for later assembly into veneer sheets. In **book matching** every other veneer leaf is turned over, resulting in the greatest

Veneer Matches

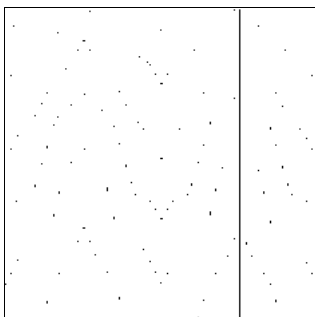

Fig. 9 Book match

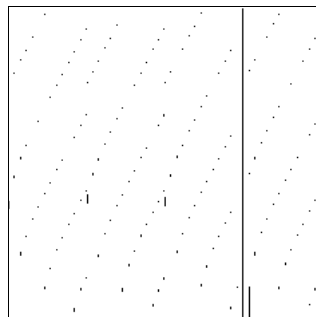

Fig. 10 Slip match

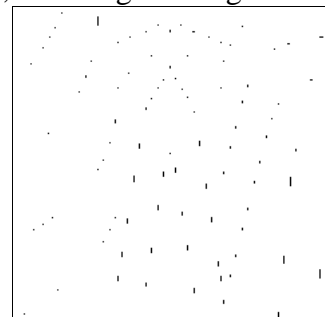

Fig. 11 Random match

continuity of grain pattern as the log is essentially unfolded (Fig. 9). This type of match is most common

for plain sliced leaves where considerable breadth of pattern occurs. The fact that alternate interior and exterior faces of the veneer are displayed results in an additional, subtle variation as the direction of the pores in the grain alternates up and down from leaf to leaf. This may be aggravated through improper finishing, and may cause a color shift as the reflective surface of the wood changes.

Slip matching fans the leaves of a log as one might fan a deck of cards (Fig. 10). This provides a strong continuity of grain and color match, but results in a very directional pattern. This match is best used with rift and quarter sawn veneers where the grain is controlled during the cutting process. **Random matching** means just that: the veneer leaves are placed randomly, purposefully placing the veneers out of order (Fig. 11). This is sometimes done for aesthetic effect, but most often is simply an economical means of mixing leaves from multiple source logs.

Industrial composite boards, such as **medium density fiberboard**, **wafer board** or **oriented strand board**, are **engineered wood products** developed to take advantage of very specific characteristics of wood. They are often made from commodity woods - fast growing trees with little aesthetic character or utility due to their small size, but which, as raw material, provide an excellent source of product. Industrial composite boards are typically engineered with a particular use in mind, and their application must be consistent with that intended use. They vary in stability, resistance to moisture and workability - some are intended as finish materials while most are only used as substrates.

Plastic

Plastics exist in many forms, including rigid sheets of solid plastic, plastic laminate veneers over hardboard panels, or thin and flexible wall vinyls. These materials come in a wide range of colors and surface finishes and are durable and generally easy to clean. However, some may be damaged by abrasive cleaners, and once damaged may be difficult to restore to their original finish.

Plastic Laminate

Plastics may be used as an alternative to glass where impact is a concern. Solid plastics for countertops, transaction surfaces, and toilet partitions offer workability and repairability. Thin plastic veneers provide an economical protective wall treatment.

Plastic laminates traditionally consist of a decorative paper face sandwiched between a phenolic backing and a melamine face. Recent product developments have led to solid-color laminates composed of multiple layers of colored paper imbedded with melamine so that the color continues through the thickness of the laminate. Plastic laminates are used extensively for cabinets, countertops and tabletops.

Plastic laminate grades are as follows.

- GP 50, General purpose used for horizontal applications; offers sturdiness and good wear resistance and can be cold formed in simple bends to radii of 6 to 8 inches.
- GP 28, General purpose, a thinner material produced for vertical surfaces exposed to less wear.
- PF 42, Post-forming can be bent at elevated temperatures to small radiuses and has a permanent memory for the formed position.
- CL 20, Cabinet liner for vertical decorative surfaces that receive little wear, such as insides of cabinets.
- BK 20, Backer used in the fabrication of plastic laminate-clad surfaces to prevent warping and to protect against dimensional instability of both the laminate and substrate.

Glass

Glass has myriad uses as partitions, tabletops and windows. Available in a wide range of thicknesses, glass may be laminated where additional strength or thickness is required. Standard utility glass is annealed. In many interior applications - particularly where the glass is susceptible to impact or required to be part of a fire-rated enclosure - safety glass is required. Safety glass is available in three common manufactures: laminated, tempered and wire glass.

Laminated safety glass is composed of two or more sheets of glass with plastic interleaves, bonded together through heat and pressure. When broken, the plastic holds the fragments of glass together to help reduce injury. It is important to note that not all laminated glass is safety glass; a number of manufacturers produce decorative laminated glass. **Tempered glass** is heated and then cooled rapidly to alter the molecular structure of the glass. When broken, tempered glass shatters into tiny rectangular fragments, reducing risk of harm from the broken glass. **Wire glass**, like laminated glass, has an independent structure introduced into the glass to maintain its integrity in case of damage; in this case a wire mesh imbedded into the molten glass during forming. Wire glass is commonly used only in fire-rated enclosures where this integrity is paramount. However, its appearance is often objectionable.

Glass may be used for decorative purposes as well. By etching or sandblasting the surface, or using patterned or colored glass, different optical effects can be achieved. Decorative laminated glasses offer almost limitless options for altering the appearance of glass to achieve different colors or patterns. Many types of glass have limited applications: art or stained glass, electronic (LCD) privacy glass, polarized glass, fire resistive (salt-filled) glass, and bullet resistive glass. These specialty glass types need to be researched independently for their specific uses.

Wall Board

Wall board is perhaps the most common of all contemporary building materials. Essentially a wafer of gypsum (a powdery white mineral) sandwiched between two layers of paper, gypsum wall board is a mass-produced replacement for plaster and lath. When the appropriate grade of wall board and finish are used together, this product has extremely broad applications. It is generally secure, easily maintained and provides a level of fire and moisture protection.

The different grades of wall board include:

- standard grade for general application,
- fire resistive for use in fire resistive construction,
- water resistant for use in damp locations, and

- cementitious for use in wet locations (such as shower enclosures or as tile underlayment in kitchens, etc.).

Tile

Tile may be used as a wall or floor finish for both interior and exterior applications. It is very durable, easily maintained and attractive. Tiles are available to coordinate in color, style, texture, and thickness with other floor coverings.

Ceramic tile is made of clay that is shaped and fused by firing in a kiln. They generally come in tiles 300 mm (12 inches) square or smaller, and can be easily installed with mastic over any rigid substrate. Because of its hard surface, glazed ceramic tile can be easily cleaned and is quite resistant to stains, making it appropriate for wet areas such as bathrooms, kitchens and laboratories.

Porcelain tile is a dense, fine grained, smooth, homogeneously colored ceramic tile. It resists chipping and provides superior stain and slip resistance.

Quarry tile is typically a thicker tile with a rougher character than either ceramic or porcelain. It is impervious to water, grease and most liquids, and wears well. Quarry tile is often used on floors that are subject to a great deal of abrasion.

Terrazzo

Terrazzo, similar to concrete, consists of an aggregate bound in a matrix, but is not a structural material. It is usually applied over concrete and divided by zinc, brass, or plastic comes into workable areas and patterns. The aggregate may be any hard material such as marble, rock or glass while the binders are typically cementitious or epoxy-based. Terrazzo is a designed surface composed of aggregate and matrix chosen for their color, texture and translucence. A polished finish is the most common; however, it may be left unpolished. Terrazzo is most frequently used for floor finishes requiring a high level of durability and low maintenance.

Acoustic Ceilings Systems

Suspended **acoustic ceiling systems** refer to acoustic panels or tiles suspended by an exposed or concealed ceiling grid. The tiles themselves can be made of fiberglass, mineral fiber, wood, or metal. They range from smooth, washable surfaces to deep-fissured or textural patterns. They come in a wide range of patterns, colors, and acoustic values—most between 0.50 and 0.70 NRC. The quality of the acoustic value directly relates to the composition, face texture, and manufacture of the tile. Fiberglass tiles absorb almost all of the sound that strikes them but are generally not very durable. Mineral fiber tiles are more durable and absorb less sound overall than fiberglass, but they prove very effective at absorbing sound that strikes at a 90 degree angle. As the angle of incidence increases however, the sound absorption decreases.

Acoustic ceiling systems are utilized for their cost efficiency, flexibility and acoustic properties. These systems can be used in almost any application. Caution should be taken to specify moisture resistant systems in wet areas.

Resilient Flooring

Linoleum was the first resilient flooring that gained broad popularity. Schools and public buildings with heavy duty needs still utilize linoleum as a resilient floor covering. Thicker linoleums can be warm and resilient. Disadvantages to linoleum are its sensitivity to alkalis, and susceptibility to water damage from underneath, which can cause it to bubble, peel or deteriorate.

Cork provides a very resilient and acoustic option for flooring. Inherently porous and fragile, cork is typically combined with resins to increase durability. The increased durability far outweighs the minimal loss of acoustics and resiliency with the addition of resins.

Vinyl Composition Tile (VCT) is composed of vinyls, resins, plasticizers, coloring agents, and fillers. VCT is resistant to oils, grease and other stains. It is very economical, wears well and is easily maintained, repaired, and replaced. Disadvantages include its

vulnerability to scuffing and marking, and continuous care required to maintain its visual appearance.

Sheet vinyl is waterproof, resists most domestic chemicals and can have a textured finish that is slip resistant. It is resilient, quiet, shows fewer marks than VCT, and can be cushioned. Sheet vinyls come in an unlimited range of colors and designs and can be used with underfloor heating. Solid colors are not recommended in high-use areas because they tend to show dirt and marking.

Rubber, possesses many of the same properties as vinyl; although it is more resilient and resistant to indentation than vinyl. It will withstand wear and spiked shoe traffic longer than any other type of resilient flooring. Rubber flooring with raised patterned surfaces is ideal for areas where excessive tracking of dirt or moisture is likely, because the dirt and moisture drop below the wear surface. Unfortunately, rubber is less resistant to grease, oil and alkalis than vinyl, and is not available as a conductive flooring.

Static-conductive tiles are specialty tiles with an additive to enhance the dissipation of static electricity. These tiles are frequently used in hospital operating rooms or laboratories where sparks may pose a hazard.

Carpet

Carpet comes in a wide range of colors, patterns and textures. Carpet aids in reducing fatigue from standing for long periods of time and absorbs noises within an interior. It is inherently slip resistant but provides a soft surface in case of a fall. Considerations when selecting carpet include type of fiber, construction and cleanability.

Carpet can be made from many different types of yarn, and further from different fibers within those yarns.

Fiber Types

- **Staple fibers** are relatively short in length and must be carded and spun in order to form yarn. Natural fibers such as wool, cotton and flax are staple fibers. Synthetic fibers are sometimes cut into staple fibers.
- **Continuous filament fibers** are produced as single running fibers. Typically nylon and other man-made

fibers are continuous filament. Silk is a natural continuous filament fiber.

Fiber Composition

Nylon is the most common type of fiber used in commercial carpet. Nylons may be dull or glossy and have good color range. Nylon is very tough and easily cleaned, and it blends well with other fibers. The more advanced nylons have inherent static control and excellent resistance to mold, mildew, aging, abrasion, and sunlight. Unfortunately, nylon does attract dirt and melts on contact with direct flame.

Wool, a natural fiber, is warm, soft, fire and mildew resistant, has a hard-wearing resiliency, and dyes well in a wide range of colors. It has a high resistance to soiling and wear as well as excellent texture and appearance retention. However, dampness may cause wools to swell, and dry heat may cause shrinkage.

Continuous filament **olefins** are used in backings for tufted carpets. They are hard-wearing, easy to clean, and resistant to water, mildew, soil, stain, aging, abrasion, and sunlight. A major disadvantage of this fiber for face yarn is that the material crushes and pills easily, making it undesirable for commercial use.

Dye Processes

Yarns may be colored at several stages during the manufacturing process. Synthetic yarn which has color added to it prior to the fiber-forming process is called **solution-dyed**. Synthetic or natural yarns colored after being formed are called **yarn-dyed** or **skein-dyed**. Yarns colored after the carpet has been manufactured are referred to as **piece-dyed**.

Solution-dyed yarns hold their color best because the color is integral to the yarn and thus not subject to removal by cleaners or bleach. Because the dye is contained within the body of the yarn however, the color is dependent on the color and clarity of the base yarn material, and is usually muted. Because the various colors of yarn are made individually, they are generally produced in smaller batches than yarn which is to be skein or piece-dyed, and are therefore more expensive than these goods.

Because the pores on the surface of skein and piece-dyed yarns are already filled by dye, they tend to be more resistant to staining than an untreated solution-dyed yarn.

As the dye rests on or near the surface of skein and piece-dyed yarns, their color is generally more brilliant as well.

Both solution and yarn-dyed carpets offer excellent opportunity for color mixing. Because the entire carpet is subjected to a single dye for piece-dyed goods, color is dependent on the yarns' ability to absorb or resist the dye, and is therefore much more limited.

Another opportunity to introduce color and pattern to a carpet is through overprinting. Overprinting is a localized dye process whereby dyes are applied to the face of a carpet, or injected into its pile. Limitations to this process are depth of ink penetration, color resistance to cleaning, and lack of definition in pattern due to bleeding or wicking of the dyes along and between yarns. Overprinting has its broadest applications in the production of less-expensive custom pattern carpets and remanufacturing. (In remanufacturing, the face of a used carpet is sheared slightly, and then the carpet is overprinted to update its look and conceal minor flaws and damage.)

Carpet Format

The term **broadloom** originally referred to woven carpets which were made on a loom, but now describes most rollgood carpets. Broadloom carpets are available in a variety of widths, the most common of which are 1830 mm (6 feet) and 3660 mm (12 feet). Use of a broadloom carpet requires the development of a seaming plan prior to installation to ensure that seams are located inconspicuously and never in the middle of high traffic areas. Disadvantages of broadloom carpet include inconvenience of access to underfloor systems and difficulty in replacing damaged areas.

Carpet tile is manufactured as a rollgood and then cut into squares of 305 mm (1 foot) to 1220 mm (4 feet) dimensions. Installation by glue-down or loose-lay methods are possible. Replacement of damaged or worn tiles is quite simple. Other advantages include reduced waste of goods at installation and easy access to underfloor systems. Initially carpet tiles cost more than broadloom, but life-cycle cost may be less, if reconfiguring or replacement of small areas is significant.

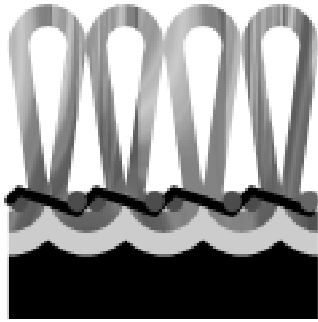

Fig. 12 Tufted; loop carpet

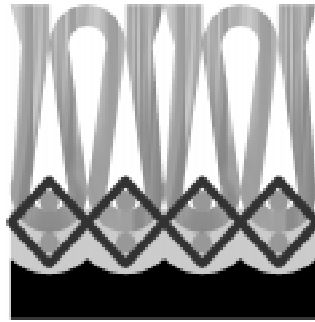

Fig. 13 Woven; cut and loop carpet

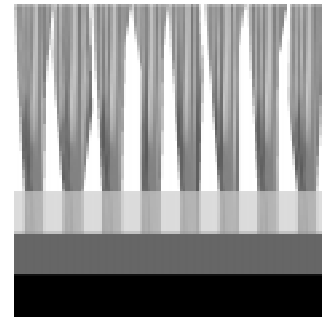

Fig. 14 Fusion bonded; cut pile carpet

Tufted carpets are made up of individual tufts of yarn inserted into a premanufactured jute, cotton or synthetic

backing (Fig. 12). A coating of latex applied to the back of the carpet bonds the tufts to the backing.

In the **woven** carpet manufacturing process, the yarns for the backing are woven simultaneously with those of the face (Fig. 13). The primary components of a woven carpet are the weft yarns, backing yarns which run the width of the carpet; the warp yarns, backing yarns which run lengthwise through the carpet; and the pile yarns which form the face of the carpet. The three principal machine-woven techniques are: velvet, Wilton and Axminster. **Knit** carpet is a type of woven carpet in which the pile yarns are interwoven among themselves, resulting in a three dimensional weave.

In **fusion bonded** construction, pile yarn is inserted directly into liquid vinyl backing which is then fused at a high temperature to lock in the yarn, creating a unitary structure (Fig. 14). In some manufacturing operations, the yarn is sandwiched between two backs, and cut after curing to form two separate runs of carpet. Fusion bonding provides high tuftbind and density, maximizes face yarn utility on the wearing surface, and minimizes edge fraying or raveling.

All face yarns in **cut pile** (Fig. 14) carpet are cut. The carpet then has a plush, velvet look. Cut pile hides seams and cuts well, and responds favorably to easy, periodic maintenance. It can be produced in fusion-bonded, tufted or woven construction. Low density cut pile carpets show crushing and shading, and should be avoided where this is a concern.

Carpet Construction

Carpet Face Types

No surface ends are cut in **loop pile** carpet (Fig. 12). Loop pile can be produced in tufted or woven construction. It is very durable, not affected by crushing, and is easily maintained. Pilling can occur with staple fibers. Loop pile carpeting does not hide seams or cuts well due to blossoming of the yarn at locations where the loop has been cut.

Tip shear and **cut and loop pile** are combination face construction carpets which provide some of the benefits of each of the previous types of face construction (Fig. 13). Tip shear is produced as a multi-level loop carpet and then sheared to a single height. Cut and loop is cut during the weaving or tufting process. These carpets provide a softer look than all-loop pile, but are more durable than cut. They do not hide seams and cuts as well as all cut pile, but do better than all loop.

Backing Systems

Backing systems are enhancements to the construction of a carpet to ensure stability and integrity of the carpet. All woven and tufted carpets are constructed over a primary backing. **Primary backing** refers to the material the pile yarns are woven or tufted into during the process of manufacturing. While some woven carpets are heavy enough to require only primary backing, tufted carpet requires additional support.

Secondary backings improve the body of the carpet and its dimensional stability, anchoring the pile yarns to better prevent slippage. A **scrim coat** of latex is often applied to the back of a carpet to lock the yarns into place and is the basis for all additional backings. The **action-back** system consists of the carpet pile yarns and their primary backing with a latex pre-coat and a woven secondary backing laminated to it. One of the most common backing systems, action-back improves tuftbind, helps prevent delamination and is applicable to any type of carpet.

The **unitary backing** system consists of pile yarns and primary backing with a high performance latex or PVC coating to lock the yarns in place. This backing gives a higher tuftbind than action-back and prevents edge ravel, delamination and zipping. While unitary backing allows for better performance in high traffic areas, it is only used on all-loop pile carpet.

A **unitary action-back** has all the benefits of the unitary backing. The added secondary backing allows not only loop pile but also tip-sheared loop and cut and loop carpets to use it.

Padded backing is available in a number of formats and thicknesses. Padding is typically applied directly to the carpet to reduce the labor involved in installation, and to provide additional stability and integrity to the carpet as a form of secondary backing.

Installation Methods

Direct glue installation secures the carpet directly to the floor. The adhesive may be permanent or, for carpet tile, releasable. Releasable glue is used when periodic access is needed for gaining access to the underfloor systems. Direct glue is generally the most economical means of installing broadloom carpet. It provides an extremely stable carpet base suited to heavy traffic.

Stretched installation works well in light to moderate traffic areas. Perimeter fastening devices are installed which hold the edges of the carpet only, facilitating easy removal of carpet for relocation, replacement or access to the floor. These devices are generally either tack strips consisting of rows of metal barbs which bind the carpet backing, or fabric hook tape which binds special loop backing applied to the carpet during manufacture. Alternatively, the carpet may be tacked directly to the flooring, as is often the case when carpeting wooden stairs or other small or irregular areas.

Free lay installation is used primarily on carpet tile but may be used on other carpets with semi-rigid backing. Even in free lay installation, a grid of adhesive is generally necessary to prevent the field from shifting under load. This grid is typically 3.66m (approximately 12 feet) on center.

Carpet Pad

Carpet pad provides additional softness and extends carpet life by yielding with the pile under load. Various types of pad are available, made from natural fibers, urethanes and rubber. Some pads are separate roll goods installed prior to the carpet, others are specially designed integral pads specific to the application.

Carpet Cleaning

Various cleaning methods are available for carpet. The particular method used should be chosen on the basis of the installation and the nature of the soiling.

Feature		Characteristics
Material		
	Nylon	Good resiliency. Very good resistance to abrasion, crushing, matting, moisture, staining and soiling. Requires addition of anti-static fibers for static control. Appropriate for heavy wear areas.
	Olefin	Poor resiliency. Good abrasion and matting resistance. Very good mildew, staining, soil and moth resistance. Not prone to static build-up. Best used in indoor/outdoor and short term applications. Not recommended for interior commercial or institutional installations.
	Wool	Excellent resiliency. Very good resistance to abrasion, crushing, matting. Fair resistance to moisture, staining and soiling. May be treated to reduce static electricity build up and moth damage. High initial cost.
Dye Process		
	Solution-Dyed	Color is added prior to formation of fiber, and is therefore inherent to the material. Color consistency is optimal. Color is as resistant to chemicals as yarn. Porous fiber face—if not stain treated— allows retention of dirt and stains.
	Yarn-Dyed	Most brilliant color. Color is added to the bulk yarn prior to the carpet manufacturing process. By mixing yarn during manufacture of the carpet, small color differences may be concealed. Pigment fills porous fiber face, and reduces staining. Pigment is susceptible to damage from chemicals and abrasion.
	Piece-dyed	Carpet goods are dyed after manufacture. By mixing yarns of different dye resistance properties, multiple colors can be achieved. Some color variation through the carpet may be apparent due to the dyeing process. Pigment fills porous fiber face, and reduces staining. Pigment is susceptible to damage from chemicals and abrasion.
	Overprint	Used to add pattern to a carpet after manufacture. Color penetration varies by manufacturer. Some may be very shallow, and as a result will not wear well.
Construction		
	Tufted	Low cost manufacture. Quality depends largely on the ability of the carpet to retain tufts. Tuft bind may be considerably enhanced by added backing.
	Woven	Premium manufacture. Quality related primarily to carpet density. Wide variety of patterns available with different weaving processes.
	Fusion Bonded	Very durable carpet construction. High tuft bind. (See also Unitary backing below.)

Fig. 15 Carpet Selection Criteria Table of Common Carpet Features

Feature		Characteristics
Face Construction		
	Loop	Most durable of constructions. Resists matting and crushing. Typically matte in appearance as side of fiber is exposed.
	Cut Pile	Rich in appearance. Hides seams well. Prone to crushing and matting. Carpet density and pile height together determine quality of product. Low-density product tends to lay over and show traffic. Not recommended in heavy traffic areas or stairs.
	Cut and Loop	Aesthetic variation on the two face constructions listed above. This construction allows greater variety in surface appearance, while balancing, in some measure, the durability of a full loop carpet.
Format		
	Broadloom 2-4m wide	Long lengths produce fewer seams, and therefore the appearance of seams is a lesser consideration. May be padded. Limited access to floor. Difficult to repair. Large scale custom patterns require excellent craftsmanship.
	Carpet tile 0.5-1.33m square	Relatively easy installation. Large scale patterns are relatively simple to achieve. Floor access is maximized. Stains and wear are easily repaired. Seams are abundant.
Backing		
	Primary Scrim	Scrim coat of latex applied to back of carpet over tufted ends or weave. Increases tuft bind over non-backed. Enhances adhesion of direct-glue carpets.
	Action back/Secondary backing	Additional fabric backing applied over primary scrim. Improves tuft bind, dimensional stability.
	Unitary backing	Built-up latex or PVC backing. Excellent tuft bind and dimensional stability. Substantially reduces potential for edge ravel.
	Padded Backing	Reduces labor of installing backing separately. Some hybrid benefits of other secondary backings.
Installation		
	Direct Glue	Economical installation for broadloom carpet. Very stable. Difficult to remove. Typically no material value after removal. Glue-down of tile products is required by some manufacturers.
	Stretch	Broadloom only. Seams are taped or sewn. Large expanses of carpet are difficult to stretch. Carpet may move with weather conditions.
	Free lay	Carpet tile only. Easily installed, easily repaired. Provides immediate access to subfloor. May move if not properly installed

Fig. 15 (cont'd) Carpet Selection Criteria Table of Common Carpet Features

- The **dry extraction** procedure utilizes an absorbent powder or other component which is worked into the carpet pile and then vacuumed out. The soil-extracting particles used in this method are generally water-based detergents with a small amount of solvent. The advantage of dry extraction cleaning is that the fibers do not get wet. This alleviates the need for drying which may cause shrinkage, and eliminates the potential for mold or mildew growth.
- The **dry foam** method utilizes a water-based shampoo converted into foam. This is worked into the carpet and then vacuumed out. Cleaning with dry foam may not be as thorough as other methods, especially when large amounts of soil are deeply embedded in the pile layer. The risk of overwetting is minimal.
- The **wet shampoo** method utilizes a wet vacuum to draw fluids and dry matter from surfaces. Rotating brushes work the detergent solution into the carpet. This may cause pile distortion, especially to cut pile surfaces. This procedure must be administered carefully to avoid overwetting the structure and to prevent accelerated resoiling due to residual detergent deposits.
- The **hot water extraction** method, commonly called steam extraction, uses extremely hot water and shampoo. The diluted shampoo is driven into the pile and immediately extracted by the vacuum part of the machine. Minimal pile distortion occurs as there is no mechanical brushing. The detergent must be thoroughly removed to retard rapid resoiling.

For extremely soiled carpet, a heavy build up of residue may require removal with a combination of the above methods

Stain Penetration

In general, staining and spotting may be prevented by acting promptly: foreign substances are more difficult to remove after they have aged. Vacuuming dry substances, and absorbing as much liquid from wet ones as possible before continuing with other removal procedures, is key to avoiding stains. Having cleaning agents and materials available for immediate use as part of proper general maintenance will extend a carpet's life.

Paint and Other Film-Applied Finishes

Paint is, in generic terms, a suspension of solid pigment in a liquid, which is applied to a surface, and which then cures or dries to leave a thin film coating. Paints are available in limitless color choices. They are classified by their liquid portion—the vehicle. Paints are typically either water or oil-based.

Types of Water-Based Paints

Water-based paints have synthetic resins and color pigments suspended in water. Because they are water-based they are typically easier to handle than oil-based paints and clean up readily. The alkaline resistance of these paints makes them suitable for new lime-containing plaster. Acrylic emulsions make the dried film more water-resistant while vinyl emulsions give it a smoother finish. Water-borne paints dry quickly, but raise the grain on new wood. Most are not as tough or washable as oil-based paints.

Types of Oil-Based Paints

Oil-based paints may consist of natural or synthetic resins, color pigments, linseed oil, and solvents. They are extremely durable and washable, especially if made with synthetic resins.

Oil-modified resins, **alkyds**, have now replaced the traditional oil-based paints. Alkyds prove more durable and dry faster than typical oil-based paints. Alkyds apply easily and are priced moderately, but some disadvantages do exist. Exterior alkyds have poorer sheen and color retention than exterior latex or acrylic paints, and tend to yellow over time. A primer must be used on alkaline surfaces before an alkyd is applied. Although some alkyds have no odor, fumes may be toxic and highly flammable until the surface has dried. Clean-up requires mineral spirits and is more difficult than with water-based paints.

Formulations

Latex paint applies easily, has low odor, dries and recoats quickly, poses minimal fire hazard, and resists peeling and blistering. Latex paint is water-based and cleans-up with soap and water.

Acrylic paint is lightweight, strong, and has good color and optical qualities. It is resistant to weather and temperature. It is available in both oil and water-based preparations.

Finishes

Epoxy paint is typically a two-part preparation that produces a tough, hard, glossy finish. It works well for wet areas, and high traffic areas such as stairwells. It is waterproof, has excellent sealing qualities and resists specific acids, alkalis, gases, salts, and solvents. It is available in both oil and water-based formulations.

A **flat** finish has a dull, non-reflective surface that may be wiped but not scrubbed. It shows scuff marks easily and has little sealing capability, making it inappropriate for damp areas.

An **eggshell** finish has a slight reflectance and sheen. It is easily cleaned by wiping and will not show scuffs marks as readily as a flat finish. It can be used in moderately damp areas and is suitable for wood and metal.

Semi-gloss has more reflectance and sheen than an eggshell finish. Its glossy finish makes it durable and quite washable. It is normally used on woodwork and wet areas such as bathrooms, kitchens and laboratories.

High-gloss finish has high reflectance and sheen. It has a very durable, tough finish that cleans easily and resists marking and scuffing. Its good sealing qualities make it especially good for wet and damp areas, doors, woodwork, and trim; wood or metal.

Paint can be used in a variety of ways to create pattern and texture. Paint can be applied in patterns with stencils or by masking. Stippled, spattered or sponged textures can be created which utilize multiple colors and minimize appearance of spots or scratches. More-pronounced textures may be created with special paints that contain sand or other bulk; or by applying the paint with special rollers; or by going over wet paint with a sponge, dry brush, comb, or broom.

Other Surface Finishes

Specialty coatings include common multi-colored speckled finishes, textured coatings, and high-build elastic coatings. These finishes possess unique attributes with attendant benefits such as durability, safety, and appearance. They should be investigated thoroughly relative to the specific application intended to ensure appropriateness of use. Typically they require a specially-trained installer.

Lacquer is a solvent-based paint applied in multiple coats, typically with a spray gun. Lacquer may or may not have pigment and is typically used in the finishing process of commercial wood furniture and cabinets. Lacquer is highly combustible, and if not properly handled, presents a health hazard to the user.

Varnish refers to a family of colorless films used to finish wood and wood furniture. It provides a hard surface meant to protect wood from wear, while allowing the natural beauty of the wood grain to show through. Linseed oil varnishes are the traditional varnish. Polyurethane varnishes, made from a synthetic resin, are resistant to water and alcohol. Acrylic urethane varnishes do not yellow or change color as much as conventional varnishes.

Type	Characteristics
Acrylic	Excellent adhesion. Fast drying. Non-yellowing, good color retention. Resists weather and temperature. Low abrasion resistance. Low odor. Water clean-up.
Latex	Applies easily. Moderate leveling. Fast drying. Low odor. Moderate cleanability. Breathes to resist blistering and peeling. Water clean-up
Alkyd	More durable than traditional oil-based paints. Harder than latex or acrylics. Dries faster than traditional oil-based paints, much slower than latex or acrylics. Levels well. Easily cleaned. Tends to yellow and chalk over time. Flammable and strong odor until dry. Requires thinners for clean-up.
Epoxy	Very durable. Resistant to abrasion and many chemicals. Typically high-build. Flammable and strong odor until dry. Recommended for wet areas. Requires thinners for clean-up.

Fig. 16 Paint Selection Table for Common Paints

Stain is similar to paint, but does not form a sealing film so much as it penetrates the structure of the surface it is applied to. It can be transparent or opaque, and is available in a limitless range of colors. Several different types of stains are available. Oil-based, water-based and alcohol-based stains are typically covered with a protective coat of oil or water-based varnish. Alcohol-based stains are typically used under lacquer. Varnish stains provide a superficial colored protective surface. This type of staining method is cheap and fast but does not have the depth of color of other stains. Stain waxes

provide pigment as well as the protective finish of a wax.

While paints, lacquers, and varnishes are all appropriate surface finish materials, recent legislative **Volatile Organic Compounds (VOC)** regulations have led to the development of a new generation of higher-performing, easy-to-maintain top coats for finishing systems. These include high solids and water-reducible varnishes, lacquers, and polyurethanes. These superior quality, low VOC, high-build finishing systems provide excellent toughness, domestic chemical resistance and exceptional durability.

New VOC compliant, high-quality acrylic, and clear lacquer systems provide good film clarity, hardness and excellent resistance to yellowing. They are used in low traffic areas. High solids, low VOC polyurethanes offer impact, abrasion, chemical, and stain resistance as well as excellent hardness, while providing good color.

Wallcovering

Applied wall finishes, excluding paints, fall under the umbrella term **wallcovering**. These range from vinyls and papers to textiles of varying types.

Vinyl wallcoverings are durable and resist grease, stains and cooking splashes quite well, are scrubbable and easy to clean. Vinyls can be backed with a woven fabric to increase their durability and to cover rough subsurfaces. Vinyl wallcoverings come in a wide range of designs, colors and finishes. They are suitable for use in kitchens, bathrooms and most commercial installations.

Wallpapers are produced for residential and light commercial use in a wide variety of colors, textures, patterns, and pictorial images. Many wallpapers have a self-adhesive or prepasted backing for ease of installation. Papers are not intended for moderate to heavy use commercial installations. Wallpaper is not as durable as vinyl wallcovering and deteriorates more rapidly in the presence of moisture.

Textile wallcoverings come in many styles, textures and colors. They consist of a fabric face backed with paper. Silk, linen, wool, sisal, jute, nylon, and olefin can all be used. Textiles add softness, texture, color, visual

interest, and may add acoustic properties and durability to a wall surface. They do not all resist abrasion and snagging well and some are prone to soiling. These wallcoverings should be avoided in heavy traffic areas.

Fabric and Textiles

In this discussion “fabric” is used to indicate a finished material piece, and “textile” the raw material from which the fabric is made, or a general class of fabrics.

In selecting fabric for furnishings and drapery, each consumer or producer will use a unique set of governing criteria. These factors vary but usually relate to appearance, feel, and/or durability of the material. The following describes some of the appearance and durability factors associated with fabric selection.

Because fabrics possess both visual and tactile attributes, the designer must be knowledgeable about the textile characteristics associated with these qualities. Pattern, color, and texture of a fabric will affect how it will appear alone and in combination with other elements in the interior design.

Color characteristics of individual textiles and textile combinations must be considered when selecting fabrics. Other aspects associated with color styling—multi-colors, solid-colors, motif, detail, and pattern size—will also affect the appearance of fabric design.

Hand, drapeability, and weight must be considered when choosing a fabric. These qualities are associated with the psychological response of users to the material. The characteristics of hand (smooth, rough, cool, soft, or harsh), drapeability (stiff or fluid), and weight (sheer, thin, light weight, medium weight, or heavy weight) are all critical factors that need to be considered in fabric selection.

Durability depends on the basic life of the fibers that make up the fabric. Among the general factors defining durability are resistance to wear and dirt, ease of cleaning, and ease of repair. Other factors that may be specifically related to a fabric or textile's durability include:

- tenacity (resistance to tearing),
- stain resistance,

- abrasion resistance,
- cohesiveness (ability of a staple fiber to retain its spun form),
- elongation potential/elasticity,
- flexibility,
- structural stability,
- fiber strength,
- moisture/mildew resistance, and
- flame resistance.

Maintenance factors to be considered when selecting fabrics and textiles.

In order to preserve a fabric's appearance and durability, it must be maintained over time. The maintenance required of a chosen fabric must coincide with the consumer's preferences and willingness to perform the necessary procedures. Among the characteristics to consider when selecting a fabric are:

- cleanability, washability and dry-cleanability,
- on-site versus off-site cleaning availability,
- ease of stain removal,
- level of ironing required, and
- frequency of cleaning required.

As mentioned above, many costs are associated with the selection of different types of fabrics. Costs involved not only include the initial manufacturing or retail price, but can also include shipping and delivery charges, maintenance costs, additional treatment costs, and custom coloring and design costs.

Fabric Types

Fabrics fall under two main categories: natural and synthetic. **Natural textiles** are those fabrics constructed from materials occurring in nature. These include wool, silk, cotton, rayon (from wood pulp), and linen. **Synthetic textiles** are those constructed from man-made, primarily petroleum-based, products. These include nylon, polyester, olefin, and acrylic.

Textile Characteristics

Color retention/color fastness is important aesthetically to the appearance of a textile. The factors that influence color fastness are:

- chemical nature of fibers,
- chemical nature of dyes and pigments,
- penetration of dyes into the textiles, and
- fixations of dyes or pigments on or in the textiles.

The coloring agents used in fabrics should resist the washing, dry cleaning, bleaching, and spot and stain removing techniques used to maintain the fabric's visual appearance.

Abrasion resistance is the ability of a textile to withstand the rubbing or abrasion of everyday use. This rubbing or abrasion may occur when a fabric or textile is rubbed, flexed, or folded. The more flexible the fabric or textile, the greater the ability to bend repeatedly without breaking.

Stain resistance is the ability of a textile to withstand stains and spotting. Minimizing and removing stains is an important preventative activity that must be done to maintain the durability and appearance of a fabric over time.

Dimensional stability refers to the ability of a textile to retain a given size and shape throughout use and care. A desirable property for fibers that contribute to the textile properties of shrinkage resistance, elastic recovery, durability, and appearance; dimensional stability is especially important when choosing a method of cleaning.

Fabric Performance Enhancers

Fabrics utilize **backings** to reduce heat transfer, alter appearance, lock yarns in place, and minimize air and water permeability. Among the materials that may be used for this purpose are acrylic, foam, vinyl spray, paper, gypsum, spunlaced or spunbonded fabric, or metallic foil coatings.

Paper backing applied to the back of a textile fabric helps to prevent the application adhesive from seeping

through and producing a stained appearance. **Spunbonding** converts thermoplastic filaments directly into fabric structures. Filaments are arranged into a thin web and then stabilized with heat or chemical binders. Spunbonded fabrics are increasingly used for backings for wallcoverings and carpet. **Acrylic backing** involves using foam to minimize air movement through fabric, to increase thickness of fabric, and to finish the back of the fabric.

Backcoating of upholstery fabrics with acrylic latex reduces seam slippage and generally improves abrasion-resistance and dimensional stability.

Foam backed textiles—two layers of material joined together with stitching, adhesive, or heat—provide a stable backing for loosely constructed surface fabrics. Drapery fabrics use it for insulative lining. Both tricot knits and foams are used as backings. Quilts use three layers and are often hand-stitched or “heat-stitched.”

Treatments

Various performance treatments are available for textiles and fabrics. Treatments enhance certain inherent qualities, or add qualities required for special use.

Flame-retardance is the property of a material by which, when exposed to a flaming or non-flaming source of ignition, flaming combustion is prevented, terminated or inhibited. Flame retardancy may be achieved by:

- use of fibers which are inherently flame retardant,
- use of fiber modifications that are flame retardant, or
- use of flame retardant coatings.

Flame-retardant coatings modify the original characteristics of a textile to allow it to meet regulations regarding its use in specific applications.

Flame resistance requirements vary with how and where a material is to be used.

Material	Characteristics
Acetate/Triacetate	Manufactured fiber formed of cellulose acetate. Low cost. Sunlight, moth, mildew, and bacteria resistant. Naturally flame retardant. Low static electric potential. Low abrasion resistance.
Acrylic	Petroleum based synthetic. Moderate tenacity. Resistance to sunlight and abrasion. Moderate dimensional stability.
Cotton	Natural staple fiber. Moderate abrasion resistance. Absorbant. Thermally and electrically conductive. Resistant to alkalis and organic solvents. Low to moderate resiliency, shrinkage and sagging tendencies.
Fiberglass	Manufactured fiber in which the fiber-forming substance is glass. Sunlight, acid and alkali resistant. Flame proof. Low flexibility. No moisture regain.
Flax/Linen	Natural staple fiber. Low elongation. Good abrasion resistance. High moisture regain. Good thermal and electrical conductivity. Fabrics prone to wrinkling.
Jute	Natural staple fiber. Primarily commodity uses prevail. Low elasticity. Low sunlight resistance and colorfastness.
Modacrylic	Synthetic. High bulk. High flame resistance. Moderate resiliency. High elastic recovery. Low melting point. Low abrasion resistance.
Nylon	Synthetic. High tensile strength. Excellent abrasion resistance. Excellent resiliency and appearance retention. May be solution dyed.
Olefin/Polypropylene	Synthetic. Good abrasion resistance, tenacity. Excellent resiliency. Good dimensional stability. Static resistant, excellent resistance to most chemicals. Resists mildew and water-borne stains. Expensive to dye. Difficult to clean .
Polyester/Trevira	Synthetic. Excellent strength. Good abrasion resistance. Resists wrinkling. Permanent body.
Rayon/Viscose	Manufactured fiber made from chemically-prepared cellulose. Soft hand. High moisture regain. Good thermal and electrical conductor. Poor resiliency. Progressive shrinkage. Weakness when wet.
Silk	Natural, continuous filament fiber. Very fine fiber. Soft luster. Moderate to high abrasion resistance. Absorbant. Good heat retention. Dry hand. Medium density. Moderate resistance to wrinkling. Moderate recovery from elongation. Dimensionally stable. Poor electrical conductivity.
Sisal	Natural plant fiber. Very durable. Excellent abrasion resistance.
Wool/Mohair	Natural fiber from fleece. Moderate abrasion resistance. Low tenacity (especially when wet). Good flexibility. High elongation. Highly absorbant. High thermal retention and resiliency. Allergenic potential.

Fig. 18 Textile Selection Criteria Table

Flame test methods are designed to assess the potential flammability of fabrics by simulating real-life conditions. Flame Tunnel Test method ASTM E-84, also known as the Steiner Tunnel Test method, measures the surface burning characteristics of building materials. The testing apparatus is structured to simulate a corridor, and the testing procedures and results are used to assess flame spread and smoke generation. Specified criteria have been developed for various interior space characteristics.

Flame-retardant finishes must be durable (able to withstand 50 washings), non-toxic and non-carcinogenic. The hand and texture should not be changed by the finish, and the finish should have no residual odor. Materials used for this purpose are usually phosphate compounds or inorganic salts. Most of these finishes are not visible but add to the cost of the product.

Anti-microbial finishes inhibit the growth of bacteria and other odor-causing germs, prevent decay and damage from perspiration, control spread of disease, and reduce risk of infection transferal. These finishes are also known as antibacterial, bacteriostatic, germicidal, or antiseptic finishes.

Staph fluid barriers are fabric treatments for healthcare furnishings. The treatment uses an anti-bacterial agent which is self-deodorizing, self-sanitizing, and becomes an integral part of the fabric. Any staph fluid barrier used should be guaranteed for the life of the fabric and approved by the Environmental Protection Agency (EPA).

Vinylized fabrics have the surface laminated with a translucent film of sheeting as a preventive maintenance measure. This treatment slows soil accumulation so that proper maintenance only will be required. Though vinylized fabrics can be washed with mild detergent and warm water, they are not waterproof and are not intended for outdoor installations. The vinylized treatment produces some variation in color and luster.

Soil and stain repellents, used by manufacturers to prevent staining, utilize fluorocarbon compounds that enable fibers to repel or resist soil.

Application Guidelines

The materials presented in this chapter form a diverse group, from which the designer must choose according to functional need, aesthetic preference and availability. Applications Guidelines for floors, walls and ceilings follow which summarize objective characteristics of some of the more common material finishes, so that these materials may be compared on an objective basis.

Floors

Resilient Floor Coverings

Materials	Advantages	Disadvantages	Uses	Relative Cost Factor ¹
Vinyl Composition Tile	Resistant to Abrasion, Oils, Grease, Acids, and Alkalis.	Does Not Tolerate Standing Water.	Good for Most Commercial Installations.	Economical 1.0
Linoleum	Resilient. Resistant to Impact and Abrasion.	Susceptible to Staining.	Moderate-Traffic Public Areas.	Moderate 2.7
Cork	Resilient. Resistant to Impact and Abrasion. Natural Product.	Susceptible to Staining.	Moderate-Traffic Public Areas.	Moderate 3.2
Rubber	Resilient. Resistant to Impact and Abrasion.	Not Resistant to Grease or Chemicals.	General Utility Flooring. Stairs.	Moderate 3.2
Thermoplastic Tile	Resistant to Abrasion.	Sensitive to Fluctuations in Temperature.	General Utility Flooring.	Moderate to Expensive 3.6
Sheet Vinyl	Waterproof. Resistant to Most Chemicals. Weldable.	Requires Fairly Smooth Floor Surface.	Moderate Traffic Areas.	Moderate to Expensive 3.8
Static-Conductive Tile	Dissipates Static Electricity.	Sensitive to Extreme Temperatures.	Hospitals, Operating and Anesthetizing Areas, Computer Rooms, Chemical Laboratories.	Expensive 4.1

¹ Relative to the lowest-cost material solution presented. A cost factor of 3 indicates that the referenced material is approximately three times as expensive as the least-cost material solution shown.

Floors

Hard Floor Coverings

Material	Advantages	Disadvantages	Uses	Relative Cost Factor ¹
Concrete (Untreated)	Non-Slip. Abrasion Resistant. Can be Painted or Treated.	Will Give off Dust If Not Treated. Difficult to Clean.	Utility Flooring.	Economical 1.0
Concrete (Treated)	Nonconductive. Non-Dusting, and Non-Slip. Abrasion Resistant.	Requires Special Materials and Method of Application	Industrial and Manufacturing Areas Where Non-Sparking is Required.	Economical 1.1
Quarry Tile	Waterproof. Resistant to Grease and Liquids.	Non Resilient. May Break under Impact.	Heavy Traffic Areas, Kitchens.	Moderate 5.0
Ceramic Tile (Clay, Porcelain)	Waterproof. Resistant to Most Chemicals.	Cold. May Break under Impact. Glazing may Chip or Crack.	High Moisture Areas. Bathrooms, Kitchens.	Moderate 5.4
Wood	Relatively Easy to Clean and Refinish.	Not Resistant to Abrasion or Moisture.	Dry, Indoor Locations. Homes, Gymnasiums.	Moderate to Expensive 6.4
Brick	Resistant to Abrasion, Moisture, and Heat.	Rough and Uneven Because of Joints. Absorbs Stains.	Decorative.	Expensive 6.8
Terrazzo (All Types)	Durable in Extreme Weather Conditions.	Slippery When Wet.	Heavy Traffic Areas. Stairs, Hospitals.	Expensive 7.8
Stone (Granite, Marble, Slate)	Durable in Extreme Weather Conditions.	Slippery When Wet. Cracks under Impact.	Heavy Traffic Areas. Entries.	Expensive 8.2

¹ Relative to the lowest-cost material solution presented. A cost factor of 3 indicates that the referenced material is approximately three times as expensive as the least-cost material solution shown.

Walls

Material	Advantages	Disadvantages	Uses	Relative Cost Factor ¹
Paint	Inexpensive. Monolithic. Easily Applied and Maintained. Available in a Wide Variety of Colors, Finishes, and Compositions. Flexible.	Tends to Be One-Dimensional. Only as Durable as the Substrate.	Solid Color Walls, Faux Finishes, Trompe l'oeil, Patterns and Graphics.	Economical 1.0
Vinyl Wallcovering	Relatively Easily Applied and Maintained. Available in a Wide Variety of Colors, Patterns, and Textures. Can Conceal Flaws in Substrate. Can Provide Some Acoustical Benefits.	Not Easily Repaired. Susceptible to Delamination.	Public Spaces. Medium Traffic Surfaces.	Moderate 1.6-2.5
Fabric Wallcovering	Relatively Easily Applied and Maintained. Available in a Wide Variety of Colors, Patterns, and Textures. Can Conceal Flaws in Substrate. Can Provide Some Acoustical Benefits.	Not Easily Maintained or Repaired. Susceptible to Raveling, Fraying, and Delamination.	Private Offices and Communal Spaces. Clean, Low-Abuse Areas.	Expensive 5.0-7.3
Ceramic Tile	Impervious. Available in a Wide Variety of Colors, Sizes and Finishes. Extremely Durable.	Expensive. Brittle. Requires Extraordinary Substrate. Can be Perceived as Cold.	Wet Areas, Clean Areas, High Traffic Areas.	Expensive 5.3-7.4

¹ Relative to the lowest-cost material solution presented. A cost factor of 3 indicates that the referenced material is approximately three times as expensive as the least-cost material solution shown.

Ceilings

Material	Advantages	Disadvantages	Uses	Relative Cost Factor ¹
Painted Wallboard or Plaster	Monolithic. Durable. Easily Maintained. Unlimited Color Selection. Wide Variety of Finishes and Textures. Relatively Secure. Provides Good Environmental Separation. Ultimately Flexible.	Limits Accessibility to Ceiling Space.	Areas Where Durability, Cleanability, and Environmental Separation are Priorities, and Accessibility is Not.	Economical 1.0
Acoustic Ceiling Panels	Easily Installed. Relatively Low Initial Cost. Relatively Easily Maintained. Excellent Ceiling Accessibility. Variety of Colors, Textures, and Patterns Available. Easily Integrates HVAC and Lighting Devices.	Not Easily Maintained or Repaired. Susceptible to Moisture, Impact Damage, and Soiling. Not Easily Cleaned.	Areas Not Susceptible to Moisture or Impact.	Moderate 1.2-2.6
Metal Ceilings	Primarily Aesthetic. Defines a Ceiling Look. Can Conceal Mechanical Devices. Available in a Wide Variety of Colors and Patterns. Can Provide Some Acoustical Benefits. Limited Accessibility to Ceiling Space.	Not Easily Repaired. Susceptible to Impact Damage.	Primarily Public Spaces Where Aesthetic is Priority.	Expensive 2.8-3.6

¹ Relative to the lowest-cost material solution presented. A cost factor of 3 indicates that the referenced material is approximately three times as expensive as the least-cost material solution shown.



Furnishings



Furniture	7.1
Window Treatment	7.5
Signage/Graphics	7.8
Accessories	7.10
Art	7.11
Plants	7.12

Furnishings

Furnishings are elements added to a building for utility or ornamentation following construction. These include furniture such as chairs, desks, sofas and tables, and also cabinetry, window treatments, signage, and accessories. This chapter addresses the basic furnishing elements which are part of a comprehensive interior design package.

When selecting the furnishings for an interior environment, care should be taken to include their design as an integral part of the overall concept and to ensure coherency between architecture, materials, furniture, art, and signage.

Furniture

Furnishings may be classified into three major groups: residential, institutional, and contract. Each group is distinguished by the intent, extent, and duration of use.

Residential furnishings are generally lightly constructed. They are smaller in scale than contract furnishings, and are designed to fit smaller-scale residential spaces.

Institutional furnishings are designed for areas where heavy use or abuse are anticipated: hospitals, schools, correctional facilities, sports facilities, etc. They are characterized by easily-cleaned fabric, mar-resistant surfaces, and heavy construction.

Contract furnishings fall between residential and institutional. They are constructed to withstand extended use, but not abuse. They are typically used for corporate design in offices, reception areas, and boardrooms, but transition well to high-end residential settings.

Contract Furniture - Seating

Contract seating can be differentiated into four common classes: multiple seating, lounge chairs, side chairs, and desk/conference chairs. **Multiple seating** (Fig. 1) refers to seating groups often times ganged together to form a single unit. Individual chairs can have ganging mechanisms to allow flexibility in number and installation. Multiple seating is used primarily in waiting areas and assembly rooms. **Lounge seating** (Fig. 2) is designed for comfort and aesthetics. Sofas and lounge chairs are typically fully upholstered and can be used in many areas—executive offices, lobbies, boardrooms, reception areas, etc. **Side chairs** (Fig. 3) are accessory

chairs for offices and workstations. Also called guest chairs; side chairs are used for guest seating in offices or

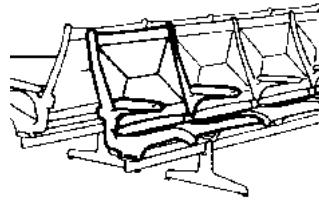

Fig. 1 Multiple seating

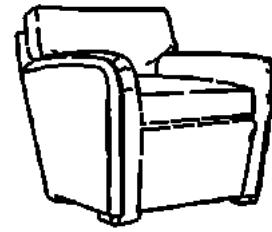

Fig. 2 Lounge seating

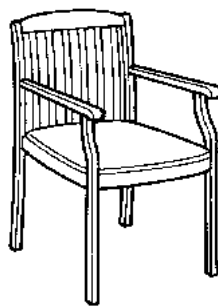

Fig. 3 Side chair



Fig. 4 Desk/conference chair

at workstations. Smaller in scale than lounge seating, they may or may not have arms, and as options may have upholstered seats, backs, or arms.

Desk/conference chairs (Fig. 4) are specifically designed to respond to ergonomics—the relationship between the work, the work conditions, and the worker. Ergonomic seating contributes to healthy, comfortable, adjustable support by providing appropriate posture, motion, and size for people and their tasks. Ergonomic seating can be passive or active. **Passive ergonomic** seating encourages proper body position through fixed construction. **Active ergonomic** seating allows the user of the chair to adjust his position via a control mechanism, such as pneumatic lift or sliding seat pan.

Given the multiplicity of functions among different types of seating, proper selection requires careful consideration of the influencing factors of space, function, and occupancy including:

- nature of the space,
- function of the space,
- physical characteristics of the individual user,

Seating design depends on a number of situational factors.

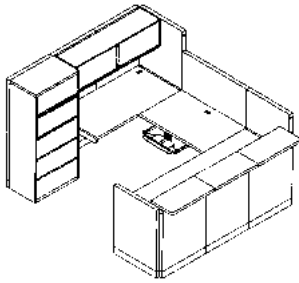

Fig. 7 Systems furniture

- frequency and duration of use,
- desired image or design intent, and
- anticipated maintenance program.

Casegoods

Casegoods are furniture elements constructed from box-like components. These include desks, credenzas, file cabinets, etc. Casegoods fall under two major categories: conventional and modular. **Conventional casegoods** (Fig. 5) come pre-assembled as finished, ready-to-use products. Desks, bookcases, display cases, and lecterns may all be gotten as conventional casegoods.

Modular casegoods (Fig. 6) are manufactured as separate pieces which may be grouped into a number of different arrangements. Desks and workstations are assembled from pedestals, work surfaces, credenzas, and filing cabinets.

Storage units such as file cabinets are a type of modular casegood which may be utilized to make up storage walls or room dividers as well. Modular assemblies may be room height for privacy or counter height for

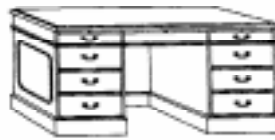

Fig. 5 Conventional casegoods

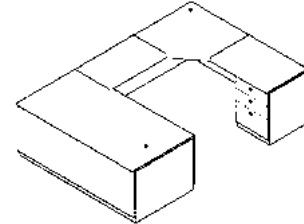

Fig. 6 Modular casegoods

openness. Either way, they serve as a partition while providing storage from one or both sides.

In selecting storage furniture, whether conventional or modular, what will be stored and aesthetic quality each play a part in determining the appropriate pieces. Storage furniture comes with a wide variety of options: open shelves, hinged or sliding doors, and various drawer arrangements. Different components can be grouped together to suit different needs. Modern storage systems often incorporate elements to serve special purposes: food service, audio-visual equipment storage, or display.

Systems furniture (Fig. 7) refers to modular components and panel elements that can be linked

together to form individual workstations or group work areas. Primarily intended for office use, systems furniture provides flexibility and multiplicity of function.

Systems furniture design varies by manufacturer, but some common characteristics do exist. It typically consists of vertical panels, horizontal worksurfaces, and storage units that can be arranged in a variety of configurations. By using vertical elements to support numerous components and provide a common data/electrical conduit, systems furniture achieves an economy surpassing most other furniture options. Systems furniture components may be post-supported, panel-hung, or wall-mounted.

Systems furniture can be supplied with electricity to support varying work tasks.

Systems are flexible in nature and can be rearranged to fit the needs of the user. They may be used to provide open or closed areas, and to accommodate one or more users. They can be located within closed rooms or open office environments. A systems furniture grouping around an individual is generally referred to as a workstation. Multiple workstations may be assembled into larger units, referred to as workgroups, to enhance economy, user communication, and productivity.

Electrical power distribution may be integrated within a systems panel or component, permitting electrical equipment to be plugged directly into the systems furniture. Internal raceways conceal wiring. Power connectors permit one workstation to be plugged into the next. The hidden raceways may contain electrical power, telephone cabling and computer wiring. Lighting fixtures to provide either ambient or task lighting may also be incorporated as optional components in the systems furniture.

Systems furniture specifications include various modular component pieces for panels and worksurfaces as well as power and communications systems, panel acoustics, and material finishes. Specifying the different products available from the various systems manufacturers requires detailed effort from the designer.

Custom Casegoods

Casegoods fall into three quality levels as determined by the American Woodworker's Institute (AWI). Budget, use, and aesthetics each play a part in determining which grade most suits a given project. Many characteristics differentiate between the premium, custom, and economy grades of casegoods. A few key characteristics are listed here.

- **Premium grade** (Fig. 8) refers to the highest quality of architectural woodwork. Usually reserved for feature areas or high-end projects, premium grade calls for continuous grain matching of veneer segments, quality finishes inside and out, and superior craftsmanship.
- **Custom grade** (Fig. 9), the most common for architectural millwork, requires limited grain matching of veneers and durable, quality construction and finishes.
- **Economy grade** (Fig. 10) defines the minimum acceptable level of quality within AWI standards. It requires no grain matching of veneered components and

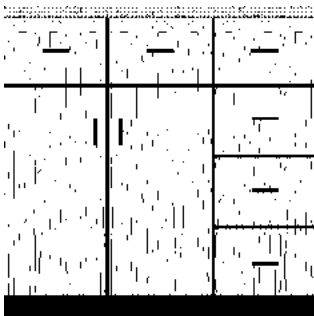

Fig. 8 Premium grade

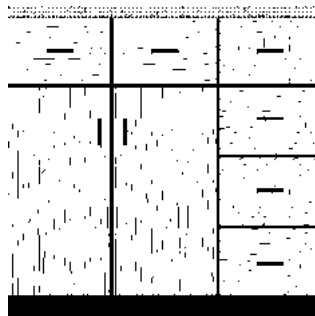

Fig. 9 Custom grade

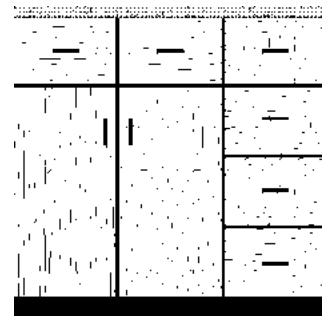

Fig. 10 Economy grade

generally describes a commodity product.

Window Treatment

Window treatments serve many purposes in an interior environment. They can provide privacy, light and sun control, reduced energy consumption (by preventing heat loss or gain), and decreased sound transmission. The type of treatment, as well as the type of material used, will determine the effectiveness of the treatment in any given instance. Sheer, semi-sheer, or casement fabrics will provide minimum privacy, shade, and energy

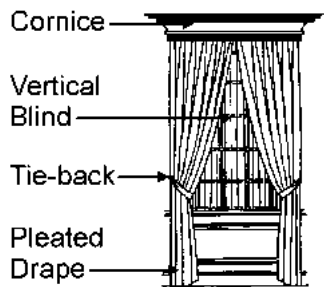

Fig. 11 Mixed window treatment

savings; heavy, opaque fabrics and hard treatments provide greater effect. Full, soft treatments will absorb more sound than hard treatments.

Window treatments should complement and support the interior design of a space. In addition, window treatments also add flexibility in the design, conceal architectural defects, or change the apparent size, shape, and character of a room (Fig. 11). Choices should be made based upon the elements and principles of good design as discussed in Chapter 4. Other factors to take into consideration include the structural characteristics of a space, exterior appearance, architectural style, and historical context.

Window treatments can be classified into three basic categories: soft, hard, and top.

Soft window treatments include those which are generally made of soft fabrics: curtains, draperies and shades. Both **curtains** and **draperies** are fabric panels which are generally pleated and hung on a rod over a window. Draperies tend to be more formal than curtains, usually consisting of several layers of panels. **Shades** typically consist of fabric panels designed to be raised and lowered.

The wide range of styles, along with limitless fabric options, make soft window treatments extremely flexible.

Hard window treatments are constructed from rigid materials and include shutters and blinds. **Shutters**, typically constructed from wood, consist of either a solid panel of wood, or wood louvers, within a stile and rail frame. They come in a variety of sizes, designs and finishes.

Blinds are available as horizontal or vertical slats of wood, aluminum, or plastic; and may have fabric or paper inserts. Blinds are effective for view, light, and air control. If desired, they can be completely hidden behind other window treatments.

Horizontal blinds have slats that run the width of the window; **vertical blinds** have slats that run the height. By using a control wand or pull cord, blinds may be raised and lowered, or moved side to side, and the slats angled up, down, or side to side.

Top treatments refer to any window treatment applied to the top of either soft or hard window treatments. In addition to adding to the aesthetic of a window treatment and giving a window a more finished appearance, top treatments also may:

- screen the hardware and rod,
- improve window proportion and hide structural defects,
- increase apparent height or width of a window, or
- make different sized windows appear equal by altering their visual proportions.

Top treatments may be chosen from a wide variety of soft treatments and hard treatments. Soft top treatments are called **valances**. The term valance encompasses any shape and style of valance within the designer's imagination, and limitless fabric and rod options. Hard top treatments are called **cornices**. Cornices are often used for energy efficiency. An architectural member that connects to the wall, window frame or ceiling, cornices can be made into any shape and size and can be finished wood, fabric covered, or a combination of the two.

Selecting Window Treatments

Aesthetic and functional performance criteria are to be used when selecting window treatments for an interior space. As with textile fabric selection, window treatments should be evaluated on both appearance and serviceability factors.

Fiber properties for window coverings critically influence performance and durability. Density, elasticity, stiffness, sunlight and chemical resistance, color fastness, flame resistance, weight, energy conservation, light transmission, and reflectance all determine how a window covering will function in its environment.

To preserve the appearance and usefulness of the treatments, sagging and shrinkage should be minimized. Sagging could destroy the balance of laterally draping folds and cause the fabric to puddle on the floor. Shrinkage will do the opposite and cause the treatment to look improperly fit.

Mildew resistance needs to be considered when selecting window treatments. In many climates windows are a

point of moisture condensation and operable windows will expose the window treatment to weather.

Maintenance

Preventative maintenance is important in reducing deterioration of the fibers and preserving the original appearance of window coverings. Moisture poses the greatest concern to maintaining window treatments. Care should be taken to keep treatments from hanging in contact with moisture. Water may combine with soil present on fibers causing the fabric to stain. Water may also combine with pollutants and oily cooking fumes to form dilute acids that attack and weaken fibers. In spaces where this occurs, window treatments should be cleaned frequently to prevent accumulation of these pollutants.

Cleaning itself is an important maintenance concern for window treatments. Typically, textile window coverings should be cleaned by a professional cleaning service. Most such services offer removal and rehangings as optional services.

Hard window treatments should be vacuumed or dusted on a regular basis to avoid accumulation of dirt. These types of treatments tend to be more difficult to clean of built-up residue than soft treatments.

Signage/Graphics

Signage and graphics in interiors serve to inform and guide people. Signage may be informational, directional, or regulatory. **Informational signage** (Fig. 12) provides the user with information and includes room or area labels, bulletin boards, menus, artwork descriptions, and emergency information. **Directional signage** (Fig. 13) directs circulation and provides orientation. It includes entry directories, directional arrows and maps. The purpose of **regulatory signage** (Fig. 14) is control:

- Scale drawings of each typical sign type.
- Construction and mounting details.
- Schedule of various sign types.
- Schedule of all text to be included on various sign types.

The need for illumination of signage and a graphics manual, describing the signage system and illustrating how to extend or modify it, are additional factors to take into consideration during the design of a signage package.

Accessories

Accessories may be either functional or decorative. Whatever the purpose, accessories serve to make a room appear less sterile and impersonal.

Functional accessories include letter trays, coat racks, lamps, glassware, magazine racks, brochure racks, and message boards. This group of accessories should be selected for utilitarian aspects as well as aesthetic qualities that may make a contribution to the total design concept. Repetitive elements can act as unifiers and help tie the accessories to the design scheme. Well-designed accessories do not have to be expensive to be visually effective in the space.

Audio visual (AV) equipment also falls under the category of functional accessories. AV equipment can be treated as part of the design or concealed within casegoods. AV equipment includes the following pieces:

- televisions (fixed screen or projection),
- portable sound systems for either speaking or entertainment,
- media players such as videocassette recorders (VCR's) and laser disc players.

Decorative accessories include utilitarian objects such as displays of product samples, and purely decorative objects such as artwork and plants. These elements may serve a secondary purpose or simply add a sense of freshness or uniqueness to an environment.

Art

An art program sets guidelines for the selection of artwork. Among the factors to be taken into consideration are:

- quality (posters, prints, original art),
- subject matter,
- medium (photography, paper, oil, etc.),
- size,
- placement,
- method of display (permanent collection or rotating program),
- lighting, and
- integration with design scheme.

The preparation of the artwork to be displayed and positioned in an interior space involves many important decisions. The designer must work closely with the user to determine placements that are satisfactory for both function and visual composition. Frame and mat must be selected to complement the artwork and interior design. Art should be carefully positioned for proper and comfortable viewing. Large works may be placed alone to create a dominant effect; small pictures may be grouped, or hung on a smaller wall surface. Proper lighting for viewing may be artificial or natural. Protection from abuse or deterioration is required for all art.

Art work has perhaps the greatest potential of any additive feature to alter our perception of a space, due to the immediacy of its communication.

Lighting of artwork may be either uniform or non-uniform. Uniform lighting for all vertical surfaces that will receive art gives prominence to the architecture. Viewers have the opportunity to select their own focus and to enjoy all pieces of art. Non-uniform lighting focuses light on individual objects while leaving the surroundings comparatively dark. This technique gives prominence to the art over the architecture, and, all else being equal, creates a more dramatic environment.

In a space where art is changed frequently, flexible lighting is most effective. Track systems are often selected because of ease of locating and aiming the luminaries as needed. With either method for lighting art, excellent color rendering is important for a proper appreciation of the objects. To achieve the objective of allowing the viewer to see the color in the art;

continuous spectrum, high Color Rendition Index sources are essential.

Other functions to consider in lighting art are the medium, surface texture, and type of frame or enclosure. Placement of the light source is crucial to minimizing problems with shadows from the frame and distortion of the object due to exaggerated texture.

The lighting of three-dimensional objects will affect the viewer's perception of these pieces. Concentrated beams create higher contrast and deep shadows, emphasizing form and texture. Lighting a vertical surface behind an object in addition to the object itself provides a luminous backdrop to separate the object visually from its background. Lighting from the side as well as from above provides added dimension to the piece.

Plants

Plants have become an important interior design element. They add color, texture, and variety of form and shape to the interior. They bring a natural element to an otherwise artificial environment. They are used as focal points, screening, and for psychological effect. Increasingly, plants are being incorporated into the interior environment for the health and well-being of the user, as well as enrichment of the space.

Fresh plants serve a healthful function by cleaning and freshening indoor air. They absorb noxious gases through tiny openings in the leaf surface and release oxygen and water vapor in return. Even a relatively small number of plants can do an effective job of cleaning the air.

When selecting plants, their light, water, and temperature needs, continuing care requirements, and ease of replacement must all be considered. The designer must consider the kinds and amount of light the space has—direct or indirect, daylight, fluorescent or incandescent. The ease with which plants can be watered is critical as well. Plants should not be positioned such that their location presents a problem in watering.

In general, low-light acclimated plants should be used in interior spaces. A plant maintenance program is highly

recommended for the survival and growth of plants in an interior environment, because they need consistent care. Plants must be sprayed for insects, pruned, fertilized, rotated, and polished on a regular basis. Some plants are toxic if eaten. Care must, therefore, be taken in selecting and locating plants in areas where small children and/or animals may be present.

Silk plants were developed to replace live plants in environments where growth and maintenance are inhibited. Quality silk plants look very much like real ones, but require far less maintenance. While they provide close to the same aesthetic effect, silk plants cannot provide air cleaning.

*Plants add life to a space.
Living plants also add vital
elements to the environment
and help to purify the air.*

Plants should be selected which are appropriately scaled to the space in which they are placed. They should complement the design scheme functionally and aesthetically. Aesthetic considerations include foliage color, size, shape, and outline. A single well-placed plant may be very dramatic, almost abstract, while masses of plants arranged in a line might create the effect of a soft screen. Big bold plants are good for major effects or to fill a space where furniture does not fit; small ones can occupy a place of prominence on a table or window ledge.

The containers or planters in which plants are kept have much to do with both ornamental value and the health of the plant; but when the requirement for proper drainage, root spread, and soil aeration has been met, almost any container can be acceptable. Glazed and unglazed ceramics, metals, glass, and plastics can also provide liners for more decorative, less water resistant containers such as wicker or wood.

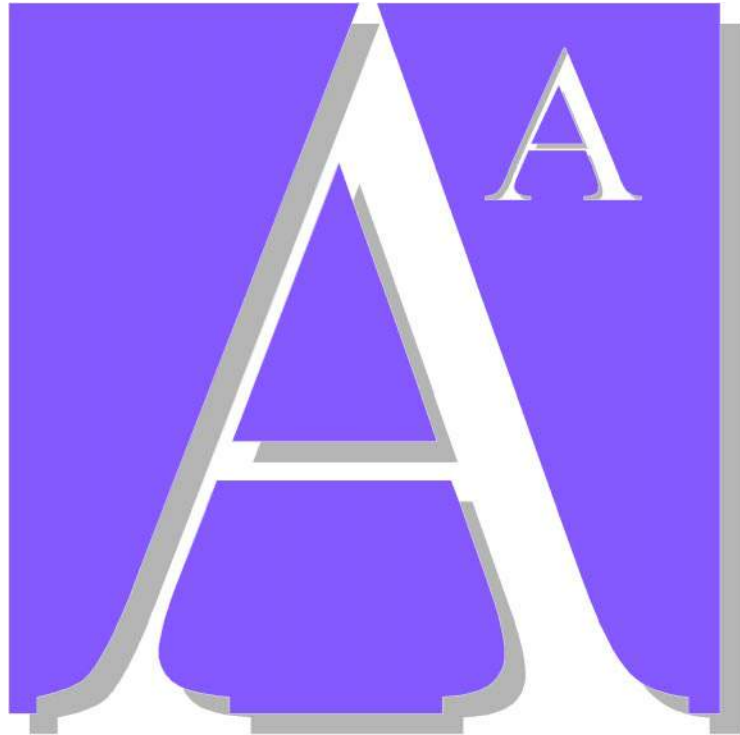

Appendix A



Army Interior Design Process

Appendix A

Army Interior Design Process

The U.S. Army Corps of Engineers (USACE) is the construction agent for the Army and the Air Force. In 1974, USACE hired its first in-house interior designer, primarily in response to its Air Force customer's request for coordinated, high-quality interior finishes and furniture in its operational and personnel support facilities. In 1981, USACE first defined interior design services and design responsibilities in a policy document, ER 1110-345-122, *Engineering and Design, Interior Design*. In response to the USACE commitment to improving the quality of interior environments in the 1980's, the first USACE *Design Guide for Interiors* was issued in 1982.

In 1988, the U.S. Army Engineer District, Omaha was designated the Corps-Wide Technical Center of Expertise (TCX) for Interior Design. Along with a commitment to improve interior design criteria and expand interior design staffing, USACE also introduced interior design training for USACE, command staff, installation staff, and facility users in 1989. USACE currently has in-house interior design staff in ten district offices with military design and construction responsibilities to provide service at every step in the process of obtaining and maintaining facilities.

Organization of the Appendix

The appendix is organized in terms of the process steps normally required to obtain and maintain facilities. Important criteria references are discussed with each of the steps.

Planning and Programming

References

Army Regulation 415-15. *Army Military Construction Program Development and Execution*, dated 30 August 1994, or later. This regulation sets Army policies, responsibilities, and procedures for use in development of Military Construction Army (MCA) programs. Included is guidance concerning planning, programming, designing, budgeting, construction, and disposing of major and minor construction, acquisition of real estate, and other supporting activities.

*Army Regulation 415-15.
Army Military Construction
Program Development and
Execution is the primary
reference for planning and
programming of all Military
Construction Army
programs*

Appendix G, "Facilities Standardization and Repetitive Designs", AR 415-15, discusses the advantages to the government in the reuse of successful designs. This encourages efficient use of time and funding by using existing and proven designs. Currently, two facility types have standard interior designs developed. These are for use in Chapel and Unaccompanied Enlisted Personnel Housing interior design projects.

Appendix H, "Equipment Installation", AR 415-15, defines installed building equipment which is normally provided as a part of construction and whose costs are included in the construction cost estimate and personal property, which is not normally MILCON funded. (Note prewired workstations may be provided in the construction contract when funding is included in the DD Form 1391 and furniture-related interior design services are requested.)

Appendix I of AR 415-15 defines the DD Form 1391, "Military Construction Project Data". This form defines user facility requirements in terms of area, functions, and financial resources. The DD Form 1391 is important to the interior design process because it can be used to define furniture-reflected requirements.

Architectural and Engineering Instructions, Design Criteria. This document (3 July 1994 or later edition) is issued by HQUSACE to replace DoD 4270.1-M, *Construction Criteria*. The *Architectural and Engineering Instructions* (AEI) provide design criteria and guidance to be used when planning, programming,

designing, and managing military facilities at Army installations. The AEI is a single source document for planning and design criteria because significant related criteria are referenced for each facility type.

Standard Designs. Standard Interior Designs provide guidelines for interior materials and furnishings for specific facility types. There are currently two standard interior designs which have been developed within the USACE. The facility types are Chapel and Unaccompanied Enlisted Personnel Housing.

Other Sources. Both the Army and Air Force major commands provide additional criteria on specific facility types which are of particular importance to them. This guidance should be used to supplement the referenced criteria. This information can be placed behind the numbered tabs.

Design Directives

Design Directives are given to Districts to authorize various stages of design and specific functions. These directives are given design codes which manage, in part, the design execution. Directive codes which typically apply to MCA projects requiring Interior Design are:

- **Code 1** directives initiate the design of a project, authorize selection of an Architect-Engineer (A-E), and permit various preliminary work such as surveys and studies.
- **Code 2** directives permit development of a project to the concept level. For the purposes of reporting, approved concept design is considered to be 35% of the total design effort. Concept design includes drawings, estimate, design analysis, and outline specifications adequate to define the functional aspects of a facility.
- **Code 3** directives may be issued for certain types of projects in lieu of a Code 1 or Code 2 directive. A Code 3 design is known as Project Engineering with Parametric Estimating. It is authorized for certain types of projects to achieve a clear definition of project requirements, scope, and cost more quickly than can be accomplished with a Code 2 directive.
- **Code 4** directives indicate that the project design is on hold, pending a supplemental design directive.

- **Code 5** directives indicate that the project is deferred from the program.
- **Code 6** directives authorize final design. The District Commander's approval of final design is sufficient to permit the project to proceed to advertisement and bid.
- **Code 9** directives indicate a construction contract (or design and construct contract) is authorized for award.

Responsibilities

Although USACE is not normally involved at this stage, assistance with scope definition and preparation of programming documents can be provided on a reimbursable basis. In addition to defining area and functional requirements, the identification of funds for furniture and furnishings is critical to effective programming.

Planning and Programming. During this phase, the user has the responsibility to initiate planning and programming. The Department of Public Works (DPW) prepares the programming documents.

Funding. The funding for Military Construction (MILCON) projects differs significantly from funding for Operations and Maintenance (O&M). The processes are as follows:

- **Military Construction Projects.** Funds are not available until Congress passes and the President signs the MILCON Authorization and Appropriations Acts. Funds are available for new obligations for a period of 5 years. The process by which these projects reach Congress for approval is as follows.

- Documentation for projects over \$300,000 is prepared and justified by installation commanders based on the Installation Master Plan. DD Form 1391 is the programming document which includes project description, costs estimates and is the basis of the requirement for the facility.

- The Major Army Command (MACOM) includes this in its "Six-Year Program" on a priority basis. This program is submitted to Headquarters Department of the Army (HQDA).

- HQDA justifies programs to Department of Defense (DoD), Office of Management and Budget (OMB) and to the Congressional committees.

- The programming document is submitted to Congress for review, approval and passage as Public Law.

- Once a project has been approved, HQUSACE will release it for design by a District by issuing a design directive.

• **Operations and Maintenance Projects.** O&M Funds are appropriated on a yearly basis by Congress and are allocated at the base level. They are available for a variety of uses including the purchase of furniture. Funds are provided by the user and are available for new obligation only for the year appropriated.

Design

References

ER 1110-345-122, *Engineering and Design, Interior Design* 15 April 1994 or later establishes policy requirements, and responsibilities to be followed in the planning, design, approval, and procurement of interior designs for military construction projects and improvement programs.

This ER defines types of interior design to be performed as Building- and Furniture-Related Interior Design. Building-Related Interior Design is required for all facilities and includes all items permanently attached to the facility. This service requires the accommodation of needed furniture and equipment within the building, and the design or selection of items normally provided as part of the building construction project in accordance with AR 415-15. Furniture-Related Interior Design services relate to the planning and selection of items that will be provided or procured by the Government. This service will be provided when requested by the user and normally includes items which are movable and not permanently attached to the facility.

Initiation of Design

This is the point where USACE design activities normally enter the process. The Scope of Work is refined from the data provided on DD Form 1391. Refinement involves developing any additional information necessary to define a Scope of Services, from which an Architect-Engineering (AE) firm can be contracted. For in-house designers, this scope refinement is necessary to establish man-hour estimates and budgets for design. The designer performs the following two functions to start the design process:

In addition to policy requirements and responsibilities, ER 1110-345-122 establishes the framework of the process for USACE participation with the customer.

Data Collection - Specific data applicable to a project must be collected prior to starting design. This information is project-specific. The collection of this information may involve a site visit, customer completed survey, or direct contact with the customer. A predesign conference is also appropriate at this stage of design. This conference should include all interested parties in the design process to discuss specific requirements and clarify responsibilities.

Data Analysis - Once data has been collected, it must be analyzed for its implications in relation to the design. Various factors involving customer requirements, existing conditions, criteria/regulations, design practices, regional preferences, and maintenance considerations are analyzed to form a complete basis for design.

Concept Design

Concept design is authorized when a Code 2 design directive is received from Headquarters U.S. Army Corps of Engineers (HQUSACE). Concept design is based on the pre-design activities and is limited to the Headquarters Department of the Army (HQDA) approved scope as stated in the DD Form 1391. AR 415-15 defines information required to be provided in a concept design.

Project Engineering with Parametric Estimating

Project engineering with parametric estimating is authorized for certain construction projects where standard designs, design guide sketches, or project designs exist that meet the requirements of the customer. Its purpose is to provide a clear and final definition of project requirements by the design agency, with customer involvement throughout the process. Appropriate design decisions and calculations, as well as a thorough site investigation will be accomplished. Project scope and cost will have the same degree of reliability as a 35% concept design. Architectural and Engineering Instructions (AEI), Code 3 Design, 6 February 1996, defines the information required for this type of submission. Government-furnished equipment, installed equipment, and equipment that will be procured and installed by the using agency should also be identified.

Project engineering with parametric estimating is not generally suitable for modernization, maintenance and repair, minor construction, or urgent minor projects. This process also does not apply to medical projects.

Final Design

Final design is based on approved concept design and is authorized when a Code 6 directive is received from HQUSACE. The final design must be functional, cost effective and reflect the scope of the approved DD form 1391. At the completion of this stage, contract documents are 100% complete.

Procurement

References and Sources

Federal Acquisition Regulations (FAR) - The Federal Acquisitions are based on Public Law. For the purpose of Interior Design, they define acceptable processes for acquisition of interior items.

FAR Part 8. This portion of the FAR directly affects the interior design process by outlining the required sources of supplies and services and their use. Of particular importance to the process of developing and procuring Furniture-related Interior Design is paragraph 8.001, Priorities for use of Government supply sources. These are as follows:

- Agency inventories
- Excess from other agencies (Subpart 8.1)
- Federal Prison Industries, Inc. (Subpart 8.6)
- Products available from the Committee for Purchase From People Who Are Blind or Severely Disabled (Subpart 8.7)
- Wholesale supply sources (such as the stock programs of the General Services Administration (GSA))
- Mandatory Federal Supply Schedules (Subpart 8.4)
- Optional use Federal Supply Schedules (Subpart 8.4)
- Commercial sources

General Services Administration (GSA) Schedules. The General Services Administration contracts with manufacturers of a variety of products for purchase by agencies of the Federal Government. Products are grouped by product type and contracts are awarded to either multiple or single vendors. These contracts are intended to ensure that the government receive products that meet the specifications outlined by GSA at a price

that is fair to the government based on the large quantity of products purchased. Products are selected from these schedules subject to the FAR regulations.

To request GSA Schedules, a GSA Form 457, FSS Publications Mailing List Application, must be completed. Copies of the GSA form 457 may be obtained from the following:

General Services Administration
Centralized Mailing List Service (7CAFL)
4900 Hemhill St
PO Box 6477
Ft. Worth, TX 76115

Federal Prison Industries (FPI) UNICOR. Federal Prison Industries supplies a variety of products for use by government agencies. Among these items produced are a variety of furniture and drapery products. FPI is a mandatory source of supply for government agencies. If an item is produced by FPI and another source for that product is desired, the FAR requires a clearance be obtained from FPI before that item can be purchased from another source. Information about UNICOR products or services can be obtained from:

UNICOR Customer Service Center
(800) 827-3168

Actions

Building-Related Interior Design - Items permanently attached to a facility and purchased with military construction funding are documented in contract documents. These documents include the contract drawings and specifications. Drawings clearly depict the plans, details, schedules, dimensions, elevations and all other essential visual information required to construct a complete facility. Specifications define in written form requirements for specific materials and products required for facility construction. These specifications are written in a three part format. These three parts are:

- Part 1, General, which outlines references and submitted approval requirements.
- Part 2, Products, which defines product quality.
- Part 3, Execution, which defines installation.

Furniture-Related Interior Design - Items which are not permanently attached to the facility may not be purchased with military construction funding and require an alternate method of procurement and implementation. Once the source of supply has been determined, all information necessary for procurement and installation of that item must be supplied on the appropriate procurement form. Information may also include a clearance from FPI, source justification for GSA items, or a performance specification. A specification may be required if the total dollar amount exceeds the small purchase limit of \$100,000.

Furniture-Related Interior Design is documented separately from, and is not a part of, the Contract Documents. The Furniture-Related Interior Design documents should contain all information required to procure and place furnishings including item, manufacturer, price, color/finish, placement plans and lists, total estimates, and all other pertinent information required by the Contracting Officer.

During the procurement of the furniture package, support to the contracting agency may be required. This support could include re-selection of furnishings which are not currently available, update of information which may no longer be current (such as price) or participation in the evaluation of items competitively bid from a specification to determine best value for the government. The requirement to provide these services should be defined in the Scope of Work, when the service is desired by the customer.

Design Services During Construction And Installation

Building-Related Interior Design

Building-Related Interior Design is documented in the Contract Drawings and Specifications. These documents define the quantity, quality and installation of materials required for a project. They are legally binding documents. Once a contract has been awarded to a contractor, the drawings and specifications are the documents by which a facility is constructed. The government assures quality of construction and approves

products to be used in construction by means of Contractor Submittals (Shop Drawings). The contractor submits for approval information and samples which the contractor believes will meet the contract requirements.

Any changes to the contract documents after the award of the contract require a modification to the contract by which the cost of the contract is adjusted accordingly.

During construction, support to the field may be required. This effort could include preparation of modifications to the contract documents, shop drawing review and approval, site visits to verify or assist in resolving unforeseen issues that arise, and other technical support which may not be available in the resident or area office.

Furniture-Related Interior Design

During installation of furniture, assistance may be required on site. This may involve the placement of furniture, furnishings and artwork. Typically, this effort requires additional funding as it is not normally covered as an extension of design.

Completing The Process

USACE

At this point, USACE turns the building over to the user and DPW. However, approximately one year after completion of construction, a Post Occupancy Evaluation of the project is conducted to determine the effectiveness of the design. This evaluation involves the inspection of the completed facility by a team composed of Corps and user personnel. It is typically concerned with the Building-Related aspects of the interior; however, Furniture-Related interior design may also be evaluated. Information on the quality, durability, and suitability of the furniture and furnishings can then be used to improve future projects.

User Responsibilities

Installation Design Guide. Interior design policy is a component of the Installation Design Guide (IDG). The IDG reflects installation themes and policy which are

unique to the individual military installation. The IDG should address interior design policy in terms of design and maintenance issues.

Operations Policy. To preserve the quality of facilities, the user and installation must agree upon an operations policy which defines their respective responsibilities. The user is responsible for preserving the visual appearance of the facility, and the installation is responsible for providing maintenance support needed to preserve facility quality.

Reorganization and Changing Mission. As DoD reorganizes and redefines its mission in the world, changes occur in the work place that must be addressed. As functions and technology change, the needs of the occupant are impacted. The interior environment must respond to those needs if the mission is to be supported. These changes ultimately require rethinking of the use of space, and the process of planning and programming must begin again.

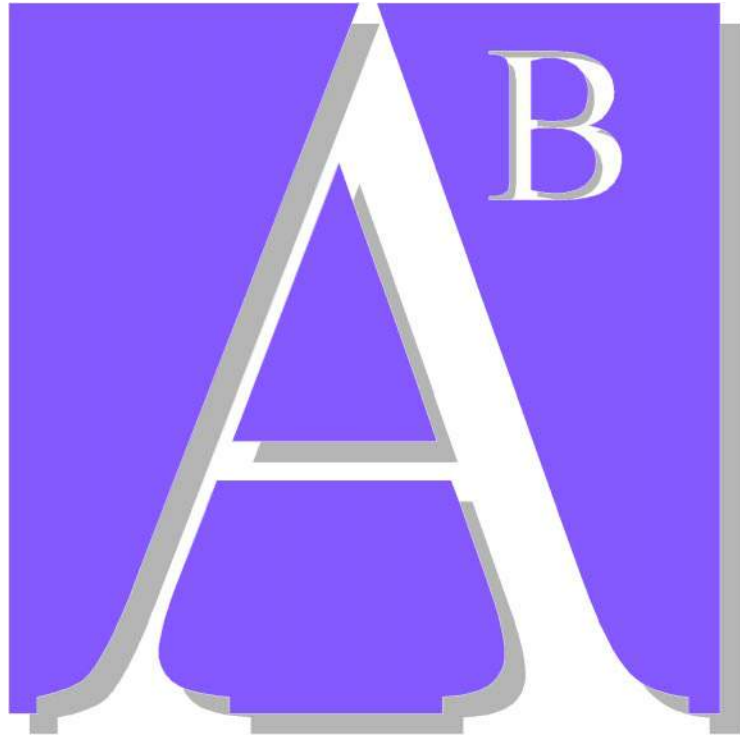

Appendix B



Planning for Administrative
Work Environments

Appendix B

Planning for Administrative Work Environments

As stated in AR 405–70, *Utilization of Real Property*, "The goal of space utilization planning and management is to maximize the efficient use of all Army lands, facilities, and space assigned to support missions." Satisfying this goal in the planning of administrative work environments requires an examination of both the organization's requirements and the criteria governing space utilization.

The first step in the planning process is to ascertain the raw data defining the physical extent of the area. Personnel count, equipment requirements, and growth projections must be determined in order to define the scope of the project. Understanding the culture of the organization and the mode in which it operates is necessary to provide effective space planning and design. The organizational elements are analyzed within the context of the larger office environment and parameters imposed by existing conditions. Once the global aspects of the environment have been established, the detailed design of workstations and their components can be accomplished. Documentation of construction elements via plan drawings and specifications follows. Furniture elements are documented in detailed layout plans of componentry, power, data, and communications systems. Although professional support is available, facility users have many responsibilities related to procurement, installation, and moving personnel into the new work environment.

Data Collection and Programming

The discovery of quantitative information which characterizes an organization—area, power, cooling requirements and the like—is accomplished by conducting an inventory of office, storage, specialized spaces, and the equipment required by the individuals and units that make up the functional groups. Potential for change in size over a set period of time (typically two to five years), whether positive or negative, should also

The process of programming seeks to produce quantitative documentation of the spatial needs of an agency, unit, or department by examining the quantitative content of a given environment: its people and equipment.

A brief explanation of the process and goals for programming should be laid out for those involved before the process is begun.

be analyzed as part of this inventory. Project goals and objectives will determine the extent of the effort.

Accurate unit information is critical to effective programming and is typically collected by means of questionnaires, and interviews with key personnel within individual units. The persons to be interviewed should be determined by the client Point of Contact (PoC) and should understand the project goals and objectives.

The PoC must understand the programming procedures in order to facilitate the process. Interviews must be obtained from personnel familiar with all aspects of the unit being programmed to guarantee the reliability of the information.

Use DoD Forms 1450 and 1450-1, Space Requirements Data Forms, to ensure that the program meets current allowable government space standards. These forms are used for space allocation review by both DoD and GSA. Their use during programming is recommended, as these forms may be required for approval by the installation commander.

A schedule of interviews should be set up with all PoC's. Conduct interviews at the site rather than a remote location. A week or two before the interview a questionnaire should be prepared and sent to interviewees. The interviewees should be the designated PoC for the units. The questionnaire should request a detailed inventory of existing space usage for the unit and should be structured to simplify transfer of data to the final format.

Information requested should include the following at a minimum.

- Organizational Structure:
 - departmental mission,
 - organization chart, and
 - relationship to other departments.
- Functional Structure:
 - functions performed,
 - operating schedule,
 - historical and projected staffing, and
 - equipment requirements.

- Assessment of Current Facilities:
 - quantity of space,
 - internal arrangement,
 - accessibility,
 - quality of environment,
 - known code or regulatory deficiencies, and
 - known problem areas.
- Anticipated Changes in Work Methodology.
- Additional Comments.

Analysis

Responses given on the questionnaires should be reviewed during the interview to ensure completeness and accuracy. Typically the interview includes a walking tour of the unit with the interviewee. This gives the interior designer the opportunity to *visually* confirm the data given on the questionnaires.

AR 405-70, *Utilization of Real Property*, "Appendix D", defines requirements for office space and supporting areas. The regulation controls both net and gross area in terms of the following categories. **Office space** is workstation area and associated immediate circulation. Office space is evaluated based on personnel. **Storage space**, as used in this regulation, is space which supports workstations as common areas. It includes such things as common storage, files, and equipment within the office environment. Its size is determined by equipment. **Special space** is space with architectural features significantly different from the office environment. It normally includes conference rooms, computer rooms, classrooms, exhibit and reception areas, cafeteria or break rooms, duplicating rooms, mail rooms, and building maintenance support areas such as warehousing and loading docks. Special space must be justified on the basis of specific mission and site support requirements. Allocations include an allowance for internal circulation. Consult the regulation for specific requirements.

Care should be taken to assign programmed space to the appropriate category, as such assignment may affect the total allowable area. Storage area requirements must be

clearly distinguished from office space, as the two functions are generated differently (personnel vs. equipment), but are found closely integrated within the unit environment.

The numerical data collected during the interviews should be summarized and sent back to the interviewees for verification prior to final summarization and initiation of design. After verification, summaries should be prepared—including growth projections, if this is a consideration. Comments by interviewees should be analyzed and incorporated into the documentation when appropriate.

Once the data on personnel numbers and equipment has been collected, it is extrapolated into volumetric data. This provides the estimated footprint area of the new space to be included in the planning of the facility. Army Regulation 405-70, *Utilization of Real Property*, "Appendix D" provides numerical planning and utilization allowances which should be applied to the quantities determined during the interview process.

After the initial determination of volumetric data using AR 405-70, *Utilization of Real Property*, allowances has been performed, these numbers must be checked. One way to do this is by applying a scaling factor (to account for changes in need, or future growth) to the existing area. If the change from existing to projected requirements is dramatic, it may be necessary to examine both sets of calculations more closely in order to determine which more accurately reflects the needs of the organization. If the organization is a new one, the best check is to reference a similar facility, and apply a scaling factor to account for differences in population, equipment etc. Discrepancies should be resolved at this point before effort is expended in the planning and design process.

General building circulation and support are factored in at 25 percent of the calculated net planned area. The actual percentage may vary depending on several things, primarily the building configuration and the total required area. Circulation percentage for a small organization is typically higher than that for a large one due to the exaggerated ratio of circulation between groups compared to that within. Building configuration

affects plan area directly, as some buildings are more efficient to plan than others. Simple things, such as the distance between mullions on a window wall, will affect the layout of offices, and thereby their size, and ultimately the efficiency of a floor plan. Finally, the limitations of the infrastructure of the building must be considered—allowable loads on structure within storage areas, availability of adequate ventilation for special needs, etc. These factors may affect the area requirements for a given function, if the limits of the building do not meet the standard programmatic guidelines.



Fig. 1 Bubble Diagram

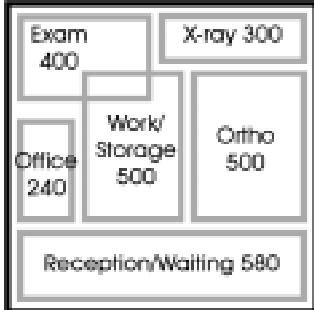

Fig. 2 Blocking Diagram

Space Planning

The area requirements determined through the programming and data development process are used to establish the area requirement for an organization. The areas determined for a collection of organizations which will share a common space are typically arranged as a bubble diagram (Fig. 1). These diagrams indicate the relation of groups to one another. They do not represent a space plan or floor plan, but the relationship of organizations to one another.

A further extension of the initial diagram is a preliminary **blocking diagram** in which the bubble diagram is made more regular and checked for fit inside the proposed floor plan (Fig. 2). The location of various organizations on the floor plan at this time is solely a function of the adjacency requirements brought to light during the interview portion of the programming process. It is the designer’s task to arrange these groups in such a way as to maximize the required adjacencies. If the project includes planning for a multi-floor facility the data should be interpreted into blocking and **stacking diagrams** which show the organization being studied and three dimensional adjacencies, where each unit is represented by a volume of space as quantified by the program data.

Once the area requirements of an organization have been assessed through programming, and the relative position has been determined through the review of blocking and stacking diagrams, the actual configuration of the group is developed through the planning of the proximity and

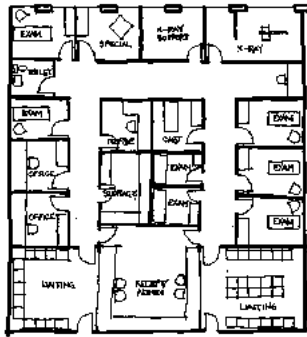

Fig. 3 Final Plan

area requirements within the organization (Fig. 3). Here the primary concern in the planning of the space should be the corporate culture of the entity; how the organization operates, its management structure, and means of organizing around a project.

A successful plan must embody the answers to the following questions about the organization. Is the organization relatively fixed or do its people tend to flow with projects? Is managerial structure flat or hierarchical? What statement is being made through planning about the relationship between management and staff? It is often possible for a design professional to recommend alternative structures to enhance the operation of a particular organization, but if a structure is not compatible with the organization, its implementation will either force a shift in the mode of operation, or the plan will fail.

Office plans may be designed around the concept of **open office** space or **private office** space. Open office plans are common for working level persons in large, open areas and offer flexibility. Private office space plans are limited primarily to executive offices. In most cases, plans will be a mixture of a large open office area and a few private offices. Open office plans use systems furniture to define workstation and other spaces. Private offices are defined by fixed walls. Arriving at the appropriate solution requires an examination of the operation's organization and its culture.

Culture within the work place is not that much different from what we understand as culture on a geographic basis. Different work environments communicate, cooperate, and are managed in different ways. Corporate environments are microcosms of larger geopolitical cultures.

The culture of an organization is characterized by its work processes, methods of communication, and organizational structure; and is expressed through the design of its environment. The organization of work areas has much to do with the operation of the various functions and the interrelation of the parts. Work environments may be classified into the following groups:

- **Individual** space is provided for individual workstations and generally configured as office space. It may be either private or open. Individual workstations must consider surface work area, storage, security, communication, equipment, and privacy requirements that support individual work independent of other group activity.

- **Team space** may be defined as a collection of individual workstations and an area for common activity. A team room may also be created as a special use space to accommodate work on a common project as well as storage of project materials. Formal team rooms are generally not provided in government offices.

- **Informal group space** is a common support space which supports informal interaction among persons from multiple organizational units. These are areas where people have chance encounters and can include the coffee pot, reception areas, copier areas, and other possibilities.

- **Formal group space** means special purpose space dedicated for conference rooms or other places where people will assemble.

Alternative Officing refers to alternatives to dedicated office work space allocated on an individual basis, as opposed to traditional officing which involves a single location commuted to from the home and worked at on a regular basis.

Most offices will have a mixture of the environments listed above. Ownership or territoriality is a primary feature of any office plan. Traditional officing assumes that each individual will have a unique work space to which he or she is assigned on a permanent basis. **Alternative officing** acknowledges that workspace requirements are not static, and allows for a more dynamic allocation of resources based upon immediate needs. In alternative officing programs, a set of typical work spaces are developed which are then assigned on a needs basis.

Hybrid environments seek to optimize a mixture of work arrangements and ownership, in which each of these factors is satisfied separately. Component parts of workspaces which are necessary, but which do not need to be dedicated—such as conferencing areas in private offices—may be separated from the core function and shared among a group of individuals, thereby lowering the aggregate area requirements of the group. Many alternative officing solutions are centered around specialized furniture products intended to facilitate some particular aspect of work, others take advantage of changing work philosophies and technologies such as home officing or telecommuting.

Hoteling is an alternative officing solution which provides workspace for individuals who are not always in the office, but need to be accommodated when they are. Worker-to-workspace ratios in excess of one-to-one

are established which recognize the actual vacancy ratio within the organization, and typical workstations are established which may be used by any individual on an on-call basis. Other officing solutions recognize the need for both private work areas and team areas, but provide them as individual entities: offices do not have conference areas within them, but are drawn down to the minimum size necessary for the individual; shared conference areas are scattered throughout the plan.

The person planning the work environment should be well-versed in current planning philosophies and options. Most plans utilize a mixture of the four space types described above. Design solutions evolve as variations on basic concepts are refined for specific uses. By application of the general concepts to specific functional, organizational, and cultural requirements; a satisfactory solution can be identified.

Layout

In planning the individual organization the detailed information gathered during the initial programming process is employed. The entire process of developing bubble diagrams and then blocking diagrams is replayed at a more detailed level than before. Detailed workstation types and workstation clusters are developed and arranged to test their fit within the blocking diagram. Circulation and building modules (window mullions, lighting and power grids, and structural bay widths) must be strictly observed at this time.

Typically, a generic workstation unit or office is developed and tested against the user's stated program of requirements. Layout of the individual work areas begins with a detailed assessment of the individual work surface and storage requirements. As the floor area is largely determined by the target average area per individual, much of the variation in individual workstation requirements will be made up in the outfitting of the workstation proper. Generic group spaces which reflect the operations of the specific functional area should also be developed. These are then used to perform an initial layout of detailed spaces.

A series of uniform footprint workstations should be developed which satisfy the needs of the majority of the individuals. These may need to be created for a new organization or an organization which is moving into a new type of environment, or they may be refined from existing, when the unit is an established one simply undergoing a re-organization or move. Individualization of the workstations can be done on a case-by-case basis. By establishing pattern workstations, the planning of the organization's area is simplified, and future re-organization of individual positions is eased. With standardized workstations, people can move without having to move furniture. The cost and time involved in reconfiguring fixed walls and systems furniture make the use of workstations, typical in size and components, the most efficient way to manage the movement and changing needs of workers.

Circulation is as critical to the success of a floor plan as the layout of the individual and group workstations. Circulation must be clearly planned from point of access to end point so that residents or guests will be able to discern their paths easily. A hierarchy of widths aids in determining volume of traffic flow, and routes should be direct and visibly identifiable from any point. Egress distances and accessibility by the physically handicapped must be considered when laying out circulation paths. Within a given administrative unit, circulation is not merely definition of a boundary between organizational clusters, it must be fully functional and reflect the interrelation of the units.

Design Coordination

The direction for development of a space should be set and approved prior to the final planning and layout of the individual workstations. The development of a space is paralleled by development of its color scheme and interior finishes. In a new facility, fewer parameters influence the direction of the design. Once the initial direction is set, the designer selects items which fulfill the design intent. In existing facilities, additional factors—such as existing furniture which must be reused, and surrounding areas which must be integrated— will constrain the design direction. In either

case, materials and finishes should be chosen which harmonize with one another, and which do not date the project.

Typically, individual users understand only their own environment and may not realize the impact their portion of the project has on the overall concept. The designer must maintain a global view, within the context of the project, and further within the organization as a whole. Projects afford the designer the opportunity to express a current design interest or the personality of a specific client/user. The design intent, however, is to provide a solution which satisfies the needs of the user, provides an appropriate aesthetic expression, and will be maintainable over a period of time. The solution must also integrate well into the greater fabric of the organizational environment.

Documentation

Proper documentation of furniture-related interior design is more detailed than that required for building-related interior design work. Building-related interior design is typically fully-integrated within the architectural portion of the construction documents. The information required to communicate the intent of the design becomes a part of the architectural drawings, schedules and specifications. The interior designer is primarily responsible for ensuring that the design intent is properly conveyed.

Furniture-related interior design documentation may be either a stand-alone document developed after the building components are in place as is often the case for a simple remodel; or it may be a part of the overall set of construction and bid documents for a new construction project or extensive remodel.

Systems furniture and equipment must be located just as accurately as any other element of the project, and except for large homogeneous organizations, more detail is required per unit of area for systems furniture layout than for typical architectural construction. Documentation procedures vary, but plans should always be broken down into several related documents which separately convey the general location of individual workstations, then into successively smaller details

ranging from structure of the work space, to components of the work space, to accessories, to data, power and communications. Where repetition is significant, notes on the drawings may be used to take advantage of duplicate elements. The documentation must be thoroughly checked for accuracy and completeness, particularly with regard to rotated and mirrored versions of prototypical units.

Implementation and Move-in

While the user has the primary responsibility for implementation and move-in, the designer's responsibility is to advise on reuse of existing furniture, provide technical expertise in the review of furniture solicitations, and participate in the presentation of the plan to the organization. Even after the design is complete and documented, significant work and coordination must be done to complete the process and make the move successful.

The designer's role in this process is one of quality assurance, reviewing the product and seeing that it satisfies the intent. During implementation and move in, this will involve acting directly with the contractor, suppliers, installers, and the user; although perhaps the majority of contact will be with the contracting office, for furniture procurement.

Interaction with the contractor on building-related interior design involves providing clarification of intent prior to action and interpretation of results relative to design intent. Complete and thorough documentation is critical, but so is a watchful eye on the part of the designer.

Furniture-related interior design services typically involve placing all relevant procurement information on procurement forms, tracking, inspection, assembly, and placement, and tends to be a more involved process. The user may require considerable assistance to complete these operations. The designer needs to be certain that the user understands the key tasks involved:

- verifying funding,
- scheduling,
- placing orders,

- tracking shipments,
- accepting/inspecting deliveries and filing claims,
- warehousing,
- installation and coordination of furniture items,
- installation and coordination of electrical and data systems,
- warranties,
- moving existing property to new facilities, and
- excessing redundant property.

Follow-through is essential. Many items will need to be verified repeatedly in order to ensure that the provider meets the needs of the user, particularly with regard to schedule. During the final installation and move-in, the number of things happening at once can be overwhelming for the user. An implementation plan is essential to keep the process on schedule. Assigning the proper person to be in charge of the move is also a critical factor the success of the project.

Even after installation and move-in, issues may require the attention of the interior designer. Maintenance is an issue which dramatically impacts upon the appearance of a facility. An interior designer can assist by recommending the establishment of an operations policy to guide in the maintenance of facility appearance. The designer has little say, however, as to whether the policy is implemented and, if so, how successfully. Such a policy must have strong user/command support to assure successful implementation.

A post-occupancy evaluation allows both the user and the designer to learn from their experiences. The evaluation also affords the opportunity to see where modifications to the facility would assure better solutions in future work. These opportunities provide designers with some of the most potent feedback on their efforts and help both designer and user grow in their understanding of what is needed to create a truly excellent interior.



Glossary



Glossary

ABS, (acrylonitrile, butadiene, styrene), a tough, lightweight, highly moldable plastic compound especially suited to fitted parts and interlocking components; major uses include modular furniture, luggage, and plumbing systems.

absorption, the assimilation of sound energy by a body without recoil or echo.

accent lighting, direct lighting to emphasize a particular object or draw attention to a part of the field of view.

accent, to enhance decoration by using a lesser quantity of a contrasting color or finish.

acetate, a manufactured fiber formed of cellulose acetate, characterized by low cost, sunlight resistance, flame retardance, resistance to moths, mildew, and bacteria, low static electric potential, and low abrasion resistance.

achromatic, a neutral color, lacking in chroma or intensity: black, white, or gray.

acoustic tile, modular sound absorptive panels.

acrylic, a synthetic fiber of moderate tenacity, resistance to abrasion and light, and dimensional stability.

aesthetic, pertaining to an object's quality of beauty.

aggregate, the sum of a collection of particulars.

ambient lighting, general environmental illumination.

ampere, a unit of electric current equal to the current of one Volt acting through a resistance of one Ohm.

amplification, the effect of color intensification due to the interreflection of light from one colored surface to another. An increase in the volume of sound.

angle of incidence, the angle (measured from the surface on the side of the approach) at which an element strikes an object.

anneal, the process of strengthening through heating and gradual cooling.

ANSI, (American National Standards Institute), a private sector standards coordinating center which helps identify and coordinate private sector standards activities and standards development.

anthropometrics, the measurement of the size and proportions of the human body, and its applications to the design of furnishings, equipment, and spaces.

antimicrobial treatment, a treatment that prevents the growth of mold, mildew, and bacteria on carpet.

appurtenance, a subordinate part or accessory.

ASA, (acrylonitrile, styrene, acrylic elastomer), a plastic compound with properties similar to those of ABS.

Axminster, a patterned, woven carpet originating in the 1700s in Axminster, England in which almost all of the pile yarns appear on the surface, and are of one height.

barrier-free design, that which presents no physical barriers to access and free movement within an environment.

bay window, a window set in a frame projecting outward from a wall to create an interior recess, usually of fixed glass.

bay, a volumetric or structural unit defined by columns or walls.

berber, a carpet texture characterized by broad, short loops which give a popcorn-like appearance.

bifold door, a door with vertical double panels that folds back against itself.

binder, a substance which brings cohesion to a collection of elements.

biodegradable, capable of being broken down into innocuous products through biological processes.

blossom, the tendency of a looped yarn to untwist when cut.

board-and-batten construction, a type of wall treatment in which wide vertical boards are sealed at their junctures by narrow strips of wood, or battens.

bonded fabric, a fabric formed by combining an outer face fabric with a backing fabric using an adhesive or laminate.

bow window, a bay window in the form of an unbroken curve.

brick, a clay block hardened by heat and used as a building unit.

broadloom, floor textiles woven on looms more than about 1 meter (36 inches) wide.

brush, to add a fine texture to a surface by means of a wire or bristle brush.

bubble diagram, an initial planning sketch in which clustered circles represent activity zones placed in proximity relationships.

came, the channeled element used between pieces of glass in stained glass or leaded windows, or to divide cast-in-place terrazzo.

cantilever, any part of a structural member (commonly a beam), that projects beyond its support.

card, to combine staple fibers, such as wool or cotton into a continuous filament.

carpet, a soft-surface floor covering used to blanket a floor from wall to wall.

casegoods, furniture which is typically freestanding and capable of supporting or storing smaller materials: desks, credenzas, bookcases, files, storage cabinets, beds, dressers, and tables.

casement, a loosely woven or knit sheer drapery fabric.

casement window, a window hinged at the side, and which swings open like a door.

cathode, the terminal from which electrons emanate in a fluorescent or other discharge-type lamp.

ceramic, made from clay and heated (fired) in a kiln. A hard and durable material.

chromaticity, the aspect of a color that describes its dominant wavelength and purity

clapboard, a wood siding composed of narrow boards each with one thinner edge to facilitate horizontal overlapping.

cleft, split as with a blow.

clerestory, a window or bank of windows inserted between two roof levels to bring light into a room.

closed plan, an architectural plan that divides the internal space of a structure into separate, discrete rooms.

coefficient of utilization, (cu), the ratio of light (lumens) from a luminaire received on a workplane to that emitted by the lamp.

coffered ceiling, one with ornamental raised panels between closely spaced beams.

color fastness, the ability of a material to retain its color when exposed to light or cleaning agents.

color rendering index, the general expression for the effect of a light source on the color appearance of objects in comparison with their color appearance under a referenced light source.

color retention, the ability of a material to retain its color when exposed to light or cleaning agents.

color spectrum, the range of color comprising visible light.

compact fluorescent, an energy-saving replacement for incandescent sources, with greater efficiency and life.

concrete, a material consisting of cement mixed in varying proportions with sand and gravel or other aggregates. With the addition of water, the mixture becomes moldable, capable of assuming almost any shape. Concrete dries to a heavy, stonelike mass of great strength.

concrete blocks, large, generally hollow, bricklike blocks composed of concrete; widely used in building, especially for walls.

conduction, the direct transfer of heat through a solid material, such as glass or metal.

conduit, a tube used to protect electrical wires.

construction documents, the full volume of drawings, specifications and contracts which comprise the complete description of a built project.

contract, a legally binding, written agreement between two parties outlining services to be rendered, responsibilities, and compensation.

contract design, nonresidential interior design, including offices, institutions (healthcare, schools), hospitality, industrial facilities, and retail businesses.

convection, the transfer of heat through natural air circulation.

cotton, a natural staple fiber harvested from the flower of the cotton plant.

cove lighting, that provided by light sources shielded by a ledge and distributing light upward over the ceiling.

coved ceiling, a ceiling that curves into the supporting walls rather than meeting them at an angle.

critical path, the time frame and overlapping order of steps in the building and finishing process which determines the minimum time or necessary progression required for an event.

cut pile, a fabric or carpet, the face of which is composed of cut ends of pile yarn.

decibel, (dB, db), a unit for expressing the relative intensity of sounds on a scale from zero for the least perceptible sound to about 130 for the average pain level.

decorative design, the additional arrangement, shaping, coloring, or placing of ornament to make an object or space more beautiful or interesting to the eye.

delaminate, to come apart in layers.

density, a factor used to judge the quality of carpet; the amount of surface yarns compressed in a given area. The closer the pile tufts are to each other, and the higher and heavier the pile yarn, the more durable the carpet within the same fiber category.

design, the process of planning a building, furnishings, or composite interiors; the organization of a work of interior design, architecture or art.

design concept, the idea for the solution to a design problem.

detail drawing, a drawing, commonly full size or on a scale two or three times greater than that of the general drawings, showing specific composition of an object to be built, or part of it.

diffusion, the random dispersion or scattering of a sound or light wave when it strikes a surface that is irregular, concave, or convex in form; or when the wave form is not in line with, or not equal in size to, the object struck, the wavelength will tend to bend around the object and continue on its path.

dimensional stability, the property of a material which indicates its resistance to change in size due to affecting conditions, such as temperature or humidity.

dimmer, a device used to control the intensity of light emitted by a luminaire through the control of the voltage or current available to it.

direct glare, the result of areas of excessive contrast (such as insufficiently shielded light sources) in the direct field of view.

direct lighting, that provided on the workplane or object from a prominent and identifiable source.

double-glazing, a process of providing windows with two sheets of glass sealed together trapping air or a vacuum between them to provide superior thermal insulation.

downlight, a luminaire from which light emanates downward; may be recessed, surface or pendant mounted.

draperiy, a loosely hung, often heavy, fabric curtain.

drapery panel, a drapery length made of one or more widths of fabric that travel together on a rod.

draw curtain, a fabric panel that can be opened and closed by means of a draw cord on a traverse rod.

dropped ceiling, that portion of a ceiling below the actual functional level or below other sections of the ceiling within the same space. Often, a dropped ceiling serves to articulate specific segments of a room such as a dining area, or to accommodate mechanical equipment.

ecology, the study of the relationship between organisms and their environment.

efficacy, the measure of the effectiveness of a solution; the ratio of light emitted by a lamp to the electrical power input, usually expressed in lumens per watt.

effluent, something that flows out.

egress, a means of exiting.

elevation, a drawing which represents a vertical image of one side of an object, room or building.

emulsion, a combination of two non-compatible liquids, such as oil and water.

engineered wood product, any recombination of wood by-products to form a material of greater performance capacity than the original (see also industrial board).

ergofit, the relationship between people and their environment.

ergonomics, the science that seeks to adapt the environment to its users.

etch, to remove through corrosive action.

fabric, cloth; more specifically, a construction of fibers, not necessarily woven.

facade, the face or front of a building or article.

felt, the joining of fibers into a fabric through the application of heat, agitation and moisture, or by mechanical treatment.

fenestration, the arrangement and design of windows and other openings of a building.

fiber, a material of natural or synthetic derivation capable of forming a continuous filament, such as yarn or thread.

fiberglass, any number of plastic resins, such as polyesters, polypropylene, or nylon, reinforced with segments of glass fibers.

fiberoptics, the transmission of signals as pulses of light through an optical conductor, such as glass cord.

filament, a single continuous strand of fiber.

finish floor, the final visible flooring material or surface.

firebrick, a very hard brick capable of withstanding the intense heat of a kiln or fireplace interior.

flamed, a granite finish produced by passing a flame over the face of a piece of granite, causing it to spall off its outer surface.

flame-resistant fabric, a fabric whose fiber content or topical finish makes it difficult to ignite, slow to burn, and often self-extinguishing.

flame-retardant finish, a chemical finish that renders a fabric made of a flammable fiber resistant to fire ignition and spread.

flat slice, a method of cutting a log parallel to a plane through its center which produces a vaulted or cathedral-like grain.

flax, a plant fiber used in the manufacture of linen yarn.

flood lamp, a lamp providing a relatively wide light distribution pattern.

floor plan, a drawing that represents the horizontal arrangement of building parts and furnishings.

fluorescent lamp, a low-pressure mercury electric-discharge lamp in which a fluorescent coating (phosphor) transforms ultraviolet energy into visible light.

flux, the flow of light or the measure of the flow of electric charge in a wire.

footcandle, (fc), a unit of illuminance on a surface equal to that produced by the light of one candle at a distance of one foot.

fray, to wear by rubbing; to release from a woven fabric.

fuse, to bond together through chemical or thermal action.

galvanized iron, iron coated with zinc as a means of retarding rust.

general lighting, that which provides a substantially uniform level of illumination throughout an area, exclusive of any provision for special local requirements.

glare, any brightness or brightness relationship that annoys, distracts or reduces visibility.

glass, a mixture of silicates, alkalis, and lime that is extremely moldable when heated to high temperatures, permitting blown, molded, pressed, and stretched forms, and which cools to a rigid, nonabsorbent, transparent or translucent substance.

glass blocks, brick-like forms of glass available in a variety of shapes and sizes. They can be set together or joined to other materials with mortar.

glaze, protective and/or decorative glass-like coating formed on the surface of a ceramic piece by firing.

grazing, light directed at a very steep angle to a surface, emphasizing its texture.

hammered, a metal or stone finish produced by direct blows of a hammer on the material surface, or a finish giving the appearance thereof.

hand, the textural feel of a fabric.

hardboard, a mat-formed flat panel consisting of particles of wood bonded together with a synthetic resin or other suitable binder.

hard-wire, to permanently connect to an electrical source; as opposed to plug-in.

header, a horizontal structural member which serves to tie vertical members together at the top of an element.

holistic, emphasizing the relationship between the whole and its parts, and that the whole is greater than the mere sum of its parts.

homogeneous, of uniform make-up throughout the extent of a body.

honed, a medium to coarse stone finish produced by abrasion of a cut face.

hue, the attribute of perceived color which determines its position in the color spectrum.

hydrophobic fibers, those which resist water-borne soiling.

IESNA, (Illuminating Engineering Society of North America), the recognized technical authority for the illumination field. The society's objective is to communicate information on all aspects of good lighting practice to its members, the lighting community and consumers through a variety of programs, publications and services.

illuminance, the density of light falling upon a surface, the units of which are the lux and footcandle.

incandescent filament lamp, (bulb), a lamp in which light is produced by a filament heated to incandescence by an electric current.

incident, falling upon or striking.

indirect lighting, that provided by luminaries which distribute 90-100 percent of their emitted light first onto a reflective surface such as a ceiling or wall.

industrial board, any of a number of engineered wood products commonly used in the manufacturing of furniture and casegoods.

ingress, the way in or entrance.

insulation, the prevention, by means of certain materials, of an excessive transfer of electricity, heat, cold or sound between the inside and the outside of a structure or between portions of a structure; also, the materials themselves.

jacquard weave, a fabric of complex pattern, such as tapestry or brocade, produced on the Jacquard loom.

jalousie window, adjustable, louvered window units of narrow, glass, plastic or wood slats, most often arranged horizontally.

junction box, a protective housing for the joining of electrical connections.

Kelvin, (K), relating to the thermometric scale in which the unit of measurement equals the centigrade degree and according to which absolute zero, the temperature at which all atomic activity ceases, and the equivalent of -273.16° Celsius is 0° Kelvin.

Kelvin temperature, (K), represents the relative whiteness of a light source; whether the source appears warm, cool, or neutral. The higher the temperature, the cooler the appearance of the source. The Kelvin temperature assigned is that of a unit black body radiator heated to the same whiteness.

kilim, a hand-woven, flat, reversible tapestry rug traditionally made of wool.

lacquer, a family of fast drying resin or synthetic finishes capable of being polished to a high gloss sheen.

lamine, the process of bonding together, thin sheets or small pieces of material to create a substance having properties the material would not otherwise possess, such as strength, durability or intricate form.

lamp, a generic term for a man-made source of light.

lath, a framework of thin wood or metal ribs integral with a building skeleton for the support of tile, plaster, reinforced concrete, plastic forms, or the like.

LeCorbusier, considered by many as the father of the Modern Movement in architecture. LeCorbusier (Corbu, Corb) practiced architecture throughout Europe in the first half of the twentieth century.

letter of agreement, a legal contractual agreement between two parties that describes the obligations and responsibilities of each.

level loop, a carpet style having all tufts in a loop form and of identical height; may be woven or tufted.

life-cycle cost, the initial cost of a product (including installation) plus the cost of maintenance or operation over its useful life.

lumen, a unit of light flow equal to the light emitted into a unit solid angle by a uniform point source of one candle.

luminaire, a complete lighting unit consisting of a lamp, or lamps, together with parts designed to distribute the light, to position and protect the lamps, and to connect the lamps to the power supply; a ceiling or wall mounted light fixture, or a portable lamp.

luminance, (photometric brightness), the luminous intensity of any surface in a given direction per unit area of that surface as viewed from that direction. All things visible have some luminance. Luminance is measured in candelas per square meter (candelas per square foot, or footlamberts).

luminance ratio, an expression of the relative brightness of any two areas in the visual field.

masonry, architectural construction of stone, brick, tile, concrete block, or glass block joined together with mortar; in broader usage, construction of plaster or concrete.

mastic, originally a resin used in the production of adhesives, now commonly the generic term for flooring adhesives.

matte, a flat, non-shiny finish which thoroughly diffuses incident light.

medium density fiberboard, (MDF), a fine-grained smooth faced industrial board product, composed of wood fiber and adhesives. Easily cut, worked and finished.

medullary rays, capillary-like structures within the body of a tree that run radially from the core to the bark and their expression in quarter-sawn lumber.

metamerism, the shift in visual appearance of colors under varied illumination.

metamers, lights of the same apparent color but of different spectral energy.

microbial, relating to micro-organisms such as bacteria.

microblind, horizontal blinds with 13 mm (1/2") slats; also called micro-miniblinds.

miniblinds, horizontal blinds with 25 mm (1") slats.

modacrylic, synthetic fiber that is highly flame resistant and bulky. It has moderate resiliency, moderate dimensional stability, and high elastic recovery. It also has a low melting point and low abrasion resistance.

modular, built of unit pieces or according to standardized sets of measurements.

module, one of a series of units designed and scaled to integrate with others in different combinations to form, for example, a set of furnishings, a system of construction, or whole buildings. In current usage, the term is most often applied to mass-produced prefabricated units.

mohair, a specialty wool fiber. The most resilient of all natural fibers, strong, and possessing a good affinity for dyes.

molding, an ornamental strip of wood or plaster that protrudes from a ceiling or wall surface.

monolithic construction, a system in which the major part of a structure consists of a single, self-supporting mass, usually of reinforced concrete, plastic or fiberglass.

mortar, cement, lime or plaster combined with sand and water. When wet, the substance is moldable; it hardens to form the binding agent of masonry construction.

Munsell color system, a system of object color specification based on perceptually uniform color scaled for the three variables: hue, value and chroma.

needle-punched fabric/needle felt, a nonwoven fabric in which webs of fibers are closely entangled by the action of hundreds of barbed needles.

nonwoven fabric, a fabric which is either fibrous, but not made in a loom, or non-fibrous, made directly from a solution. See needle-punched and spunbonded fabric.

nylon, the generic term (as well as trade name) for a family of plastics exhibiting high tensile strength in fiber or sheet form. It has excellent abrasion resistance, and resiliency, retains appearance well. Fiber modifications are antistatic, anti-soil, sunlight resistant, and flame retardant.

olefin, a plastic used for fiber and container manufacturing. Advantages of olefin fibers include good abrasion resistance, tenacity, excellent resiliency, good dimensional stability, static resistant, and excellent resistance to most chemicals. It resists mildew and stains. Fiber modifications contribute to heat and light stabilization. Often referred to as polypropylene.

open plan, an architectural plan organized with few fixed partitions; provides maximum flexibility in the use of interior space.

orientation, arrangement, alignment, or position in relation to other factors or elements.

oriented strand board, an industrial board product composed of wood chips created and bound specifically to take advantage of their non-homogeneous nature to produce a product with specific structural properties.

OSHA, (Occupational Safety and Health Administration), a federal regulatory agency in the U.S. Department of Labor with responsibilities of establishing occupational safety and health standards, conducting inspections to see if standards are being observed, and initiating enforcement actions whenever an employer is not in compliance with these standards.

oxidation, a chemical process by which one material combines with oxygen to form a second (iron oxidizes to form rust).

paneling, thin, flat wooden boards or other similarly rectangular pieces of construction material joined side by side to form an interior decorative surface for walls or ceilings.

parquetry, inlay of wood that takes the form of geometric patterns; used primarily for floors and sometimes for tabletops.

particleboard, a mat-formed flat panel consisting of particles of wood bonded together with a synthetic resin or other suitable binder.

partition, a non-loadbearing subordinate wall between two piers or other supporting members.

passive solar heating system, a technique of solar heating that uses parts of the building structure to collect, store and distribute solar heat without pumps or fans.

patina, the sheen, color and texture of an object, produced by age, use, waxing, or design. On metal, patina is the film that develops from long exposure to the atmosphere.

pattern, an artistic, decorative, usually repetitive design.

perceived object color, the color perceived to belong to an object, resulting from characteristics of the object, the incident light, the surround, the viewing direction, and observer adaptation.

perspective, a system of realistic pictorial representation of objects and spaces in relative distance or depth. The optical effects perceived in viewing objects over a distance.

pile, the visible wear surface of carpet, consisting of yarn tufts in loop and/or cut configuration; also called face or nap.

pile weave, a fabric construction in which cut or uncut loops protrude from the ground cloth.

pile yarn, a yarn which forms the tuft of carpet; also called face yarn.

pill, the tendency of staple fibers to be shed from some fabrics and to form small tufts or balls on the face of the fabric.

plain slice, a method of cutting a log parallel to a plane through its center which produces a vaulted or cathedral-like grain.

plan, the configuration of spaces and rooms, walls and openings in an architectural structure; also, the graphic representation of such an arrangement.

plane, a two-dimensional expanse; a flat surface.

plaster, a paste, usually of lime, sand, and water, which hardens as it dries. Often used as a finish for interior wall and ceiling surfaces.

plastic, a malleable, ductile material. More specifically, a member of any of the several families of synthetic polymer substances.

plenum, that space between ceiling and structure where mechanical and electrical components are typically run. In some instances the plenum itself may serve as a sort of superduct for air returning to the mechanical system from the volume beneath the ceiling.

plumbing, the system of pipes which carries water and sewage within a building.

plush carpet, a smooth carpet surface texture in which individual tufts are minimally visible and the overall effect is that of a single level of fiber ends.

ply, a single thickness, layer or strand.

plywood, a composite sheet of laminated veneers, some or all of which are made of wood, with the grain of adjacent strata arranged at perpendicular angles for increased strength.

pocket door, a door that opens by sliding into a pocket.

polished, smooth and glossy.

polyester, a synthetic fiber with excellent strength, good abrasion resistance, and which resists wrinkling. Characterized by permanent body. Fiber modifications contribute to pill resistance, antistatic, and flame retardancy.

polyethylene, a group of lightweight, flexible plastics characterized by a waxy surface and resistance to chemicals and moisture but not high temperatures.

polypropylene, a family of plastics which are resistant to water-borne but not oil-borne staining.

polystyrenes, a family of rigid, transparent-to-opaque plastics that are durable, capable of accepting varied finishes, and possessed of good insulation properties.

porcelain, high-grade, translucent white ceramicware fired at extremely high temperatures; most common in fine dishes and ornaments, but having many industrial applications, such as plumbing fixtures electrical insulators, and tiles.

portable luminaire, table or floor lamp, or wall unit, which is not permanently connected to the electrical power supply.

prefabricate, to mass-produce standardized construction parts or modules for later assembly and/or combination.

primary backing, a component of tufted carpet consisting of woven or nonwoven fabric into which pile weave tufts are inserted by the tufting needles.

primer, a coating that is applied before any other finish treatment to seal the pores in or otherwise prepare a surface to be treated.

printing, as applied to textiles (fabric, carpet, etc.), the application of dyes according to a selective pattern to create a design by such methods as woodcut, silk screen, tie-dye, or injection.

problem statement, a brief statement identifying a design project according to its purpose, location and client.

programming, the research phase of design which determines the objectives and requirements of a design project.

proportion, the relation of parts to each other or to the whole in terms of magnitude, quantity, or degree.

proxemics, the study of human interaction with space and of personal and cultural spatial needs.

PVC, (polyvinyl chloride), a tough, moldable thermoplastic used in the manufacture of plumbing pipes and furniture.

quality of lighting, distribution of luminance in a visual environment with regard to visual performance, visual comfort, ease of seeing, safety and aesthetics for the specific visual tasks involved.

rag rug, a plain weave rug woven with strips of fabric, historically rags or recycled clothing remnants.

ravel, to untwist or unweave.

rayon, a natural fiber made from cellulose which has been chemically prepared. Soft hand, high moisture regain, smooth and soft fibers, good conductor of heat and static. Accepts durable press and dimensional stability finishes. Disadvantages include poor resiliency, progressive shrinkage, and weakness, especially when wet.

reflectance, the ratio of the light reflected by a surface or medium to the light incident upon it.

reflected glare, results from specular reflections of high contrast from polished or glossy surfaces in the field of view.

reflection, the process by which light or sound leaves a surface from the incident side.

refraction, the change in direction or propagation of a sound or light wave due to a change in the velocity occurring when a change in materials, a thermal gradient or a wind velocity gradient is encountered.

regain, a measure of the recovery of moisture lost to the atmosphere through drying.

reinforced concrete, concrete embedded before hardening with steel rods that lend the material a tensile strength far beyond its original capacity.

rendering, a pictorial representation of a proposed design, usual in perspective and full color.

renovate, to restore condition by rebuilding, repairing or cleaning.

restore, to renew or return to an original state or condition.

retrofit, to fit with new parts or equipment not available at the time of initial construction or production.

reverberation, a sound effect similar to that of a continuous echo.

rheostat, a device used to control the intensity of light emitted by a luminaire through control of the voltage or current available to it.

riser, the individual vertical faces of a stair. The collection of ducts or pipes which provide vertical transport of air or water through a building.

r-value, the thermal resistance of a material. A higher r-value indicates greater resistance.

rya rug, a deep shag-like rug handknotted with abstract, contemporary patterns, from Scandinavia.

sandblast, abrasive cleaning with sand moved by an air jet.

sash curtain, a semi-sheer fabric gathered or shirred onto rods at top and bottom and hung onto a window sash.

scale, dimension relative to a standard or to a familiar reference.

schedule, a table that indicates the finish material used on floors, walls, and ceilings, or lists types of doors and windows.

schematic design drawings, quick initial drawings used to generate or show ideas.

seasoning, to bring to the proper state for use, as in seasoning wood by drying.

secondary backing, a woven or nonwoven fabric reinforcement laminated to the back of tufted carpet for added strength and stability.

shade, a low-value or dark color produced by adding black to a hue. A cover for window or lamp to control light distribution.

silk, the only natural continuous filament fiber. Silk fiber is harvested from the cocoon of the silk worm. Silk fabric is highly valued for its strength, hand and luster.

simultaneous contrast, the accentuation of differences between the hue, value, and intensity of colors due to adjacent or background colors.

sisal, a natural plant fiber; smooth, straight, and yellow. May be used by itself or in blends with wool and acrylic for a softer bond. Sisal is used in wall coverings, especially in heavy-duty commercial applications because of its durability and ease of application to a variety of surfaces.

soffit, a dropped horizontal surface.

space plan, a drawing which shows the arrangement of functional elements within an area.

space planning, the functional planning of interior space; a design specialty which concentrates on establishing space needs and utilization in the early stages of design.

spall, the breaking away of a surface due to mechanical action within the material itself such as thermal expansion.

specification, the criteria of minimum durability, cost and safety requirements of finished materials; all of the information necessary for the construction of custom-made items.

specular angle, that angle between the perpendicular surface and the reflected ray. It is numerically equal to the angle of incidence.

specular reflection, that process by which incident flux is redirected without diffusion.

specular surface, shiny or glossy surface (including mirror and polished metals) from which the reflection is predominantly specular.

spunbonded, fabric manufactured by a nonwoven method in which fibers are deployed in a near-random fashion and bound by chemical or thermal means.

spunlaced, see spunbonded.

standpipe, station pipe for use by a fire department to allow connection of a pumper truck to the outside of a building for delivery of water to hose stations on the interior of the building.

stipple, to decorate by repeated touching as in dots.

structural plan, a drawing, the primary purpose of which is to show the means of supporting a thing.

substrate, the underlying or supporting layer.

surface-mounted unit, a luminaire mounted directly on the ceiling.

temper, to harden a material (metal or glass) through a specific process of heating and cooling, thereby releasing internal stresses created during the forming process.

tenacity, resistance to tearing.

tensile strength, the capacity to resist breaking or tearing apart under longitudinal stress.

terrazzo, a polished concrete flooring traditionally made of crushed marble and cement.

textile, a fiber construction; technically, a woven fabric.

texture, tactile surface quality, perceived directly through touch or indirectly through vision.

thermoplastic, a material that softens with application of heat and hardens again when cooled.

thermoset, an irreversible property of a substance that is attained by application of heat to change the chemistry of the substance, thereby making it firm.

tile, stone, concrete, or ceramic pieces, flattened and/or curved, used for roofing as well as wall, ceiling and floor covering. Also, thin modules of cork, vinyl, or other resilient material used primarily to protect and enhance interior walls, floors, and ceilings.

tip-shear carpet, a carpet texture created by shearing either level loop or high-low loop carpet lightly so that only the higher filaments within the loops are sheared.

torchere, an indirect floor lamp directing all, or nearly all, of the luminous flux upward.

track, an electrical raceway permitting the flexible use and placement of various types of luminaries along its length.

transformer, an electrical device for converting electrical potential.

translucent, able to transmit light, but not form.

traverse rod, a rod that uses carriers, pulleys, and cords to draw draperies open and closed.

tread, the individual run, or horizontal distance from the face of one riser to the next, in a flight of stairs

trevira, a polyester in which resistance to matting and crushing has been enhanced by autoclaving or heat setting the fibers.

tuft bind, a measure of the effort required to remove a carpet tuft from its primary backing.

tufting, a method of carpet construction which utilizes hundreds of needles to push pile yarns through a previously constructed primary backing sheet, forming loops or tufts of yarn which may be left uncut, cut, or selectively sheared to form a variety of surface textures, or by which high-low loops and sculptured effects can be created.

twisting, the winding of two or more strands of fiber or yarn together to make a single multiple-ply yarn.

UBC, (Uniform Building Code), a set of specifications prepared by the International Conference of Building Officials regulating materials and methods used in construction and establishing consistent standards to assure healthy, safe and sanitary conditions.

universal design, appropriate to people of all ages, abilities, and sizes.

upholstery, a soft covering of fabric on seating units, sometimes but not necessarily over padding, stuffing and/or springs.

urethane, lightweight, cellular plastic capable of assuming nearly any density and thus any hardness from resilient to rigid. Urethane can be sprayed as surface coating, preformed as cushioning and insulation, or cast to form rigid components.

utility core, a central space or unit, sometimes prefabricated, that contains all service elements, including bathrooms, heating, air conditioning, and the like.

vacuum-formed, a plastic formed in a mold in which all of the air is drawn out to form a vacuum that forces the plastic around the mold.

valance, a decorative fabric heading at the top of a window.

value, the attribute of perceived color by which it seems to transmit or reflect a greater or lesser fraction of the light incident upon it.

vaulted ceiling, a ceiling constructed as an extended arch, often semicylindrical in form (a barrel vault). Intersecting arches produce a groin vault; a ribbed vault reveals the framework of arched ribs.

vehicle, the carrying liquid of a suspension such as paint.

veiling reflection, partially or totally obscures the details to be seen by reducing the contrast.

velvet, a fabric covered with a close, short, fine, dense nap or pile.

venal structure, of or similar to the branching vessels which carry nutrients through living things.

vinyl, a versatile family of strong, lightweight plastics available in flexible, rigid, molded, film, foam, and cellular forms.

viscose, a fiber manufactured from chemically treated cellulose.

visual comfort probability, (VCP), the rating of a lighting system expressed as a percentage of people who, when viewing from a specified location and in a specified direction, will be expected to find it acceptable in terms of discomfort glare.

visual field, the sum of objects or points in space which can be perceived when the head and eyes are kept fixed.

visual surround, all portions of the visual field except the visual task.

visual task, those details and objects which must be seen for the performance of a given activity, including the immediate background of details or objects.

visual weight, the effect of visual impact regardless of actual weight, determined in part by color, texture and pattern.

vitriify, to convert into glass by fusion; typically by heat.

VOC, (Volatile Organic Compounds), a gaseous, sometimes harmful by-product of the curing process of some paints or adhesives.

wafer board, a course-grained, rough-faced industrial board product, composed of wood flakes and adhesive; easily cut, but not intended for finish work.

warp, the lengthwise yarns of a fabric, running through the loom, parallel to the edges of the run of fabric. The twist of an element away from its intended position caused by internal stresses due to changes in temperature or moisture.

weaving, the process of interlacing two or more sets of yarns, usually at right angles to each other, to make textiles.

weft, woven fabric. Also woof, the threads on a woven fabric which cross the warp.

Wilton, a specific weave of carpet in which yarns of different colors are raised in loops to form a pattern, after which the loops are cut to form a diverse plus pile.

woof, the threads on a woven fabric which cross the warp.

working drawings, the final drawings that are used to obtain bids for and construct a design.

workplane, the plane at which work is done and on which illuminance is specified and measured. Unless otherwise indicated, this is assumed to be a horizontal plane 0.76 m (30 in.) above the floor.

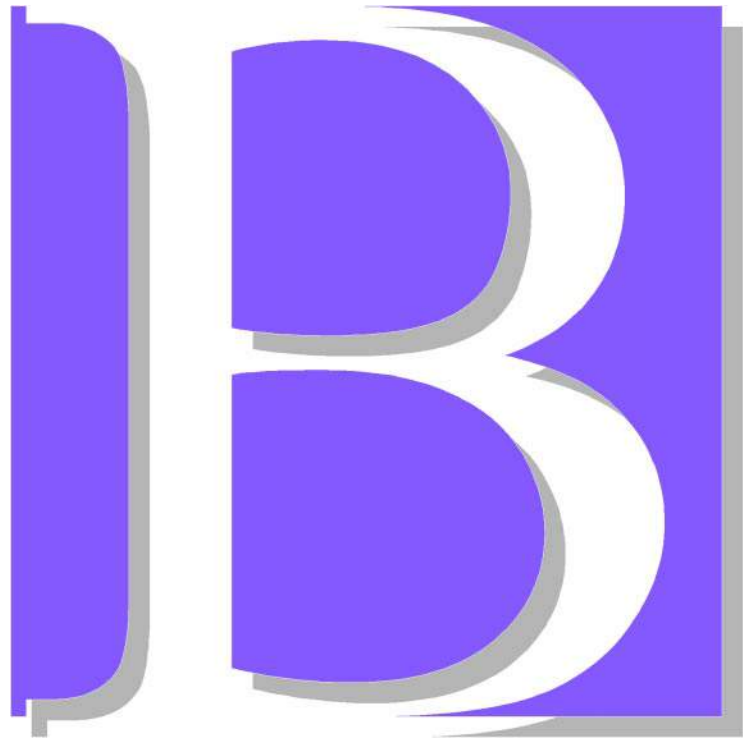

Bibliography



Bibliography

Americans with Disabilities Act (ADA). Washington, D.C.: U.S. Architectural & Transportation Barriers Compliance Board, 1991.

Architectural Woodwork Quality Standards. Centreville, VA: The Architectural Woodwork Institute, 1994.

Arnheim, Rudolph. *Art & Visual Perception: A Psychology of the Creative Eye*. Berkeley, CA: University of California Press, 1974.

Arnheim, Rudolph. *Parables of Sun Light: Observation on Psychology, the Arts and the Rest*. Berkeley, CA: University of California Press, 1989.

Bevlin, Marjorie E. *Design through Discovery an Introduction to Art and Design*. 5th ed. New York: Holt, Rinehart and Winston, Inc., 1989.

BOCA Basic/National Building Code. Country Club Hills, IL: Building Officials and Code Administrators International, Inc., 1984.

Boylan, Bernard. *Lighting Primer*. Ames, IA: Iowa State University Press, 1987.

Ching, Francis D.K. *Architectural Graphics*. New York: Van Nostrand Reinhold, 1985.

Ching, Francis D.K. *Architecture Space & Form & Order*. New York: Van Nostrand Reinhold, 1979.

Ching, Francis D.K. *Building Construction Illustrated*. New York: Van Nostrand Reinhold, 1975.

Ching, Francis D.K. *Interior Design Illustrated*. New York: Van Nostrand Reinhold, 1987.

Calloway, Stephen. *The Elements of Style: A Practical Encyclopedia of Interior Architectural Twentieth Century Decoration*. New York: Rizzoli, 1988.

Farren, Carole E. *Planning and Managing Interior Projects*. Kingston, MA: R.S. Means Company, Inc., 1988.

Freifeld, Roberta. *Space Planning*. Washington, D.C.: Special Libraries Association, 1991.

Garstein, A.S. *The How-To Handbook of Carpets*. New York: The Carpet Training Institute, 1979.

Graf, Don. *Basic Building Data*. 3rd ed. New York: Van Nostrand Reinhold, 1985.

Hall, Edward T. *The Hidden Dimension*. Garden City, NJ: Doubleday & Co./Anchor Book, 1990.

Harrigan, J.E. *Human Factors Research: Methods and Applications for Architects and Interior Designers*. New York: Elsevier Dutton, Inc., 1987.

Heschong, Lisa. *Thermal Delight in Architecture*. Cambridge, MA: MIT Press, 1979.

Karlen, M. *Space Planning Basics*. New York: Van Nostrand Reinhold, 1992.

Knackstedt, Mary V. *The Interior Design Business Handbook*. 2nd ed. New York: Van Nostrand Reinhold, 1992.

Laseau, Paul. *Graphic Thinking for Architects and Designers*. 2nd ed. New York: Van Nostrand Reinhold, 1989.

Laseau, Paul. *Lighting Handbook: Reference & Application*. 8th ed. New York: Illuminating Engineering Society of North America, 1993.

McGuiness, William; Stein, Ben M; and Reynolds, Frederick H. *Mechanical and Electrical Equipment for Building*. New York: John Wiley & Sons, Inc., 1986.

Muller, Edward. *Architectural Drawing and Light Construction*. 3rd ed. Old Tappan, NJ: Prentice-Hall, 1985.

NFPA 101 Life Safety Code. Quincy, MA: National Fire Protection Association, 1994.

Nuckolls, James L. *Interior Lighting for Environmental Designers*. 2nd ed. New York: John Wiley & Sons, Inc., 1983.

Panero, Julius and Zelnick, Martin. *Human Dimensions and Interior Space*. New York: Whitney Library of Design/Watson-Guptill Publications, Inc. 1979.

Pile, John. *Interior Design*. New York: Harry N. Abrams, Incorporated, 1988.

Pile, John. *Open Office Planning: A Handbook for Interior Designers and Architects*. New York: Whitney

Library of Design/Watson-Guptill Publications, Inc., 1986.

Ramsey, Charles George and Sleeper, Harold Reeve. *Architectural Graphic Standards*. 8th ed. New York: John Wiley & Sons, Inc., 1988.

Raschko, Bettyann Boetticher. *Housing Interiors for the Disabled and Elderly*. New York: Van Nostrand Reinhold, 1982.

Reznikoff, Sivon C. *Interior Graphic and Design Standards*. New York: Whitney Library of Design/Watson-Guptill Publications, Inc., 1986.

Reznikoff, Sivon C. *Specifications for Commercial Interiors*. New York: Whitney Library of Design/Watson-Guptill Publications, Inc., 1989.

Riggs, J. Rosemary. *Materials and Components of Interior Design*. 3rd ed. Englewood Cliffs, NJ: Prentice-Hall, 1989.

Shopsin, William C. *Restoring Old Buildings for Contemporary Uses: An American Sourcebook for Architects and Preservationists*. New York: Whitney Library of Design/Watson-Guptill Publications, Inc., 1989.

Smith, Fran Kellogg and Bertolone, Fred J. *Bringing Interiors to Light: The Principles and Practices of Lighting Design for Interior Designers*. New York: Whitney Library of Design/Watson-Guptill Publications, Inc., 1986.

Staebler, Wendy. *Architectural Detailing in Contract Interiors*. New York: Whitney Library of Design/Watson-Guptill Publications, Inc., 1988.

Standard Building Code. Birmingham, AL: Southern Building Code Congress International, Inc., 1991.

Sundstrom, Eric. *Work Places: Psychology of the Physical Environment in Offices & Factories*. Cambridge England: Cambridge University Press, 1986.

Uniform Building Code. Whittier, CA: International Conference of Building Officials, 1994.

Uniform Federal Accessibility Standards. Washington, D.C.: U.S. Architectural & Transportation Barriers Compliance Board, 1988.

Waier, Phillip R. *1993 Means Building Construction Cost Data*. 51st ed. Kingston, MA: R.S. Means Company, Inc., 1992.

Yeager, Jan. *Textiles*. New York: Harper & Row, 1988.

Zeisel, John. *Inquiry by Design: Tools for Environment - Behavior Research*. Monterey, CA: Brooks/Cole Publishing Co., 1981.

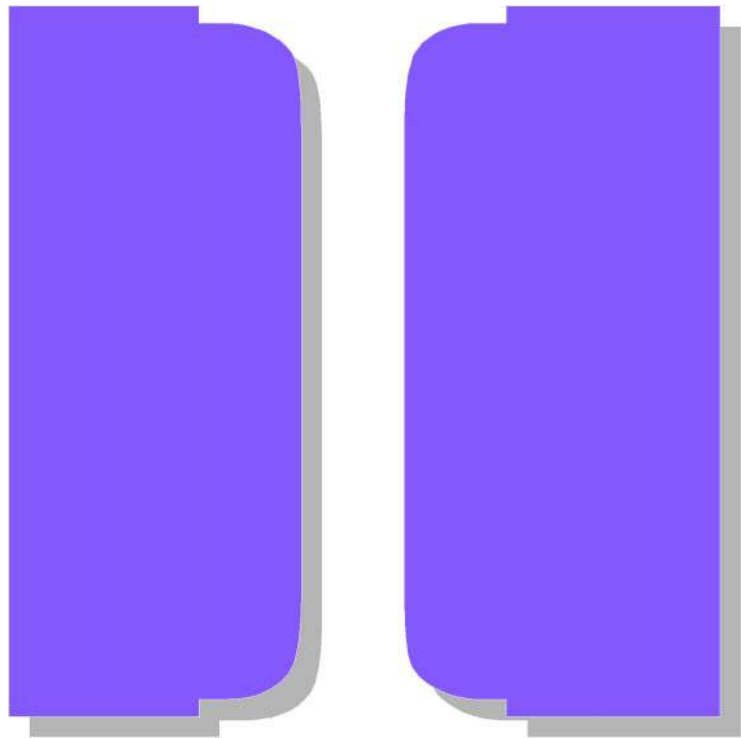

Index



Index

A

- Accessories, 7.10
- Acoustic ceilings systems, 6.11
- Acoustic, 5.5
- Aesthetics, 2.6
- Alarm systems, 5.20
- American National Standards Institute (ANSI). 4.9
- Analogous colors, 3.8
- Anthropometrics, 2.7
- Application guidelines, 6.31
 - for ceilings, 6.35
 - for floors, 6.32
 - for walls, 6.34
- Applicability of the Design Guide for Interiors,
 - AR 415-15, 1.2
 - ER 1110-345-122, 1.2
- Architectural systems, 5.1
- Architectural and Engineering Instructions,
 - Appendix A.2
- Army interior design process, Appendix A.1
- Army Regulation 415-15, Appendix A.2
- Art, 7.11
- Audio visual equipment, 7.10

B

- Balance, 4.4
 - Asymmetrical balance, 4.4
 - Radial balance, 4.5
 - Symmetrical balance, 4.4
- Blinds, 7.6
- Brightness, 3.4
- Building systems and components, 5.1
- Building-related interior design, 1.2, Appendix A.9

C

- Carpet, 6.12
 - Backing systems:
 - Action-back, 6.16
 - Padded backing, 6.17
 - Primary backing, 6.16

- Secondary Backing, 6.16
- Unitary backing, 6.16
- Broadloom, 6.14
- Carpet tile, 6.14
- Cleaning, 6.17
 - Dry extraction, 6.20
 - Dry foam, 6.20
 - Hot water extraction, 6.20
 - Wet shampoo, 6.20
- Construction:
 - Fusion bonded, 6.15
 - Knit, 6.15
 - Tufted, 6.14
 - Woven, 6.15
- Dye process:
 - Piece-dyed, 6.13
 - Skein-dyed, 6.13
 - Solution-dyed, 6.13
 - Yarn-dyed, 6.13
- Face types:
 - Cut and loop pile, 6.16
 - Cut pile, 6.15
 - Loop pile, 6.16
 - Tip shear, 6.16
- Installation methods:
 - Direct Glue, 6.17
 - Free Lay, 6.17
 - Stretched, 6.17
- Material:
 - Nylon, 6.13
 - Olefin, 6.13
 - Wool, 6.13
- Casegoods, 7.3
- Ceilings, 5.2
- Cellular floor systems, 5.22
- Ceramic tile, 6.10
- Chroma, 3.7
- Cognition, 2.3
- Color, 4.2
- Color fastness, 6.27
- Color harmonies, 4.3
- Color rendering index (CRI), 5.29
- Color retention, 6.27
- Color triad, 3.8
- Color wheel, 3.7

- Communication, 2.5
- Communications systems, 5.19
- Complementary colors, 3.8
- Concept design, Appendix A.6
- Concrete, 6.1
- Construction and life safety, 5.5
- Contract furnishings, 7.1
- Contract seating, 7.1
- Contrast, 3.5
- Contrasting color schemes, 4.3
- Convection, 5.14
- Conventional casegoods, 7.3
- Cork, 6.11
- Correlated color temperature (CCT), 5.29
- Crowding, 2.2
- Custom casegoods, 7.5
 - Custom grade, 7.5
 - Economy grade, 7.5
 - Premium grade, 7.5

D

- Data and communications, 5.19
- Data collection and programming, Appendix B.1
- Decorative accessories, 7.10
- Design, Appendix A.5
- Design directives, Appendix A.3
 - Code 1, Appendix A.3
 - Code 2, Appendix A.3
 - Code 3, Appendix A.3
 - Code 4, Appendix A.4
 - Code 5, Appendix A.4
 - Code 6, Appendix A.4
 - Code 9, Appendix A.4
- Design services during construction and installation, Appendix A.9
- Designing with light, 5.31
 - Ambient, 5.31
 - Direct 5.32
 - Indirect, 5.32
 - Task, 5.30
- Desk/conference chairs, 7.2
 - Active ergonomic, 7.2
 - Passive ergonomic, 7.2
- Developing a color scheme, 4.9

Dimensional stability, 6.27
Direct glare, 3.5
Directional signage, 7.8
Doors, 5.4
Drain pipes, 5.17

E

Electrical systems, 5.19
Elements of design, 4.1
Emphasis, 4.5
Engineered wood products, 6.7
Ergonomic design, 2.7

F

Fabric and textiles, 6.25
 Drapeability, 6.25
 Durability, 6.25
 Hand, 6.25
 Performance enhancers, 6.27
 Acrylic backing, 6.28
 Foam backing, 6.28
 Paper backing, 6.28
 Spunbonding, 6.28
 Treatments, 6.28
 Anti-microbial finishes, 6.30
 Flame-retardant coatings, 6.28
 Soil and stain repellents, 6.30
 Staph fluid barriers, 6.30
 Vinylized fabrics, 6.30
 Types, 6.26
 Natural textiles, 6.26
 Synthetic textiles, 6.26
 Weight, 6.25
Federal Acquisition Regulations (FAR), Appendix A.7
Federal Prison Industries (FPI) UNICOR, Appendix A.8
Fibers:
 Continuous Filament, 6.12
 Staple Fibers, 6.12
Film-applied finishes, 6.21
Final design, Appendix A.7
Fire hose stations, 5.18
Fire protection, 5.18
Flat wire, 5.21
Floors, 5.2

- Fluorescent lamps and fixtures, 5.26, 5.30
 - Compact fluorescent, 5.26
 - Straight-linear fluorescent "T" lamps, 5.26
- Flush door, 5.4
- Forced air, 5.14
- Form, 4.1
- Formal group, Appendix B.7
- Functional efficiency, 2.6
- Funding for Military Construction Projects,
Appendix A.4
- Furnishings, 1.3, 7.1
- Furniture, 7.1
- Furniture-related interior design, 1.2, Appendix A.9,
Appendix A.10

G

- Glass, 6.8
- Glare, 3.5
- General Services Administration (GSA) schedules,
Appendix A.7
- Granite, 6.2
- Group dynamics, 2.4

H

- Hard window treatments, 7.6
- Hardwoods, 6.3
- Harmony, 4.5
 - Unity, 4.5
 - Variety, 4.5
- Hearing, 2.6
- Heating, ventilating and air conditioning (HVAC), 5.12
 - Central air distribution systems, 5.13
 - Central water distribution systems, 5.13
 - Hybrid distribution systems, 5.14
 - Local distribution systems, 5.14
- High intensity discharge (HID) lamps and fixtures, 5.27, 5.30
 - High pressure sodium (HPS), 5.30
 - Metal halide, 5.28
- Horizontal blinds, 7.6
- Hue, 3.6
- Human behavior and the interior environment, 2.1
- Human response to the interior environment, 2.4
- Humidity control, 5.15

HVAC system, (See Heating, ventilating and air conditioning)

I

- Incandescent lamps and fixtures, 5.24
 - Decorative - F, G, C, and B, 5.24
 - General service - A, S, P, PS, and T, 5.24
 - Low voltage, 5.25
 - Reflector - R, ER, and PAR, 5.24
 - Tungsten-halogen lamps, 5.25
- Industrial composite boards, 6.7
 - Medium density fiberboard, 6.7
 - Oriented strand board, 6.7
 - Wafer board, 6.7
- Individual space, Appendix B.6
- Informal group space, Appendix B.7
- Informational signage, 7.8
- Initiation of design, Appendix A.5
- Installation Design Guide, Appendix A.11
- Institutional furnishings, 7.1
- Integral distribution systems, 5.21
- Interaction levels, 2.1
- Intimate space, 2.2

L

- Lacquer, 6.23
- Laminated safety glass, 6.9
- Lamp types, 5.23
- Lamps and their effect on color, 5.29
 - Fluorescent, 5.30
 - High intensity discharge, 5.30
 - Incandescent, 5.30
 - Tungsten-halogen, 5.30
- Life safety and health concerns, 2.8
- Light and color, 3.1
- Light in relation to surface, 3.6
- Lighting, 5.23
- Lighting rules of thumb, 5.33
- Line, 4.1
- Linoleum, 6.11
- Lounge seating, 7.1

M

Maison Domino, 5.10
Marble, 6.2
Masonry, 6.1
Materials, 6.1
Matte reflection, 3.6
Mechanical system, 5.12
Metals, 6.2
Military Construction Projects, Appendix A.4
Millwork, 5.3
Mobility, 2.7
Modular casegoods, 7.3
Multiple seating, 7.1

O

Occupational Safety and Health Administration (OSHA),
4.9
Open office, Appendix B.6
Operations and Maintenance Projects, Appendix A.5
Operations policy, Appendix A.11
Overhead cable distribution systems, 5.20

P

Paint, 6.21
 Acrylic, 6.21
 Alkyds, 6.21
 Epoxy, 6.22
 Finishes:
 Flat, 6.22
 Eggshell, 6.22
 High-gloss, 6.22
 Semi-gloss, 6.22
 Latex, 6.21
 Oil-based, 6.21
 Water-based, 6.21
Paneling, 5.4
Partition, 5.1
Perception, 2.3
Personal space, 2.2
Perspective, 3.2
Physiological determinants, 2.6
Planning, Appendix B.5

Planning administrative work environments,
Appendix B.1
Planning and programming, Appendix A.4
Plants, 7.12
Plastic, 6.7
Plastic laminate, 6.8
Plumbing, 5.16
Poke-through electrical distribution systems, 5.22
Porcelain tile, 6.10
Power poles, 5.21
Primary interior finish materials, 6.1
Principles of design, 4.1, 4.4
Privacy, 2.1
Procurement, Appendix A.7
Progression, 4.5
Project engineering with parametric estimating,
Appendix A.6
Proportion, 4.6
Psychological determinants, 2.5
Psychological human response, 2.3
Public space, 2.2

Q

Quarry tile, 6.10

R

Radiant heat, 5.14
Raised access flooring, 5.21
Reflectance, 3.4
Reflecting glare, 3.5
Reflection, 3.6
Regulatory signage, 7.8
Related color schemes, 4.3
Relative humidity, 5.15
Reorganization and changing mission, Appendix A.11
Repetition, 4.5
Residential furnishings, 7.1
Resilient flooring, 6.11
Rhythm, 4.5
Risers, 5.16
Rubber, 6.12
Running trim, 5.4

S

Scale, 4.6
Secondary colors, 3.7
Sedimentary stone, 6.2
Semi-specular reflection, 3.6
Shade, 3.7
Shape, 4.1
Sheet vinyl, 6.12
Sick Building Syndrome, 5.15
Side chairs, 7.1
Signage/graphics, 7.8
Social space, 2.2
Sociological determinants, 2.4
Sociological human need, 2.1
Softwoods, 6.3
Soil and stain repellents, 6.30
Space, 4.2
Spatial behavior, 2.3
Spatial perception and definition, 3.2
Specialty coatings, 6.22
Specular reflection, 3.6
Sprinkler systems, 5.17
 Dry pipe, 5.17
 Wet pipe, 5.17
Stability, 2.6
Stain, 6.23
Stain resistance, 6.27
Standard designs, Appendix A.3
Standing trim, 5.4
Standpipes, 5.18
Static-conductive tiles, 6.12
Static electricity, 5.15
Stile and rail doors, 5.5
Stone, 6.2
 Igneous, 6.2
 Metamorphic, 6.2
Structural systems, 5.10
Systems furniture, 7.4

T

Team space, Appendix B.7
Terrazzo, 6.10
Territoriality, 2.2
Tertiary colors, 3.7

Texture, 4.2
Textile characteristics, 6.27
Textile wallcoverings, 6.24
The Illuminating Engineering Society of North America
(IESNA), 3.4
Tile, 6.10
Traps, 5.17
Trench duct, 5.22

U

Underfloor duct systems, 5.21
User responsibilities, Appendix A.11

V

Value, 3.6
Varnish, 6.23
Ventilation, 5.15
Vent, 5.17
Vertical blinds, 7.6
Vinyl composition tile (VCT), 6.11
 Static-conductive, 6.12
Vinyl wallcoverings, 6.24
Vision, 2.6
Visual privacy, 2.5
Volatile organic compounds (VOC), 6.24
Volume, 4.2

W

Wall board, 6.9
Wallcovering, 6.24
Wallpapers, 6.24
Window treatment, 7.5
 Cornices, 7.7
 Curtains, 7.6
 Draperies, 7.6
 Maintenance of, 7.8
 Sagging, 7.7
 Shades, 7.6
 Shrinkage, 7.7
 Valances, 7.7
Wire glass, 6.9
Wood, 6.3
 Dimensional sizes, 6.4

- Grading, 6.3
- Laminated, 6.4
- Nominal sizes, 6.4
- Plain sawn, 6.3
- Quarter sawn, 6.3
- Seasoning, 6.3
- Surfacing, 6.3
- Veneers, 6.4
 - Book matching, 6.6
 - Plain slicing, 6.5
 - Quarter sawn, 6.5
 - Random matching, 6.7
 - Rift cut, 6.6
 - Rotary cut, 6.5
 - Slip matching, 6.7