

Design Course

Light and Photography

Creative Use of Light

by

Abhey Singh

IDC, IIT Bombay

Source:

<http://www.dsource.in/course/light-and-photography>



1. Introduction
2. What is Light
3. Properties of Light
4. Exposure
5. Types of Light
6. Types of Lighting
7. Light Examples
8. Contact Details

Design Course

Light and Photography

Creative Use of Light

by

Abhey Singh

IDC, IIT Bombay

Source:

<http://www.dsource.in/course/light-and-photography/introduction>

1. Introduction
2. What is Light
3. Properties of Light
4. Exposure
5. Types of Light
6. Types of Lighting
7. Light Examples
8. Contact Details

Introduction

What to Expect?

This course contains information which will help you to start knowing about the creative use of light in photography. In broad terms this course is divided in 2 parts. First part will be about knowing light. It contains information about basic character of light. The second part is about the practical applications of light in photography. Here we will introduce concepts which are defined over the time to use light in a effective manner.

Knowing Light

We will start by looking light in scientific terms and then see how it contributes in seeing things. After that we will move to the properties of light which are important to photography.

Practical Applications in Photography

This part will start from learning about exposure. A photograph is formed when light hit a recording surface (film or digital sensor). Exposure is basically determining how much light is the right choice for recording the image. After learning about the exposure we will move to the basics of lighting.

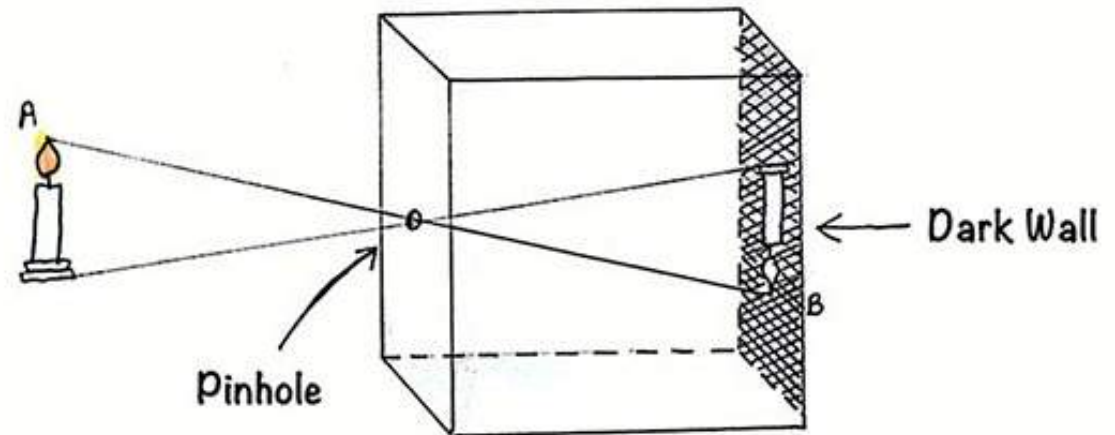

Design Course

Light and Photography

Creative Use of Light

by

Abhey Singh

IDC, IIT Bombay

Source:

<http://www.dsource.in/course/light-and-photography/what-light>

1. Introduction
2. **What is Light**
3. Properties of Light
4. Exposure
5. Types of Light
6. Types of Lighting
7. Light Examples
8. Contact Details

What is Light

A. Scientific Definition

Technically speaking light (more specifically visible light) is part of electromagnetic wave spectrum. It is usually refers as visible light which is visible to human eye and responsible for the sense of sight. (source: Wikipedia)

Well this is the most simple scientific definition of light but if you are still confused about some terms, don't worry, next we will be going to discuss the role of light in photography.

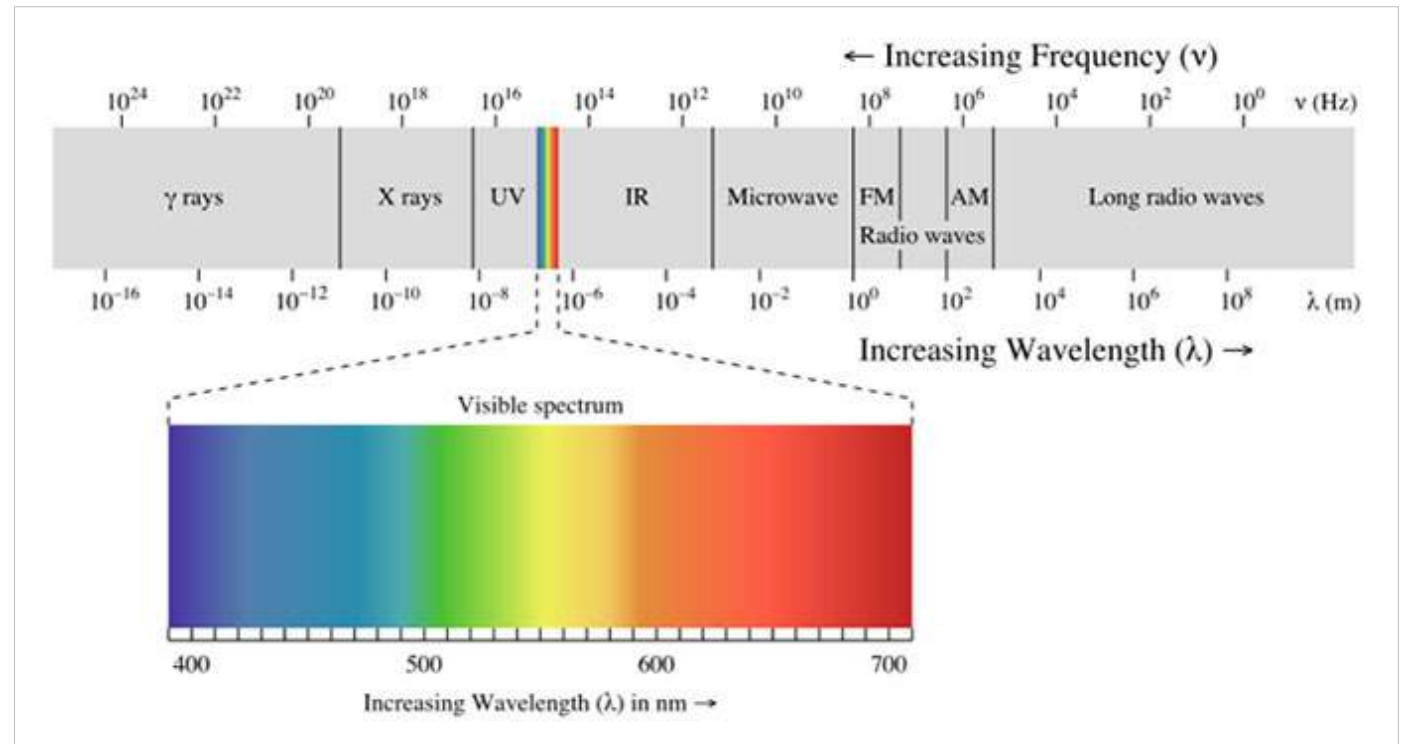

Design Course

Light and Photography

Creative Use of Light

by

Abhey Singh

IDC, IIT Bombay

Source:

<http://www.dsource.in/course/light-and-photography/what-light>

1. Introduction
2. **What is Light**
3. Properties of Light
4. Exposure
5. Types of Light
6. Types of Lighting
7. Light Examples
8. Contact Details

B. Light in Photography

Camera Obscura and How an Image is Formed

Camera Obscura was the first camera ever invented. It is a large dark room with a small opening and forms a inverted image on the wall. In modern times the small hole of the camera Obscura is replaced by a lens and the wall by a sensor.

Light in Photography are What the Colours are in Painting

In painting there is a canvas (a material where the image will be reproduced), colours (the medium for creating image) and a brush (a tool which is used to apply colours on canvas). In photography you can say that:

Colours = Light (raw material)

Brush = Lens (handles the raw material)

Canvas = Sensor/Film (Physical reproduction medium)

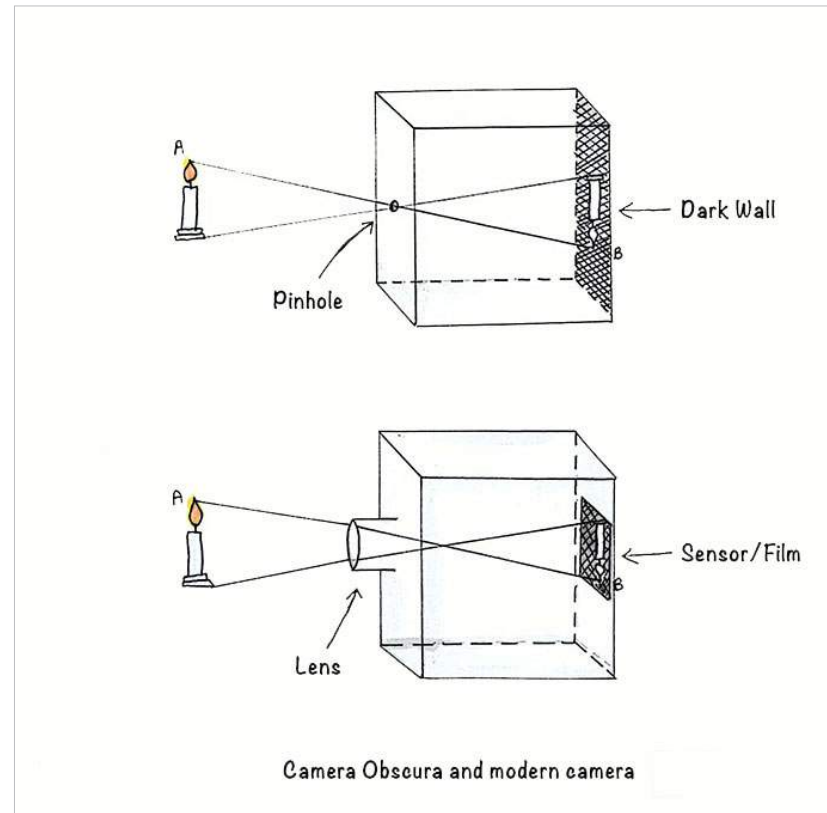

Design Course

Light and Photography

Creative Use of Light

by

Abhey Singh

IDC, IIT Bombay

Source:

<http://www.dsource.in/course/light-and-photography/properties-light>

Properties of Light

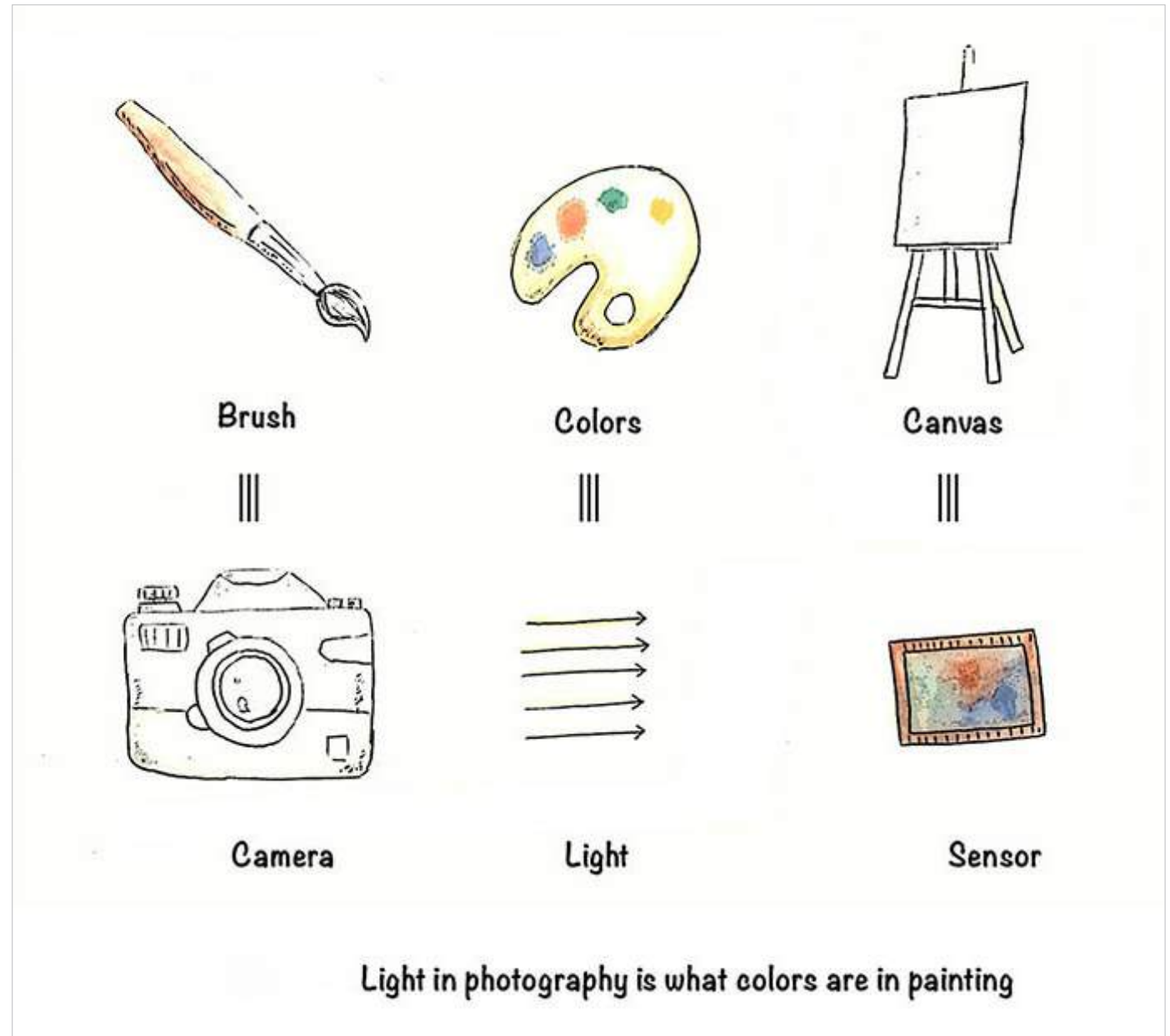

1. Introduction
2. What is Light
3. **Properties of Light**
4. Exposure
5. Types of Light
6. Types of Lighting
7. Light Examples
8. Contact Details

Design Course

Light and Photography

Creative Use of Light

by

Abhey Singh

IDC, IIT Bombay

Source:

<http://www.dsource.in/course/light-and-photography/properties-light>

1. Introduction
2. What is Light
3. **Properties of Light**
4. Exposure
5. Types of Light
6. Types of Lighting
7. Light Examples
8. Contact Details

A. Reflection/ Refraction/ Absorption

When Light Strikes

The colour of the objects we see in the natural world is the result of the way objects interact with light. When a light strikes an object, it can be absorbed, reflected, or transmitted by the object. All objects have a degree of reflection and absorption. It is due to selective reflection and sometimes due to transmission that gives colour to different surfaces.

All three of the properties have different use in photography industry. Reflection amounts to the ambient nature of natural light. Sun is the only major source in nature but most surfaces reflect light that comes from sun acting as pseudo-sources. It is also used in making reflectors, is the basis of how we see colours and used in bounce off flash. Transmission is the basis of making equipments like diffusers, filters and gels. Absorption is mainly used to block light for subtractive lighting.

In natural world, light can also be transmitted by an object with no effect (example: X-rays) however they have no visual effect so no worries.

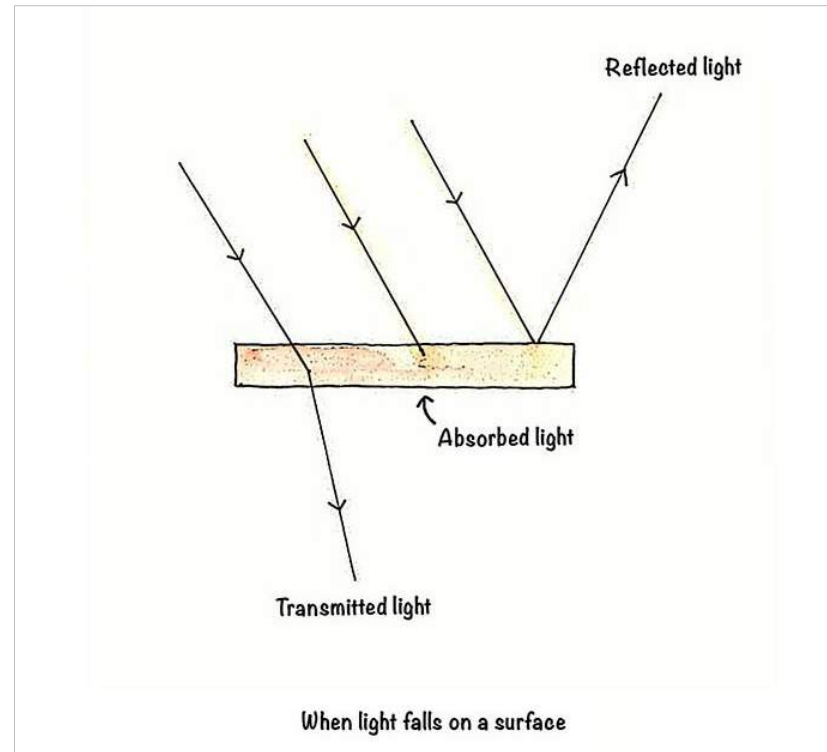

Design Course

Light and Photography

Creative Use of Light

by

Abhey Singh

IDC, IIT Bombay

Source:

<http://www.dsource.in/course/light-and-photography/properties-light>

1. Introduction
2. What is Light
3. **Properties of Light**
4. Exposure
5. Types of Light
6. Types of Lighting
7. Light Examples
8. Contact Details

Reflection

Reflection most common and most used property of light. One of the most common use is when flash light is bounced off the ceiling or a wall to obtain a diffused soft light on the subject. For photography purposes we can classify it into two broad categories: regular reflection and diffuse reflection.

Reflection on a Smooth Surface (mirror)

Light bounces off the surface of a material at an angle equal to the angle of incoming light wave. Example : mirror or glass.

Scatter or Diffuse Reflection (reflection on a rough surface)

Light waves bounce off at many angles because the surface is uneven. Example : earth (that is why sky is blue).

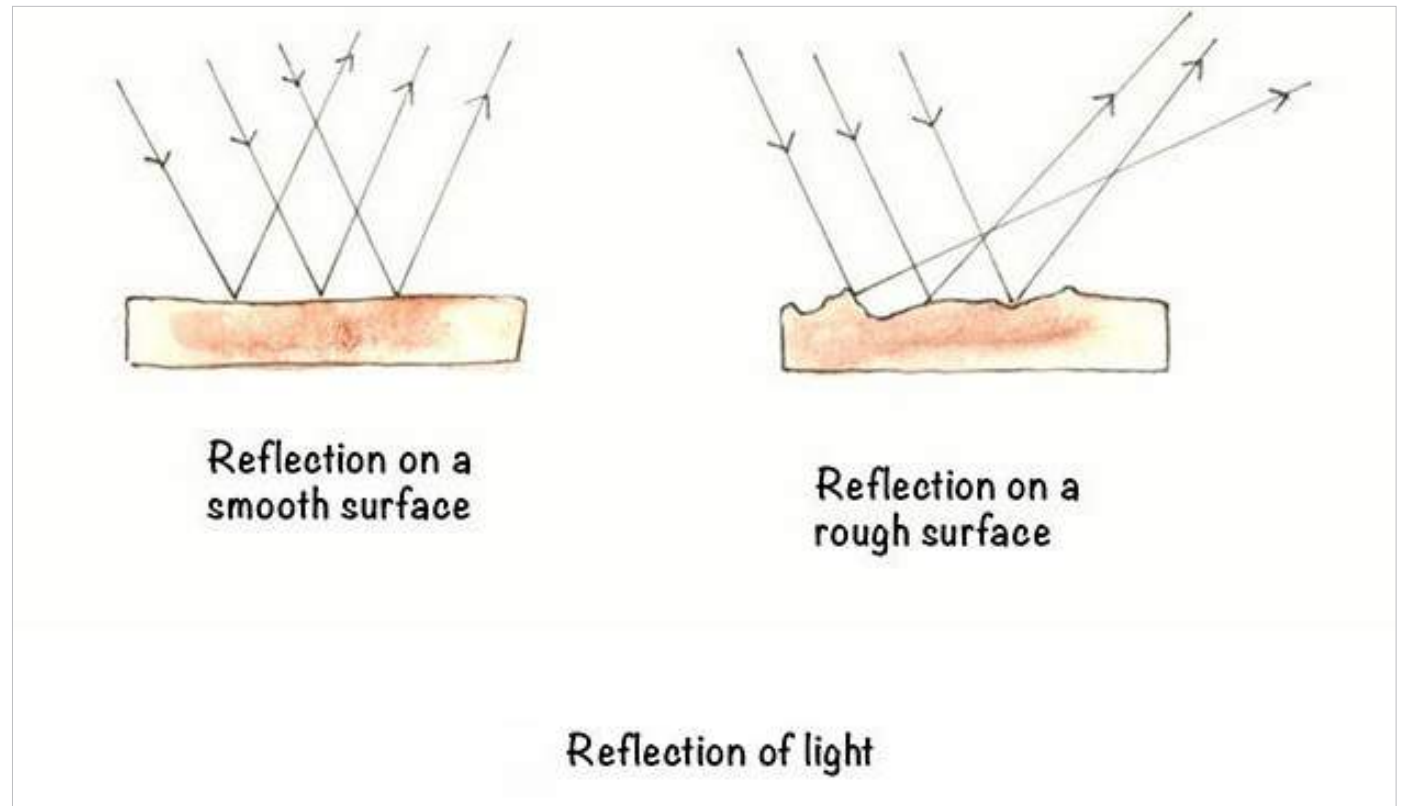

Design Course

Light and Photography

Creative Use of Light

by

Abhey Singh

IDC, IIT Bombay

Source:

<http://www.dsource.in/course/light-and-photography/properties-light>

Absorption

Light stops at the object and does not reflect or refract. Objects appear dark or opaque. The energy thus absorbed manifests as heat. Absorption is useful in subtractive lighting techniques. Example : Wood

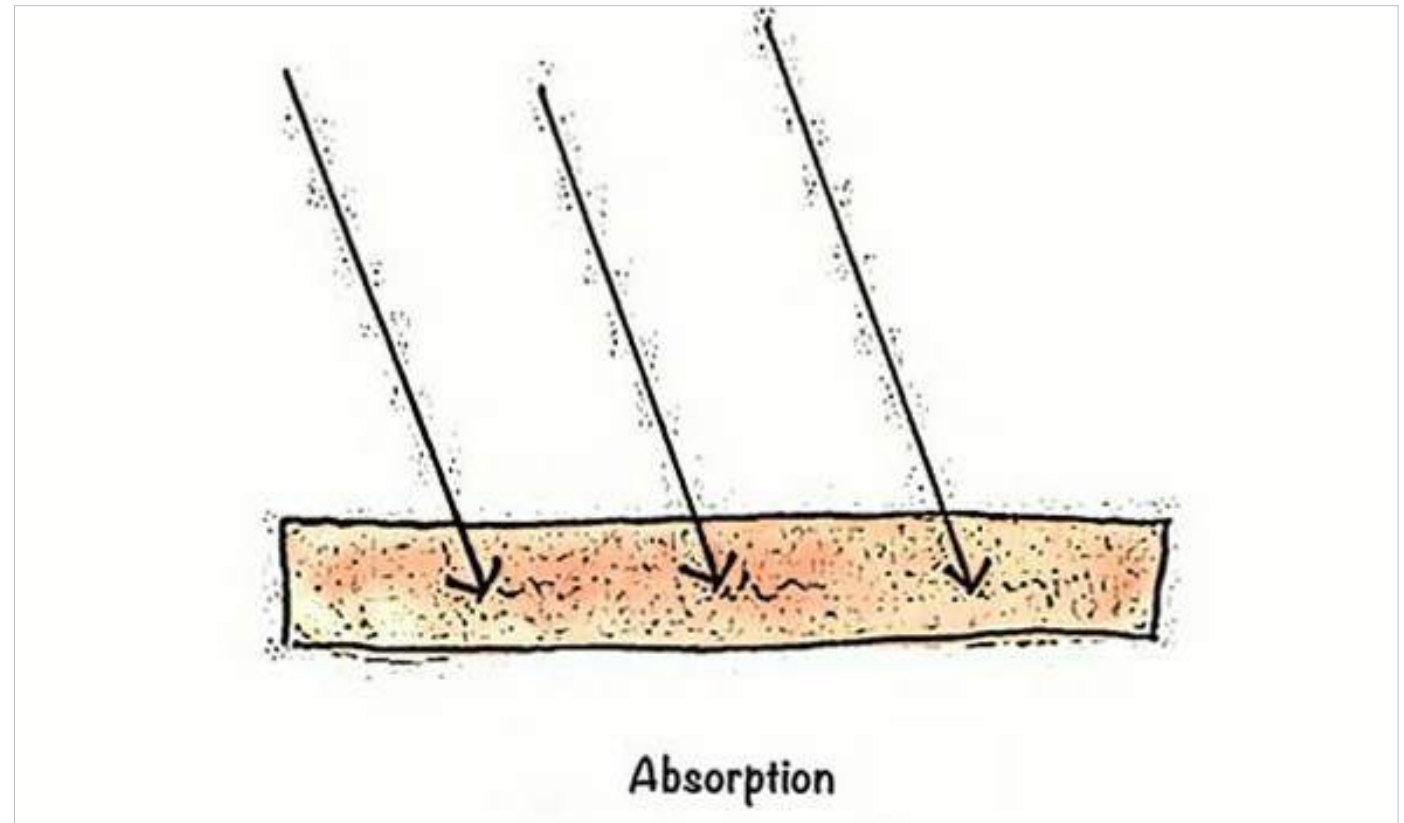

1. Introduction
2. What is Light
3. **Properties of Light**
4. Exposure
5. Types of Light
6. Types of Lighting
7. Light Examples
8. Contact Details

Design Course

Light and Photography

Creative Use of Light

by

Abhey Singh

IDC, IIT Bombay

Source:

<http://www.dsource.in/course/light-and-photography/properties-light>

1. Introduction
2. What is Light
3. **Properties of Light**
4. Exposure
5. Types of Light
6. Types of Lighting
7. Light Examples
8. Contact Details

Transmission

Transmission is when light passes through the surface. Filters or gels work on selective transmission.

Direct Transmission

When light goes through an object and no change in direction or quality takes place. For example - glass or air

Diffuse Transmission

When light goes through a transparent or semi-transparent object with texture. Example : frosted glass
Light will be softer, less contrast, less intensity.

Selective Transmission

When light goes through a coloured object. A portion will be absorbed and another portion will be transmitted through this object.

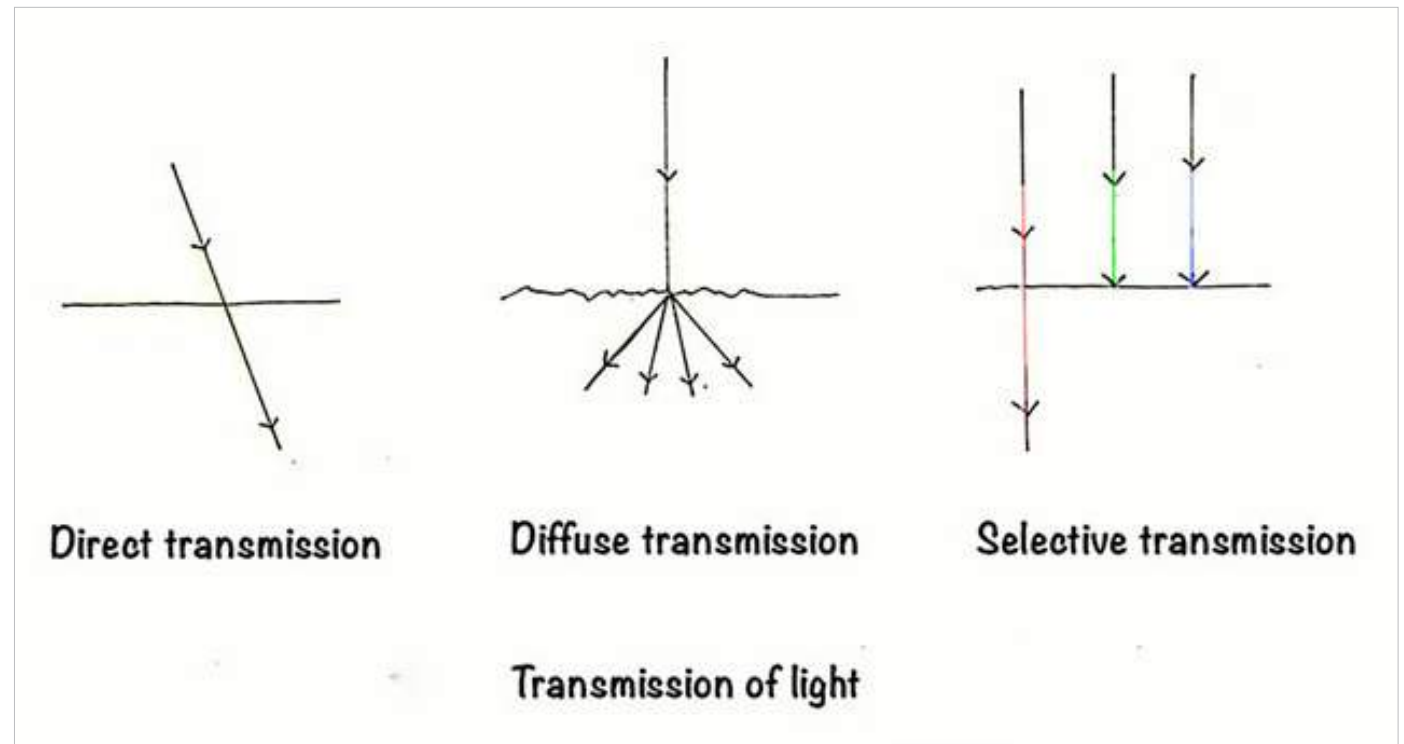

Design Course

Light and Photography

Creative Use of Light

by

Abhey Singh

IDC, IIT Bombay

Source:

<http://www.dsource.in/course/light-and-photography/properties-light>

Refraction

Light goes through the object and bends at an angle. Example : diamond (greater angle) or water (lesser angle).

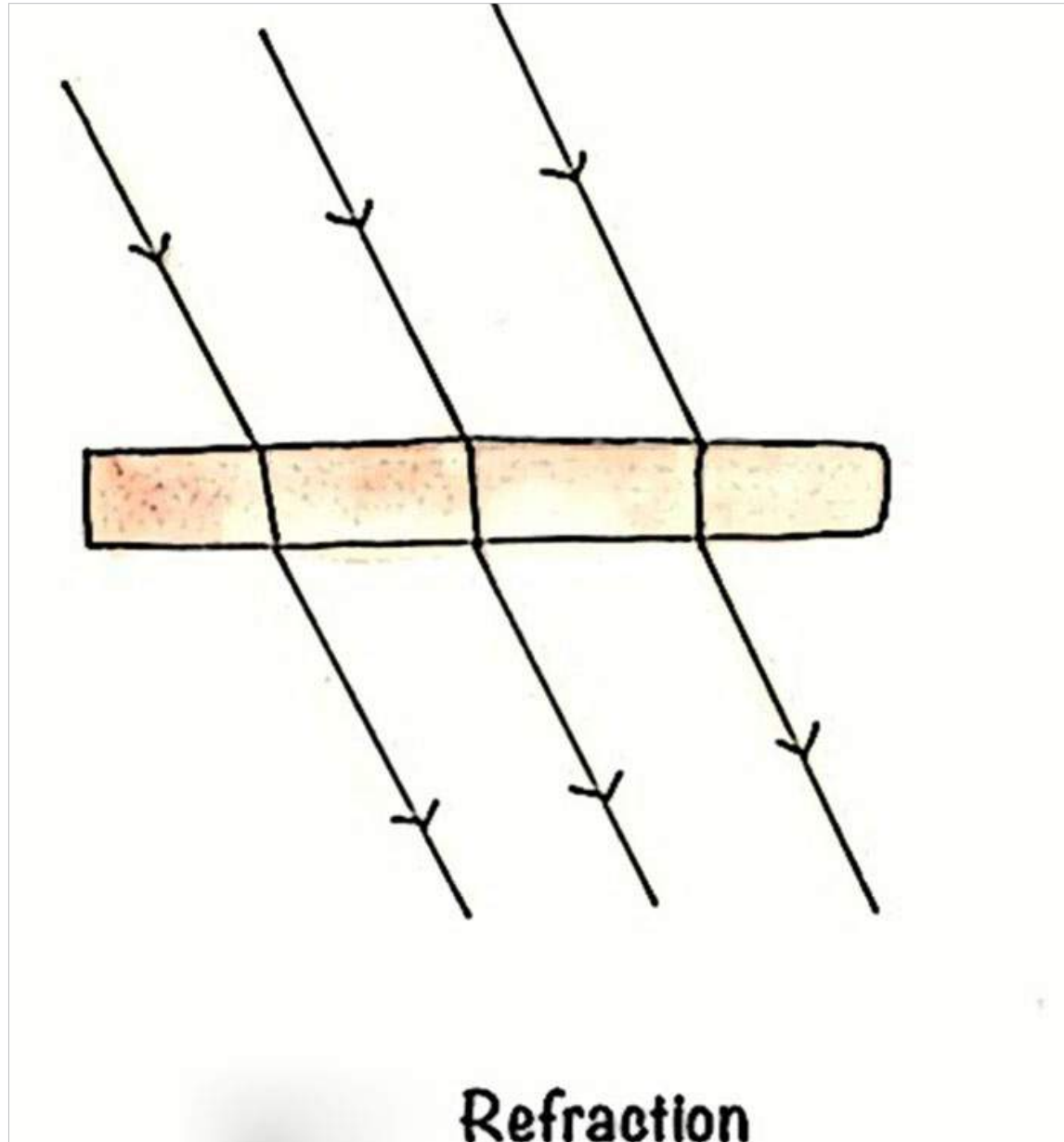

1. Introduction
2. What is Light
3. **Properties of Light**
4. Exposure
5. Types of Light
6. Types of Lighting
7. Light Examples
8. Contact Details

Design Course

Light and Photography

Creative Use of Light

by

Abhey Singh

IDC, IIT Bombay

Source:

<http://www.dsource.in/course/light-and-photography/properties-light>

1. Introduction
2. What is Light
3. **Properties of Light**
4. Exposure
5. Types of Light
6. Types of Lighting
7. Light Examples
8. Contact Details

B. Inverse Square Law

Intensity of a point source of light is inversely proportional to the square of the distance. In simple terms if we double the distance, the intensity of light drops to 1/4th. The effect of this law is not particularly visible in sunlight but it is very apparent while using artificial lights especially in studio. Generally speaking it means that light falls off drastically with distance. So while using flash and other artificial sources, distance matters a lot.

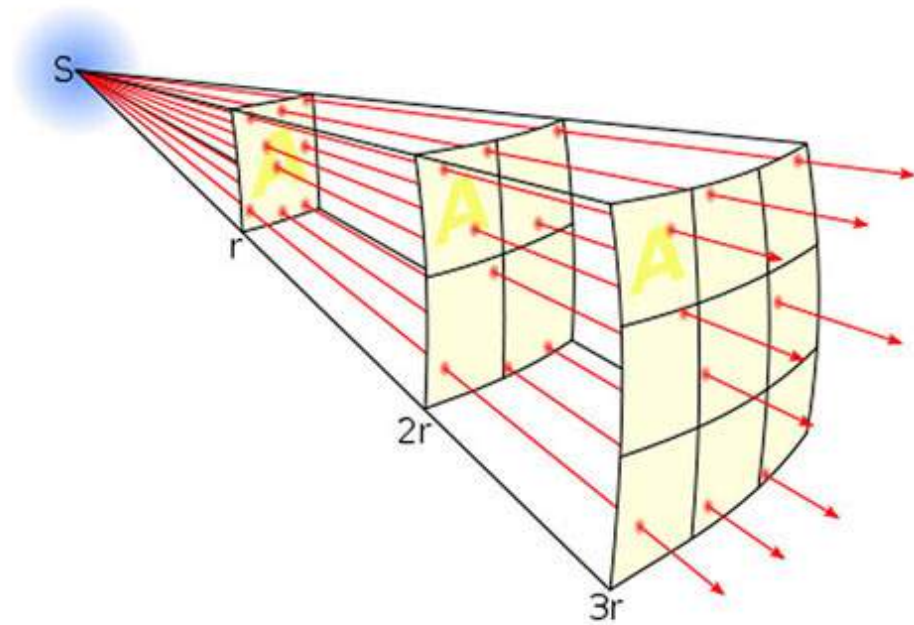

Inverse square law

(Courtesy : Wikipedia creative commons)

Design Course

Light and Photography

Creative Use of Light

by

Abhey Singh

IDC, IIT Bombay

Source:

<http://www.dsource.in/course/light-and-photography/properties-light>

C. Color Temperature

The temperature at which a black body would emit radiation of the same colour as a given object. In simple language, colour temperature is the colour of the light. It depends on the source of the light that is producing it.

1. Introduction
2. What is Light
3. **Properties of Light**
4. Exposure
5. Types of Light
6. Types of Lighting
7. Light Examples
8. Contact Details

Light source distance = 1 meter



Light source distance = 2 meter



Inverse square law

Design Course

Light and Photography

Creative Use of Light

by

Abhey Singh

IDC, IIT Bombay

Source:

<http://www.dsource.in/course/light-and-photography/properties-light>

1. Introduction
2. What is Light
3. **Properties of Light**
4. Exposure
5. Types of Light
6. Types of Lighting
7. Light Examples
8. Contact Details

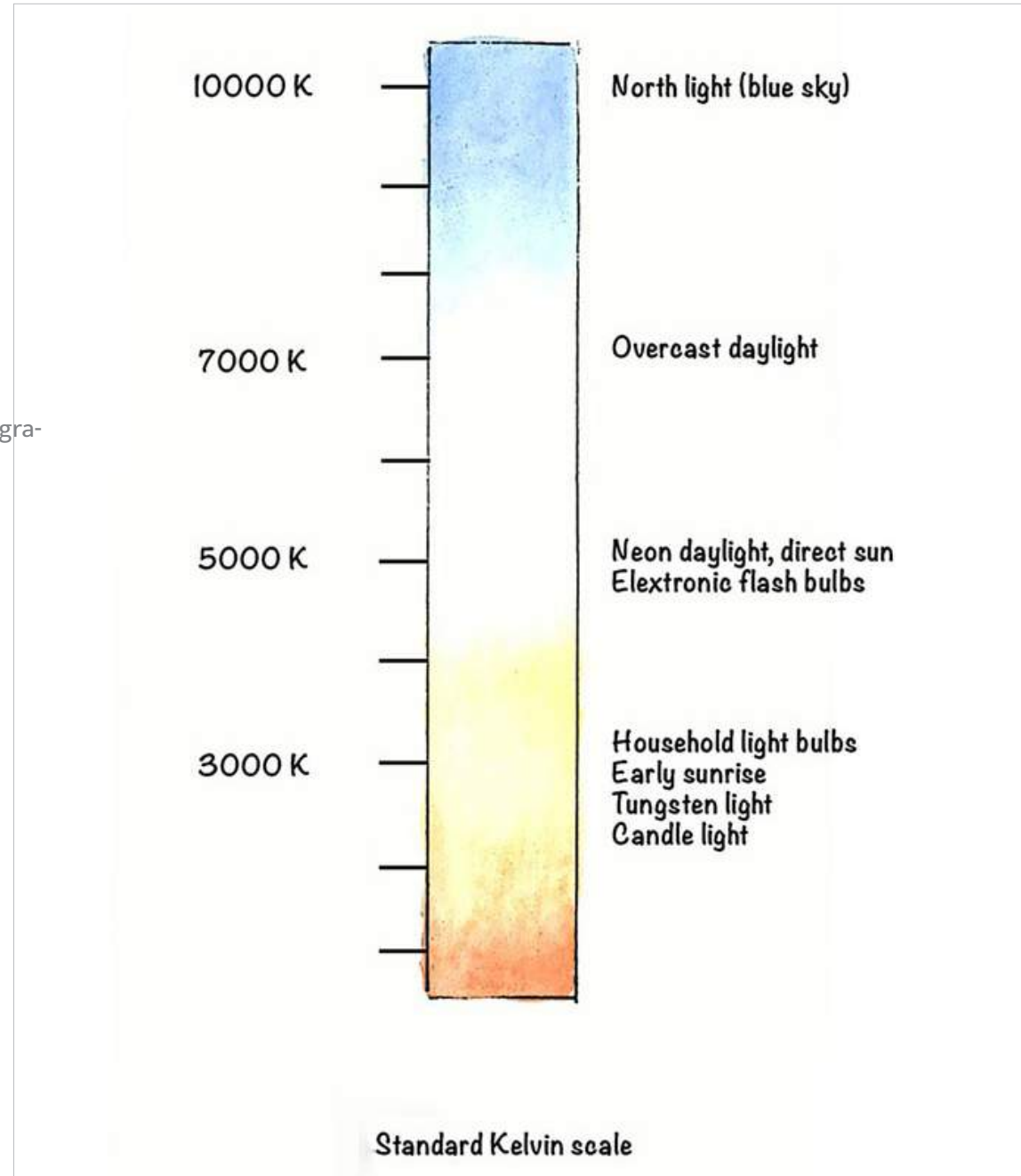

Design Course

Light and Photography

Creative Use of Light

by

Abhey Singh

IDC, IIT Bombay

Source:

<http://www.dsource.in/course/light-and-photography/properties-light>

1. Introduction
2. What is Light
3. **Properties of Light**
4. Exposure
5. Types of Light
6. Types of Lighting
7. Light Examples
8. Contact Details

White Balance

When the source of light is not completely white, the whites in the image comes out tinted. For example, a white paper will look yellow in a yellow tungsten light. White balance is adjusting the setting in the camera to compensate for the coloured light. So as the name suggests it is adjusting to get the right white.

In most of the cameras there are in-built presets for different type of common lights like tungsten, flash, shade, daylight etc. Sunlight is neutral with a temperature of around 5500K, the temperatures below it contains warm tones (red, orange, yellow) and the temperatures above 5500K belongs to cool tones (blue, magenta).

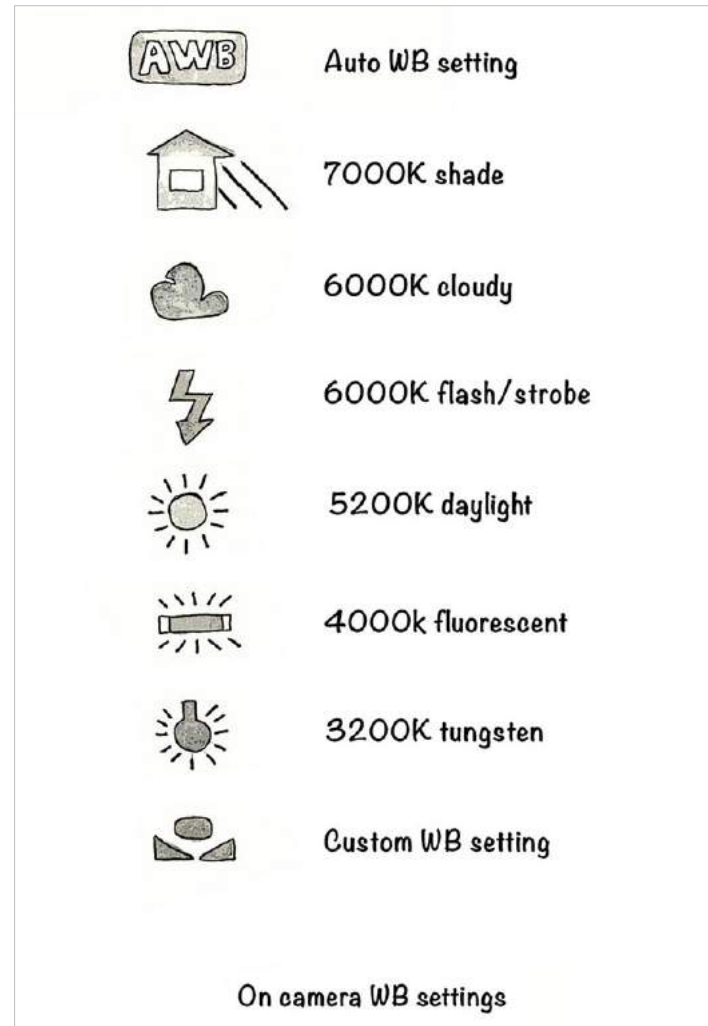

Design Course

Light and Photography

Creative Use of Light

by

Abhey Singh

IDC, IIT Bombay

Source:

<http://www.dsource.in/course/light-and-photography/properties-light>

1. Introduction
2. What is Light
3. **Properties of Light**
4. Exposure
5. Types of Light
6. Types of Lighting
7. Light Examples
8. Contact Details

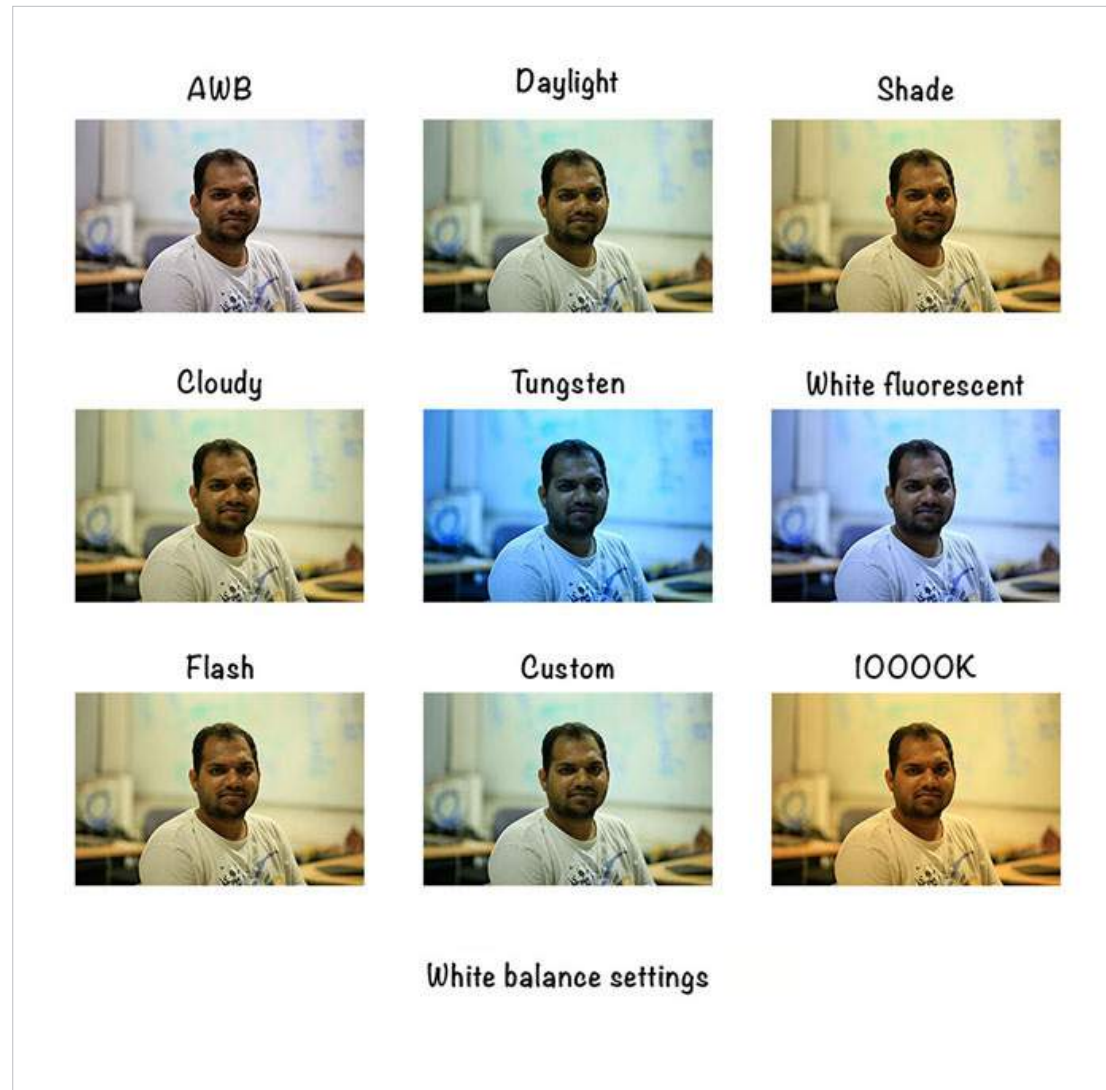

D. Colour

Light consists of seven different colours. When all the different wavelengths belonging to different colours combine, it produces white light. Colour as we see in universe is the result of selective reflection and selective transmission of light. It is in principle effect of the light waves that come from the object to our eyes. These waves can be the result of reflection, transmission or maybe the object is the light source. So that is it we see colours in object due to the light waves coming from them.

Design Course

Light and Photography

Creative Use of Light

by

Abhey Singh

IDC, IIT Bombay

Source:

<http://www.dsource.in/course/light-and-photography/properties-light>

1. Introduction
2. What is Light
3. **Properties of Light**
4. Exposure
5. Types of Light
6. Types of Lighting
7. Light Examples
8. Contact Details

E. Quality of Light

Relative size of the light source with respect to subject renders the light source as hard/soft. Hard light has more contrast, accentuate the texture and gives a more decisive feel in the photograph. Soft light in turn has less contrast, it makes the surface look smooth and gives a more moderate feel. In a way you can see hard light as black/white and soft light as the mid-tones between the extreme blacks and whites of hard light. Diffused light is soft light as light scatters and effective size of light source increases.

Soft Light

- Create soft shadows.
- Difficult to control as it is not that focused and light spills in all directions.
- Presents form through a range of tones.

Hard Light

- Create harsh shadows.
- Accentuate textures.
- Easy to control and shape as it can be easily directed.

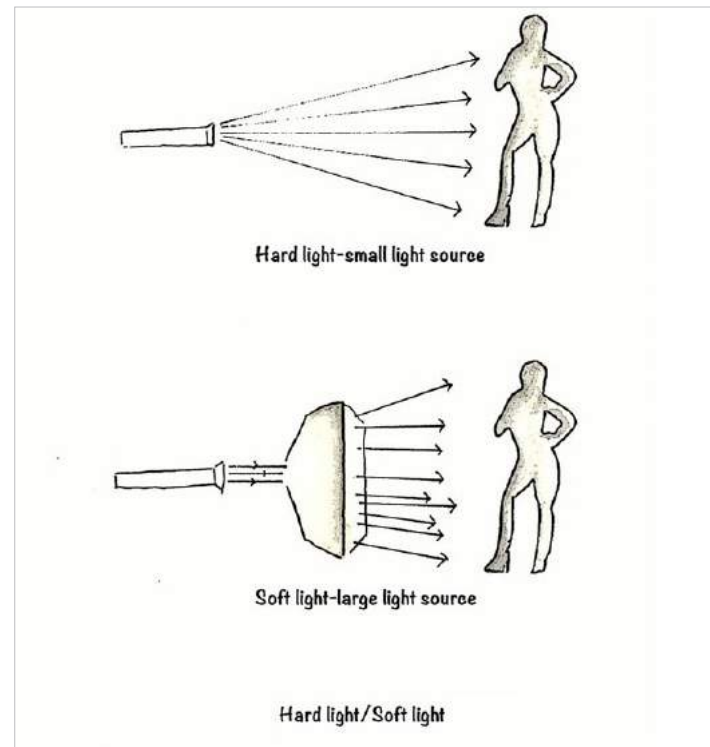

Design Course

Light and Photography

Creative Use of Light

by

Abhey Singh

IDC, IIT Bombay

Source:

<http://www.dsource.in/course/light-and-photography/properties-light>

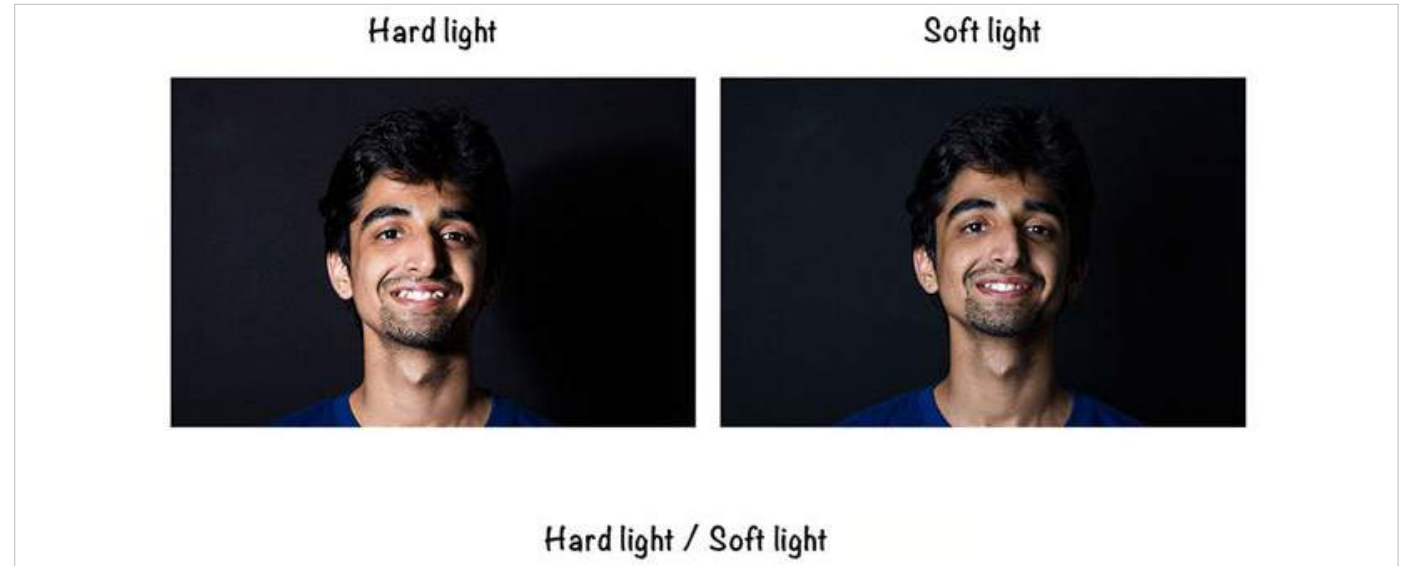

F. Natural Light and Artificial Light

Although the characteristics of light as an electromagnetic wave don't change whatever the source, for practical purposes in photography we make the distinction of natural/artificial light. In general terms the light from sources not made by mankind is termed as natural light and light from sources which are constructed by human beings is termed as artificial light.

Two most visible differences between natural and artificial light are:

1. The nature of fill
2. The rapid fall-off in intensity

In natural light sun is the only source but it bounces off from so many surfaces resulting in a wrap-around lighting. So sunlight behaves more like a Omni-directional light as compared to artificial light which is much directional. Due to inverse square law all light should fall with distance but due to the distance of sun and earth, any small increment we do on earth is negligible.

G. Polarisation

Light exhibit the behavior of both a particle and a wave. As a wave phenomenon a light wave can have vibrating waves in all directions, horizontal, vertical and in between. When reflected from a flat surface like water, most of the light aligns in one particular plane. This is known as polarised light. Polarisation property is used in making polarising filters which cancels light coming from a particular direction. It reduces glares coming from flat surfaces, thus making colours like blue in sky more dominant.

1. Introduction
2. What is Light
3. Properties of Light
4. Exposure
5. Types of Light
6. Types of Lighting
7. Light Examples
8. Contact Details

Design Course

Light and Photography

Creative Use of Light

by

Abhey Singh

IDC, IIT Bombay

Source:

<http://www.dsource.in/course/light-and-photography/exposure>

Exposure

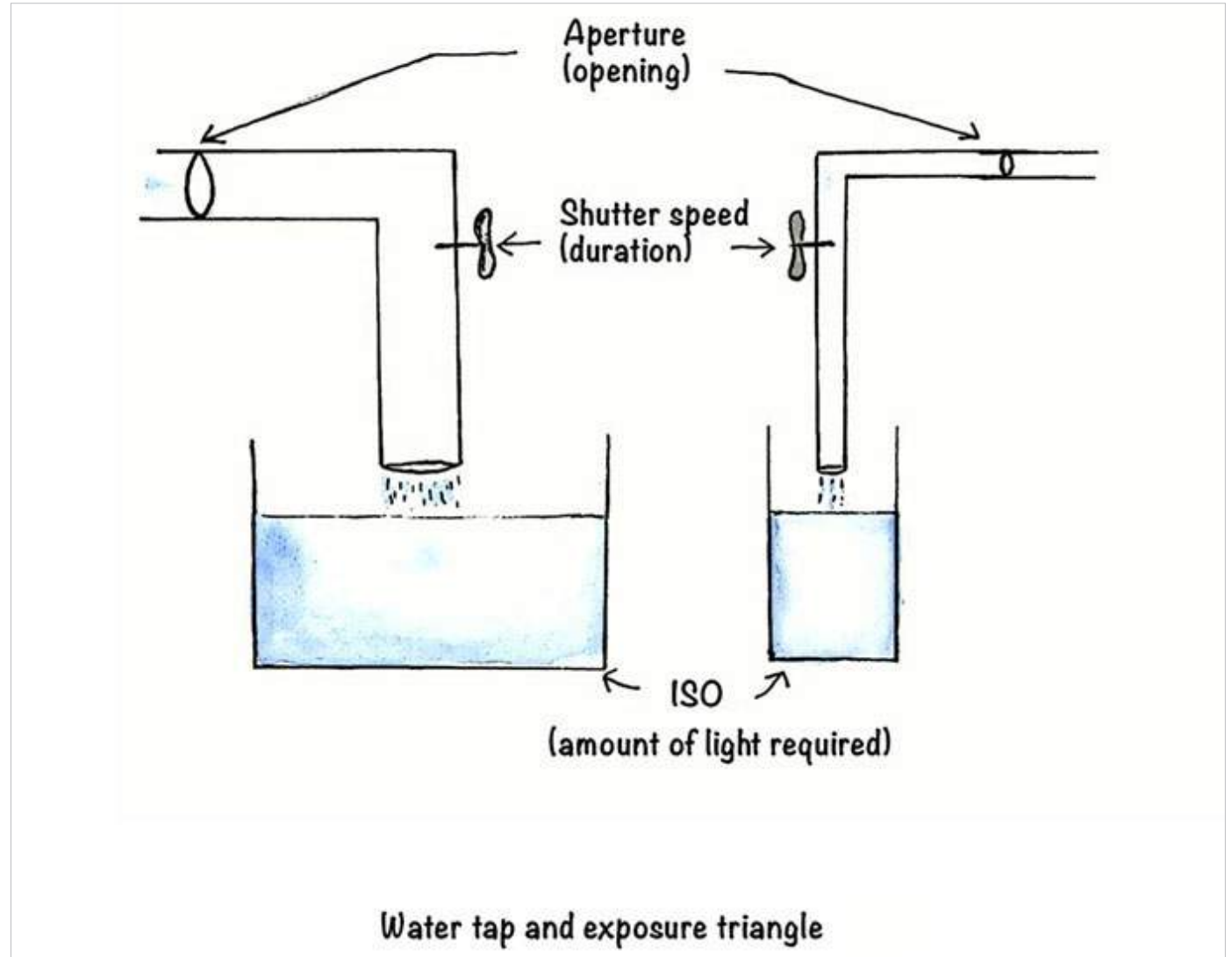

1. Introduction
2. What is Light
3. Properties of Light
4. **Exposure**
5. Types of Light
6. Types of Lighting
7. Light Examples
8. Contact Details

Design Course

Light and Photography

Creative Use of Light

by

Abhey Singh

IDC, IIT Bombay

Source:

<http://www.dsource.in/course/light-and-photography/exposure>

A. Aperture

Aperture

The opening of the lens which controls the amount of light entering the camera.

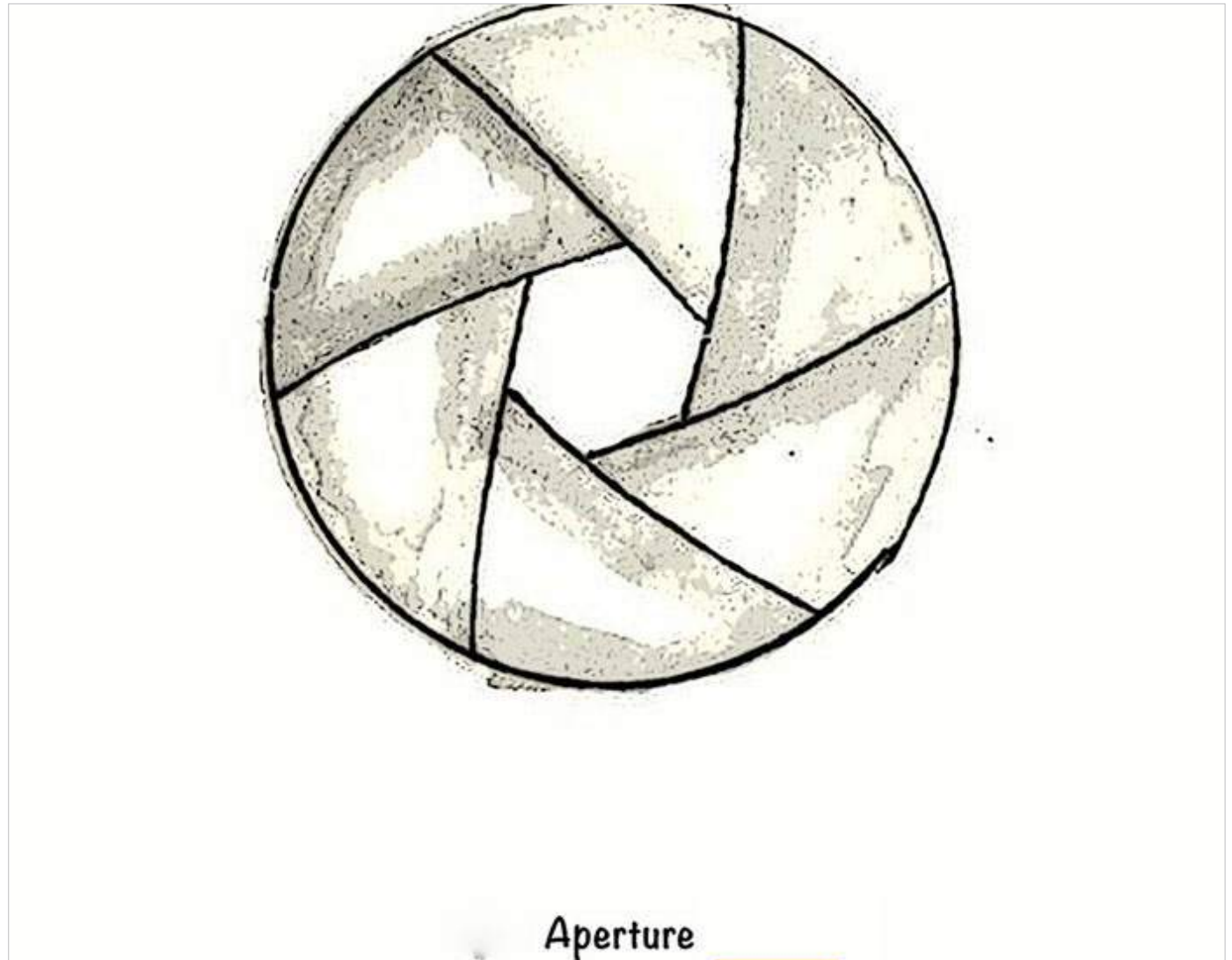

1. Introduction
2. What is Light
3. Properties of Light
4. **Exposure**
5. Types of Light
6. Types of Lighting
7. Light Examples
8. Contact Details

Design Course

Light and Photography

Creative Use of Light

by

Abhey Singh

IDC, IIT Bombay

Source:

<http://www.dsource.in/course/light-and-photography/exposure>

F-Number, F-stop, Focal Ratio, Relative Aperture

Quantitative unit used to measure the opening of aperture. Changing the f-number means changing the aperture. F-number is commonly notated using a hooked f i.e. f/N where N is the f-Number. As denoted in the formula for f-number, it has an inverse relation with aperture opening. A low f-number means larger opening and more light.

$$N=f/D$$

f= focal length

D= diameter of diaphragm

Stop

Stops are units used to quantify exposure. Changing one stop means doubling or halving the exposure. It is also known as exposure value (EV).

F-stop

F-stops are exposure values of aperture. Changing aperture by one f-stop means doubling or halving the light by doubling or halving the aperture opening.

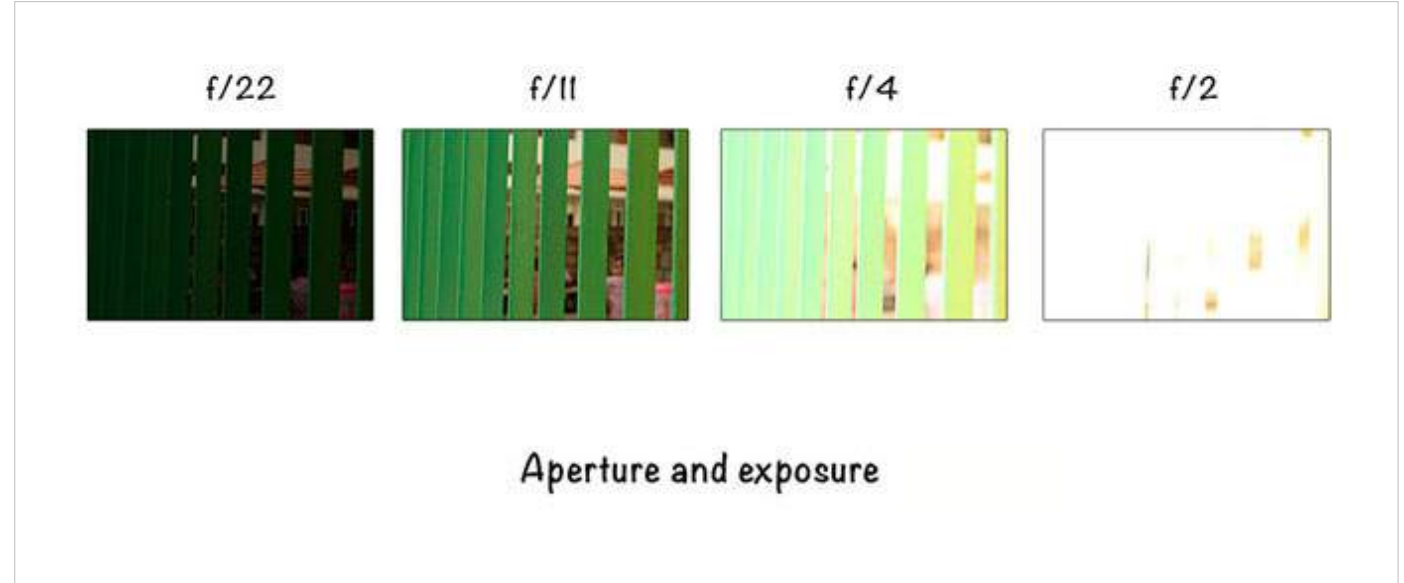

1. Introduction
2. What is Light
3. Properties of Light
4. **Exposure**
5. Types of Light
6. Types of Lighting
7. Light Examples
8. Contact Details

Design Course

Light and Photography

Creative Use of Light

by

Abhey Singh

IDC, IIT Bombay

Source:

<http://www.dsource.in/course/light-and-photography/exposure>

Depth of Field

The distance between the nearest and the farthest point in a scene that is recorded completely in focus.

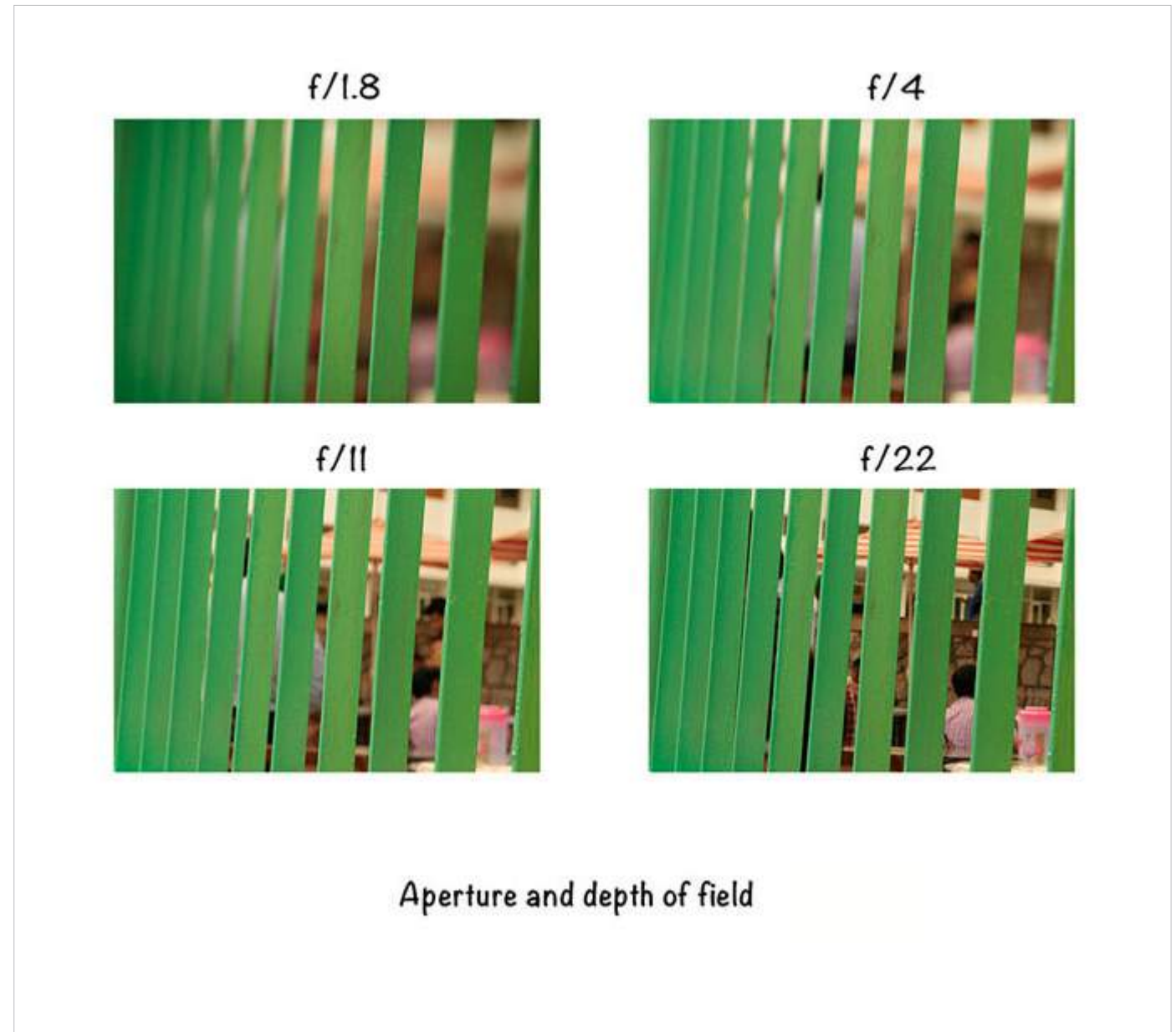

1. Introduction
2. What is Light
3. Properties of Light
4. **Exposure**
5. Types of Light
6. Types of Lighting
7. Light Examples
8. Contact Details

Design Course

Light and Photography

Creative Use of Light

by

Abhey Singh

IDC, IIT Bombay

Source:

<http://www.dsource.in/course/light-and-photography/exposure>

B. Shutter Speed

When you press camera shutter button, what happens is camera shutter opens up to allow light to hit the camera sensor. Shutter speed denotes the amount of time the camera shutter remains open when a photograph is clicked. Although it is named as speed, it is basically a measurement of time. To avoid the confusion of how aperture is measured in f-numbers and shutter speed in time, all the increment changes in aperture and shutter speed are denoted as stops.

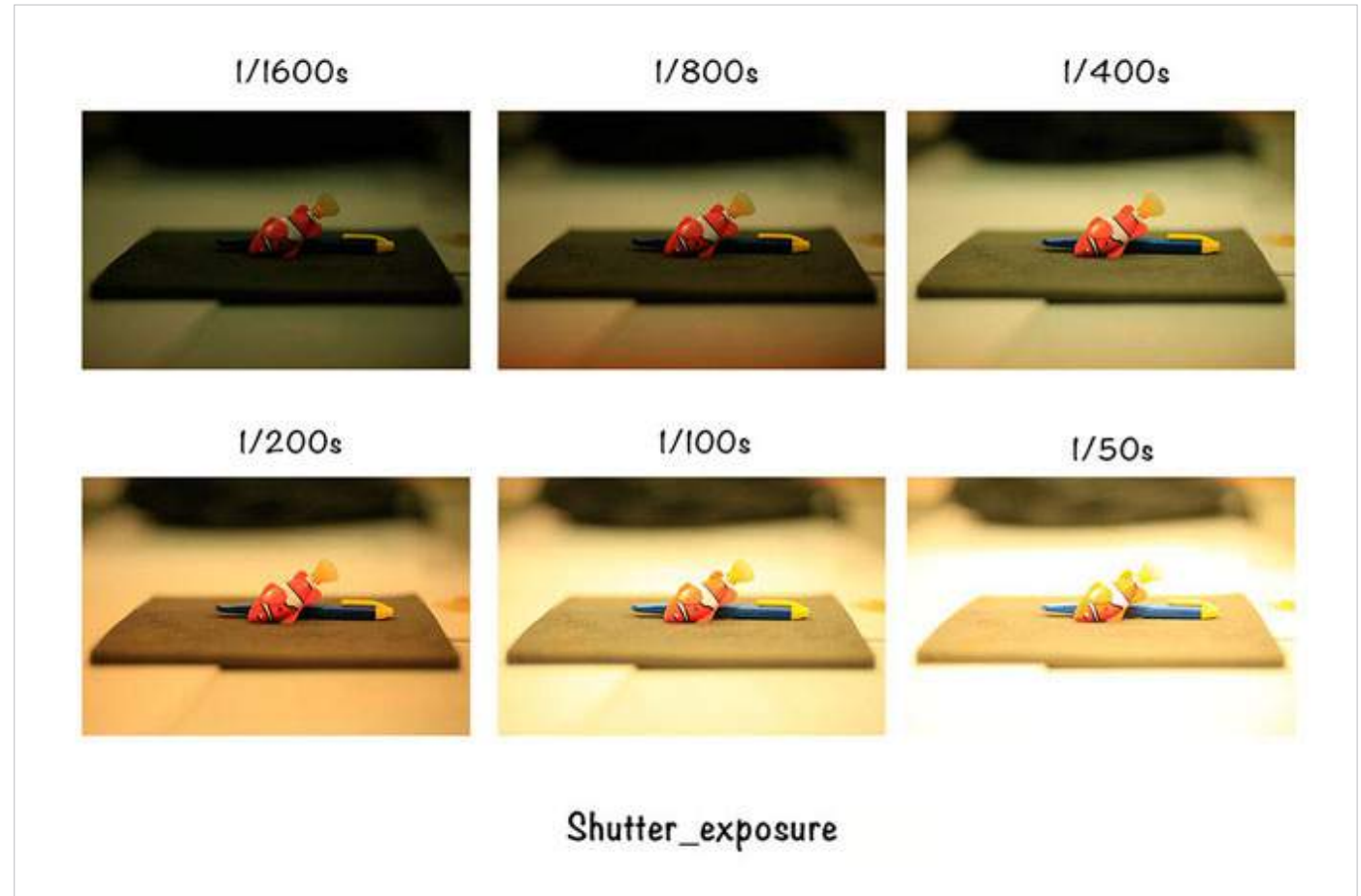

1. Introduction
2. What is Light
3. Properties of Light
4. **Exposure**
5. Types of Light
6. Types of Lighting
7. Light Examples
8. Contact Details

Design Course

Light and Photography

Creative Use of Light

by

Abhey Singh

IDC, IIT Bombay

Source:

<http://www.dsource.in/course/light-and-photography/exposure>

1. Introduction
2. What is Light
3. Properties of Light
4. **Exposure**
5. Types of Light
6. Types of Lighting
7. Light Examples
8. Contact Details

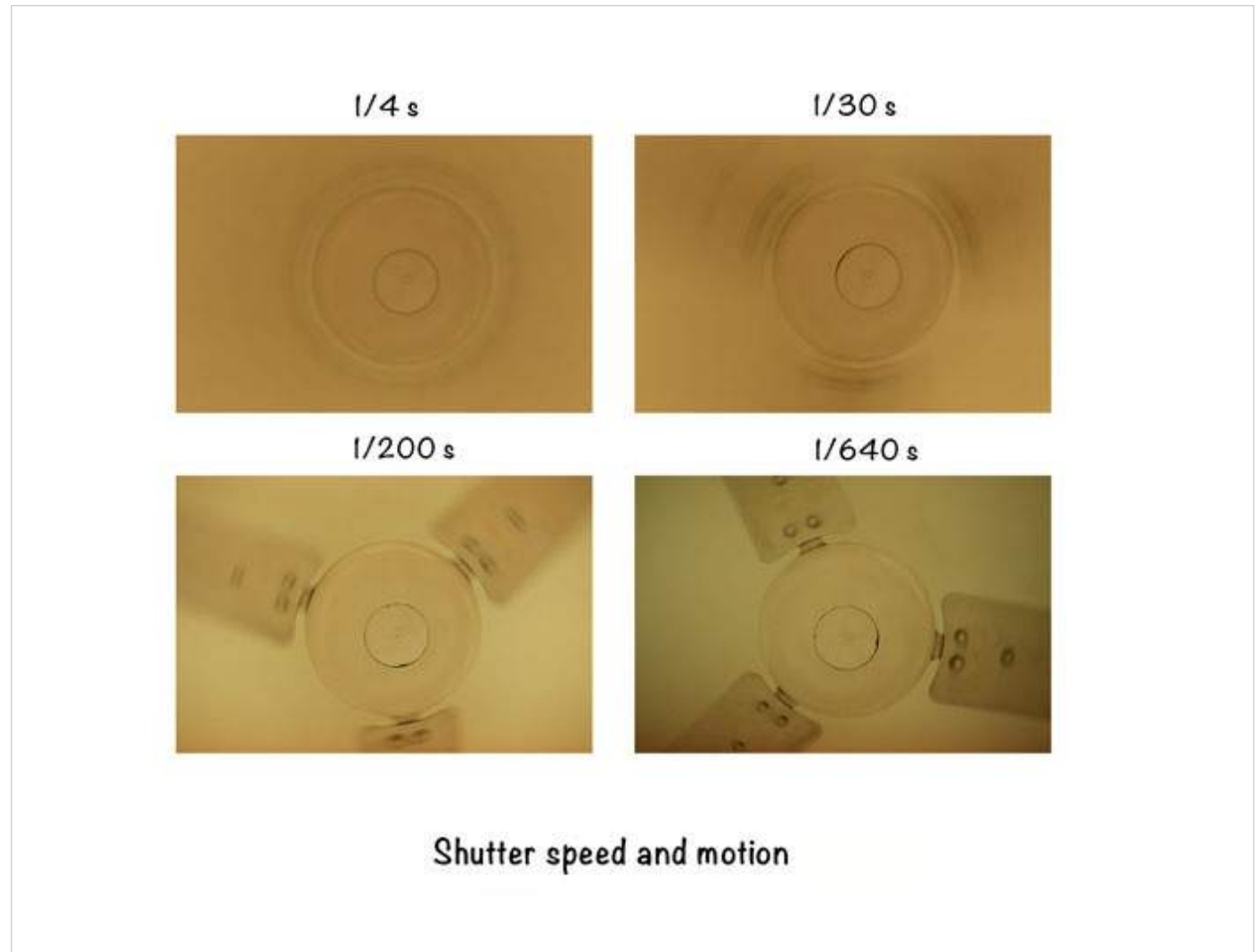

Design Course

Light and Photography

Creative Use of Light

by

Abhey Singh

IDC, IIT Bombay

Source:

<http://www.dsource.in/course/light-and-photography/exposure>

1. Introduction
2. What is Light
3. Properties of Light
4. **Exposure**
5. Types of Light
6. Types of Lighting
7. Light Examples
8. Contact Details

Reciprocal Relationship

Shutter speed and aperture shares inverse relation when it comes to exposure. If we increase aperture by one stop, we have to decrease shutter speed by one stop to maintain same exposure.

Increase by one stop of aperture = Double the exposure = Reducing f-number by one stop.

Increase by one stop of shutter speed = Double the exposure = Increasing the exposure time by one stop.

C. ISO

A measure of the sensitivity of the sensor/film. High ISO means more sensitive sensor/film and less amount of light is needed to make the exposure.

Noise

Presence of grains creating a speckled effect, most of the times due to high ISO.

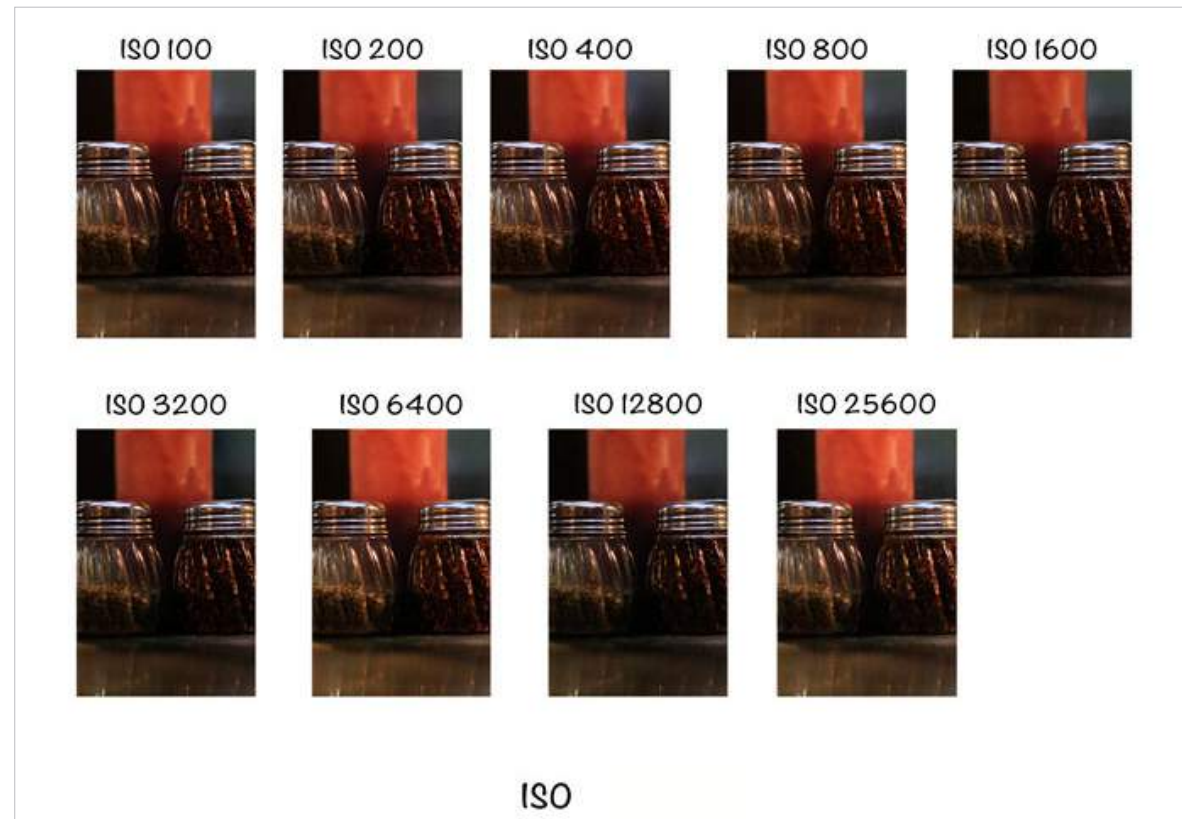

Design Course

Light and Photography

Creative Use of Light

by

Abhey Singh

IDC, IIT Bombay

Source:

<http://www.dsource.in/course/light-and-photography/exposure>

1. Introduction
2. What is Light
3. Properties of Light
4. **Exposure**
5. Types of Light
6. Types of Lighting
7. Light Examples
8. Contact Details

D. Metering

A photograph is made of light exposing a imagery on a surface. One of the basic factor in obtaining a good image is deciding the right amount of light required to make the image. Over the time various methods and instruments have been invented to determine the correct exposure.

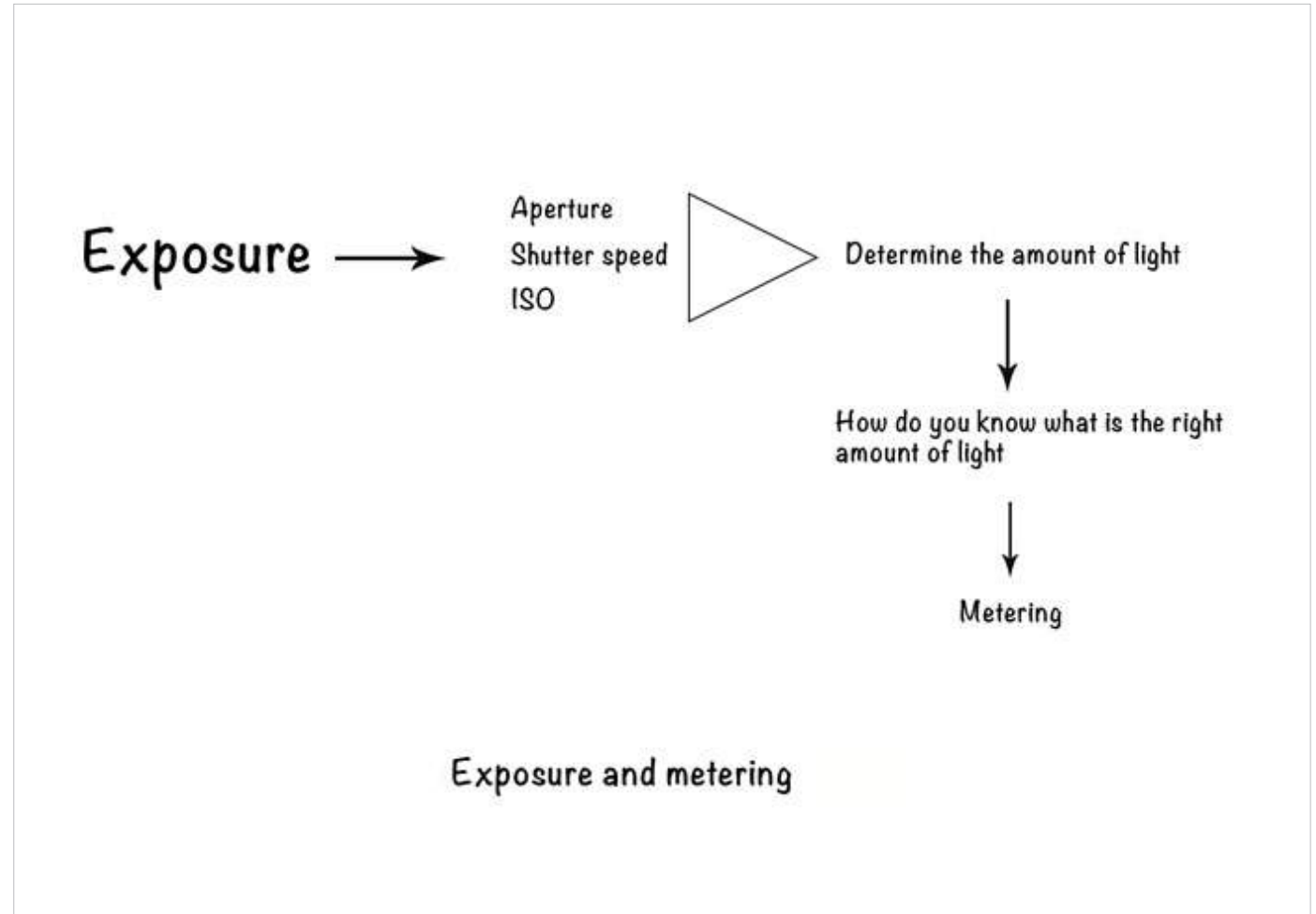

Design Course

Light and Photography

Creative Use of Light

by

Abhey Singh

IDC, IIT Bombay

Source:

<http://www.dsource.in/course/light-and-photography/exposure>

1. Introduction
2. What is Light
3. Properties of Light
4. **Exposure**
5. Types of Light
6. Types of Lighting
7. Light Examples
8. Contact Details

Metering

In photography metering refers to the mechanism a camera adopts to determine what would be the right amount of light for the particular scene.

Values/ Tones/ Dynamic Range

Values are basically various levels of greys. If we follow Ansel Adams model, there are 11 different groups of greys, ranging from 100 % black to 100% white.

18% Grey

18% grey is the grey tone which reflect 18% of the light. It is considered as the average of the entire tonal range. All the modern meters are based on assuming 18% grey as the average grey.

Incident Light Meter

It meters the light falling on the subject to determine the correct exposure. It is set according to the 18% grey reflectance irrespective of the subject.

Reflected Light Meter

It meters the light reflected from the subject to determine the right exposure for a image. Most of the DSLRs use this to determine the exposure. It works good in diversity of tones. It doesn't work that good when there are extreme tones or tones which belongs majorly to one extreme.

TTL Reflected Light Metering

It meters all the tones in the image and adjusts the exposure to bring the average to 18% grey. There are various ways for the camera to evaluate the scene and calculate the average.

Evaluative Metering

It takes into account all the pixels of the image and average them out to determine the exposure.

Centre-Weighed Average

It gives more weightage to the parts near the centre of the image in calculating the average.

Partial Metering

It takes into account a circle with centre at the mid of frame.

Spot-Metering

It only analyses the pixels around the centre to determine the exposure.

Design Course

Light and Photography

Creative Use of Light

by

Abhey Singh

IDC, IIT Bombay

Source:

<http://www.dsource.in/course/light-and-photography/exposure>

1. Introduction
2. What is Light
3. Properties of Light
4. **Exposure**
5. Types of Light
6. Types of Lighting
7. Light Examples
8. Contact Details

Evaluative



Center-weighted



Partial



Spot



Metering mode

Design Course

Light and Photography

Creative Use of Light

by

Abhey Singh

IDC, IIT Bombay

Source:

<http://www.dsource.in/course/light-and-photography/exposure>

E. Histogram

It is the graph of various values of grey versus number of pixels. It shows the distribution of various grey values with respect to the number of pixels with that grey value.

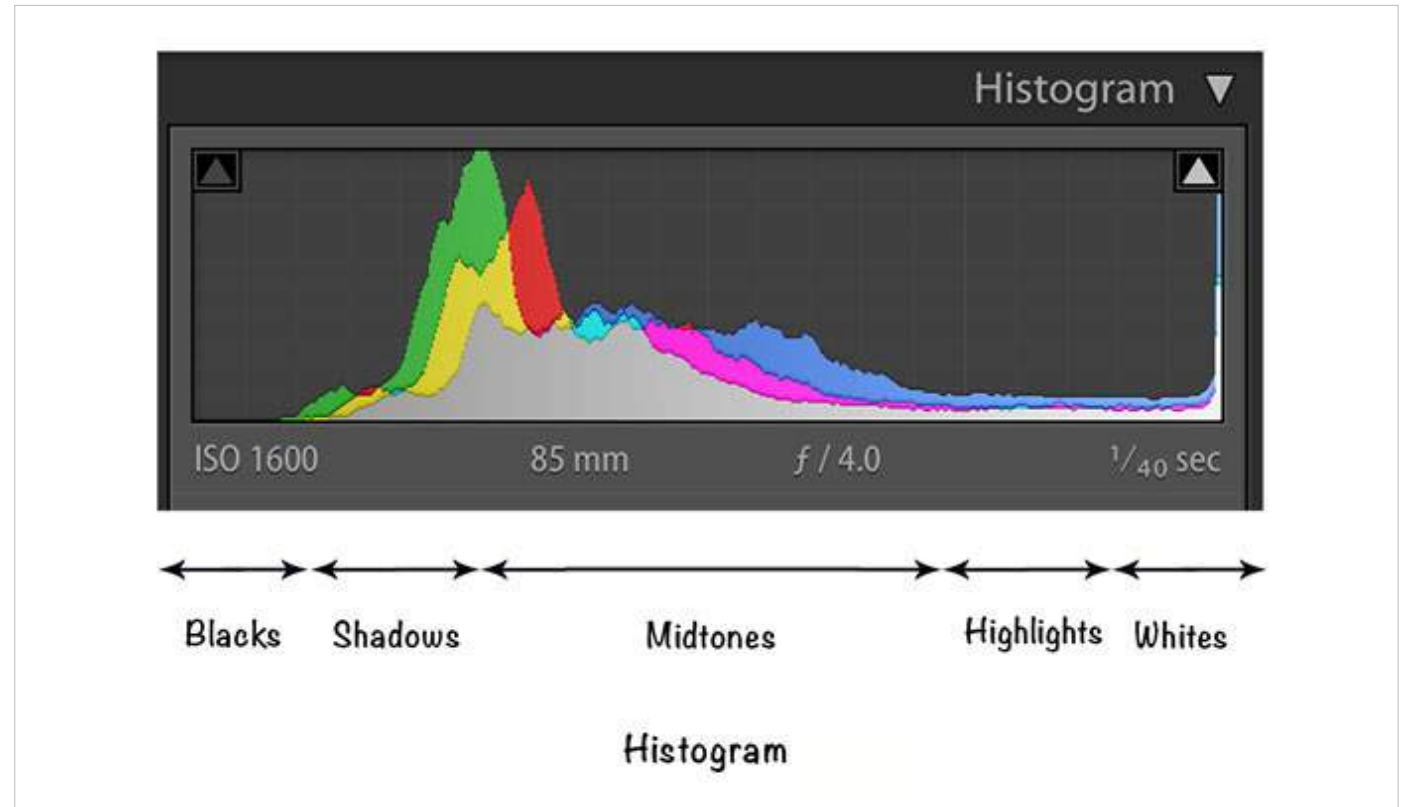

1. Introduction
2. What is Light
3. Properties of Light
4. **Exposure**
5. Types of Light
6. Types of Lighting
7. Light Examples
8. Contact Details

Design Course

Light and Photography

Creative Use of Light

by

Abhey Singh

IDC, IIT Bombay

Source:

<http://www.dsource.in/course/light-and-photography/exposure>

Highlights/ Shadows/ Mid-tones

The dynamic range of the camera is commonly divided in three segments. Highlights are the white areas, shadows are the dark areas and mid-tones are the grays in between.

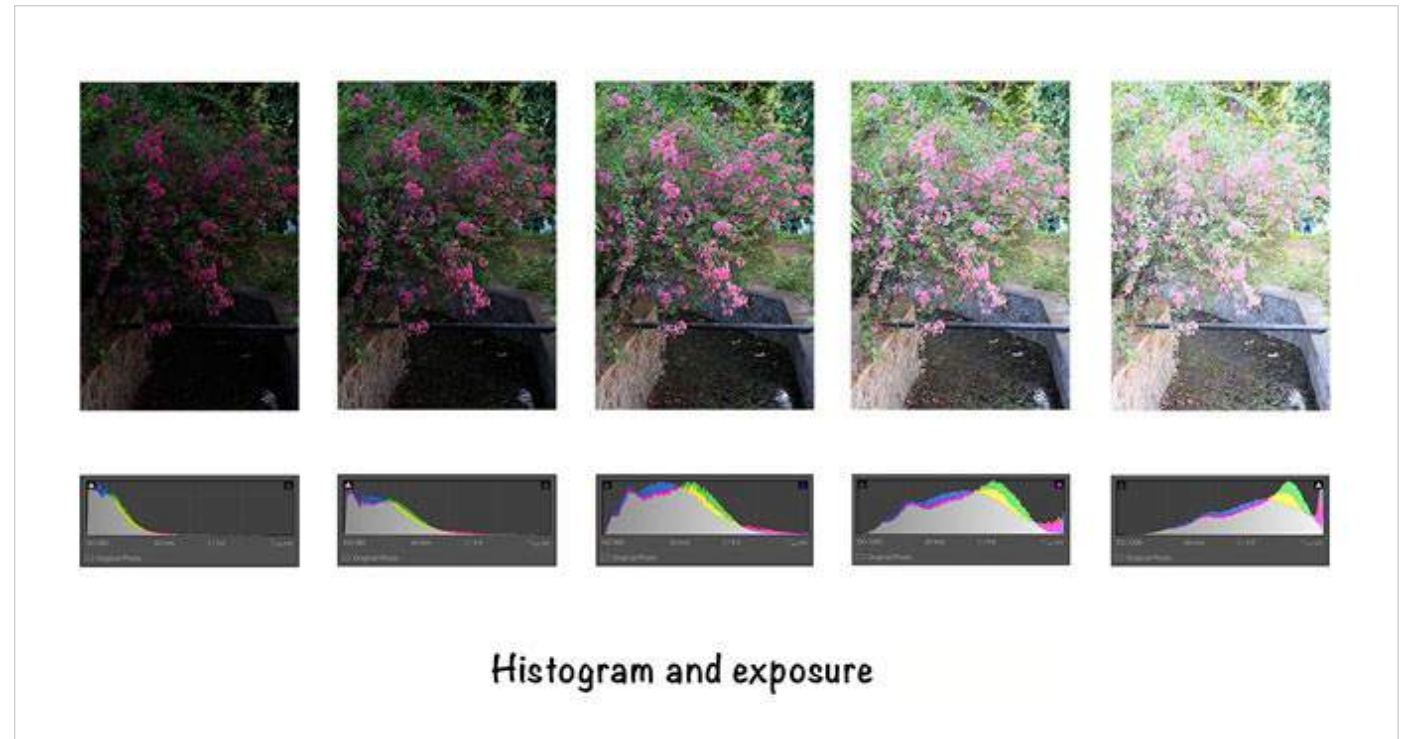

1. Introduction
2. What is Light
3. Properties of Light
4. **Exposure**
5. Types of Light
6. Types of Lighting
7. Light Examples
8. Contact Details

Design Course

Light and Photography

Creative Use of Light

by

Abhey Singh

IDC, IIT Bombay







Source:

<http://www.dsource.in/course/light-and-photography/exposure>

1. Introduction
2. What is Light
3. Properties of Light
4. **Exposure**
5. Types of Light
6. Types of Lighting
7. Light Examples
8. Contact Details

F. Exposure Compensation

Technique for adjusting exposure indicated by exposure meter. It is used in conditions when meters are unable to give right reading or we consciously want a underexposed or over exposed image.

Without exposure compensation	With exposure compensation	
		Too much black in the image so the meter gets tricked and over-expose the white subject
		A bright light source in the image so the meter gets tricked and under-expose the subject (subject here is the person)
		Too much white in the image so the meter gets tricked and under-expose the subject (subject here is the person)
Exposure compensation		

Design Course

Light and Photography

Creative Use of Light

by

Abhey Singh

IDC, IIT Bombay

Source:

<http://www.dsource.in/course/light-and-photography/types-light>

Types of Light

Key/ Fill/ Back light**Key Light**

As the name suggests this is the most important light. Key light defines the shadows in a composition. All the other lights are placed according to the key light.

Fill Light

A fill light is used to open up the shadows. Ideally fill light doesn't have its own shadow as it is generally less in intensity than the key light.

Kicker/ Rim/ Accent Light

Lights that outline the subject and separate the subject from the background. These lights are also known as side lights or hair light depending on where they are placed. These lights help in popping the subject out. This light contributes to the lightest tones and specular highlights.

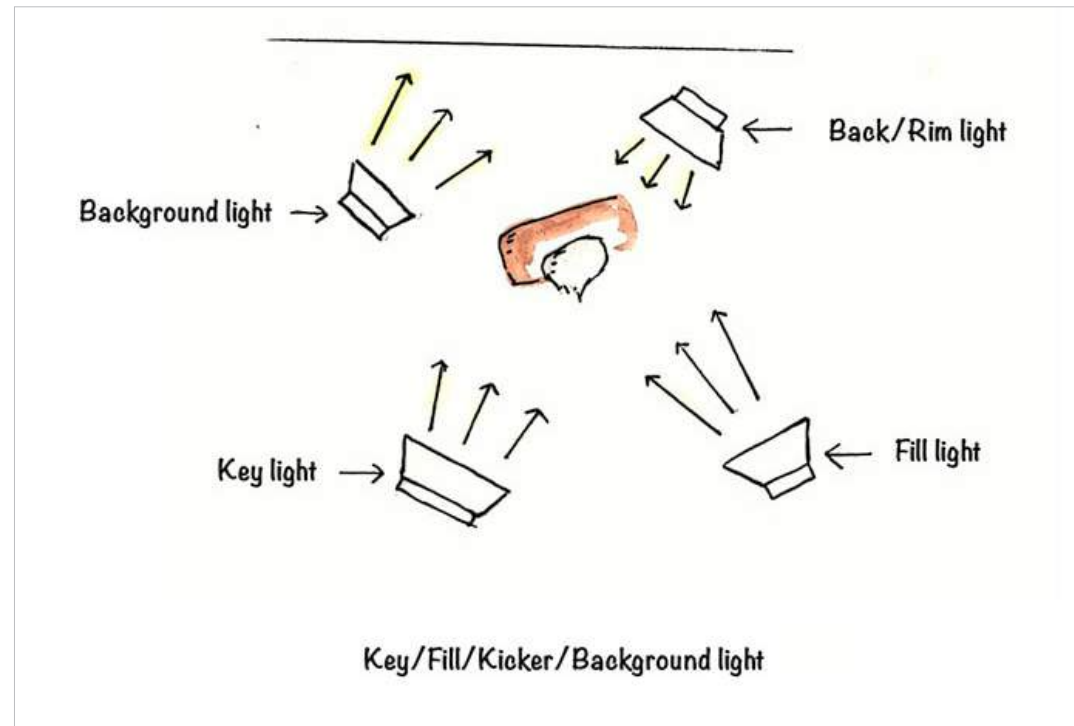

1. Introduction
2. What is Light
3. Properties of Light
4. Exposure
5. **Types of Light**
6. Types of Lighting
7. Light Examples
8. Contact Details

Design Course

Light and Photography

Creative Use of Light

by

Abhey Singh

IDC, IIT Bombay

Source:

<http://www.dsource.in/course/light-and-photography/types-light>

1. Introduction
2. What is Light
3. Properties of Light
4. Exposure
5. **Types of Light**
6. Types of Lighting
7. Light Examples
8. Contact Details

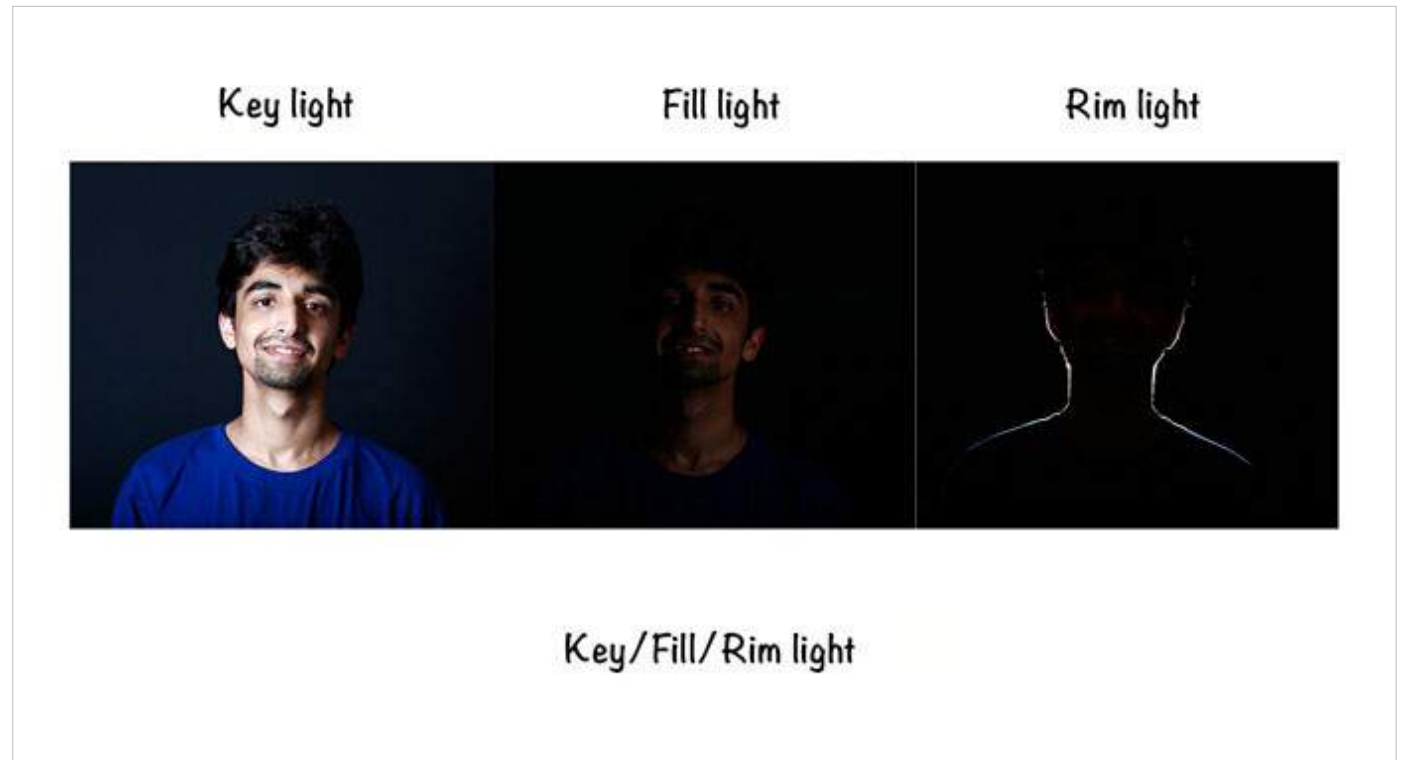

How To Set The Light?

1. Set The Key Light

Position the key light to define the shadows.

2. Add Fill

Add fill light depending on how much details you want in the shadows.

3. Look For Rim Lights

See if you can have a rim light from side or back which can add further to the image.

Design Course

Light and Photography

Creative Use of Light

by

Abhey Singh

IDC, IIT Bombay

Source:

<http://www.dsource.in/course/light-and-photography/types-light>

Lighting Ratios

The ratio between the key light and the fill light. It is calculated as ratio between- Key+Fill : Fill. A 2:1 ratio means flat lighting where both sides of face are lit evenly.



Key/ Fill/ Rim light

1. Introduction
2. What is Light
3. Properties of Light
4. Exposure
5. **Types of Light**
6. Types of Lighting
7. Light Examples
8. Contact Details

Design Course

Light and Photography

Creative Use of Light

by

Abhey Singh

IDC, IIT Bombay

Source:

<http://www.dsource.in/course/light-and-photography/types-lighting>

1. Introduction
2. What is Light
3. Properties of Light
4. Exposure
5. Types of Light
6. **Types of Lighting**
7. Light Examples
8. Contact Details

Types of Lighting

Front Lighting

Key light is directly behind the camera giving the subject an even exposure. This kind of lighting is most simple and easy to meter. In natural light conditions we can see this type of light in first hour after sunrise and last few hours of daylight.

Side Lighting

Key light is coming from one side. Front lighting might render a subject 2-dimensional, side lighting gives it a volume and 3-dimensional look. This evokes stronger response from the audience especially when taking portraits.

Back Lighting

Key light is behind the subject. Silhouette pictures are best examples of this kind of lighting. By adding fill light it can be used beautifully for portraits where back-light acts like a rim light.

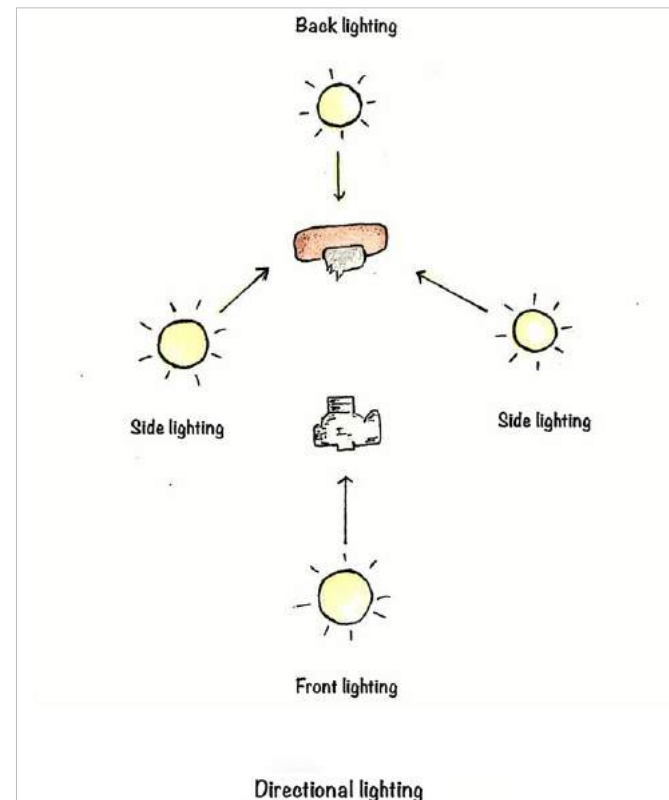

Design Course

Light and Photography

Creative Use of Light

by

Abhey Singh

IDC, IIT Bombay

Source:

<http://www.dsource.in/course/light-and-photography/types-lighting>

1. Introduction
2. What is Light
3. Properties of Light
4. Exposure
5. Types of Light
6. **Types of Lighting**
7. Light Examples
8. Contact Details



Design Course

Light and Photography

Creative Use of Light

by

Abhey Singh

IDC, IIT Bombay

Source:

<http://www.dsource.in/course/light-and-photography/light-examples>

Light Examples



Morning one source light working as backlight.

1. Introduction
2. What is Light
3. Properties of Light
4. Exposure
5. Types of Light
6. Types of Lighting
7. **Light Examples**
8. Contact Details



Design Course

Light and Photography

Creative Use of Light

by

Abhey Singh

IDC, IIT Bombay

Source:

<http://www.dsource.in/course/light-and-photography/light-examples>

1. Introduction
2. What is Light
3. Properties of Light
4. Exposure
5. Types of Light
6. Types of Lighting
7. **Light Examples**
8. Contact Details



Two big light sources from above give this rim light around the head.



Design Course

Light and Photography

Creative Use of Light

by

Abhey Singh

IDC, IIT Bombay

Source:

<http://www.dsource.in/course/light-and-photography/light-examples>

1. Introduction
2. What is Light
3. Properties of Light
4. Exposure
5. Types of Light
6. Types of Lighting
7. **Light Examples**
8. Contact Details



Backlight creating a rim light around the body.



Design Course

Light and Photography

Creative Use of Light

by

Abhey Singh

IDC, IIT Bombay

Source:

<http://www.dsource.in/course/light-and-photography/light-examples>

1. Introduction
2. What is Light
3. Properties of Light
4. Exposure
5. Types of Light
6. Types of Lighting
7. **Light Examples**
8. Contact Details



Light patterns created from trees.



Design Course

Light and Photography

Creative Use of Light

by

Abhey Singh

IDC, IIT Bombay

Source:

<http://www.dsource.in/course/light-and-photography/light-examples>

1. Introduction
2. What is Light
3. Properties of Light
4. Exposure
5. Types of Light
6. Types of Lighting
7. **Light Examples**
8. Contact Details



Street light, giving one-directional hard light form above at an angle.



Design Course

Light and Photography

Creative Use of Light

by

Abhey Singh

IDC, IIT Bombay

Source:

<http://www.dsource.in/course/light-and-photography/light-examples>

1. Introduction
2. What is Light
3. Properties of Light
4. Exposure
5. Types of Light
6. Types of Lighting
7. **Light Examples**
8. Contact Details



Evening soft side light, giving a soft skin but dark areas under eyes.



Design Course

Light and Photography

Creative Use of Light

by

Abhey Singh

IDC, IIT Bombay

Source:

<http://www.dsource.in/course/light-and-photography/light-examples>

1. Introduction
2. What is Light
3. Properties of Light
4. Exposure
5. Types of Light
6. Types of Lighting
7. **Light Examples**
8. Contact Details



Backlight from the car creating a silhouette.



Design Course

Light and Photography

Creative Use of Light

by

Abhey Singh

IDC, IIT Bombay

Source:

<http://www.dsource.in/course/light-and-photography/light-examples>

1. Introduction
2. What is Light
3. Properties of Light
4. Exposure
5. Types of Light
6. Types of Lighting
7. **Light Examples**
8. Contact Details

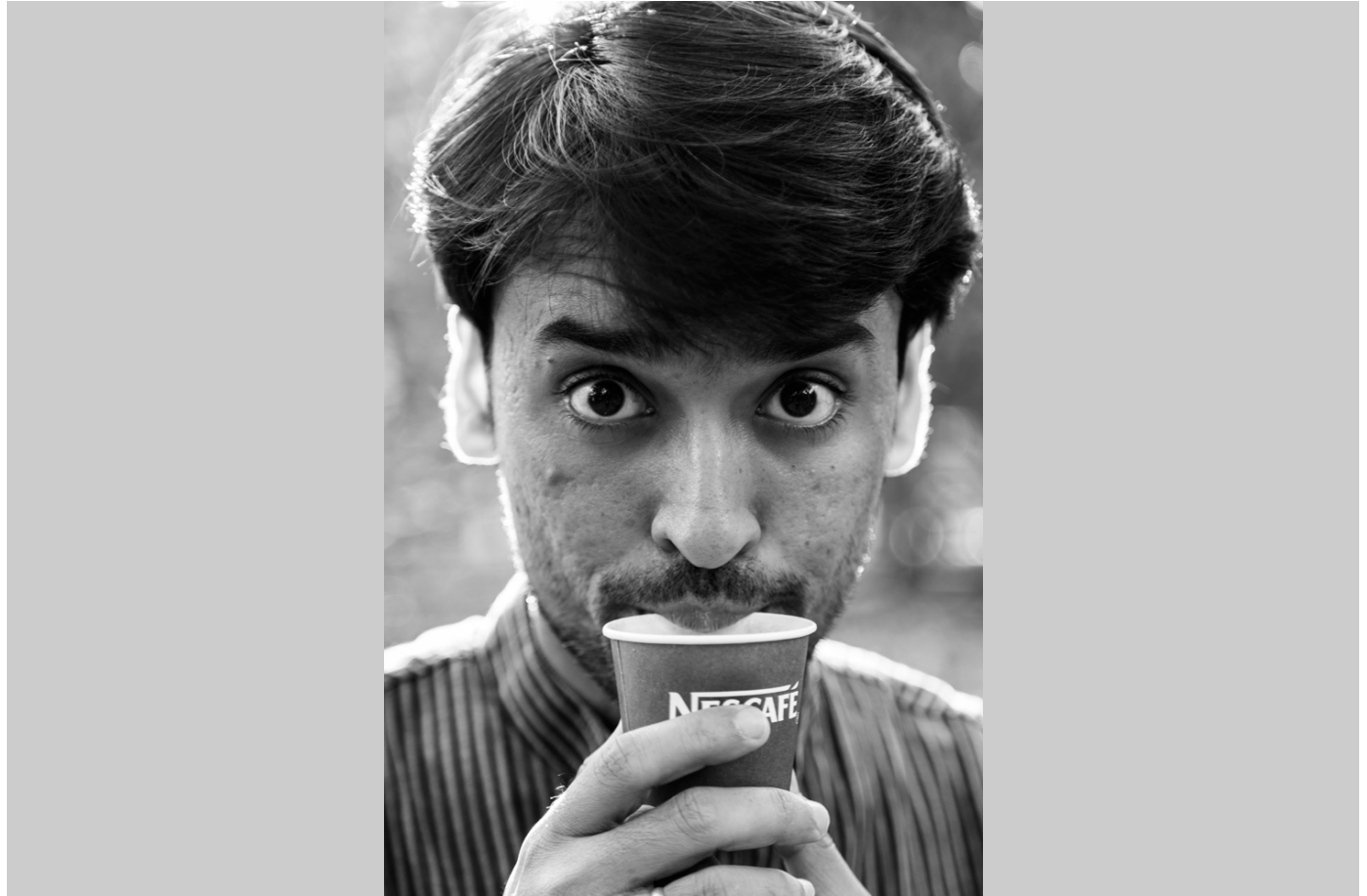

Using natural evening light to create a rim light, separating the person from background.



Design Course

Light and Photography

Creative Use of Light

by

Abhey Singh

IDC, IIT Bombay

Source:

<http://www.dsource.in/course/light-and-photography/light-examples>

1. Introduction
2. What is Light
3. Properties of Light
4. Exposure
5. Types of Light
6. Types of Lighting
7. **Light Examples**
8. Contact Details



Use of natural light at evening as rim light.



Design Course

Light and Photography

Creative Use of Light

by

Abhey Singh

IDC, IIT Bombay

Source:

<http://www.dsource.in/course/light-and-photography/light-examples>

1. Introduction
2. What is Light
3. Properties of Light
4. Exposure
5. Types of Light
6. Types of Lighting
7. **Light Examples**
8. Contact Details



Using a additional light(flash) from side, balancing the exposure on subject and background.



Design Course

Light and Photography

Creative Use of Light

by

Abhey Singh

IDC, IIT Bombay

Source:

<http://www.dsource.in/course/light-and-photography/light-examples>

1. Introduction
2. What is Light
3. Properties of Light
4. Exposure
5. Types of Light
6. Types of Lighting
7. **Light Examples**
8. Contact Details



Light patch used to give contrast to subject, a flat front light.



Design Course

Light and Photography

Creative Use of Light

by

Abhey Singh

IDC, IIT Bombay

Source:

<http://www.dsource.in/course/light-and-photography/light-examples>

1. Introduction
2. What is Light
3. Properties of Light
4. Exposure
5. Types of Light
6. Types of Lighting
7. **Light Examples**
8. Contact Details



Morning light angle used to make silhouette.



Design Course

Light and Photography

Creative Use of Light

by

Abhey Singh

IDC, IIT Bombay

Source:

<http://www.dsource.in/course/light-and-photography/light-examples>

1. Introduction
2. What is Light
3. Properties of Light
4. Exposure
5. Types of Light
6. Types of Lighting
7. **Light Examples**
8. Contact Details



Stark afternoon light making some hard shapes.



Design Course

Light and Photography

Creative Use of Light

by

Abhey Singh

IDC, IIT Bombay

Source:

<http://www.dsource.in/course/light-and-photography/light-examples>

1. Introduction
2. What is Light
3. Properties of Light
4. Exposure
5. Types of Light
6. Types of Lighting
7. **Light Examples**
8. Contact Details



Window light, soft side light, defines the shape in a portrait well.



Design Course

Light and Photography

Creative Use of Light

by

Abhey Singh

IDC, IIT Bombay

Source:

<http://www.dsource.in/course/light-and-photography/light-examples>

1. Introduction
2. What is Light
3. Properties of Light
4. Exposure
5. Types of Light
6. Types of Lighting
7. **Light Examples**
8. Contact Details



Soft Side light.



Design Course

Light and Photography

Creative Use of Light

by

Abhey Singh

IDC, IIT Bombay

Source:

<http://www.dsource.in/course/light-and-photography/light-examples>

1. Introduction
2. What is Light
3. Properties of Light
4. Exposure
5. Types of Light
6. Types of Lighting
7. **Light Examples**
8. Contact Details



The windows above provide a soft rim light, while the water reflection provide fill light.



Design Course

Light and Photography

Creative Use of Light

by

Abhey Singh

IDC, IIT Bombay

Source:

<http://www.dsource.in/course/light-and-photography/contact-details>

Contact Details

This documentation for the course was designed by Abhey Singh at [IDC, IIT Bombay](#).

You can get in touch with him at
Email: [abheysingh333\[at\]gmail.com](mailto:abheysingh333[at]gmail.com)

You could write to the following address regarding suggestions and clarifications:

Helpdesk Details:

Co-ordinator
Project e-kalpa
Industrial Design Centre
IIT Bombay
Powai
Mumbai 400076
India

Phone: 091-22-25767820/ 7801/ 7802

Fax: 091-22-25767803

Email: [dsource.in\[at\]gmail.com](mailto:dsource.in[at]gmail.com)

1. Introduction
2. What is Light
3. Properties of Light
4. Exposure
5. Types of Light
6. Types of Lighting
7. Light Examples
8. **Contact Details**