

Fundamentals of Geometry

Oleg A. Belyaev
belyaev@polly.phys.msu.ru

February 28, 2007

Contents

I	Classical Geometry	1
1	Absolute (Neutral) Geometry	3
1.1	Incidence	3
	Hilbert's Axioms of Incidence	3
	Consequences of Incidence Axioms	4
1.2	Betweenness and Order	7
	Hilbert's Axioms of Betweenness and Order	7
	Basic Properties of Betweenness Relation	8
	Betweenness Properties for n Collinear Points	14
	Every Open Interval Contains Infinitely Many Points	15
	Further Properties of Open Intervals	15
	Open Sets and Fundamental Topological Properties	18
	Basic Properties of Rays	18
	Linear Ordering on Rays	21
	Ordering on Lines	22
	Complementary Rays	25
	Point Sets on Rays	26
	Basic Properties of Half-Planes	27
	Point Sets on Half-Planes	29
	Complementary Half-Planes	30
	Basic Properties of Angles	35
	Definition and Basic Properties of Generalized Betweenness Relations	46
	Further Properties of Generalized Betweenness Relations	52
	Generalized Betweenness Relation for n Geometric Objects	53
	Some Properties of Generalized Open Intervals	55
	Basic Properties of Generalized Rays	56
	Linear Ordering on Generalized Rays	58
	Linear Ordering on Sets With Generalized Betweenness Relation	59
	Complementary Generalized Rays	61
	Sets of Geometric Objects on Generalized Rays	61
	Betweenness Relation for Rays	63
	Betweenness Relation For n Rays With Common Initial Point	64
	Basic Properties of Angular Rays	65
	Line Ordering on Angular Rays	66
	Line Ordering on Pencils of Rays	67
	Complementary Angular Rays	68
	Sets of (Traditional) Rays on Angular Rays	68
	Paths and Polygons: Basic Concepts	69
	Simplicity and Related Properties	72
	Some Properties of Triangles and Quadrilaterals	73
	Basic Properties of Trapezoids and Parallelograms	78
	Basic Properties of Half-Spaces	80
	Point Sets in Half-Spaces	81
	Complementary Half-Spaces	82
	Basic Properties of Dihedral Angles	87
	Betweenness Relation for Half-Planes	98
	Betweenness Relation for n Half-Planes with Common Edge	102
	Basic Properties of Dihedral Angular Rays	104
	Linear Ordering on Dihedral Angular Rays	105
	Line Ordering on Pencils of Half-Planes	106
	Complementary Dihedral Angular Rays	107

	Sets of Half-Planes on Dihedral Angular Rays	107
	Properties of Convex Polygons	108
1.3	Congruence	110
	Hilbert's Axioms of Congruence	110
	Basic Properties of Congruence	111
	Congruence of Triangles: SAS & ASA	113
	Congruence of Adjacent Supplementary and Vertical Angles	114
	Right Angles and Orthogonality	117
	Congruence and Betweenness for Intervals	118
	Congruence and Betweenness for Angles	119
	Congruence of Triangles:SSS	121
	Congruence of Angles and Congruence of Paths as Equivalence Relations	121
	Comparison of Intervals	123
	Generalized Congruence	126
	Comparison of Generalized Intervals	129
	Comparison of Angles	131
	Acute, Obtuse and Right Angles	133
	Interior and Exterior Angles	134
	Relations Between Intervals and Angles	136
	SAA	141
	Relations Between Intervals Divided into Congruent Parts	144
	Midpoints	148
	Triangle Medians, Bisectors, and Altitudes	151
	Congruence and Parallelism	153
	Right Bisectors of Intervals	157
	Isometries on the Line	162
	Isometries of Collinear Figures	166
	General Notion of Symmetry	167
	Comparison of Dihedral Angles	187
	Acute, Obtuse and Right Dihedral Angles	189
1.4	Continuity, Measurement, and Coordinates	208
	Axioms of Continuity	208
2	Elementary Euclidean Geometry	229
2.1	229
3	Elementary Hyperbolic (Lobachevskian) Geometry	235
3.1	235
4	Elementary Projective Geometry	249

Notation

Symbol	Meaning
\doteq	The symbol on the left of \doteq equals by definition the expression on the right of \doteq .
$\stackrel{\text{def}}{\iff}$	The expression on the left of $\stackrel{\text{def}}{\iff}$ equals by definition the expression on the right of $\stackrel{\text{def}}{\iff}$.
\mathbb{N}	The set of natural numbers (positive integers).
\mathbb{N}^0	The set $\mathbb{N}^0 \doteq \{0\} \cup \mathbb{N}$ of nonnegative integers.
\mathbb{N}_n	The set $\{1, 2, \dots, n\}$, where $n \in \mathbb{N}$.

Symbol	Meaning	Page
A, B, C, \dots	Capital Latin letters usually denote points.	3
a, b, c, \dots	Small Latin letters usually denote lines.	3
$\alpha, \beta, \gamma, \dots$	Small Greek letters usually denote planes.	3
\mathcal{C}^{Pt}	The class of all points.	3
\mathcal{C}^L	The class of all lines.	3
\mathcal{C}^{Pl}	The class of all planes.	3
a_{AB}	Line drawn through A, B .	3
α_{ABC}	Plane incident with the non-collinear points A, B, C	3
$\mathcal{P}_a \equiv \{A A \in a\}$	The set of all points ("contour") of the line a	3
$\mathcal{P}_\alpha \equiv \{A A \in \alpha\}$	The set of all points ("contour") of the plane α	3
$a \subset \alpha$	Line a lies on plane α , plane α goes through line a .	3
$\mathcal{X} \subset \mathcal{P}_a$	The figure (geometric object) \mathcal{X} lies on line a .	3
$\mathcal{X} \subset \mathcal{P}_\alpha$	The figure (geometric object) \mathcal{X} lies on plane α .	3
$A \in a \cap b$	Line a meets line b in a point A	4
$A \in a \cap \beta$	Line a meets plane β in a point A .	4
$A \in a \cap \mathcal{B}$	Line a meets figure \mathcal{B} in a point A .	4
$\mathcal{A} \in a \cap \mathcal{B}$	Figure \mathcal{A} meets figure \mathcal{B} in a point A .	4
α_{aA}	Plane drawn through line a and point A .	5
$a \parallel b$	line a is parallel to line b , i.e. a, b coplane and do not meet.	6
ab	an abstract strip ab is a pair of parallel lines a, b .	6
$a \parallel \alpha$	line a is parallel to plane α , i.e. a, α do not meet.	6
$\alpha \parallel \beta$	plane α is parallel to plane β , i.e. α, β do not meet.	6
α_{ab}	Plane containing lines a, b , whether parallel or having a common point.	7
$[ABC]$	Point B lies between points A, C .	7
AB	(Abstract) interval with ends A, B , i.e. the set $\{A, B\}$.	7
(AB)	Open interval with ends A, B , i.e. the set $\{C [ACB]\}$.	7
$[AB)$	Half-open interval with ends A, B , i.e. the set $(AB) \cup \{A, B\}$.	7
$(AB]$	Half-closed interval with ends A, B , i.e. the set $(AB) \cup \{B\}$.	7
$[AB]$	Closed interval with ends A, B , i.e. the set $(AB) \cup \{A, B\}$.	7
$Int\mathcal{X}$	Interior of the figure (point set) \mathcal{X} .	7
$Ext\mathcal{X}$	Exterior of the figure (point set) \mathcal{X} .	7
$[A_1A_2 \dots A_n \dots]$	Points $A_1, A_2, \dots, A_n, \dots$, where $n \in \mathbb{N}, n \geq 3$ are in order $[A_1A_2 \dots A_n \dots]$.	15
O_A	Ray through O emanating from A , i.e. $O_A \equiv \{B B \in a_{OA} \& B \neq O \& \neg[AOB]\}$.	18
\bar{h}	The line containing the ray h .	18
$O = \partial h$	The initial point of the ray h .	18
$(A \prec B)_{O_D}, A \prec B$	Point A precedes the point B on the ray O_D , i.e. $(A \prec B)_{O_D} \stackrel{\text{def}}{\iff} [OAB]$.	21
$A \preceq B$	A either precedes B or coincides with it, i.e. $A \preceq B \stackrel{\text{def}}{\iff} (A \prec B) \vee (A = B)$.	21
$(A \prec B)_a, A \prec B$	Point A precedes point B on line a .	22
$(A \prec_1 B)_a$	A precedes B in direct order on line a .	22
$(A \prec_2 B)_a$	A precedes B in inverse order on line a .	22
O_A^c	Ray, complementary to the ray O_A .	25
$(ABa)_\alpha, ABa$	Points A, B lie (in plane α) on the same side of the line a .	27
$(AaB)_\alpha, AaB$	Points A, B lie (in plane α) on opposite sides of the line a .	27
a_A	Half-plane with the edge a and containing the point A .	27
$(\mathcal{A}\mathcal{B}a)_\alpha, \mathcal{A}\mathcal{B}a$	Point sets (figures) \mathcal{A}, \mathcal{B} lie (in plane α) on the same side of the line a .	29
$(\mathcal{A}a\mathcal{B})_\alpha, \mathcal{A}a\mathcal{B}$	Point sets (figures) \mathcal{A}, \mathcal{B} lie (in plane α) on opposite sides of the line a .	29
a_A	Half-plane with the edge a and containing the figure \mathcal{A} .	29
a_A^c	Half-plane, complementary to the half-plane a_A .	30
$\bar{\chi}$	the plane containing the half-plane χ .	32
$\angle(h, k)_O, \angle(h, k)$	Angle with vertex O (usually written simply as $\angle(h, k)$).	35
$\mathcal{P}_{\angle(h, k)}$	Set of points, or contour, of the angle $\angle(h, k)_O$, i.e. the set $h \cup \{O\} \cup k$.	36
$Int\angle(h, k)$	Interior of the angle $\angle(h, k)$.	36
$adj\angle(h, k)$	Any angle, adjacent to $\angle(h, k)$.	38
$adjsp\angle(h, k)$	Any of the two angles, adjacent supplementary to the angle $\angle(h, k)$	39
$vert\angle(h, k)$	Angle $\angle(h^c, k^c)$, vertical to the angle $\angle(h, k)$.	40
$[ABC]$	Geometric object \mathcal{B} lies between geometric objects \mathcal{A}, \mathcal{C} .	46
$\mathcal{A}\mathcal{B}$	Generalized (abstract) interval with ends \mathcal{A}, \mathcal{B} , i.e. the set $\{\mathcal{A}, \mathcal{B}\}$.	48
$(\mathcal{A}\mathcal{B})$	Generalized open interval with ends \mathcal{A}, \mathcal{B} , i.e. the set $\{C [ACB]\}$.	48
$[\mathcal{A}\mathcal{B})$	Generalized half-open interval with ends \mathcal{A}, \mathcal{B} , i.e. the set $(\mathcal{A}\mathcal{B}) \cup \{\mathcal{A}, \mathcal{B}\}$.	48
$(\mathcal{A}\mathcal{B}]$	Generalized half-closed interval with ends \mathcal{A}, \mathcal{B} , i.e. the set $(\mathcal{A}\mathcal{B}) \cup \{\mathcal{B}\}$.	48
$[\mathcal{A}\mathcal{B}]$	Generalized closed interval with ends \mathcal{A}, \mathcal{B} , i.e. the set $(\mathcal{A}\mathcal{B}) \cup \{\mathcal{A}, \mathcal{B}\}$.	48
$\mathcal{P}^{(O)}$	A ray pencil, i.e. a collection of rays emanating from the point O .	48

Symbol	Meaning	Page
$[hkl]$	Ray k lies between rays h, l .	48
$\sphericalangle(h, h^c)$	A straight angle (with sides h, h^c).	49
$[A_1A_2 \dots A_n(\dots)]$	Geometric objects $A_1, A_2, \dots, A_n(\dots)$ are in order $[A_1A_2 \dots A_n(\dots)]$	54
$\mathcal{O}_A^{(\mathfrak{J})}, \mathcal{O}_A$	Generalized ray drawn from \mathcal{O} through A .	56
$(A \prec B)_{\mathcal{O}_{\mathcal{D}}}$	The geometric object A precedes the geometric object B on $\mathcal{O}_{\mathcal{D}}$.	58
$A \preceq B$	For A, B on $\mathcal{O}_{\mathcal{D}}$ we let $A \preceq B \stackrel{\text{def}}{\iff} (A \prec B) \vee (A = B)$	58
$(A \prec_i B)_{\mathfrak{J}}$	A precedes B in \mathfrak{J} in the direct ($i = 1$) or inverse ($i = 2$) order.	59
$A \preceq_i B$	For A, B in \mathfrak{J} we let $A \preceq_i B \stackrel{\text{def}}{\iff} (A \prec_i B) \vee (A = B)$	60
$\mathcal{O}_A^{c(\mathfrak{J})}, \mathcal{O}_A^c$	The generalized ray \mathcal{O}_A^c , complementary in \mathfrak{J} to the generalized ray \mathcal{O}_A .	61
(hk)	Open angular interval.	63
$[hk)$	Half-open angular interval.	63
$(hk]$	Half-closed angular interval.	63
$[hk]$	Closed angular interval.	63
$[h_1h_2 \dots h_n(\dots)]$	The rays $h_1, h_2, \dots, h_n(\dots)$ are in order $[h_1h_2 \dots h_n(\dots)]$.	65
o_h	Angular ray emanating from the ray o and containing the ray h	65
$(h \prec k)_{o_m}, h \prec k$	The ray h precedes the ray k on the angular ray o_m .	66
$(h \preceq k)_{o_m}, h \preceq k$	For rays h, k on an angular ray o_m we let $h \preceq k \stackrel{\text{def}}{\iff} (h \prec k) \vee (h = k)$	66
$(h \prec_i k)$	The ray h precedes the ray k in the direct ($i = 1$) or inverse ($i = 2$) order.	66
$\overrightarrow{o_h^c}$	The ray, complementary to the angular ray o_h .	68
\overrightarrow{AB}	An ordered interval.	24
$A_0A_1 \dots A_n$	A (rectilinear) path $A_0A_1 \dots A_n$.	69
$A_0A_1 \dots A_nA_{n+1}$	A polygon, i.e. the (rectilinear) path $A_0A_1 \dots A_nA_{n+1}$ with $A_{n+1} = A_0$.	69
$\triangle ABC$	A triangle with the vertices A, B, C .	69
$(A \prec B)_{A_1A_2 \dots A_n}, A \prec B$	A precedes B on the path $A_1A_2 \dots A_n$.	70
$\sphericalangle A_{i-1}A_iA_{i+1}, \sphericalangle A_i$	Angle between sides $A_{i-1}A_i, A_iA_{i+1}$ of the path/polygon $A_0A_1 \dots A_nA_{n+1}$.	71
$AB\alpha$	Points A, B lie on the same side of the plane α .	80
$A\alpha B$	Points A, B lie on opposite sides of the plane α .	80
α_A	Half-space, containing the point A , i.e. $\alpha_A \equiv \{B \mid AB\alpha\}$.	80
$AB\alpha$	Figures (point sets) A, B lie on the same side of the plane α .	81
$A\alpha B$	Figures (point sets) A, B lie on opposite sides of the plane α .	81
α_A^c	Half-space, complementary to the half-space α_A .	82
$(\widehat{\chi\kappa})_a, \widehat{\chi\kappa}$	A dihedral formed by the half-planes χ, κ with the common edge a .	87
$\mathcal{P}_{(\widehat{\chi\kappa})}$	The set of points of the dihedral angle $(\widehat{\chi\kappa})_a$, i.e. $\mathcal{P}_{(\widehat{\chi\kappa})} \equiv \chi \cup \mathcal{P}_a \cup \kappa$.	88
$adj(\widehat{\chi\kappa})$	Any dihedral angle, adjacent to the given dihedral angle $\widehat{\chi\kappa}$	91
$adjsp \widehat{\chi\kappa}$	Any of the two dihedral angles, adjacent supplementary to $\widehat{\chi\kappa}$.	91
$vert(\widehat{\chi\kappa})$	The dihedral angle, vertical to $\widehat{\chi\kappa}$, i.e. $vert(\widehat{\chi\kappa}) \equiv \widehat{\chi^c\kappa^c}$.	94
$\mathcal{S}(a)$	A pencil of half-planes with the same edge a .	98
$[a_Aa_Ba_C]$	Half-plane a_B lies between the half-planes a_A, a_C .	98
(a_Aa_C)	Open dihedral angular interval formed by the half-planes a_A, a_C .	99
$[a_Aa_C)$	Half-open dihedral angular interval formed by the half-planes a_A, a_C .	99
$(a_Aa_C]$	Half-closed dihedral angular interval formed by the half-planes a_A, a_C .	99
$[a_Aa_C]$	Closed dihedral angular interval formed by the half-planes a_A, a_C .	99
$[\chi_1\chi_2 \dots \chi_n(\dots)]$	The half-planes $\chi_1, \chi_2, \dots, \chi_n(\dots)$ are in order $[\chi_1\chi_2 \dots \chi_n(\dots)]$.	104
o_χ	Dihedral angular ray emanating from o and containing χ .	104
$(\chi \prec \kappa)_{o_\mu}$	The half-plane χ precedes the half-plane κ on the dihedral angular ray o_μ .	105
$(\chi \preceq \kappa)_{o_\mu}, \chi \preceq \kappa$	For half-planes χ, κ on o_μ we let $\chi \preceq \kappa \stackrel{\text{def}}{\iff} (\chi \prec \kappa) \vee (\chi = \kappa)$.	106
$(\chi \prec_i \kappa)$	The half-plane χ precedes κ in the direct ($i = 1$) or inverse ($i = 2$) order.	106
$\overrightarrow{o_\chi^c}$	Dihedral angular ray, complementary to the dihedral angular ray o_χ .	107
$AB \equiv CD$	The interval AB is congruent to the interval CD	110
$\sphericalangle(h, k) \equiv \sphericalangle(l, m)$	Angle $\sphericalangle(h, k)$ is congruent to the angle $\sphericalangle(l, m)$	110
$\mathcal{A} \equiv \mathcal{B}$	The figure (point set) \mathcal{A} is congruent to the figure \mathcal{B} .	110
$A_1A_2 \dots A_n \simeq B_1B_2 \dots B_n$	The path $A_1A_2 \dots A_n$ is weakly congruent to the path $B_1B_2 \dots B_n$.	110
$A_1A_2 \dots A_n \equiv B_1B_2 \dots B_n$	The path $A_1A_2 \dots A_n$ is congruent to the path $B_1B_2 \dots B_n$.	110
$A_1A_2 \dots A_n \cong B_1B_2 \dots B_n$	The path $A_1A_2 \dots A_n$ is strongly congruent to the path $B_1B_2 \dots B_n$.	111
$a \perp b$	The line a is perpendicular to the line b .	117
$proj(A, a)$	Projection of the point A on the line a .	117
$proj(AB, a)$	Projection of the interval AB on the line a .	117
$AB \geq A'B'$	The interval $A'B'$ is shorter than or congruent to the interval AB .	124
$A'B' < AB$	The interval $A'B'$ is shorter than the interval AB .	124
$\sphericalangle(h', k') \leq \sphericalangle(h, k)$	The angle $\sphericalangle(h', k')$ is less than or congruent to the angle $\sphericalangle(h, k)$.	126
$\sphericalangle(h', k') < \sphericalangle(h, k)$	The angle $\sphericalangle(h', k')$ is less than the angle $\sphericalangle(h, k)$.	126

Symbol	Meaning	Page
$AB \equiv CD$	The generalized interval AB is congruent to the generalized interval CD .	126
$AB \geq A'B'$	The generalized interval AB is shorter than or congruent to the generalized interval $A'B'$.	129
$AB < A'B'$	The generalized interval AB is shorter than the generalized interval $A'B'$.	129
$E = \text{mid } AB$	The point E is the midpoint of the interval AB .	148

Part I

Classical Geometry

Chapter 1

Absolute (Neutral) Geometry

Preamble

Following Hilbert, in our treatment of neutral geometry (called also absolute geometry and composed of facts true in both Euclidean and Lobachevskian geometries) we define points, lines, and planes as mathematical objects with the property that these objects, as well as some objects formed from them, like angles and triangles, satisfy the axioms listed in sections 1 through 4 of this chapter. We shall denote points, lines and planes by capital Latin A, B, C, \dots , small Latin a, b, c, \dots , and small Greek $\alpha, \beta, \gamma, \dots$ letters respectively, possibly with subscripts.

1.1 Incidence

Hilbert's Axioms of Incidence

Denote by \mathcal{C}^{Pt} , \mathcal{C}^L and \mathcal{C}^{Pl} the classes of all points, lines and planes respectively.¹ Axioms A 1.1.1 – A 1.1.8 define two relations $\in_L \subset \mathcal{C}^{Pt} \times \mathcal{C}^L$ and $\in_{Pl} \subset \mathcal{C}^{Pt} \times \mathcal{C}^{Pl}$. If $A \in_L a$ or $A \in_{Pl} \alpha$ ², we say that A lies on, or incident with, a (respectively α), or that a (respectively α) goes through A . As there is no risk of confusion, when speaking of these two relations in the future, we will omit the clumsy subscripts L and Pl .

We call a set of points (or, speaking more broadly, of any geometrical objects for which this relation is defined) lying on one line a (plane α)³, a collinear (coplanar) set.⁴ Points of a collinear (coplanar) set are said to colline of be collinear (coplane or be coplanar, respectively).

Denote $\mathcal{P}_a \doteq \{A | A \in a\}$ and $\mathcal{P}_\alpha \doteq \{A | A \in \alpha\}$ the set of all point of line a and plane α , respectively. We shall also sometimes refer to the set \mathcal{P}_a (\mathcal{P}_α) as the "contour of the line a " (respectively, "contour of the plane α ").

Axiom 1.1.1. *Given distinct points A, B , there is at least one line a incident with both A and B .*

Axiom 1.1.2. *There is at most one such line.*

We denote the line incident with the points A, B by a_{AB} .

Axiom 1.1.3. *Each line has at least two points incident with it. There are at least three points not on the same line.*

Axiom 1.1.4. *If A, B, C are three distinct points not on the same line, there is at least one plane incident with all three. Each plane has at least one point on it.*

Axiom 1.1.5. *If A, B, C are three distinct points not on the same line, there is at most one plane incident with all three.*

We denote the plane incident with the non-collinear points A, B, C by α_{ABC} .

Axiom 1.1.6. *If A, B are distinct points on a line l that lies on a plane α , then all points of l lie on α .*

If all points of the line a lie in the plane α , one writes $a \subset \alpha$ and says " a lies on α ", " α goes through a ." In general, if for a geometric object, viewed as a point set \mathcal{X} , we have $\mathcal{X} \subset \mathcal{P}_a$ or $\mathcal{X} \subset \mathcal{P}_\alpha$, we say that the object \mathcal{X} lies on line a or in (on) plane α , respectively.

¹The reader will readily note that what we mean by points, lines, planes, and, consequently, the classes \mathcal{C}^{Pt} , \mathcal{C}^L and \mathcal{C}^{Pl} changes from section to section in this chapter. Thus, in the first section we denote by \mathcal{C}^{Pt} , \mathcal{C}^L and \mathcal{C}^{Pl} the classes of all points, lines and planes, respectively satisfying axioms A 1.1.1 – A 1.1.8. But in the second section we already denote by \mathcal{C}^{Pt} , \mathcal{C}^L and \mathcal{C}^{Pl} the classes of all points, lines and planes, respectively satisfying those axioms plus A 1.2.1 – A 1.2.4, etc.

²As is customary in mathematics, if mathematical objects $a \in A$ and $b \in B$ are in the relation ρ , we write $a\rho b$; that is, we let $a\rho b \stackrel{\text{def}}{=} (a, b) \in \rho \subset A \times B$.

³Obviously, to say that several points or other geometric object lie on one line a (plane α) equals to saying that there is a line a (plane α) containing all of them

⁴Obviously, this definition makes sense only for sets, containing at least two points or other appropriate geometric objects.

Axiom 1.1.7. *If a point lies on two distinct planes, at least one other point lies on both planes.*

Axiom 1.1.8. *There are at least four points not on the same plane.*

Obviously, axioms A 1.1.3, A 1.1.4 imply there exists at least one line and at least one plane.

If $A \in a$ ($A \in \alpha$) and $A \in b$ ($A \in \beta$), the lines (planes) a (α) and b (β) are said to intersect or meet in their common point. We then write $A \in a \cap b$.⁵ Unless other definitions are explicitly given for a specific case, a point set \mathcal{A} is said to meet another point set \mathcal{B} (line a or plane α) in their common points $A \in \mathcal{A} \cap \mathcal{B}$ ($A \in \mathcal{A} \cap \alpha$ and $\mathcal{A} \cap \alpha$ respectively).⁶

If two (distinct) lines meet, they are said to form a cross.

If two or more point sets, lines or planes meet in a single point, they are said to concur, or be concurrent, in (at) that point.

A non-empty set of points is usually referred to as a geometric figure. A set of points all lying in one plane (on one line) is referred to as plane geometric figure (line figure).

Consequences of Incidence Axioms

Proposition 1.1.1.1. *If A, C are distinct points and C is on a_{AB} then $a_{AC} = a_{AB}$.*

Proof. $A \in a_{AC} \ \& \ C \in a_{AC} \ \& \ A \in a_{AB} \ \& \ C \in a_{AB} \xrightarrow{A1.1.2} a_{AC} = a_{AB}$. \square

Corollary 1.1.1.2. *If A, C are distinct points and C is on a_{AB} then B is on a_{AC} .*

Corollary 1.1.1.3. *If A, B, C are distinct points and C is on a_{AB} then $a_{AB} = a_{AC} = a_{BC}$.*

Lemma 1.1.1.4. *If $\{A_i | i \in \mathcal{U}\}$, is a set of points on one line a then $a = a_{A_i A_j}$ for all $i \neq j$, $i, j \in \mathcal{U}$.*

Proof. $A_i \in a \ \& \ A_j \in a \Rightarrow a = a_{A_i A_j}$. \square

Corollary 1.1.1.5. *If $\{A_i | i \in \mathcal{U}\}$, is a set of points on one line a then any of these points A_k lies on all lines $a_{A_i A_j}$, $i \neq j$, $i, j \in \mathcal{U}$. \square*

Lemma 1.1.1.6. *If the point E is not on the line a_{AC} , then all other points of the line a_{AE} except A are not on a_{AC} .*

Proof. Suppose $F \in a_{AE} \cap a_{AC}$ and $F \neq A$. Then by A 1.1.2 $a_{AE} = a_{AC}$, whence $E \in a_{AC}$ - a contradiction. \square

Lemma 1.1.1.7. *If $A_1, A_2, \dots, A_n(\dots)$, $n \geq 3$, is a finite or (countably) infinite sequence of (distinct) points, and any three consecutive points A_i, A_{i+1}, A_{i+2} , $i = 1, 2, \dots, n - 2(\dots)$ of the sequence are collinear, then all points of the sequence lie on one line.*

Proof. By induction. The case $n = 3$ is trivial. If A_1, A_2, \dots, A_{n-1} are on one line a (induction!), then by C 1.1.1.5 $A_i \in a = a_{A_{n-2} A_{n-1}}$, $i = 1, 2, \dots, n$. \square

Lemma 1.1.1.8. *If two points of a collinear set lie in plane α then the line, containing the set, lies in plane α .*

Proof. Immediately follows from A 1.1.6. \square

Theorem 1.1.1. *Two distinct lines cannot meet in more than one point.*

Proof. Let $A \neq B$ and $(A \in a \cap b) \ \& \ (B \in a \cap b)$. Then by A1.1.2 $a = b$. \square

Lemma 1.1.2.1. *For every line there is a point not on it.*

Proof. By A1.1.3 $\exists \{A, B, C\}$ such that $\neg \exists b (A \in b \ \& \ B \in b \ \& \ C \in b)$, whence $\exists P \in \{A, B, C\}$ such that $P \notin a$ (otherwise $A \in a \ \& \ B \in a \ \& \ C \in a$). \square

Lemma 1.1.2.2. *If A and B are on line a and C is not on line a then A, B, C are not on one line.*

Proof. If $\exists b (A \in b \ \& \ B \in b \ \& \ C \in b)$, then $A \in b \ \& \ B \in b \ \& \ A \in a \ \& \ B \in a \xrightarrow{A1.1.2} a = b \ni C$ - a contradiction. \square

Corollary 1.1.2.3. *If C is not on line a_{AB} then A, B, C are not on one line, B is not on a_{AC} , and A is not on a_{BC} . If A, B, C are not on one line, then C is not on line a_{AB} , B is not on a_{AC} , and A is not on a_{BC} .*

Lemma 1.1.2.4. *If A and B are distinct points, there is a point C such that A, B, C are not on one line.*

Proof. By L1.1.2.1 $\exists C \notin a_{AB}$. By C 1.1.2.3 $C \notin a_{AB} \Rightarrow \neg \exists b (A \in b \ \& \ B \in b \ \& \ C \in b)$. \square

Lemma 1.1.2.5. *For every point A there are points B, C such that A, B, C are not on one line.*

⁵Similar to the definition of $a \subset \alpha$, this notation agrees with the set-theoretical interpretation of a line or plane as an array of points. However, this interpretation is not made necessary by axioms. This observation also applies to the definitions that follow.

⁶These relations "to meet" are obviously symmetric, which will be reflected in their verbal usage.

Proof. By A1.1.3 $\exists B \neq A$. By C1.1.2.3 $\exists C$ such that $\neg \exists b (A \in b \& B \in b \& C \in b)$. \square

Lemma 1.1.2.6. *For every plane α there is a point P not on it.*

Proof. By A1.1.8 $\exists \{A, B, C, D\}$ such that $\neg \exists \beta (A \in \beta \& B \in \beta \& C \in \beta \& D \in \beta)$, whence $\exists P \in \{A, B, C, D\}$ such that $P \notin \alpha$. (otherwise $A \in \alpha \& B \in \alpha \& C \in \alpha \& D \in \alpha$). \square

Lemma 1.1.2.7. *If three non-collinear points A, B, C are on plane α , and D is not on it, then A, B, C, D are not all on one plane.*

Proof. If $\exists \beta (A \in \beta \& B \in \beta \& C \in \beta \& D \in \beta)$ then $(\neg \exists b (A \in b \& B \in b \& C \in b)) \& (A \in \alpha \& B \in \alpha \& C \in \alpha \& A \in \beta \& B \in \beta \& C \in \beta) \xrightarrow{A1.1.5} \alpha = \beta \ni D$ - a contradiction. \square

Corollary 1.1.2.8. *If D is not on plane α_{ABC} , then A, B, C, D are not on one plane.* \square

Lemma 1.1.2.9. *If A, B, C are not on one line, there is a point D such that A, B, C, D are not on one plane.*

Proof. $\neg \exists b (A \in b \& B \in b \& C \in b) \xrightarrow{A1.1.4} \exists \alpha_{ABC}$. By L1.1.2.6 $\exists D \notin \alpha_{ABC}$, whence by C1.1.2.8 $\neg \exists \beta (A \in \beta \& B \in \beta \& C \in \beta \& D \in \beta)$. \square

Lemma 1.1.2.10. *For any two points A, B there are points C, D such that A, B, C, D are not on one plane.*

Proof. By L1.1.2.4 $\exists C$ such that $\neg \exists b (A \in b \& B \in b \& C \in b)$, whence by L1.1.2.9 $\exists D \neg \exists \beta (A \in \beta \& B \in \beta \& C \in \beta \& D \in \beta)$. \square

Lemma 1.1.2.11. *For any point A there are points B, C, D such that A, B, C, D are not one plane.*

Proof. By A1.1.3 $\exists B \neq A$. By L 1.1.2.10 $\exists \{C, D\}$ such that $\neg \exists \beta (A \in \beta \& B \in \beta \& C \in \beta \& D \in \beta)$. \square

Lemma 1.1.2.12. *A point A not in plane α cannot lie on any line a in that plane.*

Proof. $A \in a \& a \subset \alpha \Rightarrow A \in \alpha$ - a contradiction. \square

Theorem 1.1.2. *Through a line and a point not on it, one and only one plane can be drawn.*

Proof. Let $C \notin a$. By A1.1.3 $\exists \{A, B\} ((A \in a) \& (B \in a))$. By L1.1.2.2 $\neg \exists b ((A \in b) \& (B \in b) \& (C \in b))$, whence by A1.1.4 $\exists \alpha ((A \in \alpha) \& (B \in \alpha) \& (C \in \alpha))$. By 1.1.6 $(A \in a) \& (B \in a) \& (A \in \alpha) \& (B \in \alpha) \Rightarrow a \subset \alpha$. To show uniqueness note that $(a \subset \alpha) \& (C \in \alpha) \& (a \subset \beta) \& (C \in \beta) \Rightarrow (A \in \alpha) \& (B \in \alpha) \& (C \in \alpha) \& (A \in \beta) \& (B \in \beta) \& (C \in \beta) \Rightarrow \alpha = \beta$. \square

We shall denote the plane drawn through a line a and a point A by α_{aA} .

Theorem 1.1.3. *Through two lines with a common point, one and only one plane can be drawn.*

Proof. Let $A = a \cap b$. By A1.1.3 $\exists B ((B \in b) \& (B \neq A))$. By T1.1.1 $B \notin a$, whence by T1.1.2 $\exists \alpha ((a \subset \alpha) \& (B \in \alpha))$. By A1.1.6 $(A \in \alpha) \& (B \in \alpha) \& (A \in b) \& (B \in b) \Rightarrow b \subset \alpha$. If there exists β such that $a \subset \beta \& b \subset \beta$ then $b \subset \beta \& B \in b \Rightarrow B \in \beta$ and $(a \subset \alpha \& B \in \alpha \& a \subset \beta \& B \in \beta) \xrightarrow{T1.1.2} \alpha = \beta$. \square

Theorem 1.1.4. *A plane and a line not on it cannot have more than one common point.*

Proof. If $A \neq B$ then by A1.1.6 $A \in a \& A \in \alpha \& B \in a \& B \in \alpha \Rightarrow a \subset \alpha$. \square

Theorem 1.1.5. *Two distinct planes either do not have common points or there is a line containing all their common points.*

Proof. Let $\alpha \cap \beta \neq \emptyset$. Then $\exists A (A \in \alpha \& A \in \beta) \xrightarrow{A1.1.7} \exists B (B \neq A \& B \in \alpha \& B \in \beta)$ and by A1.1.6 $a_{AB} \subset \alpha \cap \beta$. If $C \notin a_{AB} \& C \in \alpha \cap \beta$ then $a_{AB} \subset \alpha \cap \beta \& C \notin a_{AB} \& C \in \alpha \cap \beta \xrightarrow{T1.1.2} \alpha = \beta$ - a contradiction. \square

Lemma 1.1.6.1. *A point A not in plane α cannot lie on any line a in that plane.*

Proof. $A \in a \& a \subset \alpha \Rightarrow A \in \alpha$ - a contradiction. \square

Corollary 1.1.6.2. *If points A, B are in plane α , and a point C is not in that plane, then C is not on a_{AB} .*

Proof. $A \in \alpha \& B \in \alpha \xrightarrow{A1.1.6} a_{AB} \subset \alpha$. $C \notin \alpha \& a_{AB} \subset \alpha \xrightarrow{L1.1.6.1} C \notin a_{AB}$. \square

Corollary 1.1.6.3. *If points A, B are in plane α , and a point C is not in that plane, then A, B, C are not on one line.*

Proof. By C1.1.6.2 $C \notin a_{AB}$, whence by 1.1.2.3 A, B, C are not on one line. \square

Theorem 1.1.6. *Every plane contains at least three non-collinear points.*

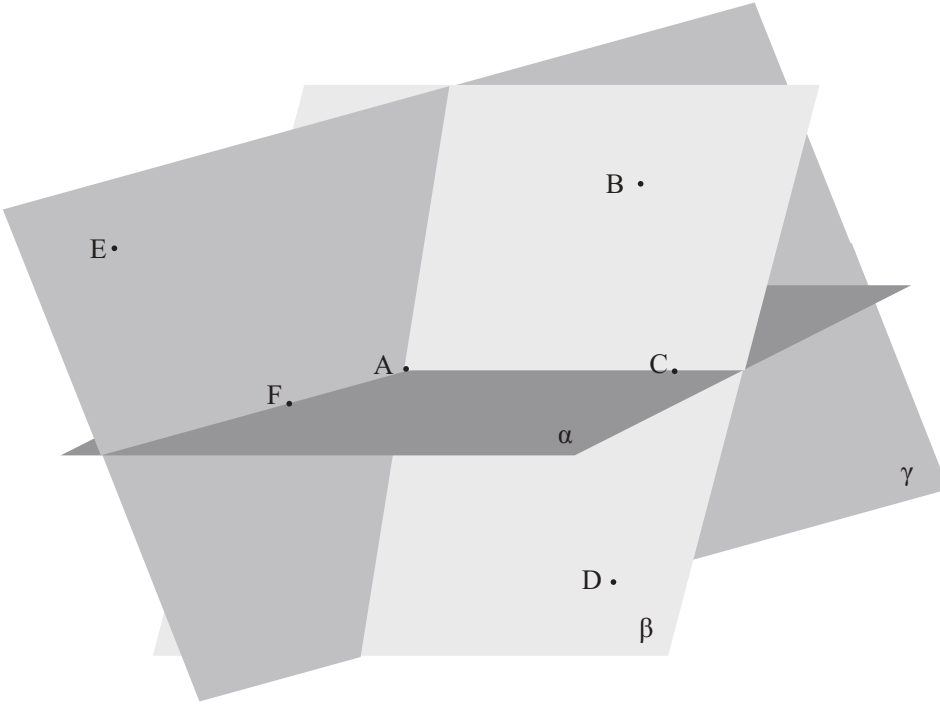

Figure 1.1: Every plane contains at least three non-collinear points.

Proof. (See Fig. 1.1.) By A 1.1.4 $\exists A A \in \alpha$. By L 1.1.2.6 $\exists B B \notin \alpha$. By L1.1.2.1 $\exists D D \notin a_{AB}$, whence by T1.1.2 $\exists \beta (a_{AB} \subset \beta \& D \in \beta)$. $a_{AB} \subset \beta \Rightarrow A \in \beta \& B \in \beta$. $A \notin \alpha \& A \in \beta \Rightarrow \alpha \neq \beta$. $A \in \alpha \& A \in \beta \& \alpha \neq \beta \xrightarrow{A1.1.7} \exists C C \in \alpha \cap \beta$. $A \in \beta \& C \in \beta \xrightarrow{A1.1.6} a_{AC} \subset \beta$. By L 1.1.2.6 $\exists E E \notin \beta$. $E \notin \beta \& a_{AB} \subset \beta \xrightarrow{L1.1.6.1} E \notin a_{AB} \xrightarrow{T1.1.2} \exists \gamma a_{AB} \subset \gamma \& E \in \gamma$. $a_{AB} \subset \gamma \Rightarrow A \in \gamma \& B \in \gamma$. $B \notin \alpha \& B \in \gamma \Rightarrow \alpha \neq \gamma$. $E \notin \beta \& E \in \gamma \Rightarrow \beta \neq \gamma$. $A \in \alpha \cap \gamma \xrightarrow{A1.1.7} \exists F F \in \alpha \cap \gamma$. $F \notin a_{AC}$, since otherwise $F \in a_{AC} \& a_{AC} \subset \beta \Rightarrow F \in \beta$, and $A \in \alpha \& F \in \alpha \& B \notin \alpha \xrightarrow{C1.1.6.3} \neg \exists b (A \in b \& B \in b \& F \in b)$, and $\neg \exists b (A \in b \& B \in b \& F \in b) \& A \in \beta \& B \in \beta \& F \in \beta \& A \in \gamma \& B \in \gamma \& F \in \gamma \xrightarrow{A1.1.4} \beta = \gamma$ - a contradiction. Finally, $F \notin a_{AC} \xrightarrow{A1.1.4} \neg \exists b (A \in b \& C \in b \& F \in b)$. \square

Corollary 1.1.6.4. *In any plane (at least) three distinct lines can be drawn.*

Proof. Using T 1.1.6, take three non-collinear points A, B, C in plane α . Using A 1.1.1, draw lines a_{AB}, a_{BC}, a_{AC} . By A 1.1.6 they all lie in α . Finally, they are all distinct in view of non-collinearity of A, B, C . \square

Corollary 1.1.6.5. *Given a line a lying in a plane α , there is a point A lying in α outside a .*

Proof. See T 1.1.6. \square

Corollary 1.1.6.6. *In every plane α there is a line a and a point A lying in α outside a .*

Proof. See T 1.1.6, A 1.1.1. \square

We say that a line a is parallel to a line b , or that lines a and b are parallel (the relation being obviously symmetric), and write $a \parallel b$, if a and b lie in one plane and do not meet.

A couple of parallel lines a, b will be referred to as an abstract strip (or simply a strip) ab .

A line a is said to be parallel to a plane α (the plane α is then said to be parallel to the line a) if they do not meet.

A plane α is said to be parallel to a plane β (or, which is equivalent, we say that the planes α, β are parallel, the relation being obviously symmetric) if $\alpha \cap \beta = \emptyset$.

Lemma 1.1.7.1. *If lines a_{AB}, a_{CD} are parallel, no three of the points A, B, C, D are collinear, and, consequently, none of them lies on the line formed by two other points in the set $\{A, B, C, D\}$.*

Proof. In fact, collinearity of any three of the points A, B, C, D would imply that the lines a_{AB}, a_{CD} meet. \square

Lemma 1.1.7.2. *For any two given parallel lines there is exactly one plane containing both of them.*

Proof. Let $a \parallel b$, where $a \subset \alpha, a \subset \beta, b \subset \alpha, b \subset \beta$. Using A 1.1.3, choose points $A_1 \in a, A_2 \in a, B \in b$. Since $a \parallel b$, the points A_1, A_2, B are not collinear. Then $A_1 \in \alpha \& A_2 \in \alpha \& B \in \alpha \& A_1 \in \beta \& A_2 \in \beta \& B \in \beta \xrightarrow{A1.1.5} \alpha = \beta$. \square

We shall denote a plane containing lines a, b , whether parallel or having a common point, by α_{ab} .

Lemma 1.1.7.3. *If lines a, b and b, c are parallel and points $A \in a, B \in b, C \in c$ are collinear, the lines a, b, c all lie in one plane.*

Proof. That A, B, C are collinear means $\exists d (A \in d \& B \in d \& C \in d)$. We have $B \in d \cap \alpha_{bc} \& C \in d \cap \alpha_{bc} \xrightarrow{A1.1.6} d \subset \alpha_{bc}$. $A \in a \& a \parallel b \Rightarrow A \notin b$. Finally, $A \in d \subset \alpha_{bc} \& A \in a \subset \alpha_{ab} \& b \subset \alpha_{ab} \& b \subset \alpha_{bc} \& A \notin b \xrightarrow{T1.1.2} \alpha_{ab} = \alpha_{bc}$. \square

Two lines a, b that cannot both be contained in a common plane are called skew lines. Obviously, skew lines are not parallel and do not meet (see T 1.1.3.)

Lemma 1.1.7.4. *If four (distinct) points A, B, C, D are not coplanar, the lines a_{AB}, a_{CD} are skew lines.*

Proof. Indeed, if the lines a_{AB}, a_{CD} were contained in a plane α , this would make the points A, B, C, D coplanar contrary to hypothesis. \square

Lemma 1.1.7.5. *If a plane α not containing a point B contains both a line a and a point A lying outside a , the lines a, a_{AB} are skew lines.*

Proof. If both a, a_{AB} were contained in a single plane, this would be the plane α , which would in this case contain B contrary to hypothesis. \square

1.2 Betweenness and Order

Hilbert's Axioms of Betweenness and Order

Axioms A 1.2.1 - A 1.2.4 define a ternary relation "to lie between" or "to divide" $\rho \subset C^{Pt} \times C^{Pt} \times C^{Pt}$. If points A, B, C are in this relation, we say that the point B lies between the points A and C and write this as $[ABC]$.

Axiom 1.2.1. *If B lies between A and C , then A, C are distinct, A, B, C lie on one line, and B lies between C and A .*

Axiom 1.2.2. *For every two points A and C there is a point B such that C lies between A and B .*

Axiom 1.2.3. *If the point B lies between the points A and C , then the point C cannot lie between the points A and B .*

For any two distinct points A, B define the following point sets:

An (abstract) interval $AB \equiv \{A, B\}$;

An open interval $(AB) \equiv \{X | [AXB]\}$;

Half-open (half-closed) intervals $[AB) \equiv \{A\} \cup (AB)$ and $(AB] \equiv (AB) \cup \{B\}$;

For definiteness, in the future we shall usually refer to point sets of the form $[AB)$ as the half-open intervals, and to those of the form $(AB]$ as the half-closed ones.

A closed interval, also called a line segment, $[AB] \equiv (AB) \cup AB$.

Open, half-open (half - closed), and closed intervals thus defined will be collectively called interval - like sets. Abstract intervals and interval - like sets are also said to **join** their **ends** A, B .

An interval AB is said to meet, or intersect, another interval CD (generic point set \mathcal{A} ⁷, line a , plane α) in a point X if $X \in (AB) \cap (CD)$ ($X \in (AB) \cap \mathcal{A}$, $X \in (AB) \cap a$, $X \in (AB) \cap \alpha$, respectively).

Given an abstract interval or any interval-like set \mathcal{X} with the ends A, B , we define its interior $Int\mathcal{X}$ by $Int\mathcal{X} \equiv (AB)$, and its exterior $Ext\mathcal{X}$ by $Ext\mathcal{X} \equiv \mathcal{P}_{a_{AB}} \setminus [AB] = \{C | C \in a_{AB} \& C \notin [AB]\}$. If some point C lies in the interior (exterior) of \mathcal{X} , we say that it lies inside (outside) \mathcal{X} .⁸

Axiom 1.2.4 (Pasch). *Let a be a line in a plane α_{ABC} , not containing any of the points A, B, C . Then if a meets AB , it also meets either AC or BC .*

⁷That is, a set conforming to the general definition on p. 4.

⁸The topological meaning of these definitions will be elucidated later; see p. 18.

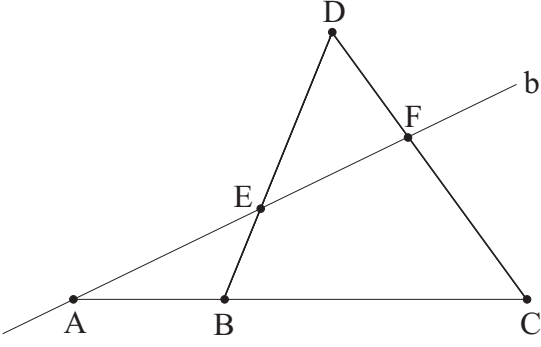

Figure 1.2: Construction for the proofs of L 1.2.1.6 and C 1.2.1.7

Basic Properties of Betweenness Relation

The axiom A 1.2.3 can be augmented by the following statement.

Proposition 1.2.1.1. *If B lies between A and C , then A, B, C are distinct points.*⁹

Proof. $[ABC] \stackrel{A1.2.3}{\implies} \neg[ABC]$. $[ABC] \& \neg[ACB] \& B = C \Rightarrow [ABB] \& \neg[ABB]$ - a contradiction. \square

Proposition 1.2.1.2. *If a point B lies between points A and C , then the point A cannot lie between the points B and C .*¹⁰

Proof. $[ABC] \stackrel{A1.2.1}{\implies} [CBA] \stackrel{A1.2.3}{\implies} \neg[CAB] \stackrel{A1.2.1}{\implies} \neg[BAC]$. \square

Lemma 1.2.1.3. *If a point B lies between points A and C , then B is on line a_{AC} , C is on a_{AB} , A is on a_{BC} , and the lines a_{AB}, a_{AC}, a_{BC} are equal.*

Proof. $[ABC] \stackrel{A1.2.1}{\implies} A \neq B \neq C \& \exists a (A \in a \& B \in a \& C \in a)$. By C 1.1.1.5 $B \in a_{AC} \& C \in a_{AB} \& A \in a_{BC}$. Since $A \neq B \neq C$, by C 1.1.1.3 $a_{AB} = a_{AC} = a_{BC}$. \square

Lemma 1.2.1.4. *If a point B lies between points A and C , then the point C lies outside AB (i.e., C lies in the set $ExtAB$), and the point A lies outside BC (i.e., $A \in ExtBC$).*

Proof. Follows immediately from A 1.2.1, A 1.2.3, L 1.2.1.3. \square

Lemma 1.2.1.5. *A line a , not containing at least one of the ends of the interval AB , cannot meet the line a_{AB} in more than one point.*

Proof. If $C \in a \cap a_{AB}$ and $D \in a \cap a_{AB}$, where $D \neq C$, then by A 1.1.2 $a = a_{AB} \Rightarrow A \in a \& B \in a$. \square

Lemma 1.2.1.6. *Let A, B, C be three points on one line a ; the point A lies on this line outside the interval BC , and the point D is not on a . If a line b , drawn through the point A , meets one of the intervals BD, CD , it also meets the other.*

Proof. (See Fig. 1.2.) Let $A \in b$ and suppose that $\exists E ([BED] \& E \in b)$. Then $[BED] \stackrel{L1.2.1.3}{\implies} E \in a_{BD} \& D \in a_{BE}$. $A \in a = a_{BC} \subset \alpha_{BCD} \& E \in a_{BD} \subset \alpha_{BCD} \& A \in b \& E \in b \stackrel{A1.1.6}{\implies} b \subset \alpha_{BCD}$. $E \notin a$, since otherwise $B \in a \& E \in a \Rightarrow a = a_{BE} \ni D$ - a contradiction. $B \notin b \& C \notin b$, because $(B \in b \vee C \in b) \& A \in b \Rightarrow a = b \ni E$. $D \notin b$, otherwise $D \in b \& E \in b \Rightarrow B \in b = a_{DE}$. By A 1.2.4 $\exists F (F \in b \& [CFD])$, because if $\exists H (H \in b \& [BHC])$ then $a \neq b \& H \in a = a_{BC} \& H \in b \& A \in a \& A \in b \stackrel{T1.1.1}{\implies} H = A$, whence $[BAC]$ - a contradiction. Replacing E with F and B with C , we find that $\exists F (F \in b \& [CFD]) \Rightarrow \exists E ([BED] \& E \in b)$. \square

Corollary 1.2.1.7. *Let a point B lie between points A and C , and D be a point not on a_{AC} . If a line b , drawn through the point A , meets one of the intervals BD, CD , it also meets the other. Furthermore, if b meets BD in E and CD in F , the point E lies between the points A, F .*

Proof. (See Fig. 1.2.) Since by A 1.2.1, A 1.2.3 $[ABC] \Rightarrow A \neq B \neq C \& \exists a (A \in a \& B \in a \& C \in a) \& \neg[BAC]$, the first statement follows from L 1.2.1.6. To prove the rest note that $D \notin a_{AC} \stackrel{C1.1.2.3}{\implies} A \notin a_{CD}$, $[DFC] \& A \notin a_{CD} \& D \in a_{DB} \& B \in a_{DB} \& [CBA] \stackrel{\text{above}}{\implies} \exists E' E' \in a_{DB} \cap (AF)$, and $E' \in a_{DB} \cap a_{AF} \& E \in a_{BD} \cap a_{AF} \& B \notin a_{AF} = b \stackrel{L1.2.1.5}{\implies} E' = E$.¹¹ \square

⁹For convenience, in the future we shall usually refer to A 1.2.3 instead of P 1.2.1.1.

¹⁰For convenience, in the future we shall usually refer to A 1.2.3 instead of P 1.2.1.2.

¹¹We have shown that $B \notin b$ in L 1.2.1.6

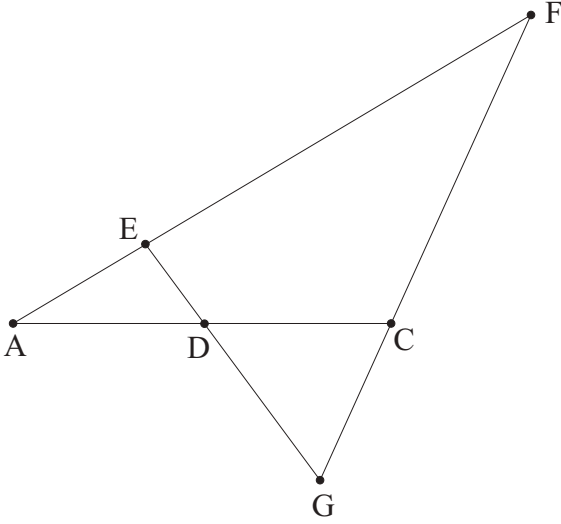

Figure 1.3: For any two distinct points A and C there is a point D between them.

Corollary 1.2.1.8. *Let A, C be two distinct points and a point E is not on line a_{AC} . Then any point F such that $[AEF]$ or $[AFE]$ or $[EAF]$, is also not on a_{AC} .*

Proof. Observe that $[AEF] \vee [AFE] \vee [EAF] \xrightarrow{A1.2.1} A \neq F \& F \in a_{AE}$ and then use L 1.1.1.6. \square

Lemma 1.2.1.9. *If half-open/half-closed intervals $[AB), (BC]$ have common points, the points A, B, C colline. ¹²*

Proof. $[AB) \cap (BC] \neq \emptyset \Rightarrow \exists D D \in [AB) \cap (BC] \xrightarrow{L1.2.1.3} D \in a_{AB} \cap a_{BC} \xrightarrow{A1.1.2} a_{AB} = a_{BC}$, whence the result. \square

Corollary 1.2.1.10. *If lines a, b and b, c are parallel and a point $B \in b$ lies between points $A \in a, C \in c$, the lines a, b, c all lie in one plane.*

Proof. Follows immediately from L 1.2.1.3, L 1.1.7.3. \square

Corollary 1.2.1.11. *Any plane containing two points contains all points lying between them.*

Proof. Follows immediately from A 1.1.6, L 1.2.1.3. \square

Corollary 1.2.1.12. *Suppose points A, B, C are not collinear and a line a has common points with (at least) two of the open intervals $(AB), (BC), (AC)$. Then these common points are distinct and the line a does not contain any of the points A, B, C .*

Proof. Let, for definiteness, $F \in a \cap (AB), D \in a \cap (AC)$. Obviously, $F \neq D$, for otherwise we would have (see L 1.2.1.3, A 1.1.2) $F = D \in a_{AB} \cap a_{AC} \Rightarrow a_{AB} = a_{AC}$ - a contradiction. Also, we have $A \notin a, B \notin a, C \notin a$, because otherwise ¹³ $(A \in a \vee B \in a \vee C \in a) \& F \in a \& D \in a \& F \in a_{AB} \& D \in a_{AC} \Rightarrow a = a_{AB} \vee a = a_{AC} \Rightarrow F \in a_{AB} \cap a_{AC} \vee F \in a_{AB} \cap a_{AC} \Rightarrow a_{AB} = a_{AC}$ - again a contradiction. \square

Corollary 1.2.1.13. *If a point A lies in a plane α and a point B lies outside α , then any other point $C \neq A$ of the line a_{AB} lies outside the plane α . ¹⁴*

Proof. $B \notin \alpha \Rightarrow a_{AB} \not\subset \alpha$. Hence by T 1.1.2 a_{AB} and α concur at A (that is, A is the only common point of the line a_{AB} and the plane α). \square

Theorem 1.2.1. *For any two distinct points A and C there is a point D between them.*

Proof. (See Fig. 1.3.) By L 1.1.2.1 $\exists E E \notin a_{AC}$. By A 1.2.2 $\exists F [AEF]$. From C 1.2.1.8 $F \notin a_{AC}$, and therefore $C \notin a_{AF}$ by L 1.1.1.6. Since $F \neq C$, by A 1.2.2 $\exists G [FCG]$. $C \notin a_{AF} \& [FCG] \xrightarrow{C1.2.1.8} G \notin a_{AF} \xrightarrow{C1.1.2.3} G \neq E \& A \notin a_{FG}$. $[AEF] \xrightarrow{A1.2.1} [FEA] \& A \neq F$. Denote $b = a_{GE}$. As $[FCG]$, $A \notin a_{FG}, G \in b$, and $E \in b \& [FEA]$, by C 1.2.1.7 $\exists D (D \in b \& [ACD])$. \square

¹²This lemma will also be used in the following form:

If points A, B, C do not colline, the half-open/half-closed intervals $[AB), (BC]$ do not meet, i.e. have no common points.

¹³Again, we use (see L 1.2.1.3, A 1.1.2).

¹⁴In particular, this is true if any one of the points A, B, C lies between the two others (see L 1.2.1.3). Note also that we can formulate a pseudo generalization of this corollary as follows: Given a line a , if a point $A \in a$ lies in a plane α , and a point $B \in a$ lies outside α , then any other point $C \neq A$ of the line a lies outside the plane α .

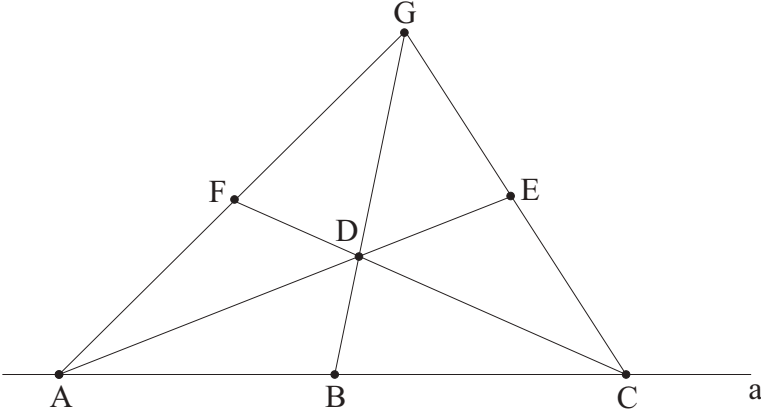

Figure 1.4: Among any three collinear points A, B, C one always lies between the others.

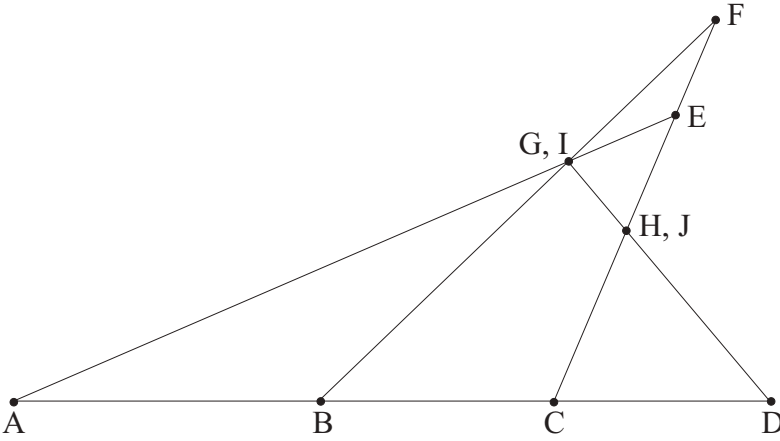

Figure 1.5: If B is on (AC) , and C is on (BD) , then both B and C lie on (AD) .

Theorem 1.2.2. *Among any three collinear points A, B, C one always lies between the others.*¹⁵

Proof. (See Fig. 1.4.) Suppose $A \in a, B \in a, C \in a$, and $\neg[BAC], \neg[ACB]$. By L 1.1.2.1 $\exists D D \notin a$. By A 1.2.2 $\exists G [BDG]$. From L 1.2.1.8 $F \notin a_{BC} = a = a_{AC}$, and therefore $C \notin a_{BG}, A \notin a_{CG}$ by C 1.1.2.3. ($B \neq G$ by A 1.2.1). $D \in a_{AD} \& A \in a_{AD} \& D \in a_{CD} \& C \in a_{CD} \& [BDG] \xrightarrow{C1.2.1.7} \exists E (E \in a_{AD} \& [CEG]) \& \exists F (F \in a_{CD} \& [AFG])$. $[CEG] \& A \notin a_{CG} \& C \in a_{CD} \& F \in a_{CD} \& [AFG] \xrightarrow{C1.2.1.7} \exists I (I \in a_{CD} \& [AIE])$. $E \in a_{AD} \& A \neq E \xrightarrow{C1.1.1.2} D \in a_{AE}$. $D \notin a_{AC} = a \xrightarrow{C1.1.2.3} A \notin a_{CD}$. $A \notin a_{CD} \& D \in a_{AE} \& [AIE] \& D \in a_{CD} \& I \in a_{CD} \xrightarrow{L1.2.1.5} I = D$, whence $[ADE] \xrightarrow{A1.2.2} [EDA]$. $[CEG] \& A \notin a_{CG} \& G \in a_{GD} \& D \in a_{GD} \& [ADE] \xrightarrow{C1.2.1.7} \exists J (J \in a_{GD} \& [AJC])$. $B \in a_{GD} \& J \in a_{GD} \& [AJC] \& B \in a_{BC} = a \& C \notin a_{GD} = a_{BD} \xrightarrow{L1.2.1.5} J = B$, whence $[ABC]$. \square

Lemma 1.2.3.1. *If a point B lies on an open interval (AC) , and the point C lies on an open interval (BD) , then both B and C lie on the open interval (AD) , that is, $[ABC] \& [BCD] \Rightarrow [ABD] \& [ACD]$.*

Proof. (See Fig. 1.5) $D \neq A$, because $[ABC] \xrightarrow{A1.2.3} \neg[BCA]$. By A 1.2.1, L 1.1.1.7 $\exists a (A \in a \& B \in a \& C \in a \& D \in a)$. By L 1.1.2.1 $\exists E E \notin a$. By A 1.2.2 $\exists F [ECF]$. From C 1.2.1.8 $F \notin a_{AC}$, and therefore $A \notin a_{CF}$ by C 1.1.2.3. $[ABC] \& F \notin a_{AC} \& A \in a_{AE} \& [CEF] \& A \notin a_{CF} \& F \in a_{BF} \& B \in a_{BF} \exists G (G \in a_{BF} \& [AGE]) \& \exists I (I \in a_{AE} \& [BIF])$. $E \notin a_{AB} \xrightarrow{C1.1.2.3} B \notin a_{AE}$. $B \notin a_{AE} \& [BIF] \& I \in a_{AE} \& G \in a_{AE} \& G \in a_{BF} \xrightarrow{L1.2.1.5} I = G$. From $F \notin a_{BD}$ by C 1.1.2.3 $D \notin a_{BF}$ and by C 1.2.1.8 $G \notin a_{BD}$, whence $G \neq D$. $[BCD] \& F \notin a_{BD} \& D \in a_{GD} \& G \in a_{GD} \& [BGF] \& D \notin a_{BF} \& F \in a_{CF} \& C \in a_{CF} \xrightarrow{C1.2.1.7} \exists H (H \in a_{GD} \& [CHF]) \& \exists J (J \in a_{CF} \& [GJD])$. $G \notin a_{CD} = a_{BD} \xrightarrow{C1.1.2.3} C \in a_{GD}$. $C \notin a_{GD} \& J \in a_{GD} \& H \in a_{GD} \& J \in a_{CF} \& [CHF] \xrightarrow{L1.2.1.5} J = H$. $E \notin a_{AC} = a_{AD} \xrightarrow{C1.1.2.3} D \notin a_{AE} \& A \notin a_{EC}$. $[AGE] \& D \notin a_{AE} \& E \in a_{EC} \& H \in a_{EC} \& [GHD] \xrightarrow{C1.2.1.7} \exists K (K \in a_{EC} \& [AKD])$. $A \notin a_{EC} \& K \in a_{EC} \& C \in a_{EC} \& C \in a_{AD} \& [AKD] \xrightarrow{L1.2.1.5} K = C$. Using the result just proven, we also obtain $[ABC] \& [BCD] \xrightarrow{A1.2.2} [DCB] \& [CBA] \xrightarrow{\text{above}} [DBA] \xrightarrow{A1.2.2} [ABD]$. \square

¹⁵The theorem is, obviously, also true in the case when one of the points lies on the line formed by the two others, i.e. when, say, $B \in a_{AC}$, because this is equivalent to collinearity.

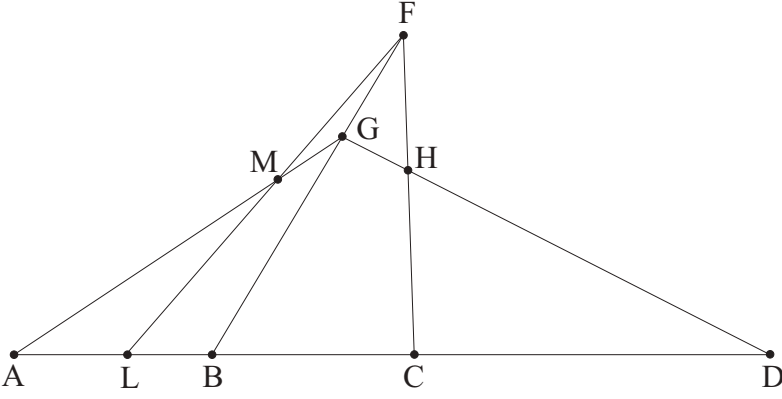

Figure 1.6: If B lies on (AC) , and C lies on (AD) , then B also lies on (AD) , and C lies on (BD) . The converse is also true.

Lemma 1.2.3.2. *If a point B lies on an open interval (AC) , and the point C lies on an open interval (AD) , then B also lies on the open interval (AD) , and C lies on the open interval (BD) . The converse is also true. That is, $[ABC] \& [ACD] \Leftrightarrow [BCD] \& [ABD]$.¹⁶*

Proof. (See Fig. 1.6.) By A 1.2.1, L 1.1.1.7 $\exists a (A \in a \& B \in a \& C \in a \& D \in a)$. By L 1.1.2.1 $\exists G G \notin a$. By A 1.2.2 $\exists F [BGF]$. From C 1.2.1.8 $F \notin a_{AB} = a_{AC} = a_{BC} = a_{BD}$, and therefore by C 1.1.2.3 $A \notin a_{BF}$, $A \notin a_{FC}$, $D \notin a_{FC}$, $D \notin a_{BF}$. $\neg \exists M (M \in a_{FC} \& [AMC])$, because $[BGF] \& A \notin a_{BF} \& F \in a_{FC} \& M \in a_{FC} \& [AMG] \xrightarrow{C1.2.1.7} \exists L (L \in a_{FC} \& [ALB])$ and therefore $A \notin a_{FC} \& L \in a_{FC} \& C \in a_{FC} \& [ALB] \& C \in a_{AB} \xrightarrow{L1.2.1.5} L = C$, whence $[ACB] \xrightarrow{A1.2.3} \neg [ABC]$ - a contradiction. $B \in a_{AD} \subset \alpha_{AGD} \& G \in \alpha_{AGD} \& F \in a_{BG} \& C \in a_{AD} \subset \alpha_{AGD} \xrightarrow{A1.1.6} a_{FC} \subset \alpha_{AGD}$. $C \in a_{FC} \& [ACD] \& \neg \exists M (M \in a_{FC} \& [AMG]) \xrightarrow{A1.2.4} \exists H (H \in a_{FC} \& [GHD])$. $[BGF] \& D \notin a_{BF} \& F \in a_{CF} \& C \in a_{CF} \& [GHD] \xrightarrow{C1.2.1.7} \exists I (I \in a_{CF} \& [BID])$. $D \notin a_{CF} \& I \in a_{CF} \& C \in a_{CF} \& [BID] \& C \in a_{BD} \xrightarrow{L1.2.1.5} I = C$, whence $[BCD]$. $[ABC] \& [BCD] \xrightarrow{L1.2.3.1} [ABD]$. To prove the converse, note that $[ABD] \& [BCD] \xrightarrow{A1.2.1} [DCB] \& [DBA] \xrightarrow{\text{above}} [DCA] \& [CBA] \xrightarrow{A1.2.1} [ACD] \& [ABC]$. \square

If $[CD] \subset (AB)$, we say that the interval CD lies inside the interval AB .

Theorem 1.2.3. *Suppose each of the points C, D lie between points A and B . If a point M lies between C and D , it also lies between A and B . In other words, if points C, D lie between points A and B , the open interval (CD) lies inside the open interval (AB) .*

Proof. (See Fig. 1.8) By A 1.2.1, L 1.1.1.7 $\exists a (A \in a \& B \in a \& C \in a \& D \in a)$, and all points A, B, C, D are distinct, whence by T 1.2.2 $[ACD] \vee [ADC] \vee [CAD]$. But $\neg [CAD]$, because otherwise $[CAD] \& [ADB] \xrightarrow{L1.2.3.1} [CAB] \xrightarrow{A1.2.3} \neg [ACB]$ - a contradiction. Finally, $[ACD] \& [CMD] \xrightarrow{L1.2.3.2} [AMD]$ and $[AMD] \& [ADB] \xrightarrow{L1.2.3.2} [AMB]$. \square

Lemma 1.2.3.3. *If points A, B, D do not colline, a point F lies between A, B and the point C lies between B, D , there is a point E , which lies between C, A as well as between D, F .*

Proof. (See Fig. 1.7.) $[AFB] \xrightarrow{A1.2.1} A \neq F \neq B$. $F \neq B \xrightarrow{A1.2.2} \exists H [FBH]$. $[AFH] \& [FBH] \xrightarrow{L1.2.3.1} [AFH] \& [ABH]$. Denote for the duration of this proof $a \Rightarrow a_{FB} = a_{AB} = a_{AF} = a_{FH} = \dots$ (see L 1.2.1.3). By C 1.1.2.3 that A, B, D do not colline implies $D \notin a$. We have $[FBH] \& D \notin a \& [BCD] \xrightarrow{C1.2.1.7} \exists R [FRD] \& [HCR]$. $[AFH] \& D \notin a \& [FRD] \xrightarrow{C1.2.1.7} \exists L [ALD] \& [HRL]$. $[HCR] \& [HRL] \xrightarrow{L1.2.3.2} [HCL] \xrightarrow{L1.2.1.3} H \in a_{CL}$. Observe that $B \in a \& [BCD] \& D \notin a \xrightarrow{C1.2.1.7} C \notin a$, and therefore $C \notin a_{AL}$,¹⁷ because otherwise $C \in a_{AL} \& L \neq C \xrightarrow{C1.1.1.2} A \in a_{LC}$ and $A \in a_{LC} \& H \in a_{LC} \xrightarrow{A1.1.2} a_{LC} = a_{AH} = a \Rightarrow C \in a$ - a contradiction. $C \notin a_{AL} \& [ALD] \& [LRC] \xrightarrow{C1.2.1.7} \exists E [AEC] \& [DRE]$. $D \notin a = a_{AB} \xrightarrow{C1.1.2.3} A \notin a_{BD}$. $A \notin a_{BD} \& [BCD] \& [CEA] \xrightarrow{C1.2.1.7} \exists X ([BXA] \& [DEX])$. $[DRE] \& [DEX] \xrightarrow{L1.2.3.2} [DRX]$. $[FRD] \& [DRX] \& [BXA] \xrightarrow{L1.2.1.3} F \in a_{DR} \& X \in a_{DR} \& X \in a$. $D \notin a \Rightarrow a_{DR} \neq a$. Finally, $F \in a \cap a_{DR} \& X \in a \cap a_{DR} \& a \neq a_{DR} \xrightarrow{A1.1.2} X = F$. \square

Proposition 1.2.3.4. *If two (distinct) points E, F lie on an open interval (AB) (i.e., between points A, B), then either E lies between A and F or F lies between A and E .*

¹⁶Note that in different words this lemma implies that if a point C lies on an open interval (AD) , the open intervals (AC) , (CD) are both subsets of (AD) .

¹⁷ a_{AL} definitely exists, because $[ALD] \Rightarrow A \neq L$.

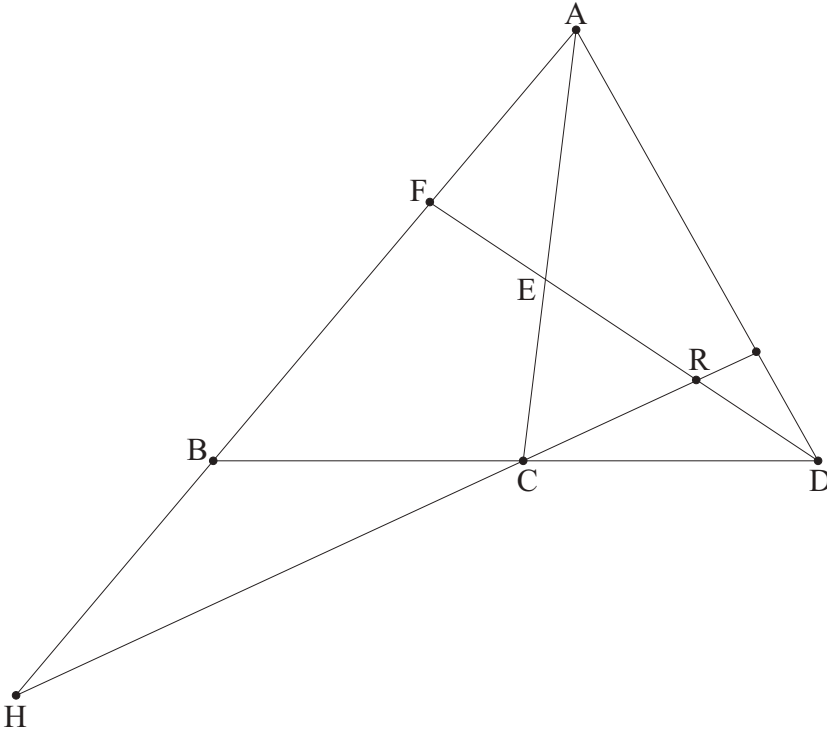

Figure 1.7: If A, B, D do not colline, F lies between A, B , and C lies between B, D , there is a point E with $[CEA]$ and $[DEF]$.



Figure 1.8: If C, D lie between A and B , (CD) lies inside (AB) .

18

Proof. By A 1.2.1 $[AEB] \& [AFB] \Rightarrow A \neq E \& A \neq F$, and the points A, B, E, F are collinear (by L 1.2.1.3 $E \in a_{AB}, F \in a_{AB}$). Also, by hypothesis, $E \neq F$. Therefore, by T 1.2.2 $[EAF] \vee [AEF] \vee [AFE]$. But $[EAF] \& E \in (AB) \& F \in (AB) \xrightarrow{T1.2.3} A \in (AB)$, which is absurd as it contradicts A 1.2.1. We are left with $[AEF] \vee [AFE]$, q.e.d. \square

Lemma 1.2.3.5. *If both ends of an interval CD lie on a closed interval $[AB]$, the open interval (CD) is included in the open interval (AB) .*

Proof. Follows immediately from L 1.2.3.2, T 1.3.3. \square

Theorem 1.2.4. *If a point C lies between points A and B , then none of the points of the open interval (AC) lie on the open interval (CB) .*

Proof. (See Fig. 1.9) $[AMC] \& [ACB] \xrightarrow{L1.2.3.2} [MCB] \xrightarrow{A1.2.3} \neg[CMB]$. \square

Theorem 1.2.5. *If a point C lies between points A and B , then any point of the open interval (AB) , distinct from C , lies either on the open interval (AC) or on the open interval (CB) .* ¹⁹

Proof. By A 1.2.1, L 1.1.1.7 $\exists a (A \in a \& B \in a \& C \in a \& M \in a)$, whence by T 1.2.2 $[CBM] \vee [CMB] \vee [MCB]$. But $\neg[CMB]$, because otherwise $[ACB] \& [CBM] \xrightarrow{L1.2.3.1} [ABM] \xrightarrow{A1.2.3} \neg[AMB]$ - a contradiction. Finally, $[AMB] \& [MCB] \xrightarrow{L1.2.3.2} [AMC]$. \square

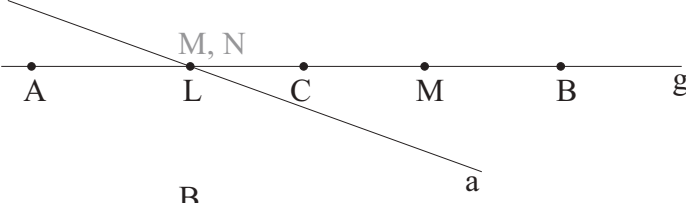

Figure 1.9: If C lies between A and B , then (AC) has no common points with (CB) . Any point of (AB) lies either on (AC) or (CB) .



Figure 1.10: If C lies between A and B , any point M of AB , $M \neq C$, lies either on (AC) or on CB .

1)



2)

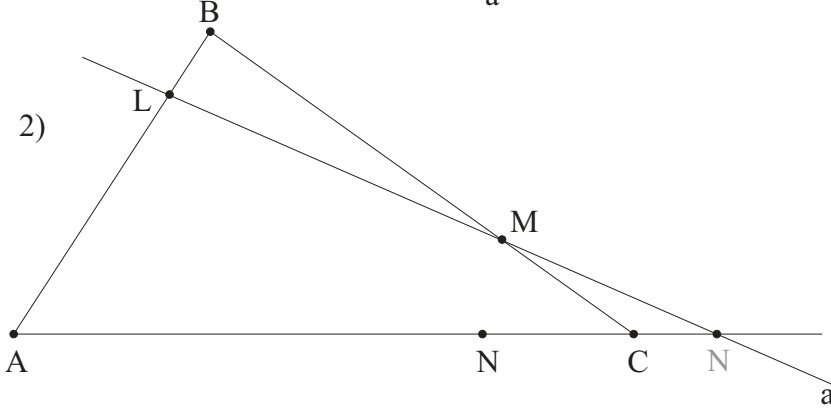

Figure 1.11: If O divides A and C , A and D , it does not divide C and D .

Proposition 1.2.5.1. *If a point O divides points A and C , as well as A and D , then it does not divide C and D .*

Proof. (See Fig. 1.10) By L 1.1.1.7, A 1.2.1 $[AOC] \& [AOD] \Rightarrow A \neq C \& A \neq D \& \exists a (A \in a \& C \in a \& D \in a)$. If also $C \neq D$ ²⁰, from T 1.2.2 $[CAD] \vee [ACD] \vee [ADC]$. But $\neg[CAD]$, because $[CAD] \& [AOD] \xrightarrow{L1.2.3.2} [CAO] \xrightarrow{A1.2.3} \neg[AOC]$. Hence by T 1.2.4 $([ACD] \vee [ADC]) \& [AOC] \& [AOD] \Rightarrow \neg[COD]$. \square

Proposition 1.2.5.2. *If two points or both ends of an interval-like set lie on line a , this set lies on line a .*

Proposition 1.2.5.3. *If two points or both ends of an interval-like set with the ends A, B lie in plane α , then the line a_{AB} , and, in particular, the set itself, lies in plane α .*

Theorem 1.2.6. *Let either*

- A, B, C be three collinear points, at least one of them not on line a ,
- or
- A, B, C be three non-collinear point, and a is an arbitrary line.

Then the line a cannot meet all of the open intervals (AB) , (BC) , and (AC) .

Proof. (See Fig. 1.2) Suppose $\exists L (L \in a \& [ALB]) \& \exists M (M \in a \& [BMC]) \& \exists N (N \in a \& [ANC])$. If $A \notin a$, then also $B \notin a \& C \notin a$, because otherwise by A 1.1.2, L 1.2.1.3 $((B \in a \vee C \in a) \& [ALB] \& [ANC]) \Rightarrow (a = a_{AB}) \vee (a = a_{AC}) \Rightarrow A \in a$.

1) Let $\exists g (A \in g \& B \in g \& C \in g)$. Then by T 1.2.2 $[ACB] \vee [ABC] \vee [CAB]$. Suppose that $[ACB]$.²¹ Then $A \notin a \& A \in g \Rightarrow a \neq g$, $[ALB] \& [BMC] \& [ANC] \xrightarrow{L1.2.1.3} L \in a_{AB} = g \& M \in a_{BC} = g \& N \in a_{AC} = g$, and therefore $L \in a \cap g \& M \in a \cap g \& N \in a \cap g \& a \neq g \xrightarrow{T1.1.1} L = M = N$, whence $[ALC] \& [CLB]$, which contradicts $[ACB]$ by T 1.1.1.

2) Now suppose $\neg \exists g (A \in g \& B \in g \& C \in g)$, and therefore $a_{AB} \neq a_{BC} \neq a_{AC}$. $L \neq M$, because $[ALB] \& [BLC] \xrightarrow{L1.2.1.3} L \in a_{AB} \& L \in a_{BC} \Rightarrow a_{AB} = a_{BC}$, $L \neq N$, because $[ALB] \& [ALC] \xrightarrow{L1.2.1.3} L \in a_{AB} \& L \in a_{AC} \Rightarrow a_{AB} = a_{AC}$, and $M \neq N$, because $[BLC] \& [ALC] \xrightarrow{L1.2.1.3} L \in a_{BC} \& L \in a_{AC} \Rightarrow a_{BC} = a_{AC}$. $L \neq M \neq N \& L \in a \& M \in a \& N \in a \xrightarrow{T1.2.2} [LMN] \vee [LNM] \vee [MLN]$. Suppose $[LMN]$.²² Then $[ANC] \& a_{AB} \neq$

¹⁹Thus, based on this theorem and some of the preceding results (namely, T 1.2.1, L 1.2.3.2, T 1.2.4), we can write $[ABC] \Rightarrow (AC) = (AB) \cup \{B\} \cup (BC)$, $(AB) \subset (AC)$, $(BC) \subset (AC)$, $(AB) \cap (BC) = \emptyset$.

²⁰for $C = D$ see A 1.2.1

²¹Since A, B, C , and therefore L, M, N , enter the conditions of the theorem symmetrically, we can do this without any loss of generality and not consider the other two cases

²²See previous footnote



Figure 1.12: Every point, except the first and the last, lies between the two points with adjacent (in \mathbb{N}) numbers

$a_{AC} \Rightarrow N \notin a_{AB}$, $[ALB] \& N \notin a_{AB} \& B \in a_{BC} \& C \in a_{BC} \& [LMN] \xrightarrow{C1.2,1.7} \exists D (D \in a_{BC} \& [ADN])$ and $A \notin a_{BC} \& C \in a_{BC} \& D \in a_{BC} \& C \in a_{AN} \& [ADN] \xrightarrow{L1.2,1.5} C = D$, whence $[ACN] \xrightarrow{A1.2,3} \neg[ANC]$ - a contradiction. \square

Denote $\mathbb{N}_n \Rightarrow \{1, 2, \dots, n\}$

Betweenness Properties for n Collinear Points

Lemma 1.2.7.1. *Suppose $A_1, A_2, \dots, A_n, (\dots)$, where $n \in \mathbb{N}_n (n \in \mathbb{N})$ is a finite (infinite) sequence of points with the property that a point lies between two other points if its number has an intermediate value between the numbers of these points. Then if a point of the sequence lies between two other points of the same sequence, its number has an intermediate value between the numbers of these two points. That is, $(\forall i, j, k \in \mathbb{N}_n$ (respectively, \mathbb{N}) $((i < j < k) \vee (k < j < i) \Rightarrow [A_i A_j A_k])) \Rightarrow (\forall i, j, k \in \mathbb{N}_n$ (respectively, \mathbb{N}) $([A_i A_j A_k] \Rightarrow (i < j < k) \vee (k < j < i))$).*

Proof. Suppose $[A_i A_j A_k]$. Then $i < j < k$ or $k < j < i$, because $(j < i < k) \vee (k < i < j) \vee (i < k < j) \vee (j < k < i) \Rightarrow [A_j A_k A_i] \vee [A_j A_k A_i] \xrightarrow{A1.2,3} \neg[A_i A_j A_k]$ - a contradiction. \square

Let an infinite (finite) sequence of points A_i , where $i \in \mathbb{N} (i \in \mathbb{N}_n, n \geq 4)$, be numbered in such a way that, except for the first and (in the finite case) the last, every point lies between the two points with adjacent (in \mathbb{N}) numbers. (See Fig. 1.12.) Then:

Lemma 1.2.7.2. - *All these points are on one line, and all lines $a_{A_i A_j}$ (where $i, j \in \mathbb{N}_n, i \neq j$) are equal.*

Proof. Follows from A 1.2.1, L 1.1.1.7. \square

Lemma 1.2.7.3. - *A point lies between two other points iff its number has an intermediate value between the numbers of these two points;*

Proof. By induction. $[A_1 A_2 A_3] \& [A_2 A_3 A_4] \xrightarrow{L1.2,3,1} [A_1 A_2 A_4] \& [A_1 A_3 A_4] (n = 4)$. $[A_i A_{n-2} A_{n-1}] \& [A_{n-2} A_{n-1} A_n] \xrightarrow{L1.2,3,1} [A_i A_{n-1} A_n]$, $[A_i A_j A_{n-1}] \& [A_j A_{n-1} A_n] \xrightarrow{L1.2,3,2} [A_i A_j A_n]$. \square

Lemma 1.2.7.4. - *An arbitrary point cannot lie on more than one of the open intervals formed by pairs of points with adjacent numbers;*

Proof. Suppose $[A_i B A_{i+1}]$, $[A_j B A_{j+1}]$, $i < j$. By L 1.2.7.3 $[A_i A_{i+1} A_{j+1}]$, whence $[A_i B A_{i+1}] \& [A_i A_{i+1} A_{j+1}] \xrightarrow{T1.2,4} \neg[A_{i+1} B A_{j+1}] \Rightarrow j \neq i+1$. But if $j > i+1$ we have $[A_{i+1} A_j A_{j+1}] \& [A_j B A_{j+1}] \xrightarrow{L1.2,3,2} [A_{i+1} B A_{j+1}]$ - a contradiction. \square

Lemma 1.2.7.5. - *In the case of a finite sequence, a point which lies between the end (the first and the last) points of the sequence, and does not coincide with the other points of the sequence, lies on at least one of the open intervals, formed by pairs of points of the sequence with adjacent numbers.*

Proof. By induction. For $n = 3$ see T 1.2.5. $[A_1 B A_n] \& B \notin \{A_2, \dots, A_{n-1}\} \xrightarrow{T1.2,5} ([A_1 B A_{n-1}] \vee [A_{n-1} B A_n]) \& B \notin \{A_2, \dots, A_{n-2}\} \Rightarrow (\exists i \in \mathbb{N}_{n-2} \& [A_i B A_{i+1}] \vee [A_{n-1} B A_n] \Rightarrow \exists i \in \mathbb{N}_{n-1} \& [A_i B A_{i+1}])$. \square

Lemma 1.2.7.6. - *All of the open intervals $(A_i A_{i+1})$, where $i = 1, 2, \dots, n-1$, lie in the open interval $(A_1 A_n)$, i.e. $\forall i \in \{1, 2, \dots, n-1\} (A_i A_{i+1}) \subset (A_1 A_n)$.*

Proof. By induction on n . For $n = 4$ $([A_1 M A_2] \vee [A_2 M A_3]) \& [A_1 A_2 A_3] \xrightarrow{L1.2,3,2} [A_1 M A_3]$.

If $M \in (A_i A_{i+1})$, $i \in \{1, 2, \dots, n-2\}$, then by induction hypothesis $M \in (A_1 A_{n-1})$, by L 1.2.7.3 $[A_1 A_{n-1} A_n]$, therefore $[A_1 M A_{n-1}] \& [A_1 A_{n-1} A_n] \xrightarrow{L1.2,3,2} [A_1 M A_n]$; if $M \in (A_{n-1} A_n)$ then $[A_1 A_{n-1} A_n] \& [A_{n-1} M A_n] \xrightarrow{L1.2,3,2} [A_1 M A_n]$. \square

Lemma 1.2.7.7. - *The half-open interval $[A_1 A_n)$ is the disjoint union of the half-open intervals $[A_i A_{i+1})$, where $i = 1, 2, \dots, n-1$:*

$$[A_1 A_n) = \bigcup_{i=1}^{n-1} [A_i A_{i+1}).$$

Also,

The half-closed interval $(A_1 A_n]$ is a disjoint union of the half-closed intervals $(A_i A_{i+1}]$, where $i = 1, 2, \dots, n-1$:

$$(A_1 A_n] = \bigcup_{i=1}^{n-1} (A_i A_{i+1}].$$



Figure 1.13: Any open interval contains infinitely many points.

Proof. Use L 1.2.7.5, L 1.2.7.3, L 1.2.7.6. \square

This lemma gives justification for the following definition:

If a finite sequence of points A_i , where $i \in \mathbb{N}_n$, $n \geq 4$, has the property that every point of the sequence, except for the first and the last, lies between the two points with adjacent (in \mathbb{N}) numbers, we say that the interval A_1A_n is divided into $n - 1$ intervals $A_1A_2, A_2A_3, \dots, A_{n-1}A_n$ (by the points A_2, A_3, \dots, A_{n-1}).

If a finite (infinite) sequence of points A_i , $i \in \mathbb{N}_n$, $n \geq 3$ ($n \in \mathbb{N}$) on one line has the property that a point lies between two other points iff its number has an intermediate value between the numbers of these two points, we say that the points $A_1, A_2, \dots, A_n(\dots)$ are in order $[A_1A_2 \dots A_n(\dots)]$. Note that for $n = 3$ three points A_1, A_2, A_3 are in order $[A_1A_2A_3]$ iff A_2 divides A_1 and A_3 , so our notation $[A_1A_2A_3]$ is consistent.

Theorem 1.2.7. *Any finite sequence of distinct points A_i , $i \in \mathbb{N}_n$, $n \geq 4$ on one line can be renumbered in such a way that a point lies between two other points iff its number has an intermediate value between the numbers of these two points. In other words, any finite sequence of points A_i , $i \in \mathbb{N}_n$, $n \geq 4$ on a line can be put in order $[A_1A_2 \dots A_n]$.*

By a renumbering of a finite sequence of points A_i , $i \in \mathbb{N}_n$, $n \geq 4$ we mean a bijective mapping (permutation) $\sigma : \mathbb{N}_n \rightarrow \mathbb{N}_n$, which induces a bijective transformation $\sigma_S : \{A_1, A_2, \dots, A_n\} \rightarrow \{A_1, A_2, \dots, A_n\}$ of the set of points of the sequence by $A_i \mapsto A_{\sigma(i)}$, $i \in \mathbb{N}_n$.

The theorem then asserts that for any finite (infinite) sequence of points A_i , $i \in \mathbb{N}_n$, $n \geq 4$ on one line there is a bijective mapping (permutation) of renumbering $\sigma : \mathbb{N}_n \rightarrow \mathbb{N}_n$ such that $\forall i, j, k \in \mathbb{N}_n$ ($i < j < k$) \vee ($k < j < i$) $\Leftrightarrow [A_{\sigma(i)}A_{\sigma(j)}A_{\sigma(k)}]$.²³

Proof. Let $[A_lA_mA_n]$, $l \neq m \neq n$, $l \in \mathbb{N}_4$, $m \in \mathbb{N}_4$, $n \in \mathbb{N}_4$ (see T 1.2.2). If $p \in \mathbb{N}_4$ & $p \neq l$ & $p \neq m$ & $p \neq n$, then by T 1.2.2, T 1.2.5 $[A_pA_lA_n] \vee [A_lA_pA_m] \vee [A_mA_pA_n] \vee [A_lA_pA_n] \vee [A_lA_nA_p]$.

Define the values of the function σ by

for $[A_pA_lA_n]$ let $\sigma(1) = p$, $\sigma(2) = l$, $\sigma(3) = m$, $\sigma(4) = n$;

for $[A_lA_pA_m]$ let $\sigma(1) = l$, $\sigma(2) = p$, $\sigma(3) = m$, $\sigma(4) = n$;

for $[A_mA_pA_n]$ let $\sigma(1) = l$, $\sigma(2) = m$, $\sigma(3) = p$, $\sigma(4) = n$;

for $[A_lA_nA_p]$ let $\sigma(1) = l$, $\sigma(2) = m$, $\sigma(3) = n$, $\sigma(4) = p$.

Now suppose that $\exists \tau : \mathbb{N}_{n-1} \rightarrow \mathbb{N}_{n-1}$ such that $\forall i, j, k \in \mathbb{N}_{n-1}$ ($i < j < k$) \vee ($k < j < i$) $\Leftrightarrow [A_{\tau(i)}A_{\tau(j)}A_{\tau(k)}]$. By T 1.2.2, L 1.2.7.5 $[A_nA_{\tau(1)}A_{\tau(n-1)}] \vee [A_{\tau(1)}A_{\tau(n-1)}A_{\tau(n)}] \vee \exists i \in \mathbb{N}_{n-2}$ & $[A_{\tau(i)}A_nA_{\tau(n+1)}]$.

The values of σ are now given

for $[A_nA_{\sigma(1)}A_{\sigma(n-1)}]$ by $\sigma(1) = n$ and $\sigma(i+1) = \tau(i)$, where $i \in \mathbb{N}_{n-1}$;

for $[A_{\sigma(i)}A_{\sigma(n-1)}A_{\sigma(n)}]$ by $\sigma(i) = \tau(i)$, where $i \in \mathbb{N}_{n-1}$, and $\sigma(n) = n$;

for $[A_{\sigma(i)}A_nA_{\sigma(i+1)}]$ by $\sigma(j) = \tau(j)$, where $j \in \{1, 2, \dots, i\}$, $\sigma(i+1) = n$, and $\sigma(j+1) = \tau(j)$, where $j \in \{i+1, i+2, \dots, n-1\}$. See L 1.2.7.3. \square

Every Open Interval Contains Infinitely Many Points

Lemma 1.2.8.1. *For any finite set of points $\{A_1, A_2, \dots, A_n\}$ of an open interval (AB) there is a point C on (AB) not in that set.*

Proof. (See Fig. 1.13.) Using T 1.2.7, put the points of the set $\{A, A_1, A_2, \dots, A_n, B\}$ in order $[A, A_1, A_2, \dots, A_n, B]$. By T 1.2.2 $\exists C [A_1CA_2]$. By T 1.2.3 $[ACB]$ and $C \neq A_1, A_2, \dots, A_n$, because by A 1.2.3 $[A_1CA_2] \Rightarrow \neg[A_1A_2C]$ and by A 1.2.1 $C \neq A_1, A_2$. \square

Theorem 1.2.8. *Every open interval contains an infinite number of points.*

Corollary 1.2.8.2. *Any interval-like set contains infinitely many points.*

Further Properties of Open Intervals

Lemma 1.2.9.1. *Let A_i , where $i \in \mathbb{N}_n$, $n \geq 4$, be a finite sequence of points with the property that every point of the sequence, except for the first and the last, lies between the two points with adjacent (in \mathbb{N}) numbers. Then if $i \leq j \leq l$, $i \leq k \leq l$, $i, j, k, l \in \mathbb{N}_n$ ($i, j, k, l \in \mathbb{N}$), the open interval (A_jA_k) is included in the open interval (A_iA_l) .²⁴ Furthermore, if $i < j < k < l$ and $B \in (A_jA_k)$ then $[A_iA_jB]$.²⁵*

²³The present theorem can thus be viewed as a direct generalization of T 1.2.2.

²⁴In particular, given a finite (countable infinite) sequence of points A_i , $i \in \mathbb{N}_n$ ($n \in \mathbb{N}$) in order $[A_1A_2 \dots A_n(\dots)]$, if $i \leq j \leq l$, $i \leq k \leq l$, $i, j, k, l \in \mathbb{N}_n$ ($i, j, k, l \in \mathbb{N}$), the open interval (A_jA_k) is included in the open interval (A_iA_l) .

²⁵Also, $[BA_kA_l]$, but this gives nothing new because of symmetry.

Proof. Assume $j < k$.²⁶ Then $i = j \& k = l \Rightarrow (A_i A_l) = (A_j A_k)$; $i = j \& k < l \Rightarrow [A_i A_k A_l] \xrightarrow{L1.2.3.2} (A_j A_k) \subset (A_i A_l)$; $i < j \& k = l \Rightarrow [A_i A_j A_k] \xrightarrow{L1.2.3.2} (A_j A_k) \subset (A_i A_l)$. $i < j \& k < l \Rightarrow [A_i A_j A_l] \& [A_i A_k A_l] \xrightarrow{L1.2.3.2} (A_j A_k) \subset (A_i A_l)$.

The second part follows from $[A_i A_j A_k] \& [A_j B A_k] \xrightarrow{L1.2.3.2} [A_i A_j B]$. \square

Let an interval $A_0 A_n$ be divided into intervals $A_0 A_1, A_1 A_2, \dots, A_{n-1} A_n$.²⁷ Then

Lemma 1.2.9.2. – *If $B_1 \in (A_{k-1} A_k)$, $B_2 \in (A_{l-1} A_l)$, $k < l$ then $[A_0 B_1 B_2]$. Furthermore, if $B_2 \in (A_{k-1} A_k)$ and $[A_{k-1} B_1 B_2]$, then $[A_0 B_1 B_2]$.*

Proof. By L 1.2.7.3 $[A_0 A_k A_m]$. Using L 1.2.9.1, (since $0 \leq k-1, k \leq l-1 < n$) we obtain $[A_0 B_1 A_k]$, $[A_k B_2 A_n]$. Hence $[B_1 A_k A_m] \& [A_k B_2 A_m] \xrightarrow{L1.2.3.2} [B_1 A_k B_2]$, $[A_0 B_1 A_k] \& [B_1 A_k B_2] \xrightarrow{L1.2.3.1} [A_0 B_1 B_2]$. To show the second part, observe that for $0 < k-1$ we have by the preceding lemma (the second part of L 1.2.9.1) $[A_0 A_{k-1} B_2]$, whence $[A_0 A_{k-1} B_2] \& [A_{k-1} B_1 B_2] \xrightarrow{L1.2.3.2} [A_0 B_1 B_2]$. \square

Corollary 1.2.9.3. – *If $B_1 \in [A_{k-1} A_k]$, $B_2 \in [A_{l-1} A_l]$, $k < l$, then $[A B_1 B_2]$.*

Proof. Follows from the preceding lemma (L 1.2.9.2) and L 1.2.9.1. \square

Lemma 1.2.9.4. – *If $[A_0 B_1 B_2]$ and $B_2 \in (A_0 A_n)$, then either $B_1 \in [A_{k-1} A_k]$, $B_2 \in [A_{l-1} A_l]$, where $0 < k < l \leq n$, or $B_1 \in [A_{k-1} A_k]$, $B_2 \in [A_{k-1} A_k]$, in which case either $B_1 = A_{k-1}$ and $B_2 \in (A_{k-1} A_k)$, or $[A_{k-1} B_1 B_2]$, where $B_1, B_2 \in (A_{k-1} A_k)$.*

Proof. $[A_0 B_1 B_2] \& [A_0 B_2 A_n] \xrightarrow{L1.2.3.2} [A_0 B_1 A_k]$. By L 1.2.7.7 we have $B_1 \in [A_{k-1} A_k]$, $B_2 \in [A_{l-1} A_l]$, where $k, l \in \mathbb{N}_n$. Show $k \leq l$. In fact, otherwise $B_1 \in [A_{k-1} A_k]$, $B_2 \in [A_{l-1} A_l]$, $k > l$ would imply $[A_0 B_2 B_1]$ by the preceding corollary, which, according to A 1.2.3, contradicts $[A_0 B_1 B_2]$. Suppose $k = l$. Note that $[A_0 B_1 B_2] \xrightarrow{A1.2.1} B_1 \neq B_2 \neq A_0$. The assumption $B_2 = A_{k-1}$ would (by L 1.2.9.1; we have in this case $0 < k-1$, because $B_2 \neq A_0$) imply $[A_0 B_2 B_1]$ - a contradiction. Finally, if $B_1, B_2 \in (A_{k-1} A_k)$ then by P 1.2.3.4 either $[A_{k-1} B_1 B_2]$ or $[A_{k-1} B_2 B_1]$. But $[A_{k-1} B_2 B_1]$ would give $[A_0 B_2 B_1]$ by (the second part of) L 1.2.9.2. Thus, we have $[A_{k-1} B_1 B_2]$. There remains also the possibility that $B_1 = A_{k-1}$ and $B_2 \in [A_{k-1} A_k]$. \square

Lemma 1.2.9.5. – *If $0 \leq j < k \leq l-1 < n$ and $B \in (A_{l-1} A_l)$ then $[A_j A_k B]$.*²⁸

Proof. By L 1.2.7.7 $[A_j A_k A_l]$. By L 1.2.9.1 $[A_k B A_l]$. Therefore, $[A_j A_k A_l] \& [A_k B A_l] \xrightarrow{L1.2.3.2} [A_j A_k B]$. \square

Lemma 1.2.9.6. – *If $D \in (A_{j-1} A_j)$, $B \in (A_{l-1} A_l)$, $0 < j \leq k \leq l-1 < n$, then $[D A_k B]$.*

Proof. Since $j \leq k \Rightarrow j-1 < k$, we have from the preceding lemma (L 1.2.9.5) $[A_{j-1} A_k B]$ and from L 1.2.9.1 $[A_{j-1} D A_k]$. Hence by L 1.2.3.2 $[D A_k B]$. \square

Lemma 1.2.9.7. – *If $B_1 \in (A_i A_j)$, $B_2 \in (A_k A_l)$, $0 \leq i < j < k < l \leq n$ then $(A_j A_k) \subset (B_1 A_k) \subset (B_1 B_2) \subset (B_1 A_l) \subset (A_i A_l)$, $(A_j A_k) \neq (B_1 A_k) \neq (B_1 B_2) \neq (B_1 A_l) \neq (A_i A_l)$ and $(A_j A_k) \subset (A_j B_2) \subset (B_1 B_2) \subset (A_i B_2) \subset (A_i A_l)$, $(A_j A_k) \neq (A_j B_2) \neq (B_1 B_2) \neq (A_i B_2) \neq (A_i A_l)$.*

*Proof.*²⁹ Using the lemmas L 1.2.3.1, L 1.2.3.2 and the results following them (summarized in the footnote accompanying T 1.2.5), we can write $[A_i B_1 A_j] \& [A_i A_j A_k] \xrightarrow{L1.2.3.2} [B_1 A_j A_k] \Rightarrow (A_j A_k) \subset (B_1 A_k) \& (A_j A_k) \neq (B_1 A_k)$. Also, $[A_j A_k A_l] \& [A_k B_2 A_l] \Rightarrow [A_j A_k B_2] \Rightarrow (A_j A_k) \subset (A_j B_2) \& (A_j A_k) \neq (A_j B_2)$. $[B_1 A_j A_k] \& [A_j A_k B_2] \xrightarrow{L1.2.3.1} [B_1 A_j B_2] \& [B_1 A_k B_2] \Rightarrow (A_j B_2) \subset (B_1 B_2) \& (A_j B_2) \neq (B_1 B_2) \& (B_1 A_k) \subset (B_1 B_2) \& (B_1 A_k) \neq (B_1 B_2)$. $[B_1 A_k B_2] \& [A_k B_2 A_l] \Rightarrow [B_1 B_2 A_l] \Rightarrow (B_1 B_2) \subset (B_1 A_l) \Rightarrow (B_1 B_2) \neq (B_1 A_l)$. $[A_i B_1 A_j] \& [B_1 A_j B_2] \Rightarrow [A_i B_1 B_2] \Rightarrow (B_1 B_2) \subset (A_i B_2) \Rightarrow (B_1 B_2) \neq (A_i B_2)$. $[A_i B_1 B_2] \& [B_1 B_2 A_l] \Rightarrow [A_i B_1 A_l] \& [A_i B_2 A_l] \Rightarrow (B_1 A_l) \subset (A_i A_l) \& (B_1 A_l) \neq (A_i A_l) \& (A_i B_2) \subset (A_i A_l) \& (A_i B_2) \neq (A_i A_l)$. \square

Lemma 1.2.9.8. – *Suppose $B_1 \in [A_k A_{k+1}]$, $B_2 \in [A_l A_{l+1}]$, where $0 < k+1 < l < n$. Then $(A_{k+1} A_l) \subset (B_1 B_2) \subset (A_k A_{l+1})$, $(A_{k+1} A_l) \neq (B_1 B_2) \neq (A_k A_{l+1})$.*

²⁶Due to symmetry, we can do so without loss of generality.

²⁷Recall that by L 1.2.7.3 this means that the points $A_0, A_1, A_2, \dots, A_n$ are in order $[A_0 A_1 A_2 \dots A_n]$.

²⁸Similarly, it can be shown that if $0 < l \leq j < k \leq n$ and $B \in (A_{l-1} A_l)$ then $[B A_j A_k]$. Because of symmetry this essentially adds nothing new to the original statement.

²⁹An easier and perhaps more elegant way to prove this lemma follows from the observation that the elements of the set $\{A_0, A_1, \dots, A_n, B_1, B_2\}$ are in order $[(A_0 \dots) A_i B_1 A_j \dots A_k B_2 A_l (\dots A_n)]$.

Proof. ³⁰ Suppose $B_1 = A_k$, $B_2 = A_l$. Then $[A_k A_{k+1} A_l] \Rightarrow (A_{k+1} A_l) \subset (A_k A_l) = (B_1 B_2) \& (A_{k+1} A_l) \neq (B_1 B_2)$. Also, in view of $k < k+1 < l < l+1$, taking into account L 1.2.9.1, we have $(A_{k+1} A_l) \subset (B_1 B_2) \subset (A_k A_{l+1}) \& (A_{k+1} A_l) \neq (B_1 B_2) \neq (A_k A_{l+1})$. Suppose now $B_1 = A_k$, $B_2 \in (A_l A_{l+1})$. Then $[A_k A_l A_{l+1}] \& [A_l B_2 A_{l+1}] \Rightarrow [A_k A_l B_2] \& [A_k B_2 A_{l+1}] \Rightarrow [B_1 B_2 A_{l+1}] \Rightarrow (B_1 B_2) \subset (A_k A_{l+1}) \& (B_1 B_2) \neq (A_k A_{l+1})$. $[A_k A_{k+1} A_l] \& [A_{k+1} A_l B_2] \Rightarrow [A_k A_{k+1} B_2] \Rightarrow (A_{k+1} B_2) \subset (A_k B_2) = (B_1 B_2) \& (A_{k+1} B_2) \neq (B_1 B_2)$. $(A_{k+1} A_l) \subset (A_{k+1} B_2) \& (A_{k+1} A_l) \neq (A_{k+1} B_2) \& (A_{k+1} B_2) \subset (B_1 B_2) \& (A_{k+1} B_2) \neq (B_1 B_2) \Rightarrow (A_{k+1} A_l) \subset (B_1 B_2) \& (A_{k+1} A_l) \neq (B_1 B_2)$. Now consider the case $B_1 \in (A_k A_{k+1})$, $B_2 = A_l$. We have $[A_k B_1 A_{k+1}] \& [A_k A_{k+1} A_l] \Rightarrow [A_l A_{k+1} A_l] \Rightarrow (A_{k+1} A_l) \subset (B_1 B_2) \& (A_{k+1} A_l) \neq (B_1 B_2)$. $[A_k A_{k+1} A_l] \& [A_k B_1 A_{k+1}] \Rightarrow [B_1 A_{k+1} A_l] \Rightarrow (A_{k+1} A_l) \subset (B_1 B_2) \& (A_{k+1} A_l) \neq (B_1 B_2)$. $[B_1 A_{k+1} A_l] \& [A_{k+1} A_l A_{l+1}] \Rightarrow [B_1 A_l A_{l+1}] \Rightarrow (B_1 B_2) = (B_1 A_l) \subset (B_1 A_{l+1}) \& (B_1 B_2) \neq (B_1 A_{l+1})$. $[A_k B_1 A_{k+1}] \& [A_k A_{k+1} A_{l+1}] \Rightarrow [A_k B_1 A_{l+1}] \Rightarrow (B_1 A_{l+1}) \subset (A_k A_{l+1}) \& (B_1 A_{l+1}) \neq (A_k A_{l+1})$. $(B_1 B_2) \subset (B_1 A_{l+1}) \& (B_1 B_2) \neq (B_1 A_{l+1}) \& (B_1 A_{l+1}) \subset (A_k A_{l+1}) \& (B_1 A_{l+1}) \neq (A_k A_{l+1}) \Rightarrow (B_1 B_2) \subset (A_k A_{l+1}) \& (B_1 B_2) \neq (A_k A_{l+1})$. Finally, in the case when $B_1 \in (A_k A_{k+1})$, $B_2 \in (A_l A_{l+1})$ the result follows immediately from the preceding lemma (L 1.2.9.7). \square

Lemma 1.2.9.9. *If open intervals (AD) , (BC) meet in a point E and there are three points in the set $\{A, B, C, D\}$ known not to colline, the open intervals (AD) , (BC) concur in E .*

Proof. If also $F \in (AD) \cap (BC)$, $F \neq E$, then by L 1.2.1.3, A 1.1.2 $a_{AD} = a_{BC}$, contrary to hypothesis. \square

Lemma 1.2.9.10. *Let $(B_1 D_1), (B_2 D_2), \dots, (B_n D_n)$ be a finite sequence of open intervals containing a point C and such that each of these open intervals $(B_j D_j)$ except the first has at least one of its ends not on any of the lines $a_{B_i D_i}$, $1 \leq i < j$ formed by the ends of the preceding (in the sequence) open intervals. ³¹ Then all intervals $(B_i D_i)$, $i \in \mathbb{N}_n$ concur in C .*

Proof. By L 1.2.9.9, we have for $1 \leq i < j \leq n$: $C \in (B_i D_i) \cap (B_j D_j) \& B_j \notin a_{B_i D_i} \vee D_j \notin a_{B_i D_i} \Rightarrow C = (B_i D_i) \cap (B_j D_j)$, whence the result. \square

Lemma 1.2.9.11. *Let $(B_1 D_1), (B_2 D_2), \dots, (B_n D_n)$ be a finite sequence of open intervals containing a point C and such that the line $a_{B_{i_0} D_{i_0}}$ defined by the ends of a (fixed) given open interval of the sequence contains at least one of the ends of every other open interval in the sequence. Then all points $C, B_i, D_i, i \in \mathbb{N}_n$ colline.*

Proof. By L 1.2.1.3, A 1.1.2, we have $\forall i \in \mathbb{N}_n \setminus i_0$ $(C \in (B_i D_i) \cap (B_{i_0} D_{i_0})) \& (B_i \in a_{B_{i_0} D_{i_0}} \vee D_i \in a_{B_{i_0} D_{i_0}}) \Rightarrow a_{B_i D_i} = a_{B_{i_0} D_{i_0}}$, whence all points $B_i, D_i, i \in \mathbb{N}_n$, are collinear. C also lies on the same line by L 1.2.1.3. \square

Lemma 1.2.9.12. *Let $(B_1 D_1), (B_2 D_2), \dots, (B_k D_k)$ be a finite sequence of open intervals containing a point C and such that the line $a_{B_{i_0} D_{i_0}}$ defined by the ends of a (fixed) given interval of the sequence contains at least one of the ends of every other interval in the sequence. Then there is an open interval containing the point C and included in all open intervals (B_i, D_i) , $i \in \mathbb{N}_k$ of the sequence.*

Proof. By (the preceding lemma) L 1.2.9.11 all points $C, B_i, D_i, i \in \mathbb{N}_k$ colline. Let A_1, A_2, \dots, A_n be the sequence of these points put in order $[A_1 A_2 \dots A_n]$, where $C = A_i$ for some $i \in \mathbb{N}_n$. (See T 1.2.7.) ³² Then $[A_{i-1} A_i A_{i+1}]$ and by L 1.2.9.1 for all open intervals $(A_k A_l)$, $1 < k < l < n$, corresponding to the open intervals of the original sequence, we have $(A_{i-1} A_{i+1}) \subset (A_k A_l)$. \square

Lemma 1.2.9.13. *If a finite number of open intervals concur in a point, no end of any of these open intervals can lie on the line formed by the ends of another interval.*

In particular, if open intervals (AD) , (BC) concur in a point E , no three of the points A, B, C, D colline.

Proof. Otherwise, by (the preceding lemma) L 1.2.9.12 two intervals would have in common a whole interval, which, by T 1.2.8, contains an infinite number of points. \square

Corollary 1.2.9.14. *Let $(B_1 D_1), (B_2 D_2), \dots, (B_n D_n)$ be a finite sequence of open intervals containing a point C and such that each of these open intervals $(B_j D_j)$ except the first has at least one of its ends not on any of the lines $a_{B_i D_i}$, $1 \leq i < j$ formed by the ends of the preceding (in the sequence) open intervals. Then no end of any of these open intervals can lie on the line formed by the ends of another interval.*

In particular, if open intervals (AD) , (BC) meet in a point E and there are three points in the set $\{A, B, C, D\}$ known not to colline, no three of the points A, B, C, D colline.

Proof. Just combine L 1.2.9.9, L 1.2.9.13. \square

³⁰Again, we use in this proof the lemmas L 1.2.3.1, L 1.2.3.2, and the results following them (summarized in the footnote accompanying T 1.2.5) without referring to these results explicitly.

³¹To put it shortly, $\forall j \in \{2, 3, \dots, n\} B_j \notin a_{B_i D_i} \vee D_j \notin a_{B_i D_i}$, $1 \leq i < j$.

³²Naturally, we count only distinct points. Also, it is obvious that $1 < i < n$, because there is at least one interval containing $C = A_i$.



Figure 1.14: The point A lies on the ray O_A .

Open Sets and Fundamental Topological Properties

Given a line a , consider a set $\mathcal{A} \subset \mathcal{P}_a$ of points all lying on a . A point O is called an interior point of \mathcal{A} if there is an open interval (AB) containing this point and completely included in \mathcal{A} . That is, O is an interior point of a linear point set \mathcal{A} iff $\exists(AB)$ such that $O \in (AB) \subset \mathcal{A}$.

Given a plane α , consider a set $\mathcal{A} \subset \mathcal{P}_\alpha$ of points all lying on α . A point O is called an interior point of \mathcal{A} if on any line a lying in α and passing through O there is an open interval $(A^{(a)}B^{(a)})$ containing the point O and completely included in \mathcal{A} .

Finally, consider a set \mathcal{A} of points not constrained to lie on any particular plane. A point O is called an interior point of \mathcal{A} if on any line a passing through O there is an open interval $(A^{(a)}B^{(a)})$ containing the point O and completely included in \mathcal{A} .

The set of all interior points of a (linear, planar, or spatial) set \mathcal{A} is called the interior of that set, denoted $Int\mathcal{A}$. A (linear, planar, or spatial) set \mathcal{A} is referred to as open if it coincides with its interior, i.e. if $Int\mathcal{A} = \mathcal{A}$.

Obviously, the empty set and the set \mathcal{P}_a of all points of a given line a are open linear sets.

The empty set and the set \mathcal{P}_α of all points of a given plane α are open plane sets.

Finally, the empty set and the set of all points (of space) given are open (spatial) sets.

The following trivial lemma gives us the first non-trivial example of a linear open set.

Lemma 1.2.9.15. *Any open interval (AB) is an open (linear) set.*

Proof. \square

Now we can establish that our open sets are indeed open in the standard topological sense.

Lemma 1.2.9.16. *A union of any number of (linear, planar, spatial) open sets is an open set.*

Proof. (Linear case.) ³³ Suppose $P \in \bigcup_{i \in \mathcal{U}} \mathcal{A}_i$, where the sets $\mathcal{A}_i \subset \mathcal{P}_a$ are open for all $i \in \mathcal{U}$. Here \mathcal{U} is a set of indices. By definition of union $\exists i_0 \in \mathcal{U}$ such that $P \in \mathcal{A}_{i_0}$. By our definition of open set there are points A, B such that $P \in (AB) \subset \mathcal{A}_{i_0}$. Hence (using again the definition of union) $P \in (AB) \subset \bigcup_{i \in \mathcal{U}} \mathcal{A}_i$, which completes the proof. \square

Lemma 1.2.9.17. *An intersection of any finite number of (linear, planar, spatial) open sets is an open set.*

Proof. Suppose $P \in \bigcap_{i=1}^n \mathcal{B}_i$, where the sets $\mathcal{B}_i \subset \mathcal{P}_a$ are open for all $i = 1, 2, \dots, n$. By definition of intersection $\forall i \in \mathbb{N}_n$ we have $P \in \mathcal{B}_i$. Hence (from our definition of open set) $\forall i \in \mathbb{N}_n$ there are points $B_i, D_i \in \mathcal{B}_i$ such that $P \in (B_i D_i) \subset \mathcal{B}_i$. Then by L 1.2.9.12 there is an open interval (BD) containing the point P and included in all open intervals (B_i, D_i) , $i \in \mathbb{N}_n$. Hence (using again the definition of intersection) $P \in (BD) \subset \bigcap_{i=1}^n \mathcal{B}_i$. \square

Theorem 1.2.9. *Given a line a , all open sets on that line form a topology on \mathcal{P}_a . Given a plane α , all open sets in that plane form a topology on \mathcal{P}_α . Finally, all (spatial) open sets form a topology on the set of all points (of space).*

Proof. Follows immediately from the two preceding lemmas (L 1.2.9.16, L 1.2.9.17). \square

Theorem 1.2.10. *Proof.* \square

Let O, A be two distinct points. Define the ray O_A , emanating from its initial point (which we shall call also the origin) O , as the set of points $O_A \doteq \{B | B \in a_{OA} \& B \neq O \& \neg[AOB]\}$. We shall denote the line a_{OA} , containing the ray $h = O_A$, by \bar{h} .

The initial point O of a ray h will also sometimes be denoted $O = \partial h$.

Basic Properties of Rays

Lemma 1.2.11.1. *Any point A lies on the ray O_A . (See Fig. 1.14)*

Proof. Follows immediately from A 1.2.1. \square

Note that L 1.2.11.1 shows that there are no empty rays.

³³We present here a proof for the case of linear open sets. For planar and spatial open sets the result is obtained by obvious modification of the arguments given for the linear case. Thus, in the planar case we apply these arguments on every line drawn through a given point and constrained to lie in the appropriate plane. Similarly, in the spatial case our argumentation concerns all lines in space that go through a chosen point.



Figure 1.15: If B lies on O_A , A lies on O_B .



Figure 1.16: B lies on the opposite side of O from A iff O divides A and B .

Lemma 1.2.11.2. *If a point B lies on a ray O_A , the point A lies on the ray O_B , that is, $B \in O_A \Rightarrow A \in O_B$.*

Proof. (See Fig. 1.15) From A 1.2.1, C 1.1.1.2 $B \neq O \& B \in a_{O_A} \& \neg[AOB] \Rightarrow A \in a_{O_B} \& \neg[BOA]$. \square

Lemma 1.2.11.3. *If a point B lies on a ray O_A , then the ray O_A is equal to the ray O_B .*

Proof. Let $C \in O_A$. If $C = A$, then by L 1.2.11.2 $C \in O_B$. $C \neq O \neq A \& \neg[AOC] \xrightarrow{T1.2.2} [OAC] \vee [OCA]$. Hence $\neg[BOC]$, because from L 1.2.3.1, L 1.2.3.2 $[BOC] \& ([OAC] \vee [OCA]) \Rightarrow [BOA]$. \square

Lemma 1.2.11.4. *If rays O_A and O_B have common points, they are equal.*

Proof. $O_A \cap O_B \neq \emptyset \Rightarrow \exists C C \in O_A \& C \in O_B \xrightarrow{L1.2.11.3} O_A = O_C = O_B$. \square

If $B \in O_A$ ($B \in a_{O_A} \& B \notin O_A \& B \neq O$), we say that the point B lies on line a_{O_A} on the same side (on the opposite side) of the given point O as (from) the point A .

Lemma 1.2.11.5. *The relation "to lie on the given line a the same side of the given point $O \in a$ as" is an equivalence relation on $\mathcal{P}_a \setminus O$. That is, it possesses the properties of:*

- 1) *Reflexivity: A geometric object A always lies in the set the same side of the point O as itself;*
- 2) *Symmetry: If a point B lies on the same side of the point O as A , then the point A lies on the same side of O as B .*
- 3) *Transitivity: If a point B lies on the same side of the point O as the point A , and a point C lies on the same side of O as B , then C lies on the same side of O as A .*

Proof. 1) and 2) follow from L 1.2.11.1, L 1.2.11.2. Show 3): $B \in O_A \& C \in O_B \xrightarrow{L1.2.11.3} O_A = O_B = O_C \Rightarrow C \in O_A$. \square

Lemma 1.2.11.6. *A point B lies on the opposite side of O from A iff O divides A and B .*

Proof. (See Fig. 1.16) By definition of the ray O_A , $B \in a_{O_A} \& B \notin O_A \& B \neq O \Rightarrow [AOB]$.

Conversely, from L 1.2.1.3, A 1.2.1 $[AOB] \Rightarrow B \in a_{O_A} \& B \neq O \& B \notin O_A$. \square

Lemma 1.2.11.7. *The relation "to lie on the opposite side of the given point from" is symmetric.*

Proof. Follows from L 1.2.11.6 and $[AOB] \xrightarrow{A1.2.1} [BOA]$. \square

If a point B lies on the same side (on the opposite side) of the point O as (from) a point A , in view of symmetry of the relation we say that the points A and B lie on the same side (on opposite sides) of O .

Lemma 1.2.11.8. *If points A and B lie on one ray O_C , they lie on line a_{O_C} on the same side of the point O . If, in addition, $A \neq B$, then either A lies between O and B or B lies between O and A .*

Proof. (See Fig. 1.17) $A \in O_C \xrightarrow{L1.2.11.3} O_A = O_C$. $B \in O_A \Rightarrow B \in a_{O_A} \& B \neq O \& \neg[BOA]$. When also $B \neq A$, from T 1.2.2 $[OAB] \vee [OBA]$. \square

Lemma 1.2.11.9. *If a point C lies on the same side of the point O as a point A , and a point D lies on the opposite side of O from A , then the points C and D lie on the opposite sides of O .³⁴*

³⁴Making use of L 1.2.11.6, this statement can be reformulated as follows:

If a point C lies on the ray O_A , and the point O divides the points A and D , then O divides C and D .

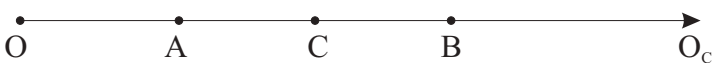

Figure 1.17: If A and B lie on O_C , they lie on a_{O_C} on the same side of O .



Figure 1.18: If C lies on O_A , and O divides A and D , then O divides C and D .



Figure 1.19: If C and D lie on the opposite side of O from A , then C and D lie on the same side of O .

Proof. (See Fig. 1.18) $C \in O_A \Rightarrow \neg[AOC] \& C \neq O$. If also $C \neq A$ ³⁵, from T 1.2.2 $[ACO]$ or $[CAO]$, whence by L 1.2.3.1, L 1.2.3.2 ($[ACO] \vee [CAO]$) & $[AOD] \Rightarrow [COD]$. \square

Lemma 1.2.11.10. *If points C and D lie on the opposite side of the point O from a point A ,³⁶ then C and D lie on the same side of O .*

Proof. (See Fig. 1.19) By A 1.2.1, L 1.1.1.7, and P 1.2.5.1 $[AOC] \& [AOD] \Rightarrow D \in a_{OC} \& O \neq C \& \neg[COD] \Rightarrow D \in O_C$. \square

Lemma 1.2.11.11. *Suppose a point C lies on a ray O_A , a point D lies on a ray O_B , and O lies between A and B . Then O also lies between C and D .*

Proof. (See Fig. 1.21) Observe that $D \in O_B \xrightarrow{L1.2.11.3} O_B = O_D$ and use L 1.2.11.9. \square

Lemma 1.2.11.12. *The point O divides the points A and B iff the rays O_A and O_B are disjoint, $O_A \cap O_B = \emptyset$, and their union, together with the point O , gives the set of points of the line a_{AB} , $\mathcal{P}_{a_{AB}} = O_A \cup O_B \cup \{O\}$. That is,*
 $[OAB] \Leftrightarrow (\mathcal{P}_{a_{AB}} = O_A \cup O_B \cup \{O\}) \& (O_A \cap O_B = \emptyset)$.

Proof. Suppose $[AOB]$. If $C \in \mathcal{P}_{a_{AB}}$ and $C \notin O_B$, $C \neq O$ then $[COB]$ by the definition of the ray O_B . $[COB] \& [AOB] \& O \neq C \xrightarrow{P1.2.5.1} \neg[COA]$. $\Rightarrow C \in O_A$. $O_A \cap O_B = \emptyset$, because otherwise $C \in O_A \& C \in O_B \xrightarrow{L1.2.11.4} B \in O_A \Rightarrow \neg[AOB]$.

Now suppose $(\mathcal{P}_{a_{AB}} = O_A \cup O_B \cup \{O\})$ and $(O_A \cap O_B = \emptyset)$. Then $O \in a_{AB} \& A \neq O \xrightarrow{C1.1.1.2} B \in a_{OA}$, $B \in O_B \& O_A \cap O_B = \emptyset \Rightarrow B \notin O_A$, and $B \neq O \& B \in a_{OA} \& B \notin O_A \Rightarrow [AOB]$. \square

Lemma 1.2.11.13. *A ray O_A contains the open interval (OA) .*

Proof. If $B \in (OA)$ then from A 1.2.1 $B \neq O$, from L 1.2.1.3 $B \in a_{OA}$, and from A 1.2.3 $\neg[BOA]$. We thus have $B \in O_A$. \square

Lemma 1.2.11.14. *For any finite set of points $\{A_1, A_2, \dots, A_n\}$ of a ray O_A there is a point C on O_A not in that set.*

Proof. Immediately follows from T 1.2.8 and L 1.2.11.13. \square

Lemma 1.2.11.15. *If a point B lies between points O and A then the rays O_B and O_A are equal.*

Proof. $[OBA] \xrightarrow{L1.2.11.13} B \in O_A \xrightarrow{L1.2.11.3} O_B = O_A$. \square

Lemma 1.2.11.16. *If a point A lies between points O and B , the point B lies on the ray O_A .*

Proof. By L 1.2.1.3, A 1.2.1, A 1.2.3 $[OAB] \Rightarrow B \in a_{OA} \& B \neq O \& \neg[BOA] \Rightarrow B \in O_A$.

Alternatively, this lemma can be obtained as an immediate consequence of the preceding one (L 1.2.11.15). \square

Lemma 1.2.11.17. *If rays O_A and O'_B are equal, their initial points coincide.*

Proof. Suppose $O' \neq O$ (See Fig. 1.20.) We have also $O' \neq O \& O'_B = O_A \Rightarrow O' \notin O_A$. Therefore, $O' \in a_{OA} \& O' \neq O \& O' \notin O_A \Rightarrow O' \in O_A^c$. $O' \in O_A^c \& B \in O_A \Rightarrow [O'OB]$. $B \in O'_B \& [O'OB] \xrightarrow{L1.2.11.13} O \in O'_B = O_A$ - a contradiction. \square

³⁵Otherwise there is nothing else to prove

³⁶One could as well have said: If O lies between A and C , as well as between A and D ...



Figure 1.20: If O_A and O'_B are equal, their origins coincide.

Lemma 1.2.11.18. *If an interval A_0A_n is divided into n intervals $A_0A_1, A_1A_2, \dots, A_{n-1}A_n$ (by the points A_1, A_2, \dots, A_{n-1}),³⁷ the points $A_1, A_2, \dots, A_{n-1}, A_n$ all lie³⁸ on the same side of the point A_0 , and the rays $A_0A_1, A_0A_2, \dots, A_0A_n$ are equal.³⁹*

Proof. Follows from L 1.2.7.3, L 1.2.11.15. \square

Lemma 1.2.11.19. *Every ray contains an infinite number of points.*

Proof. Follows immediately from T 1.2.8, L 1.2.11.13. \square

This lemma implies, in particular, that

Lemma 1.2.11.20. *There is exactly one line containing a given ray.*

Proof. \square

The line, containing a given ray O_A is, of course, the line a_{OA} .

Theorem 1.2.11. *A point O on a line a separates the rest of the points of this line into two non-empty classes (rays) in such a way that...*

Linear Ordering on Rays

Let A, B be two points on a ray O_D . Let, by definition, $(A \prec B)_{O_D} \stackrel{\text{def}}{\iff} [OAB]$. If $(A \prec B)$,⁴⁰ we say that the point A precedes the point B on the ray O_D , or that the point B succeeds the point A on the ray O_D .

Obviously, $A \prec B$ implies $A \neq B$. Conversely, $A \neq B$ implies $\neg(A \prec B)$.

Lemma 1.2.12.1. *If a point A precedes a point B on the ray O_D , and B precedes a point C on the same ray, then A precedes C on O_D :*

$A \prec B \& B \prec C \Rightarrow A \prec C$, where $A, B, C \in O_D$.

Proof. (See Fig. 1.22) $[OAB] \& [OBC] \stackrel{\text{L1.2.3.2}}{\implies} [OAC]$. \square

Lemma 1.2.12.2. *If A, B are two distinct points on the ray O_D then either A precedes B or B precedes A ; if A precedes B then B does not precede A .*

Proof. $A \in O_D \& B \in O_D \stackrel{\text{L1.2.11.8}}{\implies} B \in O_A \Rightarrow \neg[AOB]$. If $A \neq B$, then by T 1.2.2 $[OAB] \vee [OBA]$, that is, $A \prec B$ or $B \prec A$. $A \prec B \Rightarrow [OAB] \stackrel{\text{A1.2.3}}{\implies} \neg[OBA] \Rightarrow \neg(B \prec A)$. \square

Lemma 1.2.12.3. *If a point B lies on a ray O_P between points A and C ,⁴¹ then either A precedes B and B precedes C , or C precedes B and B precedes A ; conversely, if A precedes B and B precedes C , or C precedes B and B precedes A , then B lies between A and C . That is,*

$[ABC] \Leftrightarrow (A \prec B \& B \prec C) \vee (C \prec B \& B \prec A)$.

Proof. From the preceding lemma (L 1.2.12.2) we know that either $A \prec C$ or $C \prec A$, i.e. $[OAC]$ or $[OCA]$. Suppose $[OAC]$.⁴² Then $[OAC] \& [ABC] \stackrel{\text{L1.2.3.2}}{\implies} [OAB] \& [OBC] \Rightarrow A \prec B \& B \prec C$. Conversely, $A \prec B \& B \prec C \Rightarrow [OAB] \& [OBC] \stackrel{\text{L1.2.3.2}}{\implies} [ABC]$. \square

For points A, B on a ray O_D we let by definition $A \preceq B \stackrel{\text{def}}{\iff} (A \prec B) \vee (A = B)$.

Theorem 1.2.12. *Every ray is a chain with respect to the relation \preceq .*

Proof. $A \preceq A$. $(A \preceq B) \& (B \preceq A) \stackrel{\text{L1.2.12.2}}{\implies} A = B$; $(A \prec B) \& (B \prec A) \stackrel{\text{L1.2.12.1}}{\implies} A \prec C$; $A \neq B \stackrel{\text{L1.2.12.2}}{\implies} (A \prec B) \vee (B \prec A)$. \square

³⁷In other words, a finite sequence of points A_i , where $i + 1 \in \mathbb{N}_{n-1}$, $n \geq 4$, has the property that every point of the sequence, except for the first and the last, lies between the two points with adjacent (in \mathbb{N}) numbers.

³⁸Say, on $a_{A_0A_1}$. Observe also that L 1.2.7.2 implies that, given the conditions of this lemma, all lines $a_{A_iA_j}$, where $i + 1, j + 1 \in \mathbb{N}_n$, $i \neq j$, are equal, so we can put any of these $a_{A_iA_j}$ in place of $a_{A_0A_1}$.

³⁹By the same token, we can assert also that the points $A_0, A_1 \dots A_{n-1}$ lie on the same side of the point A_n , but due to symmetry, this adds essentially nothing new to the statement of the lemma.

⁴⁰In most instances in what follows we will assume the ray O_D (or some other ray) fixed and omit the mention of it in our notation.

⁴¹In fact, once we require that $A, C \in O_P$ and $[ABC]$, this ensures that $B \in O_P$. (To establish this, we can combine $[OBC]$ shown below with, say, L 1.2.11.3, L 1.2.11.13.) This observation will be referred to in the footnote accompanying proof of T 1.2.14.

⁴²Since $[ABC]$ and $[CBA]$ are equivalent in view of A 1.2.1, we do not need to consider the case $[OCA]$ separately.



Figure 1.21: If C lies on the ray O_A , D on O_B , and O between A and B , then O lies between C and D .



Figure 1.22: If A precedes B on O_D , and B precedes C on the same ray, then A precedes C on O_D .

Ordering on Lines

Let $O \in a$, $P \in a$, $[POQ]$. Define the direct (inverse) ordering on the line a , that is, a relation of ordering on the set \mathcal{P}_a of all points of the line a , as follows:

Call O_P the first ray, and O_Q the second ray.⁴³ A point A precedes a point B on the line a in the direct (inverse) order iff: (See Fig. 1.23)

- Both A and B lie on the first (second) ray and B precedes A on it; or
- A lies on the first (second) ray, and B lies on the second (first) ray or coincides with O ; or
- $A = O$ and B lies on the second (first) ray; or
- Both A and B lie on the second (first) ray, and A precedes B on it.

Thus, a formal definition of the direct ordering on the line a can be written down as follows:

$$(A \prec_1 B)_a \stackrel{\text{def}}{\iff} (A \in O_P \& B \in O_P \& B \prec A) \vee (A \in O_P \& B = O) \vee (A \in O_P \& B \in O_Q) \vee (A = O \& B \in O_Q) \vee (A \in O_Q \& B \in O_Q \& A \prec B),$$

$$\text{and for the inverse ordering: } (A \prec_2 B)_a \stackrel{\text{def}}{\iff} (A \in O_Q \& B \in O_Q \& B \prec A) \vee (A \in O_Q \& B = O) \vee (A \in O_Q \& B \in O_P) \vee (A = O \& B \in O_P) \vee (A \in O_P \& B \in O_P \& A \prec B).$$

The term "inverse order" is justified by the following trivial

Lemma 1.2.13.1. *A precedes B in the inverse order iff B precedes A in the direct order.*

Proof. \square

Obviously, for any order on any line $A \prec B$ implies $A \neq B$. Conversely, $A = B$ implies $\neg(A \prec B)$.

For our notions of order (both direct and inverse) on the line to be well defined, they have to be independent, at least to some extent, on the choice of the initial point O , as well as on the choice of the ray-defining points P and Q .

Toward this end, let $O' \in a$, $P' \in a$, $[P'O'Q']$, and define a new direct (inverse) ordering with displaced origin (ODO) on the line a , as follows:

Call O' the displaced origin, $O'_{P'}$ and $O'_{Q'}$ the first and the second displaced rays, respectively. A point A precedes a point B on the line a in the direct (inverse) ODO iff:

- Both A and B lie on the first (second) displaced ray, and B precedes A on it; or
- A lies on the first (second) displaced ray, and B lies on the second (first) displaced ray or coincides with O' ; or
- $A = O'$ and B lies on the second (first) displaced ray; or
- Both A and B lie on the second (first) displaced ray, and A precedes B on it.

⁴³Observe that if $A \in O_P$ and $B \in O_Q$ then $[AOB]$ (see L 1.2.11.11). This fact will be used extensively throughout this section.

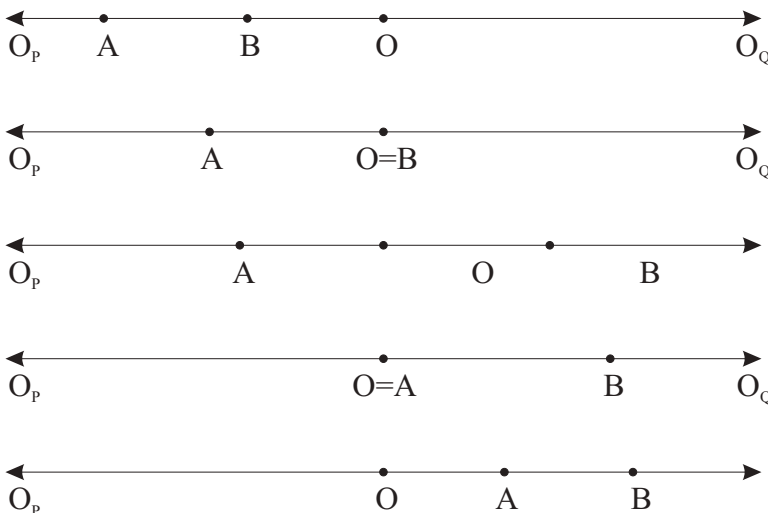

Figure 1.23: To the definition of order on a line.

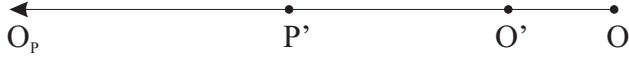

Figure 1.24: If O' lies on O_P between O and P' , then $O'_{P'} \subset O_P$.

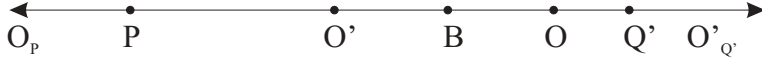

Figure 1.25: If O' lies on O_P , O lies on $O'_{Q'}$, and B lies on both O_P and $O'_{Q'}$, then B also divides O and O' .

Thus, a formal definition of the direct ODO on the line a can be written down as follows:

$$(A \prec'_1 B)_a \stackrel{\text{def}}{\iff} (A \in O'_{P'} \& B \in O'_{P'} \& B \prec A) \vee (A \in O'_{P'} \& B = O') \vee (A \in O'_{P'} \& B \in O'_{Q'}) \vee (A = O' \& B \in O'_{Q'}) \vee (A \in O'_{Q'} \& B \in O'_{Q'} \& A \prec B),$$

$$\text{and for the inverse ordering: } (A \prec'_2 B)_a \stackrel{\text{def}}{\iff} (A \in O'_{Q'} \& B \in O'_{Q'} \& B \prec A) \vee (A \in O'_{Q'} \& B = O') \vee (A \in O'_{Q'} \& B \in O'_{P'}) \vee (A = O' \& B \in O'_{P'}) \vee (A \in O'_{P'} \& B \in O'_{P'} \& A \prec B).$$

Lemma 1.2.13.2. *If the displaced ray origin O' lies on the ray O_P and between O and P' , then the ray O_P contains the ray $O'_{P'}$, $O'_{P'} \subset O_P$.*

*In particular,*⁴⁴ *if a point O' lies between points O , P , the ray O_P contains the ray $O'_{P'}$.*

Proof. (See Fig. 1.24) $O' \in O_P \Rightarrow O' \in a_{O_P}$, $[OO'P] \stackrel{\text{L1.2.1.3}}{\implies} O \in a_{O'_{P'}}$, and therefore $O \in a_{O_P} \& O \in a_{O'_{P'}}$ & $O' \in a_{O_P} \& O' \in a_{O'_{P'}}$ $\stackrel{\text{A1.1.2}}{\implies} a_{O_P} = a_{O'_{P'}}$. $A \in O'_{P'} \Rightarrow A \in O_P$, because otherwise $A \in a_{O_P} \& A \neq O \& A \notin O_P \& O' \in O_P \stackrel{\text{L1.2.11.9}}{\implies} [AOO']$ and $[AOO'] \& [OO'P'] \stackrel{\text{L1.2.3.1}}{\implies} [AO'P'] \Rightarrow A \notin O'_{P'}$. \square

Lemma 1.2.13.3. *Let the displaced origin O' be chosen in such a way that O' lies on the ray O_P , and the point O lies on the ray $O'_{Q'}$. If a point B lies on both rays O_P and $O'_{Q'}$, then it divides O and O' .*

Proof. (See Fig. 1.25) $O' \in O_P \& B \in O_P \& O \in O'_{Q'} \& B \in O'_{Q'} \stackrel{\text{L1.2.11.8}}{\implies} \neg[O'OB] \& \neg[OO'B]$, whence by T 1.2.2 $\Rightarrow [OBO']$. \square

Lemma 1.2.13.4. *An ordering with the displaced origin O' on a line a coincides with either direct or inverse ordering on that line (depending on the choice of the displaced rays). In other words, either for all points A, B on a A precedes B in the ODO iff A precedes B in the direct order; or for all points A, B on a A precedes B in the ODO iff A precedes B in the inverse order.*

Proof. Let $O' \in O_P$, $O \in O'_{Q'}$, $(A \prec'_1 B)_a$. Then $[P'O'Q'] \& O \in O'_{Q'} \stackrel{\text{L1.2.11.9}}{\implies} [OO'P']$ and $O' \in O_P \& [OO'P'] \stackrel{\text{L1.2.13.2}}{\implies} O'_{P'} \subset O_P$.

Suppose $A \in O'_{P'}$, $B \in O'_{P'}$. $A \in O'_{P'} \& B \in O'_{P'} \& O'_{P'} \subset O_P \Rightarrow A \in O_P \& B \in O_P$. $A \in O'_{P'} \& B \in O'_{P'} \& (A \prec'_1 B)_a \Rightarrow (B \prec A)_{O'_{P'}} \Rightarrow [O'BA]$. $B \in O'_{P'} \& O \in O'_{Q'} \stackrel{\text{L1.2.11.11}}{\implies} [OO'B]$, $[OO'B] \& [O'BA] \stackrel{\text{L1.2.3.1}}{\implies} (B \prec A)_{O_P} \Rightarrow (A \prec_1 B)_a$.

Suppose $A \in O'_{P'} \& B = O'$. $A \in O'_{P'} \& B = O' \& O \in O'_{Q'} \stackrel{\text{L1.2.11.11}}{\implies} [OBA] \Rightarrow (A \prec_1 B)_a$.

Suppose $A \in O'_{P'}$, $B \in O'_{Q'}$. $A \in O_P \& (B = O \vee B \in O_Q) \Rightarrow (A \prec_1 B)_a$. If $B \in O_P$ then $O' \in O_P \& O \in O'_{Q'} \& B \in O_P \& B \in O'_{Q'} \stackrel{\text{L1.2.13.3}}{\implies} [O'BO]$ and $[AO'B] \& [O'BO] \stackrel{\text{L1.2.3.1}}{\implies} [ABO] \Rightarrow (A \prec_1 B)_a$.⁴⁵

Suppose $A, B \in O'_{Q'}$. $(A \prec'_1 B)_a \Rightarrow (A \prec B)_{O'_{Q'}} \Rightarrow [O'AB]$. If $A \in O_P$ and $B \in O_P$ then by L 1.2.13.3 $[O'BO]$ and $[O'BO] \& [O'AB] \stackrel{\text{L1.2.3.2}}{\implies} [ABO] \Rightarrow (A \prec_1 B)_a$. $(A \in O_P \& B = O) \vee (A \in O_P \& B \in O_Q) \vee (A = O \& B \in O_Q) \Rightarrow (A \prec_1 B)_a$. Now let $A \in O_Q$, $B \in O_Q$. Then $\neg[AOB]$; $\neg[OBA]$, because $[OBA] \& [BAO'] \stackrel{\text{L1.2.3.1}}{\implies} [O'BO] \stackrel{\text{A1.2.3}}{\implies} \neg[B'OO'] \Rightarrow O' \in O_B$ and $B \in O_Q \& O' \in O_B \Rightarrow O' \in O_Q$. Finally, $\neg[AOB] \& \neg[OBA] \stackrel{\text{T1.2.2}}{\implies} [OAB] \Rightarrow (A \prec_1 B)_a$. \square

Lemma 1.2.13.5. *Let A, B be two distinct points on a line a , on which some direct or inverse order is defined. Then either A precedes B in that order, or B precedes A , and if A precedes B , B does not precede A , and vice versa.*

Proof. \square

For points A, B on a line where some direct or inverse order is defined, we let $A \prec_i B \stackrel{\text{def}}{\iff} (A \prec_i B) \vee (A = B)$, where $i = 1$ for the direct order and $i = 2$ for the inverse order.

⁴⁴We obtain this result letting $P' = P$. Since $[OO'P] \stackrel{\text{L1.2.11.9}}{\implies} O' \in O_P$, the condition $O' \in O_P$ becomes redundant for this particular case

⁴⁵We take into account that $A \in O'_{P'} \& B \in O'_{Q'} \stackrel{\text{L1.2.11.11}}{\implies} [AO'B]$.

Lemma 1.2.13.6. *If a point A precedes a point B on a line a , and B precedes a point C on the same line, then A precedes C on a :*

$$A \prec B \& B \prec C \Rightarrow A \prec C, \text{ where } A, B, C \in a.$$

Proof. Follows from the definition of the precedence relation \prec and L 1.2.12.1. ⁴⁶ \square

Theorem 1.2.14. *Every line with a direct or inverse order is a chain with respect to the relation \preceq_i .*

Proof. See the preceding two lemmas (L 1.2.13.5, L 1.2.13.6.) \square

Theorem 1.2.14. *If a point B lies between points A and C , then in any ordering, defined on the line containing these points, either A precedes B and B precedes C , or C precedes B and B precedes A ; conversely, if in some order, defined on the line, containing points A, B, C , A precedes B and B precedes C , or C precedes B and B precedes A , then B lies between A and C . That is,*

$$[ABC] \Leftrightarrow (A \prec B \& B \prec C) \vee (C \prec B \& B \prec A).$$

Proof. Suppose $[ABC]$. ⁴⁷

For $A, B, C \in O_P$ and $A, B, C \in O_Q$ see L 1.2.12.3.

If $A, B \in O_P, C = O$ then $[ABO] \Rightarrow (B \prec A)_{O_P} \Rightarrow (A \prec B)_a$; also $B \prec C$ in this case from definition of order on line.

If $A, B \in O_P, C \in O_Q$ then $[ABC] \& [BOC] \xrightarrow{L1.2.3.2} [ABO] \Rightarrow (A \prec B)_a$ and $B \in O_P \& C \in O_Q \Rightarrow (B \prec C)_a$.

For $A \in O_P, B = O, C \in O_Q$ see definition of order on line.

For $A \in O_P, B, C \in O_Q$ we have $[AOB] \& [ABC] \xrightarrow{L1.2.3.2} [OBC] \Rightarrow B \prec C$.

If $A = O$ and $B, C \in O_Q$, we have $[OBC] \Rightarrow B \prec C$.

Conversely, suppose $A \prec B$ and $B \prec C$ in the given direct order on a . ⁴⁸

For $A, B, C \in O_P$ and $A, B, C \in O_Q$ see L 1.2.12.3.

If $A, B \in O_P, C = O$ then $(A \prec B)_a \Rightarrow (B \prec A)_{O_P} \Rightarrow [ABO]$.

If $A, B \in O_P, C \in O_Q$ then $[ABO] \& [BOC] \xrightarrow{L1.2.3.1} [ABC]$.

For $A \in O_P, B = O, C \in O_Q$ we immediately have $[ABC]$ from L 1.2.11.11.

For $A \in O_P, B, C \in O_Q$ we have $[AOB] \& [OBC] \xrightarrow{L1.2.3.1} [ABC]$.

If $A = O$ and $B, C \in O_Q$, we have $B \prec C \Rightarrow [OBC]$.

\square

Corollary 1.2.14.1. *Suppose that a finite sequence of points A_i , where $i \in \mathbb{N}_n, n \geq 4$, has the property that every point of the sequence, except for the first and the last, lies between the two points with adjacent (in \mathbb{N}) numbers, i.e. that the interval A_1A_n is divided into $n - 1$ intervals $A_1A_2, A_2A_3, \dots, A_{n-1}A_n$ (by the points A_2, A_3, \dots, A_{n-1}). Then in any order (direct or inverse), defined on the line containing these points, we have either $A_1 \prec A_2 \prec \dots \prec A_{n-1} \prec A_n$ or $A_n \prec A_{n-1} \prec \dots \prec A_2 \prec A_1$. Conversely, if either $A_1 \prec A_2 \prec \dots \prec A_{n-1} \prec A_n$ or $A_n \prec A_{n-1} \prec \dots \prec A_2 \prec A_1$, then the points A_1, A_2, \dots, A_n are in order $[A_1A_2 \dots A_n]$.*

Proof. Follows from the two preceding theorems (T 1.2.14, T 1.2.14). \square

The following simple corollary may come in handy, for example, in discussing properties of vectors on a line.

Corollary 1.2.14.2. *If points A, B both precede a point C (in some order, direct or inverse, defined on a line a), they lie on the same side of C .*

Proof. We know that $A \prec C \& B \prec C \Rightarrow A \neq C \& B \neq C$. Also, we have $\neg[ACB]$, for $[ACB]$ would imply that either $A \prec C \prec B$ or $B \prec C \prec A$, which contradicts either $B \prec C$ or $A \prec C$ by L 1.2.13.5. Thus, from the definition of C_A we see that $B \in C_A$, as required. \square

By definition, an ordered abstract ⁴⁹ interval is an ordered pair of points. A pair (A, B) will be denoted by \overrightarrow{AB} , where the first point of the pair A is called the beginning, or initial point, of \overrightarrow{AB} , and the second point of the pair B is called the end, or final point, of the ordered interval \overrightarrow{AB} . A pair (A, A) (i.e. (A, B) with $A = B$) will be referred to as a zero ordered abstract interval. A non-zero ordered abstract interval (A, B) , i.e. $(A, B), A \neq B$, will also be referred to as a proper ordered abstract interval, although in most cases we shall leave out the words "non-zero" and "proper" whenever this usage is perceived not likely to cause confusion.

⁴⁶The following trivial observations may be helpful in limiting the number of cases one has to consider: As before, denote O_P, O_Q respectively, the first and the second ray for the given direct order on a . If a point $A \in \{O\} \cup O_Q$ precedes a point $B \in a$, then $B \in O_Q$. If a point A precedes a point $B \in O_P \cup \{O\}$, then $A \in O_P$.

⁴⁷Again, we denote O_P, O_Q respectively, the first and the second ray for the given order on a . The following trivial observations help limit the number of cases we have to consider: If $A \in O_P$ and $C \in O_P \cup \{O\}$ then $[ABC]$ implies $B \in O_P$. Similarly, if $A \in \{O\} \cup O_Q$ and $C \in O_Q$ then $[ABC]$ implies $B \in O_Q$. In fact, in the case $A \in O_P, C = O$ this can be seen immediately using, say, L 1.2.11.3. For $A, C \in O_P$ we conclude that $B \in O_P$ once $[ABC]$ immediately from L 1.2.16.4, which, of course, does not use the present lemma or any results following from it. Alternatively, this can be shown using proof of L 1.2.12.3 - see footnote accompanying that lemma.

⁴⁸Taking into account the following two facts lowers the number of cases to consider (cf. proof of L 1.2.13.6): If a point $A \in \{O\} \cup O_Q$ precedes a point $B \in a$, then $B \in O_Q$. If a point A precedes a point $B \in O_P \cup \{O\}$, then $A \in O_P$.

⁴⁹Again, for brevity we shall usually leave out the word "abstract" whenever there is no danger of confusion.



Figure 1.26: (OA) is the intersection of rays O_A and A_O , i.e. $(OA) = O_A \cap A_O$.



Figure 1.27: O_A^c is complementary to O_A

The concept of a non-zero ordered abstract interval is intimately related to the concept of line order. For the remainder of this subsection we shall usually assumed that one of the two possible orders (precedence relations) on a is chosen and fixed on some given (in advance) line a . A non-zero ordered (abstract) interval \overrightarrow{AB} lying on a (i.e. such that $A \in a, B \in a$) is said to have positive direction (with respect to the given order on a) iff A precedes B on a . Similarly, a non-zero ordered interval \overrightarrow{AB} lying on a is said to have negative direction (with respect to the given order on a) iff B precedes A on a .

A non-zero (abstract) ordered interval \overrightarrow{AB} is said to have the same direction as a non-zero ordered interval \overrightarrow{CD} (lying on the same line a) iff either both \overrightarrow{AB} and \overrightarrow{CD} have positive direction on a or both \overrightarrow{AB} and \overrightarrow{CD} have negative direction on a . If either \overrightarrow{AB} has positive direction on a and \overrightarrow{CD} negative direction, or \overrightarrow{AB} has negative direction on a and \overrightarrow{CD} positive direction, we say that the ordered intervals $\overrightarrow{AB}, \overrightarrow{CD}$ have opposite directions (on a).

Obviously, the relation "to have the same direction as", defined on the class of all non-zero ordered intervals lying on a given line a , is an equivalence.

Consider a collinear set of points \mathcal{A} , i.e. a set $\mathcal{A} \subset \mathcal{P}_a$ of points lying on some line a . We further assume that one of the two possible orders (precedence relations) on a is chosen. A transformation $f : \mathcal{A} \rightarrow \mathcal{A}$ is called sense-preserving if for any points $A, B \in \mathcal{A}$ the precedence $A \prec B$ implies $f(A) \prec f(B)$. A transformation $f : \mathcal{A} \rightarrow \mathcal{A}$ is called sense-reversing if for any points $A, B \in \mathcal{A}$ the precedence $A \prec B$ implies $f(B) \prec f(A)$. In other words, the sense-preserving transformations transform non-zero (abstract) ordered intervals into ordered intervals with the same direction, and the sense-reversing transformations transform non-zero (abstract) ordered intervals into ordered intervals with the opposite direction.

Obviously, as we have noted above in different terms, the composition of any two sense-preserving transformations of a line set \mathcal{A} is a sense-preserving transformation, as is the composition of any two sense-reversing transformations. On the other hand, for line sets the composition of a sense-preserving transformation and a sense-reversing transformation, taken in any order, is a sense-reversing transformation.

Complementary Rays

Lemma 1.2.15.1. *An interval (OA) is the intersection of the rays O_A and A_O , i.e. $(OA) = O_A \cap A_O$.*

Proof. (See Fig. 1.26) $B \in (OA) \Rightarrow [OBA]$, whence by L 1.2.1.3, A 1.2.1, A 1.2.3 $B \in a_{O_A} = a_{A_O}, B \neq O, B \neq A, \neg[B OA]$, and $\neg[B AO]$, which means $B \in O_A$ and $B \in A_O$.

Suppose now $B \in O_A \cap A_O$. Hence $B \in a_{O_A}, B \neq O, \neg[B OA]$ and $B \in a_{A_O}, B \neq A, \neg[B AO]$. Since O, A, B are collinear and distinct, by T 1.2.2 $[B OA] \vee [B AO] \vee [OBA]$. But since $\neg[B OA], \neg[B AO]$, we find that $[OBA]$. \square

Given a ray O_A , define the ray O_A^c , complementary to the ray O_A , as $O_A^c \doteq \mathcal{P}_{a_{O_A}} \setminus (\{O\} \cup O_A)$. In other words, the ray O_A^c , complementary to the ray O_A , is the set of all points lying on the line a_{O_A} on the opposite side of the point O from the point A . (See Fig. 1.27) An equivalent definition is provided by

Lemma 1.2.15.2. $O_A^c = \{B|[BOA]\}$. We can also write $O_A^c = O_D$ for any D such that $[DOA]$.

Proof. See L 1.2.11.6, L 1.2.11.3. \square

Lemma 1.2.15.3. *The ray $(O_A^c)^c$, complementary to the ray O_A^c , complementary to the given ray O_A , coincides with the ray O_A : $(O_A^c)^c = O_A$.*

Proof. $\mathcal{P}_{a_{O_A}} \setminus (\{O\} \cup (\mathcal{P}_{a_{O_A}} \setminus (\{O\} \cup O_A))) = O_A$ \square

Lemma 1.2.15.4. *Given a point C on a ray O_A , the ray O_A is a disjoint union of the half - open interval $(OC]$ and the ray C_O^c , complementary to the ray C_O :*

$$O_A = (OC] \cup C_O^c.$$

Proof. By L 1.2.11.3 $O_C = O_A$. Suppose $M \in O_C \cup C_O^c$. By A 1.2.3, L 1.2.1.3, A 1.2.1 $[OMC] \vee M = C \vee [OCM] \Rightarrow \neg[MOC] \& M \neq O \& M \in a_{O_C} \Rightarrow M \in O_A = O_C$.

Conversely, if $M \in O_A = O_C$ and $M \neq C$ then $M \in a_{O_C} \& M \neq C \& M \neq O \& \neg[MOC] \xrightarrow{T1.2.2} [OMC] \vee [OCM] \Rightarrow M \in (OC] \vee M \in C_O^c$. \square



Figure 1.28: A_{1A_n} is a disjoint union of $(A_i A_{i+1}]$, $i = 1, 2, \dots, n-1$, with $A_{nA_k}^c$.

Lemma 1.2.15.5. *Given on a line a_{OA} a point B , distinct from O , the point B lies either on O_A or on O_A^c .*

Theorem 1.2.15. *Let a finite sequence of points A_1, A_2, \dots, A_n , $n \in \mathbb{N}$, be numbered in such a way that, except for the first and (in the finite case) the last, every point lies between the two points with adjacent (in \mathbb{N}) numbers. (See Fig. 1.12) Then the ray A_{1A_n} is a disjoint union of half-closed intervals $(A_i A_{i+1}]$, $i = 1, 2, \dots, n-1$, with the ray $A_{nA_k}^c$, complementary to the ray A_{nA_k} , where $k \in \{1, 2, \dots, n-1\}$, i.e.*

$$A_{1A_n} = \bigcup_{i=1}^{n-1} (A_i A_{i+1}] \cup A_{nA_k}^c.$$

Proof. (See Fig. 1.28) Observe that $[A_1 A_k A_n] \xrightarrow{\text{L1.2.15.5}} A_{nA_k} = A_{nA_1}$, then use L 1.2.7.7, L 1.2.15.4. \square

Point Sets on Rays

Given a point O on a line a , a nonempty point set $\mathcal{B} \subset \mathcal{P}_a$ is said to lie on line a on the same side (on the opposite side) of the point O as (from) a nonempty set $\mathcal{A} \subset \mathcal{P}_a$ iff for all $A \in \mathcal{A}$ and all $B \in \mathcal{B}$ the point B lies on the same side (on the opposite side) of the point O as (from) the point $A \in \mathcal{A}$. If the set \mathcal{A} (the set \mathcal{B}) consists of a single element, we say that the set \mathcal{B} (the point B) lies on line a on the same side of the point O as the point A (the set \mathcal{A}).

Lemma 1.2.16.1. *If a set $\mathcal{B} \subset \mathcal{P}_a$ lies on line a on the same side of the point O as a set $\mathcal{A} \subset \mathcal{P}_a$, then the set \mathcal{A} lies on line a on the same side of the point O as the set \mathcal{B} .*

Proof. See L 1.2.11.5. \square

Lemma 1.2.16.2. *If a set $\mathcal{B} \subset \mathcal{P}_a$ lies on line a on the same side of the point O as a set $\mathcal{A} \subset \mathcal{P}_a$, and a set $\mathcal{C} \subset \mathcal{P}_a$ lies on line a on the same side of the point O as the set \mathcal{B} , then the set \mathcal{C} lies on line a on the same side of the point O as the set \mathcal{A} .*

Proof. See L 1.2.11.5. \square

Lemma 1.2.16.3. *If a set $\mathcal{B} \subset \mathcal{P}_a$ lies on line a on the opposite side of the point O from a set $\mathcal{A} \subset \mathcal{P}_a$, then the set \mathcal{A} lies on line a on the opposite side of the point O from the set \mathcal{B} .*

Proof. See L 1.2.11.6. \square

In view of symmetry of the relations, established by the lemmas above, if a set $\mathcal{B} \subset \mathcal{P}_a$ lies on line a on the same side (on the opposite side) of the point O as a set (from a set) $\mathcal{A} \subset \mathcal{P}_a$, we say that the sets \mathcal{A} and \mathcal{B} lie on line a on one side (on opposite sides) of the point O .

Lemma 1.2.16.4. *If two distinct points A, B lie on a ray O_C , the open interval (AB) also lies on the ray O_C .*

Proof. By L 1.2.11.8 $[OAB] \vee [OBA]$, whence by T 1.2.15 $(AB) \subset O_A = O_C$. \square

Given an interval AB on a line a_{OC} such that the open interval (AB) does not contain O , we have (L 1.2.16.5 - L 1.2.16.7):

Lemma 1.2.16.5. *If one of the ends of (AB) is on the ray O_C , the other end is either on O_C or coincides with O .*

Proof. Let, say, $B \in O_C$. By L 1.2.11.3 $O_B = O_C$. Assuming the contrary to the statement of the lemma, we have $A \in O_B^c \Rightarrow [AOB] \Rightarrow O \in (AB)$, which contradicts the hypothesis. \square

Lemma 1.2.16.6. *If (AB) has common points with the ray O_C , either both ends of (AB) lie on O_C , or one of them coincides with O .*

Proof. By hypothesis $\exists M M \in (AB) \cap O_C$. $M \in O_C \xrightarrow{\text{L1.2.11.3}} O_M = O_C$. Assume the contrary to the statement of the lemma and let, say, $A \in O_M^c$. Then $[AOM] \& [AMB] \xrightarrow{\text{L1.2.3.2}} [AOB] \Rightarrow O \in (AB)$ - a contradiction. \square

Lemma 1.2.16.7. *If (AB) has common points with the ray O_C , the interval (AB) lies on O_C , $(AB) \subset O_C$.*

Proof. Use L 1.2.16.6 and L 1.2.15.4 or L 1.2.16.4. \square

Lemma 1.2.16.8. *If A and B lie on one ray O_C , the complementary rays A_O^c and B_O^c lie on line a_{OC} on one side of the point O .*

Lemma 1.2.16.9. *If an open interval (CD) is included in an open interval (AB) , neither of the ends of (AB) lies on (CD) .*

Proof. $A \notin (CD)$, $B \notin (CD)$, for otherwise $(A \in (CD) \vee B \in (CD)) \& (CD) \subset (AB) \Rightarrow A \in (AB) \vee B \in (AB)$, which is absurd as it contradicts A 1.2.1. \square

Lemma 1.2.16.10. *If an open interval (CD) is included in an open interval (AB) , the closed interval $[CD]$ is included in the closed interval $[AB]$.⁵⁰*

Proof. By T 1.2.1 $\exists E [CED]$. $E \in (CD) \& (CD) \subset (AB) \stackrel{L1.2.15.1}{\Rightarrow} E \in (CD) \cap (A_B \cap B_A)$. $A \notin (CD) \& B \notin (CD) \& E \in A_B \cap (CD) \& E \in B_A \cap (CD) \stackrel{L1.2.16.6}{\Rightarrow} C \in A_B \cup \{A\} \& C \in B_A \cup \{B\} \& D \in A_B \cup \{A\} \& D \in B_A \cup \{B\} \Rightarrow C \in (A_B \cap B_A) \cup \{A\} \cup \{B\} \& D \in (A_B \cap B_A) \cup \{A\} \cup \{B\} \stackrel{L1.2.15.1}{\Rightarrow} C \in [AB] \& D \in [AB]$. \square

Corollary 1.2.16.11. *For intervals AB , CD both inclusions $(AB) \subset (CD)$, $(CD) \subset (AB)$ (i.e., the equality $(AB) = (CD)$) holds iff the (abstract) intervals AB , CD are identical.*

Proof. #1. $(CD) \subset (AB) \stackrel{L1.2.16.10}{\Rightarrow} [CD] \subset [AB] \Rightarrow C \in [AB] \& D \in [AB]$. On the other hand, $(AB) \subset (CD) \stackrel{L1.2.16.9}{\Rightarrow} C \notin (AB) \& D \notin (AB)$.

#2. $(AB) \subset (CD) \& (CD) \subset (AB) \stackrel{L1.2.16.10}{\Rightarrow} [AB] \subset [CD] \& [CD] \subset [AB]$. $(AB) = (CD) \& [AB] = [CD] \Rightarrow \{A, B\} = [AB] \setminus (AB) = [CD] \setminus (CD) = \{C, D\}$. \square

Lemma 1.2.16.12. *Both ends of an interval CD lie on a closed interval $[AB]$ iff the open interval (CD) is included in the open interval (AB) .*

Proof. Follows immediately from L 1.2.3.5, L 1.2.16.10. \square

We can put some of the results above (as well as some of the results we encounter in their particular cases below) into a broader context as follows.

A point set \mathcal{A} is called convex if $A \in \mathcal{A} \& B \in \mathcal{A}$ implies $(AB) \subset \mathcal{A}$ for all points $A, B \in \mathcal{A}$.

Theorem 1.2.16. *Consider a ray O_A , a point $B \in O_A$, and a convex set \mathcal{A} of points of the line a_{O_A} . If $B \in \mathcal{A}$ but $O \notin \mathcal{A}$ then $\mathcal{A} \subset O_A$.⁵¹*

Proof. Suppose that there exists $C \in O_A^c \cap \mathcal{A}$. Then $O \in \mathcal{A}$ in view of convexity, contrary to hypothesis. Since $\mathcal{A} \subset \mathcal{P}_a$ and $O_A^c \cap \mathcal{A} = \emptyset$, $O \notin \mathcal{A}$, we conclude that $\mathcal{A} \subset O_A$. \square

Basic Properties of Half-Planes

We say that a point B lies in a plane α on the same side (on the opposite (other) side) of a line a as the point A (from the point A) iff:

- Both A and B lie in plane α ;
 - a lies in plane α and does not contain A, B ;
 - a meets (does not meet) the interval AB ;
- and write this as $(ABa)_\alpha \Leftrightarrow ((AaB)_\alpha)$.

Thus, we let, by definition

$(ABa)_\alpha \stackrel{\text{def}}{\Leftrightarrow} A \notin a \& B \notin a \& \neg \exists C (C \in a \& [ACB]) \& A \in \alpha \& B \in \alpha$; and

$(AaB)_\alpha \stackrel{\text{def}}{\Leftrightarrow} A \notin a \& B \notin a \& \exists C (C \in a \& [ACB]) \& A \in \alpha \& B \in \alpha$.

Lemma 1.2.17.1. *The relation "to lie in plane α on the same side of a line a as", i.e. the relation $\rho \subset \mathcal{P}_\alpha \setminus \mathcal{P}_a \times \mathcal{P}_\alpha \setminus \mathcal{P}_a$ defined by $(A, B) \in \rho \stackrel{\text{def}}{\Leftrightarrow} ABa$, is an equivalence on $\mathcal{P}_\alpha \setminus \mathcal{P}_a$.*

Proof. By A 1.2.1 AAa and $ABa \Rightarrow BAa$. To prove $ABa \& BCa \Rightarrow ACa$ assume the contrary, i.e. that ABa , BCa and AaC . Obviously, AaC implies that $\exists D D \in a \& [ADC]$. Consider two cases:

If $\exists b (A \in b \& B \in b \& C \in b)$, by T 1.2.2 $[ABC] \vee [BAC] \vee [ACB]$. But $[ABC] \& [ADC] \& D \neq B \stackrel{T1.2.5}{\Rightarrow} [ADB] \vee [BDC]$, $[BAC] \& [ADC] \stackrel{L1.2.3.2}{\Rightarrow} [BDC]$, $[ACB] \& [ADC] \stackrel{L1.2.3.2}{\Rightarrow} [ADB]$, which contradicts $ABa \& BCa$.

If $\neg \exists b (A \in b \& B \in b \& C \in b)$ (see Fig. 1.29), then $A \notin a \& B \notin a \& C \notin a \& a \subset \alpha = \alpha_{ABC} \& \exists D (D \in a \& [ADC]) \stackrel{A1.2.4}{\Rightarrow} \exists E (E \in a \& [AEB]) \vee \exists F (F \in a \& [BFC])$, which contradicts $ABa \& BCa$.

\square

A half-plane $(a_A)_\alpha$ is, by definition, the set of points lying in plane α on the same side of the line a as the point B , i.e. $a_A \Rightarrow \{B | ABa\}$.⁵² The line a is called the edge of the half-plane a_A . The edge a of a half-plane χ will also sometimes be denoted by $\partial\chi$.

⁵⁰In particular, if an open interval (CD) is included in the open interval (AB) , the points C, D both lie on the segment $[AB]$.

⁵¹Alternatively, this theorem can be formulated as follows: Consider a ray O_A , a point $B \in O_A$, and a convex set \mathcal{A} . (This time we do not assume that the set \mathcal{A} lies on a_{O_A} or on any other line or even plane.) If $B \in \mathcal{A}$ but $O \notin \mathcal{A}$ then $\mathcal{A} \cap a_{O_A} \subset O_A$.

⁵²We shall usually assume the plane (denoted here α) to be fixed and omit the mention of it from our notation

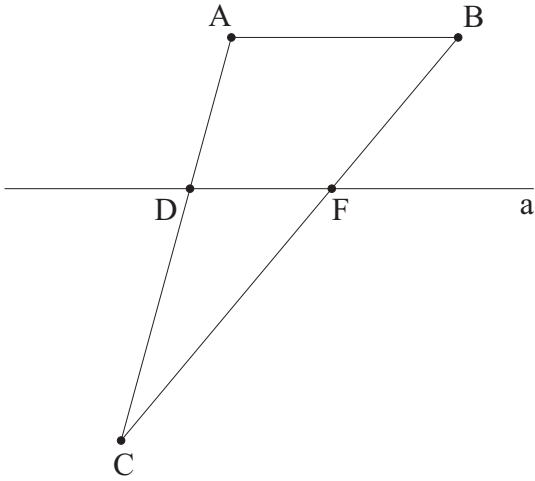

Figure 1.29: If A, B and B, C lie on one side of a , so do A, C .

Lemma 1.2.17.2. *The relation "to lie in plane α on the opposite side of the line a from" is symmetric.*

Proof. Follows from A 1.2.1. \square

In view of symmetry of the corresponding relations, if a point B lies in plane α on the same side of a line a as (on the opposite side of a line a from) a point A , we can also say that the points A and B lie in plane α on one side (on opposite (different) sides) of the line a .

Lemma 1.2.17.3. *A point A lies in the half-plane a_A .*

Lemma 1.2.17.4. *If a point B lies in a half-plane a_A , then the point A lies in the half-plane a_B .*

Lemma 1.2.17.5. *Suppose a point B lies in a half-plane a_A , and a point C in the half-plane a_B . Then the point C lies in the half-plane a_A .*

Lemma 1.2.17.6. *If a point B lies on a half-plane a_A then $a_B = a_A$.*

Proof. To show $a_B \subset a_A$ note that $C \in a_B \& B \in a_A \xrightarrow{C1.2.17.5} C \in a_A$. Since $B \in a_A \xrightarrow{C1.2.17.4} A \in a_B$, we have $C \in a_A \& A \in a_B \xrightarrow{C1.2.17.5} C \in a_B$ and thus $a_A \subset a_B$. \square

Lemma 1.2.17.7. *If half-planes a_A and a_B have common points, they are equal.*

Proof. $a_A \cap a_B \neq \emptyset \Rightarrow \exists C \ C \in a_A \& C \in a_B \xrightarrow{L1.2.17.6} a_A = a_C = a_B$. \square

Lemma 1.2.17.8. *Let A, B be two points in plane α not lying on the line $a \subset \alpha$. Then the points A and B lie either on one side or on opposite sides of the line a .*

Proof. Follows immediately from the definitions of "to lie on one side" and "to lie on opposite side". \square

Lemma 1.2.17.9. *If points A and B lie on opposite sides of a line a , and B and C lie on opposite sides of the line a , then A and C lie on the same side of a .*

Proof. (See Fig. 1.30.) $AaB \& BaC \Rightarrow \exists D \ (D \in a \& [ADB]) \& \exists E \ (E \in a \& [BEC]) \xrightarrow{T1.2.6} \neg \exists F \ (F \in a \& [AFC]) \Rightarrow ACa$. ⁵³ \square

Lemma 1.2.17.10. *If a point A lies in plane α on the same side of the line a as a point C and on the opposite side of a from a point B , the points B and C lie on opposite sides of the line a .*

Proof. Points B, C cannot lie on the same side of a , because otherwise $ACa \& BCa \Rightarrow ABa$ - a contradiction. Then BaC by L 1.2.17.8. \square

Lemma 1.2.17.11. *Let points A and B lie in plane α on opposite sides of the line a , and points C and D - on the half planes a_A and a_B , respectively. Then the points C and D lie on opposite sides of a .*

Proof. $ACa \& AaB \& BDa \xrightarrow{L1.2.17.10} CaD$. \square

Theorem 1.2.17. *Proof.* \square

⁵³Observe that since $A \notin a$, the conditions of the theorem T 1.2.6 are met whether the points A, B, C are collinear or not.

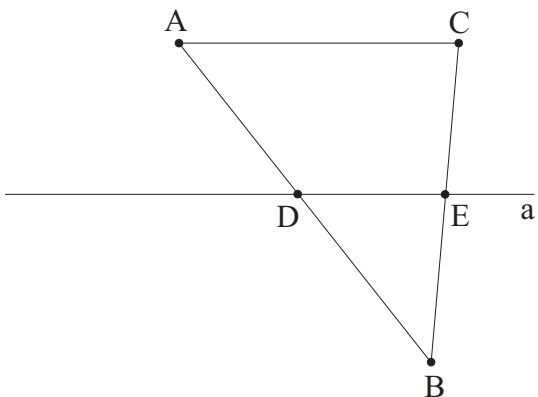

Figure 1.30: If A and B , as well as B and C , lie on opposite sides of a , A and C lie on the same side of a .

Point Sets on Half-Planes

Given a line a on a plane α , a nonempty point set $\mathcal{B} \subset \mathcal{P}_\alpha$ is said to lie in plane α on the same side (on the opposite side) of the line a as (from) a nonempty set $\mathcal{A} \subset \mathcal{P}_\alpha$, written $(\mathcal{A}\mathcal{B}a)_\alpha$ or simply $\mathcal{A}\mathcal{B}a$ ($(\mathcal{A}a\mathcal{B})_\alpha$ or simply $\mathcal{A}a\mathcal{B}$) iff for all $A \in \mathcal{A}$ and all $B \in \mathcal{B}$ the point B lies on the same side (on the opposite side) of the line a as (from) the point $A \in \mathcal{A}$. If the set \mathcal{A} (the set \mathcal{B}) consists of a single element (i.e., only one point), we say that the set \mathcal{B} (the point B) lies in plane α on the same side of the line a as the point A (the set \mathcal{A}).

If all elements of a point set \mathcal{A} lie in some plane α on one side of a line a , it is legal to write $a_{\mathcal{A}}$ to denote the side of a that contains all points of \mathcal{A} .

Lemma 1.2.18.1. *If a set $\mathcal{B} \subset \mathcal{P}_\alpha$ lies in plane α on the same side of the line a as a set $\mathcal{A} \subset \mathcal{P}_\alpha$, then the set \mathcal{A} lies in plane α on the same side of the line a as the set \mathcal{B} .*

Proof. See L 1.2.17.1. \square

Lemma 1.2.18.2. *If a set $\mathcal{B} \subset \mathcal{P}_\alpha$ lies in plane α on the same side of the line a as a set $\mathcal{A} \subset \mathcal{P}_\alpha$, and a set $\mathcal{C} \subset \mathcal{P}_\alpha$ lies in plane α on the same side of the line a as the set \mathcal{B} , then the set \mathcal{C} lies in plane α on the same side of the line a as the set \mathcal{A} .*

Proof. See L 1.2.17.1. \square

Lemma 1.2.18.3. *If a set $\mathcal{B} \subset \mathcal{P}_\alpha$ lies in plane α on the opposite side of the line a from a set $\mathcal{A} \subset \mathcal{P}_\alpha$, then the set \mathcal{A} lies in plane α on the opposite side of the line a from the set \mathcal{B} .*

Proof. See L 1.2.17.2. \square

The lemmas L 1.2.17.9 – L 1.2.17.11 can be generalized in the following way:

Lemma 1.2.18.4. *If point sets \mathcal{A} and \mathcal{B} lie on opposite sides of a line a , and the sets \mathcal{B} and \mathcal{C} lie on opposite sides of the line a , then \mathcal{A} and \mathcal{C} lie on the same side of a .*

Lemma 1.2.18.5. *If a point set \mathcal{A} lies in plane α on the same side of the line a as a point set \mathcal{C} and on the opposite side of a from the point set \mathcal{B} , the point sets \mathcal{B} and \mathcal{C} lie on opposite sides of the line a .*

Proof. \square

Lemma 1.2.18.6. *Let point sets \mathcal{A} and \mathcal{B} lie in plane α on opposite sides of the line a , and point sets \mathcal{C} and \mathcal{D} - on the same side of a as \mathcal{A} and \mathcal{B} , respectively. Then \mathcal{C} and \mathcal{D} lie on opposite sides of a .*

In view of symmetry of the relations, established by the lemmas above, if a set $\mathcal{B} \subset \mathcal{P}_\alpha$ lies in plane α on the same side (on the opposite side) of the line a as a set (from a set) $\mathcal{A} \subset \mathcal{P}_\alpha$, we say that the sets \mathcal{A} and \mathcal{B} lie in plane α on one side (on opposite sides) of the line a .

Theorem 1.2.18. *Proof.* \square

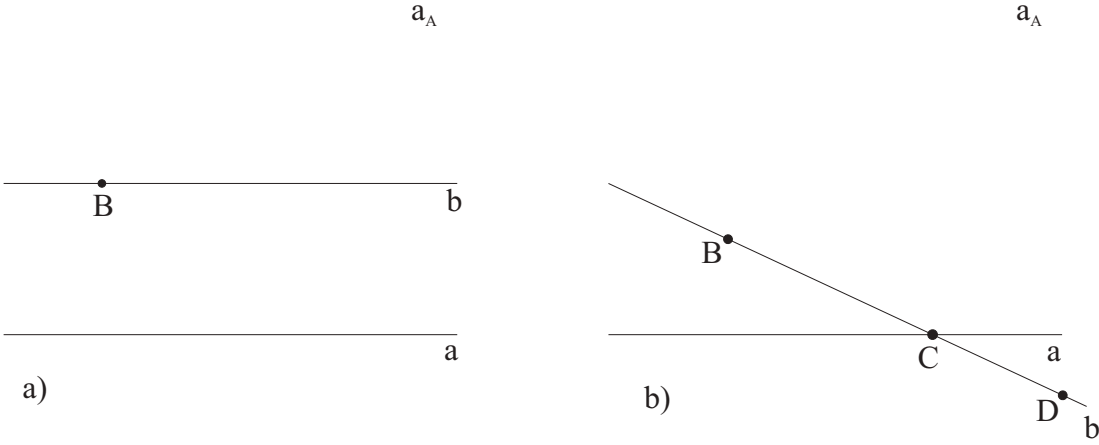

Figure 1.31: A line b parallel to a and having common points with a_A , lies in a_A .

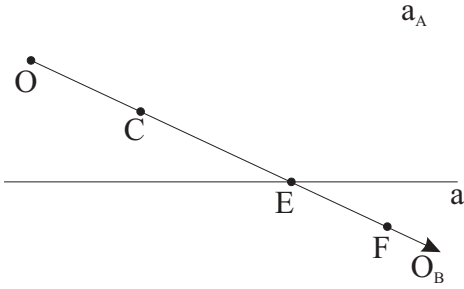

Figure 1.32: Given a ray O_B with a point C on α_{aA} , not meeting a line a , if O lies in a_A , so does O_B .

Complementary Half-Planes

Given a half-plane a_A in plane α , we define the half-plane a_A^c , complementary to the half-plane a_A , as $\mathcal{P}_\alpha \setminus (\mathcal{P}_a \cup a_A)$.

An alternative definition of complementary half-plane is provided by the following

Lemma 1.2.19.1. *Given a half-plane a_A , the complementary half-plane a_A^c is the set of points B such that the open interval (AB) meets the line a : $a_A^c \equiv \{\exists O O \in a \ \& \ [OAB]\}$. Thus, a point C lying in α outside a lies either on a_A or on a_A^c .*

Proof. $B \in \mathcal{P}_\alpha \setminus (\mathcal{P}_a \cup a_A) \stackrel{L1.2.17.8}{\iff} AaB \Leftrightarrow \exists O O \in a \ \& \ [AOB]$. \square

Lemma 1.2.19.2. *The half-plane $(a_A^c)^c$, complementary to the half-plane a_A^c , complementary to the half-plane a_A , coincides with the half-plane a_A itself.*

Proof. In fact, we have $a_A = \mathcal{P}_\alpha \setminus (\mathcal{P}_a \cup (\mathcal{P}_\alpha \setminus (\mathcal{P}_a \cup a_A))) = (a_A^c)^c$. \square

Lemma 1.2.19.3. *A line b that is parallel to a line a and has common points with a half-plane a_A , lies (completely) in a_A .*

Proof. (See Fig. 1.31, a.) $B \in a_A \Rightarrow B \in \alpha_{aA}$. $a \subset \alpha \ \& \ a \subset \alpha_{aA} \ \& \ B \in \alpha \ \& \ B \in \alpha_{aA} \stackrel{A1.1.2}{\iff} \alpha = \alpha_{aA}$. By hypothesis, $b \cap a = \emptyset$. To prove that $b \cap a_A^c = \emptyset$ suppose that $\exists D D \in b \cap a_A^c$ (see Fig. 1.31, b). Then $ABa \ \& \ AaD \stackrel{L1.2.17.10}{\implies} \exists C C \in a \ \& \ [BCD] \stackrel{L1.2.1.3}{\implies} \exists C C \in a \cap a_{BD} = b$ - a contradiction. Thus, we have shown that $b \subset \mathcal{P}_\alpha \setminus (\mathcal{P}_a \cup a_A^c) = a_A$. \square

Given a ray O_B , having a point C on plane α_{aA} and not meeting a line a

Lemma 1.2.19.4. *- If the origin O lies in half-plane a_A ⁵⁴, so does the whole ray O_B .*

Proof. (See Fig. 1.32.) $O \in \alpha_{aA} \cap a_{OB} \ \& \ C \in \alpha_{aA} \cap O_B \stackrel{A1.1.6}{\implies} a_{OB} \subset \alpha_{aA}$. By hypothesis, $O_B \cap a = \emptyset$. To prove $O_B \cap a_A^c = \emptyset$, suppose $\exists F F \in O_B \cap a_A^c$. Then $O \in a_A \ \& \ F \in a_A^c \Rightarrow \exists E E \in a \ \& \ [OEF] \stackrel{L1.2.11.13}{\implies} \exists E E \in a \cap O_B$ - a contradiction. Thus, $O_B \subset \mathcal{P}_\alpha \setminus (\mathcal{P}_a \cup a_A^c) = a_A$. \square

⁵⁴Perhaps, it would be more natural to assume that the ray O_B lies in plane α_{aA} , but we choose here to formulate weaker, albeit clumsier, conditions.

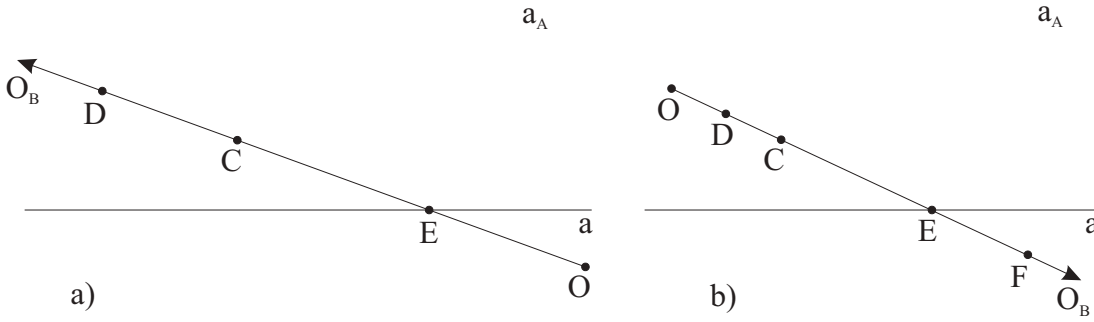

Figure 1.33: Given a ray O_B , not meeting a line a , and containing a point $C \in \alpha_{a_A}$, if O_B and a_A share a point D , distinct from C , then: a) O lies in a_A or on a ; b) O_B lies in a_A .

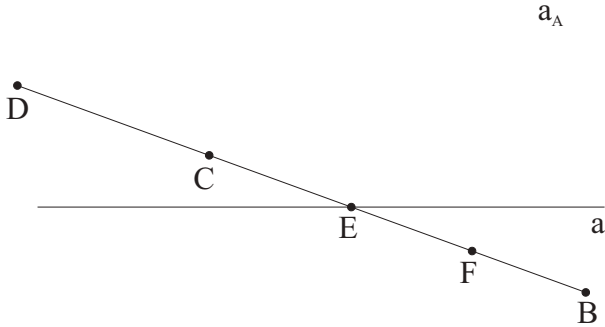

Figure 1.34: Given an open interval (DB) , not meeting a line a and having a point C on plane α_{a_A} , if one of the ends of (DB) lies in a_A , (DB) lies in a_A and its other end lies either on a_A or on a .

Lemma 1.2.19.5. - If the ray O_B and the half-plane a_A have a common point D , distinct from C ⁵⁵, then:

- a) The initial point O of O_B lies either in half-plane a_A or on (its edge) line a ;
- b) The whole ray O_B lies in half-plane a_A .

Proof. a) (See Fig. 1.33, a.) $D \in \alpha_{a_A} \cap O_B$ & $C \in \alpha_{a_A} \cap O_B \xrightarrow{L1.1.1.8} O_B \subset \alpha_{a_A}$. To prove $O \notin a_A^c$ suppose $O \in a_A^c$. Then $D \in a_A$ & $O \in a_A^c \exists E \in a$ & $[OED] \xrightarrow{L1.2.11.13} \exists E \in a \cap O_B$ - a contradiction. We see that $O \in \mathcal{P}_\alpha \setminus a_A^c = a_A \cup \mathcal{P}_a$.

b) (See Fig. 1.33, b.) By hypothesis, $a \cap O_B = \emptyset$. If $\exists F \in O_B \cap a_A^c$, we would have $D \in a_A$ & $F \in a_A^c \Rightarrow \exists E \in a$ & $[DEF] \xrightarrow{L1.2.16.4} \exists E \in a \cap O_B$ - a contradiction. Therefore, $O_B \subset \mathcal{P}_\alpha \setminus (\mathcal{P}_a \cup a_A^c) = a_A$. \square

Given an open interval (DB) having a point C on plane α_{a_A} and not meeting a line a

Lemma 1.2.19.6. - If one of the ends of (DB) lies in half-plane a_A , the open interval (DB) completely lies in half-plane a_A and its other end lies either on a_A or on line a .

Proof. (See Fig. 1.34.) $D \in \alpha_{a_A}$ & $C \in \alpha_{a_A} \cap (DB) \xrightarrow{P1.2.5.3} a_{DB} \subset \alpha_{a_A} \Rightarrow (DB) \subset \alpha_{a_A}$. If $B \in a_A^c$ then $D \in a_A$ & $B \in a_A^c \Rightarrow \exists E \in a$ & $[DEB]$ - a contradiction. By hypothesis, $(DB) \cap a = \emptyset$. To prove $(DB) \cap a_A^c = \emptyset$, suppose $F \in (DB) \cap a_A^c$. Then $D \in a_A$ & $F \in a_A^c \exists E \in a$ & $[DEF]$. But $[DEF]$ & $[DFB] \xrightarrow{L1.2.3.2} [DEB]$ - a contradiction. \square

Lemma 1.2.19.7. - If the open interval (DB) and the half-plane a_A have at least one common point G , distinct from C , then the open interval (DB) lies completely in a_A , and either both its ends lie in a_A , or one of them lies in a_A , and the other on line a .

Proof. By L 1.1.1.8 $G \in \alpha_{a_A} \cap (DB)$ & $C \in \alpha_{a_A} \cap (DB) \xrightarrow{P1.2.5.3} C \in \alpha_{a_A} \Rightarrow (DB) \subset \alpha_{a_A}$. Both ends of (DB) cannot lie on a , because otherwise by A 1.1.2, L 1.2.1.3 $D \in a$ & $B \in a \Rightarrow (BD) \subset a \Rightarrow (BD) \cap a_A = \emptyset$. Let $D \notin a$. To prove $D \notin a_A^c$ suppose $D \in a_A^c$. Then $D \in a_A^c$ & $(BD) \cap a = \emptyset$ & $C \in \alpha_{a_A} \cap (BD) \xrightarrow{L1.2.19.6} (BD) \subset a_A^c \Rightarrow G \in a_A^c$ - a contradiction. Therefore, $D \in a_A$. Finally, $D \in a_A$ & $(DB) \cap a = \emptyset$ & $C \in \alpha_{a_A} \cap (DB) \xrightarrow{L1.2.19.6} (BD) \subset a_A$. \square

Lemma 1.2.19.8. A ray O_B having its initial point O on a line a and one of its points C on a half-plane a_A , lies completely in a_A , and its complementary ray O_B^c lies completely in the complementary half-plane a_A^c .

In particular, given a line a and points $O \in a$ and $A \notin a$, we always have $O_A \subset a_A$, $O_A^c \subset a_A^c$. We can thus write $a_A^c = a_{O_A^c}$.

⁵⁵see previous footnote

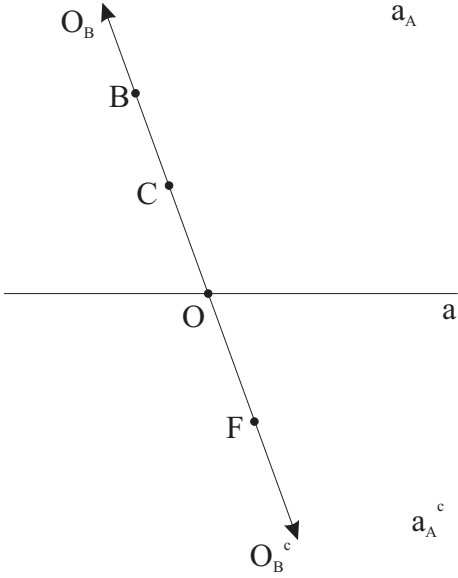

Figure 1.35: A ray O_B with its initial point O on a and one of its points C on a_A , lies in a_A , and O_B^c lies in a_A^c .

Proof. (See Fig. 1.35.) $O \in a \subset \alpha_{a_A}$ & $C \in a_A \subset \alpha_{a_A} \xrightarrow{A1.1.6} a_{OC} \subset \alpha_{a_A}$. $O_B \cap a = \emptyset$, because if $\exists E E \in O_B$ & $E \in a$, we would have $O \in a_{OB} \cap a$ & $O \in a_{OB} \cap a \xrightarrow{A1.1.2} a = a_{OB} \Rightarrow C \in a$ - a contradiction. $O_B \subset a_{OB} = a_{OC} \subset \alpha_{a_A}$ & $C \in O_B \cap a_A$ & $O_B \cap a = \emptyset \xrightarrow{L1.2.19.5} O_B \subset a_A$. By A 1.2.1 $\exists F [BOF]$. Since $F \in O_B^c \cap a_A^c$, by preceding argumentation we conclude that $O_B^c \subset a_A^c$. \square

Lemma 1.2.19.9. *If one end of an open interval (DB) lies in half - plane a_A , and the other end lies either in a_A or on line a , the open interval (DB) lies completely in a_A .*

Proof. $D \in a_A$ & $B \in a_A \xrightarrow{P1.2.5.3} (DB) \subset \alpha_{a_A}$. Let $B \in a_A$. If $D \in a_A$ we note that by L 1.2.11.13 $(DB) \subset D_B$ and use L 1.2.19.8. Let now $D \in a$. Then $(DB) \cap a = \emptyset$, because $B \in a_A$ & $E \in (DB) \cap a \Rightarrow D \in a_A^c$ - a contradiction. Finally, $B \in a_A$ & $(DB) \subset \alpha_{a_A}$ & $(DB) \cap a = \emptyset \xrightarrow{L1.2.19.5} (DB) \subset a_A$. \square

Lemma 1.2.19.10. *Every half-plane contains an infinite number of points. Furthermore, every half-plane contains an infinite number of rays.*

Proof. \square

Lemma 1.2.19.11. *There is exactly one plane containing a given half-plane.*

Proof. \square

The plane, containing a given half-plane a_A is, of course, the plane α_{a_A} .

For convenience, (especially when talking about dihedral angles - see p. 87), we shall often denote the plane containing a half-plane χ by $\bar{\chi}$.⁵⁶

Lemma 1.2.19.12. *Equal half-planes have equal edges.*

Proof. Suppose $a_A = b_B$ and $X \in a$. Then also $\alpha_{a_A} = \alpha_{b_B}$,⁵⁷ and we have $X \in \alpha_{b_B}$ & $X \notin b_B \Rightarrow X \in b \vee X \in b_B^c$. Suppose $X \in b_B^c$. Then, taking a point $P \in b_B$, we would have $P \in b_B$ & $X \in b_B^c \Rightarrow \exists M [PMX]$ & $M \in b$. On the other hand, $X \in a$ & $P \in b_B = a_A$ & $[PMX] \xrightarrow{L1.2.19.9} M \in b_B$, which contradicts $M \in b$. This contradiction shows that, in fact, $X \notin b_B^c$, and thus $X \in b$. Since we have shown that any point of the line a also lies on the line b , these lines are equal, q.e.d. \square

Lemma 1.2.19.13. *1. If a plane α and the edge a of a half-plane χ concur at a point O , the plane α and the half-plane χ have a common ray h with the origin O , and this ray contains all common points of α and χ .*

If a plane α and a half-plane χ have a common ray h (and then, of course, they have no other common points), we shall refer to the ray h as the section of the half-plane χ by the plane α .

⁵⁸

2. Conversely, if a ray h is the section of a half-plane χ by a plane α , then the plane α and the edge a of the half-plane χ concur at a single point - the origin O of the ray h .

⁵⁶Cf. the corresponding notation for rays on p. 18

⁵⁷See the preceding lemma, L 1.2.19.11.

⁵⁸Observe that, obviously, if h is the section of χ by α , then the line \bar{h} lies in plane $\bar{\chi}$ (see A 1.1.6). Furthermore, we have then $\bar{h} = \bar{\chi} \cap \alpha$.

Proof. 1. Since the planes $\alpha, \bar{\chi}$ have a common point O , they have another common point A . Without loss of generality we can assume $A \in \chi$.⁵⁹ Then by L 1.2.19.8 we have $O_A \subset \chi \cap \alpha$, $O_A^c \subset \chi^c \cap \alpha$, which implies that $O_A = \chi \cap \alpha$.⁶⁰

2. We have $h = \chi \cap \alpha \Rightarrow h \subset \chi \xrightarrow{\text{L1.2.19.5}} \partial h \in \chi \cup \partial \chi$. But $O = \partial h \notin h$ & $h \subset \chi \Rightarrow O \notin \chi$. Hence, $O \in a = \partial \chi$. Since, using L 1.2.19.8, we have $h^c \subset \chi^c$, together with $\chi^c \cap a = \emptyset$, this gives $h^c \cap a = \emptyset$. Hence, we have $O = a \cap \alpha$.
□

Corollary 1.2.19.14. *If a ray h is the section of a half-plane χ by a plane α , then the complementary ray h^c is the section of the complementary half-plane χ^c by α .*

Proof. □

Lemma 1.2.19.15. *Given three distinct points A, O, B on one line b , such that the point O lies on a line a , if A, B lie on one side (on opposite sides) of a , they also lie (on b) on one side (on opposite sides) of the point O .*

Proof. Follows from L 1.2.19.8.⁶¹ □

Given a strip ab (i.e. a pair of parallel lines a, b), we define its interior, written $Int\ ab$, as the set of points lying on the same side of the line a as the line b and on the same side of the line b as the line a .⁶² Equivalently, we could take some points A on a and B on b and define $Int\ ab$ as the intersection $a_B \cap b_A$.

Lemma 1.2.19.16. *If $A \in a, B \in b$, and $a \parallel b$ then $(AB) \subset Int\ ab$. Furthermore, $(AB) = \mathcal{P}_{a_{AB}} \cap Int\ ab$.*

Proof. Obviously, $(AB) \subset \mathcal{P}_{a_{AB}} \cap Int\ ab$ (see L 1.2.1.3, L 1.2.19.9). On the other hand, $C \in a_{AB} \xrightarrow{\text{T1.2.2}} C = A \vee C = B \vee [ABC] \vee [ABC] \vee [CAB]$. From the definition of the interior of the strip ab it is evident that $C \in Int\ ab$ contradicts all of these options except $[ABC]$, which means that $\mathcal{P}_{a_{AB}} \cap Int\ ab \subset (AB)$.
□

Given a line a with one of the two possible orders (direct or inverse) defined on it, we shall say that the choice of the order defines one of the two possible *directions* on a . We shall sometimes refer to a line a with direction on it as an oriented or directed line. Thus, an oriented line is the pair consisting of a line and an order defined on it.

Two parallel oriented lines a, b are said to have the same sense (or, loosely speaking, the same direction) iff the following requirements hold for arbitrary points $A, O, B \in a$ and $A', O', B' \in b$: If $A \prec O$ on a and $A' \prec O'$ on b then points A, A' lie on the same side of the line $a_{OO'}$; if $O \prec B$ on a and $O' \prec B'$ on b then points B, B' lie on the same side of the line $a_{OO'}$.

To formulate a simple criteria for deciding whether two given parallel lines have the same sense, we are going to need the following simple lemmas.

Lemma 1.2.19.17. *Given two parallel lines a, b and points $A, C \in a, B, D \in b$, all points common to the open interval (AB) and the line a_{CD} (if there are any) lie on the open interval (CD) .*

Proof. Suppose $X \in (AB) \cap a_{CD}$. By the preceding lemma we have $X \in Int\ ab$. Since the points C, X, D are obviously distinct, from T 1.2.2 we see that either $[XCD]$, or $[CXD]$, or $[CDX]$. But $[XCD]$ would imply that the points X and $D \in b$ lie on opposite sides of the line a , which contradicts $X \in Int\ ab$. Similarly, we conclude that $\neg[CDX]$.⁶³ Hence $[CXD]$, as required. □

Lemma 1.2.19.18. *Given two parallel lines a, b and points $A, C \in a, B, D \in b$, if points A, B lie on the same side of the line a_{CD} , then the points C, D lie on the same side of the line a_{AB} .*

Proof. Suppose the contrary, i.e. that the points C, D do not lie on the same side of the line a_{AB} . Since, evidently, $C \notin a_{AB}, D \notin a_{AB}$,⁶⁴ this implies that C, D lie on opposite sides of a_{AB} . Hence $\exists X(X \in (CD) \cap a_{AB})$. From the preceding lemma (L 1.2.19.17) we then have $X \in (CD) \cap (AB)$, which means that A, B lie on opposite sides of a_{CD} - a contradiction. This contradiction shows that in reality the points C, D do lie on the same side of the line a_{AB} . □

Lemma 1.2.19.19. *Suppose that for oriented lines a, b and points $A, O \in a, A', O' \in b$ wave: $a \parallel b$; $A \prec O$ on a , $A' \prec O'$ on b , and the points A, A' lie on the same side of the line $a_{OO'}$. Then the oriented lines a, b have the same direction.*

⁵⁹In fact, since a and α concur at O , the point $A \neq O$ cannot lie on a . Hence $A \in \bar{\chi}$ & $A \notin a \xrightarrow{\text{L1.2.17.8}} A \in \chi \vee A \in \chi^c$. In the second case (when $A \in \chi^c$) we can use A 1.2.2 to choose a point B such that $[AOB]$. Then, obviously, $B \in \chi$, so we just need to rename $A \leftrightarrow B$.

⁶⁰Observe that, using T 1.1.5, we can write $a_{OA} = \bar{\chi} \cap \alpha$. In view of $\mathcal{P}_{\bar{\chi}} = \chi \cup \mathcal{P}_a \cup \chi^c$, $O_A \subset \chi \cap \alpha$, $O_A^c \subset \chi^c \cap \alpha$, this gives $O_A = \chi \cap \alpha$.

⁶¹In fact, since $B \in a_{OA} = b$, we have either $B \in O_A$ or $B \in O_A^c$. L 1.2.19.8 then implies that in the first case $B \in a_A$, while in the second $B \in a_A^c$. Hence the result. Indeed, suppose $B \in a_A$, i.e. $B \in a_A$. Then $B \in O_A$, for $B \in O_A^c$ would imply a_A^c . Similarly, $B \in a_A$ implies $B \in O_A^c$.

⁶²Evidently, since the lines a, b are parallel, all points of b lie on the same side of a , and all points of a lie on the same side of b .

⁶³This is immediately apparent from symmetry upon the substitution $A \leftrightarrow B, C \leftrightarrow D, a \leftrightarrow b$, which does not alter the conditions of the theorem.

⁶⁴Note that the lines a, a_{AB} are distinct ($B \notin a$) and thus have only one common point, namely, A . Consequently, the inclusion $C \in a \cap a_{AB}$ would imply $C = A$. But this contradicts the assumption that A, B lie on the same side of a_{CD} , which presupposes that the point A lies outside a_{CD} .

Proof. ⁶⁵ Consider arbitrary points $C, D \in a, C', D' \in b$ with the conditions that $C \prec D$ on a and $C' \prec D'$ on b . We need to show that the points D, D' lie on the same side of the line $a_{CC'}$.

Suppose first that $C \prec O, C' \prec O'$. Since also $A \prec O, A' \prec O'$, and A, A' lie on the same side of $a_{OO'}$ (by hypothesis), ⁶⁶ we see that $CC'a_{OO'}$. Hence $OO'a_{CC'}$ from the preceding lemma (L 1.2.19.18). Since also $C \prec D, C' \prec D'$, using again the observation just made, we have $DD'a_{CC'}$.

Suppose now $C' = O'$. Without loss of generality we can assume that $[ACO]$. ⁶⁷ $AA'a_{OO'} \Rightarrow OO'a_{AA'}$. Since $OO'a_{AA'}$ and C, O lie on the same side of A , we see that $C, C' = O'$ lie on the same side of $a_{AA'}$, whence (again using the preceding lemma (L 1.2.19.18)) $AA'a_{CC'}$. As, evidently, $[ACD]$ and $[A'C'D']$, we find that $DD'a_{CC'}$, as required.

Finally, suppose $O' \prec C'$. Again, without loss of generality we can assume that $[ACO]$. Since $A' \prec O' \prec C'$ $\stackrel{T1.2.14}{\Rightarrow}$ $[A'O'C']$, ⁶⁸ we see that C, C' lie on the same side of $a_{AA'}$, and, consequently, $AA'a_{CC'}$ (L 1.2.19.18). Finally, from $A \prec C \prec D, A' \prec C' \prec D'$ using the observation made above we see that $DD'a_{CC'}$, as required. \square

Lemma 1.2.19.20. *Suppose that a line b is parallel to lines a, c and has a point $B \in b$ inside the strip ac . Then the line b lies completely inside ac .*

Proof. \square

Corollary 1.2.19.21. *Suppose that a line b is parallel to lines a, c and has a point $B \in b$ lying on an open interval (AC) , where $A \in a, C \in c$. Then the line b lies completely inside ac .*

Proof. See L 1.2.19.16, L 1.2.19.20. \square

Lemma 1.2.19.22. *If a line b lies completely in a half-plane a_A , then the lines a, b are parallel.*

Lemma 1.2.19.23. *If lines a, b lie on the same side of a line c , they are both parallel to the line c .*

Lemma 1.2.19.24. *If lines a, b lie on the opposite sides of a line c , they are parallel to each other and are both parallel to the line c .*

Lemma 1.2.19.25. *If lines a, b lie on opposite sides of a line c , then the lines b, c lie on the same side of the line a .* ⁶⁹

Proof. Since a, b lie on opposite sides of c , taking points $A \in a, B \in b$, we can find a point $C \in c$ such that $[ACB]$. The rest is obvious (see, for example, L 1.2.19.9). \square

Lemma 1.2.19.26. *Consider lines a, b, c such that $c \parallel a$ and $c \parallel b$. If the line c meets at least one open interval (A_0B_0) , where $A_0 \in a, B_0 \in b$, then it meets any open interval (AB) such that $A \in a, B \in b$.*

Proof. Denote $C_0 \equiv (A_0B_0) \cap c$. Taking arbitrary points $A \in a, B \in b$ we are going to show that $\exists C \in c$ such that $C \in (AB) \cap c$. Since $[A_0C_0B_0]$ and $c \parallel a, c \parallel b$, the lines a, b, c coplane in view of C 1.2.1.10. Therefore, the line c lies in the plane $\alpha_{A_0B_0A}$ determined by the points A_0, B_0, A , as well as in the plane α_{B_0AB} determined by the points B_0, A, B . Furthermore, $c \parallel a, c \parallel b$ implies that $A_0 \notin c, B_0 \notin c, A \notin c, B \notin c$. Thus, the conditions of A 1.2.4 are met, and applying it twice, we first find that $\exists C' \in (BA_0) \cap c$ and then that $\exists C \in (AB) \cap c$, as required. \square

As before, we can generalize some of our previous considerations using the concept of a convex set.

Lemma 1.2.19.27. *Consider a half-plane a_A , a point $B \in a_A$, and a convex set \mathcal{A} of points of the plane α_{a_A} . If $B \in \mathcal{A}$ but $\mathcal{A} \cap \mathcal{P}_a = \emptyset$ then $\mathcal{A} \subset a_A$.* ⁷⁰

Proof. Suppose that there exists $C \in a_A^c \cap \mathcal{A}$. Then $\exists D (D \in \mathcal{A} \cap \mathcal{P}_a)$ in view of convexity, contrary to hypothesis. Since $\mathcal{A} \subset \mathcal{P}_\alpha$ and $a_A^c \cap \mathcal{A} = \emptyset, \mathcal{P}_\alpha \cap \mathcal{A} = \emptyset$, we conclude that $\mathcal{A} \subset a_A$. \square

⁶⁵In this, as well as many other proofs, we leave it to the reader to supply references to some well-known facts such as L 1.2.11.13, T 1.2.14, etc.

⁶⁶We make use of the following fact, which will be used (for different points and lines) again and again in this proof: $C \prec O, C' \prec O', A \prec O, A' \prec O'$, and A, A' lie on the same side of $a_{OO'}$, then C, C' lie on the same side of $a_{OO'}$. This, in turn, stems from the fact that once the points A, A' lie on the same side of $a_{OO'}$, the complete rays $O_A, O'_{A'}$ (of course, including the points C, C' , respectively) lie on the same side of $a_{OO'}$.

⁶⁷We take into account that every point of the ray O_A lies on the same side of $a_{OO'}$.

⁶⁸We take into account that the points O, C lie on the line a on the same side of A and the points O', C' lie on the line b on the same side of A' .

⁶⁹And, of course, the lines a, c lie on opposite sides of the line b .

⁷⁰Alternatively, this theorem can be formulated as follows: Consider a half-plane a_A , a point $B \in a_A$, and a convex set \mathcal{A} . (This time we do not assume that the set \mathcal{A} lies completely on α_{a_A} or on any other plane.) If $B \in \mathcal{A}$ but $\mathcal{A} \cap \mathcal{P}_a = \emptyset$ then $\mathcal{A} \cap \alpha_{a_A} \subset a_A$.

Theorem 1.2.19. Given a line a , let \mathcal{A} be either

- A set $\{B_1\}$, consisting of one single point B_1 lying on a half - plane a_A ; or
 - A line b_1 , parallel to a and having a point B_1 on a_A ; or
 - A ray $(O_1)_{B_1}$ having a point C_1 on α_{aA} and not meeting the line a , such that the initial point O or one of its points D_1 distinct from C_1 lies on a_A ; or
 - an open interval (D_1B_1) having a point C_1 on plane α_{aA} , and not meeting a line a , such that one of its ends lies in a_A , or one of its points, $G_1 \neq C_1$, lies in a_A ; or
 - A ray $(O_1)_{B_1}$ with its initial point O_1 on a and one of its points, C_1 , in a_A ; or
 - An interval - like set with both its ends D_1, B_1 in a_A , or with one end in a_A and the other on a ;
- and let \mathcal{B} be either
- A line b_2 , parallel to a and having a point B_2 on a_A ; or
 - A ray $(O_2)_{B_2}$ having a point C_2 on α_{aA} and not meeting the line a , such that the initial point O or one of its points D_2 distinct from C_2 lies on a_A ; or
 - An open interval (D_2B_2) having a point C_2 on plane α_{aA} , and not meeting a line a , such that one of its ends lies in a_A , or one of its points, $G_2 \neq C_2$, lies in a_A ; or
 - A ray $(O_2)_{B_2}$ with its initial point O_2 on a and one of its points, C_2 , in a_A ; or
 - An interval - like set with both its ends D_2, B_2 in a_A , or with one end in a_A and the other on a .
- Then the sets \mathcal{A} and \mathcal{B} lie in plane α_{aA} on one side of the line a .

Proof. \square

Theorem 1.2.20. Given a line a , let \mathcal{A} be either

- A set $\{B_1\}$, consisting of one single point B_1 lying on a half - plane a_A ; or
 - A line b_1 , parallel to a and having a point B_1 on a_A ; or
 - A ray $(O_1)_{B_1}$ having a point C_1 on α_{aA} and not meeting the line a , such that the initial point O or one of its points D_1 distinct from C_1 lies on a_A ; or
 - An open interval (D_1B_1) having a point C_1 on plane α_{aA} , and not meeting a line a , such that one of its ends lies in a_A , or one of its points, $G_1 \neq C_1$, lies in a_A ; or
 - A ray $(O_1)_{B_1}$ with its initial point O_1 on a and one of its points, C_1 , in a_A ; or
 - An interval - like set with both its ends D_1, B_1 in a_A , or with one end in a_A and the other on a ;
- and let \mathcal{B} be either
- A line b_2 , parallel to a and having a point B_2 on a_A^c ; or
 - A ray $(O_2)_{B_2}$ having a point C_2 on α_{aA} and not meeting the line a , such that the initial point O or one of its points D_2 distinct from C_2 lies on a_A^c ; or
 - An open interval (D_2B_2) having a point C_2 on plane α_{aA} , and not meeting a line a , such that one of its ends lies in a_A^c , or one of its points, $G_2 \neq C_2$, lies in a_A^c ; or
 - A ray $(O_2)_{B_2}$ with its initial point O_2 on a and one of its points, C_2 , in a_A^c ; or
 - An interval - like set with both its ends D_2, B_2 in a_A^c , or with one end in a_A^c and the other on a .
- Then the sets \mathcal{A} and \mathcal{B} lie in plane α_{aA} on opposite sides of the line a .

Proof. \square

A non-ordered couple of distinct non-complementary rays $h = O_A$ and $k = O_B$, $k \neq h^c$, with common initial point O is called an angle $\angle(h, k)_O$, written also as $\angle AOB$. The point O is called the vertex,⁷¹ or origin, of the angle, and the rays h, k (or O_A, O_B , depending on the notation chosen) its sides. Our definition implies $\angle(h, k) = \angle(k, h)$ and $\angle AOB = \angle BOA$.

Basic Properties of Angles

Lemma 1.2.21.1. If points C, D lie respectively on the sides $h = O_A$ and $k = O_B$ of the angle $\angle(h, k)$ then $\angle COD = \angle(h, k)$.

Proof. (See Fig. 1.36.) Immediately follows from L 1.2.11.3. \square

Lemma 1.2.21.2. Given an angle $\angle AOB$, we have $B \notin a_{OA}$, $A \notin a_{OB}$, and the points A, O, B are not collinear.

⁷²

Proof. Otherwise, we would have $B \in a_{OA} \& B \neq O \xrightarrow{L1.2.15.5} B \in O_A \vee B \in O_A^c \xrightarrow{L1.2.11.3} O_B = O_A \vee O_B = O_A^c$, contrary to hypothesis that O_A, O_B form an angle. We conclude that $B \notin a_{OA}$, whence by C 1.1.2.3 $\neg \exists b (A \in b \& O \in b \& B \in b)$ and $A \notin a_{OB}$. \square

⁷¹In practice the letter used to denote the vertex of an angle is usually omitted from its ray-pair notation, so we can write simply $\angle(h, k)$

⁷²Thus, the angle $\angle AOB$ exists if and only if the points A, O, B do not colline. A 1.1.3 shows that there exists at least one angle.

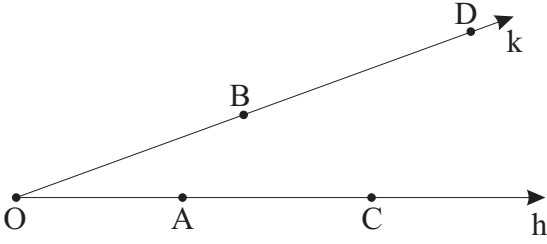

Figure 1.36: If points $C \in h = O_A$ and $D \in k = O_B$ then $\angle COD = \angle(h, k)$.

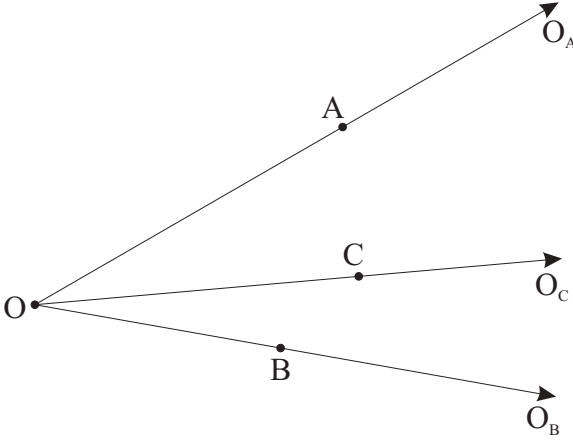

Figure 1.37: If C lies inside $\angle AOB$, O_C lies inside $\angle AOB$: $O_C \subset \text{Int}\angle AOB$.

The set of points, or contour, of the angle $\angle(h, k)_O$, is, by definition, the set $\mathcal{P}_{\angle(h, k)} \doteq h \cup \{O\} \cup k$. We say that a point lies on an angle if it lies on one of its sides or coincides with its vertex. In other words, C lies on $\angle(h, k)$ if it belongs to the set of its points (its contour): $C \in \mathcal{P}_{\angle(h, k)}$.

Lemma 1.2.21.3. *For any angle $\angle(h, k)$, $h = O_A$, $k = O_B$, there is one and only one plane, containing the angle $\angle(h, k)$, i.e. which contains the set $\mathcal{P}_{\angle(h, k)}$. It is called the plane of the angle $\angle(h, k)$ and denoted $\alpha_{\angle(h, k)}$. Thus, we have $\mathcal{P}_{\angle(h, k)} \subset \alpha_{\angle(h, k)} = \alpha_{AOB}$.*

Proof. By L 1.2.21.2 $\neg \exists b (A \in b \& O \in b \& B \in b)$. Hence by A 1.1.4 $\exists \alpha_{AOB} (A \in \alpha_{AOB}) \& O \in \alpha_{AOB} \& B \in \alpha_{AOB}$.⁷³ $(A \in \alpha_{AOB}) \& O \in \alpha_{AOB} \& B \in \alpha_{AOB} \xrightarrow{A1.1.6} a_{OA} \subset \alpha_{AOB} \& a_{OB} \subset \alpha_{AOB}$. We thus have $\mathcal{P}_{\angle AOB} \subset \alpha_{AOB}$. Since any other plane, containing the angle $\angle AOB$ (i.e., containing $\mathcal{P}_{\angle AOB}$), would contain the three non-collinear points A, O, B , by 1.1.5 there can be only one such plane. \square

We say that a point X lies *inside* an angle $\angle(h, k)$ if it lies⁷⁴ on the same side of the line \bar{h} as any of the points of the ray k , and on the same side of the line \bar{k} as any of the points of the ray h .⁷⁵

The set of all points lying inside an angle $\angle(h, k)$ will be referred to as its *interior* $\text{Int}\angle(h, k) \doteq \{X | Xk\bar{h} \& Xh\bar{k}\}$. We can also write $\text{Int}\angle AOB = (a_{OA})_B \cap (a_{OB})_A$.

If a point X lies in plane of an angle $\angle(h, k)$ neither inside nor on the angle, we shall say that X lies *outside* the angle $\angle(h, k)$.

The set of all points lying outside a given angle $\angle(h, k)$ will be referred to as the *exterior* of the angle $\angle(h, k)$, written $\text{Ext}\angle(h, k)$. We thus have, by definition, $\text{Ext}\angle(h, k) \doteq \mathcal{P}_{\alpha_{\angle(h, k)}} \setminus (\mathcal{P}_{\angle(h, k)} \cup \text{Int}\angle(h, k))$.

Lemma 1.2.21.4. *If a point C lies inside an angle $\angle AOB$, the ray O_C lies completely inside $\angle AOB$: $O_C \subset \text{Int}\angle AOB$.*

From L 1.2.11.3 it follows that this lemma can also be formulated as:

If one of the points of a ray O_C lies inside an angle $\angle AOB$, the whole ray O_C lies inside the angle $\angle AOB$.

Proof. (See Fig. 1.37.) Immediately follows from T 1.2.19. Indeed, by hypothesis, $C \in \text{Int}\angle AOB = (a_{OA})_B \cap (a_{OB})_A$. Since also $O \in \bar{h} \cap \bar{k}$, by T 1.2.19 $O_C \subset \text{Int}\angle AOB = (a_{OA})_B \cap (a_{OB})_A$. \square

Lemma 1.2.21.5. *If a point C lies outside an angle $\angle AOB$, the ray O_C lies completely outside $\angle AOB$: $O_C \subset \text{Ext}\angle AOB$.⁷⁶*

⁷³Our use of the notation α_{AOB} is in agreement with the definition on p. 3.

⁷⁴obviously, in plane of the angle

⁷⁵The theorem T 1.2.19 makes this notion well defined in its "any of the points" part.

⁷⁶In full analogy with the case of L 1.2.21.4, from L 1.2.11.3 it follows that this lemma can be reformulated as: If one of the points of a ray O_C lies outside an angle $\angle AOB$, the whole ray O_C lies outside the angle $\angle AOB$.

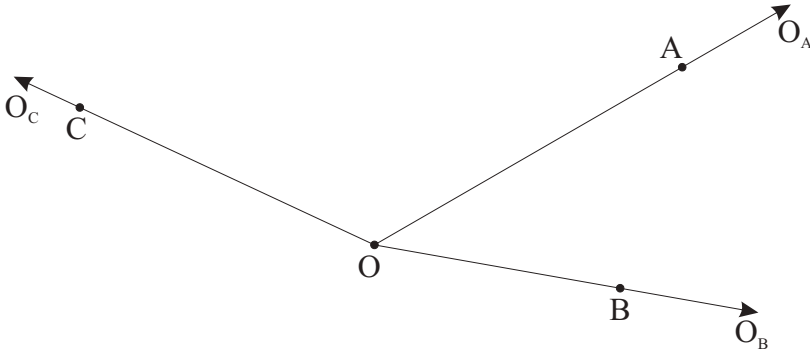

Figure 1.38: If C lies outside $\angle AOB$, O_C lies outside $\angle AOB$: $O_C \subset \text{Ext}\angle AOB$.

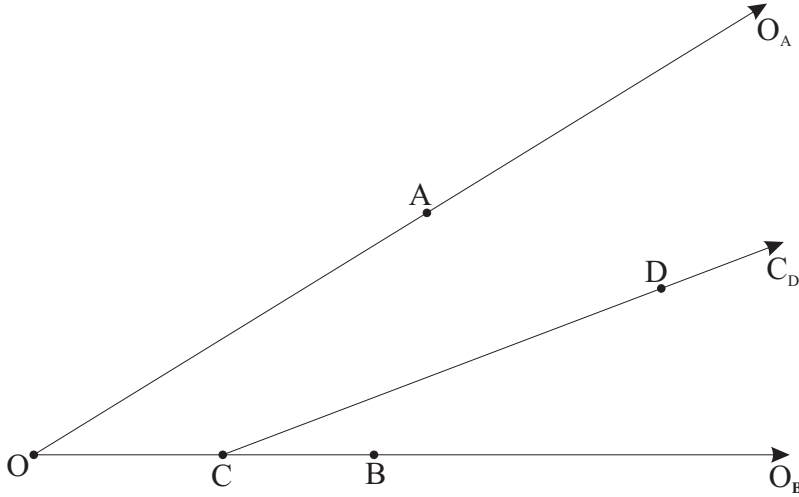

Figure 1.39: Suppose that $C \in O_B$, $D \in \text{Int}\angle AOB$, and $C_D \cap O_A = \emptyset$. Then $C_D \subset \text{Int}\angle AOB$.

Proof. (See Fig. 1.39.) $O \in \alpha_{AOB} \& C \in \text{Int}\angle AOB \subset \alpha_{AOB} \xrightarrow{\text{A1.1.6}} a_{OC} \subset \alpha_{AOB} \Rightarrow O_C \subset \alpha_{AOB}$. $O_C \cap \mathcal{P}_{\angle AOB} = \emptyset$, because $C \neq O$ and $O_C \cap O_A \neq \emptyset \vee O_C \cap O_B \neq \emptyset \xrightarrow{\text{L1.2.11.4}} O_C = O_A \vee O_C = O_B \Rightarrow C \in O_A \vee C \in O_B$ - a contradiction. $O_C \cap \text{Int}\angle AOB = \emptyset$, because if $D \in O_C \cap \text{Int}\angle AOB$, we would have $O_D = O_C$ from L 1.2.11.3 and $O_D \subset \text{Int}\angle AOB$, whence $C \in \text{Int}\angle AOB$ - a contradiction. Finally, $O_C \subset \alpha_{AOB} \& O_C \cap \mathcal{P}_{\angle AOB} = \emptyset \& O_C \cap \text{Int}\angle AOB = \emptyset \Rightarrow O_C \subset \text{Ext}\angle AOB$. \square

Lemma 1.2.21.6. *Given an angle $\angle AOB$, if a point C lies either inside $\angle AOB$ or on its side O_A , and a point D either inside $\angle AOB$ or on its other side O_B , the open interval (CD) lies completely inside $\angle AOB$, that is, $(CD) \subset \text{Int}\angle AOB$.*

Proof. $C \in \text{Int}\angle AOB \cup O_A \& D \in \text{Int}\angle AOB \cup O_B \Rightarrow C \in ((a_{OA})_B \cap (a_{OB})_A) \cup O_A \& D \in ((a_{OA})_B \cap (a_{OB})_A) \cup O_B \Rightarrow C \in ((a_{OA})_B \cup O_A) \cap ((a_{OB})_A \cup O_A) \& D \in ((a_{OA})_B \cup O_B) \cap ((a_{OB})_A \cup O_B)$. Since, by L 1.2.19.8, $O_A \subset (a_{OB})_A$ and $O_B \subset (a_{OA})_B$, we have $(a_{OB})_A \cup O_A = (a_{OB})_A$, $(a_{OA})_B \cup O_B = (a_{OA})_B$, and, consequently, $C \in (a_{OA})_B \cup O_A \& C \in (a_{OB})_A \& D \in (a_{OA})_B \& D \in (a_{OB})_A \cup O_B \xrightarrow{\text{L1.2.19.9}} (CD) \subset (a_{OA})_B \& (CD) \subset (a_{OB})_A \Rightarrow O_C \subset \text{Int}\angle AOB$. \square

The lemma L 1.2.21.6 implies that the interior of an angle is a convex point set.

Lemma 1.2.21.7. *Suppose that a point C lies on the side O_B of an angle $\angle AOB$, a point D lies inside the angle $\angle AOB$, and the ray C_D does not meet the ray O_A . Then the ray C_D lies completely inside the angle $\angle AOB$.*

Proof. (See Fig. 1.39.) By definition of interior, $D \in \text{Int}\angle AOB \Rightarrow DO_A a_{OB} \& DO_B a_{OA}$. Then by hypothesis and T 1.2.19 we have $O_A C_D a_{OB} \& O_B C_D a_{OA}$.⁷⁷ Hence the result follows from the definition of interior. \square

Lemma 1.2.21.8. *Suppose that a point E of a ray C_D lies inside an angle $\angle AOB$, and the ray C_D has no common points with the contour $\mathcal{P}_{\angle AOB}$ of the angle $\angle AOB$, i.e. we have $C_D \cap O_A = \emptyset$, $C_D \cap O_B = \emptyset$, $O \notin C_D$. Then the ray C_D lies completely inside the angle $\angle AOB$.*

Proof. Follows from the definition of interior and T 1.2.19.⁷⁸ \square

⁷⁷By hypothesis, $C_D \cap O_A = \emptyset$. Note also that the ray C_D cannot meet the ray O_A , for they lie on opposite sides of the line a_{OB} .

⁷⁸See proof of the preceding lemma. Note that L 1.2.21.4, L 1.2.21.7 can be viewed as particular cases of the present lemma.

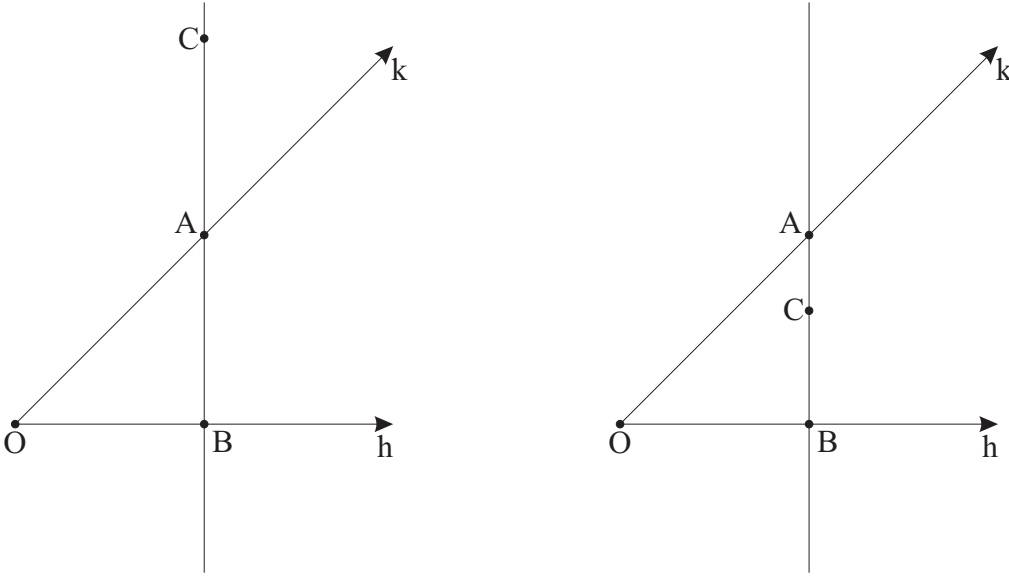

Figure 1.40: Illustration for proof of L 1.2.21.9.

Lemma 1.2.21.9. *Given an angle $\angle(h, k)$ and points $A \in h$, $B \in k$ on its sides, any point C lying on the line a_{AB} inside $\angle(h, k)$ will lie between A , B .*

Proof. Since the points A , B , C colline (by hypothesis) and are obviously distinct ($\mathcal{P}_{\angle(h, k)} \cap \text{Int}\angle(h, k) = \emptyset$), from T 1.2.2 we see that either $[CAB]$, or $[ABC]$, or $[ACB]$. Note that $[CAB]$ (see Fig. 1.40, a)) would imply that the points C , B lie on opposite sides of the line \bar{k} , which, in view of the definition of interior of the angle $\angle(h, k)$ would contradict the fact that the point C lies inside $\angle(h, k)$ (by hypothesis). The case $[ACB]$ is similarly brought to contradiction.⁷⁹ Thus, we see that $[ABC]$, as required (see Fig. 1.40, b)). \square

Lemma 1.2.21.10. *Given an angle $\angle(h, k)_O$ and a point C inside it, for any points D on h and F on k , the ray O_C meets the open interval (DF) .*

Proof. (See Fig. 1.41.) By A 1.2.2 $\exists G [DOG]$. By L 1.2.1.3 $a_{GD} = a_{OD} = \bar{h}$. Since $F \in k$, using definition of $\angle(h, k)$ we conclude that $F \notin \bar{h}$. By C 1.1.2.3 $\neg \exists b (D \in b \& G \in b \& F \in b)$. Therefore $\exists \alpha_{DGF}$ by A 1.1.4. $D \in \bar{h} \& G \in \bar{h} \& F \in \bar{k} \& \bar{h} \subset \alpha_{\angle(h, k)} \& \bar{k} \subset \alpha_{\angle(h, k)} \Rightarrow D \in \alpha_{\angle(h, k)} \& G \in \alpha_{\angle(h, k)} \& \alpha_{\angle(h, k)} \xrightarrow{A1.1.5} \alpha_{DGF} = \alpha_{\angle(h, k)}$. $O \in \alpha_{\angle(h, k)} \& C \in \text{Int}\angle(h, k) \subset \alpha_{\angle(h, k)} \xrightarrow{A1.1.5} a_{OC} \subset \alpha_{\angle(h, k)}$. We also have $D \notin a_{OC}$, $G \notin a_{AC}$, $F \notin a_{OC}$, because otherwise by A 1.1.2 $a_{OC} = \bar{h} \vee a_{OC} = \bar{k} \Rightarrow C \in \bar{h} \vee C \in \bar{k}$, whence, taking note that $\mathcal{P}_{\bar{h}} = h \cup \{O\} \cup h^c$ and $\mathcal{P}_{\bar{k}} = k \cup \{O\} \cup k^c$, we get $C \in \mathcal{P}_{\alpha_{\angle(h, k)}} \cup \text{Ext}\angle(h, k) \Rightarrow C \notin \text{Int}\angle(h, k)$ - a contradiction. Since $C \in \text{Int}\angle(h, k) \xrightarrow{L1.2.21.6, L1.2.21.4} O_C \subset \text{Int}\angle(h, k) \& O_C^c \subset \text{Int}\angle(h^c, k^c)$, $F \in k \& G \in h^c \xrightarrow{L1.2.21.6} (GF) \subset \text{Int}\angle(h, k^c)$, we have $\text{Int}\angle(h, k) \cap \text{Int}\angle(h^c, k) = \emptyset \& \text{Int}\angle(h^c, k^c) \cap \text{Int}\angle(h^c, k) = \emptyset \& O \notin \text{Int}\angle(h^c, k) \Rightarrow (GF) \cap O_C = \emptyset \& (GF) \cap O_C^c = \emptyset \& O \notin (GF)$. Taking into account $\mathcal{P}_{a_{OC}} = O_C \cup \{O\} \cup O_C^c$, we conclude that $(GF) \cap a_{OC} = \emptyset$. $a_{OC} \subset \alpha_{DGF} \& D \notin a_{OC} \& G \notin a_{OC} \& F \notin a_{OC} \& [DOG] \& (GF) \cap a_{OC} = \emptyset \xrightarrow{A1.2.4} \exists E E \in a_{OC} \& [DEF]$. $[DEF] \& D \in h \& F \in k \xrightarrow{L1.2.21.6} E \in \text{Int}\angle(h, k)$. Since $O \notin \text{Int}\angle(h, k) \Rightarrow E \neq O$, $O_C^c \subset \angle(h, k) \Rightarrow O_C^c \cap \text{Int}\angle(h, k) = \emptyset$, we conclude that $E \in O_C$. \square

An angle is said to be adjacent to another angle (assumed to lie in the same plane) if it shares a side and vertex with that angle, and the remaining sides of the two angles lie on opposite sides of the line containing their common side. This relation being obviously symmetric, we can also say the two angles are adjacent to each other. We shall denote any angle, adjacent to a given angle $\angle(h, k)$, by $\text{adj}\angle(h, k)$. Thus, we have, by definition, $\angle(k, m) = \text{adj}\angle(h, k)$ ⁸⁰ and $\angle(l, h) = \text{adj}\angle(h, k)$ if hkm and lhk , respectively. (See Fig. 1.43.)

Corollary 1.2.21.11. *If a point B lies inside an angle $\angle AOC$, the angles $\angle AOB$, $\angle BOC$ are adjacent.*⁸¹

⁷⁹The contradiction for $[ABC]$ is immediately apparent if we make the simultaneous substitutions $A \leftrightarrow B$, $h \leftrightarrow k$. Thus, due to symmetry inherent in the properties of the betweenness relations both for intervals and angles, we do not really need to consider this case separately.

⁸⁰Of course, by writing $\angle(k, m) = \text{adj}\angle(h, k)$ we do not imply that $\angle(k, m)$ is the only angle adjacent to $\angle(h, k)$. It can be easily seen that in reality there are infinitely many such angles. The situation here is analogous to the usage of the symbols o and O in calculus (used particularly in the theory of asymptotic expansions).

⁸¹In particular, if a ray k , equioriginal with rays h , l , lies inside the angle $\angle(h, l)$, then the angles $\angle(h, k)$, $\angle(k, l)$ are adjacent and thus the rays h , l lie on opposite sides of the ray k .

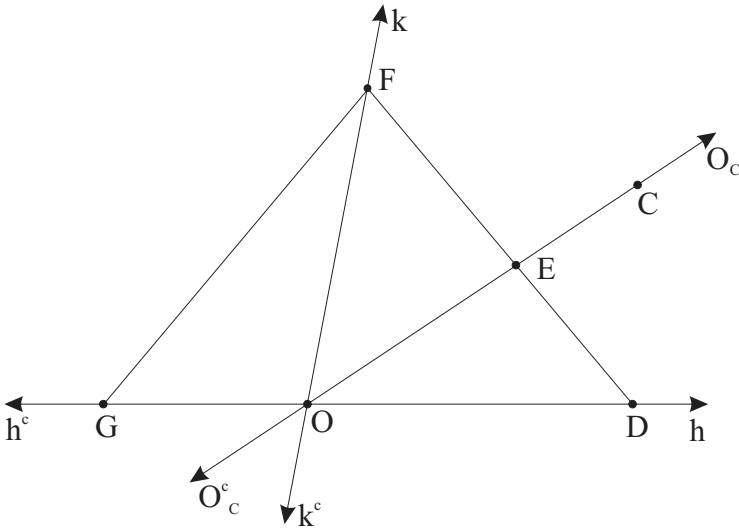

Figure 1.41: Given $\angle(h, k)_O$ and a point C inside it, for any points D on h and F on k , O_C meets (DF) .

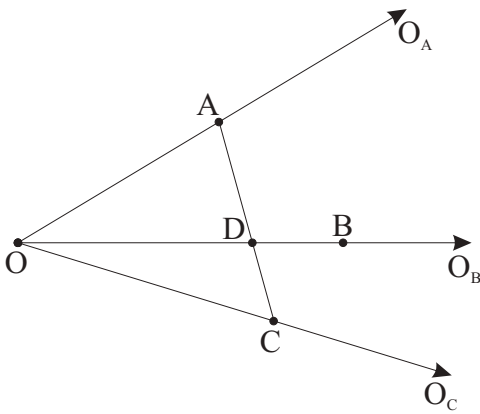

Figure 1.42: If a point B lies inside an angle $\angle AOC$, the angles $\angle AOB$, $\angle BOC$ are adjacent.

Proof. $B \in \text{Int}\angle AOC \stackrel{\text{L1.2.21.10}}{\implies} \exists D \ D \in O_B \ \& \ [ADC]$. Since $D \in a_{OB} \cap (AC)$, $A \notin a_{OB}$, we see that the points A , C , and thus the rays O_A , O_C (see T 1.2.20) lie on opposite sides of the line a_{OB} . Together with the fact that the angles $\angle AOB$, $\angle BOC$ share the side O_B this means that $\angle AOB$, $\angle BOC$ are adjacent. \square

From the definition of adjacency of angles and the definitions of the exterior and interior of an angle immediately follows

Lemma 1.2.21.12. *In an angle $\angle(k, m)$, adjacent to an angle $\angle(h, k)$, the side m lies outside $\angle(h, k)$.*

which, together with C 1.2.21.11, implies the following corollary

Corollary 1.2.21.13. *If a point B lies inside an angle $\angle AOC$, neither the ray O_C has any points inside or on the angle $\angle AOB$, nor the ray O_A has any points inside or on $\angle BOC$.*

Lemma 1.2.21.14. *If angles $\angle(h, k)$, $\angle(k, m)$ share the side k , and points $A \in h$, $B \in m$ lie on opposite sides of the line \bar{k} , the angles $\angle(h, k)$, $\angle(k, m)$ are adjacent to each other.*

Proof. Immediately follows from L 1.2.11.15. \square

An angle $\angle(k, l)$ is said to be adjacent supplementary to an angle $\angle(h, k)$, written $\angle(k, l) = \text{adjsp}\angle(h, k)$, iff the ray l is complementary to the ray h . That is, $\angle(k, l) = \text{adjsp}\angle(h, k) \stackrel{\text{def}}{\iff} l = h^c$. Since, by L 1.2.15.3, the ray $(h^c)^c$, complementary to the ray h^c , complementary to the given ray h , coincides with the ray h : $(h^c)^c = h$, if $\angle(k, l)$ is adjacent supplementary to $\angle(h, k)$, the angle $\angle(h, k)$ is, in its turn, adjacent supplementary to the angle $\angle(k, l)$. Note also that, in a frequently encountered situation, given an angle $\angle AOC$ such that the point O lies between the point A and some other point B , the angle $\angle BOC$ is adjacent supplementary to the angle $\angle AOC$.⁸²

Lemma 1.2.21.15. *Given an angle $\angle(h, k)$, any point lying in plane of this angle on the same side of the line \bar{h} as the ray k , lies either inside the angle $\angle(h, k)$, or inside the angle $\angle(k, h^c)$, or on the ray k (See Fig. 1.44.) That is,*

⁸²For illustration on a particular case of this situation, see Fig. 1.113, a).

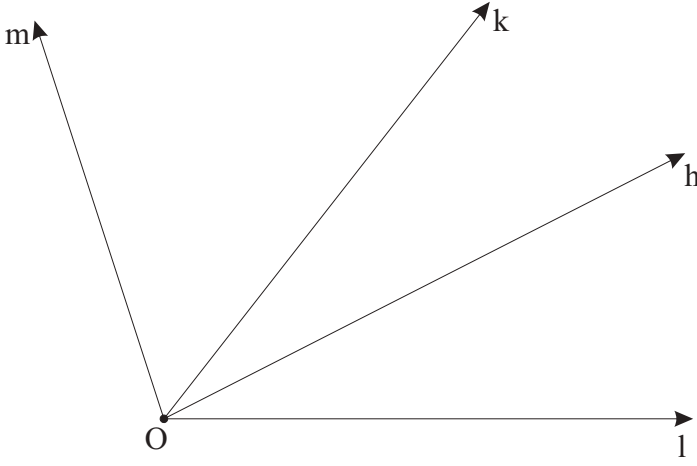

Figure 1.43: Angles $\angle(l, h)$ and $\angle(k, m)$ are adjacent to the angle $\angle(h, k)$. Note that h, m lie on opposite sides of \bar{k} and l, k lie on opposite sides of \bar{h} .

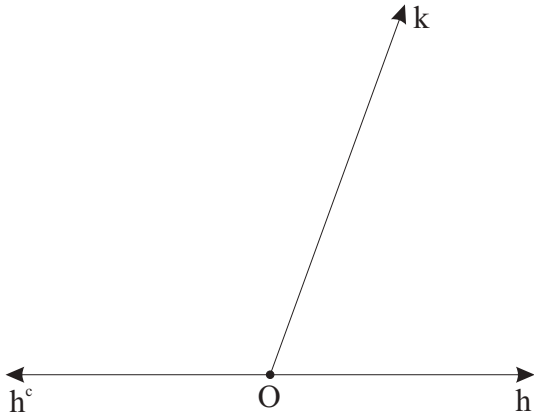

Figure 1.44: Any point lying in plane of $\angle(h, k)$ on one side of \bar{h} with k , lies either inside $\angle(h, k)$, or inside $\angle(k, h^c)$, or on k .

$\bar{h}_k = \text{Int}\angle(h, k) \cup k \cup \text{Int}\angle(k, h^c)$. Furthermore, any point lying in the plane $\alpha_{\angle(h, k)}$ (of the angle $\angle(h, k)$) not on either of the lines \bar{h}, \bar{k} lies inside one and only one of the angles $\angle(h, k), \angle(h^c, k), \angle(h, k^c), \angle(h^c, k^c)$.

Proof. $\bar{h}_k = \bar{h}_k \cap \mathcal{P}_{\alpha_{\angle(h, k)}} = \bar{h}_k \cap (\bar{k}_h \cup \mathcal{P}_{\bar{k}} \cup \bar{k}_h^c) \stackrel{\text{L1.2, 19.8}}{=} \bar{h}_k \cap (\bar{k}_h \cup \mathcal{P}_{\bar{k}} \cup \bar{k}_{h^c}) = (\bar{h}_k \cap \bar{k}_h) \cup (\bar{h}_k \cap \mathcal{P}_{\bar{k}}) \cup (\bar{h}_k \cap \bar{k}_{h^c}) = \text{Int}\angle(h, k) \cup k \cap \text{Int}\angle(k, h^c)$. Similarly, $\bar{h}_{k^c} = \text{Int}\angle(h, k^c) \cup k^c \cap \text{Int}\angle(k^c, h^c)$, whence the second part. \square

Given an angle $\angle(h, k)$, the angle $\angle(h^c, k^c)$, formed by the rays h^c, k^c , complementary to h, k , respectively, is called (the angle) vertical, or opposite, to $\angle(h, k)$. We write $\text{vert}\angle(h, k) \doteq \angle(h^c, k^c)$. Obviously, the angle $\text{vert}(\text{vert}\angle(h, k))$, opposite to the opposite $\angle(h^c, k^c)$ of a given angle $\angle(h, k)$, coincides with the angle $\angle(h, k)$.

Lemma 1.2.21.16. *If a point C lies inside an angle $\angle(h, k)$, the ray O_C^c , complementary to the ray O_C , lies inside the vertical angle $\angle(h^c, k^c)$.*

Proof. (See Fig. 1.45.) $C \in \text{Int}\angle(h, k) \Rightarrow C \in \bar{h}_k \cap \bar{k}_h \stackrel{\text{L1.2, 19.8}}{\Rightarrow} O_C^c \subset \bar{h}_k^c \cap \bar{k}_h^c \Rightarrow O_C^c \subset \bar{h}_{k^c} \cap \bar{k}_{h^c} \Rightarrow O_C^c \subset \text{Int}\angle(h^c, k^c)$. \square

Lemma 1.2.21.17. *Given an angle $\angle(h, k)$, all points lying either inside or on the sides h^c, k^c of the angle opposite to it, lie outside $\angle(h, k)$.*⁸³

Proof. \square

Lemma 1.2.21.18. *For any angle $\angle AOB$ there is a point C ⁸⁴ such that the ray O_B lies inside the angle $\angle AOC$.*⁸⁵

⁸³Obviously, this means that none of the interior points of $\angle(h^c, k^c)$ can lie inside $\angle(h, k)$.

⁸⁴and, consequently, a ray O_C

⁸⁵This lemma is an analogue of A 1.2.2.

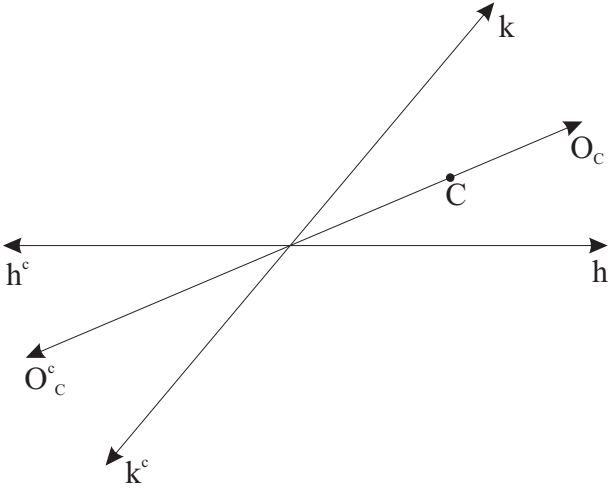

Figure 1.45: If C lies inside $\angle(h, k)$, the ray O_C^c lies inside the vertical angle $\angle(h^c, k^c)$.

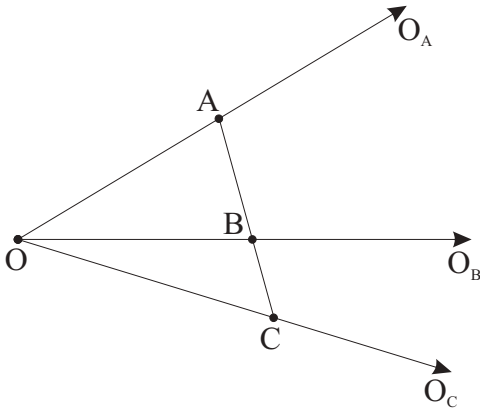

Figure 1.46: For any angle $\angle AOB$ there is a point C such that O_B lies inside $\angle AOC$. For any angle $\angle AOC$ there is a point B such that O_B lies inside $\angle AOC$.

Proof. (See Fig. 1.46.) By A 1.2.2 $\exists C [ABC]$. $C \notin a_{OA}$, because otherwise $[ABC] \xrightarrow{A1.2.1} A \neq C \xrightarrow{A1.1.2} a_{AC} = a_{OA} \xrightarrow{L1.2.1.3} B \in a_{OA}$, contrary to L 1.2.21.2. ⁸⁶ Therefore, $\exists \angle AOC$. Since $[ABC]$, by L 1.2.21.2, L 1.2.21.6, L 1.2.21.4 $O_B \subset \text{Int}\angle AOC$. \square

Lemma 1.2.21.19. For any angle $\angle AOC$ there is a point B such that the ray O_B lies inside the angle $\angle AOC$. ⁸⁷

Proof. (See Fig. 1.46.) By T 1.2.2 $\exists B [ABC]$. By L 1.2.21.6, L 1.2.21.4 $O_B \subset \text{Int}\angle AOC$. \square

Lemma 1.2.21.20. Given an angle $\angle(h, k)$, all points inside any angle $\angle(k, m)$ adjacent to it, lie outside $\angle(h, k)$.⁸⁸

Proof. (See Fig. 1.47.) By definition of the interior, $A \in \text{Int}\angle(k, m) \Rightarrow A \in \text{Am}\bar{k}$. By the definition of adjacency $\angle(k, m) = \text{adj}(h, k) \Rightarrow h\bar{k}m$. $\text{Am}\bar{k} \& h\bar{k}m \xrightarrow{L1.2.18.5} A\bar{k}h \Rightarrow A \in \text{Ext}\angle(h, k)$. \square

Lemma 1.2.21.21. 1. If points B, C lie on one side of a line a_{OA} , and $O_B \neq O_C$, either the ray O_B lies inside the angle $\angle AOC$, or the ray O_C lies inside the angle $\angle AOB$. 2. Furthermore, if a point E lies inside the angle $\angle BOC$, it lies on the same side of a_{OA} as B and C . That is, $\text{Int}\angle BOC \subset (a_{OA})_B = (a_{OA})_C$.

Proof. 1. Denote $O_D \doteq O_A^c$. (See Fig. 1.48.) $BCa_{OA} \xrightarrow{T1.2.19} O_B O_C a_{OA}$. $O_B O_C a_{OA} \& O_B \neq O_C \xrightarrow{L1.2.21.15} O_C \subset \text{Int}\angle AOB \vee O_C \subset \text{Int}\angle BOD$. ⁸⁹ Suppose $O_C \subset \text{Int}\angle BOD$. ⁹⁰ Then by L 1.2.21.12 $O_B \subset \text{Ext}\angle COD$. But since $O_B O_C a_{OA} \& O_B \neq O_C \xrightarrow{L1.2.21.15} O_B \subset \text{Int}\angle AOC \vee O_B \subset \text{Int}\angle COD$, we conclude that $O_B \subset \text{Int}\angle AOC$. 2. $E \in \text{Int}\angle BOC \xrightarrow{L1.2.21.10} \exists F F \in O_E \cap (BC)$. Hence by L 1.2.19.6, L 1.2.19.8 we have $O_E \subset (a_{OA})_B = (a_{OA})_C$, q.e.d. \square

⁸⁶ According to L 1.2.21.2, $B \in a_{OA}$ contradicts the fact that the rays O_A, O_B form an angle.

⁸⁷ This lemma is analogous to T 1.2.2. In the future the reader will encounter many such analogies.

⁸⁸ Obviously, this means that given an angle $\angle(h, k)$, none of the interior points of an angle $\angle(k, m)$ adjacent to it, lies inside $\angle(h, k)$.

⁸⁹ The lemma L 1.2.21.15 is applied here to every point of the ray O_C .

⁹⁰ If $O_C \subset \text{Int}\angle AOB$ we have nothing more to prove.

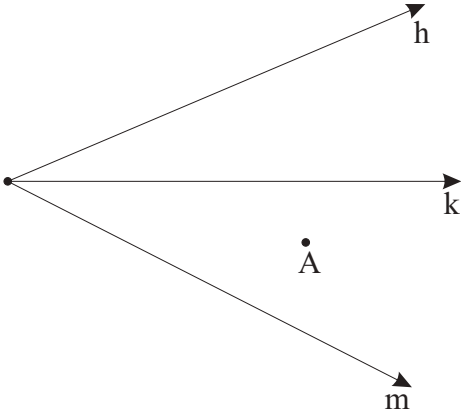

Figure 1.47: Given an angle $\angle(h, k)$, all points inside any angle $\angle(k, m)$ adjacent to it, lie outside $\angle(h, k)$.

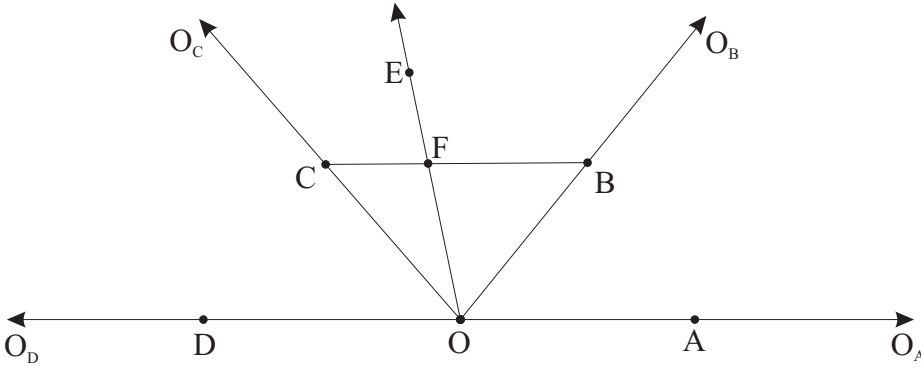

Figure 1.48: If points B, C lie on one side of a_{OA} , and $O_B \neq O_C$, either O_B lies inside $\angle AOC$, or O_C lies inside $\angle AOB$.

Lemma 1.2.21.22. *If a ray l with the same initial point as rays h, k lies inside the angle $\angle(h, k)$ formed by them, then the ray k lies inside the angle $\angle(h^c, l)$.*

Proof. Using L 1.2.21.20, L 1.2.21.15 we have $l \subset \text{Int}\angle(h, k) \Rightarrow k \subset \text{Ext}\angle(h, l) \& lk\bar{h} \& l \neq k \Rightarrow k \subset \text{Int}\angle(h^c, l)$. \square

Lemma 1.2.21.23. *If open intervals (AF) , (EB) meet in a point G and there are three points in the set $\{A, F, E, B\}$ known not to colline, the ray E_B lies inside the angle $\angle AEF$.*⁹¹

Proof. C 1.2.9.14 ensures that A, E, F do not colline, so by L 1.2.21.2 $\angle AEF$ exists. $[EGB] \stackrel{\text{L1.2.11.13}}{\implies} G \in E_B$. By L 1.2.21.6, L 1.2.21.4 we have $G \in E_B \& [AGF] \& A \in E_A \& F \in E_F \Rightarrow E_B \subset \text{Int}\angle AEF$. \square

Corollary 1.2.21.24. *If open intervals (AF) , (EB) meet in a point G and there are three points in the set $\{A, F, E, F\}$ known not to colline, the points E, F lie on the same side of the line a_{AB} .*⁹²

Proof. Observe that by definition of the interior of $\angle EAB$, we have $A_F \subset \text{Int}\angle EAB \Rightarrow EF a_{AB}$. \square

Corollary 1.2.21.25. *If open intervals (AF) , (EB) concur in a point G , the ray E_B lies inside the angle $\angle AEF$.*⁹³

Proof. Immediately follows from L 1.2.9.13, L 1.2.21.23. \square

Corollary 1.2.21.26. *If open intervals (AF) , (EB) concur in a point G , the points E, F lie on the same side of the line a_{AB} .*⁹⁴

Proof. Immediately follows from L 1.2.9.13, C 1.2.21.24. \square

⁹¹And, by the same token (due to symmetry), the ray B_E lies inside the angle $\angle ABF$, the ray A_F lies inside lies inside the angle $\angle EAB$, and the ray F_A lies inside the angle $\angle EFB$.

⁹²Again, due to symmetry, we can immediately conclude that the points A, B also lie on the same side of the line a_{EF} , etc.

⁹³And, of course, the ray B_E lies inside the angle $\angle ABF$, the ray A_F lies inside lies inside the angle $\angle EAB$, and the ray F_A lies inside the angle $\angle EFB$.

⁹⁴Again, A, B also lie on the same side of the line a_{EF} , etc.

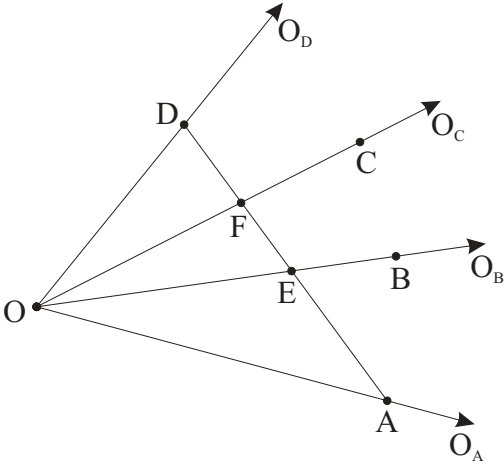

Figure 1.49: If C lies inside $\angle AOD$, and B inside an angle $\angle AOC$, then O_B lies inside $\angle AOD$, and O_C inside $\angle BOD$.

Lemma 1.2.21.27. *If a point C lies inside an angle $\angle AOD$, and a point B inside an angle $\angle AOC$, then the ray O_B lies inside the angle $\angle AOD$, and the ray O_C lies inside the angle $\angle BOD$. In particular, if a point C lies inside an angle $\angle AOD$, any point lying inside $\angle AOC$, as well as any point lying inside $\angle COD$ lies inside $\angle AOD$. That is, we have $Int\angle AOC \subset Int\angle AOD$, $Int\angle COD \subset Int\angle AOD$.⁹⁵*

Proof. (See Fig. 1.49.) $C \in Int\angle AOD \stackrel{L1.2.21.10}{\implies} \exists F [AFD] \& F \in O_C$. $B \in Int\angle AOC \stackrel{L1.2.21.10}{\implies} \exists E [AEF] \& E \in O_B$. $[AEF] \& [AFD] \stackrel{L1.2.3.2}{\implies} [AED] \& [EFD]$. Hence, using L 1.2.21.6, L 1.2.21.4, we can write $A \in O_A \& E \in O_B \& F \in O_C \& D \in O_D \& [AED] \& [EFD] \Rightarrow O_B \subset Int\angle AOD \& O_C \subset Int\angle BOD$. \square

Lemma 1.2.21.28. *Given a point C inside an angle $\angle AOD$, any point B lying inside $\angle AOD$ not on the ray O_C lies either inside the angle $\angle AOC$ or inside $\angle COD$.⁹⁶*

Proof. $C \in Int\angle AOD \stackrel{L1.2.21.10}{\implies} \exists E E \in O_C \cap (AD)$. $B \in Int\angle AOD \stackrel{L1.2.21.10}{\implies} \exists F F \in O_B \cap (AD)$. $B \notin O_C \Rightarrow O_B \not\subset O_C \stackrel{L1.2.11.4}{\implies} O_B \cap O_C = \emptyset \Rightarrow F \neq E$. $F \in (AD) \& F \neq E \stackrel{T1.2.5}{\implies} F \in (AE) \vee F \in (ED)$. Thus, we have $F \in O_B \cap (AE) \vee F \in O_B \cap (ED) \Rightarrow O_B \subset Int\angle AOC \vee O_B \subset Int\angle COD$, q.e.d. \square

Lemma 1.2.21.29. *If a ray O_B lies inside an angle $\angle AOC$, the ray O_C lies inside $\angle BOD$, and at least one of the rays O_B, O_C lies on the same side of the line a_{OA} as the ray O_D , then the rays O_B, O_C both lie inside the angle $\angle AOD$.*

Proof. Note that we can assume $O_B O_D a_{OA}$ without any loss of generality, because by the definition of the interior of an angle $O_B \subset Int\angle AOC \Rightarrow O_B O_C a_{OA}$, and if $O_C O_D a_{OA}$, we have $O_B O_C a_{OA} \& O_C O_D a_{OA} \stackrel{L1.2.18.2}{\implies} O_B O_D a_{OA}$. $O_B O_D a_{OA} \& O_B \neq O_D \stackrel{L1.2.21.21}{\implies} O_B \subset Int\angle AOD \vee O_D \subset Int\angle AOB$. If $O_B \subset Int\angle AOD$ (see Fig. 1.50, a)), by L 1.2.21.27 we immediately obtain $O_C \subset Int\angle AOD$. But if $O_D \subset Int\angle AOB$ (see Fig. 1.50, b)), observing that $O_B \subset Int\angle AOC$, we have by the same lemma $O_B \subset Int\angle DOC$, which, by C 1.2.21.13, contradicts $O_C \subset Int\angle BOD$. \square

Lemma 1.2.21.30. *Suppose that a finite sequence of points A_i , where $i \in \mathbb{N}_n$, $n \geq 3$, has the property that every point of the sequence, except for the first and the last, lies between the two points with adjacent (in \mathbb{N}) numbers. Suppose, further, that a point O lies outside the line $a = A_1 A_n$ ⁹⁷ Then the rays $O_{A_1}, O_{A_2}, \dots, O_{A_n}$ are in order $[O_{A_1} O_{A_2} \dots O_{A_n}]$, that is, $O_{A_j} \subset Int\angle A_i O A_k$ whenever either $i < j < k$ or $k < j < i$.*

Proof. (See Fig. 1.51.) Follows from L 1.2.7.3, L 1.2.21.6, L 1.2.21.4. \square

⁹⁵L 1.2.21.4 implies that any other point of the ray O_C can enter this condition in place of C , so instead of "If a point $C \dots$ " we can write "if some point of the ray $O_C \dots$ "; the same holds true for the ray O_B and the angle $\angle AOC$. Note that, for example, L 1.2.21.16, L 1.2.21.10, L 1.2.21.21 also allow similar reformulation, which we shall refer to in the future to avoid excessive mentioning of L 1.2.11.3. Observe also that we could equally well have given for this lemma a formulation apparently converse to the one presented here: If a point B lies inside an angle $\angle AOD$, and a point C lies inside the angle $\angle BOD$ (the comments above concerning our ability to choose instead of B and C any other points of the rays O_B and O_C , respectively being applicable here as well), the ray O_C lies inside the angle $\angle AOD$, and the ray O_B lies inside the angle $\angle AOC$. This would make L 1.2.21.27 fully analogous to L 1.2.3.2. But now we don't have to devise a proof similar to that given at the end of L 1.2.3.2, because it follows simply from the symmetry of the original formulation of this lemma with respect to the substitution $A \rightarrow D, B \rightarrow C, C \rightarrow B, D \rightarrow A$. This symmetry, in its turn, stems from the definition of angle as a non-ordered couple of rays, which entails $\angle AOC = \angle COA, \angle AOD = \angle DOA$, etc.

⁹⁶Summing up the results of L 1.2.21.4, L 1.2.21.27, and this lemma, given a point C inside an angle $\angle AOD$, we can write $Int\angle AOD = Int\angle AOC \cup O_C \cup Int\angle COD$.

⁹⁷Evidently, in view of L 1.1.1.4 the line a is defined by any two distinct points $A_i, A_j, i \neq j, i, j \in \mathbb{N}$, i.e. $a = a_{A_i A_j}$.

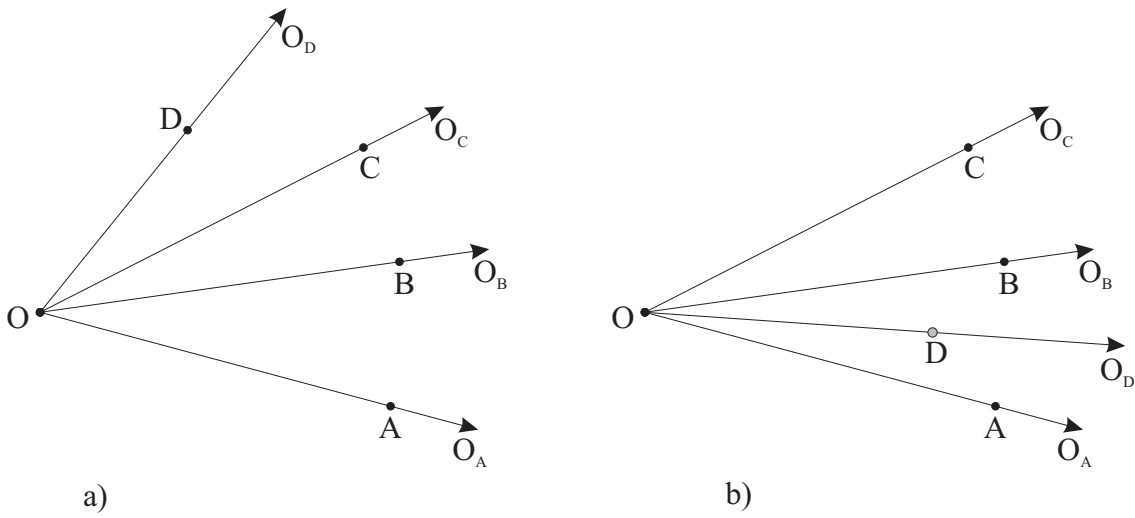

Figure 1.50: If O_B lies inside $\angle AOC$, O_C lies inside $\angle BOD$, and at least one of O_B , O_C lies on the same side of the line a_{OA} as O_D , then O_B , O_C both lie inside $\angle AOD$.

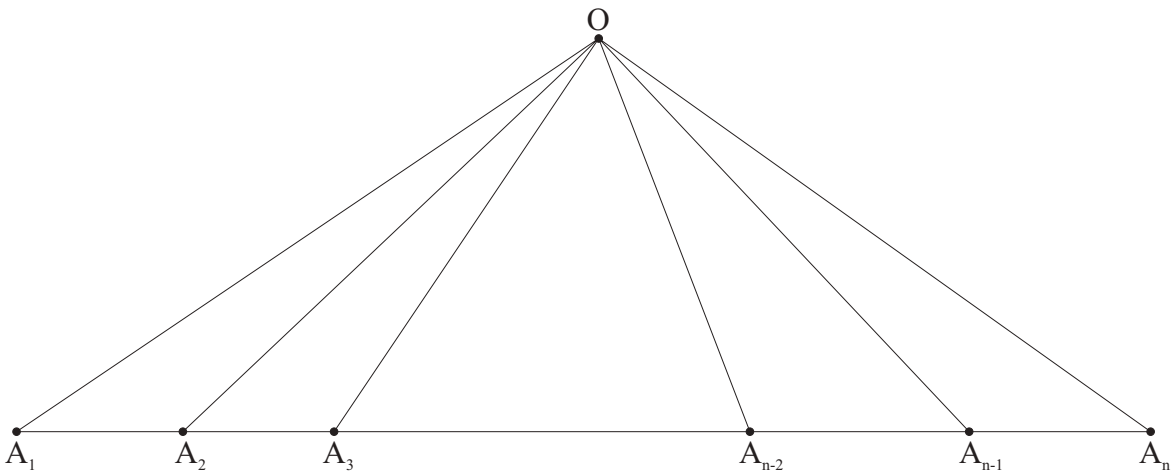

Figure 1.51: Suppose that a finite sequence of points A_i , where $i \in \mathbb{N}_n$, $n \geq 3$, has the property that every point of the sequence, except for the first and the last, lies between the two points with adjacent (in \mathbb{N}) numbers. Suppose, further, that a point O lies outside the line $a = A_1A_n$. Then the rays $O_{A_1}, O_{A_2}, \dots, O_{A_n}$ are in order $[O_{A_1}O_{A_2} \dots, O_{A_n}]$.

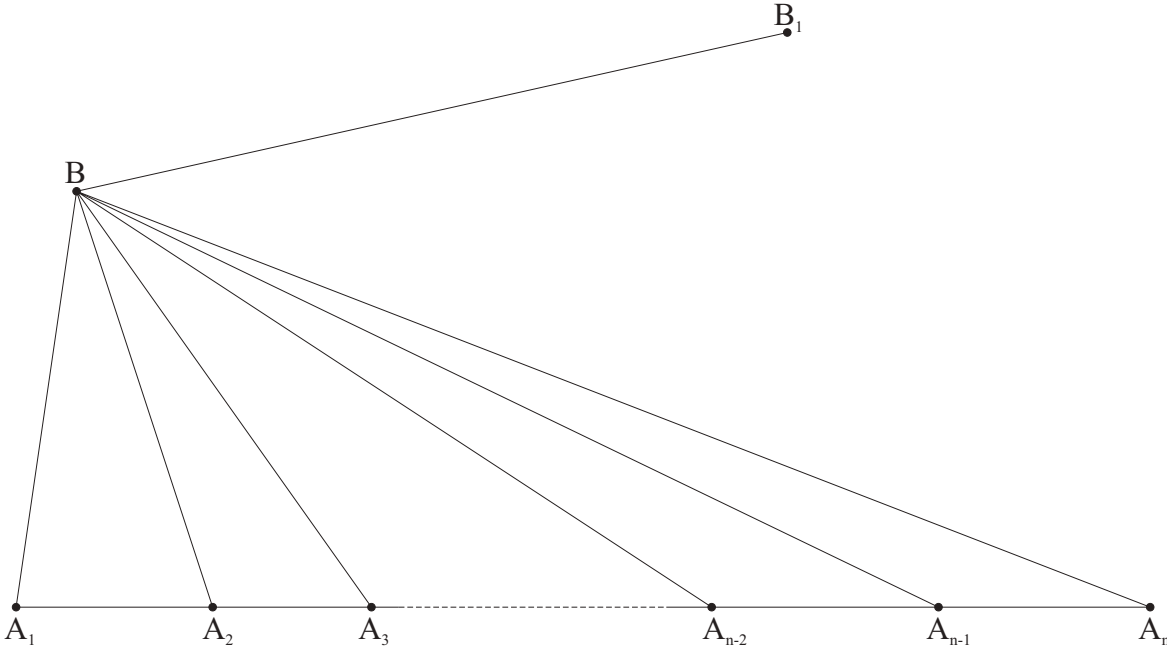

Figure 1.52: Suppose that a finite sequence of points A_i , where $i \in \mathbb{N}_n$, $n \geq 3$, has the property that every point of the sequence, except for the first and the last, lies between the two points with adjacent (in \mathbb{N}) numbers. Suppose, further, that a ray B_{B_1} does not meet the ray A_{1A_2} and that the points A_2, B_1 lie on the same side of the line a_{A_1B} . Then the rays $B_{A_1}, B_{A_2}, \dots, B_{A_n}$ are in order $[B_{A_1}B_{A_2} \dots, B_{A_n}B_{B_1}]$.

Lemma 1.2.21.31. *Suppose that a finite sequence of points A_i , where $i \in \mathbb{N}_n$, $n \geq 3$, has the property that every point of the sequence, except for the first and the last, lies between the two points with adjacent (in \mathbb{N}) numbers. Suppose, further, that a ray B_{B_1} does not meet the ray A_{1A_2} and that the points A_2, B_1 lie on the same side of the line a_{A_1B} . Then the rays $B_{A_1}, B_{A_2}, \dots, B_{A_n}$ are in order $[B_{A_1}B_{A_2} \dots B_{A_n}B_{B_1}]$.*

Proof. (See Fig. 1.52.) Since, by hypothesis, the ray A_{1A_2} , and thus the open interval (A_1A_2) , does not meet the ray B_{B_1} and, consequently, the line a_{BB_1} ,⁹⁸ the points A_1, A_2 lie on the same side of the line a_{BB_1} . Since, by hypothesis, the points A_2, B_1 lie on the same side of the line a_{A_1B} , we have $A_2 \in \text{Int}\angle A_1BB_1$. Hence by L 1.2.21.4 we have $A_i \in \text{Int}\angle A_1BB_1$, where $i \in \{3, 4, \dots, n\}$. This, in turn, by L ?? implies that $B_{A_i} \subset \text{Int}\angle A_1BB_1$, where $i \in \{3, 4, \dots, n\}$. From the preceding lemma (L 1.2.21.30) we know that the rays $B_{A_1}, B_{A_2}, \dots, B_{A_n}$ are in order $[B_{A_1}B_{A_2} \dots B_{A_n}]$. Finally, taking into account $A_i \in \text{Int}\angle A_1BB_1$, where $i \in \{2, 3, 4, \dots, n\}$, and using L 1.2.21.27, we conclude that the rays $B_{A_1}, B_{A_2}, \dots, B_{A_n}$ are in order $[B_{A_1}B_{A_2} \dots B_{A_n}B_{B_1}]$, q.e.d. \square

Lemma 1.2.21.32. *Suppose rays k, l lie on the same side of a line \bar{h} (containing a third ray h), the rays h, l lie on opposite sides of the line \bar{k} , and the points H, L lie on the rays h, l , respectively. Then the ray k lies inside the angle $\angle(h, l)$ and meets the open interval (HL) at some point K .*

Proof. (See Fig. 1.53.) $H \in h \& K \in l \& h\bar{k}l \Rightarrow \exists K \ K \in \bar{k} \& [HKL]$. $[HKL] \& H \in \bar{h} \xrightarrow{\text{L1.2.19.9}} KL\bar{h}$. Hence $K \in k$, for, obviously, $K \neq O$, and, assuming $K \in k^c$, we would have: $k\bar{h} \& k\bar{h}k^c \xrightarrow{\text{L1.2.18.5}} \bar{h}k^c$, which, in view of $L \in l$, $K \in k^c$, would imply $L\bar{h}K$ - a contradiction. Finally, $H \in h \& L \in l \& [HKL] \xrightarrow{\text{L1.2.21.6}} K \in \text{Int}\angle(h, l) \xrightarrow{\text{L1.2.21.4}} k \subset \text{Int}\angle(h, l)$. \square

Lemma 1.2.21.33. *Suppose that the rays h, k, l have the same initial point and the rays h, l lie on opposite sides of the line \bar{k} (so that the angles $\angle(h, k), \angle(k, l)$ are adjacent). Then the rays k, l lie on the same side of the line \bar{h} iff the ray l lies inside the angle $\angle(h^c, k)$, and the rays k, l lie on opposite sides of the line \bar{h} iff the ray h^c lies inside the angle $\angle(k, l)$. Also, the first case takes place iff the ray k lies between the rays h, l , and the second case iff the ray k^c lies between the rays h, l .*

Proof. Note that $l\bar{h} \& h^c\bar{h} \xrightarrow{\text{L1.2.18.4}} h^c\bar{k}$. Suppose first that the rays k, l lie on the same side of the line \bar{h} (see Fig. 1.54, a)). Then we can write $h^c\bar{k} \& k\bar{h}l \Rightarrow l \subset \text{Int}\angle(h^c, k)$. Conversely, from the definition of interior we have $l \subset \text{Int}\angle(h^c, k) \Rightarrow k\bar{h}l$. Suppose now that the rays k, l lie on opposite sides of the line \bar{h} (see Fig. 1.54, b)). Then, obviously, the ray l cannot lie inside the angle $\angle(h^c, k)$, for otherwise k, l would lie on the same side of h . Hence by L 1.2.21.21 we have $h^c \subset \text{Int}\angle(k, l)$. Conversely, if $h^c \subset \text{Int}\angle(k, l)$, the rays k, l lie on opposite sides of the line \bar{l} in

⁹⁸Since the points A_2, B_1 lie on the same side of the line a_{A_1B} , so do rays A_{1A_2}, B_{B_1} (T 1.2.19). Therefore, no point of the ray A_{1A_2} can lie on $B_{B_1}^c$, which lies on opposite side of the line a_{A_1B} .

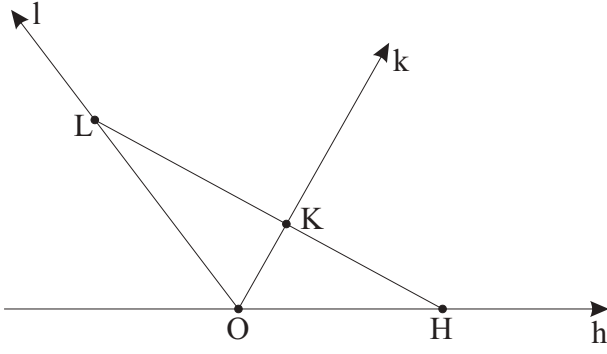

Figure 1.53: Suppose rays k, l lie on the same side of a line \bar{h} (containing a third ray h), the rays h, l lie on opposite sides of the line \bar{k} , and the points H, L lie on the rays h, l , respectively. Then the ray k lies inside the angle $\angle(h, l)$ and meets the open interval (HL) at some point K .

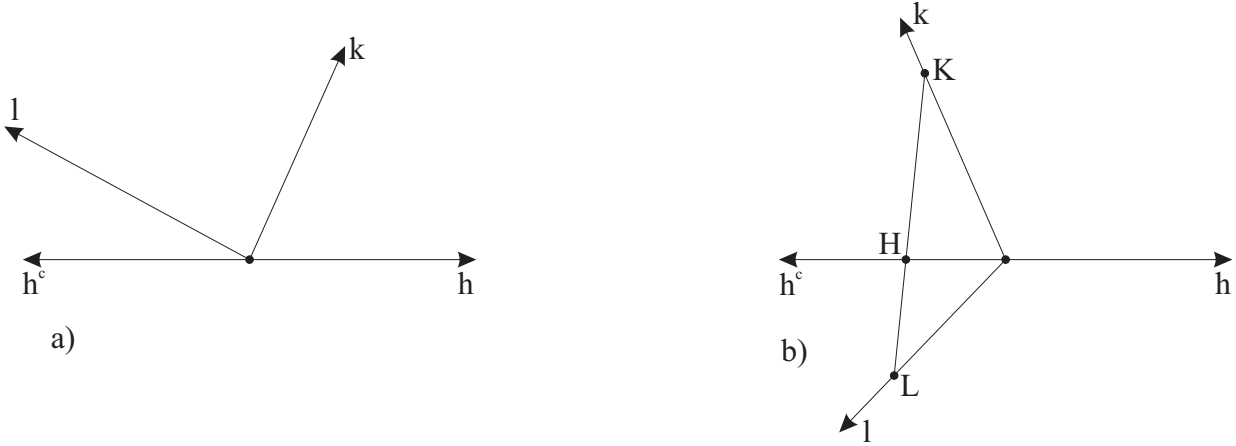

Figure 1.54: Suppose that the rays h, k, l have the same initial point and the rays h, l lie on opposite sides of the line \bar{k} . Then the rays k, l lie on the same side of the line \bar{h} iff the ray l lies inside the angle $\angle(h^c, k)$, and the rays k, l lie on opposite sides of the line \bar{h} iff the ray h^c lies inside the angle $\angle(k, l)$.

view of L 1.2.21.10. ⁹⁹ Concerning the second part, it can be demonstrated using the preceding lemma (L 1.2.21.32) and (in the second case) the observation that $l\bar{h}k \& k^c\bar{h}k \xrightarrow{L1.2.18.4} k^cl\bar{h}$. (See also C 1.2.21.11). \square

Lemma 1.2.21.34. *Suppose that the rays h, k, l have the same initial point O and the rays h, l lie on opposite sides of the line \bar{k} . Then either the ray k lies inside the angle $\angle(h, l)$, or the ray k^c lies inside the angle $\angle(h, l)$, or $l = h^c$. (In the last case we again have either $k \subset \text{Int}\angle(h, h^c)$ or $k^c \subset \text{Int}\angle(h, h^c)$ depending on which side of the line \bar{k} (i.e. which of the two half-planes having the line \bar{k} as its edge) is chosen as the interior of the straight angle $\angle(h, h^c)$).*

Proof. Take points $H \in h, L \in l$. Then $h\bar{k}l$ implies that there is a point $K \in \bar{k}$ such that $[HKL]$. Then, obviously, either $K \in k$, or $K = O$, or $K \in k^c$. If $K = O$ (see Fig. 1.55, a)) then $L \in h^c$ and thus $l = h^c$ (see L 1.2.11.3). If $K \neq O$ (see Fig. 1.55, b), c)) then the points H, O, L are not collinear, the lines \bar{k}, a_{HL} being different (see L 1.2.1.3, T 1.1.1). Thus, $\angle HOL = \angle(h, l)$ exists (see L 1.2.21.1, L 1.2.21.2). Hence by L 1.2.21.6, L 1.2.21.4 we have either $H \in h \& L \in l \& [HKL] \& K \in k \Rightarrow k \subset \text{Int}\angle(h, l)$, or $H \in h \& L \in l \& [HKL] \& K \in k^c \Rightarrow k^c \subset \text{Int}\angle(h, l)$, depending on which of the rays k, k^c the point K belongs to.

Definition and Basic Properties of Generalized Betweenness Relations

We say that a set \mathfrak{J} of certain geometric objects $\mathcal{A}, \mathcal{B}, \dots$ admits a weak ¹⁰⁰ generalized betweenness relation, if there is a ternary relation $\rho \subset \mathfrak{J}^3 = \mathfrak{J} \times \mathfrak{J} \times \mathfrak{J}$, called weak generalized betweenness relation on \mathfrak{J} , whose properties are given by Pr 1.2.1, Pr 1.2.3 – Pr 1.2.7. If $(\mathcal{A}, \mathcal{B}, \mathcal{C}) \subset \rho$, where $\mathcal{A}, \mathcal{B}, \mathcal{C} \in \mathfrak{J}$, where \mathfrak{J} is some set with a weak generalized betweenness relation defined on it, we write $[ABC]^{(\mathfrak{J})}$ or (usually) simply $[ABC]$, ¹⁰¹ and say that the geometric object \mathcal{B} lies in the set \mathfrak{J} between the geometric objects \mathcal{A} and \mathcal{C} , or that \mathcal{B} divides \mathcal{A} and \mathcal{C} .

⁹⁹By that lemma, any open interval joining a point $K \in k$ with a point $L \in l$ would then contain a point $H \in \mathcal{P}_{\bar{h}}$.

¹⁰⁰We shall usually omit the word weak for brevity.

¹⁰¹The superscript \mathfrak{J} in parentheses in $[ABC]^{(\mathfrak{J})}$ is used to signify the set (with generalized betweenness relation) \mathfrak{J} containing the geometric objects $\mathcal{A}, \mathcal{B}, \mathcal{C}$. This superscript is normally omitted when the set \mathfrak{J} is obvious from context or not relevant.

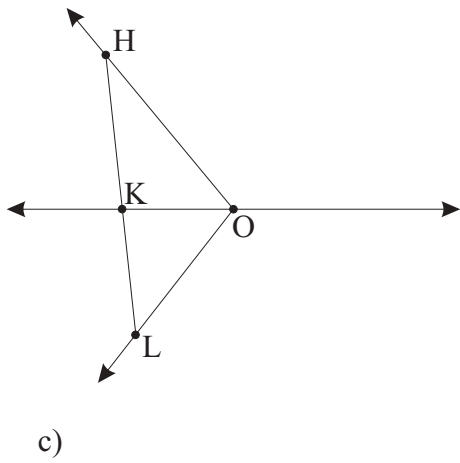
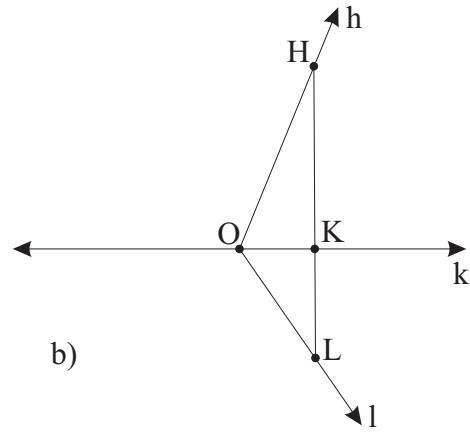
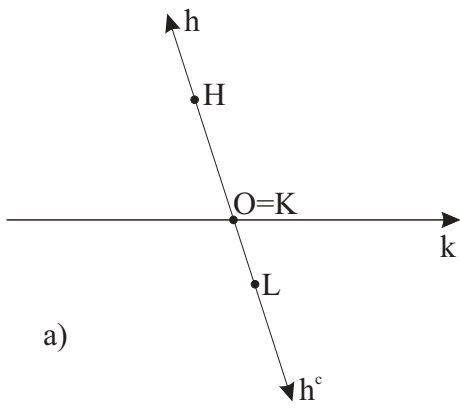

Figure 1.55: Suppose that the rays h , k , l have the same initial point O and the rays h , l lie on opposite sides of the line \bar{k} . Then either k lies inside $\angle(h, l)$, or k^c lies inside $\angle(h, l)$, or $l = h^c$.

We say that a set \mathfrak{J} of certain geometric objects $\mathcal{A}, \mathcal{B}, \dots$ admits a strong, linear, or open ¹⁰² generalized betweenness relation, if there is a ternary relation $\rho \subset \mathfrak{J}^3 = \mathfrak{J} \times \mathfrak{J} \times \mathfrak{J}$, called strong generalized betweenness relation on \mathfrak{J} , whose properties are given by Pr 1.2.1 – Pr 1.2.7.

Property 1.2.1. *If geometric objects $\mathcal{A}, \mathcal{B}, \mathcal{C} \in \mathfrak{J}$ and \mathcal{B} lies between \mathcal{A} and \mathcal{C} , then $\mathcal{A}, \mathcal{B}, \mathcal{C}$ are distinct geometric objects, and \mathcal{B} lies between \mathcal{C} and \mathcal{A} .*

Property 1.2.2. *For every two geometric objects $\mathcal{A}, \mathcal{B} \in \mathfrak{J}$ there is a geometric object $\mathcal{C} \in \mathfrak{J}$ such that \mathcal{B} lies between \mathcal{A} and \mathcal{C} .*

Property 1.2.3. *If a geometric object $\mathcal{B} \in \mathfrak{J}$ lies between geometric objects $\mathcal{A}, \mathcal{C} \in \mathfrak{J}$, then the object \mathcal{C} cannot lie between the objects \mathcal{A} and \mathcal{B} .*

Property 1.2.4. *For any two geometric objects $\mathcal{A}, \mathcal{C} \in \mathfrak{J}$ there is a geometric object $\mathcal{B} \in \mathfrak{J}$ between them.*

Property 1.2.5. *Among any three distinct geometric objects $\mathcal{A}, \mathcal{B}, \mathcal{C} \in \mathfrak{J}$ one always lies between the others.*

Property 1.2.6. *If a geometric object $\mathcal{B} \in \mathfrak{J}$ lies between geometric objects $\mathcal{A}, \mathcal{C} \in \mathfrak{J}$, and the geometric object \mathcal{C} lies between \mathcal{B} and $\mathcal{D} \in \mathfrak{J}$, then both \mathcal{B} and \mathcal{C} lie between \mathcal{A} and \mathcal{D} . ¹⁰³*

Property 1.2.7. *If a geometric object $\mathcal{B} \in \mathfrak{J}$ lies between geometric objects $\mathcal{A}, \mathcal{C} \in \mathfrak{J}$, and the geometric object \mathcal{C} lies between \mathcal{A} and $\mathcal{D} \in \mathfrak{J}$, then \mathcal{B} lies also between \mathcal{A} and \mathcal{D} and \mathcal{C} lies between \mathcal{B} and \mathcal{D} .*

Lemma 1.2.21.35. *The converse is also true. That is, $\forall \mathcal{A}, \mathcal{B}, \mathcal{C}, \mathcal{D} \in \mathfrak{J} ([\mathcal{A}\mathcal{B}\mathcal{C}] \& [\mathcal{A}\mathcal{C}\mathcal{D}] \Leftrightarrow [\mathcal{A}\mathcal{B}\mathcal{D}] \& [\mathcal{B}\mathcal{C}\mathcal{D}])$.*

Given a set \mathfrak{J} with a weak (and, in particular, strong) generalized betweenness relation, define the following subsets of \mathfrak{J} :

generalized abstract intervals, which are simply two - element subsets of \mathfrak{J} : $\mathcal{A}\mathcal{B} \doteq \{\mathcal{A}, \mathcal{B}\}$

generalized open intervals, called also open generalized intervals $(\mathcal{A}\mathcal{B}) \doteq \{\mathcal{X} \mid [\mathcal{A}\mathcal{X}\mathcal{B}], \mathcal{X} \in \mathfrak{J}\}$;

generalized half-open (called also generalized half-closed) intervals $[\mathcal{A}\mathcal{B}) \doteq \{\mathcal{A}\} \cup (\mathcal{A}\mathcal{B})$ and $(\mathcal{A}\mathcal{B}] \doteq (\mathcal{A}\mathcal{B}) \cup \{\mathcal{B}\}$;

For definiteness, in the future we shall usually refer to sets of the form $[\mathcal{A}\mathcal{B})$ as the generalized half-open intervals, and to those of the form $(\mathcal{A}\mathcal{B}]$ as the generalized half-closed ones.

generalized closed intervals, also called generalized segments, $[\mathcal{A}\mathcal{B}] \doteq (\mathcal{A}\mathcal{B}) \cup \{\mathcal{A}\} \cup \{\mathcal{B}\}$.

As in the particular case of points, generalized open, generalized half-open, generalized half-closed and generalized closed intervals thus defined are collectively called generalized interval - like sets, joining their ends \mathcal{A}, \mathcal{B} .

Proposition 1.2.21.36. *The set of points \mathcal{P}_a of any line a admits a strong generalized betweenness relation.*

Proof. Follows from A 1.1.1 – A 1.1.3, T 1.2.1, T 1.2.2, L 1.2.3.1, L 1.2.3.2. \square

We say that a set \mathfrak{J} of certain geometric objects $\mathcal{A}, \mathcal{B}, \dots$ admits an angular, or closed, ¹⁰⁴ generalized betweenness relation, if there is a ternary relation $\rho \subset \mathfrak{J}^3 = \mathfrak{J} \times \mathfrak{J} \times \mathfrak{J}$, called angular generalized betweenness relation on \mathfrak{J} , whose properties are given by Pr 1.2.1, Pr 1.2.3 – Pr 1.2.7, Pr 1.2.8.

Property 1.2.8. *The set \mathfrak{J} is a generalized closed interval, i.e. there are two geometric objects $\mathcal{A}_0, \mathcal{B}_0 \in \mathfrak{J}$ such that any other geometric object of the set \mathfrak{J} lies between $\mathcal{A}_0, \mathcal{B}_0$. ¹⁰⁵*

We shall refer to a collection of rays emanating from a common initial point O as a pencil of rays or a ray pencil, which will be written sometimes as $\mathcal{P}^{(O)}$. The point O will, naturally, be called the initial point, origin, or vertex of the pencil. A ray pencil whose rays all lie in one plane is called a planar pencil (of rays). If two or more rays lie in the same pencil, they will sometimes be called equioriginal (to each other).

Theorem 1.2.21. *Given a line a in plane α , a point Q lying in α outside a , and a point $O \in a$, the set (pencil) \mathfrak{J} of all rays with the initial point O , lying in α on the same side of the line a as the point Q ¹⁰⁶, admits a strong generalized betweenness relation.*

To be more precise, we say that a ray $O_B \in \mathfrak{J}$ lies between rays $O_A \in \mathfrak{J}$ and $O_C \in \mathfrak{J}$ iff O_B lies inside the angle $\angle AOC$, i.e. iff $O_B \subset \text{Int}\angle AOC$. ¹⁰⁷ Then the following properties hold, corresponding to Pr 1.2.1 - Pr 1.2.7 in the definition of strong generalized betweenness relation:

1. *If a ray $O_B \in \mathfrak{J}$ lies between rays $O_A \in \mathfrak{J}$ and $O_C \in \mathfrak{J}$, then O_B also lies between O_C and O_A , and O_A, O_B, O_C are distinct rays.*
2. *For every two rays $O_A, O_B \in \mathfrak{J}$ there is a ray $O_C \in \mathfrak{J}$ such that O_B lies between O_A and O_C .*
3. *If a ray $O_B \in \mathfrak{J}$ lies between rays $O_A, O_C \in \mathfrak{J}$, the ray O_C cannot lie between the rays O_A and O_B .*

¹⁰²The term *linear* here reflects the resemblance to the betweenness relation for points on a line. The word *open* is indicative of the topological properties of \mathfrak{J} .

¹⁰³Note that, stated in different terms, this property implies that if a geometric object \mathcal{C} lies on an open interval $(\mathcal{A}\mathcal{D})$, the open intervals $(\mathcal{A}\mathcal{C})$, $(\mathcal{C}\mathcal{D})$ are both subsets of $(\mathcal{A}\mathcal{D})$ (see below the definition of intervals in the sets equipped with a generalized betweenness relation).

¹⁰⁴The use of the term *angular* in this context will be elucidated later, as we reveal its connection with the properties of angles. The word *closed* reflects the topological properties of \mathfrak{J} .

¹⁰⁵In this situation it is natural to call $\mathcal{A}_0, \mathcal{B}_0$ the ends of the set \mathfrak{J} .

¹⁰⁶That is, of all rays with origins at O , lying in the half-plane a_Q .

¹⁰⁷If $O_B \in \mathfrak{J}$ lies between $O_A \in \mathfrak{J}$ and $O_C \in \mathfrak{J}$, we write this as $[O_A O_B O_C]$ in accord with the general notation. Sometimes, however, it is more convenient to write simply $O_B \subset \text{Int}\angle AOC$.

4. For any two rays $O_A, O_C \in \mathfrak{J}$ there is a ray $O_B \in \mathfrak{J}$ between them.
5. Among any three distinct rays $O_A, O_B, O_C \in \mathfrak{J}$ one always lies between the others.
6. If a ray $O_B \in \mathfrak{J}$ lies between rays $O_A, O_C \in \mathfrak{J}$, and the ray O_C lies between O_B and $O_D \in \mathfrak{J}$, both O_B, O_C lie between O_A and O_D .
7. If a ray $O_B \in \mathfrak{J}$ lies between rays $O_A, O_C \in \mathfrak{J}$, and the ray O_C lies between O_A and $O_D \in \mathfrak{J}$, then O_B lies also between O_A, O_D , and O_C lies between O_B and O_D . The converse is also true. That is, for all rays of the pencil \mathfrak{J} we have $[O_A O_B O_C] \& [O_A O_C O_D] \Leftrightarrow [O_A O_B O_D] \& [O_B O_C O_D]$.

The statements of this theorem are easier to comprehend and prove when given the following formulation in "native" terms.

1. If a ray $O_B \in \mathfrak{J}$ lies inside an angle $\angle AOC$, where $O_A, O_C \in \mathfrak{J}$, it also lies inside the angle $\angle COA$, and the rays O_A, O_B, O_C are distinct.
2. For every two rays $O_A, O_B \in \mathfrak{J}$ there is a ray $O_C \in \mathfrak{J}$ such that the ray O_B lies inside the angle $\angle AOC$.
3. If a ray $O_B \in \mathfrak{J}$ lies inside an angle $\angle AOC$, where $O_A, O_C \in \mathfrak{J}$, the ray O_C cannot lie inside the angle $\angle AOB$.
4. For any two rays $O_A, O_C \in \mathfrak{J}$, there is a ray $O_B \in \mathfrak{J}$ which lies inside the angle $\angle AOC$.
5. Among any three distinct rays $O_A, O_B, O_C \in \mathfrak{J}$ one always lies inside the angle formed by the other two.
6. If a ray $O_B \in \mathfrak{J}$ lies inside an angle $\angle AOC$, where $O_A, O_C \in \mathfrak{J}$, and the ray O_C lies inside $\angle BOD$, then both O_B and O_C lie inside the angle $\angle AOD$.
7. If a ray $O_B \in \mathfrak{J}$ lies inside an angle $\angle AOC$, where $O_A, O_C \in \mathfrak{J}$, and the ray O_C lies inside $\angle AOD$, then O_B also lies inside $\angle AOD$, and the ray O_C lies inside the angle $\angle BOD$. The converse is also true. That is, for all rays of the pencil \mathfrak{J} we have $O_B \subset \text{Int}\angle AOC \& O_C \subset \text{Int}\angle AOD \Leftrightarrow O_B \subset \text{Int}\angle AOD \& O_C \subset \text{Int}\angle BOD$.

Proof. 1. Follows from the definition of $\text{Int}\angle AOC$.

2. See L 1.2.21.18.

3. See C 1.2.21.13.

4. See L 1.2.21.19.

5. By A 1.1.3 $\exists D D \in a \& D \neq O$. By A 1.1.2 $a = a_{OD}$. Then $O_A O_B a \& O_A \neq O_B \& O_A O_C a \& O_A \neq O_C \& O_B O_C a \& O_B \neq O_C \stackrel{\text{L1.2.21.21}}{\implies} (O_A \subset \text{Int}\angle DOB \vee O_B \subset \text{Int}\angle DOA) \& (O_A \subset \text{Int}\angle DOC \vee O_C \subset \text{Int}\angle DOA) \& (O_B \subset \text{Int}\angle DOC \vee O_C \subset \text{Int}\angle DOB)$. Suppose $O_A \subset \text{Int}\angle DOB$.¹⁰⁸ If $O_B \subset \text{Int}\angle DOC$ (see Fig. 1.56, a) then $O_A \subset \text{Int}\angle DOB \& O_B \subset \text{Int}\angle DOC \stackrel{\text{L1.2.21.27}}{\implies} O_B \subset \text{Int}\angle AOC$. Now suppose $O_C \subset \text{Int}\angle DOB$. If $O_C \subset \text{Int}\angle DOA$ (see Fig. 1.56, b) then $O_C \subset \text{Int}\angle DOA \& O_A \subset \text{Int}\angle DOB \stackrel{\text{L1.2.21.27}}{\implies} O_A \subset \text{Int}\angle BOC$. Finally, if $O_A \subset \text{Int}\angle DOC$ (see Fig. 1.56, c) then $O_A \subset \text{Int}\angle DOC \& O_C \subset \text{Int}\angle DOB \stackrel{\text{L1.2.21.27}}{\implies} O_C \subset \text{Int}\angle AOB$.

6. (See Fig 1.57.) Choose a point $E \in a, E \neq O$, so that $O_B \subset \text{Int}\angle EOD$.¹⁰⁹ $O_B \subset \text{Int}\angle EOD \& O_C \subset \text{Int}\angle BOD \stackrel{\text{L1.2.21.27}}{\implies} O_C \subset \text{Int}\angle EOD \& O_B \subset \text{Int}\angle EOC$. Using the definition of interior, and then L 1.2.16.1, L 1.2.16.2, we can write $O_B \subset \text{Int}\angle EOC \& O_B \subset \text{Int}\angle AOC \Rightarrow O_B O_E a_{OC} \& O_B O_A a_{OC} \Rightarrow O_A O_C a_{OC}$. Using the definition of the interior of $\angle EOC$, we have $O_A O_E a_{OC} \& O_A O_C a_{OE} \Rightarrow O_A \subset \text{Int}\angle EOC$. $O_A \subset \text{Int}\angle EOC \& O_C \subset \text{Int}\angle EOD \stackrel{\text{L1.2.21.27}}{\implies} O_C \subset \text{Int}\angle AOD$. Finally, $O_C \subset \text{Int}\angle AOD \& O_B \subset \text{Int}\angle AOC \stackrel{\text{L1.2.21.27}}{\implies} O_B \subset \text{Int}\angle AOD$.

7. See L 1.2.21.27. \square

At this point it is convenient to somewhat extend our concept of an angle.

A pair $\angle(h, h^c)$ of mutually complementary rays h, h^c is traditionally referred to as a straight angle. The rays h, h^c are, naturally, called its sides. Observe that, according to our definitions, a straight angle is not, strictly speaking, an angle. We shall refer collectively to both the (conventional) and straight angles as extended angles.

Given a line a in plane α , a point Q lying in α outside a , and a point $O \in a$, consider the set (pencil), which we denote here by \mathfrak{J}_0 , of all rays with the initial point O , lying in α on the same side of the line a as the point Q .¹¹⁰ Taking a point $P \in a, P \neq O$ (see A 1.1.3), we let $h \equiv O_P$. Denote by \mathfrak{J} the set obtained as the union of \mathfrak{J}_0 with the pair of sides of the straight angle $\angle(h, h^c)$ (viewed as a two-element set): $\mathfrak{J} \equiv \mathfrak{J}_0 \cup \{h, h^c\}$. We shall say that a ray O_C lies between the rays h, h^c , or, worded another way, a ray O_C lies inside the straight angle $\angle(h, h^c)$, if $O_C \subset a_Q$. With the other cases handled traditionally,¹¹¹ we can formulate the following proposition:

Proposition 1.2.21.29. *Given a line a in plane α , a point Q lying in α outside a , and two distinct points $O \in a, P \in a, P \neq O$, the set (pencil) \mathfrak{J} , composed of all rays with the initial point O , lying in α on the same side of the line a as the point Q , plus the rays $h \equiv O_P$ and h^c ,¹¹² admits an angular generalized betweenness relation, i.e. the rays in the set \mathfrak{J} thus defined satisfy 1, 3-8 below, corresponding to Pr 1.2.1, Pr 1.2.3 - Pr 1.2.7, Pr 1.2.8:*

1. If a ray $O_B \in \mathfrak{J}$ lies between rays $O_A \in \mathfrak{J}$ and $O_C \in \mathfrak{J}$, then O_B also lies between O_C and O_A , and O_A, O_B, O_C are distinct rays.
2. For every two rays $O_A, O_B \in \mathfrak{J}$ there is a ray $O_C \in \mathfrak{J}$ such that O_B lies between O_A and O_C .
3. If a ray $O_B \in \mathfrak{J}$ lies between rays $O_A, O_C \in \mathfrak{J}$, the ray O_C cannot lie between the rays O_A and O_B .

¹⁰⁸We can do this without any loss of generality. No loss of generality results from the fact that the rays O_A, O_B, O_C enter the conditions of the theorem symmetrically.

¹⁰⁹By A 1.1.3 $\exists E E \in a \& E \neq O$. By A 1.1.2 $a = a_{OE}$. By L 1.2.21.15, L 1.2.21.4 $O_D O_B a \& O_D \neq O_B \Rightarrow O_B \subset \text{Int}\angle EOD \vee O_B \subset \text{Int}\angle FOD$, where $O_F = (O_E)^c$. We choose $O_B \subset \text{Int}\angle EOD$, renaming $E \rightarrow F, F \rightarrow E$ if needed.

¹¹⁰We shall find the notation \mathfrak{J}_0 convenient in the proof of P 1.2.21.29.

¹¹¹That is, we say that a ray $O_B \in \mathfrak{J}$ lies between rays $O_A \in \mathfrak{J}$ and $O_C \in \mathfrak{J}$ iff O_B lies inside the angle $\angle AOC$, i.e. iff $O_B \subset \text{Int}\angle AOC$.

¹¹²That is, of all rays with origins at O , lying in the half-plane a_Q .

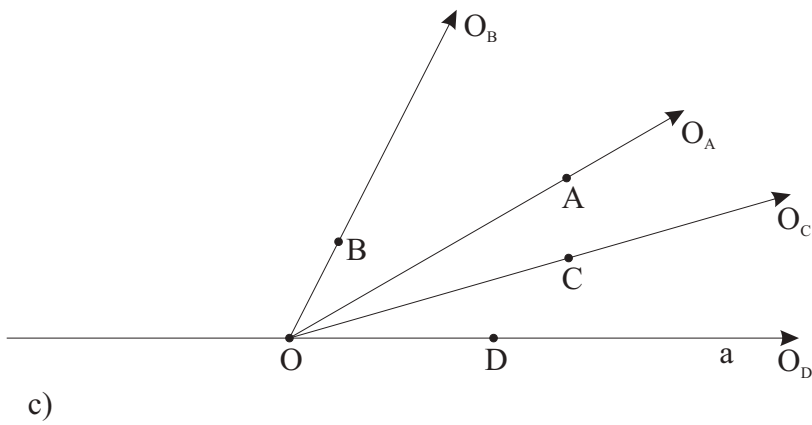
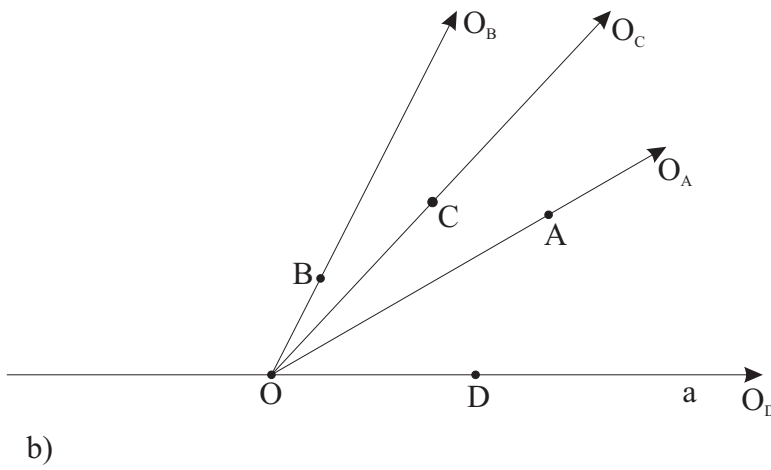
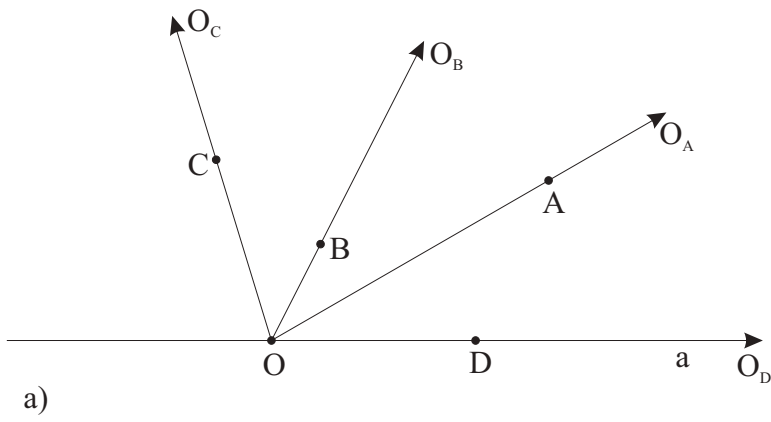

Figure 1.56: Among any three distinct rays $O_A, O_B, O_C \in \mathfrak{J}$ one always lies inside the angle formed by the other two.

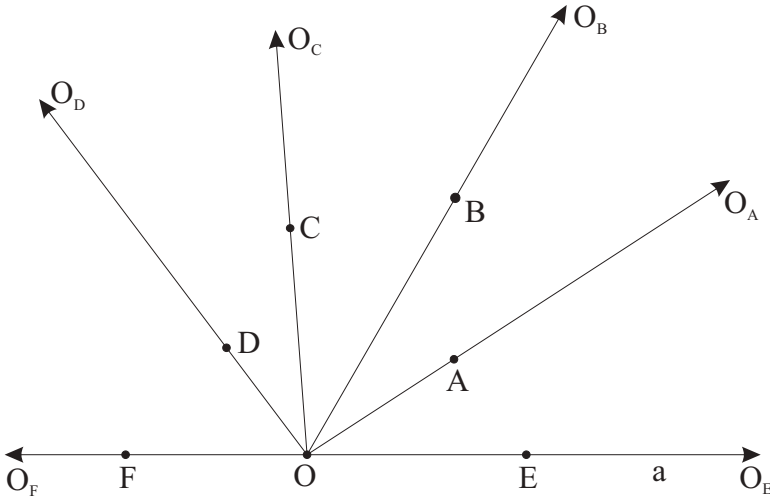

Figure 1.57: If a ray $O_B \in \mathfrak{J}$ lies between rays $O_A, O_C \in \mathfrak{J}$, and the ray O_C lies between O_B and $O_D \in \mathfrak{J}$, both O_B, O_C lie between O_A and O_D .

4. For any two rays $O_A, O_C \in \mathfrak{J}$ there is a ray $O_B \in \mathfrak{J}$ between them.
 5. Among any three distinct rays $O_A, O_B, O_C \in \mathfrak{J}$ one always lies between the others.
 6. If a ray $O_B \in \mathfrak{J}$ lies between rays $O_A, O_C \in \mathfrak{J}$, and the ray O_C lies between O_B and $O_D \in \mathfrak{J}$, both O_B, O_C lie between O_A and O_D .
 7. If a ray $O_B \in \mathfrak{J}$ lies between rays $O_A, O_C \in \mathfrak{J}$, and the ray O_C lies between O_A and $O_D \in \mathfrak{J}$, then O_B lies also between O_A, O_D , and O_C lies between O_B and O_D . The converse is also true. That is, for all rays of the pencil \mathfrak{J} we have $[O_A O_B O_C] \& [O_A O_C O_D] \Leftrightarrow [O_A O_B O_D] \& [O_B O_C O_D]$.
 8. The set \mathfrak{J} coincides with the generalized closed interval $[hh^c]$.
- In addition, we have the following property:
9. The ray h cannot lie between any two other rays of the set \mathfrak{J} . Neither can h^c .

Proof. 1. For the cases when both $O_A \in \mathfrak{J}_0, O_C \in \mathfrak{J}_0$ (where \mathfrak{J}_0 is the pencil of rays with the initial point O , lying in α on the same side of the line a as the point Q) or one of O_A, O_C lies in \mathfrak{J}_0 and the other coincides with $h = O_P$ or h^c ,¹¹³ the result follows from the definitions of the corresponding angles and their interiors. When one of the rays O_A, O_C coincides with h , and the other - with h^c , it is a trivial consequence of the definition of the interior of the straight angle $\angle(h, h^c)$ for our case as the half-plane a_Q .

9. In fact, $h \subset \text{Int}\angle BOC$, where $O_B \in \mathfrak{J}_0, O_C \in \mathfrak{J}_0$, would imply (by L 1.2.21.21, 2) $hB\bar{h}$, which is absurd. This contradiction shows that the ray h cannot lie between two rays from \mathfrak{J}_0 . Also, $\forall k \in \mathfrak{J}_0$ we can write $\angle(k, h^c) = \text{adj}\angle(h, k) \stackrel{\text{L1.2.21.12}}{\Leftrightarrow} h^c \subset \text{Ext}\angle(h, k)$, whence the result.

8. According to our definition of the interior of the straight angle $\angle(h, h^c)$ we have $[hkh^c]$ for all $k \in \mathfrak{J}_0$.

3. By hypothesis, $O_B \in \mathfrak{J}$ lies between rays $O_A, O_C \in \mathfrak{J}$. From 9 necessarily $O_B \notin \mathfrak{J}_0$. If $O_C = h$ the result again follows from 9. If $O_C \neq h$, the rays O_A, O_C form an angle (i.e. the angle $\angle AOC$ necessarily exists), and by C 1.2.21.13 O_C cannot lie inside the angle $\angle AOB$.

4. If at least one of the rays O_A, O_C is distinct from h, h^c , then the angle $\angle AOC$ exists, and the result follows from L 1.2.21.19. If one of the rays O_A, O_C coincides with h , and the other with h^c , we can let $B \equiv Q$.

5. For $O_A, O_B, O_C \in \mathfrak{J}_0$ see T 1.2.21, 5. If one of the rays O_A, O_C coincides with h , and the other with h^c , then the ray O_B lies in \mathfrak{J}_0 and thus lies inside the straight angle $\angle(h, h^c)$. Now suppose that only one of the rays O_A, O_C coincides with either h or h^c . Due to symmetry, in this case we can assume without loss of generality that $O_A = h$.¹¹⁴ The result then follows from L 1.2.21.21.

7. Observe that by 9. the rays O_B, O_C necessarily lie in \mathfrak{J}_0 . Suppose one of the rays O_A, O_D coincides with h and the other with h^c . We can assume without loss of generality that $O_A = h, O_D = h^c$.¹¹⁵ This already means that the ray O_B lies inside the straight angle $\angle(h, h^c)$, i.e. O_B lies between O_A and O_D . Since the rays O_B, O_C both lie in \mathfrak{J}_0 , i.e. on the same side of a and, by hypothesis, O_B lies between $O_A = h$ and O_C , from L 1.2.21.22 we conclude that the ray O_C lies between O_B and $O_D = h^c$.

Suppose now that only no more than one of the rays O_A, O_B, O_C, O_D can coincide with h, h^c . Then, obviously, the rays O_A, O_D necessarily form an angle (in the conventional sense, not a straight angle), and the required result follows from L 1.2.21.27.

6. For $O_A, O_B, O_C, O_D \in \mathfrak{J}_0$ see T 1.2.21, 6. Observe that by 9. the rays O_B, O_C necessarily lie in \mathfrak{J}_0 . If one of the rays O_A, O_D coincides with h and the other with h^c , we immediately conclude that O_B, O_C lie inside the straight

¹¹³Since h and h^c enter the conditions of the theorem in the completely symmetrical way, we do not really need to consider the case of h^c separately. Thus when only one side of the straight angle $\angle(h, h^c)$ is in question, for the rest of this proof we will be content with considering only h .

¹¹⁴If necessary, we can make one or both of the substitutions $A \leftrightarrow C, h \leftrightarrow h^c$.

¹¹⁵Making the substitution $A \leftrightarrow D$ or $h \leftrightarrow h^c$ if necessary.

angle $\angle(h, h^c)$. Now suppose that only one of the rays O_A, O_D coincides with one of the rays h, h^c . As in our proof of 5, we can assume without loss of generality that $O_A = h$.¹¹⁶ Then both O_B and O_D lie in \mathfrak{J}_0 , i.e. on one side of a . Hence by L 1.2.21.21 either the ray O_D lies inside the angle $\angle AOB$, or the ray O_B lies inside the angle $\angle AOD$. To disprove the first of these alternatives, suppose $O_D \subset \text{Int}\angle AOB$. Taking into account that, by hypothesis, $O_C \subset \text{Int}\angle BOD$, L 1.2.21.27 gives $O_C \subset \text{Int}\angle AOB$, which contradicts $O_B \subset \text{Int}\angle AOC$ in view of C 1.2.21.13. Thus, we have shown that $O_B \subset \text{Int}\angle AOD$. Finally, $O_B \subset \text{Int}\angle AOD \& O_C \subset \text{Int}\angle BOD \xrightarrow{\text{L1.2.21.12}} O_C \subset \text{Int}\angle AOD$. \square

Proposition 1.2.21.30. *If A, B are two elements of a set \mathfrak{J} with weak generalized betweenness relation, the generalized open interval (AB) is a set with linear generalized betweenness relation, and the generalized closed interval $[AB]$ is a set with angular generalized betweenness relation.*

Proof. \square

Lemma 1.2.21.31. *Let the vertex O of an angle $\angle(h, k)$ lies in a half-plane a_A . Suppose further that the sides h, k of $\angle(h, k)$ lie in the plane α_{a_A} ¹¹⁷ and have no common points with a . Then the interior of the angle $\angle(h, k)$ lies completely in the half-plane a_A : $\text{Int}\angle(h, k) \subset a_A$.*

Proof. \square

Lemma 1.2.21.32. *Given an angle $\angle(h, k)$ and points $B \in h, C \in k$, there is a bijection between the open interval (BC) and the open angular interval (hk) .¹¹⁸*

Proof. \square

Corollary 1.2.21.33. *There is an infinite number of rays inside a given angle.*

Proof. \square

Lemma 1.2.21.34. *Suppose that lines b, c lie on the same side of a line a and $a \parallel b, a \parallel c, b \parallel c$. Then either the line b lies inside the strip ac , or the line c lies inside the strip ab .*

Proof. Take points $A \in a, B \in b, C \in c$. Consider first the case where A, B, C are collinear. By T 1.2.2 we have either $[BAC]$, or $[ABC]$, or $[ACB]$.¹¹⁹ But $[BAC]$ would imply that the lines a, c lie on opposite sides of the line b contrary to hypothesis. $[ABC]$ (in view of C 1.2.19.21) implies that b lies inside the strip (ac) . Similarly, $[ACB]$ implies that c lies inside the strip (ab) (note the symmetry!).

Suppose now that the points A, B, C do not lie on one line. The point B divides the line b into two rays, h and h^c , with initial point B . If one of these rays, say, h , lies inside the angle $\angle ABC$ then in view of L 1.2.21.10 it is bound to meet the open interval (AC) in some point H , and we see from C 1.2.19.21 that the line b lies inside the strip (ac) . Similarly, the point C divides the line c into two rays, k and k^c , with initial point C . If one of these rays, say, k , lies inside the angle $\angle ACB$ then the line c lies inside the strip (ab) . Suppose now that neither of the rays h, h^c lies inside the angle $\angle ABC$ and neither of the rays k, k^c lies inside the angle $\angle ACB$. Then using L 1.2.21.34 we find that the points A, C lie on the same side of the line b and the points A, B lie on the same side of the line c .¹²⁰ Thus, we see that the lines a, c lie on the same side of the line b and the lines a, b lie on the same side of the line c , as required. \square

Further Properties of Generalized Betweenness Relations

In the following we assume that \mathfrak{J} is a set of geometric objects which admits a generalized betweenness relation.

Lemma 1.2.22.2. *If a geometric object $B \in \mathfrak{J}$ lies between geometric objects A, C , then the geometric object A cannot lie between B and C .*

Lemma 1.2.22.3. *Suppose each of the geometric objects $C, D \in \mathfrak{J}$ lies between geometric objects $A, B \in \mathfrak{J}$. If a geometric object $M \in \mathfrak{J}$ lies between C and D , it also lies between A and B . In other words, if geometric objects $C, D \in \mathfrak{J}$ lie between geometric objects $A, B \in \mathfrak{J}$, the generalized open interval (CD) lies inside the generalized open interval (AB) , that is, $(CD) \subset (AB)$.*

Proof. $[ACB] \& [ADB] \& [CMD] \xrightarrow{\text{Pr1.2.1}} A \neq C \neq D \xrightarrow{\text{Pr1.2.5}} [ACD] \vee [ADC] \vee [CAD]$. But $\neg[CAD]$, because otherwise $[CAD] \& [ADB] \xrightarrow{\text{Pr1.2.6}} [CAB] \xrightarrow{\text{Pr1.2.3}} \neg[ACB]$ a contradiction. Finally, $[ACD] \& [CMD] \xrightarrow{\text{Pr1.2.7}} [AMD]$ and $[AMD] \& [ADB] \xrightarrow{\text{Pr1.2.7}} [AMB]$. \square

¹¹⁶Making, if necessary, one or both of the substitutions $A \leftrightarrow C, h \leftrightarrow h^c$.

¹¹⁷In fact, in view of L 1.2.19.8, we require only that one of the points of h and one of the points of k lie in a_A .

¹¹⁸Recall that (hk) is a set of rays lying inside the angle $\angle(h, k)$ and having the vertex of $\angle(h, k)$ as their initial point.

¹¹⁹Since, by hypothesis, the lines $a \ni A, b \ni B, c \ni C$ are pairwise parallel, the points A, B, C are obviously distinct.

¹²⁰Since the points A, C do not lie on the line b , they lie either on one side or on opposite sides of the line b . But if A, C lie on opposite sides of b , then by L 1.2.21.34 either h or h^c lie inside the angle $\angle ABC$ (recall that we now assume that A, B, C are not collinear), contrary to our assumption.

Lemma 1.2.22.4. *If both ends of a generalized interval \mathcal{CD} lie on a generalized closed interval $[\mathcal{AB}]$, the generalized open interval (\mathcal{CD}) is included in the generalized open interval (\mathcal{AB}) .*

Proof. Follows immediately from Pr 1.2.6, L 1.2.22.3. \square

Lemma 1.2.22.5. *If a geometric object $\mathcal{C} \in \mathfrak{J}$ lies between geometric objects \mathcal{A} and \mathcal{B} , none of the geometric objects of the generalized open interval (\mathcal{AC}) lie on the generalized open interval (\mathcal{CB}) .*

Proof. $[\mathcal{AMC}] \& [\mathcal{ACB}] \xrightarrow{\text{Pr1.2.7}} [\mathcal{MCB}] \xrightarrow{\text{Pr1.2.3}} \neg[\mathcal{CMB}]$. \square

Proposition 1.2.22.6. *If two (distinct) geometric objects \mathcal{E}, \mathcal{F} lie on an generalized open interval (\mathcal{AB}) (i.e., between geometric objects \mathcal{A}, \mathcal{B}), then either \mathcal{E} lies between \mathcal{A} and \mathcal{F} or \mathcal{F} lies between \mathcal{A} and \mathcal{E} .*

Proof. By Pr 1.2.1 $[\mathcal{AEB}] \& [\mathcal{AFB}] \Rightarrow \mathcal{A} \neq \mathcal{E} \& \mathcal{A} \neq \mathcal{F}$. Also, by hypothesis, $\mathcal{E} \neq \mathcal{F}$. Therefore, by Pr 1.2.5 $[\mathcal{EAF}] \vee [\mathcal{AEF}] \vee [\mathcal{AFE}]$. But $[\mathcal{EAF}] \& \mathcal{E} \in (\mathcal{AB}) \& \mathcal{F} \in (\mathcal{AB}) \xrightarrow{\text{L1.2.22.5}} \mathcal{A} \in (\mathcal{AB})$, which is absurd as it contradicts Pr 1.2.1. We are left with $[\mathcal{AEF}] \vee [\mathcal{AFE}]$, q.e.d. \square

Lemma 1.2.22.7. *Both ends of a generalized interval \mathcal{CD} lie on a generalized closed interval $[\mathcal{AB}]$ iff the open interval (\mathcal{CD}) is included in the generalized open interval (\mathcal{AB}) .*

Proof. Follows immediately from Pr 1.2.6, L 1.2.22.4. \square

Lemma 1.2.22.8. *If a geometric object $\mathcal{C} \in \mathfrak{J}$ lies between geometric objects $\mathcal{A}, \mathcal{B} \in \mathfrak{J}$, any geometric object of the open interval (\mathcal{AB}) , distinct from \mathcal{C} , lies either on (\mathcal{AC}) or on (\mathcal{CB}) .¹²¹*

Proof. Suppose $[\mathcal{AMB}]$, $\mathcal{M} \neq \mathcal{C}$. Since also $[\mathcal{ACB}] \& [\mathcal{AMB}] \xrightarrow{\text{Pr1.2.1}} \mathcal{C} \neq \mathcal{B} \& \mathcal{M} \neq \mathcal{B}$, by Pr 1.2.5 $[\mathcal{CBM}] \vee [\mathcal{CMB}] \vee [\mathcal{MCB}]$. But $\neg[\mathcal{CBM}]$, because otherwise $[\mathcal{ACB}] \& [\mathcal{CBM}] \xrightarrow{\text{Pr1.2.6}} [\mathcal{ABM}] \xrightarrow{\text{Pr1.2.3}} \neg[\mathcal{AMB}]$ - a contradiction. Finally, $[\mathcal{AMB}] \& [\mathcal{MCB}] \xrightarrow{\text{Pr1.2.7}} [\mathcal{AMC}]$. \square

Lemma 1.2.22.9. *If a geometric object $\mathcal{O} \in \mathfrak{J}$ divides geometric objects $\mathcal{A} \in \mathfrak{J}$ and $\mathcal{C} \in \mathfrak{J}$, as well as $\mathcal{A}, \mathcal{D} \in \mathfrak{J}$, it does not divide \mathcal{C} and \mathcal{D} .*

Proof. $[\mathcal{AOC}] \& [\mathcal{AOD}] \xrightarrow{\text{Pr1.2.1}} \mathcal{A} \neq \mathcal{C} \& \mathcal{A} \neq \mathcal{D}$. If also $\mathcal{C} \neq \mathcal{D}$ ¹²², from Pr 1.2.5 we have $[\mathcal{CAD}] \& [\mathcal{ACD}] \& [\mathcal{ADC}]$. But $\neg[\mathcal{CAD}]$, because $[\mathcal{CAD}] \& [\mathcal{AOD}] \xrightarrow{\text{Pr1.2.7}} [\mathcal{CAO}] \xrightarrow{\text{Pr1.2.3}} \neg[\mathcal{AOC}]$. Hence by L 1.2.22.5 $([\mathcal{ACD}] \vee [\mathcal{ADC}]) \& [\mathcal{AOC}] \& [\mathcal{AOD}] \Rightarrow \neg[\mathcal{COD}]$. \square

Generalized Betweenness Relation for n Geometric Objects

Lemma 1.2.22.10. *Suppose $\mathcal{A}_1, \mathcal{A}_2, \dots, \mathcal{A}_n, (\dots)$ is a finite (countably infinite) sequence of geometric objects of the set \mathfrak{J} with the property that a geometric object of the sequence lies between two other geometric objects of the sequence if its number has an intermediate value between the numbers of these geometric objects. Then the converse of this property is true, namely, that if a geometric object of the sequence lies between two other geometric objects of the sequence, its number has an intermediate value between the numbers of these two geometric objects. That is, $(\forall i, j, k \in \mathbb{N}_n \text{ (respectively, } \mathbb{N})) ((i < j < k) \vee (k < j < i) \Rightarrow [\mathcal{A}_i \mathcal{A}_j \mathcal{A}_k]) \Rightarrow (\forall i, j, k \in \mathbb{N}_n \text{ (respectively, } \mathbb{N})) ([\mathcal{A}_i \mathcal{A}_j \mathcal{A}_k] \Rightarrow (i < j < k) \vee (k < j < i))$.*

Let an infinite (finite) sequence of geometric objects $\mathcal{A}_i \in \mathfrak{J}$, where $i \in \mathbb{N}$ ($i \in \mathbb{N}_n, n \geq 4$), be numbered in such a way that, except for the first and the last, every geometric object lies between the two geometric objects of the sequence with numbers, adjacent (in \mathbb{N}) to the number of the given geometric object. Then:

Lemma 1.2.22.11. *– A geometric object from this sequence lies between two other members of this sequence iff its number has an intermediate value between the numbers of these two geometric objects.*

Proof. By induction. $[\mathcal{A}_1 \mathcal{A}_2 \mathcal{A}_3] \& [\mathcal{A}_2 \mathcal{A}_3 \mathcal{A}_4] \xrightarrow{\text{Pr1.2.6}} [\mathcal{A}_1 \mathcal{A}_2 \mathcal{A}_4] \& [\mathcal{A}_1 \mathcal{A}_3 \mathcal{A}_4]$ ($n = 4$). $[\mathcal{A}_i \mathcal{A}_{n-2} \mathcal{A}_{n-1}] \& [\mathcal{A}_{n-2} \mathcal{A}_{n-1} \mathcal{A}_n] \xrightarrow{\text{Pr1.2.6}} [\mathcal{A}_i \mathcal{A}_{n-1} \mathcal{A}_n], [\mathcal{A}_i \mathcal{A}_j \mathcal{A}_{n-1}] \& [\mathcal{A}_j \mathcal{A}_{n-1} \mathcal{A}_n] \xrightarrow{\text{Pr1.2.7}} [\mathcal{A}_i \mathcal{A}_j \mathcal{A}_n]$. \square

Lemma 1.2.22.12. *– An arbitrary geometric object from the set \mathfrak{J} cannot lie on more than one of the generalized open intervals formed by pairs of geometric objects of the sequence having adjacent numbers in the sequence.*

Proof. Suppose $[\mathcal{A}_i \mathcal{B} \mathcal{A}_{i+1}], [\mathcal{A}_j \mathcal{B} \mathcal{A}_{j+1}], i < j$. By L 1.2.22.11 $[\mathcal{A}_i \mathcal{A}_{i+1} \mathcal{A}_{j+1}]$, whence $[\mathcal{A}_i \mathcal{B} \mathcal{A}_{i+1}] \& [\mathcal{A}_i \mathcal{A}_{i+1} \mathcal{A}_{j+1}] \xrightarrow{\text{L1.2.22.5}} \neg[\mathcal{A}_{i+1} \mathcal{B} \mathcal{A}_{j+1}] \Rightarrow j \neq i+1$. But if $j > i+1$, we have $[\mathcal{A}_{i+1} \mathcal{A}_j \mathcal{A}_{j+1}] \& [\mathcal{A}_j \mathcal{B} \mathcal{A}_{j+1}] \xrightarrow{\text{Pr1.2.7}} [\mathcal{A}_{i+1} \mathcal{B} \mathcal{A}_{j+1}]$ – a contradiction. \square

¹²¹Thus, based on this lemma and some of the preceding results, we can write $[\mathcal{ABC}] \Rightarrow (\mathcal{AC}) = (\mathcal{AB}) \cup \{\mathcal{B}\} \cup (\mathcal{BC}), (\mathcal{AB}) \subset (\mathcal{AC}), (\mathcal{BC}) \subset (\mathcal{AC}), (\mathcal{AB}) \cap (\mathcal{BC}) = \emptyset$.

¹²²For $\mathcal{C} = \mathcal{D}$ see Pr 1.2.1.

Lemma 1.2.22.13. – In the case of a finite sequence, a geometric object which lies between the end (the first and the last, n^{th}), geometric objects of the sequence, and does not coincide with the other geometric objects of the sequence, lies on at least one of the generalized open intervals, formed by pairs of geometric objects with adjacent numbers.

Proof. By induction. For $n = 3$ see L 1.2.22.8. $[\mathcal{A}_1\mathcal{B}\mathcal{A}_n] \& \mathcal{B} \notin \{\mathcal{A}_2, \dots, \mathcal{A}_{n-1}\} \xrightarrow{\text{L1.2.22.8}} ([\mathcal{A}_1\mathcal{B}\mathcal{A}_{n-1}] \vee [\mathcal{A}_{n-1}\mathcal{B}\mathcal{A}_n]) \& \mathcal{B} \notin \{\mathcal{A}_2, \dots, \mathcal{A}_{n-2}\} \Rightarrow (\exists i \in \mathbb{N}_{n-2} \& [\mathcal{A}_i\mathcal{B}\mathcal{A}_{i+1}] \vee [\mathcal{A}_{n-1}\mathcal{B}\mathcal{A}_n]) \Rightarrow \exists i \in \mathbb{N}_{n-1} \& [\mathcal{A}_i\mathcal{B}\mathcal{A}_{i+1}]. \quad \square$

Lemma 1.2.22.14. – All of the generalized open intervals $(\mathcal{A}_i\mathcal{A}_{i+1})$, where $i = 1, 2, \dots, n-1$, lie inside the generalized open interval $(\mathcal{A}_1\mathcal{A}_n)$, i.e. $\forall i \in \{1, 2, \dots, n-1\} (\mathcal{A}_i\mathcal{A}_{i+1}) \subset (\mathcal{A}_1\mathcal{A}_n)$.

Proof. By induction. For $n = 4$ $([\mathcal{A}_1\mathcal{M}\mathcal{A}_2] \vee [\mathcal{A}_2\mathcal{M}\mathcal{A}_3]) \& [\mathcal{A}_1\mathcal{A}_2\mathcal{A}_3] \xrightarrow{\text{Pr1.2.7}} [\mathcal{A}_1\mathcal{M}\mathcal{A}_3]$. If $\mathcal{M} \in (\mathcal{A}_i\mathcal{A}_{i+1})$, $i \in \{1, 2, \dots, n-2\}$, then by the induction hypothesis $\mathcal{M} \in (\mathcal{A}_1\mathcal{A}_{n-1})$, by L 1.2.22.11 we have $[\mathcal{A}_1\mathcal{A}_{n-1}\mathcal{A}_n]$, therefore $[\mathcal{A}_1\mathcal{M}\mathcal{A}_{n-1}] \& [\mathcal{A}_1\mathcal{A}_{n-1}\mathcal{A}_n] \xrightarrow{\text{Pr1.2.7}} [\mathcal{A}_1\mathcal{M}\mathcal{A}_n]$; if $\mathcal{M} \in (\mathcal{A}_{n-1}\mathcal{A}_n)$ then $[\mathcal{A}_1\mathcal{A}_{n-1}\mathcal{A}_n] \& [\mathcal{A}_{n-1}\mathcal{M}\mathcal{A}_n] \xrightarrow{\text{Pr1.2.7}} [\mathcal{A}_1\mathcal{M}\mathcal{A}_n]$. \square

Lemma 1.2.22.15. – The generalized half-open interval $[\mathcal{A}_1\mathcal{A}_n)$ is a disjoint union of the generalized half-open intervals $[\mathcal{A}_i\mathcal{A}_{i+1})$, where $i = 1, 2, \dots, n-1$:

$$[\mathcal{A}_1\mathcal{A}_n) = \bigcup_{i=1}^{n-1} [\mathcal{A}_i\mathcal{A}_{i+1}).$$

Also,

The generalized half-closed interval $(\mathcal{A}_1\mathcal{A}_n]$ is a disjoint union of the generalized half-closed intervals $(\mathcal{A}_i\mathcal{A}_{i+1}]$, where $i = 1, 2, \dots, n-1$:

$$(\mathcal{A}_1\mathcal{A}_n] = \bigcup_{i=1}^{n-1} (\mathcal{A}_i\mathcal{A}_{i+1}].$$

In particular, if $\mathfrak{J} = [\mathcal{A}_1\mathcal{A}_n)$ is a set with angular generalized betweenness relation then we have

$$\mathfrak{J} = \bigcup_{i=1}^{n-1} [\mathcal{A}_i\mathcal{A}_{i+1}).$$

Proof. Use L 1.2.22.13, L 1.2.22.11, L 1.2.22.14. \square

If a finite (infinite) sequence of geometric objects $\mathcal{A}_i \in \mathfrak{J}$, $i \in \mathbb{N}_n$, $n \geq 4$ ($n \in \mathbb{N}$) has the property that a geometric object from the sequence lies between two other geometric objects of the sequence iff its number has an intermediate value between the numbers of these two geometric objects, we say that the geometric objects $\mathcal{A}_1, \mathcal{A}_2, \dots, \mathcal{A}_n, (\dots)$ are in order $[\mathcal{A}_1\mathcal{A}_2 \dots \mathcal{A}_n(\dots)]$.

Theorem 1.2.22. Any finite sequence of geometric objects $\mathcal{A}_i \in \mathfrak{J}$, $i \in \mathbb{N}_n$, $n \geq 4$ can be renumbered in such a way that a geometric object from the sequence lies between two other geometric objects of the sequence iff its number has an intermediate value between the numbers of these two geometric objects. In other words, any finite sequence of geometric objects $\mathcal{A}_i \in \mathfrak{J}$, $i \in \mathbb{N}_n$, $n \geq 4$ can be put in order $[\mathcal{A}_1\mathcal{A}_2 \dots \mathcal{A}_n]$.

By a renumbering of a finite (infinite) sequence of geometric objects \mathcal{A}_i , $i \in \mathbb{N}_n$, $n \geq 4$, we mean a bijective mapping (permutation) $\sigma : \mathbb{N}_n \rightarrow \mathbb{N}_n$, which induces a bijective transformation $\{\sigma_S : \mathcal{A}_1, \mathcal{A}_2, \dots, \mathcal{A}_n\} \rightarrow \{\mathcal{A}_1, \mathcal{A}_2, \dots, \mathcal{A}_n\}$ of the set of geometric objects of the sequence by $\mathcal{A}_i \mapsto \mathcal{A}_{\sigma(i)}$, $i \in \mathbb{N}_n$.

The theorem then asserts that for any finite sequence of distinct geometric objects \mathcal{A}_i , $i \in \mathbb{N}_n$, $n \geq 4$ there is a bijective mapping (permutation) of renumbering $\sigma : \mathbb{N}_n \rightarrow \mathbb{N}_n$ such that $\forall i, j, k \in \mathbb{N}_n$ ($i < j < k$) \vee ($k < j < i$) $\Leftrightarrow [\mathcal{A}_{\sigma(i)}\mathcal{A}_{\sigma(j)}\mathcal{A}_{\sigma(k)}]$.

Proof. Let $[\mathcal{A}_l\mathcal{A}_m\mathcal{A}_n]$, $l \neq m \neq n$, $l \in \mathbb{N}_4$, $m \in \mathbb{N}_4$, $n \in \mathbb{N}_4$ (see Pr 1.2.5). If $p \in \mathbb{N}_4$ & $p \neq l$ & $p \neq m$ & $p \neq n$, then by Pr 1.2.5, L 1.2.22.8 $[\mathcal{A}_p\mathcal{A}_l\mathcal{A}_n] \vee [\mathcal{A}_l\mathcal{A}_p\mathcal{A}_m] \vee [\mathcal{A}_m\mathcal{A}_p\mathcal{A}_n] \vee [\mathcal{A}_l\mathcal{A}_p\mathcal{A}_n] \vee [\mathcal{A}_l\mathcal{A}_n\mathcal{A}_p]$.

Define the values of the function σ by

for $[\mathcal{A}_p\mathcal{A}_l\mathcal{A}_n]$ let $\sigma(1) = p$, $\sigma(2) = l$, $\sigma(3) = m$, $\sigma(4) = n$;

for $[\mathcal{A}_l\mathcal{A}_p\mathcal{A}_m]$ let $\sigma(1) = l$, $\sigma(2) = p$, $\sigma(3) = m$, $\sigma(4) = n$;

for $[\mathcal{A}_m\mathcal{A}_p\mathcal{A}_n]$ let $\sigma(1) = l$, $\sigma(2) = m$, $\sigma(3) = p$, $\sigma(4) = n$;

for $[\mathcal{A}_l\mathcal{A}_n\mathcal{A}_p]$ let $\sigma(1) = l$, $\sigma(2) = m$, $\sigma(3) = n$, $\sigma(4) = p$.

Now suppose that $\exists \tau : \mathbb{N}_{n-1} \rightarrow \mathbb{N}_{n-1}$ such that $\forall i, j, k \in \mathbb{N}_{n-1}$ ($i < j < k$) \vee ($k < j < i$) $\Leftrightarrow [\mathcal{A}_{\tau(i)}\mathcal{A}_{\tau(j)}\mathcal{A}_{\tau(k)}]$. By Pr 1.2.5, L 1.2.22.13 $[\mathcal{A}_n\mathcal{A}_{\tau(1)}\mathcal{A}_{\tau(n-1)}] \vee [\mathcal{A}_{\tau(1)}\mathcal{A}_{\tau(n-1)}\mathcal{A}_{\tau(n)}] \vee \exists i \in \mathbb{N}_{n-2} \& [\mathcal{A}_{\tau(i)}\mathcal{A}_n\mathcal{A}_{\tau(n+1)}]$.

The values of σ are now given

for $[\mathcal{A}_n\mathcal{A}_{\sigma(1)}\mathcal{A}_{\sigma(n-1)}]$ by $\sigma(1) = n$ and $\sigma(i+1) = \tau(i)$, where $i \in \mathbb{N}_{n-1}$;

for $[\mathcal{A}_{\sigma(i)}\mathcal{A}_{\sigma(n-1)}\mathcal{A}_{\sigma(n)}]$ by $\sigma(i) = \tau(i)$, where $i \in \mathbb{N}_{n-1}$, and $\sigma(n) = n$;

for $[\mathcal{A}_{\sigma(i)}\mathcal{A}_n\mathcal{A}_{\sigma(i+1)}]$ by $\sigma(j) = \tau(j)$, where $j \in \{1, 2, \dots, i\}$, $\sigma(i+1) = n$, and $\sigma(j+1) = \tau(j)$, where $j \in \{i+1, i+2, \dots, n-1\}$. See L 1.2.22.11. \square

Some Properties of Generalized Open Intervals

Lemma 1.2.23.1. *For any finite set of geometric objects $\{\mathcal{A}_1, \mathcal{A}_2, \dots, \mathcal{A}_n\}$ of a generalized open interval $(\mathcal{A}\mathcal{B}) \subset \mathfrak{J}$ there is a geometric object \mathcal{C} on $(\mathcal{A}\mathcal{B})$ not in that set.*

Proof. Using T 1.2.22, put the geometric objects of the set $\{\mathcal{A}, \mathcal{A}_1, \mathcal{A}_2, \dots, \mathcal{A}_n, \mathcal{B}\}$ in order $[\mathcal{A}, \mathcal{A}_1, \mathcal{A}_2, \dots, \mathcal{A}_n, \mathcal{B}]$. By Pr 1.2.5 $\exists \mathcal{C} [\mathcal{A}_1\mathcal{C}\mathcal{A}_2]$. By L 1.2.22.3 $[\mathcal{A}\mathcal{C}\mathcal{B}]$ and $\mathcal{C} \neq \mathcal{A}_1, \mathcal{A}_2, \dots, \mathcal{A}_n$, because by Pr 1.2.3 $[\mathcal{A}_1\mathcal{C}\mathcal{A}_2] \Rightarrow \neg[\mathcal{A}_1\mathcal{A}_2\mathcal{C}]$ and by Pr 1.2.1 $\mathcal{C} \neq \mathcal{A}_1, \mathcal{A}_2$. \square

Theorem 1.2.23. *Every generalized open interval in \mathfrak{J} contains an infinite number of geometric objects.*

Corollary 1.2.23.2. *Any generalized interval-like set in \mathfrak{J} contains infinitely many geometric objects.*

Lemma 1.2.24.3. *Let \mathcal{A}_i , where $i \in \mathbb{N}_n$, $n \geq 4$, be a finite sequence of geometric objects with the property that every geometric object of the sequence, except for the first and the last, lies between the two geometric objects with adjacent (in \mathbb{N}) numbers. Then if $i \leq j \leq l$, $i \leq k \leq l$, $i, j, k, l \in \mathbb{N}_n$ ($i, j, k, l \in \mathbb{N}$), the generalized open interval $(\mathcal{A}_j\mathcal{A}_k)$ is included in the generalized open interval $(\mathcal{A}_i\mathcal{A}_l)$.¹²³ Furthermore, if $i < j < k < l$ and $\mathcal{B} \in (\mathcal{A}_j\mathcal{A}_k)$ then $[\mathcal{A}_i\mathcal{A}_j\mathcal{B}]$.¹²⁴*

Proof. Assume $j < k$.¹²⁵ Then $i = j \& k = l \Rightarrow (\mathcal{A}_i\mathcal{A}_l) = (\mathcal{A}_j\mathcal{A}_k)$; $i = j \& k < l \Rightarrow [\mathcal{A}_i\mathcal{A}_k\mathcal{A}_l] \xrightarrow{\text{Pr1.2.7}} \mathcal{A}_j\mathcal{A}_k \subset (\mathcal{A}_i\mathcal{A}_l)$; $i < j \& k = l \Rightarrow [\mathcal{A}_i\mathcal{A}_j\mathcal{A}_k] \xrightarrow{\text{Pr1.2.7}} (\mathcal{A}_j\mathcal{A}_k) \subset (\mathcal{A}_i\mathcal{A}_l)$. $i < j \& k < l \Rightarrow [\mathcal{A}_i\mathcal{A}_j\mathcal{A}_l] \& [\mathcal{A}_i\mathcal{A}_k\mathcal{A}_l] \xrightarrow{\text{Pr1.2.7}} (\mathcal{A}_j\mathcal{A}_k) \subset (\mathcal{A}_i\mathcal{A}_l)$.

The second part follows from $[\mathcal{A}_i\mathcal{A}_j\mathcal{A}_k] \& [\mathcal{A}_j\mathcal{B}\mathcal{A}_k] \xrightarrow{\text{Pr1.2.7}} [\mathcal{A}_i\mathcal{A}_j\mathcal{B}]$. \square

Let a generalized interval $\mathcal{A}_0\mathcal{A}_n$ be divided into generalized intervals $\mathcal{A}_0\mathcal{A}_1, \mathcal{A}_1\mathcal{A}_2, \dots, \mathcal{A}_{n-1}\mathcal{A}_n$. Then

Lemma 1.2.24.4. *- If $\mathcal{B}_1 \in (\mathcal{A}_{k-1}\mathcal{A}_k)$, $\mathcal{B}_2 \in (\mathcal{A}_{l-1}\mathcal{A}_l)$, $k < l$ then $[\mathcal{A}_0\mathcal{B}_1\mathcal{B}_2]$. Furthermore, if $\mathcal{B}_2 \in (\mathcal{A}_{k-1}\mathcal{A}_k)$ and $[\mathcal{A}_{k-1}\mathcal{B}_1\mathcal{B}_2]$, then $[\mathcal{A}_0\mathcal{B}_1\mathcal{B}_2]$.*

Proof. By L 1.2.22.11 $[\mathcal{A}_0\mathcal{A}_k\mathcal{A}_m]$. Using L 1.2.24.3 (since $0 \leq k-1$, $k \leq l-1 < n$), we obtain $[\mathcal{A}_0\mathcal{B}_1\mathcal{A}_k]$, $[\mathcal{A}_k\mathcal{B}_2\mathcal{A}_n]$. Hence $[\mathcal{B}_1\mathcal{A}_k\mathcal{A}_m] \& [\mathcal{A}_k\mathcal{B}_2\mathcal{A}_m] \xrightarrow{\text{Pr1.2.7}} [\mathcal{B}_1\mathcal{A}_k\mathcal{B}_2]$, $[\mathcal{A}_0\mathcal{B}_1\mathcal{A}_k] \& [\mathcal{B}_1\mathcal{A}_k\mathcal{B}_2] \xrightarrow{\text{Pr1.2.6}} [\mathcal{A}_0\mathcal{B}_1\mathcal{B}_2]$. To show the second part, observe that for $0 < k-1$ we have by the preceding lemma (the second part of L 1.2.24.3) $[\mathcal{A}_0\mathcal{A}_{k-1}\mathcal{B}_2]$, whence $[\mathcal{A}_0\mathcal{A}_{k-1}\mathcal{B}_2] \& [\mathcal{A}_{k-1}\mathcal{B}_1\mathcal{B}_2] \xrightarrow{\text{Pr1.2.7}} [\mathcal{A}_0\mathcal{B}_1\mathcal{B}_2]$. \square

Corollary 1.2.24.5. *- If $\mathcal{B}_1 \in (\mathcal{A}_{k-1}\mathcal{A}_k)$, $\mathcal{B}_2 \in (\mathcal{A}_{l-1}\mathcal{A}_l)$, $k < l$, then $[\mathcal{A}\mathcal{B}_1\mathcal{B}_2]$.*

Proof. Follows from the preceding lemma (L 1.2.24.4) and L 1.2.24.3. \square

Lemma 1.2.24.6. *- If $[\mathcal{A}_0\mathcal{B}_1\mathcal{B}_2]$ and $\mathcal{B}_2 \in (\mathcal{A}_0\mathcal{A}_n)$, then either $\mathcal{B}_1 \in (\mathcal{A}_{k-1}\mathcal{A}_k)$, $\mathcal{B}_2 \in (\mathcal{A}_{l-1}\mathcal{A}_l)$, where $0 < k < l \leq n$, or $\mathcal{B}_1 \in (\mathcal{A}_{k-1}\mathcal{A}_k)$, $\mathcal{B}_2 \in (\mathcal{A}_{k-1}\mathcal{A}_k)$, in which case either $\mathcal{B}_1 = \mathcal{A}_{k-1}$ and $\mathcal{B}_2 \in (\mathcal{A}_{k-1}\mathcal{A}_k)$, or $[\mathcal{A}_{k-1}\mathcal{B}_1\mathcal{B}_2]$, where $\mathcal{B}_1, \mathcal{B}_2 \in (\mathcal{A}_{k-1}\mathcal{A}_k)$.*

Proof. $[\mathcal{A}_0\mathcal{B}_1\mathcal{B}_2] \& [\mathcal{A}_0\mathcal{B}_2\mathcal{A}_n] \xrightarrow{\text{Pr1.2.7}} [\mathcal{A}_0\mathcal{B}_1\mathcal{A}_k]$. By L 1.2.22.15 we have $\mathcal{B}_1 \in (\mathcal{A}_{k-1}\mathcal{A}_k)$, $\mathcal{B}_2 \in (\mathcal{A}_{l-1}\mathcal{A}_l)$, where $k, l \in \mathbb{N}_n$. Show $k \leq l$. In fact, otherwise $\mathcal{B}_1 \in (\mathcal{A}_{k-1}\mathcal{A}_k)$, $\mathcal{B}_2 \in (\mathcal{A}_{l-1}\mathcal{A}_l)$, $k > l$ would imply $[\mathcal{A}_0\mathcal{B}_2\mathcal{B}_1]$ by the preceding corollary, which, according to Pr 1.2.3, contradicts $[\mathcal{A}_0\mathcal{B}_1\mathcal{B}_2]$. Suppose $k = l$. Note that $[\mathcal{A}_0\mathcal{B}_1\mathcal{B}_2] \xrightarrow{\text{Pr1.2.7}} \mathcal{B}_1 \neq \mathcal{B}_2 \neq \mathcal{A}_0$. The assumption $\mathcal{B}_2 = \mathcal{A}_{k-1}$ would (by L 1.2.24.3; we have in this case $0 < k-1$, because $\mathcal{B}_2 \neq \mathcal{A}_0$) imply $[\mathcal{A}_0\mathcal{B}_2\mathcal{B}_1]$ - a contradiction. Finally, if $\mathcal{B}_1, \mathcal{B}_2 \in (\mathcal{A}_{k-1}\mathcal{A}_k)$ then by P 1.2.3.4 either $[\mathcal{A}_{k-1}\mathcal{B}_1\mathcal{B}_2]$ or $[\mathcal{A}_{k-1}\mathcal{B}_2\mathcal{B}_1]$. But $[\mathcal{A}_{k-1}\mathcal{B}_2\mathcal{B}_1]$ would give $[\mathcal{A}_0\mathcal{B}_2\mathcal{B}_1]$ by (the second part of) L 1.2.24.4. Thus, we have $[\mathcal{A}_{k-1}\mathcal{B}_1\mathcal{B}_2]$. There remains also the possibility that $\mathcal{B}_1 = \mathcal{A}_{k-1}$ and $\mathcal{B}_2 \in (\mathcal{A}_{k-1}\mathcal{A}_k)$. \square

Lemma 1.2.24.7. *- If $0 \leq j < k \leq l-1 < n$ and $\mathcal{B} \in (\mathcal{A}_{l-1}\mathcal{A}_l)$ then $[\mathcal{A}_j\mathcal{A}_k\mathcal{B}]$.¹²⁶*

Proof. By L 1.2.22.15 $[\mathcal{A}_j\mathcal{A}_k\mathcal{A}_l]$. By L 1.2.24.3 $[\mathcal{A}_k\mathcal{B}\mathcal{A}_l]$. Therefore, $[\mathcal{A}_j\mathcal{A}_k\mathcal{A}_l] \& [\mathcal{A}_k\mathcal{B}\mathcal{A}_l] \xrightarrow{\text{Pr1.2.7}} [\mathcal{A}_j\mathcal{A}_k\mathcal{B}]$. \square

Lemma 1.2.24.8. *- If $\mathcal{D} \in (\mathcal{A}_{j-1}\mathcal{A}_j)$, $\mathcal{B} \in (\mathcal{A}_{l-1}\mathcal{A}_l)$, $0 < j \leq k \leq l-1 < n$, then $[\mathcal{D}\mathcal{A}_k\mathcal{B}]$.*

Proof. Since $j \leq k \Rightarrow j-1 < k$, we have from the preceding lemma (L 1.2.24.7) $[\mathcal{A}_{j-1}\mathcal{A}_k\mathcal{B}]$ and from L 1.2.24.3 $[\mathcal{A}_{j-1}\mathcal{D}\mathcal{A}_k]$. Hence by Pr 1.2.7 $[\mathcal{D}\mathcal{A}_k\mathcal{B}]$. \square

Lemma 1.2.24.9. *- If $\mathcal{B}_1 \in (\mathcal{A}_i\mathcal{A}_j)$, $\mathcal{B}_2 \in (\mathcal{A}_k\mathcal{A}_l)$, $0 \leq i < j < k < l \leq n$ then $(\mathcal{A}_j\mathcal{A}_k) \subset (\mathcal{B}_1\mathcal{A}_k) \subset (\mathcal{B}_1\mathcal{B}_2) \subset (\mathcal{B}_1\mathcal{A}_l) \subset (\mathcal{A}_i\mathcal{A}_l)$, $(\mathcal{A}_j\mathcal{A}_k) \neq (\mathcal{B}_1\mathcal{A}_k) \neq (\mathcal{B}_1\mathcal{B}_2) \neq (\mathcal{B}_1\mathcal{A}_l) \neq (\mathcal{A}_i\mathcal{A}_l)$ and $(\mathcal{A}_j\mathcal{A}_k) \subset (\mathcal{A}_j\mathcal{B}_2) \subset (\mathcal{B}_1\mathcal{B}_2) \subset (\mathcal{A}_i\mathcal{B}_2) \subset (\mathcal{A}_i\mathcal{A}_l)$, $(\mathcal{A}_j\mathcal{A}_k) \neq (\mathcal{A}_j\mathcal{B}_2) \neq (\mathcal{B}_1\mathcal{B}_2) \neq (\mathcal{A}_i\mathcal{B}_2) \neq (\mathcal{A}_i\mathcal{A}_l)$.*

¹²³In particular, given a finite (countable infinite) sequence of geometric objects \mathcal{A}_i , $i \in \mathbb{N}_n$ ($n \in \mathbb{N}$) in order $[\mathcal{A}_1\mathcal{A}_2 \dots \mathcal{A}_n(\dots)]$, if $i \leq j \leq l$, $i \leq k \leq l$, $i, j, k, l \in \mathbb{N}_n$ ($i, j, k, l \in \mathbb{N}$), the generalized open interval $(\mathcal{A}_j\mathcal{A}_k)$ is included in the generalized open interval $(\mathcal{A}_i\mathcal{A}_l)$.

¹²⁴Also, $[\mathcal{B}\mathcal{A}_k\mathcal{A}_l]$, but this gives nothing new because of symmetry.

¹²⁵Due to symmetry, we can do so without loss of generality.

¹²⁶Similarly, it can be shown that if $0 < l \leq j < k \leq n$ and $\mathcal{B} \in (\mathcal{A}_{l-1}\mathcal{A}_l)$ then $[\mathcal{B}\mathcal{A}_j\mathcal{A}_k]$. Because of symmetry this essentially adds nothing new to the original statement.

Proof. ¹²⁷ Using the properties Pr 1.2.6, Pr 1.2.7 and the results following them (summarized in the footnote accompanying T ??), we can write $[A_i B_1 A_j] \& [A_i A_j A_k] \xrightarrow{\text{Pr1.2.7}} [B_1 A_j A_k] \Rightarrow (A_j A_k) \subset (B_1 A_k) \& (A_j A_k) \neq (B_1 A_k)$. Also, $[A_j A_k A_l] \& [A_k B_2 A_l] \Rightarrow [A_j A_k B_2] \Rightarrow (A_j A_k) \subset (A_j B_2) \& (A_j A_k) \neq (A_j B_2)$. $[B_1 A_j A_k] \& [A_j A_k B_2] \xrightarrow{\text{Pr1.2.6}} [B_1 A_j B_2] \& [B_1 A_k B_2] \Rightarrow (A_j B_2) \subset (B_1 B_2) \& (A_j B_2) \neq (B_1 B_2) \& (B_1 A_k) \subset (B_1 B_2) \& (B_1 A_k) \neq (B_1 B_2)$. $[B_1 A_k B_2] \& [A_k B_2 A_l] \Rightarrow [B_1 B_2 A_l] \Rightarrow (B_1 B_2) \subset (B_1 A_l) \Rightarrow (B_1 B_2) \neq (B_1 A_l)$. $[A_i B_1 A_j] \& [B_1 A_j B_2] \Rightarrow [A_i B_1 B_2] \Rightarrow (B_1 B_2) \subset (A_i B_2) \Rightarrow (B_1 B_2) \neq (A_i B_2)$. $[A_i B_1 B_2] \& [B_1 B_2 A_l] \Rightarrow [A_i B_1 A_l] \& [A_i B_2 A_l] \Rightarrow (B_1 A_l) \subset (A_i A_l) \& (B_1 A_l) \neq (A_i A_l) \& (A_i B_2) \subset (A_i A_l) \& (A_i B_2) \neq (A_i A_l)$. \square

Lemma 1.2.24.10. – Suppose $B_1 \in [A_k A_{k+1}]$, $B_2 \in [A_l A_{l+1}]$, where $0 < k + 1 < l < n$. Then $(A_{k+1} A_l) \subset (B_1 B_2) \subset (A_k A_{l+1})$, $(A_{k+1} A_l) \neq (B_1 B_2) \neq (A_k A_{l+1})$.

Proof. ¹²⁸ Suppose $B_1 = A_k$, $B_2 = A_l$. Then $[A_k A_{k+1} A_l] \Rightarrow (A_{k+1} A_l) \subset (A_k A_l) = (B_1 B_2) \& (A_{k+1} A_l) \neq (B_1 B_2)$. Also, in view of $k < k + 1 < l < l + 1$, taking into account L 1.2.24.3, we have $(A_{k+1} A_l) \subset (B_1 B_2) \subset (A_k A_{l+1}) \& (A_{k+1} A_l) \neq (B_1 B_2) \neq (A_k A_{l+1})$. Suppose now $B_1 = A_k$, $B_2 \in (A_l A_{l+1})$. Then $[A_k A_l A_{l+1}] \& [A_l B_2 A_{l+1}] \Rightarrow [A_k A_l B_2] \& [A_k B_2 A_{l+1}] \Rightarrow [B_1 B_2 A_{l+1}] \Rightarrow (B_1 B_2) \subset (A_k A_{l+1}) \& (B_1 B_2) \neq (A_k A_{l+1})$. $[A_k A_{k+1} A_l] \& [A_{k+1} A_l B_2] \Rightarrow [A_k A_{k+1} B_2] \Rightarrow (A_{k+1} B_2) \subset (A_k B_2) = (B_1 B_2) \& (A_{k+1} B_2) \neq (B_1 B_2)$. $(A_{k+1} A_l) \subset (A_{k+1} B_2) \& (A_{k+1} A_l) \neq (A_{k+1} B_2) \& (A_{k+1} B_2) \subset (B_1 B_2) \& (A_{k+1} B_2) \neq (B_1 B_2) \Rightarrow (A_{k+1} A_l) \subset (B_1 B_2) \& (A_{k+1} A_l) \neq (B_1 B_2)$. Now consider the case $B_1 \in (A_k A_{k+1})$, $B_2 = A_l$. We have $[A_k B_1 A_{k+1}] \& [A_k A_{k+1} A_l] \Rightarrow [A_l A_{k+1} A_l] \Rightarrow (A_{k+1} A_l) \subset (B_1 B_2) \& (A_{k+1} A_l) \neq (B_1 B_2)$. $[A_k A_{k+1} A_l] \& [A_k B_1 A_{k+1}] \Rightarrow [B_1 A_{k+1} A_l] \Rightarrow (A_{k+1} A_l) \subset (B_1 B_2) \& (A_{k+1} A_l) \neq (B_1 B_2)$. $[B_1 A_{k+1} A_l] \& [A_{k+1} A_l A_{l+1}] \Rightarrow [B_1 A_l A_{l+1}] \Rightarrow (B_1 B_2) = (B_1 A_l) \subset (B_1 A_{l+1}) \& (B_1 B_2) \neq (B_1 A_{l+1})$. $[A_k B_1 A_{k+1}] \& [A_k A_{k+1} A_{l+1}] \Rightarrow [A_k B_1 A_{l+1}] \Rightarrow (B_1 A_{l+1}) \subset (A_k A_{l+1}) \& (B_1 A_{l+1}) \neq (A_k A_{l+1})$. $(B_1 B_2) \subset (B_1 A_{l+1}) \& (B_1 B_2) \neq (B_1 A_{l+1}) \& (B_1 A_{l+1}) \subset (A_k A_{l+1}) \& (B_1 A_{l+1}) \neq (A_k A_{l+1}) \Rightarrow (B_1 B_2) \subset (A_k A_{l+1}) \& (B_1 B_2) \neq (A_k A_{l+1})$. Finally, in the case when $B_1 \in (A_k A_{k+1})$, $B_2 \in (A_l A_{l+1})$ the result follows immediately from the preceding lemma (L 1.2.24.9). \square

Theorem 1.2.24.

Basic Properties of Generalized Rays

Given a set \mathfrak{J} , which admits a generalized betweenness relation, a geometric objects $\mathcal{O} \in \mathfrak{J}$ and another geometric object $\mathcal{A} \in \mathfrak{J}$, define the generalized ray $\mathcal{O}_{\mathcal{A}}^{(3)}$,¹²⁹ emanating from its origin \mathcal{O} , as the set $\mathcal{O}_{\mathcal{A}}^{(3)} = \{\mathcal{B} | \mathcal{B} \in \mathfrak{J} \& \mathcal{B} \neq \mathcal{O} \& \neg[A\mathcal{O}\mathcal{B}]\}$.¹³⁰

Lemma 1.2.25.1. Any geometric object \mathcal{A} lies on the ray $\mathcal{O}_{\mathcal{A}}$.

Proof. Follows immediately from Pr 1.2.1. \square

Lemma 1.2.25.2. If a geometric object \mathcal{B} lies on a generalized ray $\mathcal{O}_{\mathcal{A}}$, the geometric object \mathcal{A} lies on the generalized ray $\mathcal{O}_{\mathcal{B}}$, that is, $\mathcal{B} \in \mathcal{O}_{\mathcal{A}} \Rightarrow \mathcal{A} \in \mathcal{O}_{\mathcal{B}}$.

Proof. From Pr 1.2.1 $\mathcal{O} \in \mathfrak{J} \& \mathcal{A} \in \mathfrak{J} \& \mathcal{B} \in \mathfrak{J} \& \neg[A\mathcal{O}\mathcal{B}] \Rightarrow \neg[\mathcal{B}\mathcal{O}\mathcal{A}]$. \square

Lemma 1.2.25.3. If a geometric object \mathcal{B} lies on a generalized ray $\mathcal{O}_{\mathcal{A}}$, then the ray $\mathcal{O}_{\mathcal{A}}$ is equal to the ray $\mathcal{O}_{\mathcal{B}}$.

Proof. Let $\mathcal{C} \in \mathcal{O}_{\mathcal{A}}$. If $\mathcal{C} = \mathcal{A}$, then by L 1.2.25.2 $\mathcal{C} \in \mathcal{O}_{\mathcal{B}}$. $\mathcal{C} \neq \mathcal{O} \neq \mathcal{A} \& \neg[A\mathcal{O}\mathcal{C}] \xrightarrow{\text{Pr1.2.5}} [O\mathcal{A}\mathcal{C}] \vee [O\mathcal{C}\mathcal{A}]$. Hence $\neg[\mathcal{B}\mathcal{O}\mathcal{C}]$, because from Pr 1.2.6, Pr 1.2.7 $[\mathcal{B}\mathcal{O}\mathcal{C}] \& ([O\mathcal{A}\mathcal{C}] \vee [O\mathcal{C}\mathcal{A}]) \Rightarrow [\mathcal{B}\mathcal{O}\mathcal{A}]$. \square

Lemma 1.2.25.4. If generalized rays $\mathcal{O}_{\mathcal{A}}$ and $\mathcal{O}_{\mathcal{B}}$ have common points, they are equal.

Proof. $\mathcal{O}_{\mathcal{A}} \cap \mathcal{O}_{\mathcal{B}} \neq \emptyset \Rightarrow \exists \mathcal{C} \in \mathcal{O}_{\mathcal{A}} \& \mathcal{C} \in \mathcal{O}_{\mathcal{B}} \xrightarrow{\text{L1.2.25.3}} \mathcal{O}_{\mathcal{A}} = \mathcal{O}_{\mathcal{C}} = \mathcal{O}_{\mathcal{B}}$. \square

If $\mathcal{B} \in \mathcal{O}_{\mathcal{A}}$ ($\mathcal{B} \in \mathfrak{J} \& \mathcal{B} \notin \mathcal{O}_{\mathcal{A}} \& \mathcal{B} \neq \mathcal{O}$), we say that the geometric object \mathcal{B} lies in the set \mathfrak{J} on the same side (on the opposite side) of the given geometric object \mathcal{O} as (from) the geometric object \mathcal{A} .

¹²⁷An easier and perhaps more elegant way to prove this lemma follows from the observation that the elements of the set $\{\mathcal{A}_0, \mathcal{A}_1, \dots, \mathcal{A}_n, \mathcal{B}_1, \mathcal{B}_2\}$ are in order $[(\mathcal{A}_0 \dots \mathcal{A}_i) \mathcal{A}_i \mathcal{B}_1 \mathcal{A}_j \dots \mathcal{A}_k \mathcal{B}_2 \mathcal{A}_l (\dots \mathcal{A}_n)]$.

¹²⁸Again, we use in this proof the properties Pr 1.2.6, Pr 1.2.7 and the results following them (summarized in the footnote accompanying L 1.2.22.8) without referring to these results explicitly.

¹²⁹The set \mathfrak{J} is usually assumed to be known and fixed, and so its symbol (along with the accompanying parentheses) is dropped from the notation for a generalized ray. (See also our convention concerning the notation for generalized betweenness relation on p. 46.)

¹³⁰One might argue that this definition of a generalized ray allows to be viewed as rays objects very different from our traditional "common sense" view of a ray as an "ordered half-line" (for examples, see pp. 65, 104). However, this situation is quite similar to that of many other general mathematical theories. For example, in group theory multiplication in various groups, such as groups of transformations, may at first sight appear to have little in common with number multiplication. Nevertheless, the composition of appropriately defined transformations and number multiplication have the same basic properties reflected in the group axioms. Similarly, our definition of a generalized ray is corroborated by the fact that the generalized rays thus defined possess the same essential properties the conventional, "half-line" rays, do.

Lemma 1.2.25.5. *The relation "to lie in the set \mathfrak{J} on the same side of the given geometric object $\mathcal{O} \in \mathfrak{J}$ as" is an equivalence relation on $\mathfrak{J} \setminus \{\mathcal{O}\}$. That is, it possesses the properties of:*

- 1) *Reflexivity: A geometric object \mathcal{A} always lies on the same side of the geometric object \mathcal{O} as itself;*
- 2) *Symmetry: If a geometric object \mathcal{B} lies on the same side of the geometric object \mathcal{O} as \mathcal{A} , the geometric object \mathcal{A} lies on the same side of \mathcal{O} as \mathcal{B} .*
- 3) *Transitivity: If a geometric object \mathcal{B} lies on the same side of the geometric object \mathcal{O} as the geometric object \mathcal{A} , and a geometric object \mathcal{C} lies on the same side of \mathcal{O} as \mathcal{B} , then \mathcal{C} lies on the same side of \mathcal{O} as \mathcal{A} .*

Proof. 1) and 2) follow from L 1.2.25.1, L 1.2.25.2. Show 3): $\mathcal{B} \in \mathcal{O}_{\mathcal{A}} \& \mathcal{C} \in \mathcal{O}_{\mathcal{B}} \xrightarrow{\text{L1.2.25.3}} \mathcal{O}_{\mathcal{A}} = \mathcal{O}_{\mathcal{B}} = \mathcal{O}_{\mathcal{C}} \Rightarrow \mathcal{C} \in \mathcal{O}_{\mathcal{A}}$. \square

Lemma 1.2.25.6. *A geometric object \mathcal{B} lies on the opposite side of \mathcal{O} from \mathcal{A} iff \mathcal{O} divides \mathcal{A} and \mathcal{B} .*

Proof. By the definition of the generalized ray $\mathcal{O}_{\mathcal{A}}$ we have $\mathcal{B} \in \mathfrak{J} \& \mathcal{B} \notin \mathcal{O}_{\mathcal{A}} \& \mathcal{B} \neq \mathcal{O} \Rightarrow [\mathcal{A}\mathcal{O}\mathcal{B}]$. Conversely, from Pr 1.2.1 $\mathcal{O} \in \mathfrak{J} \& \mathcal{A} \in \mathfrak{J} \& \mathcal{B} \in \mathfrak{J} \& [\mathcal{A}\mathcal{O}\mathcal{B}] \Rightarrow \mathcal{B} \neq \mathcal{O} \& \mathcal{B} \notin \mathcal{O}_{\mathcal{A}}$. \square

Lemma 1.2.25.7. *The relation "to lie in the set \mathfrak{J} on the opposite side of the given geometric object \mathcal{O} from" is symmetric.*

Proof. Follows from L 1.2.25.6 and $[\mathcal{A}\mathcal{O}\mathcal{B}] \xrightarrow{\text{Pr1.2.1}} [\mathcal{B}\mathcal{O}\mathcal{A}]$. \square

If a geometric object \mathcal{B} lies in the set \mathfrak{J} on the same side (on the opposite side) of the geometric object \mathcal{O} as (from) a geometric object \mathcal{A} , in view of symmetry of the relation we say that the geometric objects \mathcal{A} and \mathcal{B} lie in the set \mathfrak{J} on the same side (on opposite sides) of \mathcal{O} .

Lemma 1.2.25.8. *If geometric objects \mathcal{A} and \mathcal{B} lie on one generalized ray $\mathcal{O}_{\mathcal{C}} \subset \mathfrak{J}$, they lie in the set \mathfrak{J} on the same side of the geometric object \mathcal{O} . If, in addition, $\mathcal{A} \neq \mathcal{B}$, then either \mathcal{A} lies between \mathcal{O} and \mathcal{B} , or \mathcal{B} lies between \mathcal{O} and \mathcal{A} .*

Proof. $\mathcal{A} \in \mathcal{O}_{\mathcal{C}} \xrightarrow{\text{L1.2.25.3}} \mathcal{O}_{\mathcal{A}} = \mathcal{O}_{\mathcal{C}}$. $\mathcal{B} \in \mathcal{O}_{\mathcal{A}} \Rightarrow \mathcal{B} \neq \mathcal{O} \& \neg[\mathcal{B}\mathcal{O}\mathcal{A}]$. When also $\mathcal{B} \neq \mathcal{A}$, from Pr 1.2.5 $[\mathcal{O}\mathcal{A}\mathcal{B}] \vee [\mathcal{O}\mathcal{B}\mathcal{A}]$. \square

Lemma 1.2.25.9. *If a geometric object \mathcal{C} lies in the set \mathfrak{J} on the same side of the geometric object \mathcal{O} as a geometric object \mathcal{A} , and a geometric object \mathcal{D} lies on the opposite side of \mathcal{O} from \mathcal{A} , then the geometric objects \mathcal{C} and \mathcal{D} lie on opposite sides of \mathcal{O} .¹³¹*

Proof. $\mathcal{C} \in \mathcal{O}_{\mathcal{A}} \Rightarrow \neg[\mathcal{A}\mathcal{O}\mathcal{C}] \& \mathcal{C} \neq \mathcal{O}$. If also $\mathcal{C} \neq \mathcal{A}$ ¹³², from Pr 1.2.5 $[\mathcal{A}\mathcal{C}\mathcal{O}]$ or $[\mathcal{C}\mathcal{A}\mathcal{O}]$, whence by Pr 1.2.6, Pr 1.2.7 $([\mathcal{A}\mathcal{C}\mathcal{O}] \vee [\mathcal{C}\mathcal{A}\mathcal{O}]) \& [\mathcal{A}\mathcal{O}\mathcal{D}] \Rightarrow [\mathcal{C}\mathcal{O}\mathcal{D}]$. \square

Lemma 1.2.25.10. *If geometric objects \mathcal{C} and \mathcal{D} lie in the set \mathfrak{J} on the opposite side of the geometric object \mathcal{O} from a geometric object \mathcal{A} ,¹³³ then \mathcal{C} and \mathcal{D} lie on the same side of \mathcal{O} .*

Proof. By Pr 1.2.1, L 1.2.22.9 $[\mathcal{A}\mathcal{O}\mathcal{C}] \& [\mathcal{A}\mathcal{O}\mathcal{D}] \Rightarrow \mathcal{O} \neq \mathcal{C} \& \neg[\mathcal{C}\mathcal{O}\mathcal{D}] \Rightarrow \mathcal{D} \in \mathcal{O}_{\mathcal{C}}$. \square

Lemma 1.2.25.11. *Suppose a geometric object \mathcal{C} lies on a generalized ray $\mathcal{O}_{\mathcal{A}}$, a geometric object \mathcal{D} lies on a generalized ray $\mathcal{O}_{\mathcal{B}}$, and \mathcal{O} lies between \mathcal{A} and \mathcal{B} . Then \mathcal{O} also lies between \mathcal{C} and \mathcal{D} .*

Proof. Observe that $\mathcal{D} \in \mathcal{O}_{\mathcal{B}} \xrightarrow{\text{L1.2.25.3}} \mathcal{O}_{\mathcal{B}} = \mathcal{O}_{\mathcal{D}}$ and use L 1.2.25.9. \square

Lemma 1.2.25.12. *A geometric object $\mathcal{O} \in \mathfrak{J}$ divides geometric objects $\mathcal{A} \in \mathfrak{J}$ and $\mathcal{B} \in \mathfrak{J}$ iff the generalized rays $\mathcal{O}_{\mathcal{A}}$ and $\mathcal{O}_{\mathcal{B}}$ are disjoint, $\mathcal{O}_{\mathcal{A}} \cap \mathcal{O}_{\mathcal{B}} = \emptyset$, and their union, together with the geometric object \mathcal{O} , gives the set \mathfrak{J} , i.e. $\mathfrak{J} = \mathcal{O}_{\mathcal{A}} \cup \mathcal{O}_{\mathcal{B}} \cup \{\mathcal{O}\}$. That is,*

$$[\mathcal{A}\mathcal{O}\mathcal{B}] \Leftrightarrow (\mathfrak{J} = \mathcal{O}_{\mathcal{A}} \cup \mathcal{O}_{\mathcal{B}} \cup \{\mathcal{O}\}) \& (\mathcal{O}_{\mathcal{A}} \cap \mathcal{O}_{\mathcal{B}} = \emptyset).$$

Proof. Suppose $[\mathcal{A}\mathcal{O}\mathcal{B}]$. If $\mathcal{C} \in \mathfrak{J}$ and $\mathcal{C} \notin \mathcal{O}_{\mathcal{B}}$, $\mathcal{C} \neq \mathcal{O}$ then $[\mathcal{C}\mathcal{O}\mathcal{B}]$ by the definition of the generalized ray $\mathcal{O}_{\mathcal{B}}$. $[\mathcal{C}\mathcal{O}\mathcal{B}] \& [\mathcal{A}\mathcal{O}\mathcal{B}] \xrightarrow{\text{L1.2.25.5}} \neg[\mathcal{C}\mathcal{O}\mathcal{A}] \Rightarrow \mathcal{C} \in \mathcal{O}_{\mathcal{A}}$. $\mathcal{O}_{\mathcal{A}} \cap \mathcal{O}_{\mathcal{B}} = \emptyset$, because otherwise $\mathcal{C} \in \mathcal{O}_{\mathcal{A}} \& \mathcal{C} \in \mathcal{O}_{\mathcal{B}} \xrightarrow{\text{L1.2.25.4}} \mathcal{B} \in \mathcal{O}_{\mathcal{A}} \Rightarrow \neg[\mathcal{A}\mathcal{O}\mathcal{B}]$.

Now suppose $\mathfrak{J} = \mathcal{O}_{\mathcal{A}} \cup \mathcal{O}_{\mathcal{B}} \cup \{\mathcal{O}\}$ and $(\mathcal{O}_{\mathcal{A}} \cap \mathcal{O}_{\mathcal{B}} = \emptyset)$. Then $\mathcal{B} \in \mathcal{O}_{\mathcal{B}} \& \mathcal{O}_{\mathcal{A}} \cap \mathcal{O}_{\mathcal{B}} = \emptyset \Rightarrow \mathcal{B} \notin \mathcal{O}_{\mathcal{A}}$, and $\mathcal{B} \in \mathfrak{J} \& \mathcal{B} \neq \mathcal{O} \& \mathcal{B} \notin \mathcal{O}_{\mathcal{A}} \Rightarrow [\mathcal{A}\mathcal{O}\mathcal{B}]$. \square

Lemma 1.2.25.13. *A generalized ray $\mathcal{O}_{\mathcal{A}}$ contains the generalized open interval $(\mathcal{O}\mathcal{A})$.*

Proof. If $\mathcal{B} \in (\mathcal{O}\mathcal{A})$ then from Pr 1.2.1 $\mathcal{B} \neq \mathcal{O}$ and from Pr 1.2.3 $\neg[\mathcal{B}\mathcal{O}\mathcal{A}]$. We thus have $\mathcal{B} \in \mathcal{O}_{\mathcal{A}}$. \square

Lemma 1.2.25.14. *For any finite set of geometric objects $\{\mathcal{A}_1, \mathcal{A}_2, \dots, \mathcal{A}_n\}$ of a ray $\mathcal{O}_{\mathcal{A}}$ there is a geometric object \mathcal{C} on $\mathcal{O}_{\mathcal{A}}$ not in that set.*

¹³¹Making use of L 1.2.25.6, this statement can be reformulated as follows:

If a geometric object \mathcal{C} lies on $\mathcal{O}_{\mathcal{A}}$, and \mathcal{O} divides the geometric objects \mathcal{A} and \mathcal{D} , then \mathcal{O} divides \mathcal{C} and \mathcal{D} .

¹³²Otherwise there is nothing else to prove

¹³³One could as well have said: If \mathcal{O} lies between \mathcal{A} and \mathcal{C} , as well as between \mathcal{A} and \mathcal{D} ...

Proof. Immediately follows from T 1.2.23 and L 1.2.25.13. \square

Lemma 1.2.25.15. *If a geometric object \mathcal{B} lies between geometric objects \mathcal{O} and \mathcal{A} then the generalized rays $\mathcal{O}_{\mathcal{B}}$ and $\mathcal{O}_{\mathcal{A}}$ are equal.*

Proof. $[\mathcal{OBA}] \stackrel{\text{L1.2.25.13}}{\implies} \mathcal{B} \in \mathcal{O}_{\mathcal{A}} \stackrel{\text{L1.2.25.3}}{\implies} \mathcal{O}_{\mathcal{B}} = \mathcal{O}_{\mathcal{A}}$. \square

Lemma 1.2.25.16. *If a geometric object \mathcal{A} lies between geometric objects \mathcal{O} and \mathcal{B} , the geometric object \mathcal{B} lies on the generalized ray $\mathcal{O}_{\mathcal{A}}$.*

Proof. By Pr 1.2.1, Pr 1.2.3 $[\mathcal{OAB}] \Rightarrow \mathcal{B} \neq \mathcal{O} \ \& \ \neg[\mathcal{BOA}] \Rightarrow \mathcal{B} \in \mathcal{O}_{\mathcal{A}}$.

Alternatively, this lemma can be obtained as an immediate consequence of the preceding one (L 1.2.25.15). \square

Lemma 1.2.25.17. *If generalized rays $\mathcal{O}_{\mathcal{A}}$ and $\mathcal{O}'_{\mathcal{B}}$ are equal, their origins coincide.*

Proof. Suppose $\mathcal{O}' \neq \mathcal{O}$. We have also $\mathcal{O}' \neq \mathcal{O} \ \& \ \mathcal{O}'_{\mathcal{B}} = \mathcal{O}_{\mathcal{A}} \Rightarrow \mathcal{O}' \notin \mathcal{O}_{\mathcal{A}}$. Therefore, $\mathcal{O}' \in \mathfrak{J} \ \& \ \mathcal{O}' \neq \mathcal{O} \ \& \ \mathcal{O}' \notin \mathcal{O}_{\mathcal{A}} \Rightarrow \mathcal{O}' \in \mathcal{O}_{\mathcal{A}}^c$. $\mathcal{O}' \in \mathcal{O}_{\mathcal{A}}^c \ \& \ \mathcal{B} \in \mathcal{O}_{\mathcal{A}} \Rightarrow [\mathcal{O}'\mathcal{O}\mathcal{B}]$. $\mathcal{B} \in \mathcal{O}'_{\mathcal{B}} \ \& \ [\mathcal{O}'\mathcal{O}\mathcal{B}] \stackrel{\text{L1.2.25.13}}{\implies} \mathcal{O} \in \mathcal{O}'_{\mathcal{B}} = \mathcal{O}_{\mathcal{A}}$ - a contradiction. \square

Lemma 1.2.25.18. *If a generalized interval $\mathcal{A}_0\mathcal{A}_n$ is divided into n generalized intervals $\mathcal{A}_0\mathcal{A}_1, \mathcal{A}_1\mathcal{A}_2, \dots, \mathcal{A}_{n-1}\mathcal{A}_n$ (by the geometric objects $\mathcal{A}_1, \mathcal{A}_2, \dots, \mathcal{A}_{n-1}$),¹³⁴ the geometric objects $\mathcal{A}_1, \mathcal{A}_2, \dots, \mathcal{A}_{n-1}, \mathcal{A}_n$ all lie on the same side of the geometric object \mathcal{A}_0 , and the generalized rays $\mathcal{A}_0\mathcal{A}_1, \mathcal{A}_0\mathcal{A}_2, \dots, \mathcal{A}_0\mathcal{A}_n$ are equal.¹³⁵*

Proof. Follows from L 1.2.22.11, L 1.2.25.15. \square

Theorem 1.2.25. *Every generalized ray contains an infinite number of geometric objects.*

Linear Ordering on Generalized Rays

Suppose \mathcal{A}, \mathcal{B} are two geometric objects on a generalized ray $\mathcal{O}_{\mathcal{D}}$. Let, by definition, $(\mathcal{A} \prec \mathcal{B})_{\mathcal{O}_{\mathcal{D}}} \stackrel{\text{def}}{\iff} [\mathcal{OAB}]$. If $\mathcal{A} \prec \mathcal{B}$,¹³⁶ we say that the geometric object \mathcal{A} precedes the geometric object \mathcal{B} on the generalized ray $\mathcal{O}_{\mathcal{D}}$, or that the geometric object \mathcal{B} succeeds the geometric object \mathcal{A} on the generalized ray $\mathcal{O}_{\mathcal{D}}$.

Lemma 1.2.26.1. *If a geometric object \mathcal{A} precedes a geometric object \mathcal{B} on the generalized ray $\mathcal{O}_{\mathcal{D}}$, and \mathcal{B} precedes a geometric object \mathcal{C} on the same generalized ray, then \mathcal{A} precedes \mathcal{C} on $\mathcal{O}_{\mathcal{D}}$:*

$\mathcal{A} \prec \mathcal{B} \ \& \ \mathcal{B} \prec \mathcal{C} \Rightarrow \mathcal{A} \prec \mathcal{C}$, where $\mathcal{A}, \mathcal{B}, \mathcal{C} \in \mathcal{O}_{\mathcal{D}}$.

Proof. $[\mathcal{OAB}] \ \& \ [\mathcal{OBC}] \stackrel{\text{Pr1.2.7}}{\implies} [\mathcal{OAC}]$. \square

Lemma 1.2.26.2. *If \mathcal{A}, \mathcal{B} are two distinct geometric objects on a generalized ray $\mathcal{O}_{\mathcal{D}}$ then either \mathcal{A} precedes \mathcal{B} or \mathcal{B} precedes \mathcal{A} ; if \mathcal{A} precedes \mathcal{B} then \mathcal{B} does not precede \mathcal{A} .*

Proof. $\mathcal{A} \in \mathcal{O}_{\mathcal{D}} \ \& \ \mathcal{B} \in \mathcal{O}_{\mathcal{D}} \stackrel{\text{L1.2.25.8}}{\implies} \mathcal{B} \in \mathcal{O}_{\mathcal{A}} \Rightarrow \neg[\mathcal{AOB}]$. If $\mathcal{A} \neq \mathcal{B}$, then by Pr 1.2.5 $[\mathcal{OAB}] \vee [\mathcal{OBA}]$, that is, $\mathcal{A} \prec \mathcal{B}$ or $\mathcal{B} \prec \mathcal{A}$. $\mathcal{A} \prec \mathcal{B} \Rightarrow [\mathcal{OAB}] \stackrel{\text{Pr1.2.3}}{\implies} \neg[\mathcal{OBA}] \Rightarrow \neg(\mathcal{B} \prec \mathcal{A})$. \square

Lemma 1.2.26.3. *If a geometric object \mathcal{B} lies on a generalized ray $\mathcal{O}_{\mathcal{P}}$ between geometric objects \mathcal{A} and \mathcal{C} ,¹³⁷ then either \mathcal{A} precedes \mathcal{B} and \mathcal{B} precedes \mathcal{C} , or \mathcal{C} precedes \mathcal{B} and \mathcal{B} precedes \mathcal{A} ; conversely, if \mathcal{A} precedes \mathcal{B} and \mathcal{B} precedes \mathcal{C} , or \mathcal{C} precedes \mathcal{B} and \mathcal{B} precedes \mathcal{A} , then \mathcal{B} lies between \mathcal{A} and \mathcal{C} . That is,*

$[\mathcal{ABC}] \iff (\mathcal{A} \prec \mathcal{B} \ \& \ \mathcal{B} \prec \mathcal{C}) \vee (\mathcal{C} \prec \mathcal{B} \ \& \ \mathcal{B} \prec \mathcal{A})$.

Proof. From the preceding lemma (L 1.2.26.2) we know that either $\mathcal{A} \prec \mathcal{C}$ or $\mathcal{C} \prec \mathcal{A}$, i.e. $[\mathcal{OAC}]$ or $[\mathcal{OCA}]$. Suppose $[\mathcal{OAC}]$.¹³⁸ Then $[\mathcal{OAC}] \ \& \ [\mathcal{ABC}] \stackrel{\text{Pr1.2.7}}{\implies} [\mathcal{AOB}] \ \& \ [\mathcal{OBC}] \Rightarrow \mathcal{A} \prec \mathcal{B} \ \& \ \mathcal{B} \prec \mathcal{C}$. Conversely, $\mathcal{A} \prec \mathcal{B} \ \& \ \mathcal{B} \prec \mathcal{C} \Rightarrow [\mathcal{OAB}] \ \& \ [\mathcal{OBC}] \stackrel{\text{Pr1.2.7}}{\implies} [\mathcal{ABC}]$. \square

For geometric objects \mathcal{A}, \mathcal{B} on a generalized ray $\mathcal{O}_{\mathcal{D}}$ we let, by definition, $\mathcal{A} \preceq \mathcal{B} \stackrel{\text{def}}{\iff} (\mathcal{A} \prec \mathcal{B}) \vee (\mathcal{A} = \mathcal{B})$.

Theorem 1.2.26. *Every generalized ray is a chain with respect to the relation \preceq .*

Proof. $\mathcal{A} \preceq \mathcal{A}$. $(\mathcal{A} \preceq \mathcal{B}) \ \& \ (\mathcal{B} \preceq \mathcal{A}) \stackrel{\text{L1.2.26.2}}{\implies} \mathcal{A} = \mathcal{B}$; $(\mathcal{A} \prec \mathcal{B}) \ \& \ (\mathcal{B} \prec \mathcal{A}) \stackrel{\text{L1.2.26.1}}{\implies} \mathcal{A} \prec \mathcal{C}$; $\mathcal{A} \neq \mathcal{B} \stackrel{\text{L1.2.26.2}}{\implies} (\mathcal{A} \prec \mathcal{B}) \vee (\mathcal{B} \prec \mathcal{A})$. \square

¹³⁴In other words, a finite sequence of geometric objects \mathcal{A}_i , where $i + 1 \in \mathbb{N}_{n-1}$, $n \geq 4$, has the property that every geometric object of the sequence, except for the first and the last, lies between the two geometric objects with adjacent (in \mathbb{N}) numbers.

¹³⁵By the same token, we can assert also that the geometric objects $\mathcal{A}_0, \mathcal{A}_1, \dots, \mathcal{A}_{n-1}$ lie on the same side of the geometric object \mathcal{A}_n , but due to symmetry, this adds essentially nothing new to the statement of the lemma.

¹³⁶In most instances in what follows we will assume the generalized ray $\mathcal{O}_{\mathcal{D}}$ (or some other generalized ray) fixed and omit the mention of it in our notation.

¹³⁷In fact, once we require that $\mathcal{A}, \mathcal{C} \in \mathcal{O}_{\mathcal{P}}$ and $[\mathcal{ABC}]$, this ensures that $\mathcal{B} \in \mathcal{O}_{\mathcal{P}}$. (To establish this, we can combine $[\mathcal{OBC}]$ shown below with, say, L 1.2.25.3, L 1.2.25.13.) This observation will be referred to in the footnote accompanying proof of T 1.2.28.

¹³⁸Since $[\mathcal{ABC}]$ and $[\mathcal{CBA}]$ are equivalent in view of Pr 1.2.1, we do not need to consider the case $[\mathcal{OCA}]$ separately.

Linear Ordering on Sets With Generalized Betweenness Relation

Let $\mathcal{O} \in \mathfrak{J}$, $\mathcal{P} \in \mathfrak{J}$, $[\mathcal{P}\mathcal{O}\mathcal{Q}]$. Define the relation of direct (inverse) ordering on the set \mathfrak{J} , which admits a generalized betweenness relation, as follows:

Call $\mathcal{O}_{\mathcal{P}}$ the first generalized ray, and $\mathcal{O}_{\mathcal{Q}}$ the second generalized ray. A geometric object \mathcal{A} precedes a geometric object \mathcal{B} in the set \mathfrak{J} in the direct (inverse) order iff:

- Both \mathcal{A} and \mathcal{B} lie on the first (second) generalized ray and \mathcal{B} precedes \mathcal{A} on it; or
- \mathcal{A} lies on the first (second) generalized ray, and \mathcal{B} lies on the second (first) generalized ray or coincides with \mathcal{O} ;

or

- $\mathcal{A} = \mathcal{O}$ and \mathcal{B} lies on the second (first) generalized ray; or
- Both \mathcal{A} and \mathcal{B} lie on the second (first) generalized ray, and \mathcal{A} precedes \mathcal{B} on it.

Thus, a formal definition of the direct ordering on the set \mathfrak{J} can be written down as follows:

$$(\mathcal{A} \prec_1 \mathcal{B})_{\mathfrak{J}} \stackrel{\text{def}}{\iff} (\mathcal{A} \in \mathcal{O}_{\mathcal{P}} \& \mathcal{B} \in \mathcal{O}_{\mathcal{P}} \& \mathcal{B} \prec \mathcal{A}) \vee (\mathcal{A} \in \mathcal{O}_{\mathcal{P}} \& \mathcal{B} = \mathcal{O}) \vee (\mathcal{A} \in \mathcal{O}_{\mathcal{P}} \& \mathcal{B} \in \mathcal{O}_{\mathcal{Q}}) \vee (\mathcal{A} = \mathcal{O} \& \mathcal{B} \in \mathcal{O}_{\mathcal{Q}}) \vee (\mathcal{A} \in \mathcal{O}_{\mathcal{Q}} \& \mathcal{B} \in \mathcal{O}_{\mathcal{Q}} \& \mathcal{A} \prec \mathcal{B}),$$

$$\text{and for the inverse ordering: } (\mathcal{A} \prec_2 \mathcal{B})_{\mathfrak{J}} \stackrel{\text{def}}{\iff} (\mathcal{A} \in \mathcal{O}_{\mathcal{Q}} \& \mathcal{B} \in \mathcal{O}_{\mathcal{Q}} \& \mathcal{B} \prec \mathcal{A}) \vee (\mathcal{A} \in \mathcal{O}_{\mathcal{Q}} \& \mathcal{B} = \mathcal{O}) \vee (\mathcal{A} \in \mathcal{O}_{\mathcal{Q}} \& \mathcal{B} \in \mathcal{O}_{\mathcal{P}}) \vee (\mathcal{A} = \mathcal{O} \& \mathcal{B} \in \mathcal{O}_{\mathcal{P}}) \vee (\mathcal{A} \in \mathcal{O}_{\mathcal{P}} \& \mathcal{B} \in \mathcal{O}_{\mathcal{P}} \& \mathcal{A} \prec \mathcal{B}).$$

The term "inverse order" is justified by the following trivial

Lemma 1.2.27.1. *\mathcal{A} precedes \mathcal{B} in the inverse order iff \mathcal{B} precedes \mathcal{A} in the direct order.*

For our notions of order (both direct and inverse) on the set \mathfrak{J} to be well defined, they have to be independent, at least to some extent, on the choice of the origin \mathcal{O} , as well as on the choice of the ray-defining geometric objects \mathcal{P} and \mathcal{Q} .

Toward this end, let $\mathcal{O}' \in \mathfrak{J}$, $\mathcal{P}' \in \mathfrak{J}$, $[\mathcal{P}'\mathcal{O}'\mathcal{Q}']$, and define a new direct (inverse) ordering with displaced origin (ODO) on the set \mathfrak{J} , as follows:

Call \mathcal{O}' the displaced origin, $\mathcal{O}'_{\mathcal{P}'}$ and $\mathcal{O}'_{\mathcal{Q}'}$ the first and the second displaced generalized rays, respectively. A geometric object \mathcal{A} precedes a geometric object \mathcal{B} in the set \mathfrak{J} in the direct (inverse) ODO iff:

- Both \mathcal{A} and \mathcal{B} lie on the first (second) displaced generalized ray, and \mathcal{B} precedes \mathcal{A} on it; or
- \mathcal{A} lies on the first (second) displaced generalized ray, and \mathcal{B} lies on the second (first) displaced generalized ray or coincides with \mathcal{O}' ; or

- $\mathcal{A} = \mathcal{O}'$ and \mathcal{B} lies on the second (first) displaced generalized ray; or
- Both \mathcal{A} and \mathcal{B} lie on the second (first) displaced generalized ray, and \mathcal{A} precedes \mathcal{B} on it.

Thus, a formal definition of the direct ODO on the set \mathfrak{J} can be written down as follows:

$$(\mathcal{A} \prec'_1 \mathcal{B})_{\mathfrak{J}} \stackrel{\text{def}}{\iff} (\mathcal{A} \in \mathcal{O}'_{\mathcal{P}'} \& \mathcal{B} \in \mathcal{O}'_{\mathcal{P}'} \& \mathcal{B} \prec \mathcal{A}) \vee (\mathcal{A} \in \mathcal{O}'_{\mathcal{P}'} \& \mathcal{B} = \mathcal{O}') \vee (\mathcal{A} \in \mathcal{O}'_{\mathcal{P}'} \& \mathcal{B} \in \mathcal{O}'_{\mathcal{Q}'}) \vee (\mathcal{A} = \mathcal{O}' \& \mathcal{B} \in \mathcal{O}'_{\mathcal{Q}'}) \vee (\mathcal{A} \in \mathcal{O}'_{\mathcal{Q}'} \& \mathcal{B} \in \mathcal{O}'_{\mathcal{Q}'} \& \mathcal{A} \prec \mathcal{B}),$$

$$\text{and for the inverse ordering: } (\mathcal{A} \prec'_2 \mathcal{B})_{\mathfrak{J}} \stackrel{\text{def}}{\iff} (\mathcal{A} \in \mathcal{O}'_{\mathcal{Q}'} \& \mathcal{B} \in \mathcal{O}'_{\mathcal{Q}'} \& \mathcal{B} \prec \mathcal{A}) \vee (\mathcal{A} \in \mathcal{O}'_{\mathcal{Q}'} \& \mathcal{B} = \mathcal{O}') \vee (\mathcal{A} \in \mathcal{O}'_{\mathcal{Q}'} \& \mathcal{B} \in \mathcal{O}'_{\mathcal{P}'}) \vee (\mathcal{A} = \mathcal{O}' \& \mathcal{B} \in \mathcal{O}'_{\mathcal{P}'}) \vee (\mathcal{A} \in \mathcal{O}'_{\mathcal{P}'} \& \mathcal{B} \in \mathcal{O}'_{\mathcal{P}'} \& \mathcal{A} \prec \mathcal{B}).$$

Lemma 1.2.27.2. *If the displaced generalized ray origin \mathcal{O}' lies on the generalized ray $\mathcal{O}_{\mathcal{P}}$ and between \mathcal{O} and \mathcal{P}' , then the generalized ray $\mathcal{O}_{\mathcal{P}}$ contains the generalized ray $\mathcal{O}'_{\mathcal{P}'}$, $\mathcal{O}'_{\mathcal{P}'} \subset \mathcal{O}_{\mathcal{P}}$.*

Proof. $\mathcal{A} \in \mathcal{O}'_{\mathcal{P}'} \Rightarrow \mathcal{A} \in \mathcal{O}_{\mathcal{P}}$, because otherwise $\mathcal{A} \neq \mathcal{O}$ & $\mathcal{A} \notin \mathcal{O}_{\mathcal{P}}$ & $\mathcal{O}' \in \mathcal{O}_{\mathcal{P}} \stackrel{\text{L1.2.25.9}}{\implies} [\mathcal{A}\mathcal{O}\mathcal{O}']$ and $[\mathcal{A}\mathcal{O}\mathcal{O}'] \& [\mathcal{O}\mathcal{O}'\mathcal{P}'] \stackrel{\text{Pr1.2.7}}{\implies} [\mathcal{A}\mathcal{O}'\mathcal{P}'] \Rightarrow \mathcal{A} \notin \mathcal{O}'_{\mathcal{P}'}$. \square

Lemma 1.2.27.3. *Let the displaced origin \mathcal{O}' be chosen in such a way that \mathcal{O}' lies on the generalized ray $\mathcal{O}_{\mathcal{P}}$, and the geometric object \mathcal{O} lies on the ray $\mathcal{O}'_{\mathcal{Q}'}$. If a geometric object \mathcal{B} lies on both generalized rays $\mathcal{O}_{\mathcal{P}}$ and $\mathcal{O}'_{\mathcal{Q}'}$, then it divides \mathcal{O} and \mathcal{O}' .*

Proof. $\mathcal{O}' \in \mathcal{O}_{\mathcal{P}} \& \mathcal{B} \in \mathcal{O}_{\mathcal{P}} \& \mathcal{O} \in \mathcal{O}'_{\mathcal{Q}'} \& \mathcal{B} \in \mathcal{O}'_{\mathcal{Q}'} \stackrel{\text{L1.2.25.8}}{\implies} \neg[\mathcal{O}'\mathcal{O}\mathcal{B}] \& \neg[\mathcal{O}\mathcal{O}'\mathcal{B}]$, whence by Pr 1.2.5 $\Rightarrow [\mathcal{O}\mathcal{B}\mathcal{O}']$. \square

Lemma 1.2.27.4. *An ordering with the displaced origin \mathcal{O}' on a set \mathfrak{J} which admits a generalized betweenness relation, coincides with either direct or inverse ordering on that set (depending on the choice of the displaced generalized rays). In other words, either for all geometric objects \mathcal{A}, \mathcal{B} in \mathfrak{J} we have that \mathcal{A} precedes \mathcal{B} in the ODO iff \mathcal{A} precedes \mathcal{B} in the direct order; or for all geometric objects \mathcal{A}, \mathcal{B} in \mathfrak{J} we have that \mathcal{A} precedes \mathcal{B} in the ODO iff \mathcal{A} precedes \mathcal{B} in the inverse order.*

Proof. Let $\mathcal{O}' \in \mathcal{O}_{\mathcal{P}}$, $\mathcal{O} \in \mathcal{O}'_{\mathcal{Q}'}$, $(\mathcal{A} \prec'_1 \mathcal{B})_{\mathfrak{J}}$. Then $[\mathcal{P}'\mathcal{O}'\mathcal{Q}'] \& \mathcal{O} \in \mathcal{O}'_{\mathcal{Q}'} \stackrel{\text{L1.2.25.9}}{\implies} [\mathcal{O}\mathcal{O}'\mathcal{P}']$ and $\mathcal{O}' \in \mathcal{O}_{\mathcal{P}} \& [\mathcal{O}\mathcal{O}'\mathcal{P}'] \stackrel{\text{L1.2.27.2}}{\implies} \mathcal{O}'_{\mathcal{P}'} \subset \mathcal{O}_{\mathcal{P}}$.

Suppose $\mathcal{A} \in \mathcal{O}'_{\mathcal{P}'}$, $\mathcal{B} \in \mathcal{O}'_{\mathcal{P}'}$. $\mathcal{A} \in \mathcal{O}'_{\mathcal{P}'} \& \mathcal{B} \in \mathcal{O}'_{\mathcal{P}'} \& \mathcal{O}'_{\mathcal{P}'} \subset \mathcal{O}_{\mathcal{P}} \Rightarrow \mathcal{A} \in \mathcal{O}_{\mathcal{P}} \& \mathcal{B} \in \mathcal{O}_{\mathcal{P}}$. $\mathcal{A} \in \mathcal{O}'_{\mathcal{P}'} \& \mathcal{B} \in \mathcal{O}'_{\mathcal{P}'} \& (\mathcal{A} \prec'_1 \mathcal{B})_{\mathfrak{J}} \Rightarrow (\mathcal{B} \prec \mathcal{A})_{\mathcal{O}'_{\mathcal{P}'}} \Rightarrow [\mathcal{O}'\mathcal{B}\mathcal{A}]$. $\mathcal{B} \in \mathcal{O}'_{\mathcal{P}'} \& \mathcal{O} \in \mathcal{O}'_{\mathcal{Q}'} \stackrel{\text{L1.2.25.11}}{\implies} [\mathcal{O}\mathcal{O}'\mathcal{B}]$, $[\mathcal{O}\mathcal{O}'\mathcal{B}] \& [\mathcal{O}'\mathcal{B}\mathcal{A}] \stackrel{\text{Pr1.2.6}}{\implies} (\mathcal{B} \prec \mathcal{A})_{\mathcal{O}_{\mathcal{P}}} \Rightarrow (\mathcal{A} \prec_1 \mathcal{B})_{\mathfrak{J}}$.

Suppose $\mathcal{A} \in \mathcal{O}'_{\mathcal{P}'}$ & $\mathcal{B} = \mathcal{O}'$. $\mathcal{A} \in \mathcal{O}'_{\mathcal{P}'} \& \mathcal{B} = \mathcal{O}' \& \mathcal{O} \in \mathcal{O}'_{\mathcal{Q}'} \stackrel{\text{L1.2.25.11}}{\implies} [\mathcal{O}\mathcal{B}\mathcal{A}] \Rightarrow (\mathcal{A} \prec_1 \mathcal{B})_{\mathfrak{J}}$.

Suppose $\mathcal{A} \in \mathcal{O}'_{\mathcal{P}'}$, $\mathcal{B} \in \mathcal{O}'_{\mathcal{Q}'}$. $\mathcal{A} \in \mathcal{O}_{\mathcal{P}} \& (\mathcal{B} = \mathcal{O} \vee \mathcal{B} \in \mathcal{O}_{\mathcal{Q}}) \Rightarrow (\mathcal{A} \prec_1 \mathcal{B})_{\mathfrak{J}}$. If $\mathcal{B} \in \mathcal{O}_{\mathcal{P}}$ then $\mathcal{O}' \in \mathcal{O}_{\mathcal{P}} \& \mathcal{O} \in \mathcal{O}'_{\mathcal{Q}'} \& \mathcal{B} \in \mathcal{O}_{\mathcal{P}} \& \mathcal{B} \in \mathcal{O}'_{\mathcal{Q}'} \stackrel{\text{L1.2.27.3}}{\implies} [\mathcal{O}'\mathcal{B}\mathcal{O}]$ and $[\mathcal{A}\mathcal{O}'\mathcal{B}] \& [\mathcal{O}'\mathcal{B}\mathcal{O}] \stackrel{\text{Pr1.2.6}}{\implies} [\mathcal{A}\mathcal{B}\mathcal{O}] \Rightarrow (\mathcal{A} \prec_1 \mathcal{B})_{\mathfrak{J}}$. ¹³⁹

¹³⁹We take into account that $\mathcal{A} \in \mathcal{O}'_{\mathcal{P}'}$ & $\mathcal{B} \in \mathcal{O}'_{\mathcal{Q}'} \stackrel{\text{L1.2.25.11}}{\implies} [\mathcal{A}\mathcal{O}'\mathcal{B}]$.

Suppose $\mathcal{A}, \mathcal{B} \in \mathcal{O}'_{\mathcal{Q}}$. $(\mathcal{A} \prec_1 \mathcal{B})_{\mathfrak{J}} \Rightarrow (\mathcal{A} \prec \mathcal{B})_{\mathcal{O}'_{\mathcal{Q}}} \Rightarrow [\mathcal{O}'\mathcal{A}\mathcal{B}]$. If $\mathcal{A} \in \mathcal{O}_{\mathcal{P}}$ and $\mathcal{B} \in \mathcal{O}_{\mathcal{P}}$ then by L 1.2.27.3 $[\mathcal{O}'\mathcal{B}\mathcal{O}]$ and $[\mathcal{O}'\mathcal{B}\mathcal{O}] \& [\mathcal{O}'\mathcal{A}\mathcal{B}] \xrightarrow{\text{Pr1.2.7}} [\mathcal{A}\mathcal{B}\mathcal{O}] \Rightarrow (\mathcal{A} \prec_1 \mathcal{B})_{\mathfrak{J}}$. $(\mathcal{A} \in \mathcal{O}_{\mathcal{P}} \& \mathcal{B} = \mathcal{O}) \vee (\mathcal{A} \in \mathcal{O}_{\mathcal{P}} \& \mathcal{B} \in \mathcal{O}_{\mathcal{Q}}) \vee (\mathcal{A} = \mathcal{O} \& \mathcal{B} \in \mathcal{O}_{\mathcal{Q}}) \Rightarrow (\mathcal{A} \prec_1 \mathcal{B})_{\mathfrak{J}}$. Now let $\mathcal{A} \in \mathcal{O}_{\mathcal{Q}}, \mathcal{B} \in \mathcal{O}_{\mathcal{Q}}$. Then $\neg[\mathcal{A}\mathcal{O}\mathcal{B}]; \neg[\mathcal{O}\mathcal{B}\mathcal{A}]$, because $[\mathcal{O}\mathcal{B}\mathcal{A}] \& [\mathcal{B}\mathcal{A}\mathcal{O}'] \xrightarrow{\text{Pr1.2.6}} [\mathcal{O}'\mathcal{B}\mathcal{O}] \xrightarrow{\text{Pr1.2.3}} \neg[\mathcal{B}\mathcal{O}\mathcal{O}'] \Rightarrow \mathcal{O}' \in \mathcal{O}_{\mathcal{B}}$ and $\mathcal{B} \in \mathcal{O}_{\mathcal{Q}} \& \mathcal{O}' \in \mathcal{O}_{\mathcal{B}} \Rightarrow \mathcal{O}' \in \mathcal{O}_{\mathcal{Q}}$. Finally, $\neg[\mathcal{A}\mathcal{O}\mathcal{B}] \& \neg[\mathcal{O}\mathcal{B}\mathcal{A}] \xrightarrow{\text{Pr1.2.5}} [\mathcal{O}\mathcal{A}\mathcal{B}] \Rightarrow (\mathcal{A} \prec_1 \mathcal{B})_{\mathfrak{J}}$. \square

Lemma 1.2.27.5. *Let \mathcal{A}, \mathcal{B} be two distinct geometric objects in a set \mathfrak{J} , which admits a generalized betweenness relation, and on which some direct or inverse order is defined. Then either \mathcal{A} precedes \mathcal{B} in that order, or \mathcal{B} precedes \mathcal{A} , and if \mathcal{A} precedes \mathcal{B} , \mathcal{B} does not precede \mathcal{A} , and vice versa.*

Proof. \square

Lemma 1.2.27.6. *If a geometric object \mathcal{A} precedes a geometric object \mathcal{B} on set line \mathfrak{J} with generalized betweenness relation, and \mathcal{B} precedes a geometric object \mathcal{C} in the same set, then \mathcal{A} precedes \mathcal{C} on \mathfrak{J} :*

$$\mathcal{A} \prec \mathcal{B} \& \mathcal{B} \prec \mathcal{C} \Rightarrow \mathcal{A} \prec \mathcal{C}, \text{ where } \mathcal{A}, \mathcal{B}, \mathcal{C} \in \mathfrak{J}.$$

Proof. Follows from the definition of the precedence relation \prec (on sets with generalized betweenness relation) and L 1.2.26.1. ¹⁴⁰ \square

For geometric objects \mathcal{A}, \mathcal{B} in a set \mathfrak{J} , which admits a generalized betweenness relation, and where some direct or inverse order is defined, we let $\mathcal{A} \prec_i \mathcal{B} \stackrel{\text{def}}{\iff} (\mathcal{A} \prec_i \mathcal{B}) \vee (\mathcal{A} = \mathcal{B})$, where $i = 1$ for the direct order and $i = 2$ for the inverse order.

Theorem 1.2.27. *Every set \mathfrak{J} , which admits a generalized betweenness relation, and equipped with a direct or inverse order, is a chain with respect to the relation \prec_i .*

Proof. \square

Theorem 1.2.28. *If a geometric object \mathcal{B} lies between geometric objects \mathcal{A} and \mathcal{C} , then in any ordering of the kind defined above, defined on the set \mathfrak{J} , containing these geometric objects, either \mathcal{A} precedes \mathcal{B} and \mathcal{B} precedes \mathcal{C} , or \mathcal{C} precedes \mathcal{B} and \mathcal{B} precedes \mathcal{A} ; conversely, if in some order, defined on the set \mathfrak{J} admitting a generalized betweenness relation and containing geometric objects $\mathcal{A}, \mathcal{B}, \mathcal{C}$, \mathcal{A} precedes \mathcal{B} and \mathcal{B} precedes \mathcal{C} , or \mathcal{C} precedes \mathcal{B} and \mathcal{B} precedes \mathcal{A} , then \mathcal{B} lies between \mathcal{A} and \mathcal{C} . That is,*

$$\forall \mathcal{A}, \mathcal{B}, \mathcal{C} \in \mathfrak{J} [\mathcal{A}\mathcal{B}\mathcal{C}] \Leftrightarrow (\mathcal{A} \prec \mathcal{B} \& \mathcal{B} \prec \mathcal{C}) \vee (\mathcal{C} \prec \mathcal{B} \& \mathcal{B} \prec \mathcal{A}).$$

Proof. Suppose $[\mathcal{A}\mathcal{B}\mathcal{C}]$. ¹⁴¹

For $\mathcal{A}, \mathcal{B}, \mathcal{C} \in \mathcal{O}_{\mathcal{P}}$ and $\mathcal{A}, \mathcal{B}, \mathcal{C} \in \mathcal{O}_{\mathcal{Q}}$ see L 1.2.26.3.

If $\mathcal{A}, \mathcal{B} \in \mathcal{O}_{\mathcal{P}}, \mathcal{C} = \mathcal{O}$ then $[\mathcal{A}\mathcal{B}\mathcal{O}] \Rightarrow (\mathcal{B} \prec \mathcal{A})_{\mathcal{O}_{\mathcal{P}}} \Rightarrow (\mathcal{A} \prec \mathcal{B})_{\mathfrak{J}}$; also $\mathcal{B} \prec \mathcal{C}$ in this case from definition of order on line.

If $\mathcal{A}, \mathcal{B} \in \mathcal{O}_{\mathcal{P}}, \mathcal{C} \in \mathcal{O}_{\mathcal{Q}}$ then $[\mathcal{A}\mathcal{B}\mathcal{C}] \& [\mathcal{B}\mathcal{O}\mathcal{C}] \xrightarrow{\text{Pr1.2.7}} [\mathcal{A}\mathcal{B}\mathcal{O}] \Rightarrow (\mathcal{A} \prec \mathcal{B})_{\mathfrak{J}}$ and $\mathcal{B} \in \mathcal{O}_{\mathcal{P}} \& \mathcal{C} \in \mathcal{O}_{\mathcal{Q}} \Rightarrow (\mathcal{B} \prec \mathcal{C})_{\mathfrak{J}}$.

For $\mathcal{A} \in \mathcal{O}_{\mathcal{P}}, \mathcal{B} = \mathcal{O}, \mathcal{C} \in \mathcal{O}_{\mathcal{Q}}$ see definition of order on line.

For $\mathcal{A} \in \mathcal{O}_{\mathcal{P}}, \mathcal{B}, \mathcal{C} \in \mathcal{O}_{\mathcal{Q}}$ we have $[\mathcal{A}\mathcal{O}\mathcal{B}] \& [\mathcal{A}\mathcal{B}\mathcal{C}] \xrightarrow{\text{Pr1.2.7}} [\mathcal{O}\mathcal{B}\mathcal{C}] \Rightarrow \mathcal{B} \prec \mathcal{C}$.

If $\mathcal{A} = \mathcal{O}$ and $\mathcal{B}, \mathcal{C} \in \mathcal{O}_{\mathcal{Q}}$, we have $[\mathcal{O}\mathcal{B}\mathcal{C}] \Rightarrow \mathcal{B} \prec \mathcal{C}$.

Conversely, suppose $\mathcal{A} \prec \mathcal{B}$ and $\mathcal{B} \prec \mathcal{C}$ in the given direct order on \mathfrak{J} . ¹⁴²

For $\mathcal{A}, \mathcal{B}, \mathcal{C} \in \mathcal{O}_{\mathcal{P}}$ and $\mathcal{A}, \mathcal{B}, \mathcal{C} \in \mathcal{O}_{\mathcal{Q}}$ see L 1.2.26.3.

If $\mathcal{A}, \mathcal{B} \in \mathcal{O}_{\mathcal{P}}, \mathcal{C} = \mathcal{O}$ then $(\mathcal{A} \prec \mathcal{B})_{\mathfrak{J}} \Rightarrow (\mathcal{B} \prec \mathcal{A})_{\mathcal{O}_{\mathcal{P}}} \Rightarrow [\mathcal{A}\mathcal{B}\mathcal{O}]$.

If $\mathcal{A}, \mathcal{B} \in \mathcal{O}_{\mathcal{P}}, \mathcal{C} \in \mathcal{O}_{\mathcal{Q}}$ then $[\mathcal{A}\mathcal{B}\mathcal{O}] \& [\mathcal{B}\mathcal{O}\mathcal{C}] \xrightarrow{\text{Pr1.2.6}} [\mathcal{A}\mathcal{B}\mathcal{C}]$.

For $\mathcal{A} \in \mathcal{O}_{\mathcal{P}}, \mathcal{B} = \mathcal{O}, \mathcal{C} \in \mathcal{O}_{\mathcal{Q}}$ we immediately have $[\mathcal{A}\mathcal{B}\mathcal{C}]$ from L 1.2.25.11.

For $\mathcal{A} \in \mathcal{O}_{\mathcal{P}}, \mathcal{B}, \mathcal{C} \in \mathcal{O}_{\mathcal{Q}}$ we have $[\mathcal{A}\mathcal{O}\mathcal{B}] \& [\mathcal{O}\mathcal{B}\mathcal{C}] \xrightarrow{\text{Pr1.2.6}} [\mathcal{A}\mathcal{B}\mathcal{C}]$.

If $\mathcal{A} = \mathcal{O}$ and $\mathcal{B}, \mathcal{C} \in \mathcal{O}_{\mathcal{Q}}$, we have $\mathcal{B} \prec \mathcal{C} \Rightarrow [\mathcal{O}\mathcal{B}\mathcal{C}]$. \square

¹⁴⁰The following trivial observations may be helpful in limiting the number of cases one has to consider: As before, denote $\mathcal{O}_{\mathcal{P}}, \mathcal{O}_{\mathcal{Q}}$ respectively, the first and the second ray for the given direct order on \mathfrak{J} . If a geometric object $\mathcal{A} \in \{\mathcal{O}\} \cup \mathcal{O}_{\mathcal{Q}}$ precedes a geometric object $\mathcal{B} \in \mathfrak{J}$, then $\mathcal{B} \in \mathcal{O}_{\mathcal{Q}}$. If a geometric object \mathcal{A} precedes a geometric object $\mathcal{B} \in \mathcal{O}_{\mathcal{P}} \cup \{\mathcal{O}\}$, then $\mathcal{A} \in \mathcal{O}_{\mathcal{P}}$.

¹⁴¹Again, we denote $\mathcal{O}_{\mathcal{P}}, \mathcal{O}_{\mathcal{Q}}$ respectively, the first and the second generalized ray for the given order on \mathfrak{J} . The following trivial observations help limit the number of cases we have to consider: If $\mathcal{A} \in \mathcal{O}_{\mathcal{P}}$ and $\mathcal{C} \in \mathcal{O}_{\mathcal{P}} \cup \{\mathcal{O}\}$ then $[\mathcal{A}\mathcal{B}\mathcal{C}]$ implies $\mathcal{B} \in \mathcal{O}_{\mathcal{P}}$. Similarly, if $\mathcal{A} \in \{\mathcal{O}\} \cup \mathcal{O}_{\mathcal{Q}}$ and $\mathcal{C} \in \mathcal{O}_{\mathcal{Q}}$ then $[\mathcal{A}\mathcal{B}\mathcal{C}]$ implies $\mathcal{B} \in \mathcal{O}_{\mathcal{Q}}$. In fact, in the case $\mathcal{A} \in \mathcal{O}_{\mathcal{P}}, \mathcal{C} = \mathcal{O}$ this can be seen immediately using, say, L 1.2.25.3. For $\mathcal{A}, \mathcal{C} \in \mathcal{O}_{\mathcal{P}}$ we conclude that $\mathcal{B} \in \mathcal{O}_{\mathcal{P}}$ once $[\mathcal{A}\mathcal{B}\mathcal{C}]$ immediately from L 1.2.30.4, which, of course, does not use the present lemma or any results following from it. Alternatively, this can be shown using proof of L 1.2.26.3 - see footnote accompanying that lemma.

¹⁴²Taking into account the following two facts lowers the number of cases to consider (cf. proof of L 1.2.27.6): If a geometric object $\mathcal{A} \in \{\mathcal{O}\} \cup \mathcal{O}_{\mathcal{Q}}$ precedes a geometric object $\mathcal{B} \in \mathfrak{J}$, then $\mathcal{B} \in \mathcal{O}_{\mathcal{Q}}$. If a geometric object \mathcal{A} precedes a geometric object $\mathcal{B} \in \mathcal{O}_{\mathcal{P}} \cup \{\mathcal{O}\}$, then $\mathcal{A} \in \mathcal{O}_{\mathcal{P}}$.

Complementary Generalized Rays

Lemma 1.2.29.1. *A generalized interval $(\mathcal{O}\mathcal{A})$ is the intersection of the generalized rays $\mathcal{O}\mathcal{A}$ and $\mathcal{A}\mathcal{O}$, i.e. $(\mathcal{O}\mathcal{A}) = \mathcal{O}\mathcal{A} \cap \mathcal{A}\mathcal{O}$.*

Proof. $\mathcal{B} \in (\mathcal{O}\mathcal{A}) \Rightarrow [\mathcal{O}\mathcal{B}\mathcal{A}]$, whence by Pr 1.2.1, Pr 1.2.3 $\mathcal{B} \neq \mathcal{O}$, $\mathcal{B} \neq \mathcal{A}$, $\neg[\mathcal{B}\mathcal{O}\mathcal{A}]$, and $\neg[\mathcal{B}\mathcal{A}\mathcal{O}]$, which means $\mathcal{B} \in \mathcal{O}\mathcal{A}$ and $\mathcal{B} \in \mathcal{A}\mathcal{O}$.

Suppose now $\mathcal{B} \in \mathcal{O}\mathcal{A} \cap \mathcal{A}\mathcal{O}$. Hence $\mathcal{B} \neq \mathcal{O}$, $\neg[\mathcal{B}\mathcal{O}\mathcal{A}]$ and $\mathcal{B} \neq \mathcal{A}$, $\neg[\mathcal{B}\mathcal{A}\mathcal{O}]$. Since $\mathcal{O}, \mathcal{A}, \mathcal{B}$ are distinct, by Pr 1.2.5 $[\mathcal{B}\mathcal{O}\mathcal{A}] \vee [\mathcal{B}\mathcal{A}\mathcal{O}] \vee [\mathcal{O}\mathcal{B}\mathcal{A}]$. But since $\neg[\mathcal{B}\mathcal{O}\mathcal{A}]$, $\neg[\mathcal{B}\mathcal{A}\mathcal{O}]$, we find that $[\mathcal{O}\mathcal{B}\mathcal{A}]$. \square

Given a generalized ray $\mathcal{O}\mathcal{A}$, define the generalized ray $\mathcal{O}\mathcal{A}^{c(\mathfrak{J})}$ (usually written simply as $\mathcal{O}\mathcal{A}^c$ ¹⁴³), complementary in the set \mathfrak{J} to the generalized ray $\mathcal{O}\mathcal{A}$, as $\mathcal{O}\mathcal{A}^c = \mathfrak{J} \setminus (\{\mathcal{O}\} \cup \mathcal{O}\mathcal{A})$. In other words, the generalized ray $\mathcal{O}\mathcal{A}^c$, complementary to the generalized ray $\mathcal{O}\mathcal{A}$, is the set of all geometric objects lying in the set \mathfrak{J} on the opposite side of the geometric object \mathcal{O} from the geometric object \mathcal{A} . An equivalent definition is provided by

Lemma 1.2.29.2. $\mathcal{O}\mathcal{A}^c = \{\mathcal{B} | [\mathcal{B}\mathcal{O}\mathcal{A}]\}$. We can also write $\mathcal{O}\mathcal{A}^c = \mathcal{O}\mathcal{D}$ for any geometric object $\mathcal{D} \in \mathfrak{J}$ such that $[\mathcal{D}\mathcal{O}\mathcal{A}]$.

Proof. See L 1.2.25.6, L 1.2.25.3. \square

Lemma 1.2.29.3. *The generalized ray $(\mathcal{O}\mathcal{A}^c)^c$, complementary to the generalized ray $\mathcal{O}\mathcal{A}^c$, complementary to the given generalized ray $\mathcal{O}\mathcal{A}$, coincides with the generalized ray $\mathcal{O}\mathcal{A}$: $(\mathcal{O}\mathcal{A}^c)^c = \mathcal{O}\mathcal{A}$.*

Proof. $\mathfrak{J} \setminus (\{\mathcal{O}\} \cup (\mathfrak{J} \setminus (\{\mathcal{O}\} \cup \mathcal{O}\mathcal{A}))) = \mathcal{O}\mathcal{A}$ \square

Lemma 1.2.29.4. *Given a geometric object \mathcal{C} on a generalized ray $\mathcal{O}\mathcal{A}$, the generalized ray $\mathcal{O}\mathcal{A}$ is a disjoint union of the generalized half - open interval $(\mathcal{O}\mathcal{C}]$ and the generalized ray $\mathcal{C}\mathcal{O}$, complementary to the generalized ray $\mathcal{C}\mathcal{O}$:*

$$\mathcal{O}\mathcal{A} = (\mathcal{O}\mathcal{C}] \cup \mathcal{C}\mathcal{O}^c.$$

Proof. By L 1.2.25.3 $\mathcal{O}\mathcal{C} = \mathcal{O}\mathcal{A}$. Suppose $\mathcal{M} \in \mathcal{O}\mathcal{C} \cup \mathcal{C}\mathcal{O}^c$. By Pr 1.2.3, Pr 1.2.1 $[\mathcal{O}\mathcal{M}\mathcal{C}] \vee \mathcal{M} = \mathcal{C} \vee [\mathcal{O}\mathcal{C}\mathcal{M}] \Rightarrow \neg[\mathcal{M}\mathcal{O}\mathcal{C}] \& \mathcal{M} \neq \mathcal{O} \Rightarrow \mathcal{M} \in \mathcal{O}\mathcal{A} = \mathcal{O}\mathcal{C}$.

Conversely, if $\mathcal{M} \in \mathcal{O}\mathcal{A} = \mathcal{O}\mathcal{C}$ and $\mathcal{M} \neq \mathcal{C}$ then $\mathcal{M} \neq \mathcal{C} \& \mathcal{M} \neq \mathcal{O} \& \neg[\mathcal{M}\mathcal{O}\mathcal{C}] \xrightarrow{\text{Pr1.2.5}} [\mathcal{O}\mathcal{M}\mathcal{C}] \vee [\mathcal{O}\mathcal{C}\mathcal{M}] \Rightarrow \mathcal{M} \in (\mathcal{O}\mathcal{C}) \vee \mathcal{M} \in \mathcal{C}\mathcal{O}^c$. \square

Lemma 1.2.29.5. *Given in a set \mathfrak{J} , which admits a generalized betweenness relation, a geometric object \mathcal{B} , distinct from a geometric object $\mathcal{O} \in \mathfrak{J}$, the geometric object \mathcal{B} lies either on $\mathcal{O}\mathcal{A}$ or on $\mathcal{O}\mathcal{A}^c$, where $\mathcal{A} \in \mathfrak{J}$, $\mathcal{A} \neq \mathcal{O}$.*

Proof. \square

Theorem 1.2.29. *Let a finite sequence of geometric objects $\mathcal{A}_1, \mathcal{A}_2, \dots, \mathcal{A}_n$, $n \in \mathbb{N}$, from the set \mathfrak{J} be numbered in such a way that, except for the first and (in the finite case) the last, every geometric object lies between the two geometric objects with adjacent (in \mathbb{N}) numbers. Then the generalized ray $\mathcal{A}_1\mathcal{A}_n$ is a disjoint union of generalized half-closed intervals $(\mathcal{A}_i\mathcal{A}_{i+1}]$, $i = 1, 2, \dots, n-1$, with the generalized ray $\mathcal{A}_n\mathcal{A}_k^c$, complementary to the generalized ray $\mathcal{A}_n\mathcal{A}_k$, where $k \in \{1, 2, \dots, n-1\}$, i.e.*

$$\mathcal{A}_1\mathcal{A}_n = \bigcup_{i=1}^{n-1} (\mathcal{A}_i\mathcal{A}_{i+1}] \cup \mathcal{A}_n\mathcal{A}_k^c.$$

Proof. Observe that $[\mathcal{A}_1\mathcal{A}_k\mathcal{A}_n] \xrightarrow{\text{L1.2.29.5}} \mathcal{A}_n\mathcal{A}_k = \mathcal{A}_n\mathcal{A}_1$, then use L 1.2.22.15, L 1.2.29.4. \square

Sets of Geometric Objects on Generalized Rays

Given a geometric object \mathcal{O} in a set \mathfrak{J} , which admits a generalized betweenness relation, a nonempty set $\mathfrak{B} \subset \mathfrak{J}$ is said to lie in the set \mathfrak{J} on the same side (on the opposite side) of the geometric object \mathcal{O} as (from) a nonempty set $\mathfrak{A} \subset \mathfrak{J}$ iff for all geometric objects $\mathcal{A} \in \mathfrak{A}$ and all geometric objects $\mathcal{B} \in \mathfrak{B}$, the geometric object \mathcal{B} lies on the same side (on the opposite side) of the geometric object \mathcal{O} as (from) the geometric object $\mathcal{A} \in \mathfrak{A}$. If the set \mathfrak{A} (the set \mathfrak{B}) consists of a single element, we say that the set \mathfrak{B} (the geometric object \mathcal{B}) lies in the set \mathfrak{J} on the same side of the geometric object \mathcal{O} as the geometric object \mathcal{A} (the set \mathfrak{A}).

Lemma 1.2.30.1. *If a set $\mathfrak{B} \subset \mathfrak{J}$ lies in the set \mathfrak{J} on the same side of the geometric object \mathcal{O} as a set $\mathfrak{A} \subset \mathfrak{J}$, then the set \mathfrak{A} lies in the set \mathfrak{J} on the same side of the geometric object \mathcal{O} as the set \mathfrak{B} .*

Proof. See L 1.2.25.5. \square

Lemma 1.2.30.2. *If a set $\mathfrak{B} \subset \mathfrak{J}$ lies in the set \mathfrak{J} on the same side of the geometric object \mathcal{O} as a set $\mathfrak{A} \subset \mathfrak{J}$, and a set $\mathfrak{C} \subset \mathfrak{J}$ lies in the set \mathfrak{J} on the same side of the geometric object \mathcal{O} as the set \mathfrak{B} , then the set \mathfrak{C} lies in the set \mathfrak{J} on the same side of the geometric object \mathcal{O} as the set \mathfrak{A} .*

Proof. See L 1.2.25.5. \square

¹⁴³Whenever the set \mathfrak{J} is assumed to be known from context or unimportant.

Lemma 1.2.30.3. *If a set $\mathfrak{B} \subset \mathfrak{J}$ lies in the set \mathfrak{J} on the opposite side of the geometric object \mathcal{O} from a set $\mathfrak{A} \subset \mathfrak{J}$, then the set \mathfrak{A} lies in the set \mathfrak{J} on the opposite side of the geometric object \mathcal{O} from the set \mathfrak{B} .*

Proof. See L 1.2.25.6. \square

In view of symmetry of the relations, established by the lemmas above, if a set $\mathfrak{B} \subset \mathfrak{J}$ lies in the set \mathfrak{J} on the same side (on the opposite side) of the geometric object \mathcal{O} as a set (from a set) $\mathfrak{A} \subset \mathfrak{J}$, we say that the sets \mathfrak{A} and \mathfrak{B} lie in the set \mathfrak{J} on one side (on opposite sides) of the geometric object \mathcal{O} .

Lemma 1.2.30.4. *If two distinct geometric objects \mathcal{A}, \mathcal{B} lie on a generalized ray \mathcal{O}_C , the generalized open interval $(\mathcal{A}\mathcal{B})$ also lies on the generalized ray \mathcal{O}_C .*

Proof. By L 1.2.25.8 $[\mathcal{O}\mathcal{A}\mathcal{B}] \vee [\mathcal{O}\mathcal{B}\mathcal{A}]$, whence by T 1.2.29 $(\mathcal{A}\mathcal{B}) \subset \mathcal{O}_A = \mathcal{O}_C$. \square

Given a generalized interval $\mathcal{A}\mathcal{B}$ in the set \mathfrak{J} such that the generalized open interval $(\mathcal{A}\mathcal{B})$ does not contain $\mathcal{O} \in \mathfrak{J}$, we have (L 1.2.30.5 - L 1.2.30.7):

Lemma 1.2.30.5. *– If one of the ends of $(\mathcal{A}\mathcal{B})$ is on the generalized ray \mathcal{O}_C , the other end is either on \mathcal{O}_C or coincides with \mathcal{O} .*

Proof. Let, say, $\mathcal{B} \in \mathcal{O}_C$. By L 1.2.25.3 $\mathcal{O}_B = \mathcal{O}_C$. Assuming the contrary to the statement of the lemma, we have $\mathcal{A} \in \mathcal{O}_B^c \Rightarrow [\mathcal{A}\mathcal{O}\mathcal{B}] \Rightarrow \mathcal{O} \in (\mathcal{A}\mathcal{B})$, which contradicts the hypothesis. \square

Lemma 1.2.30.6. *– If $(\mathcal{A}\mathcal{B})$ has some geometric objects in common with the generalized ray \mathcal{O}_C , either both ends of $(\mathcal{A}\mathcal{B})$ lie on \mathcal{O}_C , or one of them coincides with \mathcal{O} .*

Proof. By hypothesis $\exists \mathcal{M} \mathcal{M} \in (\mathcal{A}\mathcal{B}) \cap \mathcal{O}_C$. $\mathcal{M} \in \mathcal{O}_C \xrightarrow{\text{L1.2.25.3}} \mathcal{O}_M = \mathcal{O}_C$. Assume the contrary to the statement of the lemma and let, say, $\mathcal{A} \in \mathcal{O}_M^c$. Then $[\mathcal{A}\mathcal{O}\mathcal{M}] \& [\mathcal{A}\mathcal{M}\mathcal{B}] \xrightarrow{\text{Pr1.2.7}} [\mathcal{A}\mathcal{O}\mathcal{B}] \Rightarrow \mathcal{O} \in (\mathcal{A}\mathcal{B})$ - a contradiction. \square

Lemma 1.2.30.7. *– If $(\mathcal{A}\mathcal{B})$ has common points with the generalized ray \mathcal{O}_C , the generalized interval $(\mathcal{A}\mathcal{B})$ lies on \mathcal{O}_C , $(\mathcal{A}\mathcal{B}) \subset \mathcal{O}_C$.*

Proof. Use L 1.2.30.6 and L 1.2.29.4 or L 1.2.30.4. \square

Lemma 1.2.30.8. *If \mathcal{A} and \mathcal{B} lie on one generalized ray \mathcal{O}_C , the complementary generalized rays \mathcal{A}_C^c and \mathcal{B}_C^c lie in the set \mathfrak{J} on one side of the geometric object \mathcal{O} .*

Proof. \square

Lemma 1.2.30.9. *If a generalized open interval $(\mathcal{C}\mathcal{D})$ is included in a generalized open interval $(\mathcal{A}\mathcal{B})$, neither of the ends of $(\mathcal{A}\mathcal{B})$ lies on $(\mathcal{C}\mathcal{D})$.*

Proof. $\mathcal{A} \notin (\mathcal{C}\mathcal{D}), \mathcal{B} \notin (\mathcal{C}\mathcal{D})$, for otherwise $(\mathcal{A} \in (\mathcal{C}\mathcal{D}) \vee \mathcal{B} \in (\mathcal{C}\mathcal{D})) \& (\mathcal{C}\mathcal{D}) \subset (\mathcal{A}\mathcal{B}) \Rightarrow \mathcal{A} \in (\mathcal{A}\mathcal{B}) \vee \mathcal{B} \in (\mathcal{A}\mathcal{B})$, which is absurd as it contradicts Pr 1.2.1. \square

Lemma 1.2.30.10. *If a generalized open interval $(\mathcal{C}\mathcal{D})$ is included in a generalized open interval $(\mathcal{A}\mathcal{B})$, the generalized closed interval $[\mathcal{C}\mathcal{D}]$ is included in the generalized closed interval $[\mathcal{A}\mathcal{B}]$.*

Proof. By Pr 1.2.4 $\exists \mathcal{E} [\mathcal{C}\mathcal{E}\mathcal{D}]$. $\mathcal{E} \in (\mathcal{C}\mathcal{D}) \& (\mathcal{C}\mathcal{D}) \subset (\mathcal{A}\mathcal{B}) \xrightarrow{\text{L1.2.29.1}} \mathcal{E} \in (\mathcal{C}\mathcal{D}) \cap (\mathcal{A}_B \cap \mathcal{B}_A)$. $\mathcal{A} \notin (\mathcal{C}\mathcal{D}) \& \mathcal{B} \notin (\mathcal{C}\mathcal{D}) \& \mathcal{E} \in \mathcal{A}_B \cap (\mathcal{C}\mathcal{D}) \& \mathcal{E} \in \mathcal{B}_A \cap (\mathcal{C}\mathcal{D}) \xrightarrow{\text{L1.2.30.6}} \mathcal{C} \in \mathcal{A}_B \cup \{\mathcal{A}\} \& \mathcal{C} \in \mathcal{B}_A \cup \{\mathcal{B}\} \& \mathcal{D} \in \mathcal{A}_B \cup \{\mathcal{A}\} \& \mathcal{D} \in \mathcal{B}_A \cup \{\mathcal{B}\} \Rightarrow \mathcal{C} \in (\mathcal{A}_B \cap \mathcal{B}_A) \cup \{\mathcal{A}\} \cup \{\mathcal{B}\} \& \mathcal{D} \in (\mathcal{A}_B \cap \mathcal{B}_A) \cup \{\mathcal{A}\} \cup \{\mathcal{B}\} \xrightarrow{\text{L1.2.29.1}} \mathcal{C} \in [\mathcal{A}\mathcal{B}] \& \mathcal{D} \in [\mathcal{A}\mathcal{B}]$. \square

Corollary 1.2.30.11. *For generalized intervals $\mathcal{A}\mathcal{B}, \mathcal{C}\mathcal{D}$ both inclusions $(\mathcal{A}\mathcal{B}) \subset (\mathcal{C}\mathcal{D}), (\mathcal{C}\mathcal{D}) \subset (\mathcal{A}\mathcal{B})$ (i.e., the equality $(\mathcal{A}\mathcal{B}) = (\mathcal{C}\mathcal{D})$) holds iff the generalized (abstract) intervals $\mathcal{A}\mathcal{B}, \mathcal{C}\mathcal{D}$ are identical.*

Proof. #1. $(\mathcal{C}\mathcal{D}) \subset (\mathcal{A}\mathcal{B}) \xrightarrow{\text{L1.2.30.10}} [\mathcal{C}\mathcal{D}] \subset [\mathcal{A}\mathcal{B}] \Rightarrow \mathcal{C} \in [\mathcal{A}\mathcal{B}] \& \mathcal{D} \in [\mathcal{A}\mathcal{B}]$. On the other hand, $(\mathcal{A}\mathcal{B}) \subset (\mathcal{C}\mathcal{D}) \xrightarrow{\text{L1.2.30.9}} \mathcal{C} \notin (\mathcal{A}\mathcal{B}) \& \mathcal{D} \notin (\mathcal{A}\mathcal{B})$.

#2. $(\mathcal{A}\mathcal{B}) \subset (\mathcal{C}\mathcal{D}) \& (\mathcal{C}\mathcal{D}) \subset (\mathcal{A}\mathcal{B}) \xrightarrow{\text{L1.2.30.10}} [\mathcal{A}\mathcal{B}] \subset [\mathcal{C}\mathcal{D}] \& [\mathcal{C}\mathcal{D}] \subset [\mathcal{A}\mathcal{B}]$. $(\mathcal{A}\mathcal{B}) = (\mathcal{C}\mathcal{D}) \& [\mathcal{A}\mathcal{B}] = [\mathcal{C}\mathcal{D}] \Rightarrow \{\mathcal{A}, \mathcal{B}\} = [\mathcal{A}\mathcal{B}] \setminus (\mathcal{A}\mathcal{B}) = [\mathcal{C}\mathcal{D}] \setminus (\mathcal{C}\mathcal{D}) = \{\mathcal{C}, \mathcal{D}\}$. \square

Lemma 1.2.30.12. *Both ends of a generalized interval $\mathcal{C}\mathcal{D}$ lie on a generalized closed interval $[\mathcal{A}\mathcal{B}]$ iff the generalized open interval $(\mathcal{C}\mathcal{D})$ is included in the generalized open interval $(\mathcal{A}\mathcal{B})$.*

Proof. Follows immediately from L 1.2.22.5, L 1.2.30.10. \square

Theorem 1.2.30. *A geometric object \mathcal{O} in a set \mathfrak{J} which admits a generalized betweenness relation, separates the rest of the geometric objects in this set into two non-empty classes (generalized rays) in such a way that...*

Proof. \square

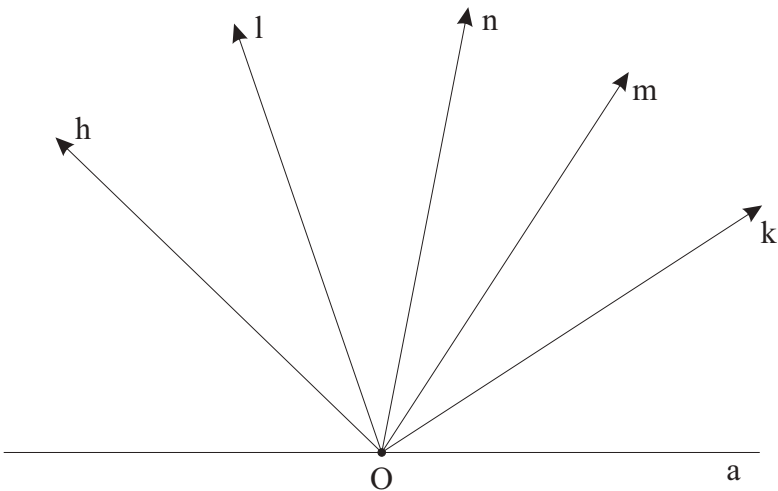

Figure 1.58: If rays $l, m \in \mathfrak{J}$ lie between rays $h, k \in \mathfrak{J}$, the open angular interval (lm) is contained in the open angular interval (hk) .

Betweenness Relation for Rays

Given a pencil \mathfrak{J} of rays, all lying in some plane α on a given side of a line $a \subset \alpha$ and having an initial point O , define an open angular interval $(O_A O_C)$, formed by the rays $O_A, O_C \in \mathfrak{J}$, as the set of all rays $O_B \in \mathfrak{J}$ lying inside the angle $\angle AOC$. That is, for $O_A, O_C \in \mathfrak{J}$ we let $(O_A O_C) \doteq \{O_B | O_B \subset \text{Int} \angle AOC\}$. In analogy with the general case, we shall refer to $[O_A O_C)$, $(O_A O_C]$, $[O_A O_C]$ as half-open, half-closed, and closed angular intervals, respectively.¹⁴⁴ In what follows, open angular intervals, half-open, half-closed and closed angular intervals will be collectively referred to as angular interval-like sets. The definition just given for open, half-open, dots, angular intervals is also applicable for the set \mathfrak{J} of rays, all lying in some plane α on a given side of a line $a \subset \alpha$ and having an initial point O , with two additional rays added: the ray $h \doteq O_A$, where $A \in a$, $A \neq O$, and its complementary ray h^c . For convenience, we can call the set of rays, all lying in α on a given side of $a \subset \alpha$ and having the origin O , an open angular pencil. And we can refer to the same set with the rays h, h^c added, as a closed angular pencil.¹⁴⁵

Given a set \mathfrak{J} of rays having the same initial point O and all lying in plane α on the same side of a line a as a given point Q (an open pencil), or the same set with the rays $h \doteq O_A$, where $A \in a$, $A \neq O$, and h^c added to it (a closed pencil), the following L 1.2.31.1 – T 1.2.37 hold. The angles spoken about in these statements are all assumed to be extended angles.¹⁴⁶

Lemma 1.2.31.1. *If a ray $O_B \in \mathfrak{J}$ lies between rays O_A, O_C of the pencil \mathfrak{J} , the ray O_A cannot lie between the rays O_B and O_C . In other words, if a ray $O_B \in \mathfrak{J}$ lies inside $\angle AOC$, where $O_A, O_C \in \mathfrak{J}$, then the ray O_A cannot lie inside the angle $\angle BOC$.*

Lemma 1.2.31.2. *Suppose each of $l, m \in \mathfrak{J}$ lies inside the angle formed by $h, k \in \mathfrak{J}$. If a ray $n \in \mathfrak{J}$ lies inside the angle $\angle(l, m)$, it also lies inside the angle $\angle(h, k)$. In other words, if rays $l, m \in \mathfrak{J}$ lie between rays $h, k \in \mathfrak{J}$, the open angular interval (lm) is contained in the open angular interval (hk) , i.e. $(lm) \subset (hk)$ (see Fig 1.58).*

Lemma 1.2.31.3. *Suppose each side of an (extended) angles $\angle(l, m)$ (where $l, m \in \mathfrak{J}$) either lies inside an (extended) angle $\angle(h, k)$, where $h, k \in \mathfrak{J}$, or coincides with one of its sides. Then if a ray $n \in \mathfrak{J}$ lies inside $\angle(l, m)$, it also lies inside the angle $\angle(h, k)$.¹⁴⁷*

Lemma 1.2.31.4. *If a ray $l \in \mathfrak{J}$ lies between rays $h, k \in \mathfrak{J}$, none of the rays of the open angular interval (hl) lie on the open angular interval (lk) . That is, if a ray $l \in \mathfrak{J}$ lies inside $\angle(h, k)$, none of the rays¹⁴⁸ lying inside the angle $\angle(h, l)$ lie inside the angle $\angle(l, k)$.*

Proposition 1.2.31.5. *If two (distinct) rays $l \in \mathfrak{J}$, $m \in \mathfrak{J}$ lie inside the angle $\angle(h, k)$, where $h \in \mathfrak{J}$, $k \in \mathfrak{J}$, then either the ray l lies inside the angle $\angle(h, m)$, or the ray m lies inside the angle $\angle(h, l)$.*

¹⁴⁴It should be noted that, as in the case of intervals consisting of points, in view of the equality $\angle(h, k) = \angle(k, h)$ and the corresponding symmetry of open angular intervals, this distinction between half-open and half-closed angular intervals is rather artificial, similar to the distinction between a half-full glass and a half-empty one!

¹⁴⁵Later, we will elaborate on the topological meaning of the words "open", "closed" used in this context.

¹⁴⁶Some of them merely reiterate or even weaken the results proven earlier specifically for rays, but they are given here nonetheless to illustrate the versatility and power of the unified approach. To let the reader develop familiarity with both flavors of terminology for the generalized betweenness relation on the ray pencil \mathfrak{J} , we give two formulations for a few results to follow.

¹⁴⁷It may prove instructive to reformulate this result using the "pointwise" terminology for angles: Suppose each side of an angle $\angle COD$ either lies inside an (extended) angle $\angle AOB$, or coincides with one of its sides. Then if a ray has initial point O and lies inside $\angle COD$, it lies inside the (extended) angle $\angle AOB$.

¹⁴⁸Actually, none of the points lying on any of these rays.

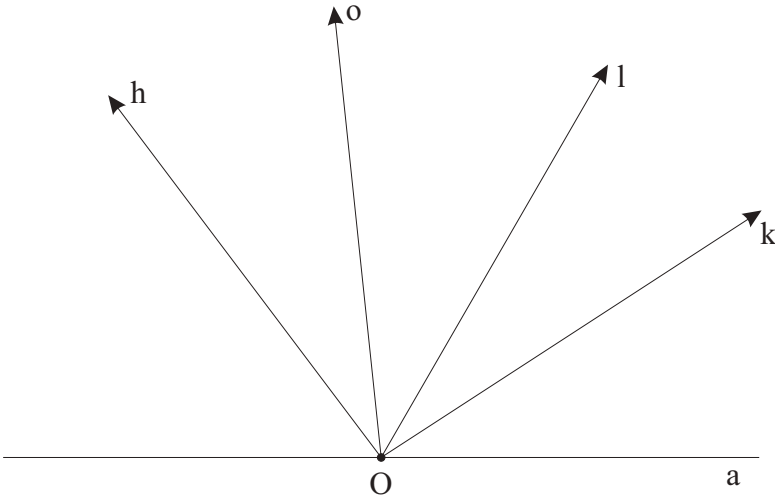

Figure 1.59: If $o \in \mathfrak{J}$ divides $h, k \in \mathfrak{J}$, as well as h and $l \in \mathfrak{J}$, it does not divide k, l .

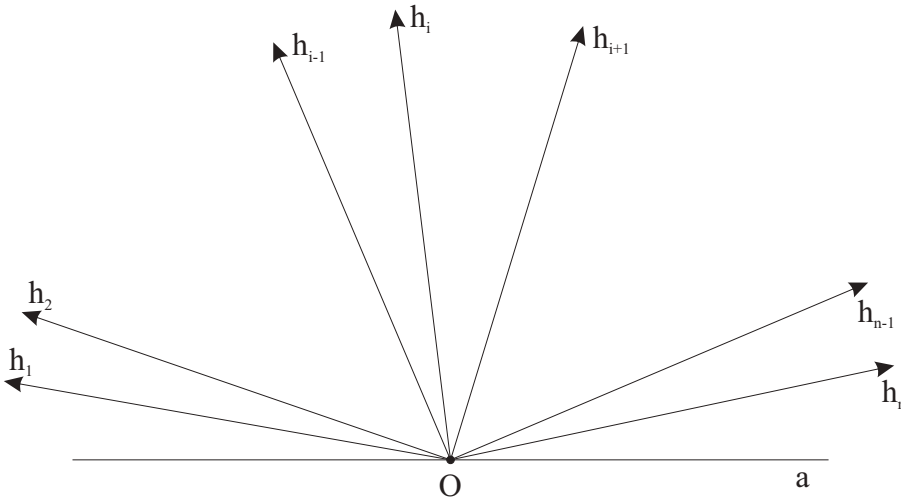

Figure 1.60: Suppose $h_1, h_2, \dots, h_n, (\dots)$ is a finite (countably infinite) sequence of rays of the pencil \mathfrak{J} with the property that a ray of the sequence lies between two other rays of the sequence. Then if a ray of the sequence lies inside the angle formed by two other rays of the sequence, its number has an intermediate value between the numbers of these two rays.

Lemma 1.2.31.6. *Each of $l, m \in \mathfrak{J}$ lies inside the closed angular interval formed by $h, k \in \mathfrak{J}$ (i.e. each of the rays l, m either lies inside the angle $\angle(h, k)$ or coincides with one of its sides) iff all the rays $n \in \mathfrak{J}$ lying inside the angle $\angle(l, m)$ lie inside the angle $\angle(k, l)$.*

Lemma 1.2.31.7. *If a ray $l \in \mathfrak{J}$ lies between rays h, k of the pencil \mathfrak{J} , any ray of the open angular interval (hk) , distinct from l , lies either on the open angular interval (hl) or on the open angular interval (lk) . In other words, if a ray $l \in \mathfrak{J}$ lies inside $\angle(h, k)$, formed by the rays h, k of the pencil \mathfrak{J} , any other (distinct from l) ray lying inside $\angle(h, k)$, also lies either inside $\angle(h, l)$ or inside $\angle(l, k)$.*

Lemma 1.2.31.8. *If a ray $o \in \mathfrak{J}$ divides rays $h, k \in \mathfrak{J}$, as well as h and $l \in \mathfrak{J}$, it does not divide k, l . (see Fig. 1.59)*

Betweenness Relation For n Rays With Common Initial Point

Lemma 1.2.31.9. *Suppose $h_1, h_2, \dots, h_n, (\dots)$ is a finite (countably infinite) sequence of rays of the pencil \mathfrak{J} with the property that a ray of the sequence lies between two other rays of the sequence¹⁴⁹ if its number has an intermediate value between the numbers of these rays. (see Fig. 1.60) Then the converse of this property is true, namely, that if a ray of the sequence lies inside the angle formed by two other rays of the sequence, its number has an intermediate value between the numbers of these two rays. That is, $(\forall i, j, k \in \mathbb{N}_n$ (respectively, \mathbb{N}) $((i < j < k) \vee (k < j < i)) \Rightarrow [h_i h_j h_k]) \Rightarrow (\forall i, j, k \in \mathbb{N}_n$ (respectively, \mathbb{N}) $([h_i h_j h_k] \Rightarrow (i < j < k) \vee (k < j < i))$).*

Let an infinite (finite) sequence of rays h_i of the pencil \mathfrak{J} , where $i \in \mathbb{N}$ ($i \in \mathbb{N}_n, n \geq 4$), be numbered in such a way that, except for the first and the last, every ray lies inside the angle formed by the two rays of sequence with numbers, adjacent (in \mathbb{N}) to that of the given ray. Then:

¹⁴⁹i.e., lies inside the angle formed by two other rays of the sequence

Lemma 1.2.31.10. – A ray from this sequence lies inside the angle formed by two other members of this sequence iff its number has an intermediate value between the numbers of these two rays.

Lemma 1.2.31.11. – An arbitrary ray of the pencil \mathfrak{J} cannot lie inside of more than one of the angles formed by pairs of rays of the sequence having adjacent numbers in the sequence.

Lemma 1.2.31.12. – In the case of a finite sequence, a ray which lies between the end (the first and the last, n^{th}) rays of the sequence, and does not coincide with the other rays of the sequence, lies inside at least one of the angles, formed by pairs of rays with adjacent numbers.

Lemma 1.2.31.13. – All of the open angular intervals $(h_i h_{i+1})$, where $i = 1, 2, \dots, n-1$, lie inside the open angular interval $(h_1 h_n)$. In other words, any ray k , lying inside any of the angles $\angle(h_i, h_{i+1})$, where $i = 1, 2, \dots, n-1$, lies inside the angle $\angle(h_1, h_n)$, i.e. $\forall i \in \{1, 2, \dots, n-1\} k \subset \text{Int}\angle(h_i, h_{i+1}) \Rightarrow k \subset \text{Int}\angle(h_1, h_n)$.

Lemma 1.2.31.14. – The half-open angular interval $[h_1 h_n)$ is a disjoint union of the half-closed angular intervals $[h_i h_{i+1})$, where $i = 1, 2, \dots, n-1$:

$$[h_1 h_n) = \bigcup_{i=1}^{n-1} [h_i h_{i+1}).$$

Also,

The half-closed angular interval $(h_1 h_n]$ is a disjoint union of the half-closed angular intervals $(h_i h_{i+1}]$, where $i = 1, 2, \dots, n-1$:

$$(h_1 h_n] = \bigcup_{i=1}^{n-1} (h_i h_{i+1}].$$

Thus, if $\mathfrak{J} = [h_1, h_n]$, where $h_1 = h$, $h_n = h^c$, is a pencil of rays with initial point O lying (in a given plane) on the same side of a line a as a point A , plus the rays h , h^c , we have $a_A = \left(\bigcup_{i=1}^{n-1} \text{Int}\angle(h_i, h_{i+1}) \right) \cup \left(\bigcup_{i=2}^{n-1} h_i \right)$.

Proof. \square

If a finite (infinite) sequence of rays h_i of the pencil \mathfrak{J} , $i \in \mathbb{N}_n$, $n \geq 4$ ($n \in \mathbb{N}$) has the property that if a ray of the sequence lies inside the angle formed by two other rays of the sequence iff its number has an intermediate value between the numbers of these two rays, we say that the rays $h_1, h_2, \dots, h_n, (\dots)$ are in order $[h_1 h_2 \dots h_n (\dots)]$.

Theorem 1.2.31. Any finite sequence of rays $h_i \in \mathfrak{J}$, $i \in \mathbb{N}_n$, $n \geq 4$ can be renumbered in such a way that a ray from the sequence lies inside the angle formed by two other rays of the sequence iff its number has an intermediate value between the numbers of these two rays. In other words, any finite (infinite) sequence of rays $h_i \in \mathfrak{J}$, $i \in \mathbb{N}_n$, $n \geq 4$ can be put in order $[h_1 h_2 \dots h_n]$.

Lemma 1.2.31.12. For any finite set of rays $\{h_1, h_2, \dots, h_n\}$ of an open angular interval $(hk) \subset \mathfrak{J}$ there is a ray l on (hk) not in that set.

Proposition 1.2.31.13. Every open angular interval in \mathfrak{J} contains an infinite number of rays.

Corollary 1.2.31.14. Every angular interval-like set in \mathfrak{J} contains an infinite number of rays.

Basic Properties of Angular Rays

Given a pencil \mathfrak{J} of rays lying in plane α on the same side of a line a as a given point Q , and two distinct rays o , h , $h \neq o$ of the pencil \mathfrak{J} , define the angular ray o_h , emanating from its origin, or initial ray o , as the set of all rays $k \neq o$ of the pencil \mathfrak{J} such that the ray o does not divide the rays h , k .¹⁵⁰ That is, for $o, h \in \mathfrak{J}$, $o \neq h$, we define $o_h \equiv \{k | k \subset \mathfrak{J} \& k \neq o \& \neg[hok]\}$.¹⁵¹

Lemma 1.2.32.1. Any ray h lies on the angular ray o_h .

Lemma 1.2.32.2. If a ray k lies on an angular ray o_h , the ray h lies on the angular ray o_k . That is, $k \in o_h \Rightarrow h \in o_k$.

Lemma 1.2.32.3. If a ray k lies on an angular ray o_h , the angular ray o_h coincides with the angular ray o_k .

Lemma 1.2.32.4. If angular rays o_h and o_k have common rays, they are equal.

Lemma 1.2.32.5. The relation "to lie in the pencil \mathfrak{J} on the same side of a given ray $o \in \mathfrak{J}$ as" is an equivalence relation on $\mathfrak{J} \setminus \{o\}$. That is, it possesses the properties of:

- 1) Reflexivity: A ray h always lies on the same side of the ray o as itself;
- 2) Symmetry: If a ray k lies on the same side of the ray o as h , the ray h lies on the same side of o as k .
- 3) Transitivity: If a ray k lies on the same side of the ray o as h , and a ray l lies on the same side of o as k , then l lies on the same side of o as h .

¹⁵⁰i.e. the ray o does not lie inside the angle $\angle(h, k)$.

¹⁵¹Note that, according to our definition, an angular ray is formed by traditional rays instead of points! In a similar manner we could construct a "hyper-angular" ray formed by angular rays instead of points or rays. This hyper-angular ray would have essentially the same properties given by Pr 1.2.1 - Pr 1.2.7 as the two types of rays already considered, but, on the other hand, it would definitely be too weird to allow any practical use.

Lemma 1.2.32.6. *A ray k lies on the opposite side of o from h iff o divides h and k .*

Lemma 1.2.32.7. *The relation "to lie in the pencil \mathfrak{J} on the opposite side of the given ray o from \dots " is symmetric.*

If a ray k lies in the pencil \mathfrak{J} on the same side (on the opposite side) of the ray o as (from) a ray h , in view of symmetry of the relation we say that the rays h and k lie in the set \mathfrak{J} on the same side (on opposite sides) of o .

Lemma 1.2.32.8. *If rays h and k lie on one angular ray $o_l \subset \mathfrak{J}$, they lie in the pencil \mathfrak{J} on the same side of the ray o . If, in addition, $h \neq k$, then either h lies between o and k , or k lies between o and h .*

Lemma 1.2.32.9. *If a ray l lies in the pencil \mathfrak{J} on the same side of the ray o as a ray h , and a ray m lies on the opposite side of o from h , then the rays l and m lie on opposite sides of o .¹⁵²*

Lemma 1.2.32.10. *If rays l and m lie in the pencil \mathfrak{J} on the opposite side of the ray o from a ray h ,¹⁵³ then l and m lie on the same side of o .*

Lemma 1.2.32.11. *Suppose a ray l lies on an angular ray o_h , a ray m lies on an angular ray o_k , and o lies between h and k . Then o also lies between l and m .*

Lemma 1.2.32.12. *A ray $o \in \mathfrak{J}$ divides rays $h \in \mathfrak{J}$ and $k \in \mathfrak{J}$ iff the angular rays o_h and o_k are disjoint, $o_h \cap o_k = \emptyset$, and their union, together with the ray o , gives the pencil \mathfrak{J} , i.e. $\mathfrak{J} = o_h \cup o_k \cup \{o\}$. That is,*

$$[hok] \Leftrightarrow (\mathfrak{J} = o_h \cup o_k \cup \{o\}) \& (o_h \cap o_k = \emptyset).$$

Lemma 1.2.32.13. *An angular ray o_h contains the open angular interval (oh) .*

Lemma 1.2.32.14. *For any finite set of rays $\{h_1, h_2, \dots, h_n\}$ of an angular ray o_h , there is a ray l on o_h not in that set.*

Lemma 1.2.32.15. *If a ray k lies between rays o and h then the angular rays o_k and o_h are equal.*

Lemma 1.2.32.16. *If a ray h lies between rays o and k , the ray k lies on the angular ray o_h .*

Lemma 1.2.32.17. *If angular rays o_h and o'_k are equal, their origins coincide.*

Lemma 1.2.32.18. *If an angle (=abstract angular interval) $\angle(h_0, h_n)$ is divided into n angles $\angle(h_0, h_1), \angle(h_1, h_2), \dots, \angle(h_{n-1}, h_n)$ (by the rays h_1, h_2, \dots, h_{n-1}),¹⁵⁴ the rays $h_1, h_2, \dots, h_{n-1}, h_n$ all lie on the same side of the ray h_0 , and the angular rays $h_{0h_1}, h_{0h_2}, \dots, h_{0h_n}$ are equal.¹⁵⁵*

Theorem 1.2.32. *Every angular ray contains an infinite number of rays.*

Line Ordering on Angular Rays

Suppose h, k are two rays on an angular ray o_m . Let, by definition, $(h \prec k)_{o_m} \stackrel{\text{def}}{\Leftrightarrow} [\uparrow \langle \mid \mid]$. If $h \prec k$,¹⁵⁶ we say that the ray h precedes the ray k on the angular ray o_m , or that the ray k succeeds the ray h on the angular ray o_m .

Lemma 1.2.33.1. *If a ray h precedes a ray k on an angular ray o_m , and k precedes a ray l on the same angular ray, then h precedes l on o_m :*

$$h \prec k \& k \prec l \Rightarrow h \prec l, \text{ where } h, k, l \in o_m.$$

Proof. \square

Lemma 1.2.33.2. *If h, k are two distinct rays on an angular ray o_m then either h precedes k , or k precedes h ; if h precedes k then k does not precede h .*

Proof. \square

For rays h, k on an angular ray o_m we let, by definition, $h \preceq k \stackrel{\text{def}}{\Leftrightarrow} (h \prec k) \vee (h = k)$.

Theorem 1.2.33. *Every angular ray is a chain with respect to the relation \preceq .*

¹⁵²Making use of L 1.2.32.6, this statement can be reformulated as follows:

If a ray l lies on o_h , and o divides h and m , then o divides l and m .

¹⁵³One could as well have said: If o lies between h and l , as well as between h and $m \dots$

¹⁵⁴In other words, a finite sequence of rays h_i , where $i + 1 \in \mathbb{N}_{n-1}$, $n \geq 4$, has the property that every ray of the sequence, except for the first and the last, lies between the two rays with adjacent (in \mathbb{N}) numbers.

¹⁵⁵By the same token, we can assert also that the rays $h_0, h_1 \dots, h_{n-1}$ lie on the same side of the ray h_n , but due to symmetry, this adds essentially nothing new to the statement of the lemma.

¹⁵⁶In most instances in what follows we will assume the angular ray o_m (or some other angular ray) fixed and omit the mention of it in our notation.

Line Ordering on Pencils of Rays

Let $o \in \mathfrak{J}$, $p \in \mathfrak{J}$, $[poq]$. Define the relation of direct (inverse) ordering on the pencil \mathfrak{J} of rays lying in plane α on the same side of a line a as a given point Q , which admits a generalized betweenness relation, as follows:

Call o_p the first angular ray, and o_q the second angular ray. A ray h precedes a ray k in the pencil \mathfrak{J} in the direct (inverse) order iff:

- Both h and k lie on the first (second) angular ray and k precedes h on it; or
- h lies on the first (second) angular ray, and k lies on the second (first) angular ray or coincides with o ; or
- $h = o$ and k lies on the second (first) angular ray; or
- Both h and k lie on the second (first) angular ray, and h precedes k on it.

Thus, a formal definition of the direct ordering on the pencil \mathfrak{J} can be written down as follows:

$$(h \prec_1 k)_{\mathfrak{J}} \stackrel{\text{def}}{\iff} (h \in o_p \& k \in o_p \& k \prec h) \vee (h \in o_p \& k = o) \vee (h \in o_p \& k \in o_q) \vee (h = o \& k \in o_q) \vee (h \in o_q \& k \in o_q \& h \prec k),$$

$$\text{and for the inverse ordering: } (h \prec_2 k)_{\mathfrak{J}} \stackrel{\text{def}}{\iff} (h \in o_q \& k \in o_q \& k \prec h) \vee (h \in o_q \& k = o) \vee (h \in o_q \& k \in o_p) \vee (h = o \& k \in o_p) \vee (h \in o_p \& k \in o_p \& h \prec k).$$

The term "inverse order" is justified by the following trivial

Lemma 1.2.34.1. *h precedes k in the inverse order iff k precedes h in the direct order.*

For our notion of order (both direct and inverse) on the pencil \mathfrak{J} to be well defined, they have to be independent, at least to some extent, on the choice of the origin o of the pencil \mathfrak{J} , as well as on the choice of the rays p and q , forming, together with the ray o , angular rays o_p and o_q , respectively.

Toward this end, let $o' \in \mathfrak{J}$, $p' \in \mathfrak{J}$, $[p'o'q']$, and define a new direct (inverse) ordering with displaced origin (ODO) on the pencil \mathfrak{J} , as follows:

Call o' the displaced origin, $o'_{p'}$ and $o'_{q'}$ the first and the second displaced angular rays, respectively. A ray h precedes a ray k in the set \mathfrak{J} in the direct (inverse) ODO iff:

- Both h and k lie on the first (second) displaced angular ray, and k precedes h on it; or
- h lies on the first (second) displaced angular ray, and k lies on the second (first) displaced angular ray or coincides with o' ; or
- $h = o'$ and k lies on the second (first) displaced angular ray; or
- Both h and k lie on the second (first) displaced angular ray, and h precedes k on it.

Thus, a formal definition of the direct ODO on the set \mathfrak{J} can be written down as follows:

$$(h \prec'_1 k)_{\mathfrak{J}} \stackrel{\text{def}}{\iff} (h \in o'_{p'} \& k \in o'_{p'} \& k \prec h) \vee (h \in o'_{p'} \& k = o') \vee (h \in o'_{p'} \& k \in o'_{q'}) \vee (h = o' \& k \in o'_{q'}) \vee (h \in o'_{q'} \& k \in o'_{q'} \& h \prec k),$$

$$\text{and for the inverse ordering: } (h \prec'_2 k)_{\mathfrak{J}} \stackrel{\text{def}}{\iff} (h \in o'_{q'} \& k \in o'_{q'} \& k \prec h) \vee (h \in o'_{q'} \& k = o') \vee (h \in o'_{q'} \& k \in o'_{p'}) \vee (h = o' \& k \in o'_{p'}) \vee (h \in o'_{p'} \& k \in o'_{p'} \& h \prec k).$$

Lemma 1.2.34.2. *If the origin o' of the displaced angular ray $o'_{p'}$ lies on the angular ray o_p and between o and p' , then the angular ray o_p contains the angular ray $o'_{p'}$, $o'_{p'} \subset o_p$.*

Lemma 1.2.34.3. *Let the displaced origin o' be chosen in such a way that o' lies on the angular ray o_p , and the ray o lies on the angular ray $o'_{q'}$. If a ray k lies on both angular rays o_p and $o'_{q'}$, then it divides o and o' .*

Lemma 1.2.34.4. *An ordering with the displaced origin o' on a pencil \mathfrak{J} of rays lying in plane α on the same side of a line a as a given point Q , which admits a generalized betweenness relation, coincides with either direct or inverse ordering on that pencil (depending on the choice of the displaced angular rays). In other words, either for all rays h, k in \mathfrak{J} we have that h precedes k in the ODO iff h precedes k in the direct order; or for all rays h, k in \mathfrak{J} we have that h precedes k in the ODO iff h precedes k in the inverse order.*

Lemma 1.2.34.5. *Let h, k be two distinct rays in a pencil \mathfrak{J} of rays lying in plane α on the same side of a line a as a given point Q , which admits a generalized betweenness relation, and on which some direct or inverse order is defined. Then either h precedes k in that order, or k precedes h , and if h precedes k , k does not precede h , and vice versa.*

For rays h, k in a pencil \mathfrak{J} of rays lying in plane α on the same side of a line a as a given point Q , which admits a generalized betweenness relation, and where some direct or inverse order is defined, we let $h \preceq_i k \stackrel{\text{def}}{\iff} (h \prec_i k) \vee (h = k)$, where $i = 1$ for the direct order and $i = 2$ for the inverse order.

Theorem 1.2.34. *Every set \mathfrak{J} of rays lying in plane α on the same side of a line a as a given point Q , which admits a generalized betweenness relation, and equipped with a direct or inverse order, is a chain with respect to the relation \preceq_i .*

Theorem 1.2.35. *If a ray k lies between rays h and l , then in any ordering of the kind defined above, defined on the pencil \mathfrak{J} , containing these rays, either h precedes k and k precedes l , or l precedes k and k precedes h ; conversely, if in some order, defined on the pencil \mathfrak{J} of rays lying in plane α on the same side of a line a as a given point Q , admitting a generalized betweenness relation and containing rays h, k, l , we have that h precedes k and k precedes l , or l precedes k and k precedes h , then k lies between h and l . That is,*

$$\forall h, k, l \in \mathfrak{J} [hkl] \Leftrightarrow (h \prec k \& k \prec l) \vee (l \prec k \& k \prec h).$$

Complementary Angular Rays

Lemma 1.2.36.1. *An angular interval (oh) is the intersection of the angular rays o_h and h_o , i.e. $(oh) = o_h \cap h_o$.*

Given an angular ray o_h , define the angular ray o_h^c , complementary in the pencil \mathfrak{J} to the angular ray o_h , as $o_h^c = \mathfrak{J} \setminus (\{o\} \cup o_h)$. In other words, the angular ray o_h^c , complementary to the angular ray o_h , is the set of all rays lying in the pencil \mathfrak{J} on the opposite side of the ray o from the ray h . An equivalent definition is provided by

Lemma 1.2.36.2. $o_h^c = \{k | [koh]\}$. We can also write $o_h^c = o_m$ for any ray $m \in \mathfrak{J}$ such that $[moh]$.

Lemma 1.2.36.3. *The angular ray $(o_h^c)^c$, complementary to the angular ray o_h^c , complementary to the given angular ray o_h , coincides with the angular ray o_h : $(o_h^c)^c = o_h$.*

Lemma 1.2.36.4. *Given a ray l on an angular ray o_h , the angular ray o_h is a disjoint union of the half - open angular interval $[ol]$ and the angular ray l_o^c , complementary to the angular ray l_o :*

$$o_h = [ol] \cup l_o^c.$$

Lemma 1.2.36.5. *Given in a pencil \mathfrak{J} of rays lying in plane α on the same side of a line a as a given point Q , which admits a generalized betweenness relation, a ray k , distinct from a ray $o \in \mathfrak{J}$, the ray k lies either on o_h or on o_h^c , where $h \in \mathfrak{J}$, $h \neq o$.*

Theorem 1.2.36. *Let a finite sequence of rays h_1, h_2, \dots, h_n , $n \in \mathbb{N}$, from the pencil \mathfrak{J} , be numbered in such a way that, except for the first and (in the finite case) the last, every ray lies between the two rays with adjacent (in \mathbb{N}) numbers. Then the angular ray h_{1h_n} is a disjoint union of half-closed angular intervals $(h_i h_{i+1}]$, $i = 1, 2, \dots, n-1$, with the angular ray $h_{nh_k}^c$, complementary to the angular ray h_{nh_k} , where $k \in \{1, 2, \dots, n-1\}$, i.e.*

$$h_{1h_n} = \bigcup_{i=1}^{n-1} (h_i h_{i+1}] \cup h_{nh_k}^c.$$

Given a ray o in a pencil \mathfrak{J} of rays lying in plane α on the same side of a line a as a given point Q , which admits a generalized betweenness relation, a nonempty set $\mathfrak{B} \subset \mathfrak{J}$ of rays is said to lie in the pencil \mathfrak{J} on the same side (on the opposite side) of the ray o as (from) a nonempty set $\mathfrak{A} \subset \mathfrak{J}$ of rays iff for all rays $h \in \mathfrak{A}$ and all rays $k \in \mathfrak{B}$, the ray k lies on the same side (on the opposite side) of the ray o as (from) the ray $h \in \mathfrak{A}$. If the set \mathfrak{A} (the set \mathfrak{B}) consists of a single element, we say that the set \mathfrak{B} (the ray k) lies in the pencil \mathfrak{J} on the same side of the ray o as the ray h (the set \mathfrak{A}).

Sets of (Traditional) Rays on Angular Rays

Lemma 1.2.37.1. *If a set $\mathfrak{B} \subset \mathfrak{J}$ lies in the pencil \mathfrak{J} on the same side of the ray o as a set $\mathfrak{A} \subset \mathfrak{J}$, then the set \mathfrak{A} lies in the pencil \mathfrak{J} on the same side of the ray o as the set \mathfrak{B} .*

Lemma 1.2.37.2. *If a set $\mathfrak{B} \subset \mathfrak{J}$ lies in the pencil \mathfrak{J} on the same side of the ray o as a set $\mathfrak{A} \subset \mathfrak{J}$, and a set $\mathfrak{C} \subset \mathfrak{J}$ lies in the set \mathfrak{J} on the same side of the ray o as the set \mathfrak{B} , then the set \mathfrak{C} lies in the pencil \mathfrak{J} on the same side of the ray o as the set \mathfrak{A} .*

Lemma 1.2.37.3. *If a set $\mathfrak{B} \subset \mathfrak{J}$ lies in the set \mathfrak{J} on the opposite side of the ray o from a set $\mathfrak{A} \subset \mathfrak{J}$, then the set \mathfrak{A} lies in the set \mathfrak{J} on the opposite side of the ray o from the set \mathfrak{B} .*

In view of symmetry of the relations, established by the lemmas above, if a set $\mathfrak{B} \subset \mathfrak{J}$ lies in the pencil \mathfrak{J} on the same side (on the opposite side) of the ray o as a set (from a set) $\mathfrak{A} \subset \mathfrak{J}$, we say that the sets \mathfrak{A} and \mathfrak{B} lie in the pencil \mathfrak{J} on one side (on opposite sides) of the ray o .

Lemma 1.2.37.4. *If two distinct rays h, k lie on an angular ray o_l , the open angular interval (hk) also lies on the angular ray o_l .*

Given an angle $\angle(h, k)$,¹⁵⁷ whose sides h, k both lie in the pencil \mathfrak{J} , such that the open angular interval (hk) does not contain $o \in \mathfrak{J}$, we have (L 1.2.37.5 - L 1.2.37.7):

Lemma 1.2.37.5. *– If one of the ends of (hk) lies on the angular ray o_l , the other end is either on o_l or coincides with o .*

Lemma 1.2.37.6. *– If (hk) has rays in common with the angular ray o_l , either both ends of (hk) lie on o_l , or one of them coincides with o .*

Lemma 1.2.37.7. *– If (hk) has common points with the angular ray o_l , the interval (hk) lies on o_l , $(hk) \subset o_l$.*

Lemma 1.2.37.8. *If h and k lie on one angular ray o_l , the complementary angular rays h_o^c and k_o^c lie in the pencil \mathfrak{J} on one side of the ray o .*

¹⁵⁷In unified terms, an abstract angular interval.

Table 1.1: Names of polygons

n	polygon	n	polygon	n	polygon
2	digon	11	undecagon (hendecagon)	30	triacontagon
3	triangle (trigon)	12	dodecagon	40	tetracontagon
4	quadrilateral (tetragon)	13	tridecagon (triskaidecagon)	50	pentacontagon
5	pentagon	14	tetradecagon (tetrakaidecagon)	60	hexacontagon
6	hexagon	15	pentadecagon (pentakaidecagon)	70	heptacontagon
7	heptagon	16	hexadecagon (hexakaidecagon)	80	octacontagon
8	octagon	17	heptadecagon (heptakaidecagon)	90	enneacontagon
9	nonagon enneagon	18	octadecagon (octakaidecagon)	100	hectogon
10	decagon	19	enneadecagon (enneakaidecagon)	1000	myriagon
		20	icosagon		

Lemma 1.2.37.9. *If the interior of an angle $\angle(l, m)$ is included in the interior of an angle $\angle(h, k)$, neither of the sides of the angle $\angle(h, k)$ lies inside $\angle(l, m)$.*

Proof. \square

Lemma 1.2.37.10. *If the interior of an angle $\angle(l, m)$ is included in the interior of an angle $\angle(h, k)$, the set $\text{Int}\angle(l, m) \cup \mathcal{P}_{\angle(l, m)}$ is included in the set $\text{Int}\angle(h, k) \cup \mathcal{P}_{\angle(h, k)}$.*

Proof. \square

Corollary 1.2.37.11. *For angles $\angle(h, k)$, $\angle(l, m)$ both inclusions $\text{Int}\angle(h, k) \subset \text{Int}\angle(l, m)$, $\text{Int}\angle(l, m) \subset \text{Int}\angle(h, k)$ (i.e., the equality $\text{Int}\angle(h, k) = \text{Int}\angle(l, m)$ holds iff the angles $\angle(h, k)$, $\angle(l, m)$ are identical.*

Proof. \square

Lemma 1.2.37.12. *Both sides of an angle $\angle(l, m)$ are included in the set $\text{Int}\angle(h, k) \cup \mathcal{P}_{\angle(h, k)}$ iff the interior $\text{Int}\angle(l, m)$ of the angle $\angle(l, m)$ is included in the interior $\text{Int}\angle(h, k)$ of the angle $\angle(h, k)$.*

Proof. \square

Theorem 1.2.37. *A ray o in a pencil \mathfrak{J} of rays lying in plane α on the same side of a line a as a given point Q , which admits a generalized betweenness relation, separates the rest of the rays in this pencil into two non-empty classes (angular rays) in such a way that...*

Paths and Polygons: Basic Concepts

Following Hilbert, we define paths and polygons as follows:

A (rectilinear) path,¹⁵⁸ or a way $A_0A_1A_2 \dots A_{n-1}A_n$, in classical synthetic geometry, is an (ordered) n -tuple, $n \geq 1$, of abstract intervals $A_0A_1, A_1A_2, \dots, A_{n-1}A_n$, such that each interval A_iA_{i+1} , except possibly for the first A_0A_1 and the last, $A_{n-1}A_n$, shares one of its ends, A_i , with the preceding (in this n -tuple) interval $A_{i-1}A_i$, and the other end A_{i+1} with the succeeding interval $A_{i+1}A_{i+2}$. (See Fig. 1.61, a.)

Given a path $A_0A_1A_2 \dots A_n$, the abstract intervals A_kA_{k+1} , or open interval (A_kA_{k+1}) , depending on the context (an attempt is made in this book to always make clear in which sense the term is used in any particular instance of its use), is called the k^{th} side of the path, the closed interval $[A_kA_{k+1}]$ the k^{th} side-interval of the path, the line $a_{A_kA_{k+1}}$ the k^{th} side-line of the path, and the point A_k - the k^{th} vertex of the path. The path $A_0A_1A_2 \dots A_{n-1}A_n$ is said to go from A_0 to A_n and to connect, or join, its beginning A_0 with end A_n . The first A_0 and the last A_n vertices of the path are also collectively called its endpoints, or simply its ends. Two vertices, together forming a side, are called adjacent.

The contour $\mathcal{P}_{A_0A_1 \dots A_n}$ of the path $A_0A_1 \dots A_n$ is, by definition, the union of its sides and vertices:

$$\mathcal{P}_{A_0A_1 \dots A_n} = \bigcup_{i=0}^{n-1} (A_iA_{i+1}) \cup \{A_0, A_1, \dots, A_n\}$$

If the first and the last vertices in a path $A_0A_1 \dots A_nA_{n+1}$ coincide, i.e. if $A_0 = A_{n+1}$, the path is said to be closed and is called a polygon $A_0A_1 \dots A_n$, or n -gon, to be more precise.¹⁵⁹ (See Fig. 1.61, b.)

A polygon with $n = 3$ is termed a triangle, with $n = 4$ a quadrilateral, and the names of the polygons for $n \geq 5$ are formed using appropriate Greek prefixes to denote the number of sides: pentagon ($n = 5$), hexagon ($n = 6$), octagon ($n = 8$), decagon ($n = 10$), dodecagon ($n = 12$), dots (see Table 1.1).

¹⁵⁸In this part of the book we shall drop the word rectilinear because we consider only such paths.

¹⁵⁹Since, whenever we are dealing with a polygon, we explicitly mention the fact that we have a polygon, and not just general path, the notation "polygon $A_0A_1 \dots A_n$ " should not lead to confusion with the "general path" notation $A_0A_1 \dots A_nA_{n+1}$ for the same object, where in the case of the given polygon $A_0 = A_{n+1}$.

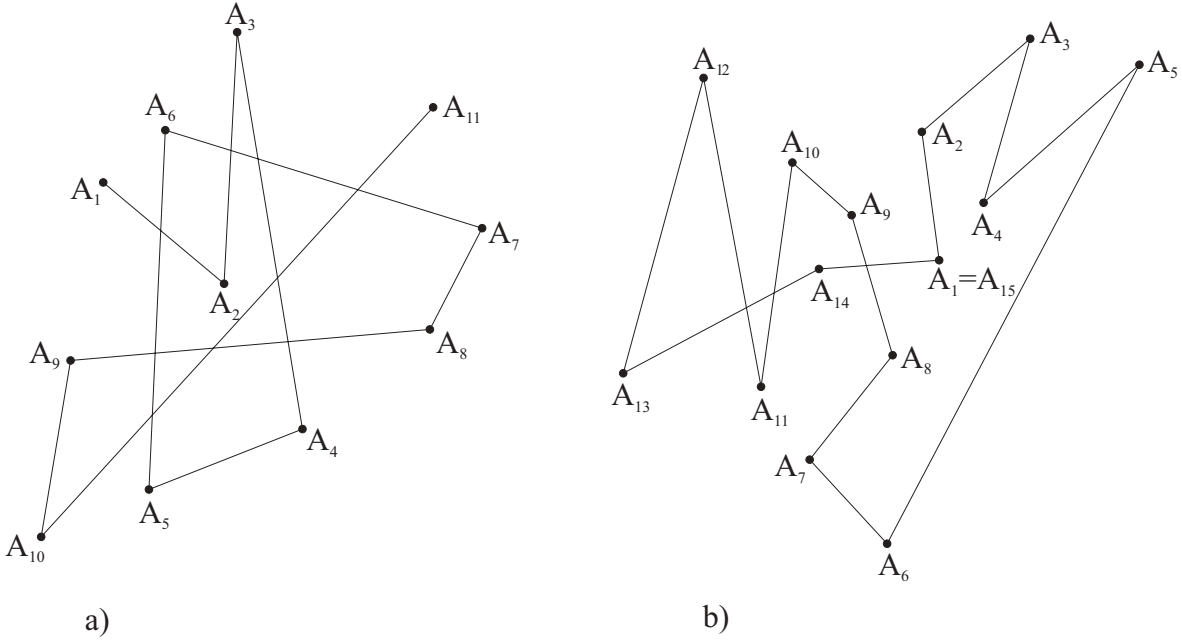

Figure 1.61: a) A general path; b) A polygon with 15 sides

To denote a triangle $A_1A_2A_3$,¹⁶⁰ which is a path $A_1A_2A_3A_4$ with the additional condition $A_4 = A_1$, a special notation $\triangle ABC$ is used.

For convenience, in a polygon $A_1A_2 \dots A_n$, viewed from the standpoint of the general path notation $A_1A_2 \dots A_nA_{n+1}$, where $A_1 = A_{n+1}$, we let, by definition $A_{n+2} \doteq A_2$.

Alternatively, one could explicate the intuitive notion of a jagged path or a polygon using the concept of an ordered path, using the definition of an ordered interval:

An ordered (rectilinear) path,¹⁶¹ or a way $\overrightarrow{A_0A_1A_2 \dots A_{n-1}A_n}$, in classical synthetic geometry, is an (ordered) n -tuple, $n \geq 1$, of ordered abstract intervals $\overrightarrow{A_0A_1}, \overrightarrow{A_1A_2}, \dots, \overrightarrow{A_{n-1}A_n}$, such that each ordered interval $\overrightarrow{A_iA_{i+1}}$, except possibly for the first $\overrightarrow{A_0A_1}$ and the last, $\overrightarrow{A_{n-1}A_n}$, has as its beginning A_i the end of the preceding (in this $(n-1)$ -tuple) ordered interval $\overrightarrow{A_{i-1}A_i}$, and its end A_{i+1} coincides with the beginning of the succeeding ordered interval $\overrightarrow{A_{i+1}A_{i+2}}$.

Although it might appear that the concept of an ordered path better grasps the ordering of the intervals which make up the path, we shall prefer to stick with the concept of non-ordered path (including non-ordered polygons), which, as above, will be referred to simply as paths. This is not unreasonable since the results concerning paths (and, in particular, polygons), are formulated ultimately in terms of the basic relations of betweenness and congruence involving the sides of these paths, and these relations are symmetric.

A path $A_{l+1}A_{l+2} \dots A_{l+k}$, formed by intervals $A_{l+1}A_{l+2}, A_{l+2}A_{l+3}, \dots, A_{l+k-1}A_k$, consecutively joining k consecutive vertices of a path $A_1A_2 \dots A_n$, is called a subpath of the latter. A subpath $A_{l+1}A_{l+2} \dots A_{l+k}$ of a path $A_1A_2 \dots A_n$, different from the path itself, is called a proper subpath.

A path $A_1A_2 \dots A_n$, in particular, a polygon, is called planar, if all its vertices lie in a single plane α , that is, $\exists \alpha A_i \in \alpha$ for all $i \in \mathbb{N}_n$.

Given a path $A_1A_2 \dots A_n$, we can define on the set $\mathcal{P}_{A_1A_2 \dots A_n} \setminus \{A_n\}$ an ordering relation as follows. We say that a point $A \in \mathcal{P}_{A_1A_2 \dots A_n} \setminus \{A_n\}$ precedes a point $B \in \mathcal{P}_{A_1A_2 \dots A_n} \setminus \{A_n\}$ and write $A \prec B$,¹⁶² or that B succeeds A , and write $B \succ A$ iff (see Fig. 1.62)

- either both A and B lie on the same half-open interval $[A_iA_{i+1})$ and A precedes B on it; or
- A lies on the half-open interval $[A_i, A_{i+1})$, B lies on $[A_j, A_{j+1})$ and $i < j$.

We say that A precedes B on the half-open interval $[A_iA_{i+1})$ iff $A = A_i$ and $B \in (A_i, A_{i+1})$, or both $A, B \in (A_iA_{i+1})$ and $[A_iAB]$.

For an open path $A_1A_2 \dots A_n$, we can extend this relation onto the set $\mathcal{P}_{A_1A_2 \dots A_n}$ if we let, by definition, $A \prec A_n$ for all $A \in \mathcal{P}_{A_1A_2 \dots A_n} \setminus \{A_n\}$.

Lemma 1.2.38.1. *The relation \prec thus defined is transitive on $\mathcal{P}_{A_1A_2 \dots A_n} \setminus \{A_n\}$, and in the case of an open path on $\mathcal{P}_{A_1A_2 \dots A_n}$. That is, for $A, B, C \in \mathcal{P}_{A_1A_2 \dots A_n} \setminus \{A_n\}$ ($A, B, C \in \mathcal{P}_{A_1A_2 \dots A_n}$ if $A_1A_2 \dots A_n$ is open) we have $A \prec B \& B \prec C \Rightarrow A \prec C$.*

¹⁶⁰It is sometimes more convenient to number points starting from the number 1 rather than 0, i.e. we can also name points A_1, A_2, \dots instead of A_0, A_1, \dots

¹⁶¹In this part of the book we shall drop the word rectilinear because we consider only such paths.

¹⁶²Properly, we should have written $(A \prec B)_{A_1A_2 \dots A_n}$. However, as there is no risk of confusion with precedence relations defined for other kinds of sets, we prefer the shorthand notation.

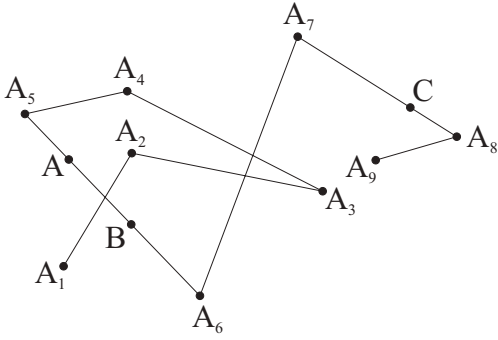

Figure 1.62: An illustration of ordering on a path. Here on an open path $A_1A_2 \dots A_n$ we have, for instance, $A_1 \prec A_3 \prec A_5 \prec A \prec B \prec A_6 \prec A_7 \prec C \prec A_8 \prec A_9$. Note that our definition of ordering on a path $A_1A_2 \dots A_n$ conforms to the intuitive notion that a point $A \in \mathcal{P}_{A_1A_2 \dots A_n}$ precedes another point $B \in \mathcal{P}_{A_1A_2 \dots A_n}$ if we encounter A sooner than B when we "take" the open path $A_1A_2 \dots A_n$ from A_1 to A_n .

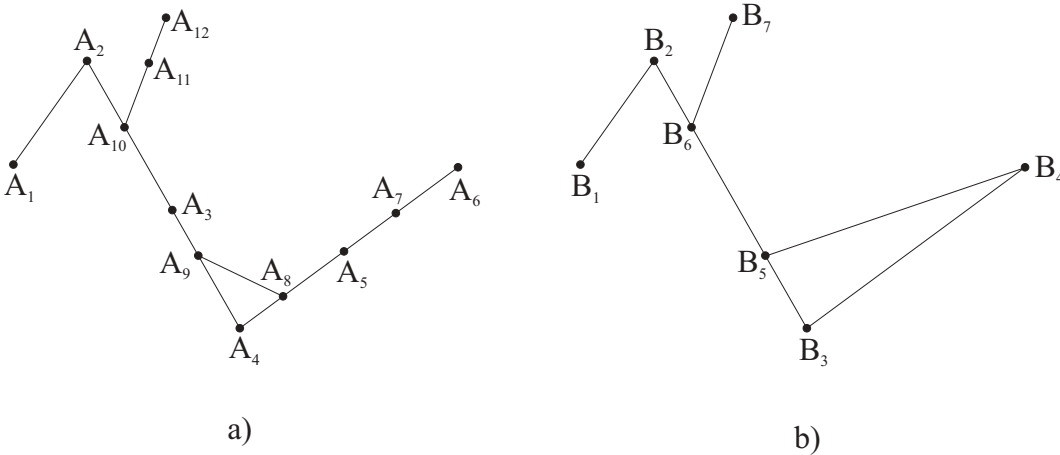

Figure 1.63: A peculiar path $A_1A_2 \dots A_{12}$ (a), and the corresponding naturalized path $B_1B_2 \dots B_7$ (b). Note that the path $A_1A_2 \dots A_{12}$ drawn here is a very perverse one: aside from being peculiar, it is not even semi-simple!

Proof. (sketch) Let $A \prec B$, $B \prec C$. If $A, B, C \in (A_i, A_{i+1})$ for some $i \in \mathbb{N}_n$, we have, using the definition, $A \prec B \& B \prec C \Rightarrow [A_iAB] \& [A_iBC] \xrightarrow{L^{1,2,3,2}} [A_iAC]$. The other cases are even more obvious. \square

We shall call a path $A_1A_2 \dots A_n$, which contains (at least once) three or more consecutive collinear vertices, a peculiar path. Otherwise the path is called non-peculiar. A subpath $A_{l+1}A_{l+2} \dots A_{l+k-1}A_{l+k}$, ($k \geq 3$), formed by consecutive collinear vertices in a peculiar path, is called a peculiar k -tuple, and the corresponding vertices are called peculiar vertices.¹⁶³ If $A_{l+1}A_{l+2} \dots A_{l+k}$, $k \geq 2$, is a peculiar k -tuple, A_{l+1} is called its first, and A_{l+k} its last point.

If two (or more¹⁶⁴) sides of a path share a vertex, they are said to be adjacent.

By definition, the angle between adjacent sides $A_{i-1}A_i$, A_iA_{i+1} , called also the angle at the vertex A_i , of a non-peculiar path $A_1A_2 \dots A_n$ is the angle $\angle(A_{i-1}A_i, A_iA_{i+1}) = \angle A_{i-1}A_iA_{i+1}$.

This angle is also denoted $\angle A_i$ whenever this simplified notation is not likely to lead to confusion.¹⁶⁵

An angle adjacent supplementary to an angle of a non-peculiar path (in particular, a polygon) is called an exterior angle of the path (polygon).

An angle $\angle A_{i-1}A_iA_{i+1}$, formed by two adjacent sides of the path $A_1A_2 \dots A_n$, is also said to be adjacent to its sides $A_{i-1}A_i$, A_iA_{i+1} , any of which, in its turn, is said to be adjacent to the angle $\angle A_{i-1}A_iA_{i+1}$.

Given a peculiar path $A_1A_2 \dots A_n$, define the corresponding depeculiarized, or naturalized path $B_1B_2 \dots B_p$ by induction, as follows (see Fig. 1.63):

Let $B_1 \Rightarrow A_1$; if $B_{k-1} = A_l$ let $B_k \Rightarrow A_m$, where m is the least integer greater than l such that the points A_{l-1} , A_l , A_m are not collinear, i.e. $m \Rightarrow \min\{p \mid l+1 \leq p \leq n \& \neg \exists b (A_{l-1} \in b \& A_l \in b \& A_m \in b)\}$. If no such m exists, $B_1B_2 \dots B_{k-1}$ is the required naturalized path.

In addition to naturalization, in the future we are going to need a related operation which we will refer to as straightening: given a path $A_1 \dots A_i \dots A_{i+k} \dots A_n$, we can replace it with the path $A_1 \dots A_iA_{i+k} \dots A_n$ (note that

¹⁶³Note that peculiar vertices are not necessarily all different. Only adjacent vertices are always distinct. So are all peculiar vertices in a semisimple path.

¹⁶⁴for paths that are not even semi-simple; see below

¹⁶⁵An angle between adjacent sides of a non-peculiar path (in particular, a polygon) will often be referred to simply as an angle of the path (polygon).

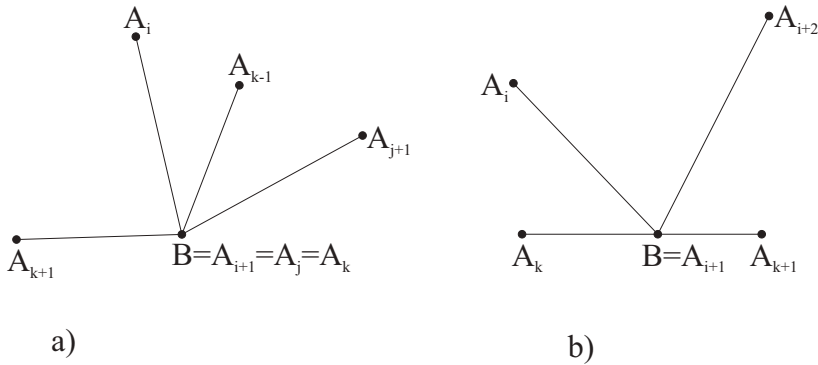

Figure 1.64: No three side - intervals meet in any point.

the vertices A_i, A_{i+k} are now adjacent). We say that we straighten the sides $A_i A_{i+1}, \dots, A_{i+k-1} A_{i+k}$ of the path $A_1 \dots A_n$ into the single side $A_i A_{i+k}$ of the new path $A_1 \dots A_i A_{i+k} \dots A_n$. Of course, this new path always contain fewer sides than the initial path.

Of course, there are paths (polygons) on which we can perform successive straightenings.

Simplicity and Related Properties

A path is termed semisimple if it has the following properties:

Property 1.2.9. *All its vertices (except the first and the last one in the case of a polygon) are distinct;*

Property 1.2.10. *No vertex lies on a side of the path;*

Property 1.2.11. *No pair of its sides meet.*

Alternatively, a path is called semisimple if the following properties hold:

Property 1.2.12. *No two side-intervals meet in any point which is not a vertex;*

Property 1.2.13. *No three side - intervals meet in any point.*

Property 1.2.14. *No side can contain an endpoint of the path.*

Lemma 1.2.38.2. *The two definitions of a semisimple path are equivalent.*

Proof. Obviously, Pr 1.2.12 is just a reformulation of Pr 1.2.11, so Pr 1.2.11 and Pr 1.2.12 are equivalent. It is also obvious that Pr 1.2.14 is a particular case of Pr 1.2.12.

To prove that Pr 1.2.9 – Pr 1.2.11 imply Pr 1.2.13 suppose the contrary, namely, that $\exists B \ B \in [A_i A_{i+1}] \cap [A_j A_{j+1}] \cap [A_k A_{k+1}]$, $i \neq j \neq k$. By Pr 1.2.12 B is an end of at least two of these side-intervals. Without loss of generality, we can assume $B = A_{i+1} = A_j$,¹⁶⁶ and thus we have $i + 1 = j$ by Pr 1.2.9.¹⁶⁷ $B = A_{i+1}$ does not coincide with either of the ends of $[A_k A_{k+1}]$ (Fig. 1.64, a) shows how this hypothetic situation would look), because each end is a vertex of the path, $i \neq j \neq k$ from our assumption, $i + 1 > 1$, and by Pr 1.2.9 the vertices A_i , where $i = 2, \dots, n$, are distinct. Nor can B lie on $(A_k A_{k+1})$, (see Fig. 1.64, b)) because A_{i+1} is a vertex, and by Pr 1.2.10 no vertex of the path can lie on its side. We have thus come to a contradiction which shows that Pr 1.2.13 is true. To show Pr 1.2.12 – Pr 1.2.14 \Rightarrow Pr 1.2.9 let $B \ni A_i = A_k$, where $1 < k - i < n - 1$.¹⁶⁸ Then the following three side - intervals meet in B :

for $i = 1$: $[A_1 A_2], [A_{k-1} A_k], [A_k A_{k+1}]$.¹⁶⁹

for $i > 1$: $[A_{i-1} A_i], [A_i A_{i+1}], [A_{k-1} A_k]$

They are all distinct because $1 < k - i$, and we arrive at a contradiction with Pr 1.2.13, which testifies the truth of Pr 1.2.9.

Finally, to prove Pr 1.2.12 – Pr 1.2.14 \Rightarrow Pr 1.2.10 suppose $A_i \in (A_k A_{k+1})$. But by Pr 1.2.14 $i \neq 1, n$, and thus $[A_{i-1} A_i], [A_i A_{i+1}]$ are both defined and meet $[A_k A_{k+1}]$ and each other in $B \ni A_i$ contrary to Pr 1.2.13. \square

Lemma 1.2.38.3. *If $A_{l+1} A_{l+2} \dots A_{l+k}$ is a peculiar k -tuple in a semisimple path $A_1 A_2 \dots A_n$, then $A_{l+1}, A_{l+2}, \dots, A_{l+k}$ are distinct points in order $[A_{l+1} A_{l+2} \dots A_{l+k}]$.*

¹⁶⁶Note that $[A_i A_{i+1}]$ and $[A_j A_{j+1}]$ enter our assumption symmetrically, so we can ignore the case $A_{j+1} = A_i$.

¹⁶⁷From Pr 1.2.9 all vertices of the path are distinct, except $A_1 = A_n$ in a polygon, and so the mapping $\psi : i \mapsto A_i$, where $i = 1, 2, \dots, n - 1$, is injective.

¹⁶⁸The first part of this inequality can be assumed due to symmetry on i, k ($k - i > 0$) and definition of a side as an (abstract) interval, which is a pair of distinct points (this gives $k - i \neq 1$). The second part serves to exclude the case of a polygon.

¹⁶⁹ $[A_k A_{k+1}]$ makes sense because $i = 1 \ \& \ k - i < n - 1 \Rightarrow k < n$.

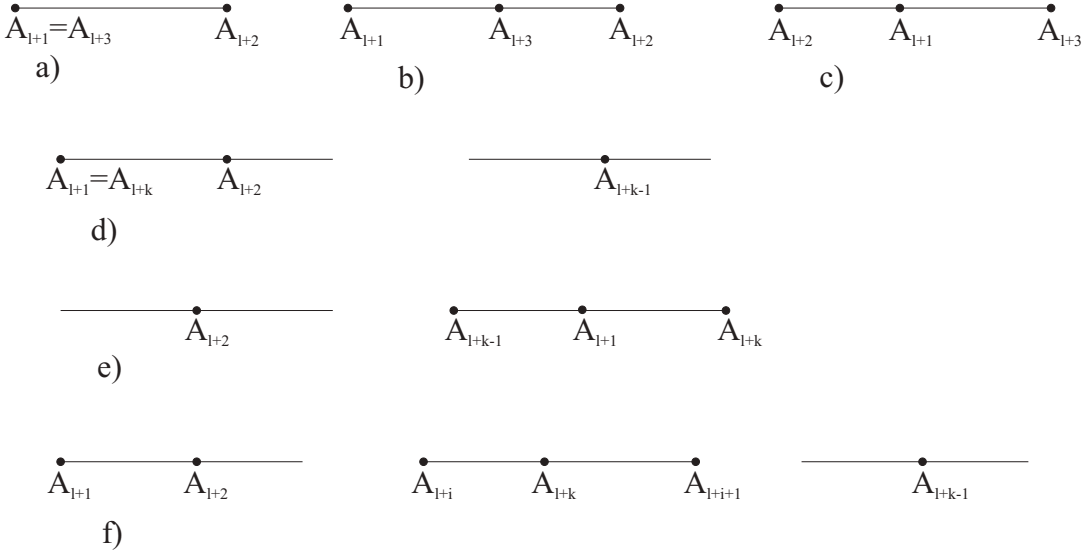

Figure 1.65: Illustration for proof of L 1.2.38.3.

Proof. By induction on k . Let $k = 3$. $A_{l+1} \neq A_{l+2}$, $A_{l+2} \neq A_{l+3}$ because $A_{l+1}A_{l+2}$, $A_{l+2}A_{l+3}$ are sides of the path and therefore are intervals, which are, by definition, pairs of *distinct* points. $A_{l+1} \neq A_{l+3}$ (this hypothetic case is shown in Fig.1.65, a)), because $A_{l+1}A_{l+2} = A_{l+2}A_{l+3} \xrightarrow{T1.2.1} (A_{l+1}A_{l+2}) \cap (A_{l+2}A_{l+3}) \neq \emptyset$, contrary to Pr 1.2.11. Since A_{l+1} , A_{l+2} , A_{l+3} are distinct and collinear (due to peculiarity), by T 1.2.2 $[A_{l+1}A_{l+3}A_{l+2}] \vee [A_{l+2}A_{l+1}A_{l+3}] \vee [A_{l+1}A_{l+2}A_{l+3}]$, but the first two cases (shown in Fig.1.65, b, c) contradict semisimplicity of $A_1A_2 \dots A_n$ by Pr 1.2.10.

Obviously, since $A_{l+1}A_{l+2} \dots A_{l+k}$ is a peculiar k -tuple, $A_{l+1}A_{l+2} \dots A_{l+k-1}$ is a peculiar $(k-1)$ -tuple. Then, by induction hypothesis, A_{l+1} , A_{l+2} , \dots , A_{l+k-1} are distinct points in order $[A_{l+1}A_{l+2} \dots A_{l+k-1}]$. $A_{l+k} \neq A_{l+k-1}$ by definition of $A_{l+k-1}A_{l+k}$. $A_{l+k} \neq A_{l+1}$, (this hypothetic case is shown in Fig.1.65, d)) because otherwise $[A_{l+1}A_{l+2} \dots A_{l+k-1}] \Rightarrow A_{l+2} \in (A_{l+k-1}A_{l+k})$, which by Pr 1.2.10 contradicts semisimplicity. Since A_{l+1} , A_{l+k-1} , A_{l+k} are distinct and collinear, we have by T 1.2.2 $[A_{l+k-1}A_{l+1}A_{l+k}] \vee [A_{l+1}A_{l+k}A_{l+k-1}] \vee [A_{l+1}A_{l+k-1}A_{l+k}]$. But $[A_{l+k-1}A_{l+1}A_{l+k}]$ contradicts Pr 1.2.10. (This situation is shown in Fig.1.65, e).) $[A_{l+1}A_{l+k}A_{l+k-1}] \Rightarrow A_{l+k} \in [A_{l+1}A_{l+k-1}] \xrightarrow{L1.2.7.7} \exists i \in \mathbb{N}_{k-2} A_{l+k} \in [A_{l+i}A_{l+i+1}]$, (see Fig.1.65, f)) which contradicts either Pr 1.2.9 or Pr 1.2.10, because A_{l+i} is a vertex, and $A_{l+i}A_{l+i+1}$ is a side of the path. Therefore, we can conclude that $[A_{l+1}A_{l+k-1}A_{l+k}]$. Finally, $[A_{l+1}A_{l+2} \dots A_{l+k-1}] \Rightarrow [A_{l+1}A_{l+k-1}A_{l+k}]$, $[A_{l+1}A_{l+k-2}A_{l+k-1}] \& [A_{l+1}A_{l+k-1}A_{l+k}] \xrightarrow{L1.2.3.2} [A_{l+k-2}A_{l+k-1}A_{l+k}]$, $[A_{l+1}A_{l+2} \dots A_{l+k-1}] \& [A_{l+k-2}A_{l+k-1}A_{l+k}] \xrightarrow{L1.2.7.3} [A_{l+1}A_{l+2} \dots A_{l+k-1}A_{l+k}]$. \square

Theorem 1.2.38. *Naturalization preserves the contour of a semisimple path. That is, if $A_1A_2 \dots A_n$ is a peculiar semisimple path, and $B_1B_2 \dots B_p$ is the corresponding naturalized path, then $\mathcal{P}_{B_1B_2 \dots B_p} = \mathcal{P}_{A_1A_2 \dots A_n}$.*

Proof. \square

A path that is both non-peculiar and semisimple is called simple. In the following, unless otherwise explicitly stated, all paths are assumed to be simple. ¹⁷⁰

Some Properties of Triangles and Quadrilaterals

Theorem 1.2.39. *If points A_1 , A_2 , A_3 do not colline, the triangle $\triangle A_1A_2A_3$ ¹⁷¹ is simple.*

Proof. Non-peculiarity is trivial. Let us show semisimplicity. Obviously, we must have $A_1 \neq A_2 \neq A_3$ for the abstract intervals A_1A_2 , A_2A_3 , A_3A_1 forming the triangle $\triangle A_1A_2A_3$ to make any sense. So Pr 1.2.9 holds. Pr 1.2.10, Pr 1.2.11 are also true for our case, because $\neg \exists a (A_i \in a \& A_j \in a \& A_k \in a) \xrightarrow{L1.2.1.9} [A_iA_j] \cap (A_jA_k) = \emptyset$, where $i \neq j \neq k$. \square

Lemma 1.2.40.1. *If points A , F lie on opposite sides of a line a_{EB} , the quadrilateral $FEAB$ is semisimple.*

Proof. (See Fig. 1.66.) Obviously, $\exists a_{AB} \Rightarrow A \neq B$ and $Aa_{EB}F \Rightarrow A \neq F$. Thus, the points F , E , A , B are all distinct, so Pr 1.2.9 holds in our case. ¹⁷² $Aa_{EB}F$ implies that A , E , B , as well as F , E , B are not collinear, whence by L 1.2.1.9 $[BE] \cap (EF) = \emptyset$, $[BE] \cap (EA) = \emptyset$, $[EB] \cap (BF) = \emptyset$, $[EB] \cap (BA) = \emptyset$, $[EA] \cap (AB) = \emptyset$, $[EF] \cap (FB) = \emptyset$. This means, in particular, that $B \notin (EF)$, $B \notin (EA)$, $E \notin (BF)$, $E \notin (BA)$. Also, $Aa_{EB}F \xrightarrow{T1.2.20}$

¹⁷⁰Note that, according to the naturalization theorem T 1.2.38, usually there is not much sense in considering peculiar paths.

¹⁷¹Recall that, by definition, $\triangle A_1A_2A_3$ is a closed path $A_1A_2A_3A_4$ with $A_4 = A_1$.

¹⁷²We have also taken into account the trivial observation that adjacent vertices of the quadrilateral are always distinct. (Every such pair of vertices forms an abstract interval.)

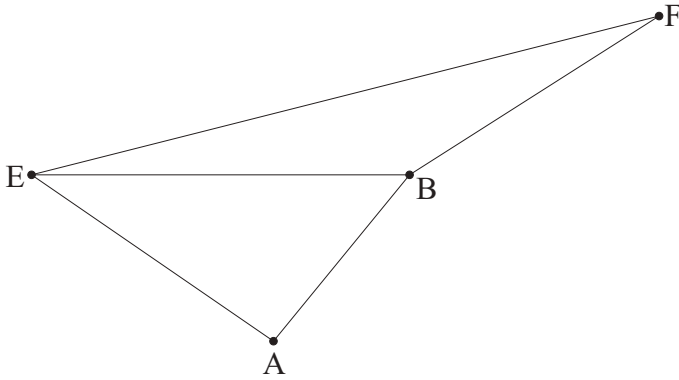

Figure 1.66: If points A, F lie on opposite sides of a line a_{EB} , the quadrilateral $FEAB$ is semisimple.

$[AE)a_{EB}(EF) \& [AE)a_{EB}(BF) \& [AB)a_{EB}(BF) \& [AB)a_{EB}(EF)$. From all this we can conclude that Pr 1.2.10, Pr 1.2.11 are true for the case in question. \square

Theorem 1.2.40. *Given a quadrilateral $FEAB$, if points E, B lie on opposite sides of the line a_{AF} , and A, F lie on opposite sides of a_{EB} , then the quadrilateral $FEAB$ is simple and no three of its vertices colline.* ¹⁷³

Proof. $Ea_{AF}B \Rightarrow E \notin a_{AF} \& B \notin a_{AF}$, $Aa_{EB}F \Rightarrow A \notin a_{EB} \& F \notin a_{EB}$. Thus, no three of the points F, E, A, B are collinear. This gives non-peculiarity of $FEAB$ as a particular case. But by (the preceding lemma) L 1.2.40.1, the quadrilateral $FEAB$ is also semisimple. \square

Given a quadrilateral $FEAB$, the open intervals (AF) , (EB) are referred to as the diagonals of the quadrilateral $FEAB$.

Theorem 1.2.41. *Given a quadrilateral $FEAB$, if points E, B lie on opposite sides of the line a_{AF} , and A, F lie on opposite sides of a_{EB} , then the open intervals (EB) , (AF) concur, i.e. the diagonals of the quadrilateral $FEAB$ meet in exactly one point. If, in addition, a point X lies between E, A , and a point Y lies between F, B , the open intervals (XY) , (AF) are also concurrent.* ¹⁷⁴

Proof. (See Fig. 1.67, a.) By the preceding theorem (T 1.2.40), the quadrilateral $FEAB$ is simple and no three of its vertices colline. We have also $Ea_{AF}B \Rightarrow \exists G G \in a_{AF} \& [EGB]$, $Aa_{EB}F \Rightarrow \exists H H \in a_{EB} \& [AHF]$, and therefore by L 1.2.1.3, A 1.1.2 $G \in a_{AF} \cap (EB) \& H \in a_{EB} \cap (AF) \& \neg \exists a (E \in a \& A \in a \& F \in a) \Rightarrow G = H$. Thus, $G \in (EB) \cap (AF)$, and by L 1.2.9.10, in view of the fact that no three of the points F, E, A, B colline, we can even write $G = (EB) \cap (AF)$.

Show 2nd part. We have $[EXA] \& [FYB] \& Ea_{AF}B \xrightarrow{T1.2.20} Xa_{AF}Y \Rightarrow \exists Z Z \in a_{AF} \& [XZY]$ and $G = (AF) \cap (EB) \xrightarrow{C1.2.21.26} EFa_{AB}$. $EFa_{AB} \& [AXE] \& [BYF] \xrightarrow{Pr??} YFa_{AB} \& XFa_{AB}$. With $[XZY]$, by L 1.2.19.9 this gives ZFa_{AB} . To show $Z \neq F$, suppose $Z = F$. (See Fig. 1.67, b.) Then $[XFY] \& [FYB] \xrightarrow{L1.2.3.1} [XFB]$ and by L 1.2.11.13, ¹⁷⁵ we have $[AXE] \& B \in E_B \& [XFB] \Rightarrow E_F \subset Int\angle AEB$. On the other hand, $G = (EB) \cap (AF) \xrightarrow{C1.2.21.25} E_B \subset Int\angle AEF$, so, in view of C 1.2.21.13 we have a contradiction. Also, $\neg[ZAF]$, for $[ZAF] \& [AGF] \xrightarrow{L1.2.3.2} [ZGF] \Rightarrow Za_{EB}F$ - a contradiction. Now the obvious symmetry of the conditions of the second part of the lemma with respect to the substitution $A \leftrightarrow F, X \leftrightarrow Y, B \leftrightarrow E$ ¹⁷⁶ allows us to conclude that also $A \neq Z$ and $\neg[ZFA]$. $[AGF] \xrightarrow{L1.2.1.3} G \in a_{AF}, Z \in a_{AF}$, the points A, F, Z colline. Therefore, $A \neq Z \neq F \& \neg[ZAF] \& \neg[ZFA] \xrightarrow{T1.2.1} [AZF]$. \square

Theorem 1.2.42. *Given four (distinct) coplanar points A, B, C, D , no three of them collinear, if the open interval (AB) does not meet the line a_{CD} and the open interval (CD) does not meet the line a_{AB} , then either the open intervals (AC) , (BD) concur, or the open intervals (AD) , (BC) concur.*

Proof. (See Fig. 1.68, a.) By definition, that A, B, C, D are coplanar means $\exists \alpha (A \in \alpha \& B \in \alpha \& C \in \alpha \& D \in \alpha)$. Since, by hypothesis, A, B, C and A, B, D , as well as A, C, D and B, C, D are not collinear (which means, of course, $C \notin a_{AB}, D \notin a_{AB}, A \notin a_{CD}, B \notin a_{CD}$), we have $C \in \mathcal{P}_\alpha \setminus \mathcal{P}_{a_{AB}} \& D \in \mathcal{P}_\alpha \setminus \mathcal{P}_{a_{AB}} \& (CD) \cap a_{AB} = \emptyset \Rightarrow CDa_{AB}$. Also, $BC \neq BD$, for otherwise B, C, D would colline. Therefore, $CDa_{AB} \& BC \neq BD \xrightarrow{L1.2.21.21} BC \subset Int\angle ABD \vee B_D \subset Int\angle ABC \xrightarrow{L1.2.21.10} (\exists X_1 X_1 \in B_C \& [AX_1D]) \vee (\exists X_2 X_2 \in B_D \& [AX_2C])$. Since the points A, B enter the conditions of the lemma symmetrically, we can immediately conclude that also $A_C \subset Int\angle BAD \vee A_D \subset Int\angle BAC$,

¹⁷³Thus, the theorem is applicable, in particular, in the case when the open intervals (AF) , (BE) concur.

¹⁷⁴We do not assume a priori the quadrilateral to be either non-peculiar or semisimple. That our quadrilateral in fact turns out to be simple is shown in the beginning of the proof.

¹⁷⁵which gives $[EXA] \Rightarrow X \in E_A$

¹⁷⁶That is, we substitute A for F, F for A, X for Y , etc.

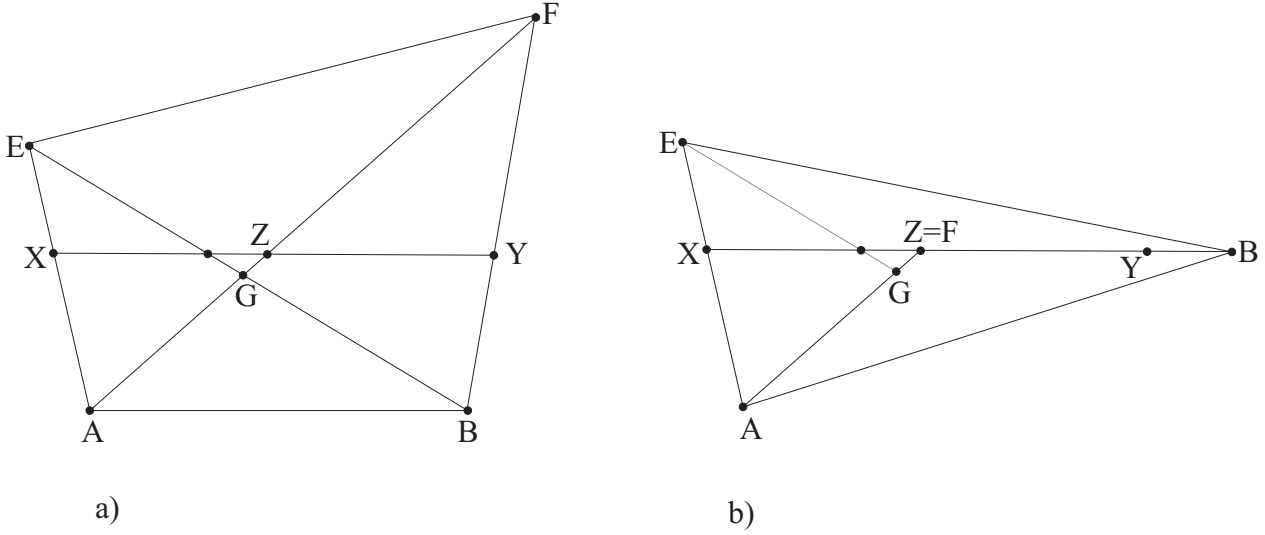

Figure 1.67: Illustration for proof of T 1.2.41.

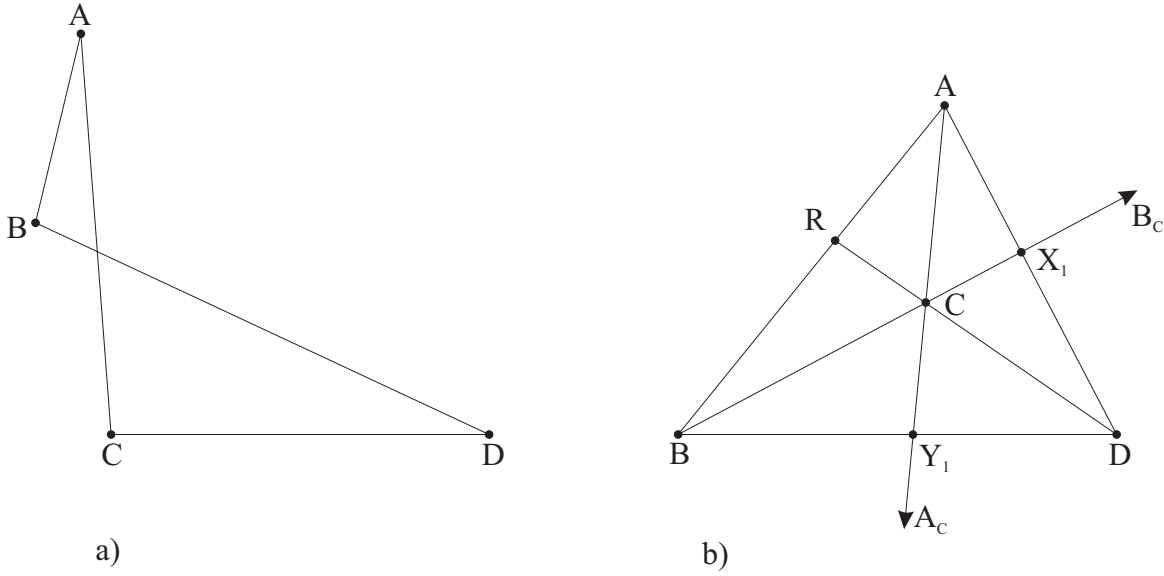

Figure 1.68: Illustration for proof of T 1.2.42.

whence $(\exists Y_1 Y_1 \in a_C \& [BY_1D]) \vee (\exists Y_2 Y_2 \in a_D \& [BY_2C])$. To show that $\exists X_1 X_1 \in a_B \& [AX_1D]$ and $\exists Y_1 Y_1 \in a_C \& [BY_1D]$ cannot hold together, suppose the contrary. (See Fig. 1.68, b.) Then $\neg \exists a (A \in a \& B \in a \& D \in a) \& [AX_1D] \& [DY_1B] \xrightarrow{L1.2.3.3} \exists C' [AC'Y_1] \& [BC'X_1] \xrightarrow{L1.2.1.3} C' \in a_{AY_1} \cap a_{BX_1}$. Obviously, also $Y_1 \in a_C \& C \notin a_{AB} \& X_1 \in a_B \Rightarrow a_{AY_1} = a_{AC} \neq a_{BC} = a_{BX_1}$. Therefore, $C' \in a_{AY_1} \cap a_{BX_1} \& C \in a_{AY_1} \cap a_{BX_1} \& a_{AY_1} \neq a_{BX_1} \xrightarrow{T1.1.1} C' = C$, and we have $B \notin a_{AD} \& [AX_1D] \& [BCX_1] \xrightarrow{C1.2.1.7} \exists R \in a_{CD} \& [ARB]$, which contradicts the condition $a_{CD} \cap (AB) = \emptyset$. Since the conditions of the theorem are symmetric with respect to the substitution $C \leftrightarrow D$, we can immediately conclude that $(\exists X_2 X_2 \in a_D \& [AX_2C])$ and $(\exists Y_2 Y_2 \in a_D \& [BY_2C])$ also cannot hold together. Thus, either both $(\exists X_1 X_1 \in a_B \& [AX_1D])$ and $(\exists Y_2 Y_2 \in a_D \& [BY_2C])$, or $(\exists X_2 X_2 \in a_D \& [AX_2C])$ and $(\exists Y_1 Y_1 \in a_C \& [BY_1D])$. In the first of these cases we have $X_1 \in a_{BC} \cap a_{AD} \& Y_2 \in a_{BC} \cap a_{AD} \& a_{BC} \neq a_{AD} \xrightarrow{T1.1.1} X_1 = Y_2$. Thus, $X_1 \in (AD) \cap (BC)$. Similarly, using symmetry with respect to the simultaneous substitutions $A \leftrightarrow B, C \leftrightarrow D$, we find that $X_2 \in (BD) \cap (AC)$. \square

Theorem 1.2.43. *If points A, B, C, D are coplanar, either the line a_{AD} and the segment $[BC]$ concur, or a_{BD} and $[AC]$ concur, or a_{CD} and $[AB]$ concur.*

Proof. We can assume that no three of the points A, B, C, D colline, since otherwise the result is immediate. Suppose $a_{CD} \cap [AB] = \emptyset$. If also $a_{AB} \cap (CD) = \emptyset$ then by (the preceding theorem) T 1.2.42 either (AC) and (BD) concur, whence a_{BD} and $[AC]$ concur, or (AD) and (BC) concur, whence a_{AD} and $[BC]$ concur. Suppose now $\exists E E \in a_{AB} \cap (CD)$. Using our another assumption $a_{CD} \cap [AB] = \emptyset$, we have $E \in Ext[AB] \xrightarrow{T1.2.1} [ABE] \vee [EAB]$. If $[ABE]$ (see Fig. 1.69, a), then $A \notin a_{CD} \& [CED] \& [ABE] \xrightarrow{C1.2.1.7} \exists F [AFC] \& a_{BD}$, and if $[EAB]$ (see Fig. 1.69, b),

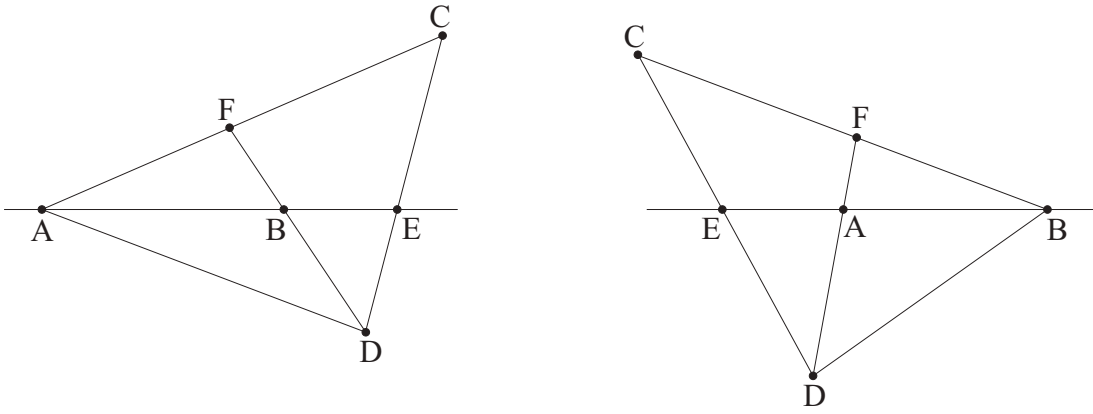

Figure 1.69: Illustration for proof of T 1.2.43.

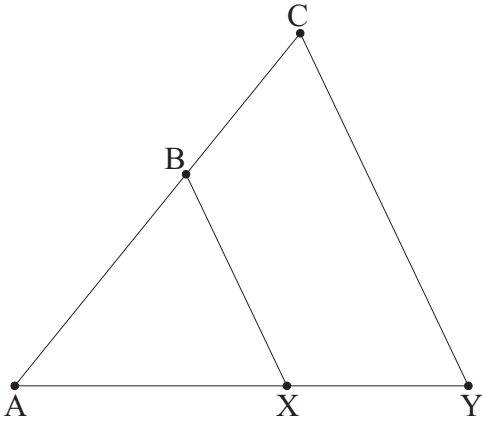

Figure 1.70: If a point X lies between A, Y , lines a_{XB}, a_{YC} are parallel, and A, B, C colline, B lies between A, C .

then $B \in a_{CD} \& [CED] \& [EAB] \xrightarrow{C1.2.1.7} \exists F F \in a_{AD} \& [BFC]$. Thus, $\exists F [AFC] \& a_{BD}$ or $\exists F F \in a_{AD} \& [BFC]$.
 \square

Theorem 1.2.44. *If a point X lies between points A, Y , lines a_{XB}, a_{YC} are parallel, and the points A, B, C colline, then B lies between A, C .*

Proof. (See Fig. 1.70.) Obviously,¹⁷⁷ the collinearity of A, B, C implies $A \in a_{BC}, a_{AC} = a_{AB}$. Using A 1.1.6, A 1.1.5 we can write $A \in a_{BC} \subset \alpha_{a_{BX}a_{CY}} \Rightarrow \alpha_{ACY} = \alpha_{a_{BX}a_{CY}} \Rightarrow a_{BX} \subset \alpha_{ACY}$. We have $a_{BX} \parallel a_{CY} \Rightarrow C \notin a_{BX} \& Y \notin a_{BX}$. Also, $a_{BX} \neq a_{AC}$ (otherwise $C \in a_{BX}$, which contradicts $a_{BX} \parallel a_{CY}$), and $a_{BX} \neq a_{AC} = a_{AB} \Rightarrow A \notin a_{BX}$. Therefore, $a_{BX} \subset \alpha_{ACY} \& A \notin a_{BX} \& C \notin a_{BX} \& Y \notin a_{BX} \& [AXY] \& X \in a_{BX} \& a_{BX} \cap (CY) = \emptyset \xrightarrow{A1.2.4} \exists B' B' \in a_{BX} \& [AB'C]$. But $B \in a_{BX} \cap a_{AC} \& B' \in a_{BX} \cap a_{AC} \& a_{BX} \neq a_{AC} \xrightarrow{T1.1.1} B' = B$. Hence $[ABC]$ as required. \square

Proposition 1.2.44.1. *If a line a is parallel to the side-line a_{BC} of a triangle $\triangle ABC$ and meets its side AB ¹⁷⁸ at some point E , it also meets the side AC of the same triangle.*

Proof. (See Fig. 1.71.) By the definition of parallel lines, $a \parallel a_{BC} \Rightarrow \exists \alpha a \subset \alpha \& a_{BC} \subset \alpha$. Also, $a \parallel a_{BC} \& E \in a \Rightarrow E \notin a_{BC}; E \in a \& a \subset \alpha \Rightarrow E \in \alpha; [AEB] \xrightarrow{C1.2.1.7} E \in \alpha_{ABC}$. Therefore, $E \in \alpha \& a_{BC} \subset \alpha \& E \in \alpha_{ABC} \& a_{BC} \subset E \in \alpha_{ABC} \xrightarrow{T1.1.2} \alpha = \alpha_{ABC}$. Thus, $a \subset \alpha_{ABC}$. Obviously, $a \parallel a_{BC} \Rightarrow B \notin a \& C \notin a$. Also, $A \notin a$, for otherwise $A \in a_{AB} \cap a \& E \in a_{AB} \cap a \& A \neq E \xrightarrow{A1.1.2} a = a_{AB} \Rightarrow B \in a$ - a contradiction.¹⁷⁹ Finally, $a \subset \alpha_{ABC} \& A \notin a \& B \notin a \& C \notin a \& \exists E (E \in (AB) \cap a) \& a \parallel a_{BC} \xrightarrow{A1.2.4} \exists F (F \in (AC) \cap a)$, q.e.d. \square

Theorem 1.2.45. *If a point A lies between points X, Y , lines a_{XB}, a_{YC} are parallel, and the points A, B, C colline, A lies between B, C .*

¹⁷⁷see C 1.1.1.5, L 1.1.1.4

¹⁷⁸That is, the open interval (AB) - see p. 69 on the ambiguity of our usage concerning the word "side".

¹⁷⁹Obviously, we are using in this, as well as in many other proofs, some facts like $[AEB] \xrightarrow{A1.2.1} A \neq E$, but we choose not to stop to justify them to avoid overloading our exposition with trivial details.

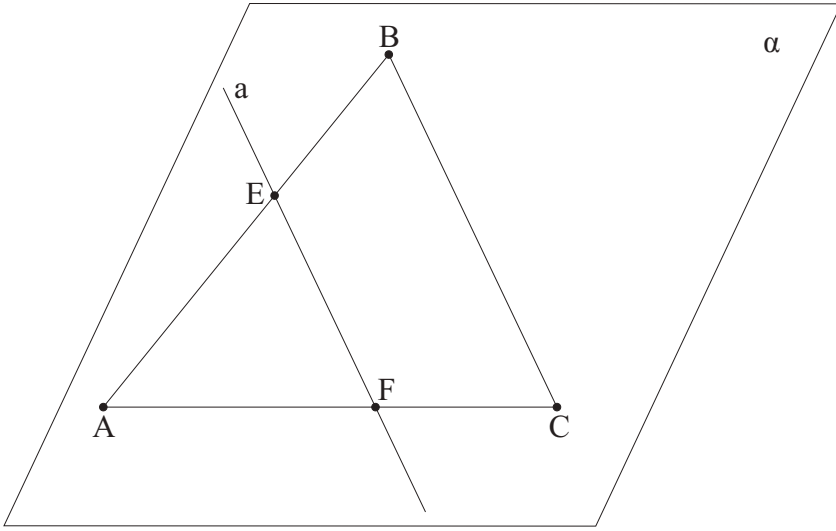

Figure 1.71: If a is parallel to a_{BC} and meets its side (AB) at E , it also meets (AC) .

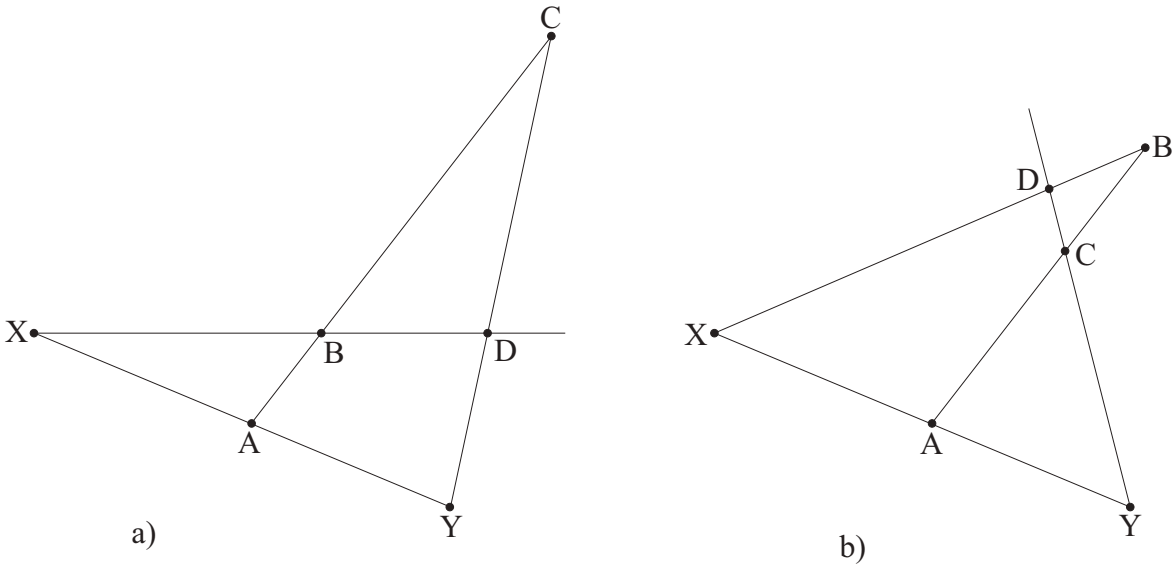

Figure 1.72: Illustration for proof of T 1.2.45.

Proof. We have $a_{XB} \parallel a_{YC} \stackrel{L1.1.7.1}{\implies} X \notin a_{YC} \& B \notin a_{XY}$ and $\exists a (A \in a \& B \in a \& C \in a) \stackrel{T1.2.2}{\implies} [ABC] \vee [ACB] \& [BAC]$. If $[ABC]$ (see Fig. 1.72, a)), we would have $X \notin a_{YC} \& [XAY] \& [ACB] \stackrel{C1.2.1.7}{\implies} \exists D \in a_{XB} \& [YDC] \stackrel{L1.2.1.3}{\implies} \exists D \in a_{XB} \cap a_{YC} \Rightarrow a_{XB} \nparallel a_{YC}$ - a contradiction. Similarly, assuming that $[ACB]$ (see Fig. 1.72, b)), we would have $B \notin a_{XY} \& [XAY] \& [ACB] \stackrel{C1.2.1.7}{\implies} \exists D \in a_{YC} \& [XDB] \stackrel{L1.2.1.3}{\implies} \exists D \in a_{YC} \cap a_{XB} \Rightarrow a_{YC} \nparallel a_{XB}$.¹⁸⁰ Thus, we are left with $[BAC]$, q.e.d. \square

Theorem 1.2.46. *If a point B lies between points A, C , lines a_{AX}, a_{BY} are parallel, as are a_{BY}, a_{CZ} , and if the points X, Y, Z colline, then Y lies between X and Z .*

Proof. (See Fig. 1.73.) By C 1.2.1.10 the lines a_{AX}, a_{BY}, a_{CZ} coplane. Therefore, $[ABC] \Rightarrow Aa_{BXC}$. We also have (from the condition of parallelism) $(CZ] \cap a_{BY} = \emptyset \& (AX] \cap a_{BY} = \emptyset \Rightarrow CZa_{BY} \& AXa_{BY}$. Then $AXa_{BY} \& CZa_{BY} \& Aa_{BY}C \stackrel{L1.2.17.11}{\implies} Xa_{BY}Z \Rightarrow \exists Y' \ Y' \in a_{BY} \& [XY'Z]$. But $Y \in a_{BY} \cap a_{XZ} \& Y' \in a_{BY} \cap a_{XZ} \& a_{XZ} \neq a_{BY} \stackrel{T1.1.1}{\implies} Y' = Y$. \square

¹⁸⁰There is a more elegant way to show that $\neg[ACB]$ if we observe that the conditions of the theorem are symmetric with respect to the simultaneous substitutions $B \leftrightarrow C, X \leftrightarrow Y$.

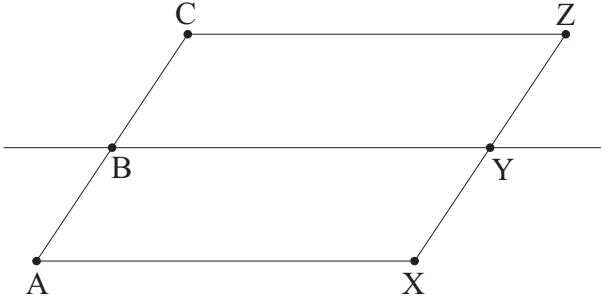

Figure 1.73: If a point B lies between A, C ; lines $a_{AX} \parallel a_{BY}$, $a_{BY} \parallel a_{CZ}$, and if X, Y, Z colline, then Y divides X and Z .

Basic Properties of Trapezoids and Parallelograms

A quadrilateral is referred to as a trapezoid if (at least) two of its side-lines are parallel. A quadrilateral $ABCD$ is called a parallelogram if $a_{AB} \parallel a_{CD}$, $a_{AC} \parallel a_{BD}$.¹⁸¹ $ABCD$

Corollary 1.2.47.1. *In a trapezoid no three of its vertices colline. Thus, a trapezoid, and, in particular, a parallelogram $ABCD$, is a non-peculiar quadrilateral. Furthermore, any side - line formed by a pair of adjacent vertices of a parallelogram lies completely on one side¹⁸² of the line formed by the other two vertices. In particular, we have CDa_{AB} , etc.*

Proof. Follows immediately from the definition of parallelogram and L 1.1.7.3, T 1.2.19. \square

Lemma 1.2.47.2. *Given a parallelogram $ABCD$, if a point X lies on the ray A_B , the open intervals (AC) , (DX) concur. In particular, (AC) and (BD) concur.*

Proof. By the preceding corollary (C 1.2.47.1) $B \notin a_{AD}$ and, moreover, BCa_{AD} . Therefore, $X \in a_{AB} \& B \notin a_{AD} \xrightarrow{L1.2.19.8} XB a_{AD}$, and $XB a_{AD} \& BCa_{AD} \xrightarrow{L1.2.17.1} XC a_{AD} \Rightarrow (XC) \cap a_{AD} = \emptyset \xrightarrow{L1.2.1.3} (XC) \cap (AD) = \emptyset$. Since also $a_{AX} = a_{AB} \parallel a_{CD} \xrightarrow{L1.2.1.3} (AX) \cap a_{CD} = \emptyset \& a_{AX} \cap (CD) = \emptyset$, the open intervals (AC) , (XD) concur by T 1.2.42. \square

Corollary 1.2.47.3. *Given a parallelogram $ABCD$, if a point X lies on the ray A_B , the ray A_C lies inside the angle $\angle XAD$.¹⁸³ In particular, the points X, D are on opposite sides of the line a_{AC} and A, C are on opposite sides of a_{DX} . In particular, the vertices B, D are on opposite sides of the line a_{AC} and A, C are on opposite sides of a_{DB} .*

Proof. Follows immediately from the preceding lemma (L 1.2.47.2) and C 1.2.21.25. \square

Corollary 1.2.47.4. *Suppose that in a trapezoid $ABCD$ with $a_{AB} \parallel a_{CD}$ the vertices B, C lie on the same side of the line a_{AD} . Then the open intervals (AC) , (BD) concur and $ABCD$ is a simple quadrilateral.*

Proof. Observe that the assumptions of the theorem imply that no three of the coplanar points A, B, C, D are collinear, the open interval (AB) does not meet the line a_{CD} , the open interval (CD) does not meet the line a_{AB} , and the open intervals (AD) , (BC) do not meet. Then the open intervals (AC) , (BD) concur by T 1.2.42 and the trapezoid $ABCD$ is simple by T 1.2.40. \square

Corollary 1.2.47.5. *Suppose that in a trapezoid $ABCD$ with $a_{BC} \parallel a_{AD}$ the open intervals (AB) , (CD) do not meet. Then the points C, D lie on the same side of the line a_{AB} .¹⁸⁴*

Proof. First, observe that no three vertices of $ABCD$ colline (see C 1.2.47.1), and thus $C \notin a_{AB}$, $D \notin a_{AB}$. To show that the points C, D lie on the same side of the line a_{AB} , suppose the contrary, i.e. that there is a point $E \in (CD) \cap a_{AB}$. Since $(CD) \subset \text{Int } a_{BC}a_{AD}$ (by L 1.2.19.16), we have $E \in \text{Int } a_{BC}a_{AD}$. Since $(AB) = a_{AB} \cap \text{Int } a_{BC}a_{AD}$ (again by L 1.2.19.16), we find that $E \in (AB)$, which in view of $E \in (CD)$ contradicts the condition of the theorem that the open intervals (AB) , (CD) do not meet. This contradiction shows that in reality the points C, D lie on the same side of the line a_{AB} . \square

Corollary 1.2.47.6. *Suppose that in a trapezoid $ABCD$ with $a_{BC} \parallel a_{AD}$ the open intervals (AB) , (CD) do not meet.¹⁸⁵ Then the ray A_C lies inside the angle $\angle BAD$ and the ray D_B lies inside the angle $\angle ADC$.¹⁸⁶*

¹⁸¹Thus, parallelogram is a particular case of trapezoid. Note that in the traditional terminology a trapezoid has *only* two parallel side-lines so that parallelograms are excluded.

¹⁸²i.e. completely inside one of the half-planes into which the line formed by the remaining vertices divides the plane of the parallelogram

¹⁸³And, of course, by symmetry the ray X_D then lies inside the angle $\angle AXC$, the ray C_A lies inside $\angle XCD$, and D_X lies inside $\angle ADC$.

¹⁸⁴Then also by symmetry the points A, B lie on the same side of the line a_{CD} . In particular, given a trapezoid $ABCD$ with $a_{BC} \parallel a_{AD}$, if the points A, B lie on the same side of the line a_{CD} then the points C, D lie on the same side of the line a_{AB} .

¹⁸⁵This will be true, in particular, if either A, B lie on the same side of a_{CD} or C, D lie on the same side of a_{AB} .

¹⁸⁶Then also by symmetry the ray B_D lies inside the angle $\angle ABC$ and the ray C_A lies inside the angle $\angle BCD$.

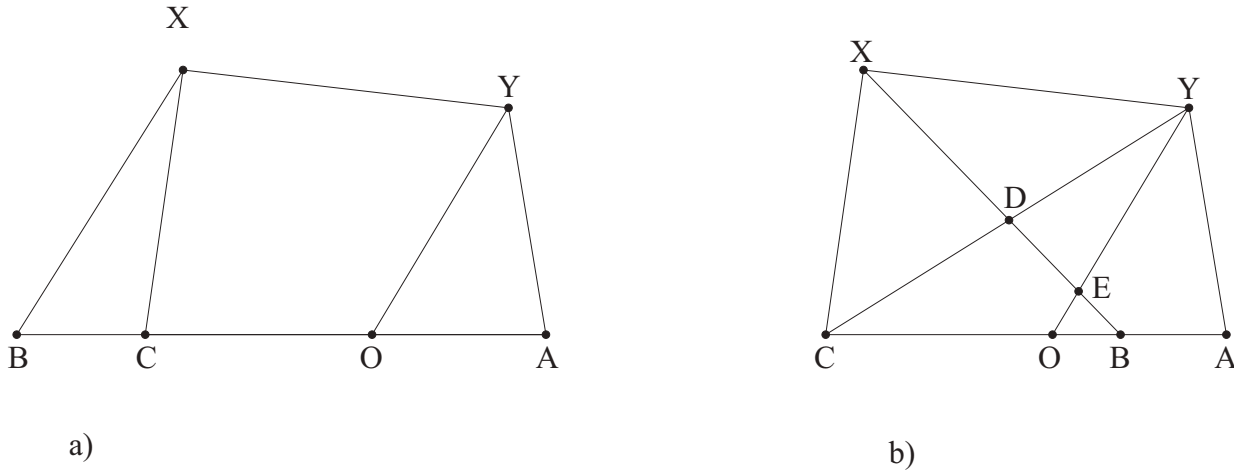

Figure 1.74: Illustration for proof of T 1.2.48.

Proof. Since (by hypothesis) $a_{AD} \parallel a_{BC}$, the points B, C lie on the same side of a_{AD} . Furthermore, from the preceding corollary (C 1.2.47.5) we have CDa_{AB}, ABa_{CD} . Hence in view of the definition of interior of angle we can write $ABa_{CD} \& BCa_{AD} \Rightarrow D_B \subset \text{Int}\angle ADC$ (see also L 1.2.21.4), $CDa_{AB} \& BCa_{AD} \Rightarrow AC \subset \text{Int}\angle BAD$. \square

Theorem 1.2.47. *A parallelogram is a simple quadrilateral.*

Proof. It is non-peculiar by C 1.2.47.1 and semisimple by C 1.2.47.1, L 1.2.40.1. \square

Theorem 1.2.48. *Given a parallelogram CAYX, if a point O lies between A, C, a point B lies on the line a_{AC} , and the lines a_{XB}, a_{OY} are parallel, then the point O lies between A, B. (See Fig. 1.74, a).)*

Proof. Suppose the contrary, i.e. $\neg[BOA]$. (See Fig. 1.74, b).) We have by L 1.2.1.3, A 1.2.1 $[COA] \Rightarrow O \in a_{AC} \& A \neq O$. Since also, by hypothesis, $B \in a_{AC}$, the points O, A, B are collinear. Taking into account $a_{XB} \parallel a_{OY} \Rightarrow O \neq B$, we can write $B \in a_{OA} \& \neg[BOA] \& B \neq O \& O \neq A$. Then by L 1.2.11.9, L 1.2.13.2 $[COA] \& B \in O_A \Rightarrow [COB] \& B \in C_A$. Since CAYX is a parallelogram and $B \in C_A$, by L 1.2.47.2 $\exists D D \in (XB) \cap (CY)$. Therefore, $Y \notin a_{CB} = a_{CA} \& [CDY] \& D \in a_{BX} \& [COB] \xrightarrow{C1.2.1.7} \exists E E \in a_{BX} \& [OEY] \Rightarrow \exists E E \in a_{BX} \cap a_{OY}$ - a contradiction. \square

Lemma 1.2.49.1. *Proof.* \square

Theorem 1.2.49. *If a polygon $A_1A_2A_3 \dots A_{n-1}A_n$ (i.e., a path $A_1A_2 \dots A_nA_{n+1}$ with $A_{n+1} = A_1$) is non-peculiar (semisimple, simple) the polygons $A_2A_3 \dots A_{n-1}A_nA_1, A_3A_4 \dots A_nA_1A_2, \dots, A_nA_1 \dots A_{n-2}A_{n-1}$ are non-peculiar (semisimple, simple) as well. Furthermore, the polygons $A_nA_{n-1}A_{n-2} \dots A_2A_1, A_{n-1}A_{n-2} \dots A_2A_1A_n, \dots, A_1A_nA_{n-1} \dots A_3A_2$ are also non-peculiar (semisimple, simple). Written more formally, if a polygon $A_1A_2A_3 \dots A_{n-1}A_n$ is non-peculiar (semisimple, simple), the polygon $A_{\sigma(1)}A_{\sigma(2)} \dots A_{\sigma(n-1)}A_{\sigma(n)}$ is non-peculiar (semisimple, simple) as well, and, more generally, the polygon $A_{\sigma^k(1)}A_{\sigma^k(2)} \dots A_{\sigma^k(n-1)}A_{\sigma^k(n)}$ is also non-peculiar (semisimple, simple), where σ is the permutation*

$$\sigma = \begin{pmatrix} 1 & 2 & \dots & n-1 & n \\ 2 & 3 & \dots & n & 1 \end{pmatrix},$$

i.e. $\sigma(i) = i + 1, i = 1, 2, \dots, n - 1, \sigma(n) = 1$, and $k \in \mathbb{N}$. Furthermore, the polygon $A_{\tau^k(1)}A_{\tau^k(2)} \dots A_{\tau^k(n-1)}A_{\tau^k(n)}$ is non-peculiar (semisimple, simple), where τ is the permutation

$$\tau = \sigma^{-1} = \begin{pmatrix} 1 & 2 & \dots & n-1 & n \\ n & 1 & \dots & n-2 & n-1 \end{pmatrix},$$

i.e. $\tau(1) = n, \tau(i) = i - 1, i = 2, 3, \dots, n$, and $k \in \{0\} \cup \mathbb{N}$.

Proof. Follows immediately by application of the appropriate definitions of non-peculiarity (semisimplicity, simplicity) to the polygons in question. ¹⁸⁷ \square

Theorem 1.2.50. *Proof.* \square

¹⁸⁷See the definition of peculiarity in p. 71 and the properties Pr 1.2.12 - Pr 1.2.14 defining semisimplicity.

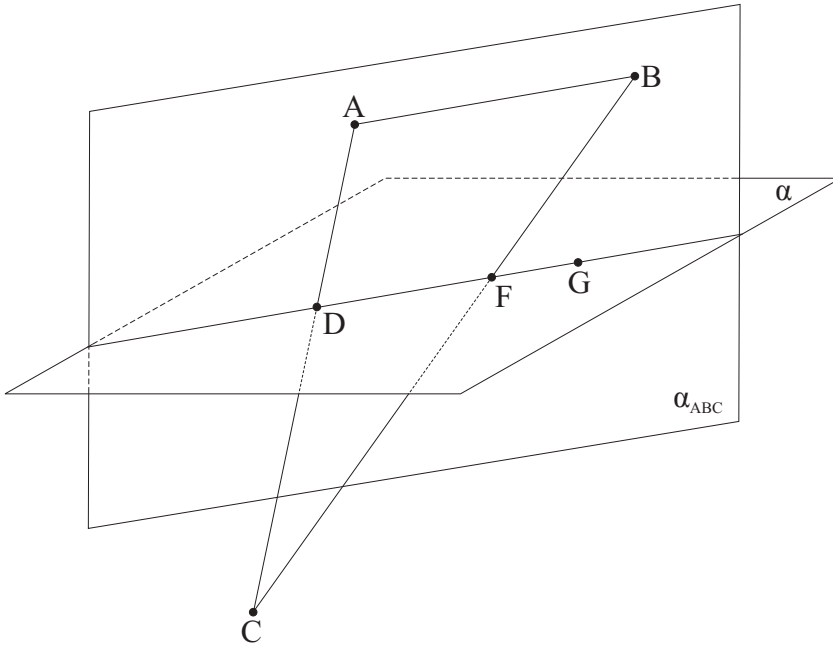

Figure 1.75: If A, B and B, C lie on one side of α , so do A, C .

Basic Properties of Half-Spaces

We say that a point B lies (in space) on the same side (on the opposite (other) side) of a plane α as the point A (from the point A) iff:

- Both A and B do not lie in plane α ;
- the interval AB meets (does not meet) the plane α ;

and write this as $AB\alpha(A\alpha B)$

Thus, we let, by definition

$$AB\alpha \stackrel{\text{def}}{\iff} A \in \alpha \& B \in \alpha \& \neg \exists C (C \in \alpha \& [ACB]); \text{ and}$$

$$AB\alpha \stackrel{\text{def}}{\iff} A \in \alpha \& B \in \alpha \& \exists C (C \in \alpha \& [ACB]).$$

Lemma 1.2.51.1. *The relation "to lie (in space) on the same side of a plane α as", i.e. the relation $\rho \subset \mathcal{C}^{Pt} \setminus \mathcal{P}_\alpha \times \mathcal{C}^{Pt} \setminus \mathcal{P}_\alpha$ defined by $(A, B) \in \rho \stackrel{\text{def}}{\iff} AB\alpha$, is an equivalence on $\mathcal{C}^{Pt} \setminus \mathcal{P}_\alpha$.*

Proof. By A 1.2.1 $AA\alpha$ and $AB\alpha \Rightarrow BA\alpha$. To prove $AB\alpha \& BC\alpha \Rightarrow AC\alpha$ assume the contrary, i.e. that $AB\alpha$, $BC\alpha$ and $A\alpha C$. Obviously, $A\alpha C$ implies that $\exists D D \in \alpha \& [ADC]$. Consider two cases:

If $\exists b (A \in b \& B \in b \& C \in b)$, by T 1.2.2 $[ABC] \vee [BAC] \vee [ACB]$. But $[ABC] \& [ADC] \& D \neq B \stackrel{T1.2.5}{\implies} [ADB] \vee [BDC]$, $[BAC] \& [ADC] \stackrel{L1.2.3.2}{\implies} [BDC]$, $[ACB] \& [ADC] \stackrel{L1.2.3.2}{\implies} [ADB]$, which contradicts $AB\alpha \& BC\alpha$.

Suppose now $\neg \exists b (A \in b \& B \in b \& C \in b)$ (See Fig. 1.75.) then (by A 1.1.1) $\exists \alpha_{ABC}$. $D \in \alpha \cap \alpha_{ABC} \stackrel{A1.1.7}{\implies} \exists G G \neq D \& G \in \alpha \cap \alpha_{ABC}$. By A 1.1.6 $a_{DG} \subset \alpha \cap \alpha_{ABC}$. $A \notin \alpha \& B \notin \alpha \& C \notin \alpha \& a_{DG} \subset \alpha \Rightarrow A \notin a_{DG} \& B \notin a_{DG} \& C \notin a_{DG}$. $A \notin a_{DG} \& B \notin a_{DG} \& C \notin a_{DG} \& a_{DG} \subset \alpha = \alpha_{ABC} \& (D \in a_{DG} \& [ADC]) \stackrel{A1.2.4}{\implies} \exists E (E \in a_{DG} \& [AEB]) \vee \exists F (F \in a_{DG} \& [BFC])$. Since, in view of $a_{DG} \subset \alpha$, we have either $[AEB] \& E \in \alpha_{ABC}$ or $[BFC] \& F \in \alpha_{ABC}$, this contradicts $AB\alpha \& BC\alpha$. \square

A half-space α_A is, by definition, the set of points lying (in space) on the same side of the plane α as the point B , i.e. $\alpha_A \stackrel{\text{def}}{=} \{B | AB\alpha\}$.

Lemma 1.2.51.2. *The relation "to lie on the opposite side of the plane α from" is symmetric.*

Proof. Follows from A 1.2.1. \square

In view of symmetry of the corresponding relations, if a point B lies on the same side of a plane α as (on the opposite side of a plane α from) a point A , we can also say that the points A and B lie on one side (on opposite (different) sides) of the plane α .

Lemma 1.2.51.3. *A point A lies in the half-space α_A .*

Lemma 1.2.51.4. *If a point B lies in a half-space α_A , then the point A lies in the half-space α_B .*

Lemma 1.2.51.5. *Suppose a point B lies in a half-space α_A , and a point C in the half-space α_B . Then the point C lies in the half-space α_A .*

Lemma 1.2.51.6. *If a point B lies in a half-space α_A then $\alpha_B = \alpha_A$.*

Proof. To show $\alpha_B \subset \alpha_A$ note that $C \in \alpha_B \& B \in \alpha_A \xrightarrow{C1.2.51.5} C \in \alpha_A$. Since $B \in \alpha_A \xrightarrow{C1.2.51.4} A \in \alpha_B$, we have $C \in \alpha_A \& A \in \alpha_B \xrightarrow{C1.2.51.5} C \in \alpha_B$ and thus $\alpha_A \subset \alpha_B$. \square

Lemma 1.2.51.7. *If half-spaces α_A and α_B have common points, they are equal.*

Proof. $\alpha_A \cap \alpha_B \neq \emptyset \Rightarrow \exists C \ C \in \alpha_A \& C \in \alpha_B \xrightarrow{L1.2.51.6} \alpha_A = \alpha_C = \alpha_B$. \square

Lemma 1.2.51.8. *Two points A, B in space lie either on one side or on opposite sides of a given plane α .*

Proof. Follows immediately from the definitions of "to lie on one side" and "to lie on opposite side". \square

Lemma 1.2.51.9. *If points A and B lie on opposite sides of a plane α , and B and C lie on opposite sides of the plane α , then A and C lie on the same side of α .*

Proof. ¹⁸⁸ $A\alpha B \& B\alpha C \Rightarrow \exists D \ (D \in \alpha \& [ADB]) \& \exists E \ (E \in \alpha \& [BEC])$. Let α_1 be a plane drawn through points A, B, C . (And possibly also through some other point G if A, B, C are collinear - see A 1.1.3, A 1.1.4.) Since $A \in \alpha_1$ but $A \notin \alpha$, the planes α_1, α are distinct. We also have $[ADB] \& A \in \alpha_1 \& B \in \alpha_1 \& [BEC] \& C \in \alpha_1 \xrightarrow{C1.2.1.11} D \in \alpha_1 \& E \in \alpha_1$, whence it follows that $D \in \alpha_1 \cap \alpha \Rightarrow \alpha_1 \cap \alpha \neq \emptyset$. Since the planes α_1, α are distinct but have common points, from T 1.1.5 it follows that there is a line a containing all their common points. In particular, we have $D \in a, E \in a$. We are now in a position to prove that points A, C lie on the same side of the plane α , i.e. that $\neg \exists F \ (F \in \alpha \& [AFC])$. In fact, otherwise $A \in \alpha_1 \& C \in \alpha_1 \& [AFC] \Rightarrow \xrightarrow{C1.2.1.11} F \in \alpha_1$, and we have $F \in \alpha_1 \cap \alpha \Rightarrow F \in a$. But since $A \notin \alpha \Rightarrow A \notin a$, we can always (whether points A, B, C are collinear or not) write $(D \in a \& [ADB]) \& (E \in a \& [BEC]) \xrightarrow{T1.2.6} \neg \exists F \ (F \in a \& [AFC])$, and we arrive at a contradiction. \square

Lemma 1.2.51.10. *If a point A lies on the same side of a plane α as a point C and on the opposite side of α from a point B , the points B and C lie on opposite sides of the plane α .*

Proof. Points B, C cannot lie on the same side of α , because otherwise $AC\alpha \& BC\alpha \Rightarrow AB\alpha$ - a contradiction. Then $B\alpha C$ by L 1.2.51.8. \square

Lemma 1.2.51.11. *Let points A and B lie in on opposite sides of plane α , and points C and D - in the half-spaces α_A and α_B , respectively. Then the points C and D lie on opposite sides of α .*

Proof. $AC\alpha \& A\alpha B \& BD\alpha \xrightarrow{L1.2.51.10} C\alpha D$. \square

Theorem 1.2.51. *Proof.* \square

Point Sets in Half-Spaces

Given a plane α , a nonempty point set \mathcal{B} is said to lie (in space) on the same side (on the opposite side) of the plane α as (from) a nonempty point set \mathcal{A} iff for all $A \in \mathcal{A}$ and all $B \in \mathcal{B}$ the point B lies on the same side (on the opposite side) of the plane α as (from) the point $A \in \mathcal{A}$. If the set \mathcal{A} (the set \mathcal{B}) consists of a single element (i.e., only one point), we say that the set \mathcal{B} (the point B) lies in plane α on the same side of the line a as the point A (the set \mathcal{A}).

If all elements of a point set \mathcal{A} lie (in space) on one side of a plane α , it is legal to write $\alpha_{\mathcal{A}}$ to denote the side of α that contains all points of \mathcal{A} .

Lemma 1.2.52.1. *If a set \mathcal{B} lies on the same side of a plane α as a set \mathcal{A} , then the set \mathcal{A} lies on the same side of the plane α as the set \mathcal{B} .*

Proof. See L 1.2.51.1. \square

Lemma 1.2.52.2. *If a set \mathcal{B} lies in on the same side of a plane α as a set \mathcal{A} , and a set \mathcal{C} lies in on the same side of the plane α as the set \mathcal{B} , then the set \mathcal{C} lies in on the same side of the plane α as the set \mathcal{A} .*

Proof. See L 1.2.51.1. \square

Lemma 1.2.52.3. *If a set \mathcal{B} lies on the opposite side of a plane α from a set \mathcal{A} , then the set \mathcal{A} lies in on the opposite side of the plane α from the set \mathcal{B} .*

Proof. See L 1.2.51.2. \square

The lemmas L 1.2.51.9 – L 1.2.51.11 can be generalized in the following way:

Lemma 1.2.52.4. *If point sets \mathcal{A} and \mathcal{B} lie on opposite sides of a plane α , and the sets \mathcal{B} and \mathcal{C} lie on opposite sides of the plane α , then \mathcal{A} and \mathcal{C} lie on the same side of α .*

Lemma 1.2.52.5. *If a point set \mathcal{A} lies on the same side of a plane α as a point set \mathcal{C} and on the opposite side of α from the point set \mathcal{B} , the point sets \mathcal{B} and \mathcal{C} lie on opposite sides of the plane α .*

¹⁸⁸The reader can refer to Fig. 1.75 after making appropriate (relatively minor) replacements in notation.

Proof. \square

Lemma 1.2.52.6. *Let point sets \mathcal{A} and \mathcal{B} lie in on opposite sides of a plane α , and point sets \mathcal{C} and \mathcal{D} - on the same side of α as \mathcal{A} and \mathcal{B} , respectively. Then \mathcal{C} and \mathcal{D} lie on opposite sides of α .*

In view of symmetry of the relations, established by the lemmas above, if a set \mathcal{B} lies on the same side (on the opposite side) of a plane α as a set (from a set) \mathcal{A} , we say that the sets \mathcal{A} and \mathcal{B} lie in on one side (on opposite sides) of the plane α .

Theorem 1.2.52. *Proof.* \square

Complementary Half-Spaces

Given a half-space α_A , we define the half-space α_A^c , complementary to the half-space α_A , as $\mathcal{C}^{Pt} \setminus (\mathcal{P}_\alpha \cup \alpha_A)$.

An alternative definition of complementary half-space is provided by the following

Lemma 1.2.53.1. *Given a half-space α_A , the complementary half-space α_A^c is the set of points B such that the open interval (AB) meets the plane α : $\alpha_A^c \Leftrightarrow \{\exists O O \in \alpha \& [OAB]\}$. A point C lying in space outside α lies either in α_A or on α_A^c .*

Proof. $B \in \mathcal{C}^{Pt} \setminus (\mathcal{P}_\alpha \cup \alpha_A) \stackrel{L1.2.51.8}{\Leftrightarrow} A\alpha B \Leftrightarrow \exists O O \in \alpha \& [AOB]$. \square

Lemma 1.2.53.2. *The half-space $(\alpha_A^c)^c$, complementary to the half-space α_A^c , complementary to the half-space α_A , coincides with the half-space α_A itself.*

Proof. In fact, we have $\alpha_A = \mathcal{C}^{Pt} \setminus (\mathcal{P}_\alpha \cup (\mathcal{C}^{Pt} \setminus (\mathcal{P}_\alpha \cup \alpha_A))) = (\alpha_A^c)^c$. \square

Lemma 1.2.53.3. *A line b that is parallel to a plane α and has common points with a half-space α_A , lies (completely) in α_A .*

Proof. (See Fig. 1.76, a.) By hypothesis, $b \cap \alpha = \emptyset$. To prove that $b \cap \alpha_A^c = \emptyset$ suppose that $\exists D D \in b \cap \alpha_A^c$ (see Fig. 1.76, b.). Then $AB\alpha \& A\alpha D \stackrel{L1.2.51.10}{\Rightarrow} \exists C C \in \alpha \& [BCD] \stackrel{L1.2.1.3}{\Rightarrow} \exists C C \in \alpha \cap a_{BD} = b$ - a contradiction. Thus, we have shown that $b \subset \mathcal{C}^{Pt} \setminus (\mathcal{P}_\alpha \cup \alpha_A^c) = \alpha_A$. \square

Given a ray O_B , not meeting a plane α

Lemma 1.2.53.4. *- If the origin O lies in a half-space α_A , so does the whole ray O_B .*

Proof. (See Fig. 1.77.) By hypothesis, $O_B \cap \alpha = \emptyset$. To prove $O_B \cap \alpha_A^c = \emptyset$, suppose $\exists F F \in O_B \cap \alpha_A^c$. $O \in \alpha_A \& F \in \alpha_A^c \Rightarrow \exists E E \in \alpha \& [OEF] \stackrel{L1.2.11.13}{\Rightarrow} \exists E E \in \alpha \cap O_B$ - a contradiction. Thus, $O_B \subset \mathcal{C}^{Pt} \setminus (\mathcal{P}_\alpha \cup \alpha_A^c) = \alpha_A$. \square

Lemma 1.2.53.5. *- If the ray O_B and the half-space α_A have a common point D , then:*

- The initial point O of O_B lies either in half-space α_A or on plane α ;*
- The whole ray O_B lies in the half-space α_A .*

Proof. a) (See Fig. 1.78, a.) To prove $O \notin \alpha_A^c$, suppose the contrary, i.e. $O \in \alpha_A^c$. Then $D \in \alpha_A \& O \in \alpha_A^c \Rightarrow \exists E E \in \alpha \& [OED] \stackrel{L1.2.11.13}{\Rightarrow} \exists E E \in \alpha \cap O_B$ - a contradiction. We see that $O \in \mathcal{C}^{Pt} \setminus \alpha_A^c = \alpha_A \cup \mathcal{P}_\alpha$.

b) (See Fig. 1.78, b.) By hypothesis, $\alpha \cap O_B = \emptyset$. If $\exists F F \in O_B \cap \alpha_A^c$, we would have $D \in \alpha_A \& F \in \alpha_A^c \Rightarrow \exists E E \in \alpha \& [DEF] \stackrel{L1.2.16.4}{\Rightarrow} \exists E E \in \alpha \cap O_B$ - a contradiction. Therefore, $O_B \subset \mathcal{C}^{Pt} \setminus (\mathcal{P}_\alpha \cup \alpha_A^c) = \alpha_A$. \square

Given an open interval (DB) , not meeting a plane α

Lemma 1.2.53.6. *- If one of the ends of (DB) lies in the half-space α_A , the open interval (DB) completely lies in the half-space α_A and its other end lies either on α_A or on plane α .*

Proof. (See Fig. 1.79.) If $B \in \alpha_A^c$ then $D \in \alpha_A \& B \in \alpha_A^c \Rightarrow \exists E (E \in \alpha \& [DEB])$ - a contradiction. By hypothesis, $(DB) \cap \alpha = \emptyset$. To prove $(DB) \cap \alpha_A^c = \emptyset$, suppose $F \in (DB) \cap \alpha_A^c$. Then $D \in \alpha_A \& F \in \alpha_A^c \Rightarrow \exists E (E \in \alpha \& [DEF])$. But $[DEF] \& [DFB] \stackrel{L1.2.3.2}{\Rightarrow} [DEB]$ - a contradiction. \square

Lemma 1.2.53.7. *- If the open interval (DB) and the half-space α_A have at least one common point G , then the open interval (DB) lies completely in α_A , and either both its ends lie in α_A , or one of them lies in α_A , and the other in plane α .*

Proof. Both ends of (DB) cannot lie on α , because otherwise by C 1.2.1.11 we have $(BD) \subset \alpha$, whence $(BD) \cap \alpha_A = \emptyset$. Let $D \notin \alpha$. To prove $D \notin \alpha_A^c$ suppose the contrary, i.e. $D \in \alpha_A^c$. Then $D \in \alpha_A^c \& (BD) \cap \alpha = \emptyset \stackrel{L1.2.53.6}{\Rightarrow} (DB) \subset \alpha_A^c \Rightarrow G \in \alpha_A^c$ - a contradiction. Therefore, $D \in \alpha_A$. Finally, $D \in \alpha_A \& (DB) \cap \alpha = \emptyset \stackrel{L1.2.19.6}{\Rightarrow} (BD) \subset \alpha_A$. \square

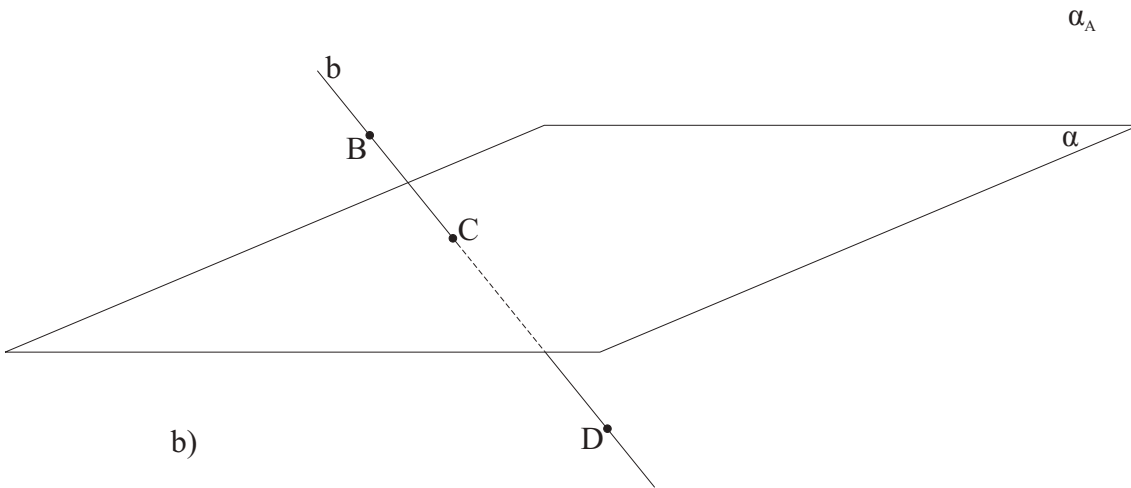
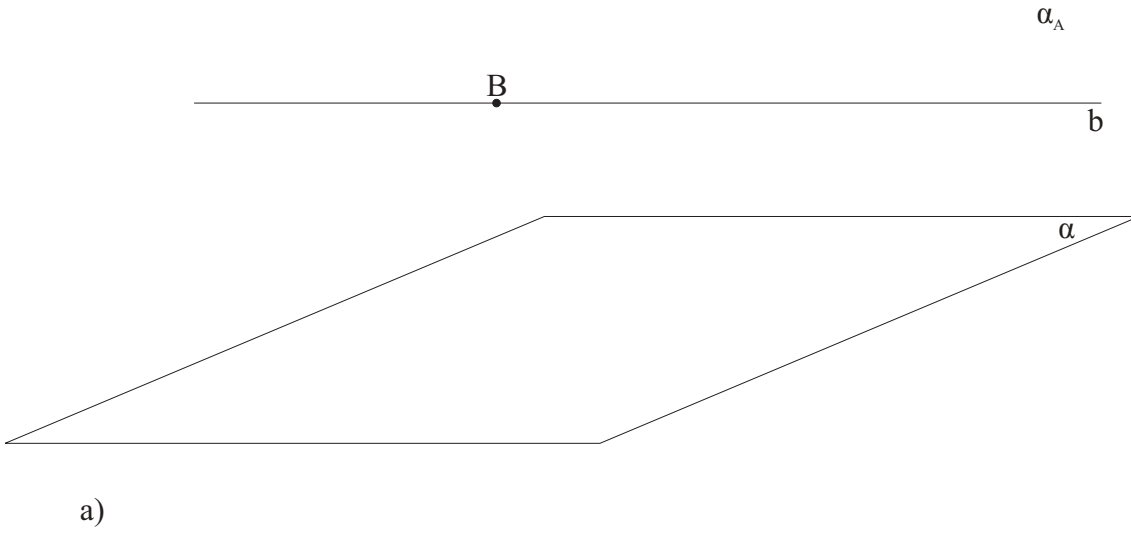

Figure 1.76: A line b parallel to a plane α and having common points with α_A , lies in α_A .

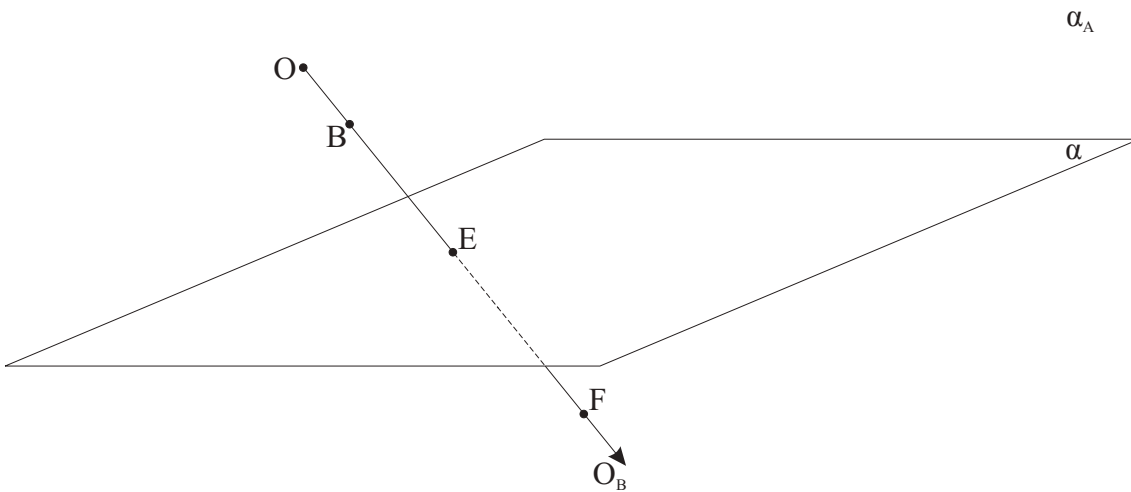
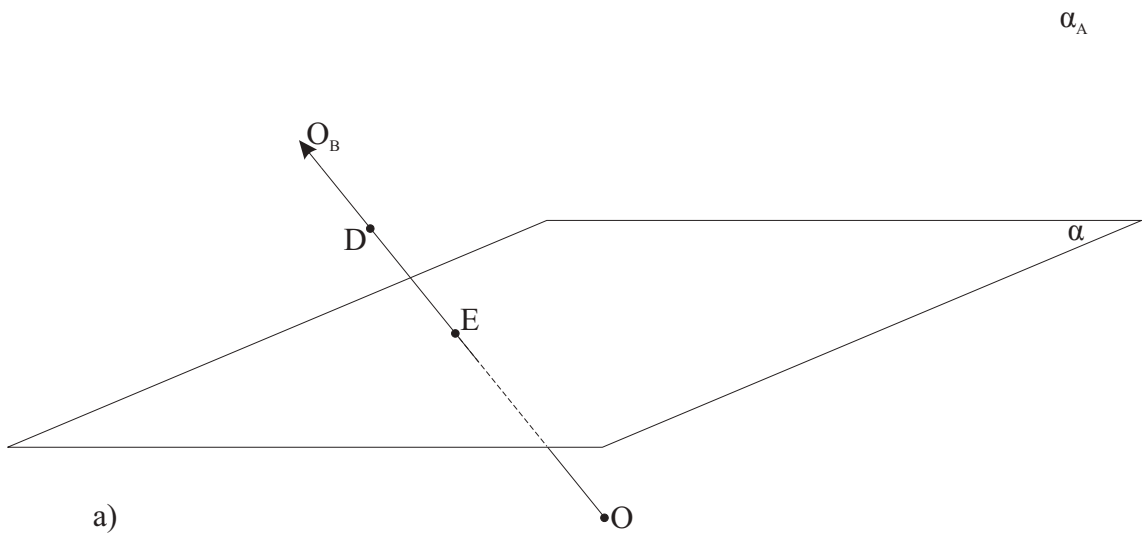
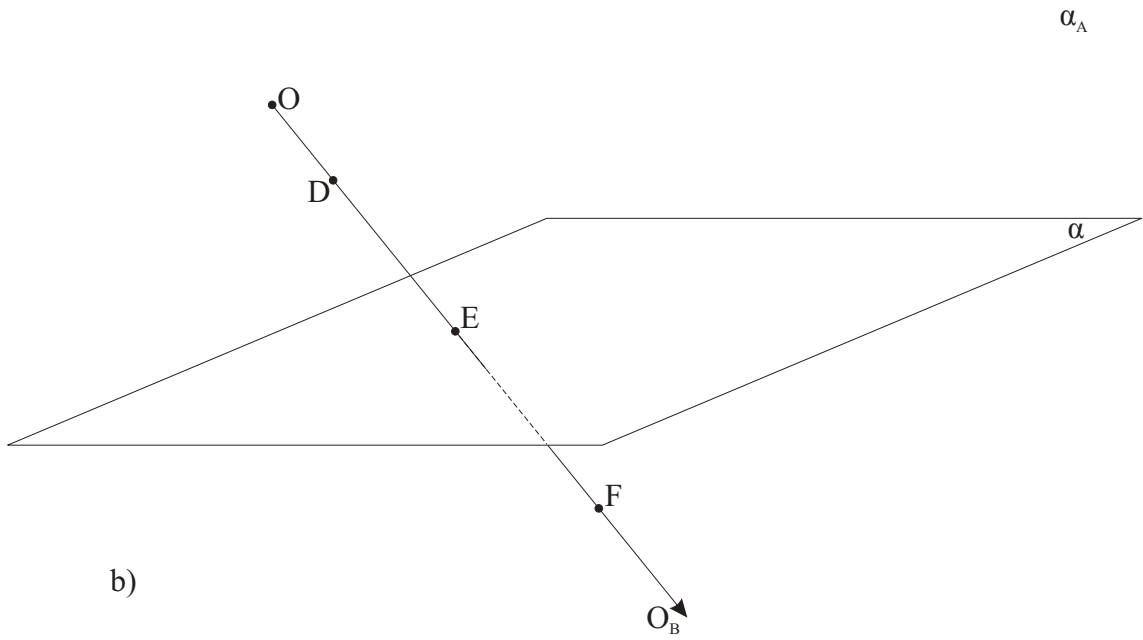

Figure 1.77: Given a ray O_B , not meeting a plane α , if a point O lies in the half-space α_A , so does O_B .



a)



b)

Figure 1.78: Given a ray O_B , not meeting a plane α , if O_B and α_A share a point D , then: a) O lies in α_A or on α ; b) O_B lies in α_A .

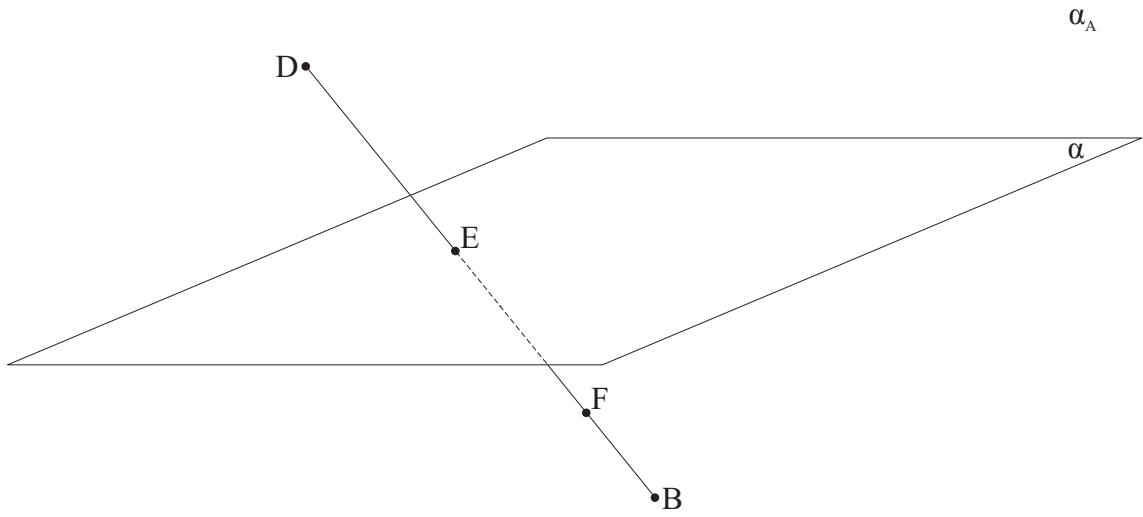

Figure 1.79: Given an open interval (DB) , not meeting a plane α , if one of the ends of (DB) lies in α_A , then (DB) lies in α_A and its other end lies either in α_A or on α .

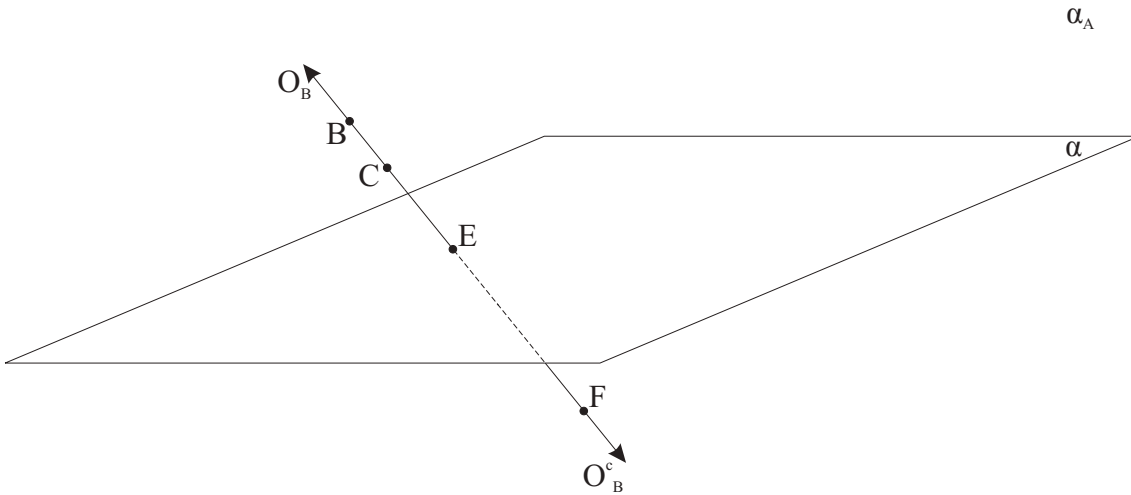

Figure 1.80: A ray O_B with its initial point O on α and one of its points C in α_A , lies in α_A , and O_B^c lies in α_A^c .

Lemma 1.2.53.8. *A ray O_B having its initial point O on a plane α and one of its points C in a half-space α_A , lies completely in α_A , and its complementary ray O_B^c lies completely in the complementary half-space α_A^c .*

In particular, given a plane α and points $O \in \alpha$ and $A \notin \alpha$, we always have $O_A \subset \alpha_A$, $O_A^c \subset \alpha_A^c$. We can thus write $\alpha_A^c = \alpha_{O_A^c}$.

Proof. (See Fig. 1.80.) $O_B \cap \alpha = \emptyset$, because if $\exists E E \in O_B \& E \in \alpha$, we would have $O \in a_{OB} \cap \alpha \& O \in a_{OB} \cap \alpha \xrightarrow{A1.1.6} a_{OB} \subset \alpha \Rightarrow C \in \alpha$ - a contradiction. $O_B \subset a_{OB} = a_{OC} \subset \alpha_{a_A} \& C \in O_B \cap \alpha_A \& O_B \cap \alpha = \emptyset \xrightarrow{L1.2.19.5} O_B \subset \alpha_A$. By A 1.1.2 $\exists F [BOF]$. Since $F \in O_B^c \cap \alpha_A^c$, by preceding argumentation we conclude that $O_B^c \subset \alpha_A^c$. \square

Lemma 1.2.53.9. *If one end of an open interval (DB) lies in half-space α_A , and the other end lies either in α_A or on plane α , the open interval (DB) lies completely in α_A .*

Proof. Let $B \in \alpha_A$. If $D \in \alpha_A$ we note that by L 1.2.11.13 $(DB) \subset D_B$ and use the preceding lemma (L 1.2.53.8). Let now $D \in \alpha$. Then $(DB) \cap \alpha = \emptyset$, because $B \in \alpha_A \& E \in (DB) \cap \alpha \Rightarrow D \in \alpha_A^c$ - a contradiction. Finally, $B \in \alpha_A \& (DB) \cap \alpha = \emptyset \xrightarrow{L1.2.19.6} (DB) \subset \alpha_A$. \square

Lemma 1.2.53.10. *If a plane β , parallel to a plane α , has at least one point in a half-space α_A , it lies completely in α_A .*

Proof. (See Fig. 1.81, a.) By hypothesis, $\beta \cap \alpha = \emptyset$. To show $\beta \cap \alpha_A^c = \emptyset$, suppose the contrary, i.e. that $\exists D D \in \beta \cap \alpha_A^c$ (see Fig. 1.81, b)). Then $B \in \alpha_A \& D \in \alpha_A^c \Rightarrow \exists C [BCD] \& C \in \alpha$. But $B \in \beta \& D \in \beta \& [BCD] \xrightarrow{C1.2.1.11} C \in \beta$. Hence $C \in \alpha \cap \beta$, which contradicts the hypothesis. Thus, we have $\beta \subset \mathcal{C}^{Pt} \setminus (\mathcal{P}_\alpha \cup \alpha_A^c) = \alpha_A$. \square

Lemma 1.2.53.11. *If a half-plane χ has no common points with a plane α and one of its points, B , lies in a half-space α_A , the half-plane χ lies completely in the half-space α_A .*

Proof. By hypothesis, $\chi \cap \alpha = \emptyset$. To show $\chi \cap \alpha_A^c = \emptyset$, suppose the contrary, i.e. that $\exists D D \in \chi \cap \alpha_A^c$. Then $B \in \alpha_A \& D \in \alpha_A^c \Rightarrow \exists C [BCD] \& C \in \alpha$. But $B \in \beta \& D \in \beta \& [BCD] \xrightarrow{L1.2.19.9} C \in \chi$. Hence $C \in \alpha \cap \chi$, which contradicts the hypothesis. Thus, we have $\chi \subset \mathcal{C}^{Pt} \setminus (\mathcal{P}_\alpha \cup \alpha_A^c) = \alpha_A$. \square

Lemma 1.2.53.12. *A half-plane χ having its edge a on a plane α and one of its points, B , in a half-space α_A , lies completely in α_A , and the complementary half-plane χ^c lies completely in the complementary half-space α_A^c .*

In particular, given a plane α , a line a in it, and a point $A \notin \alpha$, we always have $a_A \subset \alpha_A$, $a_A^c \subset \alpha_A^c$. We can thus write $\alpha_A^c = \alpha_{a_A^c}$.

Proof. ¹⁸⁹ By T 1.1.2 $\alpha_{a_B} = \bar{\chi}$. By the same theorem we have $\chi \cap \alpha = \emptyset$, for otherwise $\exists E E \in \chi \cap \alpha$ together with $a \subset \alpha_{a_B} \cap \alpha$ would imply $\alpha_{a_B} \cap \alpha$, whence $B \in \alpha$, which contradicts $B \in \alpha_A$. Therefore, using the preceding lemma gives $B \in \chi \cap \alpha_A \& \chi \cap \alpha = \emptyset \xrightarrow{L1.2.53.11} \chi \subset \alpha_A$. Choosing points C, D such that $C \in a = \alpha \cap \alpha_{a_B}$ and $[BCD]$ (see A 1.1.3, A 1.2.2), we have by L 1.2.19.1, L 1.2.53.1 $\exists D D \in \chi^c \cap \alpha_A^c$. Then the first part of the present proof gives $\chi^c \subset \alpha_A^c$, which completes the proof. \square

¹⁸⁹The reader can refer to Fig. 1.81, making necessary corrections in notation.

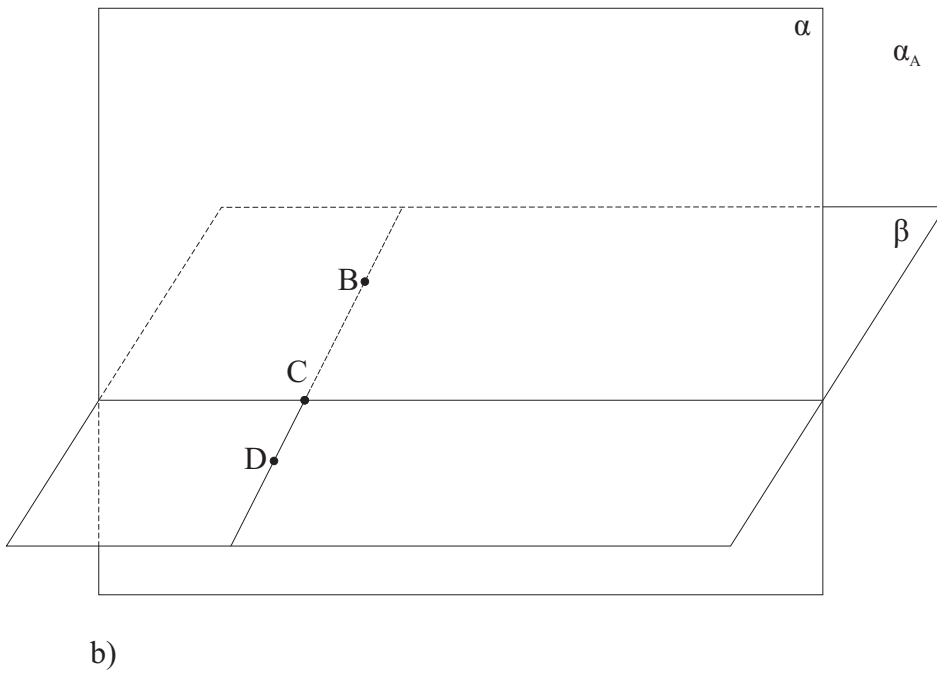
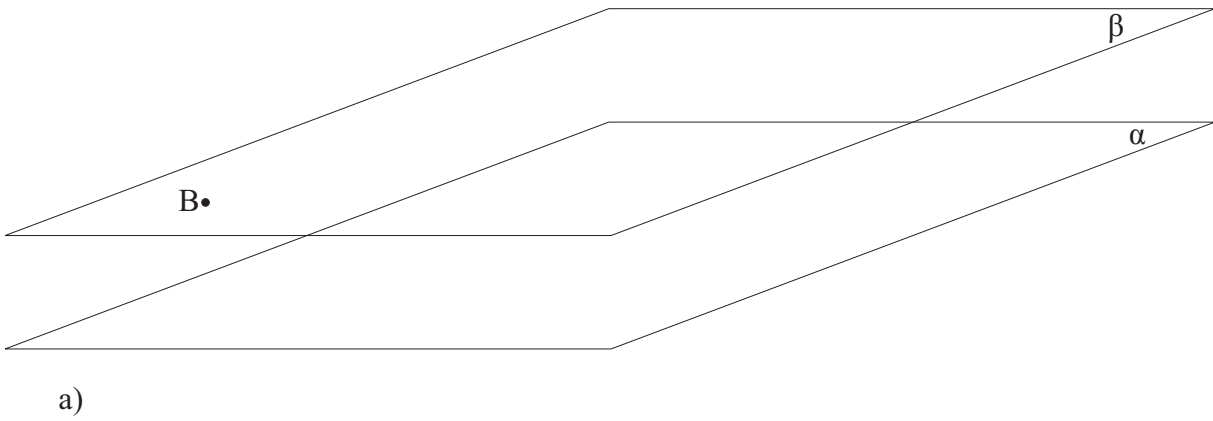

Figure 1.81: If a plane β , parallel to a plane α , has at least one point in a half-space α_A , it lies completely in α_A .

Theorem 1.2.53. Given a plane α , let \mathcal{A} be either

- A set $\{B_1\}$, consisting of one single point B_1 lying in a half - space α_A ; or
 - A line b_1 , parallel to α and having a point B_1 in α_A ; or
 - A ray $(O_1)_{B_1}$, not meeting the plane α , such that the initial point O or one of its points, D_1 , lies in α_A ; or
 - An open interval (D_1B_1) , not meeting the plane α , such that one of its ends lies in α_A , or one of its points, G_1 , lies in α_A ; or
 - A ray $(O_1)_{B_1}$ with its initial point O_1 on α and one of its points, C_1 , in α_A ; or
 - An interval - like set with both its ends D_1, B_1 in α_A , or with one end in α_A and the other on α ;
 - A plane β_1 , parallel to α and having a point B_1 in α_A ;
 - A half-plane χ_1 having no common points with α and one of its points, B_1 , in a half-space α_A ;
 - A half-plane χ_1 , having its edge a_1 on α and one of its points, B_1 , in a half-space α_A ;
- and let \mathcal{B} be either
- A line b_2 , parallel to α and having a point B_2 in α_A ; or
 - A ray $(O_2)_{B_2}$, not meeting the plane α , such that the initial point O or one of its points, D_2 , lies in α_A ; or
 - An open interval (D_2B_2) , not meeting the plane α , such that one of its ends lies in α_A , or one of its points, G_2 , lies in α_A ; or
 - A ray $(O_2)_{B_2}$ with its initial point O_2 on α and one of its points, C_2 , in α_A ; or
 - An interval - like set with both its ends D_2, B_2 in α_A , or with one end in α_A and the other on α ;
 - A plane β_2 , parallel to α and having a point B_2 in α_A ;
 - A half-plane χ_2 having no common points with α and one of its points, B_2 , in α_A ;
 - A half-plane χ_2 , having its edge a_2 on α and one of its points, B_2 , in α_A .
- Then the sets \mathcal{A} and \mathcal{B} lie in plane on one side of the plane α .

Proof. \square

Theorem 1.2.54. Given a plane α , let \mathcal{A} be either

- A set $\{B_1\}$, consisting of one single point B_1 lying in a half - space α_A ; or
 - A line b_1 , parallel to α and having a point B_1 in α_A ; or
 - A ray $(O_1)_{B_1}$, not meeting the plane α , such that the initial point O or one of its points, D_1 , lies in α_A ; or
 - An open interval (D_1B_1) , not meeting the plane α , such that one of its ends lies in α_A , or one of its points, G_1 , lies in α_A ; or
 - A ray $(O_1)_{B_1}$ with its initial point O_1 on α and one of its points, C_1 , in α_A ; or
 - An interval - like set with both its ends D_1, B_1 in α_A , or with one end in α_A and the other on α ;
 - A plane β_1 , parallel to α and having a point B_1 in α_A ;
 - A half-plane χ_1 having no common points with α and one of its points, B_1 , in a half-space α_A ;
 - A half-plane χ_1 , having its edge a_1 on α and one of its points, B_1 , in a half-space α_A ;
- and let \mathcal{B} be either
- A line b_2 , parallel to α and having a point B_2 in α_A^c ; or
 - A ray $(O_2)_{B_2}$, not meeting the plane α , such that the initial point O or one of its points, D_2 , lies in α_A^c ; or
 - An open interval (D_2B_2) , not meeting the plane α , such that one of its ends lies in α_A^c , or one of its points, G_2 , lies in α_A^c ; or
 - A ray $(O_2)_{B_2}$ with its initial point O_2 on α and one of its points, C_2 , in α_A^c ; or
 - An interval - like set with both its ends D_2, B_2 in α_A^c , or with one end in α_A^c and the other on α ;
 - A plane β_2 , parallel to α and having a point B_2 in α_A^c ;
 - A half-plane χ_2 having no common points with α and one of its points, B_2 , in α_A^c ;
 - A half-plane χ_2 , having its edge a_2 on α and one of its points, B_2 , in α_A^c .
- Then the sets \mathcal{A} and \mathcal{B} lie in plane on opposite sides of the plane α .

Proof. \square

Basic Properties of Dihedral Angles

A pair of distinct non-complementary half-planes $\chi = a_A, \kappa = a_B, \chi \neq \kappa$, with a common edge a is called a dihedral angle $(\widehat{\chi\kappa})_a$,¹⁹⁰ which can also be written as \widehat{AaB} . The following trivial lemma shows that the latter notation is well defined:

Lemma 1.2.55.1. *If points C, D lie, respectively, on the sides $\chi = a_A, \kappa = a_B$ of the dihedral angle $\widehat{\chi\kappa}$ then $\widehat{CaD} = \widehat{\chi\kappa}$.*

Proof. (See Fig. 1.82.) Follows immediately from L 1.2.17.6. \square

In a dihedral angle $\widehat{AaB} = \{a_A, a_B\}$ the half-planes a_A, a_B will be called the sides, and the line a (the common edge of the half-planes a_A, a_B) the edge, of the dihedral angle \widehat{AaB} .

¹⁹⁰In practice we shall usually omit the subscript as being either obvious from context or irrelevant.

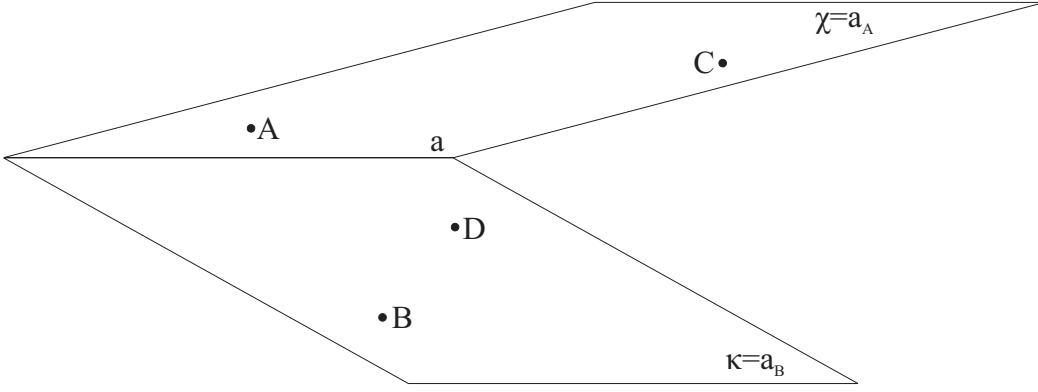

Figure 1.82: If points C, D lie, respectively, on the sides $\chi = a_A, \kappa = a_B$ of the dihedral angle $\widehat{\chi\kappa}$ then $\widehat{CaD} = \widehat{\chi\kappa}$.

Lemma 1.2.55.2. 1. Given a dihedral angle \widehat{AaB} , we have $B \notin \alpha_{aA}, A \notin \alpha_{aB}$, and the line a cannot be coplanar with both points A, B simultaneously.¹⁹¹ The lines a, a_{AB} are then skew lines.

2. If any of the following conditions:

i): $B \notin \alpha_{aA}$;

ii): $A \notin \alpha_{aB}$;

iii): a, a_{AB} are skew lines;

are met, then the other conditions are also met, and the dihedral angle \widehat{AaB} exists.¹⁹²

Proof. 1. Otherwise, we would have $B \in \alpha_{aA} \& B \notin a \Rightarrow a_B = a_A \vee a_B = a_A^c$ (see L 1.2.17.6, L 1.2.19.1), contrary to hypothesis that a_A, a_B form a dihedral angle. We conclude that $B \notin \alpha_{aA}$, whence $\neg \exists \alpha (A \in \alpha \& a \subset \alpha \& B \in \alpha)$ and $A \notin \alpha_{aB}$.

2. We have $B \notin \alpha_{aA} \Rightarrow B \notin a_A \& B \notin a_A^c$, for $B \in a_A \vee B \in a_A^c \Rightarrow B \in \alpha_{aA}$. Hence $a_B \neq a_A$ and $a_B \neq a_A^c$, so \widehat{AaB} exists.

To show that i) implies iii), suppose the contrary, i.e. that $B \in \alpha_{aA}$. Then by A 1.1.6 we have $a_{AB} \subset \alpha_{aA}$, whence we conclude that the lines a, a_{AB} lie in one plane, which is, by definition, not possible for skew lines. \square

The set of points, or contour, of the dihedral angle $(\widehat{\chi\kappa})_a$ is, by definition, the set $\mathcal{P}_{(\widehat{\chi\kappa})} = \chi \cup \mathcal{P}_a \cup \kappa$. We say that a point lies on a dihedral angle if it lies on one of its sides or coincides with its edge. In other words, C lies on $\widehat{\chi, \kappa}$ if it lies on its contour, that is, belongs to the set of its points: $C \in \mathcal{P}_{(\widehat{\chi\kappa})}$.

We say that a point X lies *inside* a dihedral angle $\widehat{\chi\kappa}$ if it lies on the same side of the plane $\bar{\chi}$ as any of the points of the half-plane κ , and on the same side of the plane $\bar{\kappa}$ as any of the points of the half-plane χ .¹⁹³

The set of all points lying inside a dihedral angle $\widehat{\chi\kappa}$ will be referred to as its *interior* $Int(\widehat{\chi\kappa}) = \{X | X\chi\bar{\kappa} \& X\kappa\bar{\chi}\}$. We can also write $Int\widehat{AaB} = (\alpha_{aA})_B \cap (\alpha_{aB})_A$.

If a point X lies in space neither inside nor on a dihedral angle $\widehat{\chi\kappa}$, we shall say that X lies *outside* the dihedral angle $\widehat{\chi\kappa}$.

The set of all points lying outside a given dihedral angle $\widehat{\chi\kappa}$ will be referred to as the *exterior* of the dihedral angle $\widehat{\chi\kappa}$, written $Ext(\widehat{\chi\kappa})$. We thus have, by definition, $Ext(\widehat{\chi\kappa}) = \mathcal{C}^{Pt} \setminus (\mathcal{P}_{(\widehat{\chi\kappa})} \cup Int(\widehat{\chi\kappa}))$.

Lemma 1.2.55.3. If a point C lies inside a dihedral angle \widehat{AaB} , the half-plane a_C lies completely inside \widehat{AaB} : $a_C \subset Int\widehat{AOB}$.

From L 1.2.17.6 it follows that this lemma can also be formulated as:

If one of the points of a half-plane a_C lies inside a dihedral angle \widehat{AaB} , the whole half-plane a_C lies inside the dihedral angle \widehat{AaB} .

Proof. (See Fig. 1.83.) Immediately follows from T 1.2.53. Indeed, by hypothesis, $C \in Int\widehat{AaB} = (\alpha_{aA})_B \cap (\alpha_{aB})_A$. Since also $a = \bar{\chi} \cap \bar{\kappa}$, by T 1.2.53 $\alpha_C \subset Int\widehat{AaB} = (\alpha_{aA})_B \cap (\alpha_{aB})_A$. \square

Lemma 1.2.55.4. If a point C lies outside a dihedral angle \widehat{AaB} , the half-plane a_C lies completely outside \widehat{AaB} : $a_C \subset Ext(\widehat{AaB})$.¹⁹⁴

¹⁹¹Thus, the dihedral angle \widehat{AaB} exists if and only if A, a, B do not coplane. With the aid of T 1.1.2, L 1.1.2.6 we can see that there exists at least one dihedral angle.

¹⁹²In other words, the present lemma states that the conditions (taken separately) i), ii), iii), and the condition of the existence of the dihedral angle \widehat{AaB} are equivalent to one another.

¹⁹³Theorem T 1.2.53 makes this notion well defined in its "any of the points" part.

¹⁹⁴In full analogy with the case of L 1.2.55.3, from L 1.2.17.6 it follows that this lemma can be reformulated as: If one of the points of a half-plane a_C lies outside a dihedral angle \widehat{AaB} , the whole half-plane a_C lies outside the dihedral angle \widehat{AaB} .

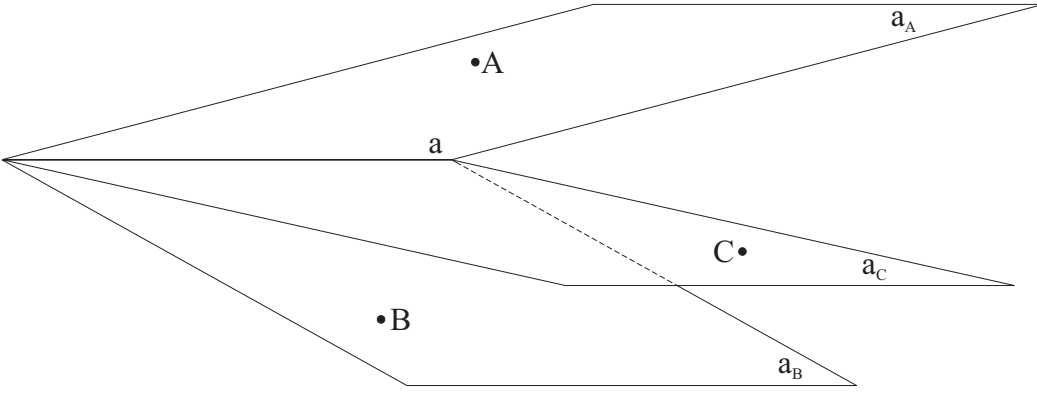

Figure 1.83: If C lies inside a dihedral angle \widehat{AaB} , the half-plane a_C lies completely inside \widehat{AaB} : $a_C \subset \text{Int}\widehat{AaB}$.

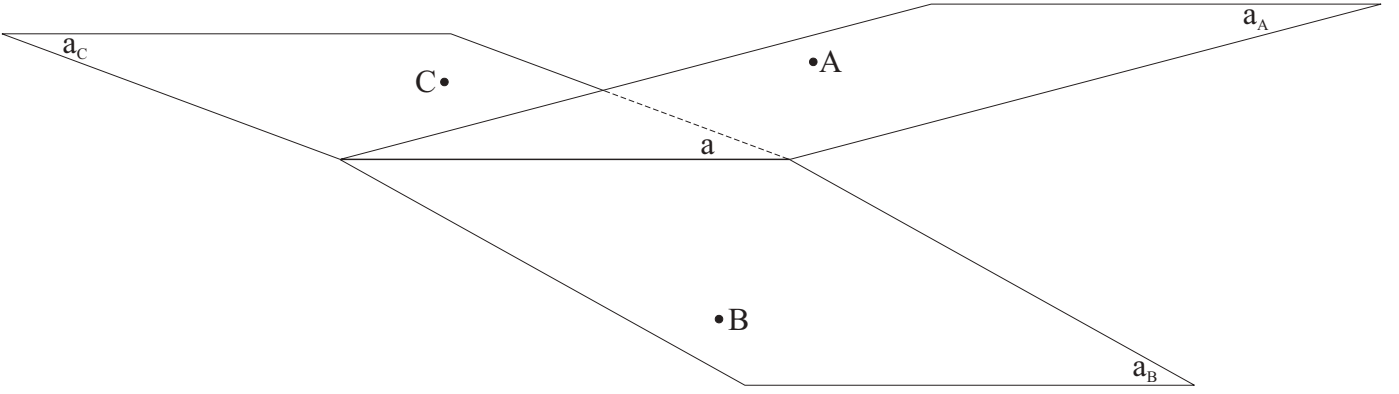

Figure 1.84: If a point C lies outside a dihedral angle \widehat{AaB} , the half-plane a_C lies completely outside \widehat{AaB} : $a_C \subset \text{Ext}(\widehat{AaB})$.

Proof. (See Fig. 1.84.) $a_C \cap \mathcal{P}_{(\widehat{AaB})} = \emptyset$, because $C \notin a$ and $a_C \cap a_A \neq \emptyset \vee a_C \cap a_B \neq \emptyset \xrightarrow{\text{L1.2.17.7}} a_C = a_A \vee a_C = a_B \Rightarrow C \in a_A \vee C \in a_B$ - a contradiction. $a_C \cap \text{Int}(\widehat{AaB}) = \emptyset$, because if $D \in a_C \cap \text{Int}(\widehat{AaB})$, we would have $a_D = a_C$ from L 1.2.17.6 and $a_D \subset \text{Int}(\widehat{AaB})$, whence $C \in \text{Int}(\widehat{AaB})$ - a contradiction. Finally, $a_C \subset \mathcal{C}^{Pt}$ & $a_C \cap \mathcal{P}_{(\widehat{AaB})} = \emptyset$ & $a_C \cap \text{Int}(\widehat{AaB}) = \emptyset \Rightarrow a_C \subset \text{Ext}\angle AaB$. \square

Lemma 1.2.55.5. *Given a dihedral angle \widehat{AaB} , if a point C lies either inside \widehat{AaB} or on its side a_A , and a point D either inside \widehat{AaB} or on its other side a_B , the open interval (CD) lies completely inside \widehat{AaB} , that is, $(CD) \subset \text{Int}(\widehat{AaB})$.*

Proof. $C \in \text{Int}(\widehat{AaB}) \cup a_A$ & $D \in \text{Int}(\widehat{AaB}) \cup a_B \Rightarrow C \in ((\alpha_{aA})_B \cap (\alpha_{aB})_A) \cup a_A$ & $D \in ((\alpha_{aA})_B \cap (\alpha_{aB})_A) \cup a_B \Rightarrow C \in ((\alpha_{aA})_B \cup a_A) \cap ((\alpha_{aB})_A \cup a_A)$ & $D \in ((\alpha_{aA})_B \cup a_B) \cap ((\alpha_{aB})_A \cup a_B)$. Since, by L 1.2.53.12, $a_A \subset (\alpha_{aB})_A$ and $a_B \subset (\alpha_{aA})_B$, we have $(\alpha_{aB})_A \cup a_A = (\alpha_{aB})_A$, $(\alpha_{aA})_B \cup a_B = (\alpha_{aA})_B$, and, consequently, $C \in (\alpha_{aA})_B \cup a_A$ & $C \in (\alpha_{aB})_A$ & $D \in (\alpha_{aA})_B$ & $D \in (\alpha_{aB})_A \cup a_B \xrightarrow{\text{L1.2.53.9}} (CD) \subset (\alpha_{aA})_B$ & $(CD) \subset (\alpha_{aB})_A \Rightarrow a_C \subset \text{Int}(\widehat{AaB})$. \square

The lemma L 1.2.55.5 implies that the interior of a dihedral angle is a convex point set.

Lemma 1.2.55.6. *If a point C lies inside a dihedral angle $(\widehat{\chi\kappa})_a$ (with the edge a), the half-plane a_C^c , complementary to the half-plane a_C , lies inside the vertical dihedral angle $\widehat{\chi^c\kappa^c}$.*

Proof. (See Fig. 1.86.) $C \in \text{Int}((\widehat{\chi\kappa})) \Rightarrow C \in \bar{\chi}_\kappa \cap \bar{\kappa}_\chi \xrightarrow{\text{L1.2.53.12}} a_C^c \subset \bar{\chi}_\kappa^c \cap \bar{\kappa}_\chi^c \Rightarrow a_C^c \subset \bar{\chi}_{\kappa^c} \cap \bar{\kappa}_{\chi^c} \Rightarrow a_C^c \subset \text{Int}\angle((\widehat{\chi^c\kappa^c}))$. \square

Lemma 1.2.55.7. *Given a dihedral angle $\widehat{\chi\kappa}$, all points lying either inside or on the sides χ^c, κ^c of the dihedral angle opposite to it, lie outside $\widehat{\chi\kappa}$.¹⁹⁵*

Proof. \square

¹⁹⁵Obviously, this means that none of the interior points of $\widehat{\chi^c\kappa^c}$ can lie inside $\widehat{\chi\kappa}$.

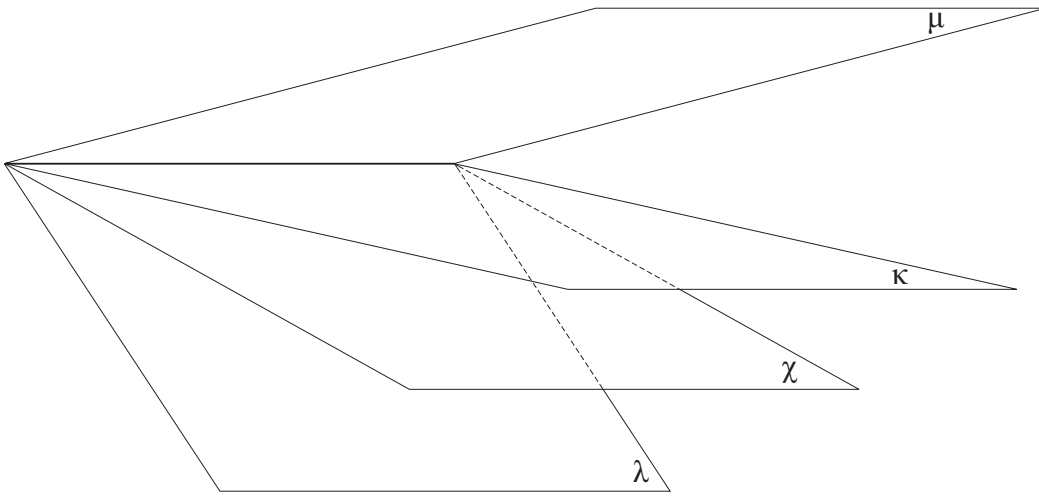

Figure 1.85: Dihedral angles $\widehat{\lambda\chi}$ and $\widehat{\kappa\mu}$ are adjacent to the dihedral angle $\widehat{\chi\kappa}$. Note that χ, μ lie on opposite sides of $\bar{\kappa}$ and λ, κ lie on opposite sides of $\bar{\chi}$.

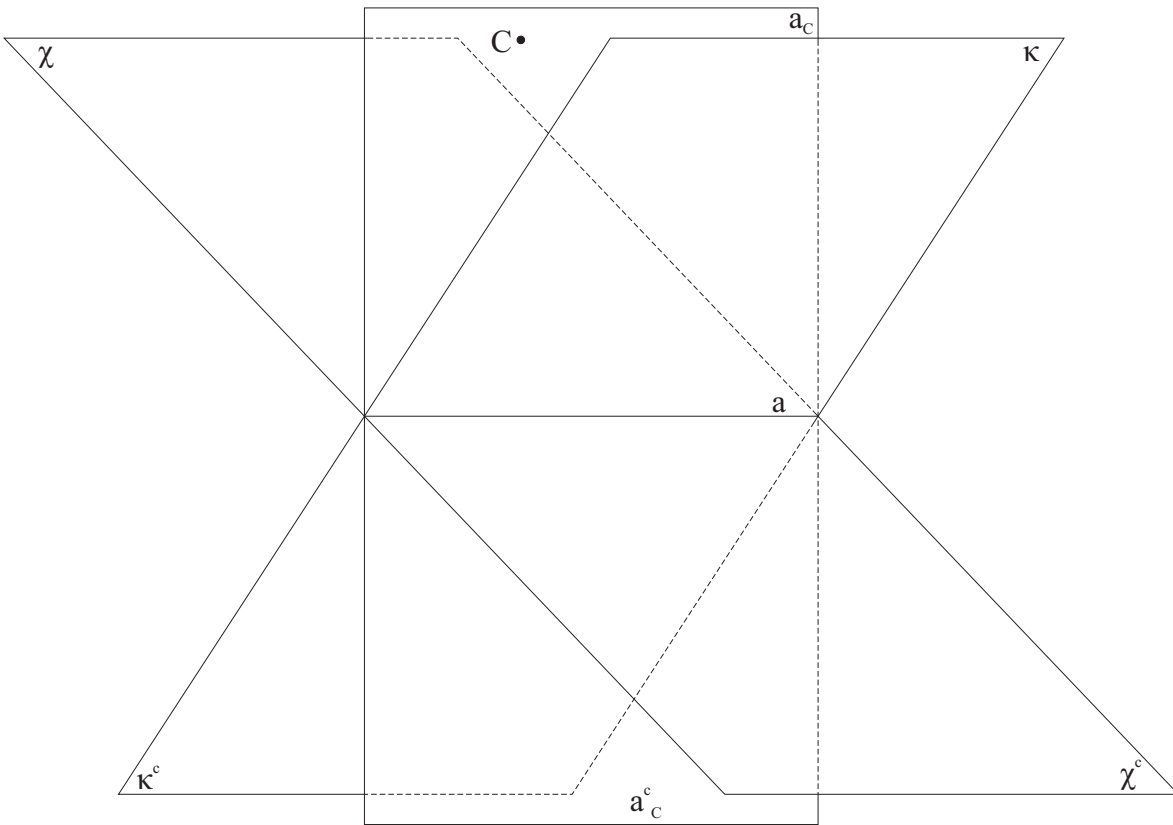

Figure 1.86: If C lies inside a dihedral angle $(\widehat{\chi\kappa})_a$, the half-plane a_c^c lies inside $\widehat{\chi^c\kappa^c}$.

Lemma 1.2.55.8. 1. If a plane α and the edge a of a dihedral angle $\widehat{\chi\kappa}$ concur at a point O , the rays h, k that are the sections by the plane α of the half-planes χ, κ , respectively, form an angle $\angle(h, k)$ with the vertex O .

The angle $\angle(h, k)$, formed by the sections of the sides χ, κ of a dihedral angle $\widehat{\chi\kappa}$ by a plane α , will be referred to as the section of the dihedral angle $\widehat{\chi\kappa}$ by the plane α .¹⁹⁶

2. Conversely, if an angle $\angle(h, k)$ is the section of a dihedral angle $\widehat{\chi\kappa}$ by a plane α , the edge a of $\widehat{\chi\kappa}$ concurs with the plane α at the vertex O of the angle $\angle(h, k)$.¹⁹⁷

Proof. 1. We have $k \neq h^c$, for otherwise the half-planes χ^c, κ , in addition to having a common edge (a), would by L 1.2.19.8 have a common point, for which we can then take any point lying on $h^c = k$. This would, by L 1.2.17.7, imply $\chi^c = \kappa$, in contradiction with the definition of dihedral angle. Thus, the two distinct rays h, k form an angle $\angle(h, k)$ with the vertex O , q.e.d.

2. Follows immediately from L 1.2.19.13, part 2. \square

A dihedral angle is said to be adjacent to another dihedral angle if it shares a side and the edge with that dihedral angle, and the remaining sides of the two dihedral angles lie on opposite sides of the line containing their common side. This relation being obviously symmetric, we can also say the two dihedral angles are adjacent to each other. We shall denote any dihedral angle, adjacent to a given dihedral angle $\widehat{\chi\kappa}$, by $\widehat{adj\chi\kappa}$. Thus, we have, by definition, $\widehat{\kappa\mu} = \widehat{adj\chi\kappa}$ ¹⁹⁸ and $\widehat{\lambda\chi} = \widehat{adj\chi\kappa}$ if $\chi\kappa\mu$ and $\lambda\chi\kappa$, respectively. (See Fig. 1.85.)

Corollary 1.2.55.9. If a point B lies inside a dihedral angle \widehat{AaC} , the dihedral angles $\widehat{AaB}, \widehat{BaC}$ are adjacent.

Proof. $B \in \text{Int}\widehat{AaC} \xrightarrow{\text{L1.2.55.18}} \exists D \in a_B \& [ADC]$. Since $D \in \alpha_{aB} \cap (AC)$, $A \notin \alpha_{aB}$, we see that the points A, C , and thus the half-planes a_A, a_C (see T 1.2.54) lie on opposite sides of the plane α_{aB} . Together with the fact that the dihedral angles $\widehat{AaB}, \widehat{BaC}$ share the side a_B this means that $\widehat{AaB}, \widehat{BaC}$ are adjacent. \square

From the definition of adjacency of dihedral angles, taken together with the definition of the interior and exterior of a dihedral angle, immediately follows

Lemma 1.2.55.10. In a dihedral angle $\widehat{\kappa\mu}$, adjacent to a dihedral angle $\widehat{\chi\kappa}$, the side μ lies outside $\widehat{\chi\kappa}$.

which, together with C 1.2.55.9, implies the following corollary

Corollary 1.2.55.11. If a point B lies inside a dihedral angle \widehat{AaC} , neither the half-plane a_C has any points inside or on the dihedral angle \widehat{AaB} , nor the half-plane a_A has any points inside or on \widehat{BaC} .

Lemma 1.2.55.12. If dihedral angles $\widehat{\chi\kappa}, \widehat{\kappa\mu}$ share the side κ , and points $A \in \chi, B \in \mu$ lie on opposite sides of the plane $\bar{\kappa}$, the dihedral angles $\widehat{\chi\kappa}, \widehat{\kappa\mu}$ are adjacent to each other.

Proof. Immediately follows from L 1.2.19.12. \square

A dihedral angle $\widehat{\kappa\lambda}$ is said to be adjacent supplementary to a dihedral angle $\widehat{\chi\kappa}$, written $\widehat{\kappa\lambda} = \widehat{adjsp\chi\kappa}$, iff the half-plane λ is complementary to the half-plane χ . That is, $\widehat{\kappa\lambda} = \widehat{adjsp\chi\kappa} \stackrel{\text{def}}{\iff} \lambda = \chi^c$. Since, by L 1.2.19.2, the half-plane $(\chi^c)^c$, complementary to the half-plane χ^c , complementary to the given half-plane χ , coincides with the half-plane χ : $(\chi^c)^c = \chi$, if $\widehat{\kappa\lambda}$ is adjacent supplementary to $\widehat{\chi\kappa}$, the dihedral angle $\widehat{\chi\kappa}$ is, in its turn, adjacent supplementary to the dihedral angle $\widehat{\kappa\lambda}$.

Lemma 1.2.55.13. Given a dihedral angle $\widehat{\chi\kappa}$, all points lying inside any dihedral angle $\widehat{\kappa\mu}$ adjacent to it, lie outside $\widehat{\chi\kappa}$.¹⁹⁹

Proof. (See Fig. 1.87.) By definition of the interior, $A \in \text{Int}(\widehat{\chi\kappa}) \Rightarrow A\mu\bar{\kappa}$. By the definition of adjacency $\widehat{\kappa\mu} = \widehat{adj\chi\kappa} \Rightarrow \chi\bar{\kappa}\mu$. $A\mu\bar{\kappa} \& \chi\bar{\kappa}\mu \xrightarrow{\text{L1.2.52.5}} A\bar{\kappa}\chi \Rightarrow A \in \text{Ext}\widehat{\chi\kappa}$. \square

Corollary 1.2.55.14. If $\angle(h, k)$ is the section of a dihedral angle $\text{Int}(\widehat{\chi\kappa})$ by a plane α , then the adjacent supplementary angles $\angle(h^c, k), \angle(h, k^c)$ are the sections of the corresponding adjacent supplementary dihedral angles $\widehat{\chi^c\kappa}, \widehat{\chi\kappa^c}$, respectively, and the vertical angle $\angle(h^c, k^c)$ is the section of the vertical dihedral angle $\widehat{\chi^c\kappa^c}$.

Proof. See C 1.2.19.14. \square

Lemma 1.2.55.15. If a point C lies inside a section of a dihedral angle $\widehat{\chi\kappa}$ by a plane $\alpha \ni C$, it lies inside the dihedral angle itself: $C \in \widehat{\chi\kappa}$.

¹⁹⁶Obviously, for any such section $\angle(h, k)$ of a dihedral angle $\widehat{\chi\kappa}$, we have $h \subset \chi, k \subset \kappa$.

¹⁹⁷Compare this lemma with L 1.2.19.13 and the definition accompanying it.

¹⁹⁸Of course, by writing $\bar{\kappa}\mu = \widehat{adj\chi\kappa}$ we do not imply that $\bar{\kappa}\mu$ is the only dihedral angle adjacent to $\widehat{\chi\kappa}$. It can be easily seen that in reality there are infinitely many such dihedral angles. The situation here is analogous to the usage of the symbols o and O in calculus (used particularly in the theory of asymptotic expansions).

¹⁹⁹Obviously, this means that given a dihedral angle $\widehat{\chi\kappa}$, none of the interior points of a dihedral angle $\widehat{\kappa\mu}$ adjacent to it, lie inside $\widehat{\chi\kappa}$.

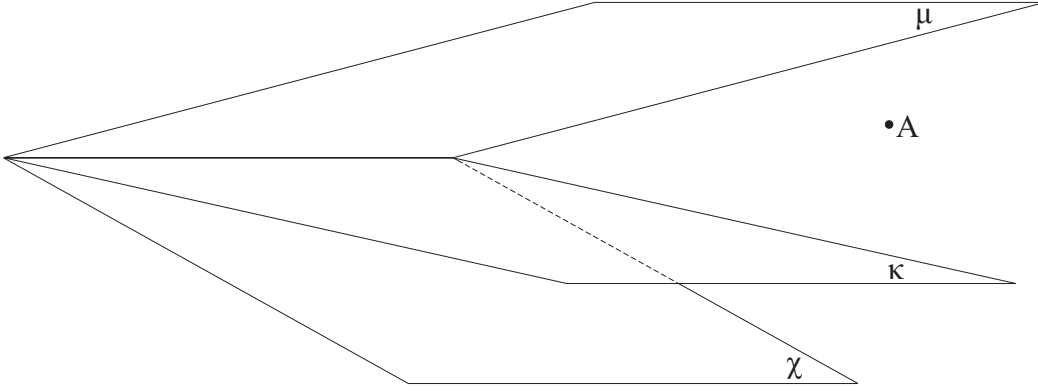

Figure 1.87: Given a dihedral angle $\widehat{\chi\kappa}$, all points lying inside any dihedral angle $\widehat{\kappa\mu}$ adjacent to it, lie outside $\widehat{\chi\kappa}$.

Proof. Taking points D, F on the sides h, k , respectively, of a section $\angle(h, k)$, we have $C \in \text{Int}\angle(h, k) \stackrel{\text{L1.2.21.10}}{\implies} \exists E [DEF] \& E \in O_C$. $D \in h \& h \subset \chi \Rightarrow D \in \chi$, $F \in k \& k \subset \kappa \Rightarrow F \in \kappa$, whence $D \in \chi \& F \in \kappa \& E \in (DF) \stackrel{\text{L1.2.55.5}}{\implies} E \in \text{Int}(\widehat{\chi\kappa})$. Using L 1.2.53.8, L 1.2.55.3 we can write $O_C \subset a_c \subset \text{Int}(\widehat{\chi\kappa})$, whence $C \in \text{Int}(\widehat{\chi\kappa})$, q.e.d. \square

Thus, for an arbitrary section $\angle(h, k)$ of a dihedral angle $\widehat{\chi\kappa}$ we can write $\text{Int}\angle(h, k) \subset \text{Int}(\widehat{\chi\kappa})$. Furthermore, applying the same argument to the adjacent supplementary and vertical angles, we can also write $\text{Int}\angle(h^c, k) \subset \text{Int}(\widehat{\chi^c\kappa})$, $\text{Int}\angle(h, k^c) \subset \text{Int}(\widehat{\chi\kappa^c})$, $\text{Int}\angle(h^c, k^c) \subset \text{Int}(\widehat{\chi^c\kappa^c})$

Lemma 1.2.55.16. *A point C lying inside a dihedral angle $\widehat{\chi\kappa}$ also lies inside all sections of $\widehat{\chi\kappa}$ by planes $\alpha \ni C$.*
200

Proof. Let $\angle(h, k)$ be the section of $\widehat{\chi\kappa}$ by a plane $\alpha \ni C$. $C \in \alpha = \alpha_{\angle(h, k)} \& C \notin \bar{h} \& C \notin \bar{k} \stackrel{\text{L1.2.21.10}}{\implies} C \in \text{Int}\angle(h, k) \vee C \in \text{Int}\angle(h^c, k) \vee C \in \text{Int}\angle(h, k^c) \vee C \in \text{Int}\angle(h^c, k^c)$. But the two preceding results (C 1.2.55.14, L 1.2.55.15) imply that $C \in \text{Int}\angle(h^c, k) \Rightarrow C \in \text{Int}(\widehat{\chi^c\kappa})$, $C \in \text{Int}\angle(h, k^c) \Rightarrow C \in \text{Int}(\widehat{\chi\kappa^c})$, $C \in \text{Int}\angle(h^c, k^c) \Rightarrow C \in \text{Int}(\widehat{\chi^c\kappa^c})$. In view of L 1.2.55.13, L 1.2.55.7, the variants $C \in \text{Int}(\widehat{\chi^c\kappa})$, $C \in \text{Int}(\widehat{\chi\kappa^c})$, $C \in \text{Int}(\widehat{\chi^c\kappa^c})$ all contradict the hypothesis $C \in \text{Int}(\widehat{\chi\kappa})$. This contradiction shows that, in fact, $C \in \text{Int}\angle(h, k)$ is the only possible option, q.e.d. \square

Lemma 1.2.55.17. *Suppose points D, F lie, respectively, on the sides χ, κ , and a point O lies on the edge a of a dihedral angle $\widehat{\chi\kappa}$. Then:*

1. *The points D, O, F are not collinear;*
2. *The plane α_{DOF} concurs with the line a at O ;*
3. *The angle $\angle DOF$ is the section of the dihedral angle $\widehat{\chi\kappa}$ by the plane α_{DOF} .*

Proof. (See Fig. 1.88.) 1. We have $D \in \chi \& F \in \kappa \stackrel{\text{L1.2.55.1}}{\implies} \widehat{DaF} = \widehat{\chi\kappa}$. $O \in a \subset \bar{\chi} = \alpha_a D \& D \in \bar{\chi} \stackrel{\text{A1.1.6}}{\implies} a_{OD} \subset \bar{\chi}$. Hence $F \notin a_{OD}$, for otherwise $F \in a_{OD} \subset \bar{\chi} \Rightarrow F \in \bar{\chi}$, which contradicts L 1.2.55.2. Thus, the points D, O, F are not collinear.

2. If $P \in a \cap \alpha_{DOF}$,²⁰¹ $P \neq O$, then we would have $O \in a \cap \alpha_{DOF} \& P \in a \cap \alpha_{DOF} \stackrel{\text{A1.1.6}}{\implies} a \subset \angle DOF \stackrel{\text{T1.1.2}}{\implies} \alpha_{aD} = \alpha_{DOF}$, whence $F \in \alpha_{aD}$ - a contradiction with L 1.2.55.2.

3. Follows from 2. and L 1.2.55.8. \square

Lemma 1.2.55.18. *Given a dihedral angle $\widehat{\chi\kappa}_a$ (with the line a as its edge) and a point C inside it, for any points D on χ and F on κ , the half-plane a_C meets the open interval (DF) .*

Proof. (See Fig. 1.89.) Take a point $O \in a$. Since, by the preceding lemma (L 1.2.55.17, 2.), the line a and the plane α_{DOF} concur at O , by L 1.2.19.13 the plane α_{DOF} and the half-plane a_A have a common ray l whose initial point is O . We have $C \in \text{Int}(\widehat{\chi\kappa})_\kappa \stackrel{\text{L1.2.55.3}}{\implies} a_C \subset \text{Int}(\widehat{\chi\kappa}) \Rightarrow l \subset \text{Int}(\widehat{\chi\kappa})$. Observe also that, from the preceding lemma (L 1.2.55.17, 3.), the angle $\angle DOF$ is the section of $\widehat{\chi\kappa}$ by α_{DOF} . Hence, taking an arbitrary point $P \in l$, we conclude from L 1.2.55.16 that $P \in \text{Int}\angle DOF$, i.e. $l \subset \text{Int}\angle DOF$. Finally, $D \in O_D \& F \in O_F \& l \subset \text{Int}\angle DOF \stackrel{\text{L1.2.21.10}}{\implies} \exists E E \in l \& [DEF]$. Thus, $E \in a_C \cap (DF)$, as required. \square

Lemma 1.2.55.19. *Given a dihedral angle $\widehat{\chi\kappa}$, any point lying on the same side of the plane $\bar{\chi}$ as the half-plane κ , lies either inside the dihedral angle $\widehat{\chi\kappa}$, or inside the dihedral angle $\widehat{\kappa\chi^c}$, or on the half-plane κ (See Fig. 1.91). That is, $\bar{\chi}_\kappa = \text{Int}(\widehat{\chi\kappa}) \cup \kappa \cup \text{Int}(\widehat{\kappa\chi^c})$.*

²⁰⁰By L 1.2.55.8, when drawing a plane α through a point $C \in \text{Int}(\widehat{\chi\kappa})$, we obtain a section of $\widehat{\chi\kappa}$ by α iff the plane α and the edge a of the dihedral angle $\widehat{\chi\kappa}$ concur at a point O .

²⁰¹The existence of α_{DOF} follows from 1. (in the present lemma) and the axiom A 1.1.4.

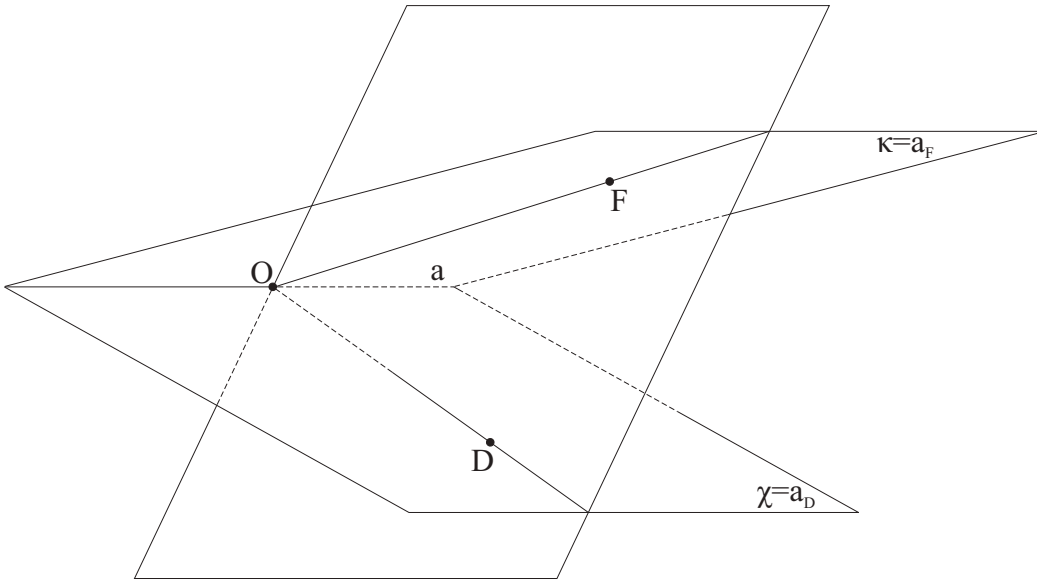

Figure 1.88: Suppose points D, F lie, respectively, on the sides χ, κ , and a point O lies on the edge a of a dihedral angle $\widehat{\chi\kappa}$. Then: 1. The points D, O, F are not collinear; 2. The plane α_{DOF} concurs with the line a at O ; 3. The angle $\angle DOF$ is the section of the dihedral angle $\widehat{\chi\kappa}$ by the plane α_{DOF} .

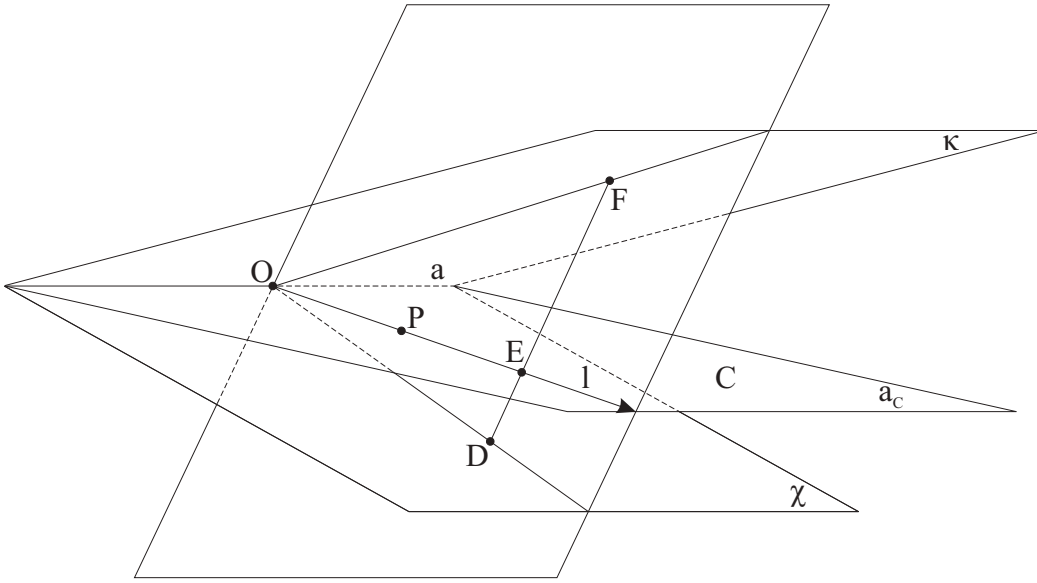

Figure 1.89: Given a dihedral angle $\widehat{\chi\kappa}_a$ and a point C inside it, for any points D on χ and F on κ , the half-plane a_C meets the open interval (DF) .

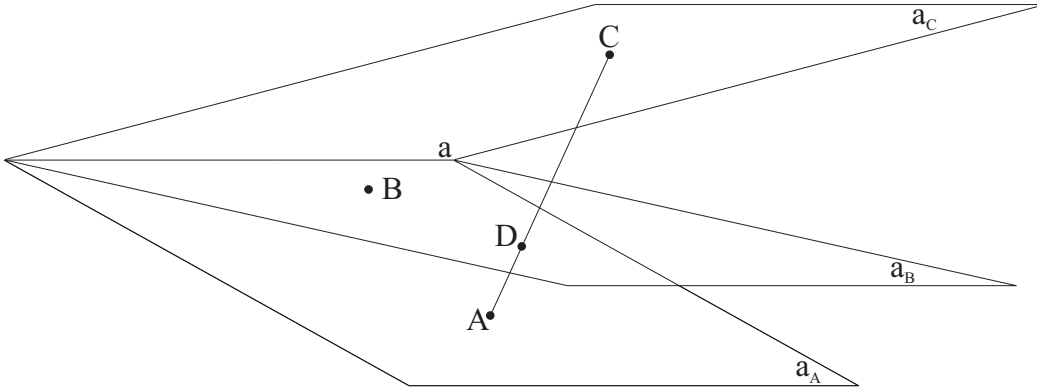

Figure 1.90: If a point B lies inside an angle $\angle AOC$, the angles $\angle AOB, \angle BOC$ are adjacent.

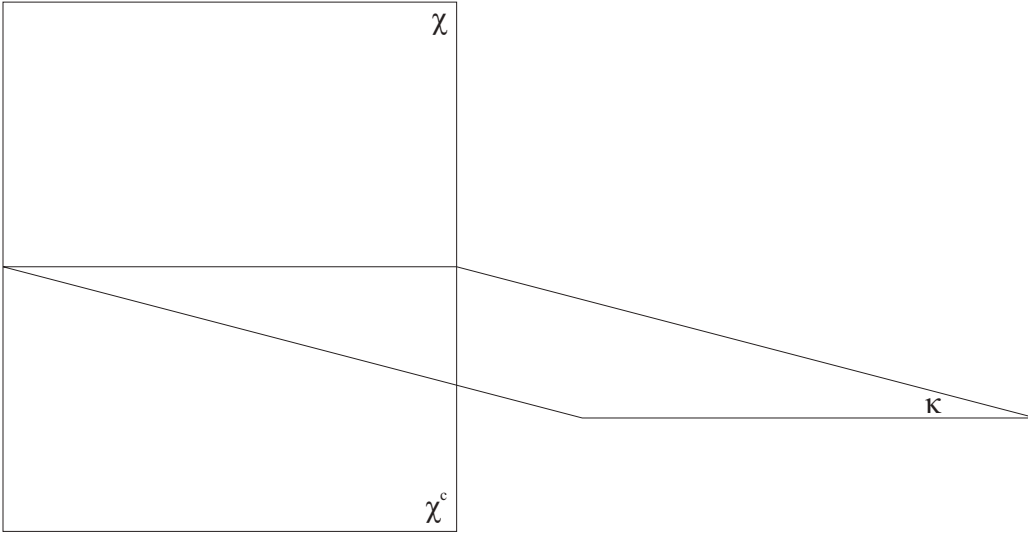

Figure 1.91: Given a dihedral angle $\widehat{\chi\kappa}$, any point lying on the same side of $\bar{\chi}$ as κ , lies either inside $\widehat{\chi\kappa}$, or inside $\widehat{\kappa\chi^c}$, or on κ .

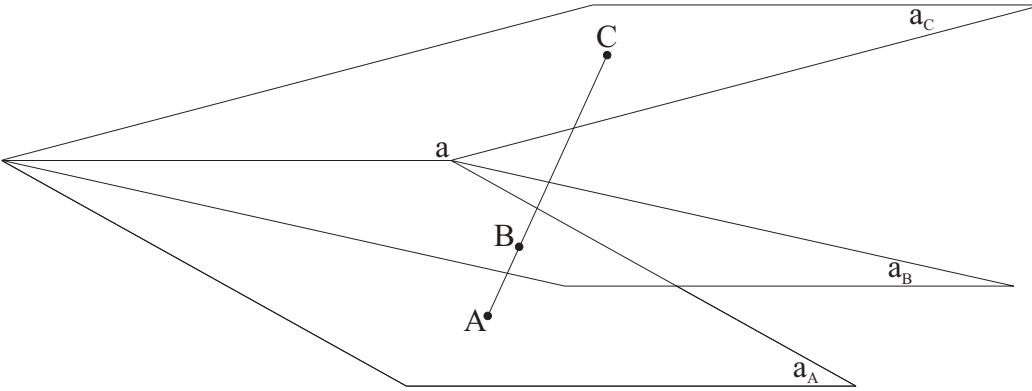

Figure 1.92: For any dihedral angle \widehat{AaB} there is a point C (and, consequently, a half-plane a_C) such that the half-plane a_B lies inside the dihedral angle \widehat{AaC} .

Proof. $\bar{\chi\kappa} = \bar{\chi\kappa} \cap \mathcal{C}^{Pt} = \bar{\chi\kappa} \cap (\bar{\kappa}_\chi \cup \mathcal{P}_{\bar{\kappa}} \cup \bar{\kappa}_\chi^c) \stackrel{L1.2.53.12}{=} \bar{\chi\kappa} \cap (\bar{\kappa}_\chi \cup \mathcal{P}_{\bar{\kappa}} \cup \bar{\kappa}_\chi^c) = (\bar{\chi\kappa} \cap \bar{\kappa}_\chi) \cup (\bar{\chi\kappa} \cap \mathcal{P}_{\bar{\kappa}}) \cup (\bar{\chi\kappa} \cap \bar{\kappa}_\chi^c) = Int(\widehat{\chi\kappa}) \cup \kappa \cap Int(\widehat{\chi\kappa})$. \square

Given a dihedral angle $\widehat{\chi\kappa}$, the dihedral angle $\widehat{\chi^c\kappa^c}$, formed by the half-planes χ^c , κ^c , complementary to χ , κ , respectively, is called (the dihedral angle) vertical, or opposite, to $\widehat{\chi\kappa}$. We write $vert(\widehat{\chi\kappa}) = \widehat{\chi^c\kappa^c}$. Obviously, the angle $vert(vert(\widehat{\chi\kappa}))$, opposite to the opposite $\widehat{\chi^c\kappa^c}$ of a given dihedral angle $\widehat{\chi\kappa}$, coincides with the dihedral angle $\widehat{\chi\kappa}$.

Lemma 1.2.55.20. *For any dihedral angle \widehat{AaB} there is a point C ²⁰² such that the half-plane a_B lies inside the dihedral angle \widehat{AaC} .* ²⁰³

Proof. (See Fig. 1.92.) Since \widehat{AaB} is a dihedral angle, by L 1.2.55.2 we have $B \notin \alpha_{aA}$. Hence by C 1.2.1.13 also $C \notin \alpha_{aA}$. By L 1.2.55.2 the dihedral angle \widehat{AaC} exists. By L 1.2.55.5, L 1.2.55.3 the half-plane a_B lies inside the dihedral angle \widehat{AaC} , q.e.d. \square

Lemma 1.2.55.21. *For any dihedral angle \widehat{AaC} there is a point B such that the half-plane a_B lies inside \widehat{AaC} .* ²⁰⁴

Proof. (See Fig. 1.92.) By T 1.2.2 $\exists B [ABC]$. By L 1.2.55.5, L 1.2.55.3 $a_B \subset Int(\widehat{AaC})$. \square

Lemma 1.2.55.22. *If points B, C lie on one side of a plane α_{aA} , and $a_B \neq a_C$, either the half-plane a_B lies inside the dihedral angle \widehat{AaC} , or the half-plane a_C lies inside the dihedral angle \widehat{AaB} .*

²⁰²and, consequently, a half-plane a_C

²⁰³This lemma is an analogue of A 1.2.2, L 1.2.21.18.

²⁰⁴This lemma is analogous to T 1.2.2, L 1.2.21.19. In the future the reader will encounter many such analogies.

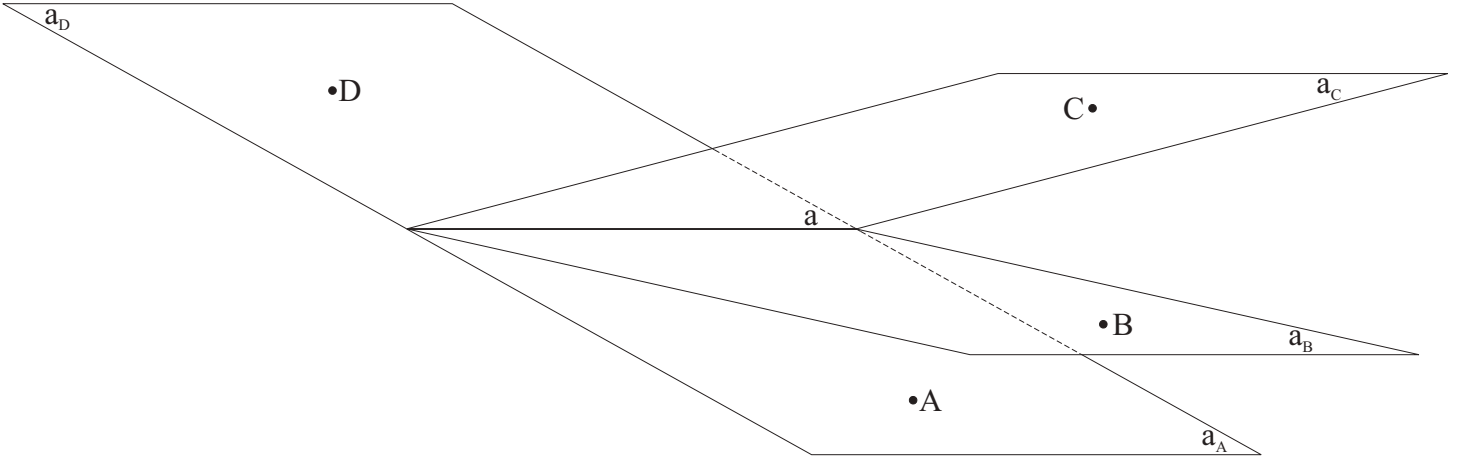

Figure 1.93: If B, C lie on one side of α_{aA} , and $a_B \neq a_C$, either a_B lies inside \widehat{AaC} , or the half-plane a_C lies inside \widehat{AaB} .

Proof. Denote $a_D \equiv a_A^c$. (See Fig. 1.93.) $BC\alpha_{aA} \xrightarrow{T1.2.53} a_B a_C \alpha_{aA}$. $a_B a_C \alpha_{aA} \& a_B \neq a_C \xrightarrow{L1.2.55.19} a_C \subset \text{Int}(\widehat{AaB}) \vee a_C \subset \text{Int}(\widehat{BaD})$.²⁰⁵ Suppose $a_C \subset \text{Int}(\widehat{BaD})$.²⁰⁶ Then by L 1.2.55.10 $a_B \subset \text{Ext}(\widehat{CaD})$. But since $a_B a_C \alpha_{aA} \& O_B \neq O_C \xrightarrow{L1.2.55.19} a_B \subset \text{Int}(\widehat{AaC}) \vee a_B \subset \text{Int}(\widehat{CaD})$, we conclude that $a_B \subset \text{Int}(\widehat{AaB})$. \square

Corollary 1.2.55.23. *Suppose that the rays h, k, l are the sections of half-planes χ, κ, λ with common edge a by a plane α . If the rays k, l lie in α on the same side of \bar{h} , then the half-planes κ, λ lie on the same side of the plane $\bar{\chi}$.*

Proof. Obviously, we can assume without loss of generality that the rays k, l are distinct.²⁰⁷ Then by L 1.2.21.21 either $k \subset \text{Int}\angle(h, l)$ or $l \subset \text{Int}\angle(h, k)$. Hence, in view of L 1.2.55.15, L 1.2.55.3 we have either $\kappa \subset \text{Int}\widehat{\chi\lambda}$ or $\lambda \subset \text{Int}\widehat{\chi\kappa}$. Then from definition of interior of dihedral angle we see that the half-planes κ, λ lie on the same side of the plane $\bar{\chi}$. \square

Corollary 1.2.55.24. *Suppose that the rays h, k, l are the sections of half-planes χ, κ, λ with common edge a by a plane α . If κ, λ lie on the same side of the plane $\bar{\chi}$, then the rays k, l lie in α on the same side of \bar{h} .*

Proof. Follows from L 1.2.55.22, L 1.2.55.16. \square

Corollary 1.2.55.25. *Suppose that the rays h, k, l are the sections of half-planes χ, κ, λ with common edge a by a plane α . If the rays k, l lie in α on opposite sides of \bar{h} , then the half-planes κ, λ lie on opposite sides of the plane $\bar{\chi}$.*

Proof. Take points $K \in k, L \in l$. Since, by hypothesis, the rays k, l lie in α on opposite sides of \bar{h} , the open interval (KL) is bound to meet the line \bar{h} in some point H . But $\bar{h} \subset a, k \subset \kappa, l \subset \lambda$, whence the result. \square

Corollary 1.2.55.26. *Suppose that the rays h, k, l are the sections of half-planes χ, κ, λ with common edge a by a plane α . If χ, λ lie on opposite sides of the plane $\bar{\kappa}$, then the rays h, l lie in α on opposite sides of \bar{k} .*

Proof. Obviously, the rays h, k, l lie in the same plane, namely, the plane of the section. Also, neither of the rays h, l lie on the line \bar{k} .²⁰⁸ Therefore, the rays h, l lie either on one side or on opposite sides of the line \bar{k} . But if h, l lie on the same side of \bar{k} then χ, λ lie on the same side of the plane $\bar{\kappa}$ (see C 1.2.55.23), contrary to hypothesis. Thus, we see that h, l lie in α on opposite sides of \bar{k} , q.e.d. \square

Lemma 1.2.55.27. *If a half-plane λ with the same edge as half-planes χ, κ lies inside the dihedral angle $\widehat{\chi\kappa}$ formed by them, then the half-plane κ lies inside the dihedral angle $\widehat{\chi\lambda}$.*

Proof. Using L 1.2.55.13, L 1.2.55.19 we have $\lambda \subset \text{Int}(\widehat{\chi\kappa}) \Rightarrow \kappa \subset \text{Ext}\widehat{\chi\lambda} \& \lambda\kappa\bar{\chi} \& \lambda \neq \kappa \Rightarrow \kappa \subset \text{Int}(\widehat{\chi\lambda})$. \square

²⁰⁵The lemma L 1.2.55.19 is applied here to every point of the half-plane a_C .

²⁰⁶If $a_C \subset \text{Int}(\widehat{AaB})$, we have nothing more to prove.

²⁰⁷If $k = l$, using T 1.1.3 we can see that the half-planes κ, λ coincide.

²⁰⁸In fact, suppose the contrary, i.e. that, for example h lies on \bar{k} . Then by T 1.1.3 the planes $\bar{\chi}$ and $\bar{\kappa}$ would coincide, which contradicts the hypothesis that χ, λ lie on opposite sides of the plane $\bar{\kappa}$.

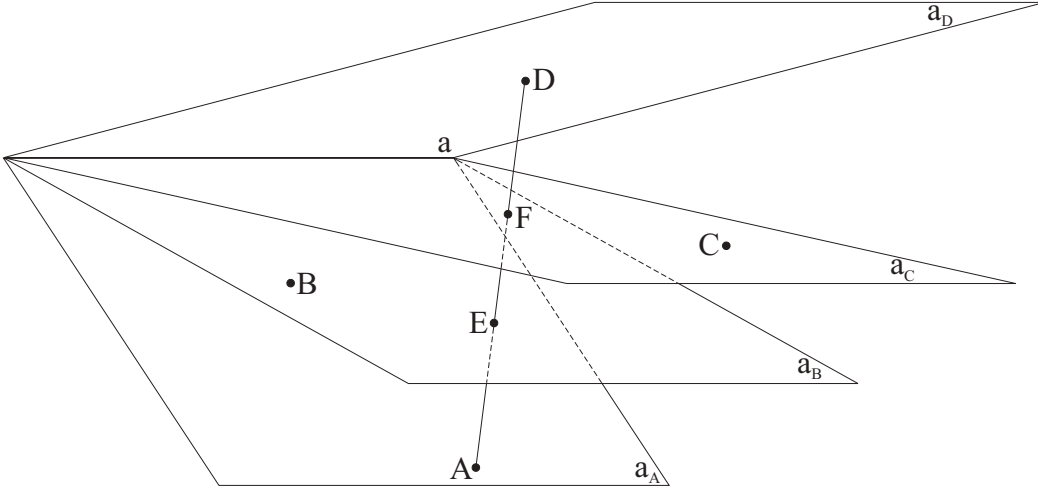

Figure 1.94: If a point C lies inside a dihedral angle \widehat{AaD} , and a point B inside a dihedral angle \widehat{AaC} , then the half-plane a_B lies inside the dihedral angle \widehat{AaD} , and the half-plane a_C lies inside the dihedral angle \widehat{BaD} .

Lemma 1.2.55.28. *If a point C lies inside a dihedral angle \widehat{AaD} , and a point B inside a dihedral angle \widehat{AaC} , then the half-plane a_B lies inside the dihedral angle \widehat{AaD} , and the half-plane a_C lies inside the dihedral angle \widehat{BaD} .* ²⁰⁹

Proof. (See Fig. 1.49.) $C \in \text{Int}(\widehat{AaD}) \stackrel{\text{L1.2.55.18}}{\implies} \exists F [AFD] \& F \in a_C$. $B \in \text{Int}(\widehat{AaC}) \stackrel{\text{L1.2.55.18}}{\implies} \exists E [AEF] \& E \in a_B$. $[AEF] \& [AFD] \stackrel{\text{L1.2.3.2}}{\implies} [AED] \& [EFD]$. Hence, using L 1.2.55.5, L 1.2.55.3, we can write $A \in a_A \& E \in a_B \& F \in a_C \& D \in a_D \& [AED] \& [EFD] \Rightarrow a_B \subset \text{Int}(\widehat{AaD}) \& a_C \subset \text{Int}(\widehat{BaD})$. \square

Lemma 1.2.55.29. *If a half-plane a_B lies inside a dihedral angle \widehat{AaC} , the ray a_C lies inside a dihedral \widehat{BaD} , and at least one of the half-planes a_B, a_C lies on the same side of the plane α_{aA} as the half-plane a_D , then the half-planes a_B, a_C both lie inside the dihedral angle \widehat{AaD} .*

Proof. Note that we can assume $a_B a_D \alpha_{aA}$ without any loss of generality, because by the definition of dihedral angle $a_B \subset \text{Int}(\widehat{AaC}) \Rightarrow a_B a_C \alpha_{aA}$, and if $a_C a_D \alpha_{aA}$, we have $a_B a_C \alpha_{aA} \& a_C a_D \alpha_{aA} \stackrel{\text{L1.2.52.2}}{\implies} a_B a_D \alpha_{aA}$. $a_B a_D \alpha_{aA} \& a_B \neq a_D \stackrel{\text{L1.2.55.22}}{\implies} a_B \subset \text{Int}(\widehat{AaD}) \vee a_D \subset \text{Int}(\widehat{AaB})$. If $a_B \subset \text{Int}(\widehat{AaD})$ (see Fig. 1.95, a)), then using the preceding lemma (L 1.2.55.28), we immediately obtain $a_C \subset \text{Int}(\widehat{AaD})$. But if $a_D \subset \text{Int}(\widehat{AaB})$ (see Fig. 1.95, b)), observing that $a_B \subset \text{Int}(\widehat{AaC})$, we have by the same lemma $a_B \subset \text{Int}(\widehat{DaC})$, which, by C 1.2.55.11, contradicts $a_C \subset \text{Int}(\widehat{BaD})$. \square

Lemma 1.2.55.30. *Suppose that a finite sequence of points A_i , where $i \in \mathbb{N}_n, n \geq 3$, has the property that every point of the sequence, except for the first and the last, lies between the two points with adjacent (in \mathbb{N}) numbers. Suppose, further, that a line b is skew to the line $a = A_1 A_n$ ²¹⁰ Then the half-planes $b_{A_1}, b_{A_2}, \dots, b_{A_n}$ are in order $[b_{A_1} b_{A_2} \dots b_{A_n}]$, that is, $b_{A_j} \subset \text{Int}(\widehat{A_i b A_k})$ whenever either $i < j < k$ or $k < j < i$.*

Proof. Follows from L 1.2.7.3, L 1.2.55.10, L 1.2.55.4. \square

Lemma 1.2.55.31. *Suppose half-planes κ, λ lie on the same side of a plane $\bar{\chi}$ (containing a third half-plane χ), the half-planes χ, λ lie on opposite sides of the half-plane $\bar{\kappa}$, and the points H, L lie on the half-planes χ, λ , respectively. Then the half-plane κ lies inside the dihedral angle $\widehat{\chi\lambda}$ and meets the open interval (HL) at some point K .*

²⁰⁹L 1.2.55.3 implies that any other point of the half-plane a_C can enter this condition in place of C , so instead of "If a point $C \dots$ " we can write "if some point of the half-plane $O_C \dots$ "; the same holds true for the half-plane a_B and the dihedral angle \widehat{AaC} . Note that, for example, L 1.2.55.6, L 1.2.55.18, L 1.2.55.22 also allow similar reformulation, which we shall refer to in the future to avoid excessive mentioning of L 1.2.17.6. Observe also that we could equally well have given for this lemma a formulation apparently converse to the one presented here: If a point B lies inside a dihedral angle \widehat{AaD} , and a point C lies inside the dihedral angle \widehat{BaD} (the comments above concerning our ability to choose instead of B and C any other points of the half-planes a_B and a_C , respectively being applicable here as well), the half-plane a_C lies inside the dihedral angle \widehat{AaD} , and the half-plane a_B lies inside the dihedral angle \widehat{AaC} . This would make L 1.2.55.28 fully analogous to L 1.2.3.2. But now we don't have to devise a proof similar to that given at the end of L 1.2.3.2, because it follows simply from the symmetry of the original formulation of this lemma with respect to the substitution $A \rightarrow D, B \rightarrow C, C \rightarrow B, D \rightarrow A$. This symmetry, in its turn, stems from the definition of dihedral angle as a non-ordered couple of half-planes, which entails $\widehat{AaC} = \widehat{CaA}, \widehat{AaD} = \widehat{DaA}$, etc.

²¹⁰That is, there is no plane containing both a and b . Evidently, in view of L 1.1.1.4 the line a is defined by any two distinct points $A_i, A_j, i \neq j, i, j \in \mathbb{N}$, i.e. $a = a_{A_i A_j}$.

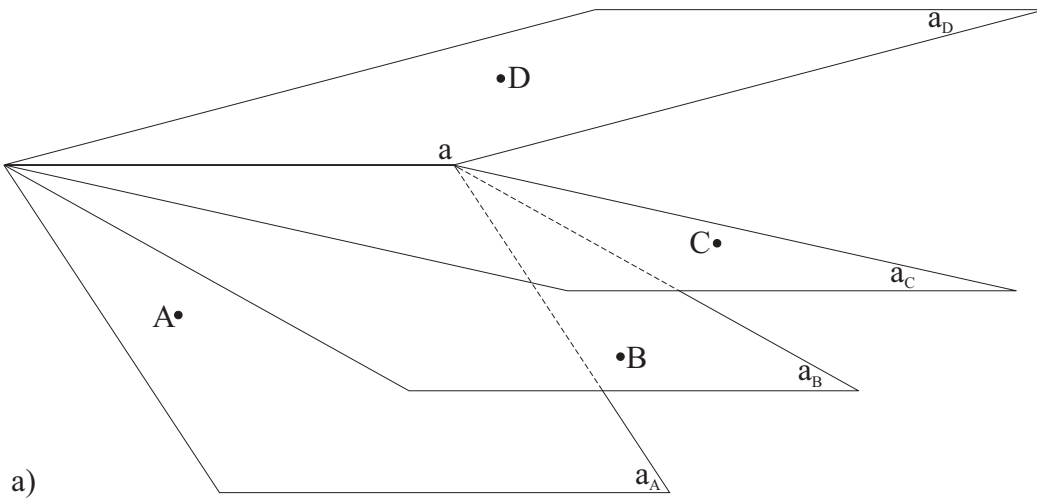

a)

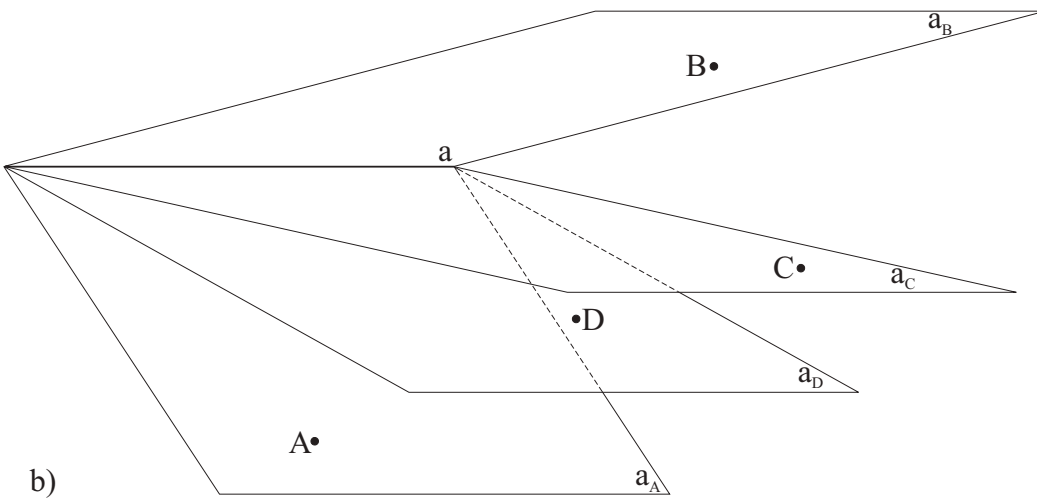

b)

Figure 1.95: If a half-plane a_B lies inside a dihedral angle \widehat{AaC} , the ray a_C lies inside a dihedral \widehat{BaD} , and at least one of the half-planes a_B , a_C lies on the same side of the plane α_{a_A} as the half-plane a_D , then the half-planes a_B , a_C both lie inside the dihedral angle \widehat{AaD} .

Proof. $H \in \chi \& K \in \lambda \& \chi\bar{\kappa}\lambda \Rightarrow \exists K \ K \in \bar{\kappa} \& [HKL]$. $[HKL] \& H \in \bar{\chi} \xrightarrow{L1.2.53.9} KL\bar{\chi}$. Hence $K \in \kappa$, for, obviously, $K \neq O$, and, assuming $K \in \kappa^c$, we would have: $\kappa\lambda\bar{\chi} \& \kappa\bar{\chi}i\kappa^c \xrightarrow{L1.2.18.5} \lambda\bar{\chi}\kappa^c$, which, in view of $L \in \lambda$, $K \in \kappa^c$, would imply $L\bar{\chi}K$ - a contradiction. Finally, $H \in \chi \& L \in \lambda \& [HKL] \xrightarrow{L1.2.55.10} K \in \widehat{\chi\lambda} \xrightarrow{L1.2.55.4} k \subset \widehat{\chi\lambda}$. \square

Lemma 1.2.55.32. *Suppose that the half-planes χ , κ , λ have the same edge and the half-planes χ , λ lie on opposite sides of the plane $\bar{\kappa}$ (so that the dihedral angles $\widehat{\chi\bar{\kappa}}$, $\widehat{\kappa\lambda}$ are adjacent). Then the half-planes χ , λ lie on the same side of the plane $\bar{\chi}$ iff the half-plane λ lies inside the dihedral angle $\widehat{\chi^c\kappa}$, and the half-planes κ , λ lie on opposite sides of the plane $\bar{\chi}$ iff the half-plane χ^c lies inside the dihedral angle $\kappa\lambda$. Also, the first case takes place iff the half-plane κ lies between the half-planes χ , λ , and the second case iff the half-plane κ^c lies between the half-planes χ , λ .*

Proof. Note that $\lambda\bar{\kappa}\chi \& \chi^c\bar{\kappa}\chi \xrightarrow{L1.2.52.4} \chi^c\lambda\bar{\kappa}$. Suppose first that the half-planes κ , λ lie on the same side of the plane $\bar{\chi}$. Then we can write $\chi^c\lambda\bar{\kappa} \& \kappa\lambda\bar{\chi} \Rightarrow \lambda \subset \text{Int}\widehat{\chi^c\kappa}$. Conversely, from the definition of interior we have $\lambda \subset \text{Int}\widehat{\chi^c\kappa} \Rightarrow \kappa\lambda\bar{\chi}$. Suppose now that the half-planes κ , λ lie on opposite sides of the plane $\bar{\chi}$. Then, obviously, the half-plane λ cannot lie inside the dihedral angle $\widehat{\chi^c\kappa}$, for otherwise κ , λ would lie on the same side of χ . Hence by L 1.2.55.22 we have $\chi^c \subset \widehat{\kappa\lambda}$. Conversely, if $\chi^c \subset \text{Int}\widehat{\kappa\lambda}$, the half-planes κ , λ lie on opposite sides of the plane $\bar{\lambda}$ in view of L 1.2.55.22.²¹¹ Concerning the second part, it can be demonstrated using the preceding lemma (L 1.2.55.31) and (in the second case) the observation that $\lambda\bar{\chi}\kappa \& \kappa^c\bar{\chi}\kappa \xrightarrow{L1.2.52.4} \kappa^c\lambda\bar{\chi}$. (See also C 1.2.55.9). \square

Lemma 1.2.55.33. *Suppose that the half-planes χ , κ , λ have the same edge a and the half-planes χ , λ lie on opposite sides of the plane $\bar{\kappa}$. Then either the half-plane κ lies inside the dihedral angle $\widehat{\chi\lambda}$, or the half-plane κ^c lies inside the dihedral angle $\widehat{\chi\lambda}$, or $\lambda = \chi^c$. (In the last case we again have either $\kappa \subset \text{Int}\widehat{\chi\chi^c}$ or $\kappa^c \subset \text{Int}\widehat{\chi\chi^c}$ depending on which side of the plane $\bar{\kappa}$ (i.e. which of the two half-planes having the plane $\bar{\kappa}$ as its edge) is chosen as the interior of the straight dihedral angle $\widehat{\chi\chi^c}$).*

Proof. Take points $H \in \chi$, $L \in \lambda$. Then $\chi\bar{\kappa}\lambda$ implies that there is a point $K \in \bar{\kappa}$ such that $[HKL]$. Then, obviously, either $K \in \kappa$, or $K \in a$, or $K \in \kappa^c$. If $K \in a$ then $L \in \kappa^c$ (see L 1.2.19.8) and thus $\lambda = \chi^c$ (see L 1.2.51.6). If $K \notin a$ then the points H , L and the line a are not coplanar.²¹² Therefore, the proper (non-straight) dihedral angle $\widehat{\chi\lambda}$ exists (see L 1.2.21.1, L 1.2.55.2). Hence by L 1.2.55.5, L 1.2.55.3 we have either $H \in \chi \& L \in \lambda \& [HKL] \& K \in \kappa \Rightarrow \kappa \subset \text{Int}\widehat{\chi\lambda}$, or $H \in \chi \& L \in \lambda \& [HKL] \& K \in \kappa^c \Rightarrow \kappa^c \subset \text{Int}\widehat{\chi\lambda}$, depending on which of the half-planes κ , κ^c the point K belongs to.

Betweenness Relation for Half-Planes

We shall refer to a collection of half-planes emanating from a common edge a as a pencil of half-planes or a half-plane pencil, which will be written sometimes as $\mathcal{S}^{(a)}$. The line a will, naturally, be called the edge, or origin, of the pencil. If two or more half-planes lie in the same pencil (i.e. have the same edge), they will sometimes be called equioriginal (to each other).

Theorem 1.2.55. *Given a plane α , a line a lying in α , and a point A lying outside α , the set (pencil) \mathfrak{J} of all half-planes with the edge a , lying in on the same side of the plane α as the point A ²¹³, admits a generalized betweenness relation.*

To be more precise, we say that a half-plane $a_B \in \mathfrak{J}$ lies between half-planes $a_A \in \mathfrak{J}$ and $a_C \in \mathfrak{J}$ iff a_B lies inside the dihedral angle \widehat{AaC} , i.e. iff $a_B \subset \text{Int}(\widehat{AaC})$.²¹⁴ Then the following properties hold, corresponding to Pr 1.2.1 - Pr 1.2.7 in the definition of generalized betweenness relation:

1. *If a half-plane $a_B \in \mathfrak{J}$ lies between half-planes $a_A \in \mathfrak{J}$ and $a_C \in \mathfrak{J}$, then a_B also lies between a_C and a_A , and a_A , a_B , a_C are distinct half-planes.*
2. *For every two half-planes $a_A, a_B \in \mathfrak{J}$ there is a half-plane $a_C \in \mathfrak{J}$ such that a_B lies between a_A and a_C .*
3. *If a half-plane $a_B \in \mathfrak{J}$ lies between half-planes $a_A, a_C \in \mathfrak{J}$, the half-plane a_C cannot lie between the rays a_A and a_B .*
4. *For any two half-planes $a_A, a_C \in \mathfrak{J}$ there is a half-plane $a_B \in \mathfrak{J}$ between them.*
5. *Among any three distinct half-planes $a_A, a_B, a_C \in \mathfrak{J}$ one always lies between the others.*
6. *If a half-plane $a_B \in \mathfrak{J}$ lies between half-planes $a_A, a_C \in \mathfrak{J}$, and the half-plane a_C lies between a_B and $a_D \in \mathfrak{J}$, both a_B , a_C lie between a_A and a_D .*
7. *If a half-plane $a_B \in \mathfrak{J}$ lies between half-planes $a_A, a_C \in \mathfrak{J}$, and the half-plane a_C lies between a_A and $a_D \in \mathfrak{J}$, then a_B lies also between a_A , a_D , and a_C lies between a_B and a_D . The converse is also true. That is, for all half-planes of the pencil \mathfrak{J} we have $[a_A a_B a_C] \& [a_A a_C a_D] \Leftrightarrow [a_A a_B a_D] \& [a_B a_C a_D]$.*

The statements of this theorem are easier to comprehend and prove when given the following formulation in "native" terms.

²¹¹By that lemma, any open interval joining a point $K \in \kappa$ with a point $L \in \lambda$ would then contain a point $H \in \mathcal{P}_{\bar{\chi}}$.

²¹²Suppose the contrary, i.e. that H , L , a coplane. (Then the points H , L lie in the plane $\bar{\chi} = \bar{\lambda}$ on opposite sides of the line a (this can easily be seen using L 1.2.19.8; actually, we have in this case $\lambda = \chi^c$). Then $K \in a = \bar{\chi} \cap \bar{\kappa}$ - a contradiction.

²¹³That is, of all half-planes with the edge a , lying in the half-space α_A .

²¹⁴If $a_B \in \mathfrak{J}$ lies between $a_A \in \mathfrak{J}$ and $a_C \in \mathfrak{J}$, we write this as $[a_A a_B a_C]$ in accord with the general notation. Sometimes, however, it is more convenient to write simply $a_B \subset \text{Int}(\widehat{AaC})$.

1. If a half-plane $a_B \in \mathfrak{J}$ lies inside the angle \widehat{AaC} , where $a_A, a_C \in \mathfrak{J}$, it also lies inside the dihedral angle \widehat{CaA} , and the half-planes a_A, a_B, a_C are distinct.
2. For every two half-planes $a_A, a_B \in \mathfrak{J}$ there is a half-plane $a_C \in \mathfrak{J}$ such that the half-plane a_B lies inside the dihedral angle \widehat{AaC} .
3. If a half-plane $a_B \in \mathfrak{J}$ lies inside a dihedral angle \widehat{AaC} , where $a_A, a_C \in \mathfrak{J}$, the half-plane a_C cannot lie inside the dihedral angle \widehat{AaB} .
4. For any two half-planes $a_A, a_C \in \mathfrak{J}$, there is a half-plane $a_B \in \mathfrak{J}$ which lies inside the dihedral angle \widehat{AaC} .
5. Among any three distinct half-planes $a_A, a_B, a_C \in \mathfrak{J}$ one always lies inside the dihedral angle formed by the other two.
6. If a half-plane $a_B \in \mathfrak{J}$ lies inside an angle \widehat{AaC} , where $a_A, a_C \in \mathfrak{J}$, and the half-plane a_C lies inside \widehat{BaD} , then both a_B and a_C lie inside the dihedral angle \widehat{AaD} .
7. If a half-plane $a_B \in \mathfrak{J}$ lies inside a dihedral angle \widehat{AaC} , where $a_A, a_C \in \mathfrak{J}$, and the half-plane a_C lies inside \widehat{AaD} , then a_B also lies inside \widehat{AaD} , and the half-plane a_C lies inside the dihedral angle \widehat{BaD} . The converse is also true. That is, for all half-planes of the pencil \mathfrak{J} we have $a_B \subset \text{Int}(\widehat{AaC}) \ \& \ a_C \subset \text{Int}(\widehat{AaD}) \Leftrightarrow a_B \subset \text{Int}(\widehat{AaD}) \ \& \ a_C \subset \text{Int}(\widehat{BaD})$.

Proof. 1. Follows from the definition of $\text{Int}(\widehat{AaC})$.

2. See L 1.2.55.20.

3. See C 1.2.55.11.

4. See L 1.2.55.21.

5. By C 1.1.6.6 there is a point D lying in α outside a . By T 1.1.2 we have $\alpha = \alpha_{aD}$. Then $a_A a_B \alpha \ \& \ a_A \neq a_B \ \& \ a_A a_C \alpha \ \& \ a_A \neq a_C \ \& \ a_B a_C \alpha \ \& \ a_B \neq a_C \xrightarrow{\text{L1.2.55.22}} (a_A \subset \text{Int}(\widehat{DaB}) \vee a_B \subset \text{Int}(\widehat{DaA})) \ \& \ (a_A \subset \text{Int}(\widehat{DaC}) \vee a_C \subset \text{Int}(\widehat{DaA})) \ \& \ (a_B \subset \text{Int}(\widehat{DaC}) \vee a_C \subset \widehat{DaB})$. Suppose $a_A \subset \text{Int}(\widehat{DaB})$.²¹⁵ If $a_B \subset \text{Int}(\widehat{DaC})$ (see Fig. 1.96, a) then $a_A \subset \text{Int}(\widehat{DaB}) \ \& \ a_B \subset \text{Int}(\widehat{DaC}) \xrightarrow{\text{L1.2.55.28}} a_B \subset \text{Int}(\widehat{AaC})$. Now suppose $a_C \subset \text{Int}(\widehat{DaB})$. If $a_C \subset \text{Int}(\widehat{DaA})$ (see Fig. 1.96, b) then $a_C \subset \text{Int}(\widehat{DaA}) \ \& \ a_A \subset \widehat{DaB} \xrightarrow{\text{L1.2.55.28}} a_A \subset \text{Int}(\widehat{BaC})$. Finally, if $a_A \subset \text{Int}(\widehat{DaC})$ (see Fig. 1.96, c) then $a_A \subset \text{Int}(\widehat{DaC}) \ \& \ a_C \subset \text{Int}(\widehat{DaB}) \xrightarrow{\text{L1.2.55.28}} a_C \subset \text{Int}(\widehat{AaB})$.

6. (See Fig. 1.97.) Choose a point $E \in \alpha$, $E \notin a$, so that $a_B \subset \text{Int}(\widehat{EaD})$.²¹⁶ $a_B \subset \text{Int}(\widehat{EaD}) \ \& \ a_C \subset \text{Int}(\widehat{BaD}) \xrightarrow{\text{L1.2.55.28}} a_C \subset \text{Int}(\widehat{EaD}) \ \& \ a_B \subset \text{Int}(\widehat{EaC})$. Using the definition of interior, and then L 1.2.18.1, L 1.2.18.2, we can write $a_B \subset \text{Int}(\widehat{EaC}) \ \& \ a_B \subset \text{Int}(\widehat{AaC}) \Rightarrow a_B a_E \alpha_{aC} \ \& \ a_B a_A \alpha_{aC} \Rightarrow a_A a_C \alpha_{aC}$. Using the definition of the interior of \widehat{EaC} , we have $a_A a_E \alpha_{aC} \ \& \ a_A a_C \alpha_{aE} \Rightarrow a_A \subset \text{Int}(\widehat{EaC})$. $a_A \subset \text{Int}(\widehat{EaC}) \ \& \ a_C \subset \text{Int}(\widehat{EaD}) \xrightarrow{\text{L1.2.55.28}} a_C \subset \text{Int}(\widehat{AaD})$. Finally, $a_C \subset \text{Int}(\widehat{AaD}) \ \& \ a_B \subset \text{Int}(\widehat{AaC}) \xrightarrow{\text{L1.2.55.28}} a_B \subset \text{Int}(\widehat{EaD})$.

7. See L 1.2.55.28. \square

Given a pencil \mathfrak{J} of half-planes, all lying on a given side of a plane α , define an open dihedral angular interval $(a_A a_C)$ formed by the half-planes $a_A, a_C \in \mathfrak{J}$, as the set of all half-planes $a_B \in \mathfrak{J}$ lying inside the dihedral angle \widehat{AaC} . That is, for $a_A, a_C \in \mathfrak{J}$ we let $(a_A a_C) = \{a_B | a_B \subset \text{Int}(\widehat{AaC})\}$. In analogy with the general case, we shall refer to $(a_A a_C)$, $[a_A a_C]$, $[a_A a_C]$ as half-open, half-closed, and closed dihedral angular intervals, respectively.²¹⁷ In what follows, open dihedral angular intervals, half-open, half-closed and closed dihedral angular intervals will be collectively referred to as dihedral angular interval-like sets.

Given a pencil \mathfrak{J} of half-planes having the same edge a and all lying on the same side of a plane α as a given point O , the following L 1.2.56.1 – T 1.2.61 hold.²¹⁸

Lemma 1.2.56.1. *If a half-plane $a_B \in \mathfrak{J}$ lies between half-planes a_A, a_C of the pencil \mathfrak{J} , the half-plane a_A cannot lie between the half-planes a_B and a_C . In other words, if a half-plane $a_B \in \mathfrak{J}$ lies inside \widehat{AaC} , where $a_A, a_C \in \mathfrak{J}$, then the half-plane a_A cannot lie inside the dihedral angle \widehat{BaC} .*

Lemma 1.2.56.2. *Suppose each of $\lambda, \mu \in \mathfrak{J}$ lies inside the dihedral angle formed by $\chi, \kappa \in \mathfrak{J}$. If a half-plane $\nu \in \mathfrak{J}$ lies inside the dihedral angle $\widehat{\lambda\mu}$, it also lies inside the dihedral angle $\widehat{\chi\kappa}$. In other words, if half-planes $\lambda, \mu \in \mathfrak{J}$ lie between half-planes $\chi, \kappa \in \mathfrak{J}$, the open dihedral angular interval $(\lambda\mu)$ is contained in the open dihedral angular interval $(\chi\kappa)$ ²¹⁹, i.e. $(\lambda\mu) \subset (\chi\kappa)$. (see Fig 1.98)*

²¹⁵We can do this without any loss of generality. No loss of generality results from the fact that the half-planes a_A, a_B, a_C enter the conditions of the theorem symmetrically.

²¹⁶By C 1.1.6.5 $\exists E \in \alpha \ \& \ E \notin a$. By T 1.1.2 $\alpha = \alpha_{aE}$. By L 1.2.55.19, L 1.2.55.3 $a_D a_B \alpha \ \& \ a_D \neq a_B \Rightarrow a_B \subset \text{Int}(\widehat{EaD}) \vee a_B \subset \text{Int}(\widehat{FaD})$, where $a_F = (aE)^c$. We choose $a_B \subset \text{Int}(\widehat{EaD})$, renaming $E \rightarrow F$, $F \rightarrow E$ if needed.

²¹⁷It should be noted that, as in the case of intervals consisting of points, in view of the equality $\widehat{\chi\kappa} = \widehat{\kappa\chi}$, and the corresponding symmetry of open dihedral angular intervals, this distinction between half-open and half-closed dihedral angular intervals is rather artificial, similar to the distinction between a half-full glass and a half-empty one!

²¹⁸Some of them merely reiterate or even weaken the results proven earlier specifically for half-planes, but they are given here nonetheless to illustrate the versatility and power of the unified approach. To let the reader develop familiarity with both flavors of terminology for the generalized betweenness relation on the half-plane pencil \mathfrak{J} , we give two formulations for a few results to follow.

²¹⁹A notation like $(\chi\kappa)$ for an open dihedral angular interval should not be confused with the notation $(\widehat{\chi\kappa})$ used for the corresponding dihedral angle.

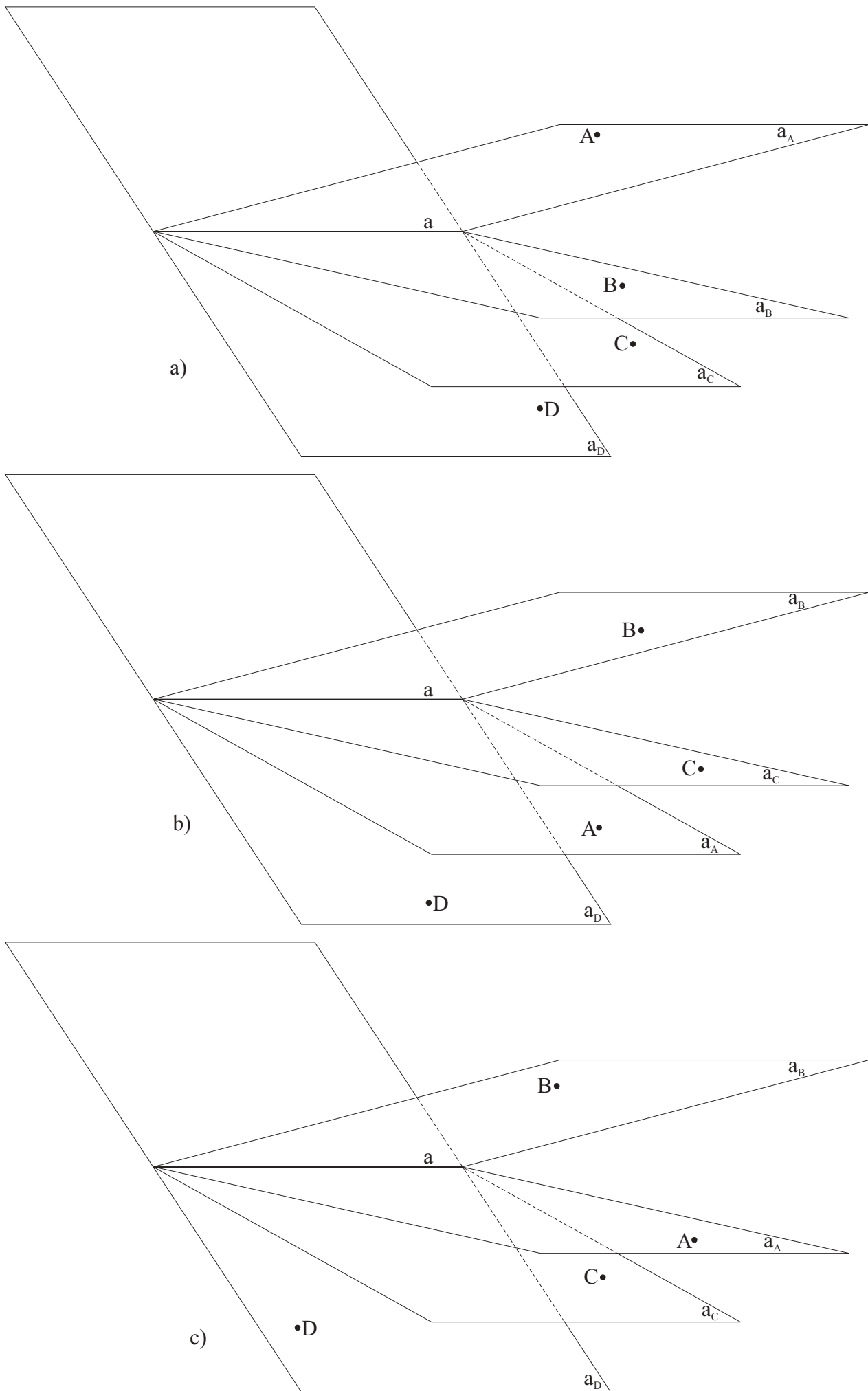

Figure 1.96: Among any three distinct half-planes $a_A, a_B, a_C \in \mathfrak{J}$ one always lies inside the dihedral angle formed by the other two.

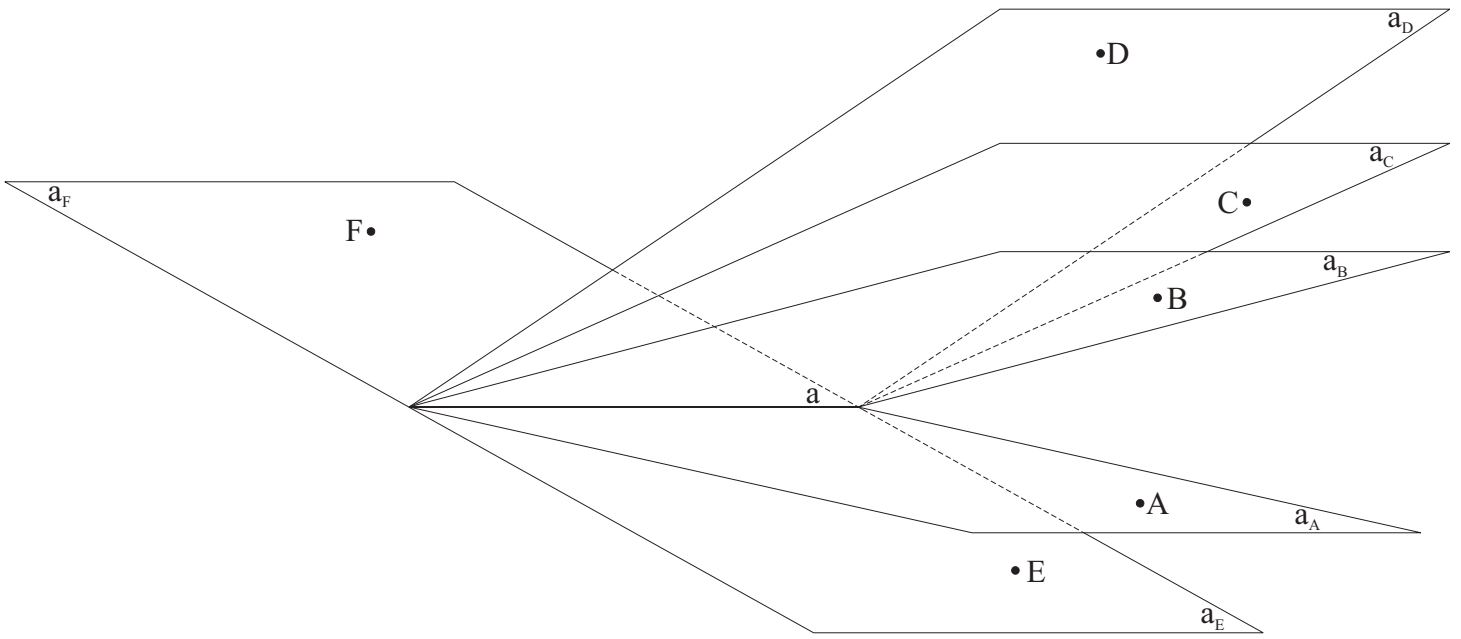

Figure 1.97: If a half-plane $a_B \in \mathfrak{J}$ lies inside an angle \widehat{AaC} , where $a_A, a_C \in \mathfrak{J}$, and the half-plane a_C lies inside \widehat{BaD} , then both a_B and a_C lie inside the dihedral angle \widehat{AaD} .

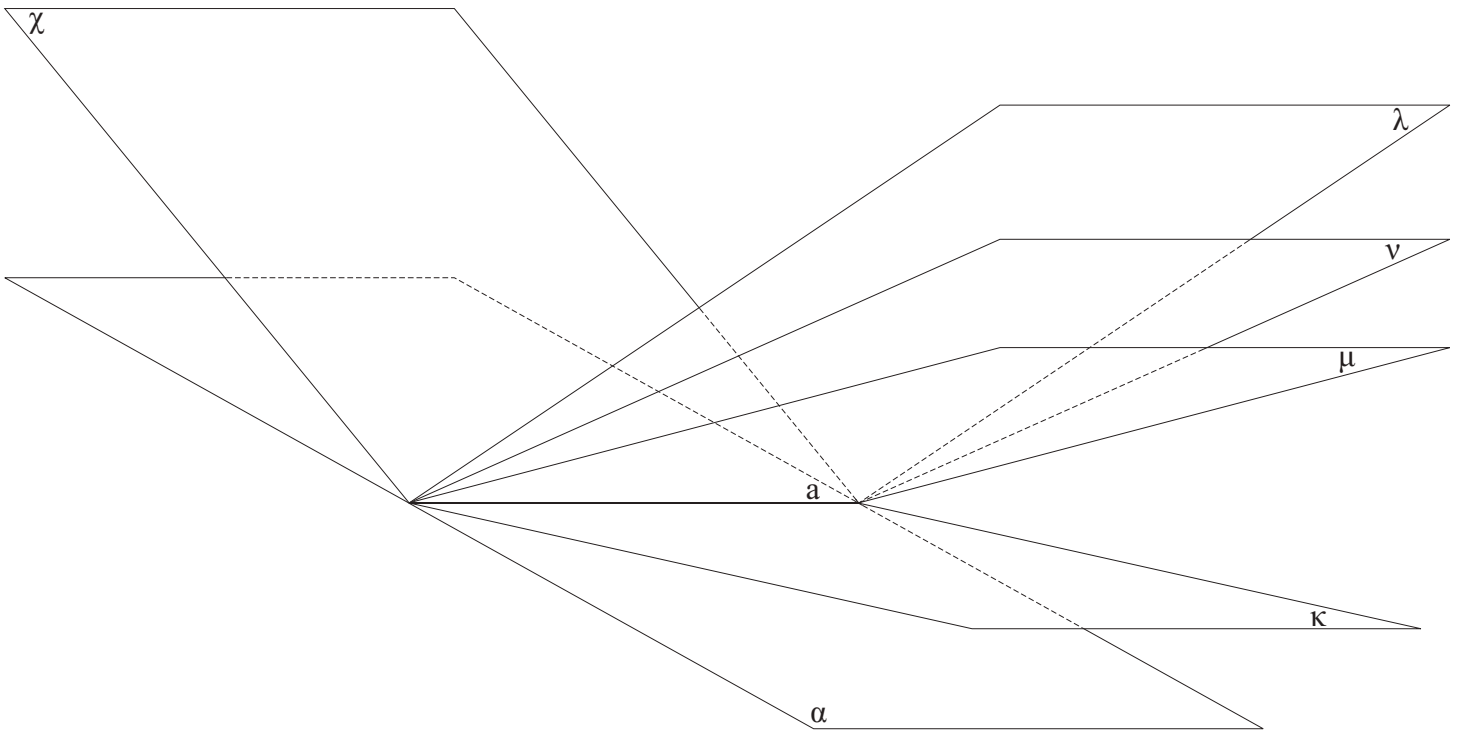

Figure 1.98: If half-planes $\lambda, \mu \in \mathfrak{J}$ lie between half-planes $\chi, \kappa \in \mathfrak{J}$, the open dihedral angular interval $(\lambda\mu)$ is contained in the open dihedral angular interval $(\chi\kappa)$

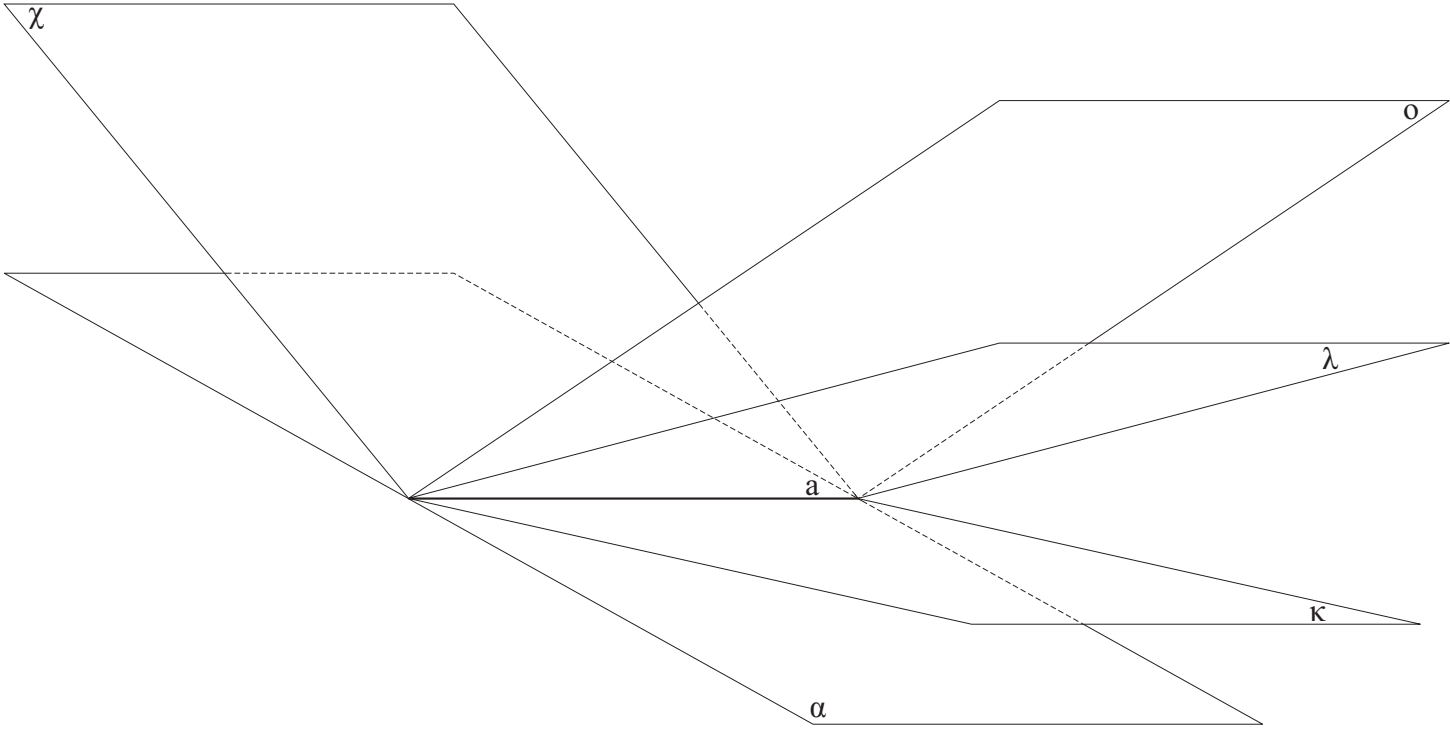

Figure 1.99: If $o \in \mathfrak{J}$ divides $\chi, \kappa \in \mathfrak{J}$, as well as χ and $\lambda \in \mathfrak{J}$, it does not divide κ, λ .

Lemma 1.2.56.3. Suppose each side of an (extended) dihedral angles $\widehat{\lambda\mu}$ (where $\lambda, \mu \in \mathfrak{J}$) either lies inside an (extended) dihedral angle $\widehat{\chi\kappa}$, where $\chi, \kappa \in \mathfrak{J}$, or coincides with one of its sides. Then if a half-plane $\nu \in \mathfrak{J}$ lies inside $\widehat{\lambda\mu}$, it also lies inside the dihedral angle $\widehat{\chi\kappa}$.²²⁰

Lemma 1.2.56.4. If a half-plane $\lambda \in \mathfrak{J}$ lies between half-planes $\chi, \kappa \in \mathfrak{J}$, none of the half-planes of the open dihedral angular interval $(\chi\lambda)$ lie on the open dihedral angular interval $(\lambda\kappa)$. That is, if a half-plane $\lambda \in \mathfrak{J}$ lies inside $\widehat{\chi\kappa}$, none of the half-planes²²¹ lying inside the dihedral angle $\widehat{\chi\lambda}$ lie inside the dihedral angle $\widehat{\lambda\kappa}$.

Proposition 1.2.56.5. If two (distinct) half-planes $\lambda \in \mathfrak{J}, \mu \in \mathfrak{J}$ lie inside the dihedral angle $\widehat{\chi\kappa}$, where $\chi \in \mathfrak{J}, \kappa \in \mathfrak{J}$, then either the half-plane λ lies inside the dihedral angle $\widehat{\chi\mu}$, or the half-plane μ lies inside the dihedral angle $\widehat{\chi\lambda}$.

Lemma 1.2.56.6. Each of $\lambda, \mu \in \mathfrak{J}$ lies inside the closed dihedral angular interval formed by $\chi, \kappa \in \mathfrak{J}$ (i.e. each of the half-planes λ, μ either lies inside the dihedral angle $\widehat{\chi\kappa}$ or coincides with one of its sides) iff all the half-planes $\nu \in \mathfrak{J}$ lying inside the dihedral angle $\widehat{\lambda\mu}$ lie inside the dihedral angle $\widehat{\kappa\lambda}$.

Lemma 1.2.56.7. If a half-plane $\lambda \in \mathfrak{J}$ lies between half-planes χ, κ of the pencil \mathfrak{J} , any half-plane of the open dihedral angular interval $(\chi\kappa)$, distinct from λ , lies either on the open angular interval $(\chi\lambda)$ or on the open dihedral angular interval $(\lambda\kappa)$. In other words, if a half-plane $\lambda \in \mathfrak{J}$ lies inside $\widehat{\chi\kappa}$, formed by half-planes χ, κ of the pencil \mathfrak{J} , any other (distinct from λ) half-plane lying inside $\widehat{\chi\kappa}$, also lies either inside $\widehat{\chi\lambda}$ or inside $\widehat{\lambda\kappa}$.

Lemma 1.2.56.8. If a half-plane $o \in \mathfrak{J}$ divides half-planes $\chi, \kappa \in \mathfrak{J}$, as well as χ and $\lambda \in \mathfrak{J}$, it does not divide κ, λ (see Fig. 1.99).

Betweenness Relation for n Half-Planes with Common Edge

Lemma 1.2.56.9. Suppose $\chi_1, \chi_2, \dots, \chi_n$ (\dots) is a finite (countably infinite) sequence of half-planes of the pencil \mathfrak{J} with the property that a half-plane of the sequence lies between two other half-planes of the sequence²²² if its number has an intermediate value between the numbers of these half-planes. (see Fig. 1.100) Then the converse of this property is true, namely, that if a half-plane of the sequence lies inside the dihedral angle formed by two other half-planes of the sequence, its number has an intermediate value between the numbers of these two half-planes. That is, $(\forall i, j, k \in \mathbb{N}_n$ (respectively, \mathbb{N}) $((i < j < k) \vee (k < j < i) \Rightarrow [\chi_i\chi_j\chi_k]) \Rightarrow (\forall i, j, k \in \mathbb{N}_n$ (respectively, \mathbb{N}) $([\chi_i\chi_j\chi_k] \Rightarrow (i < j < k) \vee (k < j < i))$).

²²⁰It may prove instructive to reformulate this result using the "pointwise" terminology for dihedral angles: Suppose each side of a dihedral angle \widehat{CaD} either lies inside an (extended) dihedral angle \widehat{AaB} , or coincides with one of its sides. Then if a half-plane has edge point a and lies inside \widehat{CaD} , it lies inside the (extended) dihedral angle AaB .

²²¹Actually, none of the points lying on any of these half-planes.

²²²i.e., lies inside the dihedral angle formed by two other half-planes of the sequence

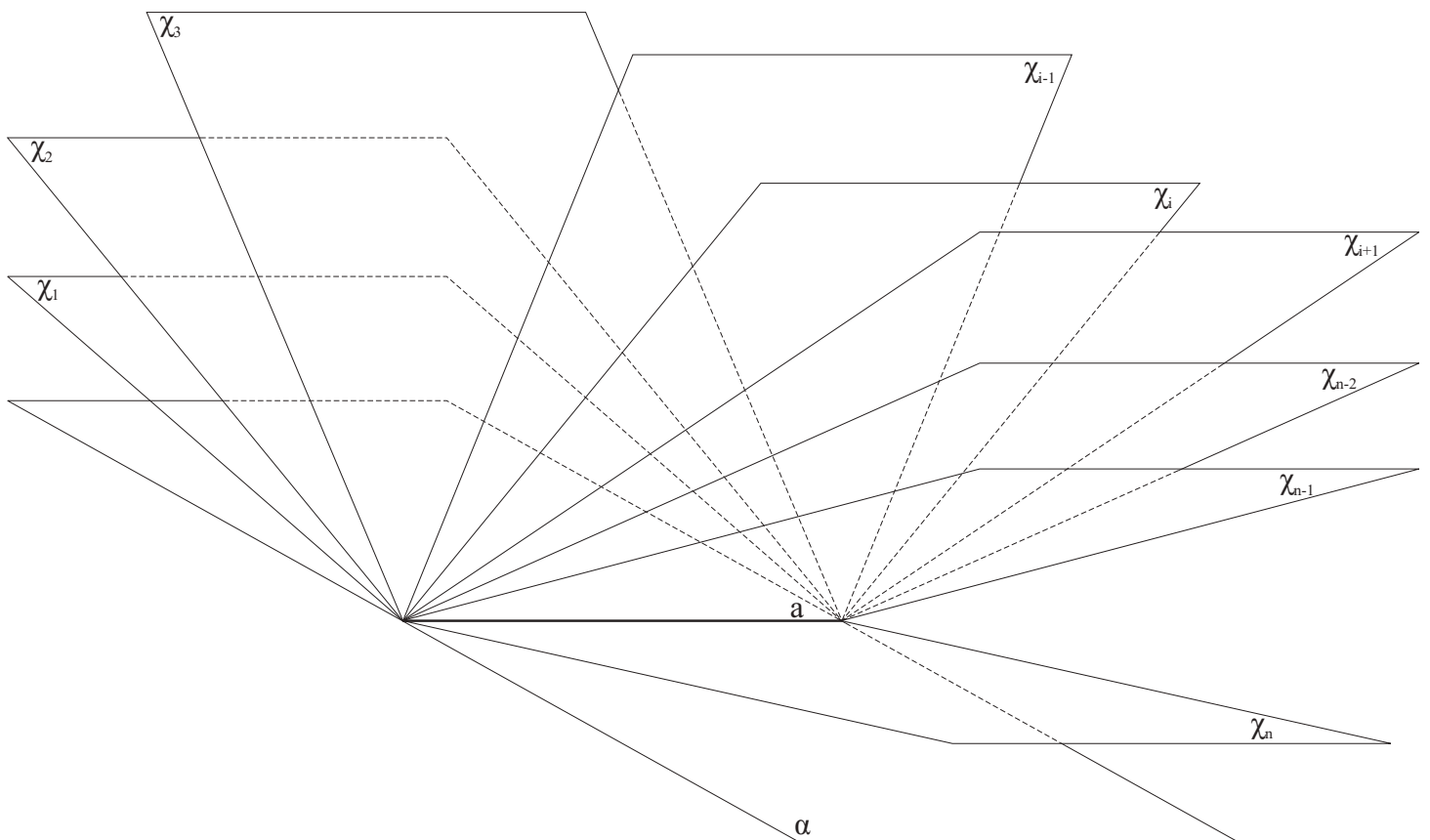

Figure 1.100: Suppose $\chi_1, \chi_2, \dots, \chi_n, (\dots)$ is a finite (countably infinite) sequence of half-planes of the pencil \mathfrak{J} with the property that a half-plane of the sequence lies between two other half-planes of the sequence if its number has an intermediate value between the numbers of these half-planes. Then the converse of this property is true, namely, that if a half-plane of the sequence lies inside the dihedral angle formed by two other half-planes of the sequence, its number has an intermediate value between the numbers of these two half-planes.

Let an infinite (finite) sequence of half-planes χ_i of the pencil \mathfrak{J} , where $i \in \mathbb{N}$ ($i \in \mathbb{N}_n$, $n \geq 4$), be numbered in such a way that, except for the first and the last, every half-plane lies inside the dihedral angle formed by the two half-planes of sequence with numbers, adjacent (in \mathbb{N}) to that of the given half-plane. Then:

Lemma 1.2.56.10. – *A half-plane from this sequence lies inside the dihedral angle formed by two other members of this sequence iff its number has an intermediate value between the numbers of these two half-planes.*

Lemma 1.2.56.11. – *An arbitrary half-plane of the pencil \mathfrak{J} cannot lie inside of more than one of the dihedral angles formed by pairs of half-planes of the sequence having adjacent numbers in the sequence.*

Lemma 1.2.56.12. – *In the case of a finite sequence, a half-plane which lies between the end (the first and the last, n^{th}) half-planes of the sequence, and does not coincide with the other half-planes of the sequence, lies inside at least one of the dihedral angles, formed by pairs of half-planes with adjacent numbers.*

Lemma 1.2.56.13. – *All of the open dihedral angular intervals $(\chi_i\chi_{i+1})$, where $i = 1, 2, \dots, n-1$, lie inside the open dihedral angular interval $(\chi_1\chi_n)$. In other words, any half-plane κ , lying inside any of the dihedral angles $\widehat{\chi_i, \chi_{i+1}}$, where $i = 1, 2, \dots, n-1$, lies inside the dihedral angle $\widehat{\chi_1, \chi_n}$, i.e. $\forall i \in \{1, 2, \dots, n-1\} \kappa \subset \text{Int}(\widehat{\chi_i, \chi_{i+1}}) \Rightarrow \kappa \subset \text{Int}(\widehat{\chi_1, \chi_n})$.*

Lemma 1.2.56.14. – *The half-open dihedral angular interval $[\chi_1\chi_n)$ is a disjoint union of the half-closed dihedral angular intervals $[\chi_i\chi_{i+1})$, where $i = 1, 2, \dots, n-1$:*

$$[\chi_1\chi_n) = \bigcup_{i=1}^{n-1} [\chi_i\chi_{i+1}).$$

Also,

The half-closed dihedral angular interval $(\chi_1\chi_n]$ is a disjoint union of the half-closed dihedral angular intervals $(\chi_i\chi_{i+1}]$, where $i = 1, 2, \dots, n-1$:

$$(\chi_1\chi_n] = \bigcup_{i=1}^{n-1} (\chi_i\chi_{i+1}].$$

Proof. \square

If a finite (infinite) sequence of half-planes χ_i of the pencil \mathfrak{J} , $i \in \mathbb{N}_n$, $n \geq 4$ ($n \in \mathbb{N}$) has the property that if a half-plane of the sequence lies inside the dihedral angle formed by two other half-planes of the sequence iff its number has an intermediate value between the numbers of these two half-planes, we say that the half-planes $\chi_1, \chi_2, \dots, \chi_n, (\dots)$ are in order $[\chi_1\chi_2 \dots \chi_n(\dots)]$.

Theorem 1.2.56. *Any finite sequence of half-planes $\chi_i \in \mathfrak{J}$, $i \in \mathbb{N}_n$, $n \geq 4$ can be renumbered in such a way that a half-plane from the sequence lies inside the dihedral angle formed by two other half-planes of the sequence iff its number has an intermediate value between the numbers of these two half-planes. In other words, any finite (infinite) sequence of half-planes $h_i \in \mathfrak{J}$, $i \in \mathbb{N}_n$, $n \geq 4$ can be put in order $[\chi_1\chi_2 \dots \chi_n]$.*

Lemma 1.2.56.12. *For any finite set of half-planes $\{\chi_1, \chi_2, \dots, \chi_n\}$ of an open dihedral angular interval $(\chi\kappa) \subset \mathfrak{J}$ there is a half-plane λ on $(\chi\kappa)$ not in that set.*

Proposition 1.2.56.13. *Every open dihedral angular interval in \mathfrak{J} contains an infinite number of half-planes.*

Corollary 1.2.56.14. *Every dihedral angular interval-like set in \mathfrak{J} contains an infinite number of half-planes.*

Basic Properties of Dihedral Angular Rays

Given a pencil \mathfrak{J} of half-planes lying on the same side of a plane α as a given point Q , and two distinct half-planes o , χ , $\chi \neq o$ of the pencil \mathfrak{J} , define the dihedral angular ray o_χ , emanating from its origin, or initial half-plane o , as the set of all half-planes $\kappa \neq o$ of the pencil \mathfrak{J} such that the half-plane o does not divide the half-planes χ , κ .²²³ That is, for $o, \chi \in \mathfrak{J}$, $o \neq \chi$, we define $o_\chi \Rightarrow \{\kappa | \kappa \subset \mathfrak{J} \& \kappa \neq o \& \neg[\chi o \kappa]\}$.²²⁴

Lemma 1.2.57.1. *Any half-plane χ lies on the dihedral angular ray o_χ .*

Lemma 1.2.57.2. *If a half-plane κ lies on a dihedral angular ray o_χ , the half-plane χ lies on the dihedral angular ray o_κ . That is, $\kappa \in o_\chi \Rightarrow \chi \in o_\kappa$.*

Lemma 1.2.57.3. *If a half-plane κ lies on a dihedral angular ray o_χ , the dihedral angular ray o_χ coincides with the dihedral angular ray o_κ .*

Lemma 1.2.57.4. *If dihedral angular rays o_χ and o_κ have common half-planes, they are equal.*

²²³i.e. the half-plane o does not lie inside the dihedral angle $\widehat{\chi\kappa}$.

²²⁴Note that, according to our definition, a dihedral angular ray is formed by half-planes instead of points! In a similar manner we could construct a "hyper-dihedral angular" ray formed by dihedral angular rays instead of points, rays, or half-planes. This hyper-dihedral angular ray would have essentially the same properties given by Pr 1.2.1 - Pr 1.2.7 as the types of rays already considered, but, on the other hand, it would definitely be too weird to allow any practical use.

Lemma 1.2.57.5. *The relation "to lie in the pencil \mathfrak{J} on the same side of a given half-plane $o \in \mathfrak{J}$ as" is an equivalence relation on $\mathfrak{J} \setminus \{o\}$. That is, it possesses the properties of:*

- 1) *Reflexivity: A half-plane h always lies on the same side of the half-plane o as itself;*
- 2) *Symmetry: If a half-plane κ lies on the same side of the half-plane o as χ , the half-plane χ lies on the same side of o as κ .*
- 3) *Transitivity: If a half-plane κ lies on the same side of the half-plane o as χ , and a half-plane λ lies on the same side of o as κ , then λ lies on the same side of o as χ .*

Lemma 1.2.57.6. *A half-plane κ lies on the opposite side of o from χ iff o divides χ and κ .*

Lemma 1.2.57.7. *The relation "to lie in the pencil \mathfrak{J} on the opposite side of the given half-plane o from ..." is symmetric.*

If a half-plane κ lies in the pencil \mathfrak{J} on the same side (on the opposite side) of the half-plane o as (from) a half-plane χ , in view of symmetry of the relation we say that the half-planes χ and κ lie in the set \mathfrak{J} on the same side (on opposite sides) of o .

Lemma 1.2.57.8. *If half-planes χ and κ lie on one dihedral angular ray $o_\chi \subset \mathfrak{J}$, they lie in the pencil \mathfrak{J} on the same side of the half-plane o . If, in addition, $\chi \neq \kappa$, then either χ lies between o and κ , or κ lies between o and χ .*

Lemma 1.2.57.9. *If a half-plane λ lies in the pencil \mathfrak{J} on the same side of the half-plane o as a half-plane χ , and a half-plane μ lies on the opposite side of o from χ , then the half-planes λ and μ lie on opposite sides of o .²²⁵*

Lemma 1.2.57.10. *If half-planes λ and μ lie in the pencil \mathfrak{J} on the opposite side of the half-plane o from a half-plane χ ,²²⁶ then λ and μ lie on the same side of o .*

Lemma 1.2.57.11. *Suppose a half-plane λ lies on a dihedral angular ray o_χ , a half-plane μ lies on a dihedral angular ray o_κ , and o lies between χ and κ . Then o also lies between λ and μ .*

Lemma 1.2.57.12. *A half-plane $o \in \mathfrak{J}$ divides half-planes $\chi \in \mathfrak{J}$ and $\kappa \in \mathfrak{J}$ iff the dihedral angular rays o_χ and o_κ are disjoint, $o_\chi \cap o_\kappa = \emptyset$, and their union, together with the ray o , gives the pencil \mathfrak{J} , i.e. $\mathfrak{J} = o_\chi \cup o_\kappa \cup \{o\}$. That is, $[\chi o \kappa] \Leftrightarrow (\mathfrak{J} = o_\chi \cup o_\kappa \cup \{o\}) \& (o_\chi \cap o_\kappa = \emptyset)$.*

Lemma 1.2.57.13. *A dihedral angular ray o_χ contains the open dihedral angular interval (o_χ) .*

Lemma 1.2.57.14. *For any finite set of half-planes $\{\chi_1, \chi_2, \dots, \chi_n\}$ of a dihedral angular ray o_χ , there is a half-plane λ on o_χ not in that set.*

Lemma 1.2.57.15. *If a half-plane κ lies between half-planes o and χ then the dihedral angular rays o_κ and o_χ are equal.*

Lemma 1.2.57.16. *If a half-plane χ lies between half-planes o and κ , the half-plane κ lies on the dihedral angular ray o_χ .*

Lemma 1.2.57.17. *If dihedral angular rays o_χ and o'_κ are equal, their origins coincide.*

Lemma 1.2.56.18. *If a dihedral angle (=abstract dihedral angular interval) $\widehat{\chi_0 \chi_n}$ is divided into n dihedral angles $\widehat{\chi_0 \chi_1}, \widehat{\chi_1 \chi_2}, \dots, \widehat{\chi_{n-1} \chi_n}$ (by the half-planes $\chi_1, \chi_2, \dots, \chi_{n-1}$),²²⁷ the half-planes $\chi_1, \chi_2, \dots, \chi_{n-1}, \chi_n$ all lie on the same side of the half-plane χ_0 , and the dihedral angular rays $\chi_0 \chi_1, \chi_0 \chi_2, \dots, \chi_0 \chi_n$ are equal.²²⁸*

Theorem 1.2.56. *Every dihedral angular ray contains an infinite number of half-planes.*

Linear Ordering on Dihedral Angular Rays

Suppose χ, κ are two half-planes on a dihedral angular ray o_μ . Let, by definition, $(\chi \prec \kappa)_{o_\mu} \stackrel{\text{def}}{\Leftrightarrow} [ohk]$. If $\chi \prec \kappa$,²²⁹ we say that the half-plane χ precedes the half-plane κ on the dihedral angular ray o_μ , or that the half-plane κ succeeds the half-plane χ on the dihedral angular ray o_μ .

Lemma 1.2.57.1. *If a half-plane χ precedes a half-plane κ on the dihedral angular ray o_μ , and κ precedes a half-plane λ on the same dihedral angular ray, then χ precedes λ on o_μ :*

$$\chi \prec \kappa \& \kappa \prec \lambda \Rightarrow \chi \prec \lambda, \text{ where } \chi, \kappa, \lambda \in o_\mu.$$

Proof. \square

²²⁵Making use of L 1.2.57.6, this statement can be reformulated as follows:

If a half-plane λ lies on o_χ , and o divides χ and μ , then o divides λ and μ .

²²⁶One could as well have said: If o lies between χ and λ , as well as between χ and μ ...

²²⁷In other words, a finite sequence of half-planes χ_i , where $i + 1 \in \mathbb{N}_{n-1}$, $n \geq 4$, has the property that every half-plane of the sequence, except for the first and the last, lies between the two half-planes with adjacent (in \mathbb{N}) numbers.

²²⁸By the same token, we can assert also that the half-planes $\chi_0, \chi_1, \dots, \chi_{n-1}$ lie on the same side of half-plane χ_n , but due to symmetry, this adds essentially nothing new to the statement of the lemma.

²²⁹In most instances in what follows we will assume the dihedral angular ray o_μ (or some other dihedral angular ray) fixed and omit the mention of it in our notation.

Lemma 1.2.57.2. *If χ, κ are two distinct half-planes on the dihedral angular ray o_μ then either χ precedes κ , or κ precedes χ ; if χ precedes κ then κ does not precede χ .*

Proof. \square

For half-planes χ, κ on a dihedral angular ray o_μ we let, by definition, $\chi \preceq \kappa \stackrel{\text{def}}{\iff} (\chi \prec \kappa) \vee (\chi = \kappa)$.

Theorem 1.2.57. *Every dihedral angular ray is a chain with respect to the relation \preceq .*

Line Ordering on Pencils of Half-Planes

Let $o \in \mathfrak{J}, \pi \in \mathfrak{J}, [\pi \wr \rho]$. Define the relation of direct (inverse) ordering on the pencil \mathfrak{J} of half-planes lying on the same side of a plane α as a given point Q , which admits a generalized betweenness relation, as follows:

Call o_π the first dihedral angular ray, and o_ρ the second dihedral angular ray. A half-plane χ precedes a half-plane κ in the pencil \mathfrak{J} in the direct (inverse) order iff:

- Both χ and κ lie on the first (second) dihedral angular ray and κ precedes χ on it; or
- χ lies on the first (second) dihedral angular ray, and κ lies on the second (first) dihedral angular ray or coincides with o ; or
- $\chi = o$ and κ lies on the second (first) dihedral angular ray; or
- Both χ and κ lie on the second (first) dihedral angular ray, and χ precedes κ on it.

Thus, a formal definition of the direct ordering on the pencil \mathfrak{J} can be written down as follows:

$$(\chi \prec_1 \kappa)_{\mathfrak{J}} \stackrel{\text{def}}{\iff} (\chi \in o_{\pi'} \& \kappa \in o_{\pi'} \& \kappa \prec \chi) \vee (\chi \in o_\pi \& \kappa = o) \vee (\chi \in o_\pi \& \kappa \in o_\rho) \vee (\chi = o \& \kappa \in o_\rho) \vee (\chi \in o_\rho \& \kappa \in o_\rho \& \chi \prec \kappa),$$

$$\text{and for the inverse ordering: } (\chi \prec_2 \kappa)_{\mathfrak{J}} \stackrel{\text{def}}{\iff} (\chi \in o_\rho \& \kappa \in o_\rho \& \kappa \prec \chi) \vee (\chi \in o_\rho \& \kappa = o) \vee (\chi \in o_\rho \& \kappa \in o_\pi) \vee (\chi = o \& \kappa \in o_\pi) \vee (\chi \in o_\pi \& \kappa \in o_\pi \& \chi \prec \kappa).$$

The term "inverse order" is justified by the following trivial

Lemma 1.2.58.1. *χ precedes κ in the inverse order iff κ precedes χ in the direct order.*

For our notion of order (both direct and inverse) on the pencil \mathfrak{J} to be well defined, they have to be independent, at least to some extent, on the choice of the origin o of the pencil \mathfrak{J} , as well as on the choice of the half-planes π and ρ , forming, together with the half-plane o , dihedral angular rays o_π and o_ρ , respectively.

Toward this end, let $o' \in \mathfrak{J}, \pi' \in \mathfrak{J}, [\pi' \wr \rho']$, and define a new direct (inverse) ordering with displaced origin (ODO) on the pencil \mathfrak{J} , as follows:

Call o' the displaced origin, $o'_{\pi'}$ and $o'_{\rho'}$ the first and the second displaced dihedral angular rays, respectively. A half-plane χ precedes a half-plane κ in the set \mathfrak{J} in the direct (inverse) ODO iff:

- Both χ and κ lie on the first (second) displaced dihedral angular ray, and κ precedes χ on it; or
- χ lies on the first (second) displaced dihedral angular ray, and κ lies on the second (first) displaced dihedral angular ray or coincides with o' ; or
- $\chi = o'$ and κ lies on the second (first) displaced dihedral angular ray; or
- Both χ and κ lie on the second (first) displaced dihedral angular ray, and χ precedes κ on it.

Thus, a formal definition of the direct ODO on the set \mathfrak{J} can be written down as follows:

$$(\chi \prec'_1 \kappa)_{\mathfrak{J}} \stackrel{\text{def}}{\iff} (\chi \in o'_{\pi'} \& \kappa \in o'_{\pi'} \& \kappa \prec \chi) \vee (\chi \in o'_{\pi'} \& \kappa = o') \vee (\chi \in o'_{\pi'} \& \kappa \in o'_{\rho'}) \vee (\chi = o' \& \kappa \in o'_{\rho'}) \vee (\chi \in o'_{\rho'} \& \kappa \in o'_{\rho'} \& \chi \prec \kappa),$$

$$\text{and for the inverse ordering: } (\chi \prec'_2 \kappa)_{\mathfrak{J}} \stackrel{\text{def}}{\iff} (\chi \in o'_{\rho'} \& \kappa \in o'_{\rho'} \& \kappa \prec \chi) \vee (\chi \in o'_{\rho'} \& \kappa = o') \vee (\chi \in o'_{\rho'} \& \kappa \in o'_{\pi'}) \vee (\chi = o' \& \kappa \in o'_{\pi'}) \vee (\chi \in o'_{\pi'} \& \kappa \in o'_{\pi'} \& \chi \prec \kappa).$$

Lemma 1.2.58.2. *If the origin o' of the displaced dihedral angular ray $o'_{\pi'}$ lies on the dihedral angular ray o_π and between o and π' , then the dihedral angular ray o_π contains the dihedral angular ray $o'_{\pi'}$, $o'_{\pi'} \subset o_\pi$.*

Lemma 1.2.58.3. *Let the displaced origin o' be chosen in such a way that o' lies on the dihedral angular ray o_π , and the half-plane o lies on the dihedral angular ray $o'_{\rho'}$. If a half-plane κ lies on both dihedral angular rays o_π and $o'_{\rho'}$, then it divides o and o' .*

Lemma 1.2.58.4. *An ordering with the displaced origin o' on a pencil \mathfrak{J} of half-planes lying on the same side of a plane α as a given point Q , which admits a generalized betweenness relation, coincides with either direct or inverse ordering on that pencil (depending on the choice of the displaced dihedral angular rays). In other words, either for all half-planes χ, κ in \mathfrak{J} we have that χ precedes κ in the ODO iff χ precedes κ in the direct order; or for all half-planes χ, κ in \mathfrak{J} we have that χ precedes κ in the ODO iff χ precedes κ in the inverse order.*

Lemma 1.2.58.5. *Let χ, κ be two distinct half-planes in a pencil \mathfrak{J} of half-planes lying on the same side of a plane α as a given point Q , which admits a generalized betweenness relation, and on which some direct or inverse order is defined. Then either χ precedes κ in that order, or κ precedes χ , and if χ precedes κ , κ does not precede χ , and vice versa.*

For half-planes χ, κ in a pencil \mathfrak{J} of half-planes lying on the same side of a plane α as a given point Q , which admits a generalized betweenness relation, and where some direct or inverse order is defined, we let $\chi \preceq_i \kappa \stackrel{\text{def}}{\iff} (\chi \prec_i \kappa) \vee (\chi = \text{kappa})$, where $i = 1$ for the direct order and $i = 2$ for the inverse order.

Theorem 1.2.58. *Every set \mathfrak{J} of half-planes lying on the same side of a plane α as a given point Q , which admits a generalized betweenness relation, and equipped with a direct or inverse order, is a chain with respect to the relation \preceq_i .*

Theorem 1.2.59. *If a half-plane κ lies between half-planes χ and λ , then in any ordering of the kind defined above, defined on the pencil \mathfrak{J} , containing these rays, either χ precedes κ and κ precedes λ , or λ precedes κ and κ precedes χ ; conversely, if in some order, defined on the pencil \mathfrak{J} of half-planes lying on the same side of a plane α as a given point Q , admitting a generalized betweenness relation and containing half-planes χ, κ, λ , we have that χ precedes κ and κ precedes λ , or λ precedes κ and κ precedes χ , then κ lies between χ and λ . That is,*

$$\forall \chi, \kappa, \lambda \in \mathfrak{J} [\chi \kappa \lambda] \Leftrightarrow (\chi \prec \kappa \ \& \ \kappa \prec \lambda) \vee (\lambda \prec \kappa \ \& \ \kappa \prec \chi).$$

Complementary Dihedral Angular Rays

Lemma 1.2.60.1. *An dihedral angular interval $(o\chi)$ is the intersection of the dihedral angular rays o_χ and χ_o , i.e. $(o\chi) = o_\chi \cap \chi_o$.*

Given a dihedral angular ray o_χ , define the dihedral angular ray o_χ^c , complementary in the pencil \mathfrak{J} to the dihedral angular ray o_χ , as $o_\chi^c = \mathfrak{J} \setminus (\{o\} \cup o_\chi)$. In other words, the dihedral angular ray o_χ^c , complementary to the dihedral angular ray o_χ , is the set of all half-planes lying in the pencil \mathfrak{J} on the opposite side of the half-plane o from the half-plane χ . An equivalent definition is provided by

Lemma 1.2.60.2. $o_\chi^c = \{\kappa \mid [\kappa o \chi]\}$. We can also write $o_\chi^c = o_\mu$ for any half-plane $\mu \in \mathfrak{J}$ such that $[\mu o \chi]$.

Lemma 1.2.60.3. *The dihedral angular ray $(o_\chi^c)^c$, complementary to the dihedral angular ray o_χ^c , complementary to the given dihedral angular ray o_h , coincides with the dihedral angular ray o_χ : $(o_\chi^c)^c = o_\chi$.*

Lemma 1.2.60.4. *Given a half-plane λ on an dihedral angular ray o_χ , the dihedral angular ray o_χ is a disjoint union of the half-open dihedral angular interval $(o\lambda]$ and the dihedral angular ray λ_o^c , complementary to the dihedral angular ray λ_o :*

$$o_h = (o\lambda] \cup \lambda_o^c.$$

Lemma 1.2.60.5. *Given in a pencil \mathfrak{J} of half-planes lying on the same side of a plane α as a given point Q , which admits a generalized betweenness relation, a half-plane κ , distinct from a half-plane $o \in \mathfrak{J}$, the half-plane κ lies either on o_χ or on o_χ^c , where $\chi \in \mathfrak{J}$, $\chi \neq o$.*

Theorem 1.2.60. *Let a finite sequence of half-planes $\chi_1, \chi_2, \dots, \chi_n$, $n \in \mathbb{N}$, from the pencil \mathfrak{J} , be numbered in such a way that, except for the first and (in the finite case) the last, every half-plane lies between the two half-planes with adjacent (in \mathbb{N}) numbers. Then the dihedral angular ray $\chi_{1\chi_n}$ is a disjoint union of half-closed dihedral angular intervals $(\chi_i \chi_{i+1}]$, $i = 1, 2, \dots, n-1$, with the dihedral angular ray $\chi_{n\chi_k}^c$, complementary to the dihedral angular ray $\chi_{n\chi_k}$, where $k \in \{1, 2, \dots, n-1\}$, i.e.*

$$\chi_{1\chi_n} = \bigcup_{i=1}^{n-1} (\chi_i \chi_{i+1}] \cup \chi_{n\chi_k}^c.$$

Sets of Half-Planes on Dihedral Angular Rays

Given a half-plane o in a pencil \mathfrak{J} of half-planes lying on the same side of a plane α as a given point Q , which admits a generalized betweenness relation, a nonempty set $\mathfrak{B} \subset \mathfrak{J}$ is said to lie in the pencil \mathfrak{J} on the same side (on the opposite side) of the ray o as (from) a nonempty set $\mathfrak{A} \subset \mathfrak{J}$ iff for all half-planes $\chi \in \mathfrak{A}$ and all half-planes $\kappa \in \mathfrak{B}$, the half-plane κ lies on the same side (on the opposite side) of the half-plane o as (from) the half-plane $\chi \in \mathfrak{A}$. If the set \mathfrak{A} (the set \mathfrak{B}) consists of a single element, we say that the set \mathfrak{B} (the half-plane κ) lies in the pencil \mathfrak{J} on the same side of the half-plane o as the half-plane χ (the set \mathfrak{A}).

Lemma 1.2.61.1. *If a set $\mathfrak{B} \subset \mathfrak{J}$ lies in the pencil \mathfrak{J} on the same side of the half-plane o as a set $\mathfrak{A} \subset \mathfrak{J}$, then the set \mathfrak{A} lies in the pencil \mathfrak{J} on the same side of the half-plane o as the set \mathfrak{B} .*

Lemma 1.2.61.2. *If a set $\mathfrak{B} \subset \mathfrak{J}$ lies in the pencil \mathfrak{J} on the same side of the half-plane o as a set $\mathfrak{A} \subset \mathfrak{J}$, and a set $\mathfrak{C} \subset \mathfrak{J}$ lies in the set \mathfrak{J} on the same side of the half-plane o as the set \mathfrak{B} , then the set \mathfrak{C} lies in the pencil \mathfrak{J} on the same side of the half-plane o as the set \mathfrak{A} .*

Lemma 1.2.61.3. *If a set $\mathfrak{B} \subset \mathfrak{J}$ lies in the set \mathfrak{J} on the opposite side of the half-plane o from a set $\mathfrak{A} \subset \mathfrak{J}$, then the set \mathfrak{A} lies in the set \mathfrak{J} on the opposite side of the half-plane o from the set \mathfrak{B} .*

In view of symmetry of the relations, established by the lemmas above, if a set $\mathfrak{B} \subset \mathfrak{J}$ lies in the pencil \mathfrak{J} on the same side (on the opposite side) of the half-plane o as a set (from a set) $\mathfrak{A} \subset \mathfrak{J}$, we say that the sets \mathfrak{A} and \mathfrak{B} lie in the pencil \mathfrak{J} on one side (on opposite sides) of the half-plane o .

Lemma 1.2.61.4. *If two distinct half-planes χ, κ lie on an dihedral angular ray o_λ , the open dihedral angular interval $(\chi\kappa)$ also lies on the dihedral angular ray o_λ .*

Given a dihedral angle $\widehat{\chi\kappa}$,²³⁰ whose sides χ, κ both lie in the pencil \mathfrak{J} , such that the open dihedral angular interval $(\chi\kappa)$ does not contain $o \in \mathfrak{J}$, we have (L 1.2.61.5 - L 1.2.61.7):

Lemma 1.2.61.5. *– If one of the ends of $(\chi\kappa)$ lies on the dihedral angular ray o_λ , the other end is either on o_λ or coincides with o .*

Lemma 1.2.61.6. *– If (hk) has half-planes in common with the dihedral angular ray o_λ , either both ends of $(\chi\kappa)$ lie on o_λ , or one of them coincides with o .*

Lemma 1.2.61.7. *– If $(\chi\kappa)$ has common points with the dihedral angular ray o_λ , the interval $(\chi\kappa)$ lies on o_λ , $(\chi\kappa) \subset o_\lambda$.*

Lemma 1.2.61.8. *If χ and κ lie on one dihedral angular ray o_λ , the complementary dihedral angular rays χ_o^c and κ_o^c lie in the pencil \mathfrak{J} on one side of the half-plane o .*

Theorem 1.2.61. *A half-plane o in a pencil \mathfrak{J} of half-planes lying on the same side of a plane α as a given point Q , which admits a generalized betweenness relation, separates the rest of the half-planes in this pencil into two non-empty classes (dihedral angular rays) in such a way that...*

Properties of Convex Polygons

A polygon $A_1A_2 \dots A_n$ is called convex iff for any side A_iA_{i+1} for $i = 1, 2, \dots, n$ (where, of course, $A_{n+1} = A_1$) the set $\mathcal{P} \setminus [A_iA_{i+1}]$ lies completely on one side of the line $a_{A_iA_{i+1}}$.²³¹

Lemma 1.2.62.1. *Every triangle is a convex polygon.*

Proof. \square

Lemma 1.2.62.2. *Suppose that a polygon $A_1A_2 \dots A_n$, $n \geq 4$, has the following property: for any side A_iA_{i+1} for $i = 1, 2, \dots, n$ (where, of course, $A_{n+1} = A_1$) the remaining vertices of the polygon lie on the same side of the corresponding line $a_{A_iA_{i+1}}$. Then the polygon is convex.*

Proof. Follows from L 1.2.19.9. \square

Lemma 1.2.62.3. *If points A, C lie on opposite sides of the line a_{BD} , and B, D lie on opposite sides of a_{AC} , then the quadrilateral $ABCD$ is convex.*²³²

Proof. According to T 1.2.41, the diagonals (AC) , (BD) meet in a point O . The result is then easily seen using L 1.2.21.6, L 1.2.21.4 and the definition of interior of the angle. \square

Lemma 1.2.62.4. *Suppose $A_1A_2 \dots A_n$, where $n \geq 4$, is a convex polygon, where the vertices A_k, A_l are both adjacent to the vertex A_i . Then for any other vertex A_j (distinct from A_i, A_k, A_l) of the same polygon the ray A_iA_j lies completely inside the angle $\angle A_kA_iA_l$.*²³³

Proof. Follows directly from the definitions of convexity and the interior of angle.²³⁴ \square

Lemma 1.2.62.5. *Consider a trapezoid $ABCD$ with $a_{BC} \parallel a_{AD}$. If the vertices C, D lie on one side of the line a_{AB} formed by the other two vertices,²³⁵ then $ABCD$ is convex.*²³⁶

Proof. See C 1.2.47.4, L 1.2.62.3. \square

Theorem 1.2.62. *Every convex polygon is simple.*

Proof. \square

²³⁰In unified terms, an abstract dihedral angular interval.

²³¹This is a rather unfortunate piece of terminology in that it seems to be at odds with the definition of convex point set. Apparently, this definition is related to the fact (proved) below that the interior of a convex polygon does form a convex set.

²³²Thus, $ABCD$ is convex, in particular, if its diagonals (AC) , (BD) meet (see beginning of proof).

²³³Note also that the result, converse to the preceding lemma, is true: If a quadrilateral $ABCD$ is convex, then the points A, C lie on opposite sides of the line a_{BD} , and B, D lie on opposite sides of a_{AC} .

²³⁴Indeed, from convexity the vertices A_j, A_l lie on the same side of the line $a_{A_iA_k}$ and A_j, A_k lie on the same side of the line $a_{A_iA_l}$. Hence $A_j \subset \text{Int}\angle A_kA_iA_l$ by the definition of interior and, finally, $A_iA_j \subset \text{Int}\angle A_kA_iA_l$ by L 1.2.21.4.

²³⁵It is evident that due to symmetry we could alternatively assume that the vertices A, B lie on the line a_{CD} .

²³⁶It should be noted that we do not assume here that $ABCD$ is simple. This will follow from C 1.2.47.4.

Consider two non-adjacent vertices A_i, A_j of a polygon $A_1A_2 \dots A_n$ (assuming the polygon in question does have two non-adjacent vertices; this obviously cannot be the case for a triangle), there are evidently two open paths with A_i, A_j as the ends. We shall refer to these paths as the (open) separation paths generated by A_i, A_j and associated with the polygon $A_1A_2 \dots A_n$, and denote them $Path1(A_1A_2 \dots A_n)$ and $Path2(A_1A_2 \dots A_n)$, the choice of numbers 1, 2 being entirely coincidental. Sometimes (whenever it is well understood which polygon is being considered) we shall omit the parentheses.

Consider two non-adjacent vertices A_i, A_j of a convex polygon $A_1A_2 \dots A_n$.

Lemma 1.2.63.1. *The open interval (A_iA_j) does not meet either of the separation paths (generated by A_i, A_j and associated with $A_1A_2 \dots A_n$).²³⁷*

Proof. Consider one of the separation paths, say, $Path1$. Suppose the contrary to what is stated by the lemma, i.e. that the open interval (A_iA_j) meets the side-line $[A_kA_l]$ of $Path1$. This means that the points A_i, A_j lie on the opposite sides of the line $a_{A_kA_l}$,²³⁸ which contradicts the convexity of the polygon $A_1A_2 \dots A_n$. This contradiction shows that in reality (A_iA_j) does not meet $Path1$ (and by the same token it does not meet $Path2$). \square

Lemma 1.2.63.2. *The separation paths $Path1, Path2$ lie on opposite sides of the line $a_{A_iA_j}$.*

Proof. Suppose the contrary, i.e. that the paths $Path1, Path2$ lie on the same side of the line $a_{A_iA_j}$.²³⁹ Consider the vertices A_k, A_l of $Path1, Path2$, respectively, adjacent on the polygon $A_1A_2 \dots A_n$ to A_i . Using L 1.2.21.21, we can assume without loss of generality that the ray A_k lies inside the angle $\angle A_jA_iA_l$. But this implies that the vertices A_j, A_l of the polygon $A_1A_2 \dots A_n$ lie on opposite sides of the line $a_{A_iA_k}$ containing the side A_iA_k , which contradicts the convexity of $A_1A_2 \dots A_n$. \square

Lemma 1.2.63.3. *Straightening of convex polygons preserves their convexity.*

Proof. We need to show that for any side of the new polygon the remaining vertices lie on the same side of the line containing that side. This is obvious for all sides except the one formed as the result of straightening. (In fact, straightening can only reduce the number of sides for which the condition of convexity must be satisfied.) But for the latter this is an immediate consequence of L 1.2.63.1. Indeed, given the side A_iA_j resulting from straightening, the remaining vertices of the new polygon are also vertices of one of the separation paths generated by A_i, A_j , associated with the original polygon $A_1A_2 \dots A_n$. \square

Lemma 1.2.63.4. *If vertices A_p, A_q lie on different separation paths (generated by A_i, A_j) then the ray A_iA_j (in particular, the point A_j and the open interval (A_iA_j)) lies completely inside the angle $\angle A_pA_iA_q$.*

Proof. Follows from L 1.2.63.3, L 1.2.62.4.²⁴⁰ \square

Consider a path $A_1A_2 \dots A_n$ ²⁴¹ (in particular, a polygon) and a connected collinear set \mathcal{A} .

We shall define a single instance of traversal of the path $A_1A_2 \dots A_n$ by the set \mathcal{A} , or, which is by definition the same, a single instance of traversal of the set \mathcal{A} by the path $A_1A_2 \dots A_n$ as one of the following situations taking place:

- (Type I traversal): A point $A \in \mathcal{A}$ lies on the side A_iA_{i+1} of the path and this is the only point that the set and the side have in common;
- (Type II traversal): A vertex A_i lies in the set \mathcal{A} , and the adjacent vertices A_{i-1}, A_{i+1} lie on opposite sides of the line containing the set \mathcal{A} .
- (Type III traversal): Vertices A_i, A_{i+1} lie in the set \mathcal{A} , and the vertices A_{i-1}, A_{i+2} lie on opposite sides of the line containing the set \mathcal{A} .

²⁴²

Lemma 1.2.63.5. *Proof.* \square

Theorem 1.2.64. *Proof.* \square

²³⁷Thus, it follows that each path lies completely on one side of the line $a_{A_iA_j}$, although we have yet to prove that the paths lie on opposite sides of the line $a_{A_iA_j}$ (this proof will be done in the next lemma).

²³⁸Obviously, the points A_i, A_j, A_k, A_l cannot be all collinear.

²³⁹In this proof we implicitly use the results of the preceding lemma (L 1.2.63.1) and T 1.2.20.

²⁴⁰Here are some details: Performing successive straightening operations, we turn the polygon $A_1A_2 \dots A_n$ into the (convex according to L 1.2.63.3) quadrilateral $A_iA_pA_jA_q$ (it takes up to four straightenings). Using L 1.2.62.4 we then conclude that $A_iA_j \subset \text{Int}\angle A_kA_iA_l$.

²⁴¹In a polygon $A_1A_2 \dots A_n$, i.e. in a path $A_1A_2 \dots A_nA_{n+1}$ with $A_{n+1} = A_1$ we shall use the following notation wherever it is believed to lead to excessive confusion: $A_{n+2} \doteq A_2, A_{n+3} \doteq A_3, \text{ldots}$. While sacrificing some pedantry, this notation saves us much hassle at the place where "the snake bites at its tail".

²⁴²Observe that there are certain requirements on the minimum number of sides the polygon must possess in order to make a traversal of the given type: While traversals of the first type can happen to a digon, it takes a triangle to have a traversal of the second type and a quadrilateral for a traversal of the third type.

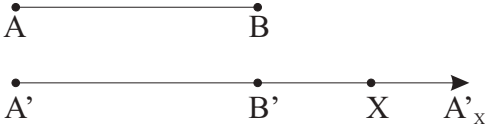

Figure 1.101: Given an interval AB , on any ray A'_x , there is a point B' such that $AB \equiv A'B'$.

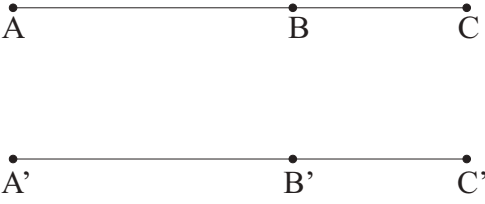

Figure 1.102: If intervals AB, BC are congruent to $A'B', B'C'$, B lies between A, C and B' lies between A', C' , the interval AC is congruent to $A'C'$.

1.3 Congruence

Hilbert's Axioms of Congruence

The axioms A 1.3.1 – A 1.3.3 define the relation of congruence on the class of intervals, i.e. for all two - element point sets: $\rho \subset \{\{A, B\} | A, B \in \mathcal{C}^{Pt}\}^2$. If a pair $(AB, CD) \in \rho$, we say that the interval AB is congruent to the interval CD and write $AB \equiv CD$. The axiom A 1.3.4 defines the relation of congruence on the class of all angles. If angles $\angle(h, k)$ and $\angle(l, m)$ are in this relation, we say that the angle $\angle(h, k)$ is congruent to the angle $\angle(l, m)$ and write $\angle(h, k) \equiv \angle(l, m)$.

Axiom 1.3.1. *Given an interval AB , on any ray A'_x , there is a point B' such that AB is congruent to the interval $A'B'$, $AB \equiv A'B'$. (See Fig. 1.101.)*

Axiom 1.3.2. *If intervals $A'B'$ and $A''B''$ are both congruent to the same interval AB , the interval $A'B'$ is congruent to the interval $A''B''$. That is, $A'B' \equiv AB \ \& \ A''B'' \equiv AB \Rightarrow A'B' \equiv A''B''$.*

Axiom 1.3.3. *If intervals AB, BC are congruent to intervals $A'B', B'C'$, respectively, where the point B lies between the points A and C and the point B' lies between A' and C' , then the interval AC is congruent to the interval $A'C'$. That is, $AB \equiv A'B' \ \& \ BC \equiv B'C' \Rightarrow AC \equiv A'C'$. (See Fig. 1.102)*

Axiom 1.3.4. *Given an angle $\angle(h, k)$, for any ray h' in a plane $\alpha' \supset h'$ containing this ray, and for any point $A \in \mathcal{P}_{\alpha'} \setminus \mathcal{P}_{\bar{h}}$, there is exactly one ray k' with the same origin O' as h' , such that the ray k' lies in α' on the same side of h' as A , and the angle $\angle(h, k)$ is congruent to the angle $\angle(h', k')$.*

Every angle is congruent to itself: $\angle(h, k) \equiv \angle(h, k)$.

A point set \mathcal{A} is said to be pointwise congruent, or isometric, to a point set \mathcal{B} , written $\mathcal{A} \equiv \mathcal{B}$, iff there is a bijection $\phi : \mathcal{A} \rightarrow \mathcal{B}$, called isometry, congruence, or (rigid) motion, or which maps (abstract) intervals formed by points of the set \mathcal{A} to congruent intervals formed by points of the set \mathcal{B} : for all $A_1, A_2 \in \mathcal{A}$ such that $A_1 \neq A_2$, we have $A_1A_2 \equiv B_1B_2$, where $B_1 = \phi(A_1)$, $B_2 = \phi(A_2)$. Observe that, by definition, all motions are injective, i.e. they transform distinct points into distinct points.

A finite (countably infinite) sequence of points A_i , where $i \in \mathbb{N}_n$ ($i \in \mathbb{N}$), $n \geq 2$, is said to be congruent to a finite (countably infinite) sequence of points B_i , where $i \in \mathbb{N}_n$ ($i \in \mathbb{N}$), if every interval A_iA_j , $i \neq j$, $i, j \in \mathbb{N}_n$ ($i, j \in \mathbb{N}$) formed by a pair of points from the first sequence, is congruent to the corresponding (i.e. formed by the points with the same numbers) interval B_iB_j , $i \neq j$, $i, j \in \mathbb{N}_n$ ($i, j \in \mathbb{N}$) formed by a pair of points of the second sequence.

A path $A_1A_2 \dots A_n$, in particular, a polygon, is said to be weakly congruent to a path $B_1B_2 \dots B_m$ (we write this as $A_1A_2 \dots A_n \simeq B_1B_2 \dots B_m$) iff $m = n$ ²⁴³ and each side of the first path is congruent to the corresponding²⁴⁴ side of the second path. That is,

$$A_1A_2 \dots A_n \simeq B_1B_2 \dots B_m \stackrel{\text{def}}{\iff} (m = n) \ \& \ (\forall i \in \mathbb{N}_{n-1} \ A_iA_{i+1} \equiv B_iB_{i+1}).$$

A path $A_1A_2 \dots A_n$, in particular, a polygon, is said to be congruent to a path $B_1B_2 \dots B_m$, written $A_1A_2 \dots A_n \equiv B_1B_2 \dots B_m$, iff

- the path $A_1A_2 \dots A_n$ is weakly congruent to the path $B_1B_2 \dots B_n$; and

²⁴³Thus, only paths with equal number of vertices (and, therefore, of sides), can be weakly congruent.

²⁴⁴i.e., formed by vertices with the same numbers as in the first path

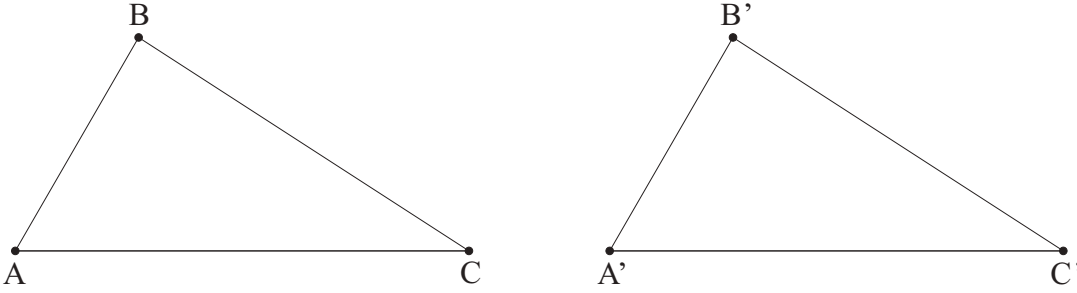

Figure 1.103: Congruences $AB \equiv A'B'$, $AC \equiv A'C'$, $\angle BAC \equiv \angle B'A'C'$ imply $\angle ABC \equiv \angle A'B'C'$.

– each angle between adjacent sides of the first path is congruent to the corresponding angle²⁴⁵ between adjacent sides of the second path. That is,

$$A_1A_2 \dots A_n \equiv B_1B_2 \dots B_n \stackrel{\text{def}}{\iff} A_1A_2 \dots A_n \simeq B_1B_2 \dots B_n \ \& \\ (\forall i \in \{2, 3, \dots, n-1\} \ \angle A_{i-1}A_iA_{i+1} \equiv \angle B_{i-1}B_iB_{i+1}) \ \& (A_1 = A_n \ \& \ B_1 = B_n \Rightarrow \angle A_{n-1}A_nA_2 \equiv \angle B_{n-1}B_nB_2).$$

A path $A_1A_2 \dots A_n$ is said to be strongly congruent to a path $B_1B_2 \dots B_n$, written $A_1A_2 \dots A_n \cong B_1B_2 \dots B_n$, iff the contour of $A_1A_2 \dots A_n$ is pointwise congruent to the contour of $B_1B_2 \dots B_n$. That is,

$$A_1A_2 \dots A_n \cong B_1B_2 \dots B_n \stackrel{\text{def}}{\iff} \mathcal{P}_{A_1A_2 \dots A_n} = \mathcal{P}_{B_1B_2 \dots B_n}$$

Axiom 1.3.5. *Given triangles $\triangle ABC$, $\triangle A'B'C'$, congruences $AB \equiv A'B'$, $AC \equiv A'C'$, $\angle BAC \equiv \angle B'A'C'$ imply $\angle ABC \equiv \angle A'B'C'$. (See Fig. 1.103)*

Basic Properties of Congruence

Lemma 1.3.1.1. *Given triangles $\triangle ABC$, $\triangle A'B'C'$, congruences $AB \equiv A'B'$, $AC \equiv A'C'$, $\angle BAC \equiv \angle B'A'C'$ imply $\angle ACB \equiv \angle A'C'B'$.²⁴⁶ (See Fig. 1.103)*

Proof. Immediately follows from A 1.3.5. \square

Theorem 1.3.1. *Congruence is an equivalence relation on the class of all (abstract) intervals, i.e., it is reflexive, symmetric, and transitive.*

Proof. Given an interval AB , by A 1.3.1 $\exists A'B' \ AB \equiv A'B'$.

Reflexivity: $AB \equiv A'B' \ \& \ AB \equiv A'B' \xrightarrow{A1.3.2} AB \equiv AB$.²⁴⁷

Symmetry: $A'B' \equiv A'B' \ \& \ AB \equiv A'B' \xrightarrow{A1.3.2} A'B' \equiv AB$.

Transitivity: $AB \equiv A'B' \ \& \ A'B' \equiv A''B'' \Rightarrow A'B' \equiv AB \ \& \ A'B' \equiv A''B'' \xrightarrow{A1.3.2} AB \equiv A''B''$. \square

Corollary 1.3.1.2. *Congruence of geometric figures is an equivalence relation (on the class of all geometric figures.) Congruence of finite or countably infinite sequences is an equivalence relation (on the class of all such sequences.) Weak congruence is an equivalence relation (on the class of all paths (in particular, polygons.)) That is, all these relations have the properties of reflexivity, symmetry, and transitivity.*

Proof. \square

Owing to symmetry, implied by T 1.3.1, of the relation of congruence of intervals, if $A_1A_2 \equiv B_1B_2$, i.e. if the interval A_1A_2 is congruent to the interval B_1B_2 , we can say also that the intervals A_1A_2 and B_1B_2 are congruent.

Similarly, because of C 1.3.1.2, if $A_1A_2 \dots A_n \simeq B_1B_2 \dots B_n$ instead of saying that the path $A_1A_2 \dots A_n$ is weakly congruent to the path $B_1B_2 \dots B_n$, one can say that the paths $A_1A_2 \dots A_n$, $B_1B_2 \dots B_n$ are weakly congruent (to each other).

The following simple technical facts will allow us not to worry too much about how we denote paths, especially polygons, in studying their congruence.

Proposition 1.3.1.3. *If a path (in particular, a polygon) $A_1A_2A_3 \dots A_{n-1}A_n$ is weakly congruent to a path (in particular, a polygon) $B_1B_2B_3 \dots B_{n-1}B_n$, the paths $A_2A_3 \dots A_{n-1}A_nA_1$ and $B_2B_3 \dots B_{n-1}B_nB_1$ are also weakly congruent, as are the paths $A_3A_4 \dots A_nA_1A_2$ and $B_3B_4 \dots B_nB_1B_2$, \dots , $A_nA_1 \dots A_{n-2}A_{n-1}$ and $B_nB_1 \dots B_{n-2}B_{n-1}$. Furthermore, the paths $A_nA_{n-1}A_{n-2} \dots A_2A_1$ and $B_nB_{n-1}B_{n-2} \dots B_2B_1$, $A_{n-1}A_{n-2} \dots A_2A_1A_n$ and $B_{n-1}B_{n-2} \dots B_2B_1B_n$, \dots , $A_1A_nA_{n-1} \dots A_3A_2$ and $B_1B_nB_{n-1} \dots B_3B_2$ are then weakly congruent as well. Written more formally, if*

²⁴⁵i.e., formed by sides made of pairs of vertices with the same numbers as in the first path

²⁴⁶For convenience, in what follows we shall usually refer to A 1.3.5 instead of L 1.3.1.1.

²⁴⁷The availability of an interval $A'B'$ with the property $AB \equiv A'B'$ is guaranteed by A 1.3.1.

a path (in particular, a polygon) $A_1A_2A_3\dots A_{n-1}A_n$ is weakly congruent to a path (in particular, a polygon) $B_1B_2B_3\dots B_{n-1}B_n$, the paths $A_{\sigma(1)}A_{\sigma(2)}\dots A_{\sigma(n-1)}A_{\sigma(n)}$ and $B_{\sigma(1)}B_{\sigma(2)}\dots B_{\sigma(n-1)}A_{\sigma(n)}$ are also weakly congruent, and more generally, the paths $A_{\sigma^k(1)}A_{\sigma^k(2)}\dots A_{\sigma^k(n-1)}A_{\sigma^k(n)}$ and $B_{\sigma^k(1)}B_{\sigma^k(2)}\dots B_{\sigma^k(n-1)}B_{\sigma^k(n)}$ are weakly congruent, where σ is the permutation

$$\sigma = \begin{pmatrix} 1 & 2 & \dots & n-1 & n \\ 2 & 3 & \dots & n & 1 \end{pmatrix},$$

i.e. $\sigma(i) = i + 1, i = 1, 2, \dots, n-1, \sigma(n) = 1$, and $k \in \mathbb{N}$. Furthermore, the paths $A_{\tau^k(1)}A_{\tau^k(2)}\dots A_{\tau^k(n-1)}A_{\tau^k(n)}$ and $B_{\tau^k(1)}B_{\tau^k(2)}\dots B_{\tau^k(n-1)}B_{\tau^k(n)}$ are weakly congruent, where τ is the permutation

$$\tau = \sigma^{-1} = \begin{pmatrix} 1 & 2 & \dots & n-1 & n \\ n & 1 & \dots & n-2 & n-1 \end{pmatrix},$$

i.e. $\tau(1) = n, \tau(i) = i - 1, i = 2, 3, \dots, n$, and $k \in \{0\} \cup \mathbb{N}$.

Proposition 1.3.1.4. *If a polygon $A_1A_2A_3\dots A_{n-1}A_n$ (i.e., a path $A_1A_2\dots A_nA_{n+1}$ with $A_{n+1} = A_1$) is congruent to a polygon $B_1B_2B_3\dots B_{n-1}B_n$ (i.e., a path $B_1B_2\dots B_nB_{n+1}$ with $B_{n+1} = B_1$), the polygon $A_2A_3\dots A_{n-1}A_nA_1$ is congruent to the polygon $B_2B_3\dots B_{n-1}B_nB_1$, and $A_3A_4\dots A_nA_1A_2$ is congruent to $B_3B_4\dots B_nA_1A_2$, ..., $A_nA_1\dots A_{n-2}A_{n-1}$ is congruent to $B_nB_1\dots B_{n-2}B_{n-1}$. Furthermore, the polygon $A_nA_{n-1}A_{n-2}\dots A_2A_1$ is congruent to the polygon $B_nB_{n-1}B_{n-2}\dots B_2B_1$, $A_{n-1}A_{n-2}\dots A_2A_1A_n$ is congruent to $B_{n-1}B_{n-2}\dots B_2B_1B_n$, ..., $A_1A_nA_{n-1}\dots A_3A_2$ is congruent to $B_1B_nB_{n-1}\dots B_3B_2$. Written more formally, if a polygon $A_1A_2A_3\dots A_{n-1}A_n$ is congruent to a polygon $B_1B_2B_3\dots B_{n-1}B_n$, the polygon $A_{\sigma(1)}A_{\sigma(2)}\dots A_{\sigma(n-1)}A_{\sigma(n)}$ is congruent to the polygon $B_{\sigma(1)}B_{\sigma(2)}\dots B_{\sigma(n-1)}A_{\sigma(n)}$, and more generally, the polygon $A_{\sigma^k(1)}A_{\sigma^k(2)}\dots A_{\sigma^k(n-1)}A_{\sigma^k(n)}$ is congruent to the polygon $B_{\sigma^k(1)}B_{\sigma^k(2)}\dots B_{\sigma^k(n-1)}B_{\sigma^k(n)}$, where σ is the permutation*

$$\sigma = \begin{pmatrix} 1 & 2 & \dots & n-1 & n \\ 2 & 3 & \dots & n & 1 \end{pmatrix},$$

i.e. $\sigma(i) = i + 1, i = 1, 2, \dots, n-1, \sigma(n) = 1$, and $k \in \mathbb{N}$. Furthermore, the polygon $A_{\tau^k(1)}A_{\tau^k(2)}\dots A_{\tau^k(n-1)}A_{\tau^k(n)}$ is congruent to the polygon $B_{\tau^k(1)}B_{\tau^k(2)}\dots B_{\tau^k(n-1)}B_{\tau^k(n)}$, where τ is the permutation

$$\tau = \sigma^{-1} = \begin{pmatrix} 1 & 2 & \dots & n-1 & n \\ n & 1 & \dots & n-2 & n-1 \end{pmatrix},$$

i.e. $\tau(1) = n, \tau(i) = i - 1, i = 2, 3, \dots, n$, and $k \in \{0\} \cup \mathbb{N}$.

Proposition 1.3.1.5. *Suppose finite sequences of n points A_1, A_2, \dots, A_n and B_1, B_2, \dots, B_n , where $n \geq 3$, have the property that every point of the sequence, except the first (A_1, B_1) and the last (A_n, B_n , respectively), lies between the two points of the sequence with the numbers adjacent (in \mathbb{N}) to the number of the given point. Then if all intervals formed by pairs of points of the sequence A_1, A_2, \dots, A_n with adjacent (in \mathbb{N}) numbers are congruent to the corresponding intervals²⁴⁸ of the sequence B_1, B_2, \dots, B_n , the intervals formed by the first and the last points of the sequences are also congruent, $A_1A_n \equiv B_1B_n$. To recapitulate in more formal terms, let A_1, A_2, \dots, A_n and $B_1, B_2, \dots, B_n, n \geq 3$, be finite point sequences such that $[A_iA_{i+1}A_{i+2}], [B_iB_{i+1}B_{i+2}]$ for all $i \in \mathbb{N}_{n-2}$ (i.e. $\forall i = 1, 2, \dots, n-2$). Then congruences $A_iA_{i+1} \equiv B_iB_{i+1}$ for all $i \in \mathbb{N}_{n-1}$ imply $A_1A_n \equiv B_1B_n$.*

Proof. By induction on n . For $n = 3$ see A 1.3.3. Now suppose $A_1A_{n-1} \equiv B_1B_{n-1}$ (induction!).²⁴⁹ We have $[A_1A_{n-1}A_n], [B_1B_{n-1}B_n]$ by L 1.2.7.3. Therefore, $[A_1A_{n-1}A_n] \& [B_1B_{n-1}B_n] \& A_1A_{n-1} \equiv B_1B_{n-1} \& A_{n-1}A_n \equiv B_{n-1}B_n \xrightarrow{A1.3.3} A_1A_n \equiv B_1B_n$. \square

Lemma 1.3.2.1. *Let points B_1, B_2 lie on one side of a line a_{AC} , and some angle $\angle(h, k)$ be congruent to both $\angle CAB_1$ and $\angle CAB_2$. Then the angles $\angle CAB_1, \angle CAB_2$, and, consequently, the rays AB_1, AB_2 , are identical.*

Proof. (See Fig. 1.104.) $B_1B_2a_{AC} \& B_1 \in A_{B_1} \& B_2 \in A_{B_2} \xrightarrow{T1.2.19} A_{B_1}A_{B_2}a_{AC}$. $\angle(h, k) \equiv \angle CAB_1 \& \angle(h, k) \equiv \angle CAB_2 \& A_{B_1}A_{B_2}a_{AC} \xrightarrow{A1.3.4} \angle CAB_1 = \angle CAB_2 \Rightarrow A_{B_1} = A_{B_2}$.²⁵⁰ \square

Corollary 1.3.2.2. *If points B_1, B_2 lie on one side of a line a_{AC} , and the angle $\angle CAB_1$ is congruent to the angle $\angle CAB_2$ then $\angle CAB_1 = \angle CAB_2$ and, consequently, $A_{B_1} = A_{B_2}$.*

Proof. By A 1.3.4 $\angle CAB_1 \equiv \angle CAB_1$, so we can let $\angle(h, k) \equiv \angle CAB_1$ and use L 1.3.2.1. \square

²⁴⁸i.e., intervals formed by pairs of points with equal numbers

²⁴⁹We are using the obvious fact that if the conditions of our proposition are satisfied for n , they are satisfied for $n-1$, i.e. if $[A_iA_{i+1}A_{i+2}], [B_iB_{i+1}B_{i+2}]$ for all $i = 1, 2, \dots, n-2$, then obviously $[A_iA_{i+1}A_{i+2}], [B_iB_{i+1}B_{i+2}]$ for all $i = 1, 2, \dots, n-3$; if $A_iA_{i+1} \equiv B_iB_{i+1}$ for all $i = 1, 2, \dots, n-1$, then $A_iA_{i+1} \equiv B_iB_{i+1}$ for all $i = 1, 2, \dots, n-2$.

²⁵⁰In what follows we shall increasingly often use simple facts and arguments such as that, for instance, $DA_{B_1}a_{AC} \& A_{B_1}A_{B_2}a_{AC} \xrightarrow{L1.2.18.2} DA_{B_2}a_{AC}$ without mention, so as not to clutter exposition with excessive trivial details.

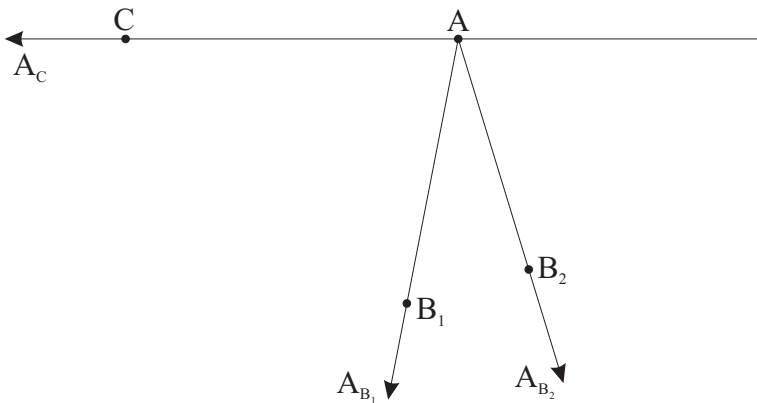

Figure 1.104: If points B_1, B_2 lie on one side of a_{AC} , and some angle $\angle(h, k)$ is congruent to both $\angle CAB_1, \angle CAB_2$, then the angles $\angle CAB_1, \angle CAB_2$, and, consequently, the rays A_{B_1}, A_{B_2} , are identical.

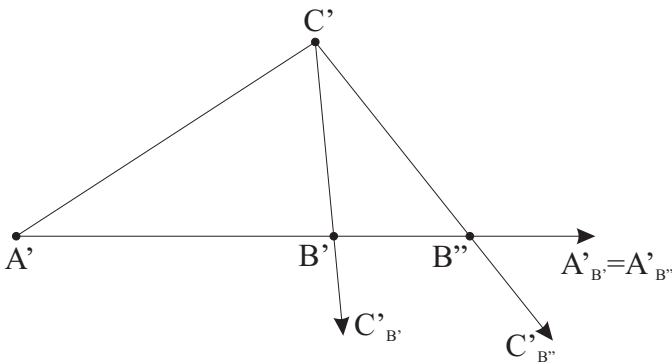

Figure 1.105: Given an interval AB , on any ray A'_X there is at most one point B' such that AB is congruent to the interval $A'B'$

Theorem 1.3.2. *Given an interval AB , on any ray A'_X there is exactly one point B' such that AB is congruent to the interval $A'B'$, $AB \equiv A'B'$.*

Proof. (See Fig. 1.105.) To show that given an interval AB , on any ray A'_X there is at most one point B' such that AB is congruent to the interval $A'B'$, suppose the contrary, i.e. $\exists B'' \in A'_B$ such that $AB \equiv A'B', AB \equiv A'B''$. By L 1.1.2.1 $\exists C' \notin a_{A'B'}$. $B'' \in A'_B \xrightarrow{L1.2.11.3} A'B'' = A'_B'' \xrightarrow{A1.3.4} \angle B'A'C' \equiv \angle B''A'C'$. $AB \equiv A'B' \& AB \equiv A'B'' \xrightarrow{T1.3.1} A'B' \equiv A'B''$. $A'B' \equiv A'B'' \& A'C' \equiv A'C' \& \angle B'A'C' \equiv \angle B''A'C' \xrightarrow{L1.3.1.1} \angle A'C'B' \equiv \angle A'C'B''$. $B'' \in A'_B \xrightarrow{L1.2.19.8} B'' \in (a_{A'C'})_{B'}$. $B'B'' \in a_{A'C'} \& \angle C'A'B' \equiv \angle C'A'B'' \xrightarrow{C1.3.2.2} C'_{B'} = C'_{B''}$.²⁵¹ But, on the other hand, $B'' \in a_{A'B'} \& B'' \neq B' \xrightarrow{P1.1.1.1} a_{A'B'} = a_{B'B''}$, and $C' \notin a_{A'B'} = a_{B'B''} \xrightarrow{C1.1.2.3} B'' \notin a_{B'C'} \xrightarrow{L1.2.11.1} C'_{B'} \neq C'_{B''}$ - a contradiction. \square

Congruence of Triangles: SAS & ASA

A triangle with (at least) two congruent sides is called an isosceles triangle. In an isosceles triangle $\triangle ABC$ with $AB \equiv CB$ the side AC is called the base of the triangle $\triangle ABC$, and the angles $\angle BAC$ and $\angle ACB$ are called its base angles. (See Fig. 1.106.)

Theorem 1.3.3. *In an isosceles triangle $\triangle ABC$ with $AB \equiv CB$ the base angles $\angle BAC, \angle ACB$ are congruent.*

Proof. Consider $\triangle ABC, \triangle CBA$. Then $AB \equiv CB \& CB \equiv AB \& \angle ABC \equiv \angle CBA \xrightarrow{A1.3.5} \angle CAB \equiv \angle ACB$. \square

Theorem 1.3.4 (First Triangle Congruence Theorem (SAS)). *Let two sides, say, AB and AC , and the angle $\angle BAC$ between them, of a triangle $\triangle ABC$, be congruent, respectively, to sides $A'B', A'C'$, and the angle $\angle B'A'C'$ between them, of a triangle $\triangle A'B'C'$. Then the triangle $\triangle ABC$ is congruent to the triangle $\triangle A'B'C'$.*

Proof. (See Fig. 1.107.) By A 1.3.5, L 1.3.1.1 $AB \equiv A'B' \& AC \equiv A'C' \& \angle A \equiv \angle A' \Rightarrow \angle B \equiv \angle B' \& \angle C \equiv \angle C'$.²⁵² Show $BC \equiv B'C'$. By A 1.3.1.1 $\exists C'' \in B'_C$ $BC \equiv B'C''$. $C'' \in B'_C \xrightarrow{L1.2.11.3} B'_C'' = B'_C' \Rightarrow \angle A'B'C' = \angle A'B'C''$. $AB \equiv A'B' \& BC \equiv B'C'' \& \angle B \equiv \angle B' = \angle A'B'C''$. $C'' \in B'_C \xrightarrow{L1.2.19.8} C'' \in (a_{A'B'})_{C'}$.

²⁵¹We take into account the obvious fact that the angles $\angle B'A'C', \angle B''A'C'$ are equal to, respectively, to $\angle C'A'B', \angle C'A'B''$.

²⁵²Recall that, according to the notation introduced on p. 71, in a $\triangle ABC$ $\angle A \equiv \angle BAC = \angle CAB$.

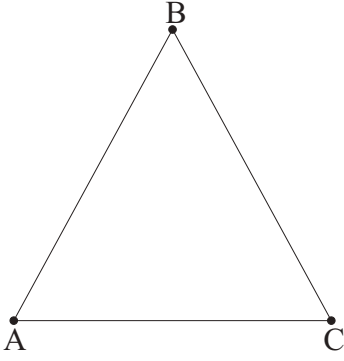

Figure 1.106: An isosceles triangle with $AB \equiv CB$.

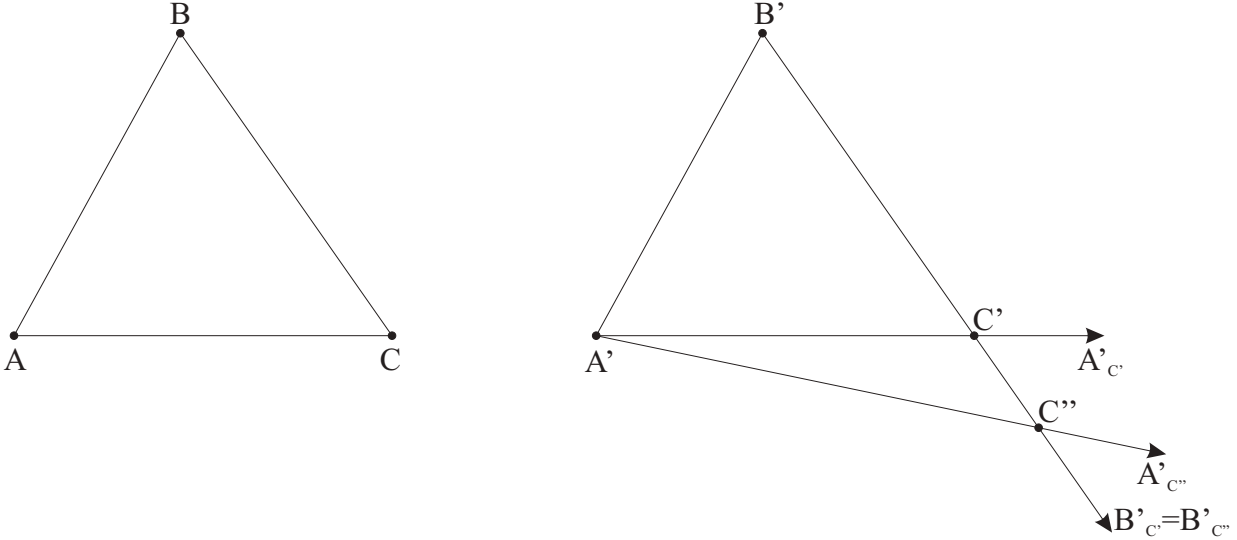

Figure 1.107: $AB \equiv A'B'$, $AC \equiv A'C'$, and $\angle BAC \equiv \angle B'A'C'$ imply $\triangle ABC \equiv \triangle A'B'C'$. (SAS, or The First Triangle Congruence Theorem)

$\angle BAC \equiv \angle B'A'C'$ & $\angle BAC \equiv \angle B'A'C''$ & $C'C'' \perp a_{A'B'}$ $\stackrel{L1.3.2.1}{\implies} A'C' = A'C''$. Finally, $C'' = C'$, because otherwise $C'' \neq C'$ & $C'' \in a_{B'C'} \cap a_{A'C'}$ & $C' \in a_{B'C'} \cap a_{A'C'}$ $\stackrel{A1.1.2}{\implies} a_{A'C'} = a_{B'C'}$ - a contradiction. \square

Theorem 1.3.5 (Second Triangle Congruence Theorem (ASA)). *Let a side, say, AB , and the two angles $\angle A$ and $\angle B$ adjacent to it (i.e. the two angles of $\triangle ABC$ having AB as a side) of a triangle $\triangle ABC$, be congruent respectively to a side $A'B'$ and two angles, $\angle A'$ and $\angle B'$, adjacent to it, of a triangle $\triangle A'B'C'$. Then the triangle $\triangle ABC$ is congruent to the triangle $\triangle A'B'C'$.*

Proof. (See Fig. 1.108.) By hypothesis, $AB \equiv A'B'$ & $\angle A \equiv \angle A'$ & $\angle B \equiv \angle B'$. By A 1.3.1 $\exists C''$ $C'' \in A'C'$ & $AC \equiv A'C''$. $C'' \in A'C'$ $\stackrel{L1.2.11.3}{\implies} A'C'' = A'C' \Rightarrow \angle B'A'C' \equiv \angle B'A'C''$. $AB \equiv A'B'$ & $AC \equiv A'C''$ & $\angle ABC \equiv \angle A'B'C''$ $\stackrel{A1.3.5}{\implies} \triangle ABC \equiv \triangle A'B'C''$. $C'' \in A'C'$ $\stackrel{L1.2.19.8}{\implies} (a_{A'B'})_{C'}$. $\angle ABC \equiv \angle A'B'C'$ & $\angle ABC \equiv \angle A'B'C''$ & $C'C'' \perp a_{A'B'}$ $\stackrel{A1.3.4}{\implies} B'C' = B'C''$. Finally, $C'' = C'$, because otherwise $C'' \neq C'$ & $C'' \in a_{B'C'} \cap a_{A'C'}$ & $C' \in a_{B'C'} \cap a_{A'C'}$ $\stackrel{A1.1.2}{\implies} a_{A'C'} = a_{B'C'}$ - a contradiction. \square

Congruence of Adjacent Supplementary and Vertical Angles

Theorem 1.3.6. *If an angle $\angle(h, k)$ is congruent to an angle $\angle(h', k')$, the angle $\angle(h^c, k)$ adjacent supplementary to the angle $\angle(h, k)$ is congruent to the angle $\angle(h'^c, k')$ adjacent supplementary to the angle $\angle(h', k')$.²⁵³*

Proof. (See Fig. 1.109.) Let B and B' be the common origins of the triples (3-ray pencils) of rays h, k, h^c and h', k', h'^c , respectively. Using L 1.2.11.3, A 1.3.1, we can choose points $A \in h, C \in k, D \in h^c$ and $A' \in h', C' \in k', D' \in h'^c$ in such a way that $AB \equiv A'B', BC \equiv B'C', BD \equiv B'D'$. Then also, by hypothesis, $\angle ABC \equiv \angle A'B'C'$. We have $AB \equiv A'B'$ & $BC \equiv B'C'$ & $\angle ABC \equiv \angle A'B'C'$ $\stackrel{T1.3.4}{\implies} \triangle ABC \equiv$

²⁵³Under the conditions of the theorem, the angle $\angle(h, k^c)$ (which is obviously also adjacent supplementary to the angle $\angle(h, k)$) is also congruent to the angle $\angle(h', k'^c)$ (adjacent supplementary to the angle $\angle(h', k')$). But due to symmetry in the definition of angle, this fact adds nothing new to the statement of the theorem.

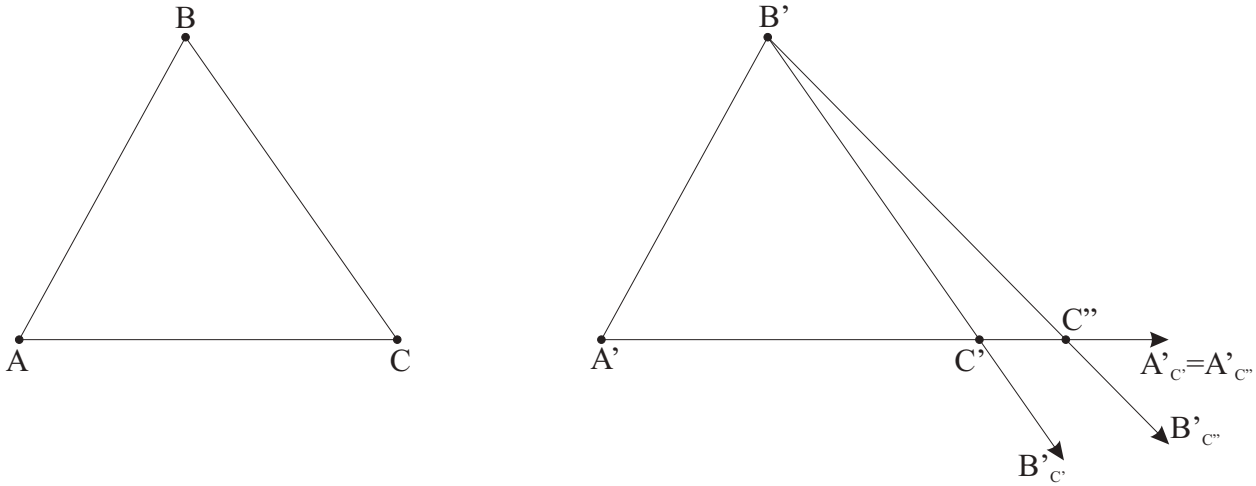

Figure 1.108: $AB \equiv A'B'$, $\angle A \equiv \angle A'$, and $\angle B \equiv \angle B'$ imply $\triangle ABC \equiv \triangle A'B'C'$. (ASA, or The Second Triangle Congruence Theorem)

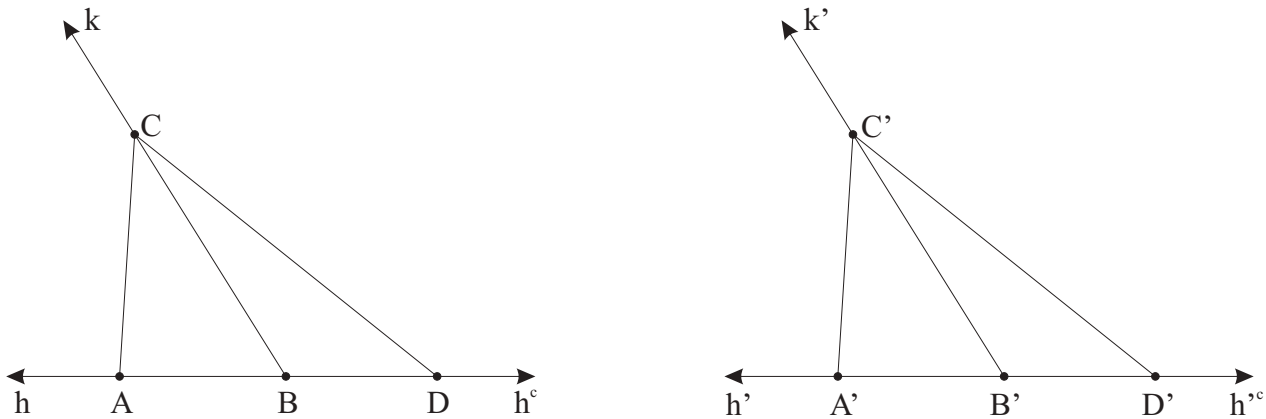

Figure 1.109: If angles $\angle(h, k)$, $\angle(h', k')$ are congruent, their adjacent supplementary angles $\angle(h^c, k)$, $\angle(h'^c, k')$ are also congruent.

$\triangle A'B'C' \Rightarrow AC \equiv A'C' \& \angle CAB \equiv \angle C'A'B'$. $AB \equiv A'B' \& BD \equiv B'D' \& [ABD] \& [A'B'D'] \xrightarrow{A1.3.3} AD \equiv A'D'$. $[ABD] \& [A'B'D'] \xrightarrow{L1.2.15.1} B \in A_D \cap D_A \& A'_{D'} \cap D'_{A'} \Rightarrow B \in A_D \& B' \in A'_{D'} \& B \in D_A \& B' \in D'_{A'} \xrightarrow{L1.2.11.3} AB = A_D \& A'_{B'} = A'_{D'} \& D_B = D_A \& D'_{B'} = D'_{A'} \Rightarrow \angle CAB = \angle CAD \& \angle C'A'B' = \angle C'A'D' \& \angle CDB = \angle CDA \& \angle C'D'B' = \angle C'D'A'$. $\angle CAB \equiv \angle C'A'B' \& \angle CAB = \angle CAD \& \angle C'A'B' = \angle C'A'D' \Rightarrow \angle CAD \equiv \angle C'A'D'$. $AC \equiv A'C' \& AD \equiv A'D' \& \angle CAD \equiv \angle C'A'D' \xrightarrow{T1.3.4} \triangle ACD \equiv \triangle A'C'D' \Rightarrow CD \equiv C'D' \& \angle CDA \equiv \angle C'D'A'$. $\angle CDA \equiv \angle C'D'A' \& \angle CDA = \angle CDB \& \angle C'D'A' = \angle C'D'B' \xrightarrow{A1.3.5} \angle CBD \equiv \angle C'B'D'$. \square

The following corollary is opposite, in a sense, to the preceding theorem T 1.3.6.

Corollary 1.3.6.1. *Suppose $\angle(h, k)$, $\angle(k, l)$ are two adjacent supplementary angles (i.e. $l = h^c$) and $\angle(h', k')$, $\angle(k', l')$ are two adjacent angles such that $\angle(h, k) \equiv \angle(h', k')$, $\angle(k, l) \equiv \angle(k', l')$. Then the angles $\angle(h', k')$, $\angle(k', l')$ are adjacent supplementary, i.e. $l' = h'^c$. (See Fig. 1.110.)*

Proof. Since, by hypothesis, $\angle(h', k')$, $\angle(k', l')$ are adjacent, by definition of adjacency the rays h' , l' lie on opposite sides of \bar{k}' . Since the angles $\angle(h, k)$, $\angle(k, l)$ are adjacent supplementary, as are the angles $\angle(h', k')$, $\angle(k', h'^c)$, we have by T 1.3.6 $\angle(k, l) \equiv \angle(k', h'^c)$. We also have, obviously, $h'\bar{k}'h'^c$. Hence $h'\bar{k}'l' \& h'\bar{k}'h'^c \xrightarrow{L1.2.18.4} l'h'^c\bar{k}'$. $\angle(k, l) \equiv \angle(k', l') \& \angle(k, l) \equiv \angle(k', h'^c) \& l'h'^c\bar{k}' \xrightarrow{A1.3.4} h'^c = l'$. Thus, the angles $\angle(h', k')$, $\angle(k', l')$ are adjacent supplementary, q.e.d. \square

Corollary 1.3.6.2. *Consider two congruent intervals AC , $A'C'$ and points B , B' , D , D' such that $\angle BAC \equiv \angle B'A'C'$, $\angle DCA \equiv \angle D'C'A'$, the points B , D lie on the same side of the line a_{AC} , and the points B' , D' lie on the same side of the line $a_{A'C'}$. Suppose further that the lines a_{AB} , a_{CD} meet in some point E . Then the lines $a_{A'B'}$ and $a_{C'D'}$ meet in a point E' such that the triangles $\triangle AEC$, $\triangle A'E'C'$ are congruent. Furthermore, if the points B , E lie on the same side of the line a_{AC} then the points B' , E' lie on the same side of the line $a_{A'C'}$, and if the points B , E lie on the opposite sides of the line a_{AC} then the points B' , E' lie on the opposite sides of the line $a_{A'C'}$. Thus, if the rays AB , $C'D$ meet in E , then the rays $A'B'$ meet ray $C'D'$ in some point E' .*

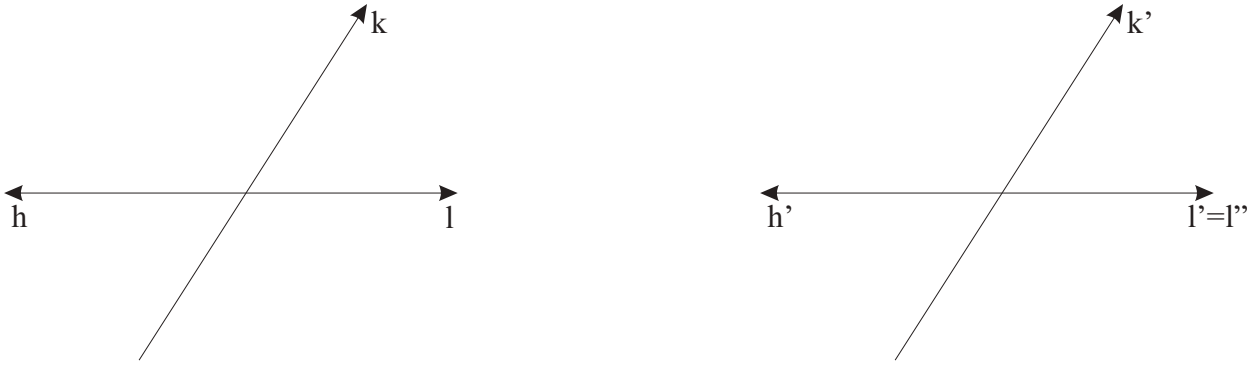

Figure 1.110: Suppose $\angle(h, k)$, $\angle(k, l)$ are adjacent supplementary, $\angle(h', k')$, $\angle(k', l')$ are adjacent, and $\angle(h, k) \equiv \angle(h', k')$, $\angle(k, l) \equiv \angle(k', l')$. Then $\angle(h', k')$, $\angle(k', l')$ are adjacent complementary, i.e. $l' = h'^c$.

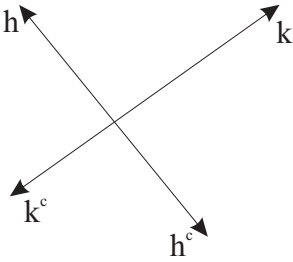

Figure 1.111: $\angle(h, k)$ is congruent to its vertical angle $\angle(h^c, k^c)$.

Proof. Consider first the case where $E \in A_B$, that is, the points B, D, E all lie on the same side of a_{AC} (see L 1.2.19.8, L 1.2.17.1). Using A 1.3.1 take $E' \in A'_B$ such that $AE \equiv A'E'$. Then $AC \equiv A'C'$ & $AE \equiv A'E'$ & $\angle EAC \equiv \angle E'A'C'$ $\xrightarrow{T1.3.4}$ $\triangle AEC \equiv \triangle A'E'C' \Rightarrow \angle ACE \equiv \angle A'C'E'$.²⁵⁴ Taking into account that $E \in C_D$ $\xrightarrow{L1.2.11.15}$ $\angle ACD = \angle ACE$, we can write $\angle ACD \equiv \angle A'C'D'$ & $\angle ACE \equiv \angle A'C'E'$ & $D'E'a_{A'C'} \xrightarrow{A1.3.4} A'E' = A'D'$.

Now suppose that the points B, E lie on the opposite sides of the line a_{AC} . Then (see L 1.2.17.10) the points D, E lie on the opposite sides of a_{AC} . Taking points G, H, G', H' such that $[BAG], [DCH], [B'A'G'], [D'C'H']$ and thus $\angle GAC = \text{adjsp}\angle BAC$, $\angle HCA = \text{adjsp}\angle DCA$, $\angle G'A'C' = \text{adjsp}\angle B'A'C'$, $\angle H'C'A' = \text{adjsp}\angle D'C'A'$, we see that $\angle GAC \equiv \angle G'A'C'$, $\angle HCA \equiv \angle H'C'A'$ by hypothesis and in view of T 1.3.6. Using L 1.2.17.9, L 1.2.17.10 we can write $Ba_{AC}G \& BDa_{AC} \& Da_{AC}H \Rightarrow GHa_{AC}$, $Ba_{AC}E \& Ba_{AC}G \Rightarrow EGa_{AC}$, $B'a_{A'C'}G' \& B'D'a_{A'C'} \& D'a_{A'C'}H' \Rightarrow G'H'a_{A'C'}$, $B'a_{A'C'}E' \& B'a_{A'C'}G' \Rightarrow E'G'a_{A'C'}$. Thus, the remainder of the proof is essentially reduced to the case already considered. \square

Theorem 1.3.7. Every angle $\angle(h, k)$ is congruent to its vertical angle $\angle(h^c, k^c)$.

Proof. $\angle(h^c, k) = \text{adjsp}\angle(h, k) \& \angle(h^c, k) = \text{adjsp}\angle(h^c, k^c) \& \angle(h^c, k) \equiv \angle(h^c, k) \xrightarrow{T1.3.6} \angle(h, k) \equiv \angle(h^c, k^c)$. (See Fig. 1.111.) \square

The following corollary is opposite, in a sense, to the preceding theorem T 1.3.7.

Corollary 1.3.7.1. If angles $\angle(h, k)$ and $\angle(h^c, k')$ (where h^c is, as always, the ray complementary to the ray h) are congruent and the rays k, k' lie on opposite sides of the line \bar{h} , then the angles $\angle(h, k)$ and $\angle(h^c, k')$ are vertical angles. (See Fig. 1.112.)

*Proof.*²⁵⁵ By the preceding theorem (T 1.3.7) the vertical angles $\angle(h, k)$, $\angle(h^c, k^c)$ are congruent. We have also $k\bar{h}k^c \& k\bar{h}k' \xrightarrow{L1.2.18.4} k^c k' \bar{h}$. Therefore, $\angle(h, k) \equiv \angle(h^c, k^c) \& \angle(h, k) \equiv \angle(h^c, k') \& k^c k' \bar{h} \xrightarrow{A1.3.4} k' = k^c$, which completes the proof. \square

An angle $\angle(h', l')$, congruent to an angle $\angle(h, l)$, adjacent supplementary to a given angle $\angle(h, k)$,²⁵⁶ is said to be supplementary to the angle $\angle(h, k)$. This fact is written as $\angle(h', l') \text{suppl}\angle(h, k)$. Obviously (see T 1.3.1), this relation is also symmetric, which gives as the right to speak of the two angles $\angle(h, k)$, $\angle(h, l)$ as being supplementary (to each other).

²⁵⁴We take into account here that in view of L 1.2.11.3 we have $E \in A_B \Rightarrow \angle EAC = \angle BAC$, $E' \in A'_B \Rightarrow \angle E'A'C' = \angle B'A'C'$. Thus, $\angle BAC \equiv \angle B'A'C'$ turns into $\angle EAC \equiv \angle E'A'C'$.

²⁵⁵Alternatively, to prove this corollary we can write: $\angle(h^c, k) = \text{adjsp}\angle(h, k) \& \angle(h^c, k) = \text{adj}\angle(h^c, k') \& \angle(h, k) \equiv \angle(h^c, k') \& \angle(h^c, k) \equiv \angle(h^c, k) \xrightarrow{C1.3.6.1} k' = k^c$. Hence the result follows immediately by the preceding theorem T 1.3.7.

²⁵⁶I.e. we have $\angle(h', l') \equiv \angle(h, l)$, where $l = k^c$

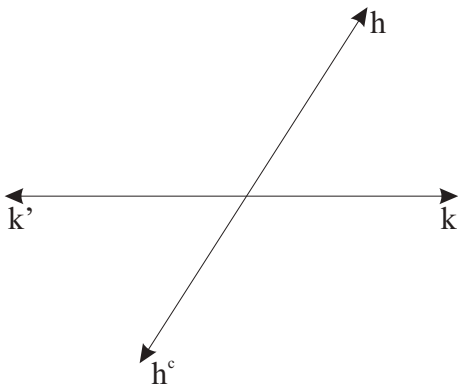

Figure 1.112: If angles $\angle(h, k), \angle(h^c, k')$ are congruent and k, k' lie on opposite sides of \bar{h} , then the angles $\angle(h, k), \angle(h^c, k')$ are vertical angles and thus are congruent.

Right Angles and Orthogonality

An angle $\angle(h, k)$ congruent to its adjacent supplementary angle $\angle(h^c, k)$ is called a right angle. An angle which is not a right angle is called an oblique angle.

If $\angle(h, k)$ is a right angle, the ray k , as well as the line \bar{k} , are said to be perpendicular, or orthogonal, to ray h , as well as the line \bar{h} , written $k \perp l$. (respectively, the fact that the line \bar{k} is perpendicular to the line \bar{h} is written as $\bar{k} \perp \bar{h}$, etc.) The ray k is also called simply a perpendicular to \bar{h} , and the vertex O of the right angle $\angle(h, k)$ is called the foot of the perpendicular k . If $P \in \{O\} \cup k$, the point O is called the orthogonal projection²⁵⁷ of the point P on the line \bar{h} . Furthermore, if $Q \in h$, the interval OQ is called the (orthogonal) projection of the interval OP on the line \bar{k} .

In general, we shall call the orthogonal projection²⁵⁸ of the point A on line a and denote by $proj(A, a)$:

- The point A itself if $A \in a$;
- The foot O of the perpendicular to a drawn through A .

Also, if A, B are points each of which lies either outside or on some line a , the interval $A'B'$ formed by the orthogonal projections A', B' (assuming A', B' are distinct!) of the points A, B , respectively, on a ,²⁵⁹ is called the orthogonal projection of the interval AB on the line a and denoted $proj(AB, a)$.

Note that orthogonality of lines is well defined, because if $\angle(h, k)$ is a right angle, we have $\angle(h, k) \equiv \angle$, so that $\angle(h^c, k), \angle(h, k^c), \angle(h^c, k^c)$ are also right angles.

The concept of projection can be extended onto the case of non-orthogonal projections. Consider a line a on which one of the two possible orders is defined, an angle $\angle(h, k)$, and a point A . We define the projection $B = proj(A, a, \angle(h, k))$ ²⁶⁰ of the point A on our oriented line under the given angle $\angle(h, k)$ as follows: If $A \in a$ then $B \equiv A$. If $A \notin a$ then B is the (only) point with the property $\angle BAC \equiv \angle(h, k)$, where C is a point succeeding A in the chosen order.²⁶¹ The uniqueness of this point can easily be shown using T 1.3.17.²⁶²

Lemma 1.3.8.1. *Given a line a_{OA} , through any point C not on it at least one perpendicular to a_{OA} can be drawn.*

Proof. Using A 1.3.4, L 1.2.11.3, A 1.3.1, choose B so that $\angle AOC \equiv \angle AOB$ & $O_B \subset (a_{OA})_C^c$ & $OC \equiv OB \Rightarrow \exists D \in a_{OA}$ & $[CDB]$. If $D = O$ (See Fig. 1.113, a.) then $\angle AOB = \text{adjsp } \angle AOC$, whence, taking into account $\angle AOC \equiv \angle AOB$, we conclude that $\angle AOC$ is a right angle. If $D \in O_A$ (See Fig. 1.113, b.) then from L 1.2.11.3 it follows that $O_D = O_A$ and therefore $\angle AOC = \angle DOC$, $\angle AOB = \angle DOB$. Together with $\angle AOC \equiv \angle AOB$, this gives $\angle DOC \equiv \angle DOB$. We then have $OA \equiv OA$ & $OC \equiv OB$ & $\angle DOC \equiv \angle DOB \xrightarrow{A1.3.5} \angle ODC \equiv \angle ODB$. Since also $[CDB]$, angle $\angle ODC$ is right. If $D \in O_A^c$ (See Fig. 1.113, c.) then $\angle DOC = \text{adjsp } \angle AOC$ & $\angle DOB = \text{adjsp } \angle AOB$ & $\angle AOC \equiv \angle AOB \xrightarrow{T1.3.6} \angle DOC \equiv \angle DOB$. Finally, $OD \equiv OD$ & $OC \equiv OB$ & $\angle DOC \equiv \angle DOB \xrightarrow{A1.3.5} \angle ODC \equiv \angle ODB$. \square

Theorem 1.3.8. *Right angles exist.*

Proof. Follows immediately from L 1.3.8.1. \square

²⁵⁷In our further exposition in this part of the book the word "projection" will mean orthogonal projection, unless otherwise stated. We will also omit the mention of the line onto which the interval is projection whenever this mention is not relevant.

²⁵⁸Again, we will usually leave out the word "orthogonal". We shall also mention the line on which the interval is projected only on an as needed basis.

²⁵⁹For example, if both $A \notin a, B \notin a$, then A', B' are the feet of the perpendicular to the line a drawn, respectively, through the points A, B in the planes containing the corresponding points.

²⁶⁰We normally do not mention the direction explicitly, as, once defined and fixed, it is not relevant in our considerations.

²⁶¹Evidently, the projection is well defined, for it does not depend on the choice of the point C as long as the point C succeeds A . To see this, we can utilize the following property of the precedence relation: If $A \prec B$ then $A \prec C$ for any point $C \in AB$.

²⁶²The trivial details are left to the reader to work out as an exercise. Observe that we are not yet in a position to prove the *existence* of the projection B of a given point A onto a given line a under a given angle $\angle(h, k)$. Establishing this generally requires the continuity axioms.

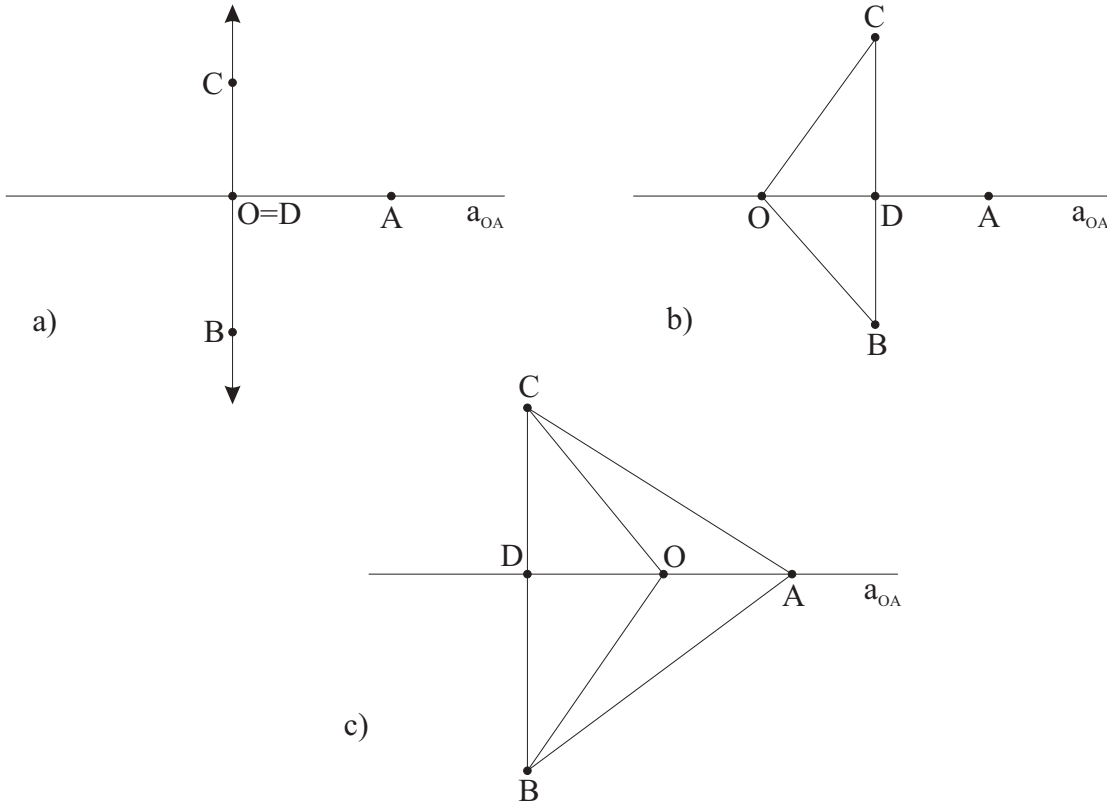

Figure 1.113: Construction for proof of T 1.3.8. $\angle AOC$ in a) and $\angle ODC$ in b), c) are right angles.

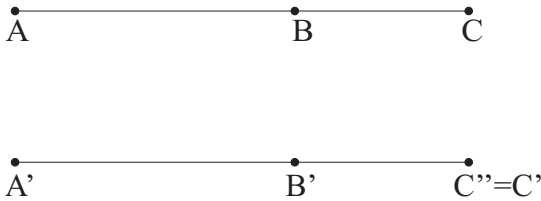

Figure 1.114: Let B and B' divide A, C and A', C' , respectively. Then $AB \equiv A'B'$, $AC \equiv A'C'$ imply $BC \equiv B'C'$.

Lemma 1.3.8.2. Any angle $\angle(h', k')$ congruent to a right angle $\angle(h, k)$, is a right angle.

Proof. Indeed, by T 1.3.6, T 1.3.11 we have $\angle(h', k') \equiv \angle(h, k) \& \angle(h, k) \equiv \angle(h^c, k) \Rightarrow \angle(h'^c, k') \equiv \angle(h^c, k) \& \angle(h', k') \equiv \angle(h', k') \equiv \angle(h^c, k) \Rightarrow \angle(h', k') \equiv \angle(h'^c, k')$. \square

Lemma 1.3.8.3. Into any of the two half-planes into which the line a divides the plane α , one and only one perpendicular to a with O as the foot can be drawn. ²⁶³

Proof. See T 1.3.8, A 1.3.4. \square

Congruence and Betweenness for Intervals

Lemma 1.3.9.1. If intervals $AB, A'B'$, as well as $AC, A'C'$, are congruent, B divides A, C , and B', C' lie on one side of A' , then B' divides A', C' , and $BC, B'C'$ are congruent. ²⁶⁴

Proof. (See Fig. 1.114.) By A 1.3.1 $\exists C'' \in (B'A')^c \& BC \equiv B'C''$. $C'' \in (B'A')^c \xrightarrow{L1.2.15.2} [A'B'C'']$. $[A'B'C'] \& [A'B'C''] \xrightarrow{L1.2.11.13} B' \in A'C' \& B' \in A'C'' \xrightarrow{L1.2.11.4} A'C' = A'C''$. $AC \equiv A'C' \& AC \equiv A'C'' \& A'C' = A'C'' \xrightarrow{A1.3.1} A'C' = A'C'' \Rightarrow C' = C''$. \square

Corollary 1.3.9.2. Given congruent intervals $AC, A'C'$, for any point $B \in (AC)$ there is exactly one point $B' \in (A'C')$ such that $AB \equiv A'B', BC \equiv B'C'$.

²⁶³The following formulation of this lemma will also be used: Given a line a and a point O on it, in any plane α containing the line a there exists exactly one line b perpendicular to a (and meeting it) at O .

²⁶⁴For the particular case where it is already known that the point B' divides the points A', C' , we can formulate the remaining part of the lemma as follows: Let points B and B' lie between points A, C and A', C' , respectively. Then congruences $AB \equiv A'B', AC \equiv A'C'$ imply $BC \equiv B'C'$.

Proof. Using A 1.3.1, choose $B' \in A'C'$ so that $AB \equiv A'B'$. Then apply L 1.3.9.1. Uniqueness follows from T 1.3.1. \square

Proposition 1.3.9.3. *Let point pairs B, C and B', C' lie either both on one side or both on opposite sides of the points A and A' , respectively. Then congruences $AB \equiv A'B', AC \equiv A'C'$ imply $BC \equiv B'C'$.*

Proof. First, suppose $B \in A_C, B' \in A'_{C'}$. $B \in A_C \& B \neq C \xrightarrow{L1.2.11.8} [ABC] \vee [ACB]$. Let $[ABC]$.²⁶⁵ Then $[ABC] \& B' \in A'_{C'} \& AB \equiv A'B' \& AC \equiv A'C' \xrightarrow{L1.3.9.1} BC \equiv B'C'$.

If B, C and B', C' lie on opposite sides of A and A' , respectively, we have $[BAC] \& [B'A'C'] \& AB \equiv A'B' \& AC \equiv A'C' \xrightarrow{A1.3.3} BC \equiv B'C'$. \square

Corollary 1.3.9.4. *Let intervals $AB, A'B'$, as well as $AC, A'C'$, be congruent. Then if the point B lies between the points A, C , the point C' lies outside the interval $A'B'$ (i.e. C' lies in the set $ExtA'B' = \mathcal{P}_{\alpha_{A'B'}} \setminus [A'B']$).*

Proof. $[ABC] \xrightarrow{L1.2.11.13} C \in A_B$. $B' \neq C'$, because otherwise $A'B' \equiv AB \& A'C' \equiv AC \& B = C \& C \in A_B \xrightarrow{A1.3.1} B = C$ - a contradiction. Also, $C' \notin (A'B')$, because otherwise $[A'C'B'] \& C \in A_B \& A'B' \equiv AB \& A'C' \equiv AC \xrightarrow{L1.3.9.1} [ACB] \Rightarrow \neg[ABC]$ - a contradiction. \square

Congruence and Betweenness for Angles

At this point it is convenient to extend the notion of congruence of angles to include straight angles. A straight angle $\angle(h, h^c)$ is, by definition, congruent to any straight angle $\angle(k, k^c)$, including itself, and not congruent to any extended angle that is not straight.

This definition obviously establishes congruence of straight angles as an equivalence relation.

Theorem 1.3.9. *Let h, k, l and h', k', l' be planar 3-ray pencils with the origins O and O' , respectively. Let also pairs of rays h, k and h', k' lie in corresponding planes α and α' either both on one side or both on opposite sides of the lines l, l' , respectively.²⁶⁶ In the case when h, k lie on opposite sides of l we require further that the rays h, k do not lie on one line.²⁶⁷ Then congruences $\angle(h, l) \equiv \angle(h', l'), \angle(k, l) \equiv \angle(k', l')$ imply $\angle(h, k) \equiv \angle(h', k')$.*

Proof. (See Fig. 1.115.) Let h, k lie in α on the same side of \bar{l} . Then, by hypothesis, h', k' lie in α' on the same side of \bar{l}' . Using A 1.3.1, choose $K \in k, K' \in k', L \in l, L' \in l'$ so that $OK \equiv O'K', OL \equiv O'L'$. Then, obviously, by L 1.2.11.3 $\angle(k, l) = \angle KOL, \angle(k', l') = \angle K'O'L'$. $hk\bar{l} \& h'k'\bar{l}' \& h \neq k \& h' \neq k' \xrightarrow{L1.2.21.21} (h \subset Int\angle(k, l) \vee k \subset Int\angle(h, l)) \& (h' \subset \angle(k', l') \vee k' \subset Int\angle(h', l'))$. Without loss of generality, we can assume $h \subset Int\angle(k, l), h' \subset Int\angle(k', l')$.²⁶⁸

The rest of the proof can be done in two ways:

(#1) $h \subset Int\angle(k, l) \& K \in k \& L \in l \xrightarrow{L1.2.21.10} \exists H \ H \in h \& [LHK]$. By A 1.3.1 $\exists H' \ H' \in h' \& OH \equiv O'H'$. $OL \equiv O'L' \& OH \equiv O'H' \& OK \equiv O'K' \& \angle HOL \equiv \angle H'O'L' \& \angle KOL \equiv \angle K'O'L' \xrightarrow{T1.3.4} \triangle OHL \equiv \triangle O'H'L' \& \triangle OKL \equiv \triangle O'K'L' \Rightarrow HL \equiv H'L' \& KL \equiv K'L' \& \angle OLH \equiv \angle O'H'L' \& \angle OLK \equiv \angle O'L'K' \& \angle OKL \equiv \angle O'K'L'$. $[LHK] \xrightarrow{L1.2.11.15} L_H = L_K \Rightarrow \angle OLH = \angle OLK$. By definition of the interior of the angle $\angle(l', k')$, we have $K' \in k' \& H' \in h' \& h' \subset Int\angle(l', k') \Rightarrow H'K'a_{O'L'}$.²⁶⁹ $\angle OLH = \angle OLK \& \angle OLH \equiv \angle O'L'H' \& \angle OLK \equiv \angle O'L'K' \& H'K'a_{O'L'} \xrightarrow{L1.3.2.1} \angle O'L'H' = \angle O'L'K' \Rightarrow L'_H = L'_K \Rightarrow H' \in a_{L'K'}$. $h' \subset Int\angle(l', k') \& K' \in k' \& L' \in l' \xrightarrow{L1.2.21.10} \exists H'' \ H'' \in h' \& [L'H''K']$. $L' \notin a_{O'H'} \& H' \in a_{O'H'} \cap a_{L'K'} \& H'' \in a_{O'H'} \cap a_{L'K'} \xrightarrow{L1.2.1.5} H'' = H'$,²⁷⁰ whence $[L'H''K']$. $[LHK] \& [L'H''K'] \& LH \equiv L'H' \& LK \equiv L'K' \xrightarrow{L1.3.9.1} HK \equiv H'K'$. $[KHL] \& [K'H'L'] \xrightarrow{L1.2.11.15} K_H = K_L \& K'_{H'} = K'_{L'} \Rightarrow \angle OKH = \angle OKL \& \angle O'K'H' = \angle O'K'L'$. Combined with $\angle OKL \equiv \angle O'K'L'$, this gives $\angle OKH \equiv \angle O'K'H'$. $OK \equiv O'K' \& HK \equiv H'K' \& \angle OKH \equiv \angle O'K'H' \xrightarrow{A1.3.5} \angle KOH \equiv \angle K'O'H' \Rightarrow \angle(h, k) \equiv \angle(h', k')$.

Now suppose h, k and h', k' lie in the respective planes α and α' on opposite sides of \bar{l} and \bar{l}' , respectively. By hypothesis, in this case h^c and k are distinct. Then we also have $k' \neq h'^c$, for otherwise we would have $k' = h'^c \& \angle(h', l') \equiv \angle(h, l) \& \angle(l', k') \equiv \angle(l, k) \& h\bar{l}k \xrightarrow{C1.3.6.1} k = h^c$ - a contradiction. Now we can write $h\bar{l}k \& h'\bar{l}'k' \& h^c\bar{l}h \& h'^c\bar{l}'h' \xrightarrow{L1.2.18.4} h^c\bar{k}l \& h'^c\bar{k}'l'$. $\angle(h, l) \equiv \angle(h', l') \xrightarrow{T1.3.6} \angle(h^c, l) \equiv \angle(h'^c, l')$. Using the first part

²⁶⁵Since B, C enter the conditions of the proposition symmetrically, as do B', C' , because $B' \in A'_{C'} \xrightarrow{L1.2.11.3} C' \in A'_{B'}$, we do not really need to consider the case when $[ACB]$.

²⁶⁶These conditions are met, in particular, when both $k \subset Int\angle(h, l), k' \subset Int\angle(h', l')$ (see proof).

²⁶⁷In the case when h, k lie on one line, i.e. when the ray k is the complementary ray of h and thus the angle $\angle(h, l)$ is adjacent supplementary to the angle $\angle(l, k) = \angle(l, h^c)$, the theorem is true only if we extend the notion of angle to include straight angles and declare all straight angles congruent. In this latter case we can write $\angle(h, l) \equiv \angle(h', l') \& \angle(l, k) \equiv \angle(l', k') \& \angle(l, k) = \text{adj}\angle(h, l) \& \angle(l', k') = \text{adj}\angle(h', l') \xrightarrow{C1.3.6.1} l' = h'^c$.

²⁶⁸Note that h, k , as well as h', k' , enter the conditions of the theorem symmetrically. Actually, it can be proven that under these conditions $h \subset Int\angle(l, k)$ implies $h' \subset Int\angle(l', k')$ (see P 1.3.9.5 below), but this fact is not relevant to the current proof.

²⁶⁹Obviously, $a_{O'L'} = \bar{l}'$.

²⁷⁰Note that $a_{O'H'} = \bar{h}'$.

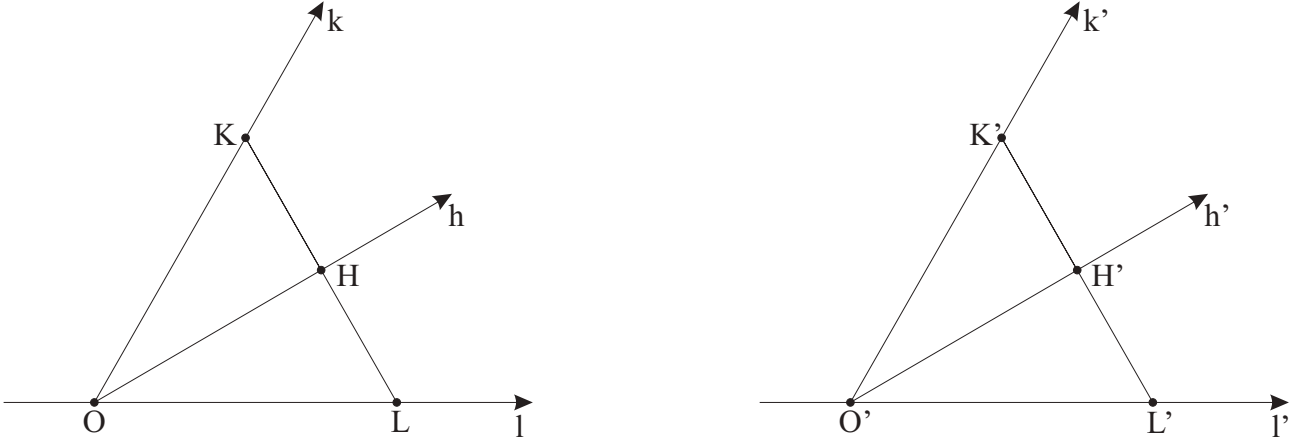

Figure 1.115: Construction for proof of T 1.3.9, P 1.3.9.5.

of this proof, we can write, $h^c k \bar{l} \& h'^c k' \bar{l}' \& \angle(h^c, l) \equiv \angle(h'^c, l') \& \angle(k, l) \equiv \angle(k', l') \Rightarrow \angle(h^c, k) \equiv \angle(h'^c, k') \xrightarrow{T1.3.6} \angle(h, k) \equiv \angle(h', k')$. \square

(#2) $OK \equiv O'K' \& OL \equiv O'L' \& \angle KOL \equiv \angle K'O'L' \xrightarrow{T1.3.4} \triangle OKL \equiv \triangle O'K'L' \Rightarrow KL \equiv K'L' \& \angle OLK \equiv \angle O'L'K' \& \angle OKL \equiv \angle O'K'L'$. $h \subset \text{Int}\angle(k, l) \& K \in k \& L \in l \& h' \subset \text{Int}\angle(k', l') \& K' \in k' \& L' \in l' \xrightarrow{L1.2.21.10} (\exists H \ H \in h \& [LHK]) \& (\exists H' \ H' \in h' \& [L'H'K'])$. $[LHK] \& [L'H'K'] \xrightarrow{L1.2.11.15} L_H = L_K \& L'_{H'} = L'_{K'} \& K_H = K_L \& K'_{H'} = K'_{L'} \Rightarrow \angle OLH = \angle OLK \& \angle O'L'H' = \angle O'L'K' \& \angle OKH = \angle OKL \& \angle O'K'H' = \angle O'K'L'$. Combined with $\angle OLK \equiv \angle O'L'K'$, $\angle OKL \equiv \angle O'K'L'$, this gives $\angle OLH \equiv \angle O'L'H'$, $\angle OKH \equiv \angle O'K'H'$. $OL \equiv O'L' \& \angle HOL \equiv \angle H'O'L' \& \angle OLH \equiv \angle O'L'H' \xrightarrow{T1.3.5} \triangle OHL \equiv \triangle O'H'L' \Rightarrow LH \equiv L'H' \& \angle LHO \equiv \angle L'H'O'$. Since $[LHK]$, $[L'H'K']$, we have $\angle KHO = \text{adjsp } \angle LHO \& \angle K'H'O' = \text{adjsp } \angle L'H'O'$. $\angle LHO \equiv \angle L'H'O' \& \angle KHO = \text{adjsp } \angle LHO \& \angle K'H'O' = \text{adjsp } \angle L'H'O' \xrightarrow{T1.3.6} \angle KHO \equiv \angle K'H'O'$. $[LHK] \& [L'H'K'] \& LK \equiv L'K' \& LH \equiv L'H' \xrightarrow{L1.3.9.1} HK \equiv H'K'$. $HK \equiv H'K' \& \angle OHK \equiv \angle O'H'K' \& \angle OKH \equiv \angle O'K'H' \xrightarrow{A1.3.5} \angle HOK \equiv \angle H'O'K' \Rightarrow \angle(h, k) \equiv \angle(h', k')$. The rest is as in (#1). \square

Proposition 1.3.9.5. *Let h, k, l and h', k', l' be planar 3-ray pencils with the origins O and O' . If the ray h lies inside the angle $\angle(l, k)$, and the rays h', k' lie on one side of the line \bar{l}' , the congruences $\angle(h, l) \equiv \angle(h', l')$, $\angle(k, l) \equiv \angle(k', l')$ imply $h' \subset \text{Int}\angle(l', k')$. ²⁷¹*

Proof. (See Fig. 1.115.) ²⁷² Using A 1.3.1, choose $K \in k$, $K' \in k'$, $L \in l$, $L' \in l'$ so that $OK \equiv O'K'$, $OL \equiv O'L'$. Then, obviously, by L 1.2.11.3 $\angle(k, l) = \angle KOL$, $\angle(k', l') = \angle K'O'L'$. $OL \equiv O'L' \& OK \equiv O'K' \& \angle KOL \equiv \angle K'O'L' \xrightarrow{T1.3.4} \triangle OKL \equiv \triangle O'K'L' \Rightarrow KL \equiv K'L' \& \angle OLK \equiv \angle O'L'K'$. $h \subset \text{Int}\angle(k, l) \& K \in k \& L \in l \xrightarrow{L1.2.21.10} \exists H \ H \in h \& [LHK]$. $[LHK] \& KL \equiv K'L' \xrightarrow{C1.3.9.2} \exists H' \ [L'H'K'] \& LH \equiv L'H' \& KH \equiv K'H'$. $[LHK] \& [L'H'K'] \xrightarrow{L1.2.11.15} L_H = L_K \& L'_{H'} = L'_{K'} \Rightarrow \angle OLH = \angle OLK \& \angle O'L'H' = \angle O'L'K'$. Combined with $\angle OLK \equiv \angle O'L'K'$, this gives $\angle OLH \equiv \angle O'L'H'$. $OL \equiv O'L' \& LH \equiv L'H' \& \angle OLH \equiv \angle O'L'H' \xrightarrow{A1.3.5} \angle HOL \equiv \angle H'O'L'$. By L 1.2.21.6, L 1.2.21.4 $K' \in k' \& L' \in l' \& [L'H'K'] \Rightarrow O'_{H'} \subset \text{Int}\angle(k', l') \Rightarrow O'_{H'}k'\bar{l}'$. Also, by hypothesis, $k'h'\bar{l}'$, and therefore $O'_{H'}k'\bar{l}' \& k'h'\bar{l}' \in l \xrightarrow{L1.2.18.2} O'_{H'}h'\bar{l}'$. Finally, $\angle(h, l) \equiv \angle(h', l') \& \angle HOL \equiv \angle H'O'L' \& \angle(h, l) = \angle HOL \& O'_{H'}h'\bar{l}' \in l \xrightarrow{A1.3.4} h' \subset \text{Int}\angle(l', k')$. \square

Corollary 1.3.9.6. *Let rays h, k and h', k' lie on one side of lines \bar{l} and \bar{l}' , and let the angles $\angle(l, h)$, $\angle(l, k)$ be congruent, respectively, to the angles $\angle(l', h')$, $\angle(l', k')$. Then if the ray h' lies outside the angle $\angle(l', k')$, the ray h lies outside the angle $\angle(l, k)$.*

Proof. Indeed, if $h = k$ then $h = k \& \angle(l, h) \equiv \angle(l', h') \& \angle(l, k) \equiv \angle(l', k') \& h'k'\bar{l}' \xrightarrow{A1.3.4} \angle(l', h') = \angle(l', k') \Rightarrow h' = k'$ - a contradiction; if $h \subset \text{Int}\angle(l, k)$ then $h \subset \text{Int}\angle(l, k) \& h'k'\bar{l}' \& \angle(l, h) \equiv \angle(l', h') \& \angle(l, k) \equiv \angle(l', k') \xrightarrow{P1.3.9.5} h' \subset \text{Int}\angle(l', k')$ - a contradiction. \square

Proposition 1.3.9.7. *Let an angle $\angle(l, k)$ be congruent to an angle $\angle(l', k')$. Then for any ray h of the same origin as l, k , lying inside the angle $\angle(l, k)$, there is exactly one ray h' with the same origin as l', k' , lying inside the angle $\angle(l', k')$ such that $\angle(l, h) \equiv \angle(l', h')$, $\angle(h, k) \equiv \angle(h', k')$.*

Proof. Using A 1.3.4, choose h' so that $h'k'\bar{l}' \& \angle(l, h) \equiv \angle(l', h')$. The rest follows from P 1.3.9.5, T 1.3.9. \square

²⁷¹ According to T 1.3.9, they also imply in this case $\angle(h, k) \equiv \angle(h', k')$.

²⁷² Note that this proof, especially in its beginning, follows closely in the footsteps of the proof of T 1.3.9.

Congruence of Triangles:SSS

Lemma 1.3.10.1. *If points Z_1, Z_2 lie on opposite sides of a line a_{XY} , the congruences $XZ_1 \equiv XZ_2, YZ_1 \equiv YZ_2$ imply $\angle XYZ_1 \equiv \angle XYZ_2$ (and $\angle YXZ_1 \equiv \angle YXZ_2$).*

Proof. $Z_1 a_{XY} Z_2 \Rightarrow \exists X' X' \in a_{XY} \& [Z_1 X' Z_2]$. Observe that the lines $a_{XY}, a_{Z_1 Z_2}$ meet only in X' , because $Z_1 \notin a_{XY} \Rightarrow a_{Z_1 Z_2} \neq a_{XY}$, and therefore for any Y' such that $Y' \in a_{XY}, Y' \in a_{Z_1 Z_2}$, we have $X' \in a_{XY} \cap a_{Z_1 Z_2} \& Y' \in a_{XY} \cap a_{Z_1 Z_2} \xrightarrow{T1.1.1} Y' = X'$.²⁷³ We also assume that $Y \notin a_{Z_1 Z_2}$.²⁷⁴ For the isosceles triangle $\triangle Z_1 Y Z_2$ the theorem T 1.3.3 gives $YZ_1 \equiv YZ_2 \Rightarrow \angle YZ_1 Z_2 \equiv \angle YZ_2 Z_1$. On the other hand, $[Z_1 X' Z_2] \xrightarrow{L1.2.11.15} Z_{1X'} = Z_{1Z_2} \& Z_{2X'} = Z_{2Z_1} \Rightarrow \angle YZ_1 X' = \angle YZ_1 Z_2 \& \angle YZ_2 X' = \angle YZ_2 Z_1$. Therefore, $\angle YZ_1 Z_2 \equiv \angle YZ_2 Z_1 \& \angle YZ_1 X' = \angle YZ_1 Z_2 \& \angle YZ_2 Z_1 = \angle YZ_2 X' \Rightarrow \angle YZ_1 X' \equiv \angle YZ_2 X'$.

Let Z_1, Z_2, X be collinear, i.e. $X \in a_{Z_1 Z_2}$ (See Fig. 1.116, a)). Then we have $X \in a_{XY} \cap a_{Z_1 Z_2} \Rightarrow X' = X$, and we can write $XZ_1 \equiv XZ_2 \& YZ_1 \equiv YZ_2 \& \angle YZ_1 X' \equiv \angle YZ_2 X' \xrightarrow{T1.3.4} \triangle XYZ_1 \equiv \triangle XYZ_2 \Rightarrow \angle XYZ_1 \equiv \angle XYZ_2 \& \angle YXZ_1 \equiv \angle YXZ_2$.²⁷⁵

Now suppose neither X nor Y lie on $a_{Z_1 Z_2}$. In this case $X' \in a_{XY} \& X' \neq X \neq Y \xrightarrow{T1.2.2} [X'XY] \vee [X'YX] \vee [XX'Y]$. Suppose $[X'XY]$ (See Fig. 1.116, b)).²⁷⁶ Then $Y \in Z_{iY} \& X' \in Z_{iX'} \& X \in Z_{iX} \xrightarrow{L1.2.21.6, L1.2.21.4} Z_{iX} \subset \text{Int} \angle YZ_i X'$, where $i = 1, 2$. $[X'XY] \xrightarrow{L1.2.11.15} X'_{iX} = X'_{iY} \Rightarrow \angle Z_1 X' X = \angle Z_1 X' Y \& \angle Z_2 X' X = \angle Z_2 X' Y$. Furthermore, arguing exactly as above, we see that $XZ_1 X' = \angle XZ_1 Z_2 \& \angle XZ_2 X' = \angle XZ_2 Z_1$, whence $\angle XZ_1 X' \equiv \angle XZ_2 X'$. Using T 1.3.9 we obtain $\angle XZ_1 Y \equiv \angle XZ_2 Y$, which allows us to write $XZ_1 \equiv XZ_2 \& YZ_1 \equiv YZ_2 \& \angle XZ_1 Y \equiv \angle XZ_2 Y \xrightarrow{T1.3.4} \triangle XZ_1 Y \equiv \triangle XZ_2 Y \Rightarrow \angle XYZ_1 \equiv \angle XYZ_2 \& \angle YXZ_1 \equiv \angle YXZ_2$.

Finally, suppose $[XX'Y]$ (See Fig. 1.116, c)). Then $[XX'Y] \Rightarrow [YX'X] \xrightarrow{L1.2.11.15} Y_{X'} = Y_X \Rightarrow \angle XYZ_i \equiv \angle X'Y Z_i$, where $i = 1, 2$. Together with $\angle X'Y Z_1 \equiv \angle X'Y Z_2$, this gives $\angle XYZ_1 \equiv \angle XYZ_2$. \square

Theorem 1.3.10 (Third Triangle Congruence Theorem (SSS)). *If all sides of a triangle $\triangle ABC$ are congruent to the corresponding sides of a triangle $\triangle A'B'C'$, i.e. if $AB \equiv A'B', BC \equiv B'C', AC \equiv A'C'$, the triangle $\triangle ABC$ is congruent to the triangle $\triangle A'B'C'$. In other words, if a triangle $\triangle ABC$ is weakly congruent to a triangle $\triangle A'B'C'$, this implies that the triangle $\triangle ABC$ is congruent to the triangle $\triangle A'B'C'$.*

Proof. (See Fig. 1.117.) By hypothesis, $\triangle ABC \simeq \triangle A'B'C'$, i.e., $AB \equiv A'B', BC \equiv B'C', AC \equiv A'C'$. Using A 1.3.4, A 1.3.1, L 1.2.11.3, choose B'' so that $C'_{B''} C'_{B'} a_{A'C'}$, $\angle ACB \equiv \angle A'C' B''$, $BC \equiv B'' C'$, and then choose B''' so that $C'_{B''} a_{A'C'} C'_{B''}$.²⁷⁷ Then we have $AC \equiv A'C' \& BC \equiv B'' C' \& \angle ACB \equiv \angle A'C' B'' \xrightarrow{T1.3.4} \triangle ABC \equiv \triangle A'B'' C' \Rightarrow AB \equiv A'B''$. $A'C' \equiv A'C' \& B'' C' \equiv B''' C' \& \angle A'C' B'' \equiv \angle A'C' B''' \xrightarrow{T1.3.4} \triangle A'B'' C' \equiv \triangle A'B''' C' \Rightarrow AB \equiv A'B''$. Since $AB \equiv A'B' \& AB \equiv A'B'' \& A'B'' \equiv A'B''' \& BC \equiv B'C' \& BC \equiv B'' C' \& B'' C' \equiv B''' C' \xrightarrow{T1.3.1} A'B''' \equiv A'B' \& A'B''' \equiv A'B'' \& B''' C' \equiv B' C' \& B''' C' \equiv B'' C' \xrightarrow{T1.3.1} B'' C' \equiv B' C', B'' B' a_{A'C'} \& B''' a_{A'C'} B'' \xrightarrow{L1.2.17.10} B''' a_{A'C'} B'$, we have $A'B''' \equiv A'B'' \& B''' C' \equiv B'' C' \& B''' a_{A'C'} B'' \xrightarrow{L1.3.10.1} \angle A'C' B''' \equiv \angle A'C' B''$, $A'B''' \equiv A'B' \& B''' C' \equiv B' C' \& B''' a_{A'C'} B' \xrightarrow{A1.3.4} \angle A'C' B''' \equiv \angle A'C' B' \& \angle A'C' B'' \equiv \angle A'C' B' \& C'_{B''} C'_{B'} a_{A'C'} \xrightarrow{A1.3.4} \angle A'C' B'' \equiv \angle A'C' B' \Rightarrow C'_{B''} = C'_{B'}, C' B'' \equiv C' B' \& C'_{B''} = C'_{B'} \xrightarrow{A1.3.1} B'' = B'.$ \square

Congruence of Angles and Congruence of Paths as Equivalence Relations

Lemma 1.3.11.1. *If angles $\angle(h', k'), \angle(h'', k'')$ are both congruent to an angle $\angle(h, k)$, the angles $\angle(h', k'), \angle(h'', k'')$ are congruent to each other, i.e., $\angle(h', k') \equiv \angle(h'', k'')$ and $\angle(h'', k'') \equiv \angle(h', k')$.*

Proof. (See Fig. 1.118.) Denote O, O', O'' the vertices of the angles $\angle(h, k), \angle(h', k'), \angle(h'', k'')$, respectively. Using A 1.3.1, choose $H \in h, K \in k, H' \in h', K' \in k', H'' \in h''$ so that $OH \equiv O'H', OK \equiv O'K', OH \equiv O''H'', OK \equiv O''K''$, whence by T 1.3.1 $O'H' \equiv OH, O'K' \equiv OK, O''H'' \equiv OH, O''K'' \equiv OK$, and by L 1.2.21.1 $\angle HOK = \angle(h, k), \angle H'O'K' = \angle(h', k'), \angle H''O''K'' = \angle(h'', k'')$. Then we have $O'H' \equiv OH \& O'K' \equiv OK \& \angle H'O'K' \equiv \angle HOK \& O''H'' \equiv OH \& O''K'' \equiv OK \& \angle H''O''K'' \xrightarrow{T1.3.4} \triangle H'O'K' \equiv \triangle HOK \& \triangle H''O''K'' \equiv \triangle HOK \Rightarrow K'H' \equiv KH \& K''H'' \equiv KH \xrightarrow{T1.3.1} K'H' \equiv K''H''$. Also, $O'H' \equiv OH \& O''H'' \equiv OH \& O'K' \equiv OK \& O''K'' \equiv OK$

²⁷³We take into account that, obviously, $[Z_1 X' Z_2] \xrightarrow{L1.2.1.3} X' \in a_{Z_1 Z_2}$.

²⁷⁴We can assume this without loss of generality - see next footnote.

²⁷⁵Observe that the seemingly useless fact that $\angle YXZ_1 \equiv \angle YXZ_2$ allows us to avoid considering the case $Y \in a_{Z_1 Z_2}$ separately. Instead, we can substitute X for Y and Y for X to obtain the desired result, taking advantage of the symmetry of the conditions of the theorem with respect to this substitution.

²⁷⁶Again, because of obvious symmetry with respect to substitution $X \rightarrow Y, Y \rightarrow X$, we do not need to consider the case when $[X'YX]$. Note that we could have avoided this discussion altogether if we united both cases $[X'XY], [X'YX]$ into the equivalent $Y \in X'_{iX}, Y \neq X$, but the approach taken here has the appeal of being more illustrative.

²⁷⁷To be more precise, we take a point B_0 such that $C'_{B''} a_{A'C'} B_0$, and then, using A 1.3.4, draw the angle $\angle A'C' B'''$ such that $C'_{B''} B_0 a_{A'C'}$, $\angle A'C' B'' \equiv \angle A'C' B'''$, $B'' C' \equiv B''' C'$. We then have, of course, $C'_{B''} a_{A'C'} B_0 \& C'_{B''} B_0 a_{A'C'} \xrightarrow{L1.2.18.5} C'_{B''} a_{A'C'} C'_{B''}$. Using jargon, as we did here, allows one to avoid cluttering the proofs with trivial details, thus saving the space and intellectual energy of the reader for more intricate points.

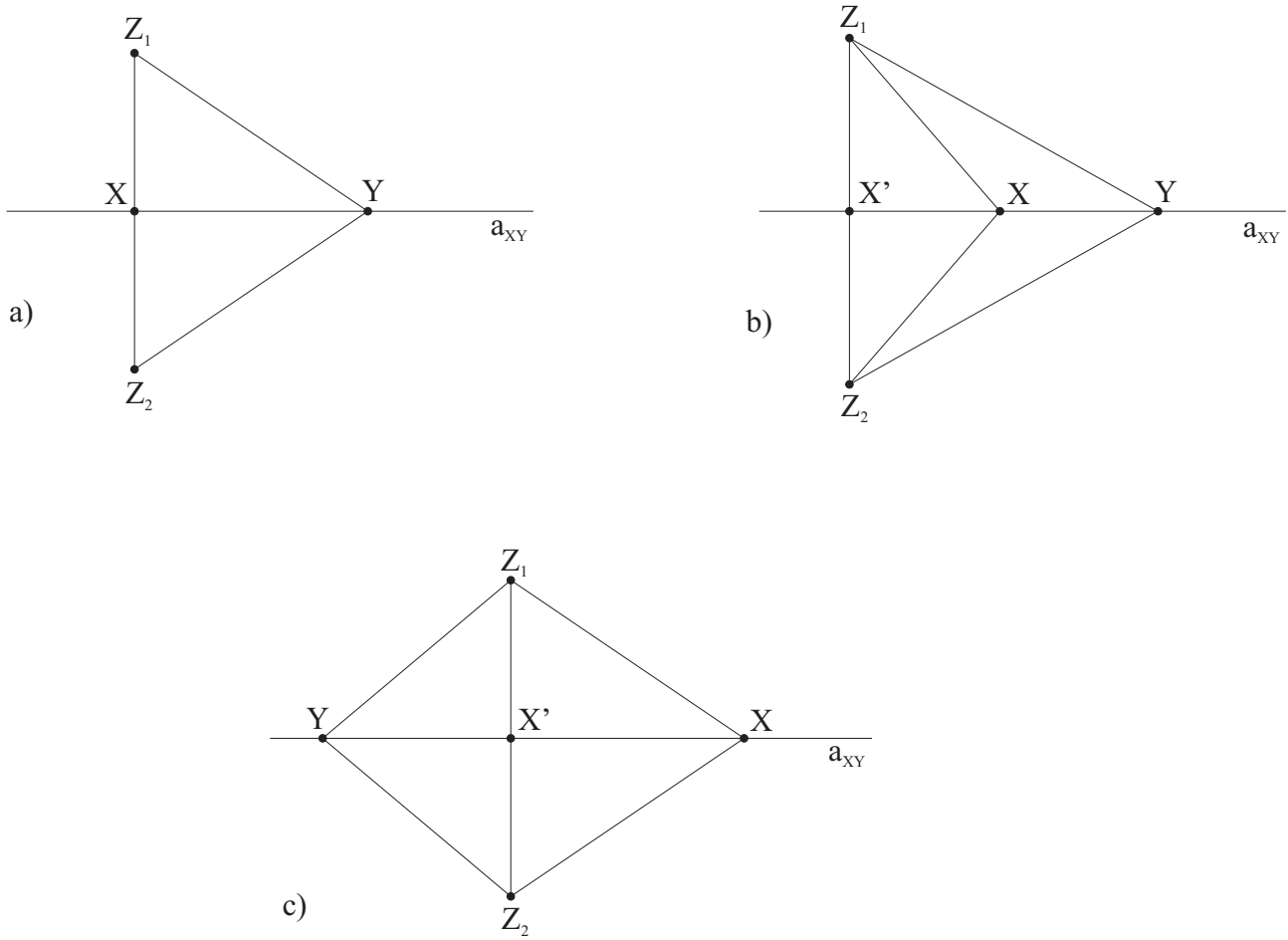

Figure 1.116: If points Z_1, Z_2 lie on opposite sides of a line a_{XY} , the congruences $XZ_1 \equiv XZ_2, YZ_1 \equiv YZ_2$ imply $\angle XYZ_1 \equiv \angle XYZ_2$. In a) Z_1, Z_2, X are collinear, i.e. $X \in a_{Z_1Z_2}$; in b), c) X, Y do not lie on $a_{Z_1Z_2}$ and $[X'XY]$ in b), $[XX'Y]$ in c).

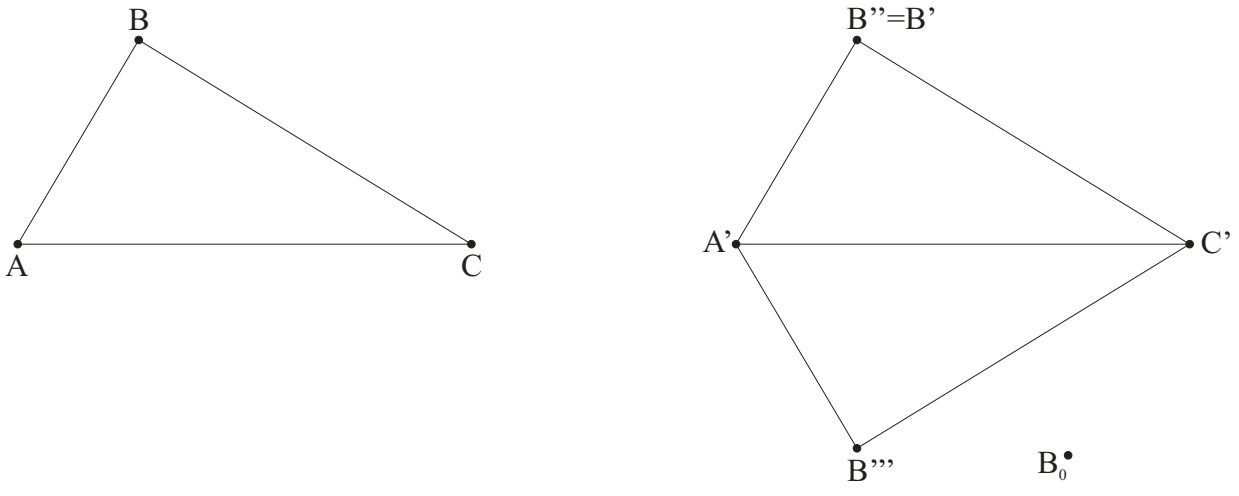

Figure 1.117: if $AB \equiv A'B', BC \equiv B'C', AC \equiv A'C'$, the triangle $\triangle ABC$ is congruent to the triangle $\triangle A'B'C'$ (SSS, or The Third Triangle Congruence Theorem).

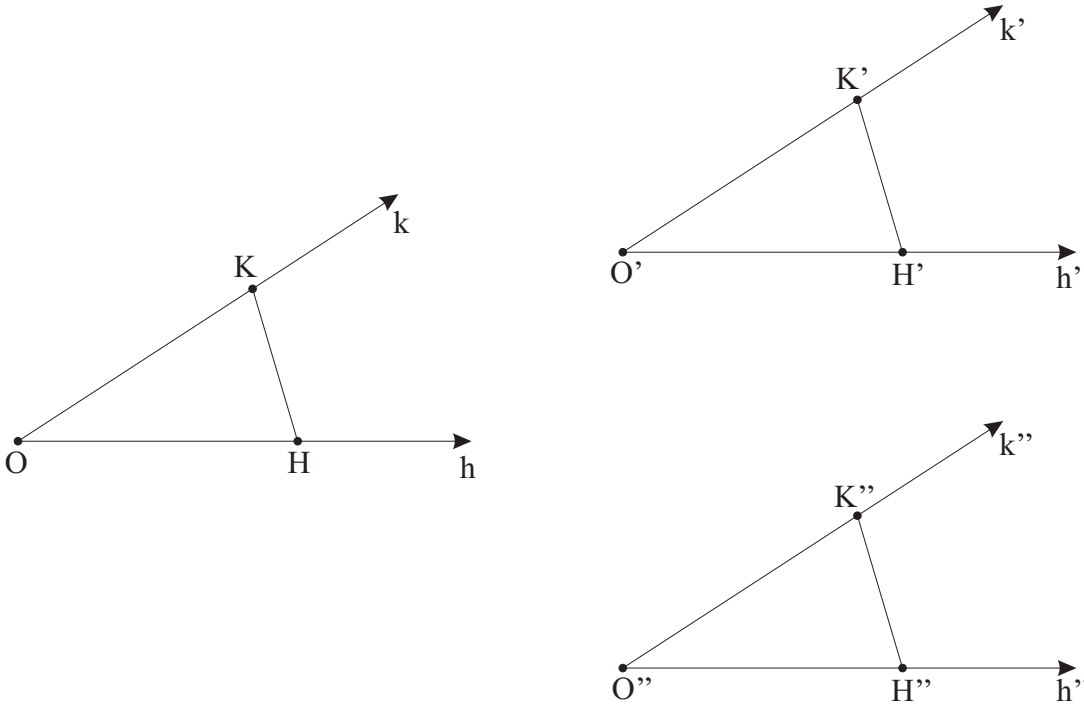

Figure 1.118: $\angle(h', k') \equiv \angle(h, k)$ and $\angle(h'', k'') \equiv \angle(h, k)$ imply $\angle(h', k') \equiv \angle(h'', k'')$ and $\angle(h'', k'') \equiv \angle(h', k')$.

$OK \xrightarrow{T1.3.1} O'H' \equiv O''H''$ & $O'K' \equiv O''K''$. Finally, $O'H' \equiv O''H''$ & $O'K' \equiv O''K''$ & $K'H' \equiv K''H'' \xrightarrow{T1.3.10} \Delta H'O'K' \equiv \Delta H''O''K'' \Rightarrow \angle H'O'K' \equiv \angle H''O''K'' \Rightarrow \angle(h', k') \equiv \angle(h'', k'')$. \square

Theorem 1.3.11. *Congruence of angles is a relation of equivalence on the class of all angles, i.e. it possesses the properties of reflexivity, symmetry, and transitivity.*

Proof. Reflexivity follows from A 1.3.4.

Symmetry: Let $\angle(h, k) \equiv \angle(h', k')$. Then $\angle(h', k') \equiv \angle(h', k') \& \angle(h, k) \equiv \angle(h', k') \xrightarrow{L1.3.11.1} \angle(h', k') \equiv \angle(h, k)$.

Transitivity: $\angle(h, k) \equiv \angle(h', k') \& \angle(h', k') \equiv \angle(h'', k'') \xrightarrow{\text{above}} \angle(h, k) \equiv \angle(h', k') \& \angle(h'', k'') \equiv \angle(h', k') \xrightarrow{L1.3.11.1} \angle(h, k) \equiv \angle(h'', k'')$. \square

Therefore, if an angle $\angle(h, k)$ is congruent to an angle $\angle(h', k')$, we can say the angles $\angle(h, k)$, $\angle(h', k')$ are congruent (to each other).

Corollary 1.3.11.2. *Congruence of paths (in particular, of polygons) is a relation of equivalence on the class of all paths. That is, any path $A_1A_2 \dots A_n$ is congruent to itself. If a path $A_1A_2 \dots A_n$ is congruent to a path $B_1B_2 \dots B_n$, the path $B_1B_2 \dots B_n$ is congruent to the path $A_1A_2 \dots A_n$. $A_1A_2 \dots A_n \equiv B_1B_2 \dots B_n$, $B_1B_2 \dots B_n \equiv C_1C_2 \dots C_n$ implies $A_1A_2 \dots A_n \equiv C_1C_2 \dots C_n$.*

Proof. \square

Again, if a path, in particular, a polygon, $A_1A_2 \dots A_n$ is congruent to a path $B_1B_2 \dots B_n$, we shall also say (and C 1.3.11.2 gives us the right to do so) that the paths $A_1A_2 \dots A_n$ and $B_1B_2 \dots B_n$ are congruent.

We are now in a position to prove theorem opposite to T 1.3.3.

Theorem 1.3.12. *If one angle, say, $\angle CAB$, of a triangle ΔABC is congruent to another angle, say, $\angle ACB$, then ΔABC is an isosceles triangle with $\angle ABC \equiv \angle ABC$.*

Proof. Let in a ΔABC $\angle CAB \equiv \angle ACB$. Then by T 1.3.12 $\angle ACB \equiv \angle CAB$ and $AC \equiv AC$ & $\angle CAB \equiv \angle ACB$ & $\angle CAB \equiv \angle ACB \xrightarrow{T1.3.11} \Delta CAB \equiv \Delta ACB \Rightarrow AB \equiv CB$. \square

Comparison of Intervals

Lemma 1.3.13.1. *For any point C lying on an open interval (AB) , there are points $E, F \in (AB)$ such that $AC \equiv EF$.*

Proof. (See Fig. 1.119.) Suppose $[ACB]$. By T 1.2.1 $\exists F [CFB]$. Then $[ACB] \& [CFB] \xrightarrow{L1.2.3.2} [ACF] \& [AFB]$. $[ACF] \& AF \equiv FA \xrightarrow{C1.3.9.2} \exists E [FEA] \& AC \equiv FE$. Finally, $[AEF] \& [AFB] \xrightarrow{L1.2.3.2} [AEB]$. \square

The following lemma is opposite, in a sense, to L 1.3.13.1



Figure 1.119: Construction for L 1.3.13.1, L 1.3.13.2.

Lemma 1.3.13.2. *For any two (distinct) points E, F lying on an open interval (AB) , there is exactly one point $C \in (AB)$ such that $EF \equiv AC$.*

Proof. (See Fig. 1.119.) By P 1.2.3.4 $[AEF] \vee [AFE]$. Since E, F enter the conditions of the lemma symmetrically, we can assume without any loss of generality that $[AEF]$. Then $AF \equiv FA \& [FEA] \xrightarrow{C1.3.9.2} \exists! C \ FE \equiv AC \& [ACF]$. Finally, $[ACF] \& [AFB] \xrightarrow{L1.2.3.2} [ACB]$. \square

An (abstract) interval $A'B'$ is said to be shorter, or less, than or congruent to an (abstract) interval AB , written $A'B' < AB$, if there is an interval CD such that the abstract interval $A'B'$ is congruent to the interval CD , and the open interval (CD) is included in the open interval (AB) .²⁷⁸ If $A'B'$ is shorter than or congruent to AB , we write this fact as $A'B' \leq AB$. Also, if an interval $A'B'$ is shorter than or congruent to an interval AB , we shall say that the (abstract) interval AB is longer, or greater than or congruent to the (abstract) interval $A'B'$, and write this as $AB \geq A'B'$.

If an (abstract) interval $A'B'$ is shorter than or congruent to an (abstract) interval AB , and, on the other hand, the interval $A'B'$ is known to be incongruent (not congruent) to the interval AB , we say that the interval $A'B'$ is strictly shorter, or strictly less²⁷⁹ than the interval AB , and write $A'B' < AB$. If an interval $A'B'$ is (strictly) shorter than an interval AB , we shall say also that the (abstract) interval AB is strictly longer, or strictly greater²⁸⁰ than (abstract) interval $A'B'$, and write this as $AB > A'B'$.

Lemma 1.3.13.3. *An interval $A'B'$ is (strictly) shorter than an interval AB iff:*

- 1. *There exists a point C on the open interval (AB) such that the interval $A'B'$ is congruent to the interval AC ;²⁸¹ or*
- 2. *There are points E, F on the open interval AB such that $A'B' \equiv EF$.*

In other words, an interval $A'B'$ is strictly shorter than an interval AB iff there is an interval CD , whose ends both lie on a half-open $[AB)$ (half-closed interval $[AB)$), such that the interval $A'B'$ is congruent to the interval CD .

Proof. Suppose $A'B' \equiv AC$ and $C \in (AB)$. Then by L 1.2.3.2, L 1.2.11.13 $C \in (AB) \Rightarrow (AC) \subset AB \& C \in A_B$. Therefore, $A'B' \leq AB$. Also, $A'B' \not\equiv AB$, because otherwise $C \in A_B \& A'B' \equiv AC \& A'B' \equiv AB \xrightarrow{A1.3.1} AC = AB \Rightarrow C = B$, whence $C \notin (AB)$ - a contradiction. Thus, we have $A'B' \leq AB \& A'B' \not\equiv AB$, i.e. $A'B' < AB$.

Suppose $A'B' \equiv EF$, where $E \in (AB), F \in (AB)$. By L 1.3.13.2 $\exists C \ C \in (AB) \& EF \equiv AC$. Then $A'B' \equiv EF \& EF \equiv AC \xrightarrow{T1.3.1} A'B' \equiv AC$ and $A'B' \equiv AC \& C \in (AB) \xrightarrow{\text{above}} A'B' < AB$.

Now suppose $A'B' < AB$. By definition, this means that there exists an (abstract) interval CD such that $(CD) \subset (AB)$, $A'B' \equiv CD$, and also $A'B' \not\equiv AB$. Then we have $(CD) \subset (AB) \xrightarrow{L1.2.16.10} C \in [AB] \& D \in [AB]$, $A'B' \not\equiv AB \& A'B' \equiv CD \Rightarrow CD \neq AB$. Therefore, either one of the ends or both ends of the interval CD lie on the open interval (AB) . The statement in 1. then follows from L 1.3.13.2, in 2.- from L 1.3.13.3. \square

Observe that the lemma L 1.3.13.3 (in conjunction with A 1.3.1) indicates that we can lay off from any point an interval shorter than a given interval. Thus, there is actually no such thing as the shortest possible interval.

Corollary 1.3.13.4. *If a point C lies on an open interval (AB) (i.e. C lies between A and B), the interval AC is (strictly) shorter than the abstract interval AB .*

If two (distinct) points E, F lie on an open interval (AB) , the interval EF is (strictly) less than the interval AB .

Proof. Follows immediately from L 1.3.13.3. \square

Lemma 1.3.13.5. *An interval $A'B'$ is shorter than or congruent to an interval AB iff there is an interval CD whose ends both lie on the closed interval $[AB]$, such that the interval $A'B'$ is congruent to the interval CD .*

Proof. Follows immediately from L 1.2.16.12 and the definition of "shorter than or congruent to". \square

Lemma 1.3.13.6. *If an interval $A''B''$ is congruent to an interval $A'B'$ and the interval $A'B'$ is less than an interval AB , the interval $A''B''$ is less than the interval AB .*

Proof. (See Fig. 1.120.) By definition and L 1.3.13.3, $A'B' < AB \Rightarrow \exists C \ C \in (AB) \& A'B' \equiv AC$. $A''B'' \equiv A'B' \& A'B' \equiv AC \xrightarrow{T1.3.1} A''B'' \equiv AC$. $A''B'' \equiv AC \& C \in (AB) \Rightarrow A''B'' < AB$. \square

²⁷⁸This definition is obviously consistent, as can be seen if we let $CD = AB$.

²⁷⁹We shall usually omit the word 'strictly'.

²⁸⁰Again, we shall omit the word 'strictly' whenever we feel that this omission does not lead to confusion

²⁸¹We could have said here also that $A'B' < AB$ iff there is a point $D \in (AB)$ such that $A'B' \equiv BD$, but because of symmetry this adds nothing new to the statement of the theorem, so we do not need to consider this case separately.

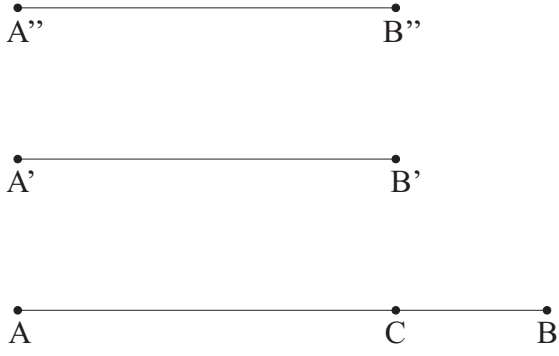

Figure 1.120: If an interval $A''B''$ is congruent to an interval $A'B'$ and the interval $A'B'$ is less than an interval AB , the interval $A''B''$ is less than the interval AB .

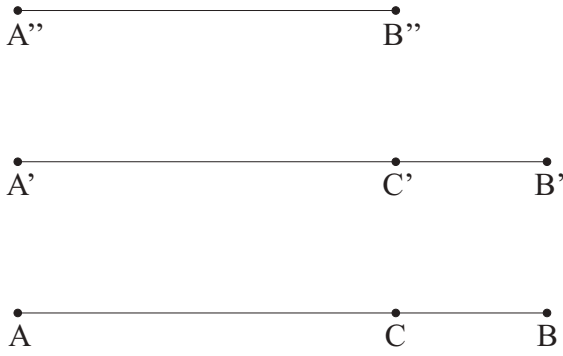

Figure 1.121: If an interval $A''B''$ is less than an interval $A'B'$ and the interval $A'B'$ is congruent to an interval AB , the interval $A''B''$ is less than the interval AB .

Lemma 1.3.13.7. *If an interval $A''B''$ is less than an interval $A'B'$ and the interval $A'B'$ is congruent to an interval AB , the interval $A''B''$ is less than the interval AB .*

Proof. (See Fig. 1.121.) $A''B'' < A'B' \Rightarrow \exists C' C' \in (A'B') \& A''B'' \equiv A'C'$. $A'B' \equiv AB \& C' \in (A'B') \xrightarrow{C1.3.9.2} \exists C C \in (AB) \& A'C' \equiv AC$. $A''B'' \equiv A'C' \& A'C' \equiv AC \xrightarrow{T1.3.1} A''B'' \equiv AC$. $A''B'' \equiv AC \& C \in (AB) \Rightarrow A''B'' < AB$. \square

Lemma 1.3.13.8. *If an interval $A''B''$ is less than an interval $A'B'$ and the interval $A'B'$ is less than an interval AB , the interval $A''B''$ is less than the interval AB .*

Proof. (See Fig. 1.122.) $A''B'' < A'B' \Rightarrow \exists C' C' \in (A'B') \& A''B'' \equiv A'C'$. $A'B' < AB \Rightarrow \exists D D \in (AB) \& A'B' \equiv AD$. $C' \in (A'B') \& A'B' \equiv AD \xrightarrow{C1.3.9.2} \exists C C \in (AD) \& A'C' \equiv AC$. $A''B'' \equiv A'C' \& A'C' \equiv AC \xrightarrow{T1.3.1} A''B'' \equiv AC$. $[ACD] \& [ADB] \xrightarrow{L1.2.3.2} [ACB]$. $A''B'' \equiv AC \& [ACB] \Rightarrow A''B'' < AB$. \square

Lemma 1.3.13.9. *If an interval $A''B''$ is less than or congruent to an interval $A'B'$ and the interval $A'B'$ is less than or congruent to an interval AB , the interval $A''B''$ is less than or congruent to the interval AB .*

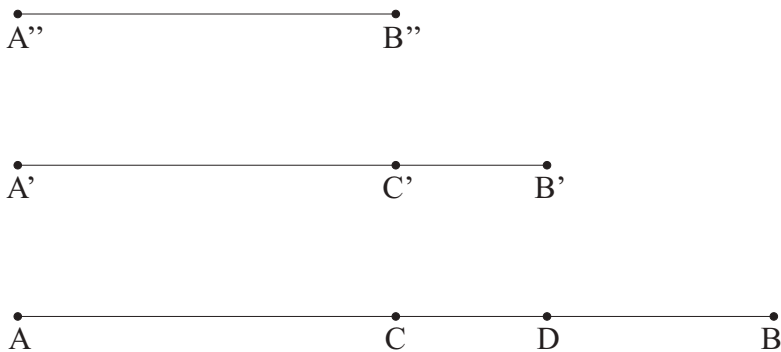

Figure 1.122: If an interval $A''B''$ is less than an interval $A'B'$ and the interval $A'B'$ is less than an interval AB , the interval $A''B''$ is less than the interval AB .

Proof. We have, using T 1.3.1, L 1.3.13.6, L 1.3.13.7, L 1.3.13.8 on the way: $A''B'' \leq A'B' \& A'B' \leq AB \Rightarrow (A''B'' < A'B' \vee A''B'' \equiv A'B') \& (A'B' < AB \vee A'B' \equiv AB) \Rightarrow (A''B'' < A'B' \& A'B' < AB) \vee (A''B'' < A'B' \& A'B' \equiv AB) \vee (A''B'' \equiv A'B' \& A'B' < AB) \vee (A''B'' \equiv A'B' \& A'B' \equiv AB) \Rightarrow A'' < B'' \vee A''B'' \equiv AB \Rightarrow A''B'' \leq AB. \square$

Lemma 1.3.13.10. *If an interval $A'B'$ is less than an interval AB , the interval AB cannot be less than the interval $A'B'$.*

Proof. Suppose the contrary, i.e., that both $A'B' < AB$ and $AB < A'B'$, that is, $\exists C \ C \in (AB) \& A'B' \equiv AC$ and $\exists C' \ C' \in (A'B') \& AB \equiv A'C'$. Then $A'B' \equiv AC \xrightarrow{T1.3.1} AC \equiv A'B'$ and $AC \equiv A'B' \& AB \equiv A'C' \& [ACB] \xrightarrow{C1.3.9.4} C' \in ExtA'B' -$ a contradiction with $C' \in (A'B')$. \square

Lemma 1.3.13.11. *If an interval $A'B'$ is less than an interval AB , it cannot be congruent to that interval.*

Proof. Suppose the contrary, i.e. that both $A'B' < AB$ and $A'B' \equiv AB$. We have then $A'B' < AB \Rightarrow \exists C \ C \in (AB) \& A'B' \equiv AC. [ACB] \xrightarrow{L1.2.11.13} C \in A_B. But A'B' \equiv AC \& A'B' \equiv AB \& C \in A_B \xrightarrow{A1.3.1} C = B -$ a contradiction. \square

Corollary 1.3.13.12. *If an interval $A'B'$ is congruent to an interval AB , neither $A'B'$ is shorter than AB , nor AB is shorter than $A'B'$.*

Proof. Follows immediately from L 1.3.13.11. \square

Lemma 1.3.13.13. *If an interval $A'B'$ is less than or congruent to an interval AB and the interval AB is less than or congruent to the interval $A'B'$, the interval $A'B'$ is congruent to the interval AB .*

Proof. $(A'B' < AB \vee A'B' \equiv AB) \& (AB < A'B' \vee AB \equiv A'B') \Rightarrow A'B' \equiv AB$, because $A'B' < AB$ contradicts both $AB < A'B'$ and $A'B' \equiv AB$ in view of L 1.3.13.10, L 1.3.13.11. \square

Lemma 1.3.13.14. *If an interval $A'B'$ is not congruent to an interval AB , then either the interval $A'B'$ is less than the interval AB , or the interval AB is less than the interval $A'B'$.*

Proof. Using A 1.3.1, choose points $C \in A_B, C' \in A'_{B'}$ so that $A'B' \equiv AC, AB \equiv A'C'$. Then $C \neq B$, because $A'B' \not\equiv AB$ by hypothesis, and $C \in A_B \& C \neq B \xrightarrow{L1.2.11.8} [ACB] \vee [ABC]$. We have in the first case (i.e., when $[ACB] \ [ACB] \& A'B' \equiv AC \Rightarrow A'B' < AB$, and in the second case $AB \equiv A'C' \& AC \equiv A'B' \& [ABC] \& C' \in A'_{B'} \xrightarrow{L1.3.9.1} [A'C'B'], [A'C'B'] \& AB \equiv A'C' \Rightarrow AB < A'B'$. \square

An (extended) angle $\angle(h', k')$ is said to be less than or congruent to an (extended) angle $\angle(h, k)$ if there is an angle $\angle(l, m)$ with the same vertex O as $\angle(h, k)$ such that the angle $\angle(h', k')$ is congruent to the angle $\angle(l, m)$ and the interior of the angle $\angle(l, m)$ is included in the interior of the angle $\angle(h, k)$. If $\angle(h', k')$ is less than or congruent to $\angle(h, k)$, we shall write this fact as $\angle(h', k') \leq \angle(h, k)$. If an angle $\angle(h', k')$ is less than or congruent to an angle $\angle(h, k)$, we shall also say that the angle $\angle(h, k)$ is greater than or congruent to the angle $\angle(h', k')$, and write this as $\angle(h, k) \geq \angle(h', k')$.

If an angle $\angle(h', k')$ is less than or congruent to an angle $\angle(h, k)$, and, on the other hand, the angle $\angle(h', k')$ is known to be incongruent (not congruent) to the angle $\angle(h, k)$, we say that the angle $\angle(h', k')$ is strictly less²⁸² than the angle $\angle(h, k)$, and write this as $\angle(h', k') < \angle(h, k)$. If an angle $\angle(h', k')$ is (strictly) less than an angle $\angle(h, k)$, we shall also say that the angle $\angle(h, k)$ is strictly greater²⁸³ than the angle $\angle(h', k')$.

Obviously, this definition implies that any non-straight angle is less than a straight angle.

We are now in a position to prove for angles the properties of the relations "less than" and "less than or congruent to" (and, for that matter, the properties of the relations "greater than" and "greater than or congruent to") analogous to those of the corresponding relations of (point) intervals. It turns out, however, that we can do this in a more general context. Some definitions are in order.

Generalized Congruence

Let \mathcal{C}^{gbr} be a subclass of the class \mathcal{C}_0^{gbr} of all those sets \mathfrak{J} that are equipped with a (weak) generalized betweenness relation.²⁸⁴ Generalized congruence is then defined by its properties Pr 1.3.1 – Pr 1.3.5 as a relation $\rho \subset \mathfrak{J}^2$, where $\mathfrak{J} \equiv \{\{\mathcal{A}, \mathcal{B}\} \mid \exists \mathfrak{J} \in \mathcal{C}^{gbr} \ \mathcal{A} \in \mathfrak{J} \& \mathcal{B} \in \mathfrak{J}\}$.²⁸⁵ If a pair $(\mathcal{AB}, \mathcal{CD}) \in \rho$, we say that the generalized abstract interval \mathcal{AB}

²⁸²We shall usually omit the word 'strictly'.

²⁸³Again, the word 'strictly' is normally omitted

²⁸⁴As we shall see, in practice the subclass \mathcal{C}^{gbr} is "homogeneous", i.e. its elements are of the same type: they are either all lines, or pencils of rays lying on the same side of a given line, etc.

²⁸⁵This notation, obviously, shows that the two - element set (generalized abstract interval) $\{\mathcal{A}, \mathcal{B}\}$, formed by geometric objects \mathcal{A}, \mathcal{B} , lies in the set $\{\{\mathcal{A}, \mathcal{B}\} \mid \exists \mathfrak{J} \in \mathcal{C}^{gbr} \ (\mathcal{A} \in \mathfrak{J} \& \mathcal{B} \in \mathfrak{J})\}$ iff there is a set \mathfrak{J} in \mathcal{C}^{gbr} , containing both \mathcal{A} and \mathcal{B} .

is congruent to the generalized abstract interval \mathcal{CD} and write, as usual, $\mathcal{AB} \equiv \mathcal{CD}$. We also denote, for convenience, $\mathfrak{J}^\cup \equiv \bigcup_{\mathfrak{J} \in \mathcal{C}^{gbr}} \mathfrak{J}$.²⁸⁶

Property 1.3.1. *Suppose \mathcal{AB} is a generalized abstract interval formed by geometric objects \mathcal{A}, \mathcal{B} lying in a set \mathfrak{J} from the class \mathcal{C}^{gbr} . Then for any geometric object $\mathcal{A}' \in \mathfrak{J}^\cup$ and any geometric object $\mathcal{X}' \in \mathfrak{J}^\cup$ distinct from \mathcal{A}' and such that $\mathcal{A}'\mathcal{X}' \in \mathfrak{J}$,²⁸⁷ there is at least one geometric object $\mathcal{B}' \in \mathfrak{J}^\cup$ with the properties that $\mathcal{X}', \mathcal{B}'$ lie in some set $\mathfrak{J}' \in \mathcal{C}^{gbr}$ on one side of the geometric object \mathcal{A}' ²⁸⁸ and such that the generalized interval \mathcal{AB} is congruent to the generalized interval $\mathcal{A}'\mathcal{B}'$.*

Furthermore, given two distinct geometric objects \mathcal{A}, \mathcal{B} , where $\mathcal{A}, \mathcal{B} \in \mathfrak{J} \in \mathcal{C}^{gbr}$, and a geometric object $\mathcal{A}' \in \mathfrak{J}' \in \mathcal{C}^{gbr}$, then for any geometric object $\mathcal{X}' \in \mathfrak{J}'$, $\mathcal{X}' \neq \mathcal{A}'$, there is at most²⁸⁹ one geometric object \mathcal{B}' such that $\mathcal{X}', \mathcal{B}'$ lie in the set \mathfrak{J}' with generalized betweenness relation on one side of the geometric object \mathcal{A}' and the generalized intervals \mathcal{AB} and $\mathcal{A}'\mathcal{B}'$ are congruent.

Property 1.3.2. *If generalized (abstract) intervals $\mathcal{A}'\mathcal{B}'$, where $\mathcal{A}', \mathcal{B}' \in \mathfrak{J}'$ and $\mathcal{A}''\mathcal{B}''$, where $\mathcal{A}'', \mathcal{B}'' \in \mathfrak{J}''$ are both congruent to a generalized interval \mathcal{AB} , where $\mathcal{A}, \mathcal{B} \in \mathfrak{J}$, then the generalized interval $\mathcal{A}'\mathcal{B}'$ is congruent to the generalized interval $\mathcal{A}''\mathcal{B}''$.*

Property 1.3.3. *If generalized intervals $\mathcal{AB}, \mathcal{A}'\mathcal{B}'$, as well as $\mathcal{AC}, \mathcal{A}'\mathcal{C}'$, formed by the geometric objects $\mathcal{A}, \mathcal{B}, \mathcal{C} \in \mathfrak{J}$ and $\mathcal{A}', \mathcal{B}', \mathcal{C}' \in \mathfrak{J}'$, (where $\mathfrak{J}, \mathfrak{J}' \in \mathcal{C}^{gbr}$) are congruent, \mathcal{B} divides \mathcal{A}, \mathcal{C} , and $\mathcal{B}', \mathcal{C}'$ lie on one side of \mathcal{A}' , then \mathcal{B}' divides $\mathcal{A}', \mathcal{C}'$, and $\mathcal{BC}, \mathcal{B}'\mathcal{C}'$ are congruent.²⁹⁰*

Property 1.3.4. *Suppose a geometric object \mathcal{B} lies in a set $\mathfrak{J} \in \mathcal{C}^{gbr}$ (with generalized betweenness relation) between geometric objects $\mathcal{A} \in \mathfrak{J}, \mathcal{C} \in \mathfrak{J}$. Then any set $\mathfrak{J}' \in \mathcal{C}^{gbr}$ containing the geometric objects \mathcal{A}, \mathcal{C} , will also contain the geometric object \mathcal{B} .*

Property 1.3.5. *Any generalized interval $\mathcal{AB} \in \mathfrak{J}, \mathcal{A}, \mathcal{B} \in \mathfrak{J}$, has a midpoint,²⁹¹ i.e. $\exists \mathcal{C} \mathcal{AC} \equiv \mathcal{AB}$, where $\mathcal{A}, \mathcal{B}, \mathcal{C} \in \mathfrak{J}$.*

The idea of generalized congruence is partly justified by the following L 1.3.13.15, T 1.3.13, although we are not yet in a position to fully prove that congruence of (conventional) intervals is a generalized congruence.

Lemma 1.3.13.15. *Congruence of (conventional) intervals satisfies the properties P 1.3.1 – P 1.3.3, P 1.3.6. (Here $\mathcal{C}^{gbr} = \{\mathfrak{J} | \mathfrak{J} = \mathcal{P}_a, a \in \mathcal{C}^L\}$ is the class of contours of all lines.)*

Proof. P 1.3.1 – P 1.3.3 in this case follow immediately from, respectively, A 1.3.1, A 1.3.2, and L 1.3.9.1. P 1.3.6 follows from the fact that in view of A 1.1.2 any line a (and thus the set \mathcal{P}_a of all its points) is completely defined by two points on it. \square

Theorem 1.3.13. *Congruence of conventional angles²⁹² satisfies the properties P 1.3.1 - P 1.3.3, P 1.3.6. Here the sets \mathfrak{J} with generalized betweenness relation are the pencils of rays lying on the same side of a given line a and having the same initial point $O \in a$ (Of course, every pair consisting of a line a and a point O on it gives rise to exactly two such pencils.); each of these pencils is supplemented with the (two) rays into which the appropriate point O (the pencil's origin, i.e. the common initial point of the rays that constitute the pencil) divides the appropriate line a .²⁹³*

Proof. The properties P 1.3.1 - P 1.3.3 follow in this case from A 1.3.4, L 1.3.11.1, T 1.3.9, P 1.3.9.5. To demonstrate P 1.3.6, suppose a ray n lies in a pencil \mathfrak{J} between rays l, m .²⁹⁴ Suppose now that the rays l, m also belong to another pencil \mathfrak{J}' . The result then follows from L 1.2.31.3 applied to \mathfrak{J}' viewed as a straight angle.²⁹⁵ \square

²⁸⁶It appears that all of the conditions Pr 1.3.1 – Pr 1.3.5 are necessary to explicate the relevant betweenness properties for points, rays, half-planes, etc. Unfortunately, the author is not aware of a shorter, simpler, or just more elegant system of conditions (should there exist one!) to characterize these properties.

²⁸⁷Recall that $\mathcal{A}'\mathcal{X}' \in \mathfrak{J}$ means there is a set \mathfrak{J}' in \mathcal{C}^{gbr} , such that $\mathcal{A}' \in \mathfrak{J}', \mathcal{X}' \in \mathfrak{J}'$.

²⁸⁸That is, geometric objects $\mathcal{A}', \mathcal{X}', \mathcal{B}'$ all lie in one set \mathfrak{J}' (with generalized betweenness relation), which lies in the class \mathcal{C}^{gbr} , and may be either equal to, or different from, the set \mathfrak{J} . Note that in our formulation of the following properties we shall also assume that the sets (possibly primed) \mathfrak{J} with generalized betweenness relation lie in the set \mathcal{C}^{gbr} .

²⁸⁹As always, "at most" in this context means "one or none".

²⁹⁰For the particular case where it is already known that the geometric object \mathcal{B}' divides the geometric objects $\mathcal{A}', \mathcal{C}'$, we can formulate the remaining part of this property as follows:

Let geometric objects $\mathcal{B} \in \mathfrak{J}$ and $\mathcal{B}' \in \mathfrak{J}'$ lie between geometric objects $\mathcal{A} \in \mathfrak{J}, \mathcal{C} \in \mathfrak{J}$ and $\mathcal{A}' \in \mathfrak{J}', \mathcal{C}' \in \mathfrak{J}'$, respectively. Then congruences $\mathcal{AB} \equiv \mathcal{A}'\mathcal{B}'$, $\mathcal{AC} \equiv \mathcal{A}'\mathcal{C}'$ imply $\mathcal{BC} \equiv \mathcal{B}'\mathcal{C}'$.

²⁹¹As explained above, $\mathcal{AB} \in \mathfrak{J}$ means that there is a set $\mathfrak{J} \in \mathcal{C}^{gbr}$ with a generalized betweenness relation containing the generalized abstract interval \mathcal{AB} . Note also that a geometric object does not have to be a point in order to be called a midpoint in this generalized sense. Later we will see that it can also be a ray, a half-plane, etc. To avoid confusion of this kind, we will also be referring to the midpoint \mathcal{AB} as the middle of this generalized interval.

²⁹²Conventional angles are those formed by rays made of points in the traditional sense, as opposed to angles formed by any other kind of generalized rays.

²⁹³Worded another way, we can say that each of the sets \mathfrak{J} is formed by the two sides of the corresponding straight angle plus all the rays with the same initial point inside that straight angle.

²⁹⁴Here the pencil \mathfrak{J} is formed by the rays lying on the same side of a given line a and having the same initial point $O \in a$, plus the two rays into which the point O divides the line a .

²⁹⁵Moreover, we are then able to immediately claim that the ray n lies between l, m in \mathfrak{J}' as well. (See also L 1.3.14.2.)

Let us now study the properties of generalized congruence. ²⁹⁶

Lemma 1.3.14.1. *Generalized congruence is an equivalence relation on the class \mathfrak{J} of appropriately chosen generalized abstract intervals, i.e., it is reflexive, symmetric, and transitive.*

Proof. Given a generalized interval \mathcal{AB} , where $\mathcal{A}, \mathcal{B} \in \mathfrak{J} \in \mathcal{C}^{gbr}$, by Pr 1.3.1 we have $\exists \mathcal{A}'\mathcal{B}' \mathcal{AB} \equiv \mathcal{A}'\mathcal{B}'$, $\mathcal{A}', \mathcal{B}' \in \mathfrak{J}' \in \mathcal{C}^{gbr}$.

Reflexivity: $\mathcal{AB} \equiv \mathcal{A}'\mathcal{B}' \& \mathcal{AB} \equiv \mathcal{A}'\mathcal{B}' \xrightarrow{\text{Pr1.3.2}} \mathcal{AB} \equiv \mathcal{AB}$.²⁹⁷

Symmetry: $\mathcal{A}'\mathcal{B}' \equiv \mathcal{A}'\mathcal{B}' \& \mathcal{AB} \equiv \mathcal{A}'\mathcal{B}' \xrightarrow{\text{Pr1.3.2}} \mathcal{A}'\mathcal{B}' \equiv \mathcal{AB}$.

Transitivity: $\mathcal{AB} \equiv \mathcal{A}'\mathcal{B}' \& \mathcal{A}'\mathcal{B}' \equiv \mathcal{A}''\mathcal{B}'' \Rightarrow \mathcal{A}'\mathcal{B}' \equiv \mathcal{AB} \& \mathcal{A}'\mathcal{B}' \equiv \mathcal{A}''\mathcal{B}'' \xrightarrow{\text{Pr1.3.2}} \mathcal{AB} \equiv \mathcal{A}''\mathcal{B}''$. \square

Now we can immediately reformulate the property Pr 1.3.6 in the following enhanced form:

Lemma 1.3.14.2. *Suppose a geometric object \mathcal{B} lies in a set $\mathfrak{J} \in \mathcal{C}^{gbr}$ (with generalized betweenness relation) between geometric objects $\mathcal{A} \in \mathfrak{J}$, $\mathcal{C} \in \mathfrak{J}$. Then any set $\mathfrak{J}' \in \mathcal{C}^{gbr}$ containing the geometric objects \mathcal{A} , \mathcal{C} , will also contain the geometric object \mathcal{B} , and \mathcal{B} will lie in \mathfrak{J}' between \mathcal{A} and \mathcal{C} .*

Proof. Suppose \mathcal{B} lies in $\mathfrak{J} \in \mathcal{C}^{gbr}$ between geometric objects \mathcal{A} , \mathcal{C} , and a set $\mathfrak{J}' \in \mathcal{C}^{gbr}$ also contains \mathcal{A} , \mathcal{C} . Then by Pr 1.3.6 $\mathcal{B} \in \mathfrak{J}'$. Hence on \mathfrak{J}' we have $\mathcal{A} \in \mathfrak{J}' \& \mathcal{B} \in \mathfrak{J}' \& \mathcal{C} \in \mathfrak{J}' \& \mathcal{A} \neq \mathcal{B} \neq \mathcal{C} \xrightarrow{\text{Pr1.2.5}} \mathcal{BAC} \vee \mathcal{ABC} \vee \mathcal{ACB}$. Now from L 1.2.25.13 it follows that in \mathfrak{J}' either \mathcal{B} , \mathcal{C} lie on one side of \mathcal{A} , or \mathcal{A} , \mathcal{B} lie on one side of \mathcal{C} . The preceding lemma gives $\mathcal{AB} \equiv \mathcal{AB}$, $\mathcal{AC} \equiv \mathcal{AC}$, $\mathcal{BC} \equiv \mathcal{BC}$. The facts listed in the preceding two sentences plus \mathcal{ABC} on \mathfrak{J} allow us to conclude, using P 1.3.3, that for all considered cases the geometric object \mathcal{B} will lie between \mathcal{A} and \mathcal{C} in \mathfrak{J}' as well, q.e.d. \square

Corollary 1.3.14.3. *Given congruent generalized intervals \mathcal{AC} , $\mathcal{A}'\mathcal{C}'$, where $\mathcal{A}, \mathcal{C} \in \mathfrak{J}$ and $\mathcal{A}', \mathcal{C}' \in \mathfrak{J}'$, ($\mathfrak{J}, \mathfrak{J}' \in \mathcal{C}^{gbr}$) then for any geometric object $\mathcal{B} \in (\mathcal{AC}) \subset \mathfrak{J}$ there is exactly one geometric object $\mathcal{B}' \in (\mathcal{A}'\mathcal{C}') \subset \mathfrak{J}'$ such that $\mathcal{AB} \equiv \mathcal{A}'\mathcal{B}'$, $\mathcal{BC} \equiv \mathcal{B}'\mathcal{C}'$.*

Proof. By Pr 1.3.1 there is a geometric object \mathcal{B}' such that $\mathcal{B}', \mathcal{C}'$ lie in some set $\mathfrak{J}'' \in \mathcal{C}^{gbr}$ on the same side of the geometric object \mathcal{A}' , and $\mathcal{AB} \equiv \mathcal{A}'\mathcal{B}'$. Since also, by hypothesis, we have $[\mathcal{ABC}]$ on \mathfrak{J} and $\mathcal{AC} \equiv \mathcal{A}'\mathcal{C}'$, using Pr 1.3.3 we find that \mathcal{B}' lies (in \mathfrak{J}'') between \mathcal{A}' , \mathcal{C}' , and, furthermore, the generalized intervals \mathcal{BC} , $\mathcal{B}'\mathcal{C}'$ are congruent. As the set \mathfrak{J}' by hypothesis also contains \mathcal{A}' , \mathcal{C}' , from the preceding lemma (L 1.3.14.2) we conclude that \mathcal{B}' lies between \mathcal{A}' , \mathcal{C}' in \mathfrak{J}' as well. Uniqueness the geometric object \mathcal{B}' with the required properties now follows immediately by the second part of Pr 1.3.1. \square

Lemma 1.3.14.4. *If generalized intervals \mathcal{AB} , \mathcal{BC} are congruent to generalized intervals $\mathcal{A}'\mathcal{B}'$, $\mathcal{B}'\mathcal{C}'$, respectively, where the geometric object $\mathcal{B} \in \mathfrak{J} \in \mathcal{C}^{gbr}$ lies between the geometric objects $\mathcal{A} \in \mathfrak{J}$ and $\mathcal{C} \in \mathfrak{J}$ and the geometric object $\mathcal{B}' \in \mathfrak{J}' \in \mathcal{C}^{gbr}$ lies between $\mathcal{A}' \in \mathfrak{J}'$ and $\mathcal{C}' \in \mathfrak{J}'$, then the generalized interval \mathcal{AC} is congruent to the generalized interval $\mathcal{A}'\mathcal{C}'$.*

Proof. By Pr 1.3.1 there exists a geometric object \mathcal{C}'' such that $\mathcal{C}', \mathcal{C}''$ lie in some set $\mathfrak{J}'' \in \mathcal{C}^{gbr}$ with generalized betweenness relation on one side of \mathcal{A}' and the generalized interval \mathcal{AC} is congruent to the generalized interval $\mathcal{A}'\mathcal{C}''$. Since $\mathcal{A}' \in \mathfrak{J}''$, $\mathcal{C}' \in \mathfrak{J}''$, and (by hypothesis) \mathcal{B}' lies in \mathfrak{J}' between \mathcal{A}' , \mathcal{C}' , by L 1.3.14.2 the geometric object \mathcal{B}' lies between \mathcal{A}' , \mathcal{C}' in \mathfrak{J}'' as well. In view of L 1.2.25.13 the last fact implies that the geometric objects \mathcal{B}' , \mathcal{C}'' lie in the set \mathfrak{J}'' on the same side of \mathcal{A}' . We can write $\mathcal{C}' \in \mathcal{A}'(\mathfrak{J}'') \& \mathcal{C}'' \in \mathcal{A}'(\mathfrak{J}'') \xrightarrow{\text{L1.2.25.5}} \mathcal{C}'' \in \mathcal{A}'(\mathfrak{J}'')$. $\mathcal{AB} \equiv \mathcal{A}'\mathcal{B}' \& \mathcal{AC} \equiv \mathcal{A}'\mathcal{C}'' \& [\mathcal{ABC}]^{(\mathfrak{J}'')} \& \mathcal{C}'' \in \mathcal{A}'(\mathfrak{J}'') \xrightarrow{\text{Pr1.3.3}} [\mathcal{A}'\mathcal{B}'\mathcal{C}'']^{(\mathfrak{J}'')} \& \mathcal{BC} \equiv \mathcal{B}'\mathcal{C}''$. $[\mathcal{A}'\mathcal{B}'\mathcal{C}'']^{(\mathfrak{J}'')} \& [\mathcal{A}'\mathcal{B}'\mathcal{C}']^{(\mathfrak{J}'')} \xrightarrow{\text{L1.2.25.10}} \& \mathcal{C}'' \in \mathcal{B}'(\mathfrak{J}'')$. $\mathcal{BC} \equiv \mathcal{B}'\mathcal{C}' \& \mathcal{BC} \equiv \mathcal{B}'\mathcal{C}'' \& \mathcal{C}'' \in \mathcal{B}'(\mathfrak{J}'') \xrightarrow{\text{Pr1.3.3}} \mathcal{C}'' = \mathcal{C}'$, whence the result. \square

Proposition 1.3.14.5. *Let pairs \mathcal{B} , \mathcal{C} and \mathcal{B}' , \mathcal{C}' of geometric objects $\mathcal{B}, \mathcal{C} \in \mathfrak{J}$ and $\mathcal{B}', \mathcal{C}' \in \mathfrak{J}'$ (where $\mathfrak{J}, \mathfrak{J}' \in \mathcal{C}^{gbr}$) lie either both on one side or both on opposite sides of the geometric objects $\mathcal{A} \in \mathfrak{J}$ and $\mathcal{A}' \in \mathfrak{J}'$, respectively. Then congruences $\mathcal{AB} \equiv \mathcal{A}'\mathcal{B}'$, $\mathcal{AC} \equiv \mathcal{A}'\mathcal{C}'$ imply $\mathcal{BC} \equiv \mathcal{B}'\mathcal{C}'$.*

Proof. First, suppose $\mathcal{B} \in \mathcal{A}_c$, $\mathcal{B}' \in \mathcal{A}'_{c'}$. $\mathcal{B} \in \mathcal{A}_c \& \mathcal{B} \neq \mathcal{C} \xrightarrow{\text{L1.2.25.8}} [\mathcal{ABC}] \vee [\mathcal{ACB}]$. Let $[\mathcal{ABC}]$.²⁹⁸ Then $[\mathcal{ABC}] \& \mathcal{B}' \in \mathcal{A}'_{c'} \& \mathcal{AB} \equiv \mathcal{A}'\mathcal{B}' \& \mathcal{AC} \equiv \mathcal{A}'\mathcal{C}' \xrightarrow{\text{Pr1.3.3}} \mathcal{BC} \equiv \mathcal{B}'\mathcal{C}'$.

If \mathcal{B} , \mathcal{C} and \mathcal{B}' , \mathcal{C}' lie on opposite sides of \mathcal{A} and \mathcal{A}' , respectively, we have $[\mathcal{BAC}] \& [\mathcal{B}'\mathcal{A}'\mathcal{C}'] \& \mathcal{AB} \equiv \mathcal{A}'\mathcal{B}' \& \mathcal{AC} \equiv \mathcal{A}'\mathcal{C}' \xrightarrow{\text{L1.3.14.4}} \mathcal{BC} \equiv \mathcal{B}'\mathcal{C}'$. \square

²⁹⁶When applied to the particular cases of conventional (point-pair) or angular abstract intervals, they sometimes reiterate or perhaps even weaken some already proven results. We present them here nonetheless to illustrate the versatility and power of the unified approach. Furthermore, the proofs of general results are more easily done when following in the footsteps of the illustrated proofs of the particular cases.

Also, to avoid clumsiness of statements and proofs, we shall often omit mentioning that a given geometric object lies in a particular set with generalized betweenness relation when this appears to be obvious from context.

²⁹⁷As shown above, the availability of an interval $\mathcal{A}'\mathcal{B}' \in \mathfrak{J}$ with the property $\mathcal{AB} \equiv \mathcal{A}'\mathcal{B}'$ is guaranteed by Pr 1.3.1.

²⁹⁸Since \mathcal{B} , \mathcal{C} enter the conditions of the proposition symmetrically, as do \mathcal{B}' , \mathcal{C}' , because $\mathcal{B}' \in \mathcal{A}'_{c'} \xrightarrow{\text{L1.2.25.3}} \mathcal{C}' \in \mathcal{A}'_{b'}$, we do not really need to consider the case when $[\mathcal{ACB}]$.

Corollary 1.3.14.6. *Let generalized intervals \mathcal{AB} , $\mathcal{A}'\mathcal{B}'$, as well as \mathcal{AC} , $\mathcal{A}'\mathcal{C}'$, formed by the geometric objects $\mathcal{A}, \mathcal{B}, \mathcal{C} \in \mathfrak{J}$ and $\mathcal{A}', \mathcal{B}', \mathcal{C}' \in \mathfrak{J}'$, (where $\mathfrak{J}, \mathfrak{J}' \in \mathcal{C}^{gbr}$), be congruent. Then if the geometric object \mathcal{B} lies between the geometric \mathcal{A} , \mathcal{C} , the geometric object \mathcal{C}' lies outside the generalized interval $\mathcal{A}'\mathcal{B}'$ (i.e. \mathcal{C}' lies in the set $\text{Ext}\mathcal{A}'\mathcal{B}' = \mathfrak{J}' \setminus [\mathcal{A}'\mathcal{B}']$).*

Proof. $[\mathcal{ABC}] \stackrel{\text{L1.2.25.13}}{\implies} \mathcal{C} \in \mathcal{A}_{\mathcal{B}}$. $\mathcal{B}' \neq \mathcal{C}'$, because otherwise $\mathcal{A}'\mathcal{B}' \equiv \mathcal{AB} \& \mathcal{A}'\mathcal{C}' \equiv \mathcal{AC} \& \mathcal{B}' = \mathcal{C}' \& \mathcal{C} \in \mathcal{A}_{\mathcal{B}} \stackrel{\text{Pr1.3.1}}{\implies} \mathcal{B} = \mathcal{C}$ - a contradiction. Also, $\mathcal{C}' \notin (\mathcal{A}'\mathcal{B}')$, because otherwise $[\mathcal{A}'\mathcal{C}'\mathcal{B}'] \& \mathcal{C} \in \mathcal{A}_{\mathcal{B}} \& \mathcal{A}'\mathcal{B}' \equiv \mathcal{AB} \& \mathcal{A}'\mathcal{C}' \equiv \mathcal{AC} \stackrel{\text{L1.3.14.4}}{\implies} [\mathcal{ACB}] \Rightarrow \neg[\mathcal{ABC}]$ - a contradiction. \square

Theorem 1.3.14. *Suppose finite sequences of n geometric objects $\mathcal{A}_1, \mathcal{A}_2, \dots, \mathcal{A}_n$ and $\mathcal{B}_1, \mathcal{B}_2, \dots, \mathcal{B}_n$, where $\mathcal{A}_i \in \mathfrak{J}$, $\mathcal{B}_i \in \mathfrak{J}'$, $i = 1, 2, \dots, n$, $\mathfrak{J} \in \mathcal{C}^{gbr}$, $\mathfrak{J}' \in \mathcal{C}^{gbr}$, $n \geq 3$, have the property that every geometric object of the sequence, except the first ($\mathcal{A}_1, \mathcal{B}_1$) and the last ($\mathcal{A}_n, \mathcal{B}_n$, respectively), lies between the two geometric objects of the sequence with the numbers adjacent (in \mathbb{N}) to the number of the given geometric object. Then if all generalized intervals formed by pairs of geometric objects of the sequence $\mathcal{A}_1, \mathcal{A}_2, \dots, \mathcal{A}_n$ with adjacent (in \mathbb{N}) numbers are congruent to the corresponding generalized intervals²⁹⁹ of the sequence $\mathcal{B}_1, \mathcal{B}_2, \dots, \mathcal{B}_n$, the generalized intervals formed by the first and the last geometric objects of the sequences are also congruent, $\mathcal{A}_1\mathcal{A}_n \equiv \mathcal{B}_1\mathcal{B}_n$. To recapitulate in more formal terms, let $\mathcal{A}_1, \mathcal{A}_2, \dots, \mathcal{A}_n$ and $\mathcal{B}_1, \mathcal{B}_2, \dots, \mathcal{B}_n$, $n \geq 3$, be finite sequences of geometric objects $\mathcal{A}_i \in \mathfrak{J}$, $\mathcal{B}_i \in \mathfrak{J}'$, $i = 1, 2, \dots, n$, $\mathfrak{J} \in \mathcal{C}^{gbr}$, $\mathfrak{J}' \in \mathcal{C}^{gbr}$, such that $[\mathcal{A}_i\mathcal{A}_{i+1}\mathcal{A}_{i+2}]$, $[\mathcal{B}_i\mathcal{B}_{i+1}\mathcal{B}_{i+2}]$ for all $i \in \mathbb{N}_{n-2}$ (i.e. $\forall i = 1, 2, \dots, n-2$). Then congruences $\mathcal{A}_i\mathcal{A}_{i+1} \equiv \mathcal{B}_i\mathcal{B}_{i+1}$ for all $i \in \mathbb{N}_{n-1}$ imply $\mathcal{A}_1\mathcal{A}_n \equiv \mathcal{B}_1\mathcal{B}_n$.*

Proof. By induction on n . For $n = 3$ see Pr 1.3.3. Now suppose $\mathcal{A}_1\mathcal{A}_{n-1} \equiv \mathcal{B}_1\mathcal{B}_{n-1}$ (induction!).³⁰⁰ We have $[\mathcal{A}_1\mathcal{A}_{n-1}\mathcal{A}_n]$, $[\mathcal{B}_1\mathcal{B}_{n-1}\mathcal{B}_n]$ by L 1.2.22.14. Therefore, $[\mathcal{A}_1\mathcal{A}_{n-1}\mathcal{A}_n] \& [\mathcal{B}_1\mathcal{B}_{n-1}\mathcal{B}_n] \& \mathcal{A}_1\mathcal{A}_{n-1} \equiv \mathcal{B}_1\mathcal{B}_{n-1} \& \mathcal{A}_{n-1}\mathcal{A}_n \equiv \mathcal{B}_{n-1}\mathcal{B}_n \stackrel{\text{L1.3.14.4}}{\implies} \mathcal{A}_1\mathcal{A}_n \equiv \mathcal{B}_1\mathcal{B}_n$. \square

Comparison of Generalized Intervals

Lemma 1.3.15.1. *For any geometric object \mathcal{C} lying on a generalized open interval (\mathcal{AB}) , where $\mathcal{A}, \mathcal{B}, \mathcal{C} \in \mathfrak{J}$, $\mathfrak{J} \in \mathcal{C}^{gbr}$, there are geometric objects $\mathcal{E} \in (\mathcal{AB})$, $\mathcal{F} \in (\mathcal{AB})$ such that $\mathcal{AC} \equiv \mathcal{EF}$.*

Proof. Suppose $[\mathcal{ACB}]$. By Pr 1.2.4 $\exists \mathcal{F} \in \mathfrak{J}$ such that $[\mathcal{CFB}]$. Then $[\mathcal{ACB}] \& [\mathcal{CFB}] \stackrel{\text{Pr1.2.7}}{\implies} [\mathcal{ACF}] \& [\mathcal{AFB}]$. $[\mathcal{ACF}] \& \mathcal{AF} \equiv \mathcal{FA} \stackrel{\text{C1.3.14.3}}{\implies} \exists \mathcal{E} \in \mathfrak{J} \& [\mathcal{FEA}] \& \mathcal{AC} \equiv \mathcal{FE}$. Finally, $[\mathcal{AEF}] \& [\mathcal{AFB}] \stackrel{\text{Pr1.2.7}}{\implies} [\mathcal{AEB}]$. \square

The following lemma is opposite, in a sense, to L 1.3.15.1

Lemma 1.3.15.2. *For any two (distinct) geometric objects \mathcal{E} , \mathcal{F} lying on a generalized open interval (\mathcal{AB}) , where $\mathcal{A}, \mathcal{B} \in \mathfrak{J}$, $\mathfrak{J} \in \mathcal{C}^{gbr}$, there is exactly one geometric object $\mathcal{C} \in (\mathcal{AB})$ such that $\mathcal{EF} \equiv \mathcal{AC}$.*

Proof. By P 1.2.22.6 $[\mathcal{AEF}] \vee [\mathcal{AFE}]$. Since \mathcal{E} , \mathcal{F} enter the conditions of the lemma symmetrically, we can assume without any loss of generality that $[\mathcal{AEF}]$. Then $\mathcal{AF} \equiv \mathcal{FA} \& [\mathcal{FEA}] \stackrel{\text{C1.3.14.3}}{\implies} \exists! \mathcal{C} \mathcal{FE} \equiv \mathcal{AC} \& [\mathcal{ACF}]$. Finally, $[\mathcal{ACF}] \& [\mathcal{AFB}] \stackrel{\text{Pr1.2.7}}{\implies} [\mathcal{ACB}]$. \square

A generalized (abstract) interval $\mathcal{A}'\mathcal{B}'$, where $\mathcal{A}', \mathcal{B}' \in \mathfrak{J}'$, $\mathfrak{J}' \in \mathcal{C}^{gbr}$, is said to be shorter, or less, than or congruent to a generalized (abstract) interval \mathcal{AB} , where $\mathcal{A}, \mathcal{B} \in \mathfrak{J}$, $\mathfrak{J} \in \mathcal{C}^{gbr}$, if there is a generalized interval \mathcal{CD} ³⁰¹ such that the generalized abstract interval $\mathcal{A}'\mathcal{B}'$ is congruent to the generalized interval \mathcal{CD} , and the generalized open interval (\mathcal{CD}) is included in the generalized open interval (\mathcal{AB}) .³⁰² If $\mathcal{A}'\mathcal{B}'$ is shorter than or congruent to \mathcal{AB} , we write this fact as $\mathcal{A}'\mathcal{B}' \leq \mathcal{AB}$. Also, if a generalized interval $\mathcal{A}'\mathcal{B}'$ is shorter than or congruent to a generalized interval \mathcal{AB} , we shall say that the generalized (abstract) interval \mathcal{AB} is longer, or greater than or congruent to the generalized (abstract) interval $\mathcal{A}'\mathcal{B}'$, and write this as $\mathcal{AB} \geq \mathcal{A}'\mathcal{B}'$.

If a generalized (abstract) interval $\mathcal{A}'\mathcal{B}'$ is shorter than or congruent to a generalized (abstract) interval \mathcal{AB} , and, on the other hand, the generalized interval $\mathcal{A}'\mathcal{B}'$ is known to be incongruent (not congruent) to the generalized interval \mathcal{AB} , we say that the generalized interval $\mathcal{A}'\mathcal{B}'$ is strictly shorter, or strictly less³⁰³ than the generalized interval \mathcal{AB} , and write $\mathcal{A}'\mathcal{B}' < \mathcal{AB}$. If a generalized interval $\mathcal{A}'\mathcal{B}'$ is (strictly) shorter than a generalized interval \mathcal{AB} , we shall say also that the generalized (abstract) interval \mathcal{AB} is strictly longer, or strictly greater³⁰⁴ than (abstract) interval $\mathcal{A}'\mathcal{B}'$, and write this as $\mathcal{AB} > \mathcal{A}'\mathcal{B}'$.

²⁹⁹i.e., generalized intervals formed by pairs of geometric objects with equal numbers

³⁰⁰We are using the obvious fact that if the conditions of our proposition are satisfied for n , they are satisfied for $n-1$, i.e. if $[\mathcal{A}_i\mathcal{A}_{i+1}\mathcal{A}_{i+2}]$, $[\mathcal{B}_i\mathcal{B}_{i+1}\mathcal{B}_{i+2}]$ for all $i = 1, 2, \dots, n-2$, then obviously $[\mathcal{A}_i\mathcal{A}_{i+1}\mathcal{A}_{i+2}]$, $[\mathcal{B}_i\mathcal{B}_{i+1}\mathcal{B}_{i+2}]$ for all $i = 1, 2, \dots, n-3$; if $\mathcal{A}_i\mathcal{A}_{i+1} \equiv \mathcal{B}_i\mathcal{B}_{i+1}$ for all $i = 1, 2, \dots, n-1$, then $\mathcal{A}_i\mathcal{A}_{i+1} \equiv \mathcal{B}_i\mathcal{B}_{i+1}$ for all $i = 1, 2, \dots, n-2$.

³⁰¹From the following it is apparent that $\mathcal{C}, \mathcal{D} \in \mathfrak{J}$.

³⁰²This definition is obviously consistent, as can be seen if we let $\mathcal{CD} = \mathcal{AB}$.

³⁰³We shall usually omit the word 'strictly'.

³⁰⁴Again, we shall omit the word 'strictly' whenever we feel that this omission does not lead to confusion

Lemma 1.3.15.3. A generalized interval $A'B'$ is (strictly) shorter than a generalized interval AB iff:

- 1. There exists a geometric object C on the generalized open interval (AB) such that the generalized interval $A'B'$ is congruent to the generalized interval AC ; ³⁰⁵ or
- 2. There are geometric objects \mathcal{E}, \mathcal{F} on the generalized open interval AB such that $A'B' \equiv \mathcal{E}\mathcal{F}$.

In other words, a generalized interval $A'B'$ is strictly shorter than a generalized interval AB iff there is a generalized interval CD , whose ends both lie on a generalized half-open $[AB)$ (generalized half-closed interval $(AB]$), such that the generalized interval $A'B'$ is congruent to the generalized interval CD .

Proof. Suppose $A'B' \equiv AC$ and $C \in (AB)$. Then by Pr 1.2.7, L 1.2.25.13 $C \in (AB) \Rightarrow (AC) \subset AB \& C \in A_B$. Therefore, $A'B' \leq AB$. Also, $A'B' \not\equiv AB$, because otherwise $C \in A_B \& A'B' \equiv AC \& A'B' \equiv AB \xrightarrow{\text{Pr1.3.1}} AC = AB \Rightarrow C = B$, whence $C \notin (AB)$ - a contradiction. Thus, we have $A'B' \leq AB \& A'B' \not\equiv AB$, i.e. $A'B' < AB$.

Suppose $A'B' \equiv \mathcal{E}\mathcal{F}$, where $\mathcal{E} \in (AB), \mathcal{F} \in (AB)$. By L 1.3.15.2 $\exists C \in (AB) \& \mathcal{E}\mathcal{F} \equiv AC$. Then $A'B' \equiv \mathcal{E}\mathcal{F} \& \mathcal{E}\mathcal{F} \equiv AC \xrightarrow{\text{L1.3.14.1}} A'B' \equiv AC$ and $A'B' \equiv AC \& C \in (AB) \xrightarrow{\text{above}} A'B' < AB$.

Now suppose $A'B' < AB$. By definition, this means that there exists a generalized (abstract) interval CD such that $(CD) \subset (AB)$, $A'B' \equiv CD$, and also $A'B' \not\equiv AB$. Then we have $(CD) \subset (AB) \xrightarrow{\text{L1.2.30.10}} C \in [AB] \& D \in [AB]$, $A'B' \not\equiv AB \& A'B' \equiv CD \Rightarrow CD \neq AB$. Therefore, either one of the ends or both ends of the generalized interval CD lie on the generalized open interval (AB) . The statement in 1. then follows from L 1.3.15.1, in 2.– from L 1.3.15.2. \square

Observe that the lemma L 1.3.15.3 (in conjunction with Pr 1.3.1) indicates that we can lay off from any geometric object an interval shorter than a given generalized interval. Thus, there is actually no such thing as the shortest possible generalized interval.

Corollary 1.3.15.4. If a geometric object C lies on a generalized open interval (AB) (i.e. C lies between A and B), the generalized interval AC is (strictly) shorter than the generalized abstract interval AB .

If two (distinct) geometric objects \mathcal{E}, \mathcal{F} lie on a generalized open interval (AB) , the generalized interval $\mathcal{E}\mathcal{F}$ is (strictly) less than the generalized interval AB .

Proof. Follows immediately from the preceding lemma (L 1.3.15.3). \square

Lemma 1.3.15.5. A generalized interval $A'B'$ is shorter than or congruent to a generalized interval AB iff there is a generalized interval CD whose ends both lie on the generalized closed interval $[AB]$, such that the generalized interval $A'B'$ is congruent to the generalized interval CD .

Proof. Follows immediately from L 1.2.30.12 and the definition of "shorter than or congruent to". \square

Lemma 1.3.15.6. If a generalized interval $A''B''$, where $A'', B'' \in \mathfrak{J}'', \mathfrak{J}'' \in C^{gbr}$, is congruent to a generalized interval $A'B'$, where $A', B' \in \mathfrak{J}', \mathfrak{J}' \in C^{gbr}$, and the generalized interval $A'B'$ is less than a generalized interval AB , where $A, B \in \mathfrak{J}, \mathfrak{J} \in C^{gbr}$, the generalized interval $A''B''$ is less than the generalized interval AB .

Proof. By definition and L 1.3.15.3, $A'B' < AB \Rightarrow \exists C \in (AB) \& A'B' \equiv AC$. $A''B'' \equiv A'B' \& A'B' \equiv AC \xrightarrow{\text{L1.3.14.1}} A''B'' \equiv AC$. $A''B'' \equiv AC \& C \in (AB) \Rightarrow A''B'' < AB$. \square

Lemma 1.3.15.7. If a generalized interval $A''B''$, where $A'', B'' \in \mathfrak{J}'', \mathfrak{J}'' \in C^{gbr}$, is less than a generalized interval $A'B'$, where $A', B' \in \mathfrak{J}', \mathfrak{J}' \in C^{gbr}$, and the generalized interval $A'B'$ is congruent to a generalized interval AB , where $A, B \in \mathfrak{J}, \mathfrak{J} \in C^{gbr}$, the generalized interval $A''B''$ is less than the generalized interval AB .

Proof. $A''B'' < A'B' \Rightarrow \exists C' \in (A'B') \& A''B'' \equiv A'C'$. $A'B' \equiv AB \& C' \in (A'B') \xrightarrow{\text{C1.3.14.3}} \exists C \in (AB) \& A'C' \equiv AC$. $A''B'' \equiv A'C' \& A'C' \equiv AC \xrightarrow{\text{L1.3.14.1}} A''B'' \equiv AC$. $A''B'' \equiv AC \& C \in (AB) \Rightarrow A''B'' < AB$. \square

Lemma 1.3.15.8. If a generalized interval $A''B''$ is less than a generalized interval $A'B'$ and the generalized interval $A'B'$ is less than a generalized interval AB , the generalized interval $A''B''$ is less than the generalized interval AB .

Proof. $A''B'' < A'B' \Rightarrow \exists C' \in (A'B') \& A''B'' \equiv A'C'$. $A'B' < AB \Rightarrow \exists D \in (AB) \& A'B' \equiv AD$. $C' \in (A'B') \& A'B' \equiv AD \xrightarrow{\text{C1.3.14.3}} \exists C \in (AD) \& A'C' \equiv AC$. $A''B'' \equiv A'C' \& A'C' \equiv AC \xrightarrow{\text{Pr1.3.1}} A''B'' \equiv AC$. $[ACD] \& [ADB] \xrightarrow{\text{Pr1.2.7}} [ACB]$. $A''B'' \equiv AC \& [ACB] \Rightarrow A''B'' < AB$. \square

Lemma 1.3.15.9. If a generalized interval $A''B''$ is less than or congruent to a generalized interval $A'B'$ and the generalized interval $A'B'$ is less than or congruent to a generalized interval AB , the generalized interval $A''B''$ is less than or congruent to the generalized interval AB .

³⁰⁵We could have said here also that $A'B' < AB$ iff there is a point $D \in (AB)$ such that $A'B' \equiv BD$, but because of symmetry this adds nothing new to the statement of the theorem, so we do not need to consider this case separately.

Proof. We have, using L 1.3.14.1, L 1.3.15.6, L 1.3.15.7, L 1.3.15.8 on the way: $A''B'' \leq A'B' \& A'B' \leq AB \Rightarrow (A''B'' < A'B' \vee A''B'' \equiv A'B') \& (A'B' < AB \vee A'B' \equiv AB) \Rightarrow (A''B'' < A'B' \& A'B' < AB) \vee (A''B'' < A'B' \& A'B' \equiv AB) \vee (A''B'' \equiv A'B' \& A'B' < AB) \vee (A''B'' \equiv A'B' \& A'B' \equiv AB) \Rightarrow A'' < B'' \vee A''B'' \equiv AB \Rightarrow A''B'' \leq AB$. \square

Lemma 1.3.15.10. *If a generalized interval $A'B'$ is less than a generalized interval AB , the generalized interval AB cannot be less than the generalized interval $A'B'$.*

Proof. Suppose the contrary, i.e., that both $A'B' < AB$ and $AB < A'B'$, that is, $\exists C \in (AB) \& A'B' \equiv AC$ and $\exists C' \in (A'B') \& AB \equiv A'C'$. Then $A'B' \equiv AC \xrightarrow{L1.3.14.1} AC \equiv A'B'$ and $AC \equiv A'B' \& AB \equiv A'C' \& [ACB] \xrightarrow{C1.3.14.6} C' \in ExtA'B' - a contradiction with $C' \in (A'B')$. $\square$$

Lemma 1.3.15.11. *If a generalized interval $A'B'$ is less than a generalized interval AB , it cannot be congruent to that generalized interval.*

Proof. Suppose the contrary, i.e. that both $A'B' < AB$ and $A'B' \equiv AB$. We have then $A'B' < AB \Rightarrow \exists C \in (AB) \& A'B' \equiv AC$. $[ACB] \xrightarrow{L1.2.25.13} C \in A_B$. But $A'B' \equiv AC \& A'B' \equiv AB \& C \in A_B \xrightarrow{Pr1.3.1} C = B - a contradiction$. \square

Corollary 1.3.15.12. *If a generalized interval $A'B'$ is congruent to a generalized interval AB , neither $A'B'$ is shorter than AB , nor AB is shorter than $A'B'$.*

Proof. Follows immediately from L 1.3.15.11. \square

Lemma 1.3.15.13. *If a generalized interval $A'B'$ is less than or congruent to a generalized interval AB and the generalized interval AB is less than or congruent to the generalized interval $A'B'$, the generalized interval $A'B'$ is congruent to the generalized interval AB .*

Proof. $(A'B' < AB \vee A'B' \equiv AB) \& (AB < A'B' \vee AB \equiv A'B') \Rightarrow A'B' \equiv AB$, because $A'B' < AB$ contradicts both $AB < A'B'$ and $A'B' \equiv AB$ in view of L 1.3.15.10, L 1.3.15.11. \square

Lemma 1.3.15.14. *If a generalized interval $A'B'$ is not congruent to a generalized interval AB , then either the generalized interval $A'B'$ is less than the generalized interval AB , or the generalized interval AB is less than the generalized interval $A'B'$.*

Proof. Using Pr 1.3.1, choose geometric objects $C \in A_B, C' \in A'_B$ so that $A'B' \equiv AC, AB \equiv A'C'$. Then $C \neq B$, because $A'B' \not\equiv AB$ by hypothesis, and $C \in A_B \& C \neq B \xrightarrow{L1.2.25.8} [ACB] \vee [ABC]$. We have in the first case (i.e., when $[ACB] \& A'B' \equiv AC \Rightarrow A'B' < AB$, and in the second case $AB \equiv A'C' \& AC \equiv A'B' \& [ABC] \& C' \in A'_B \xrightarrow{L1.3.14.4} [A'C'B'], [A'C'B'] \& AB \equiv A'C' \Rightarrow AB < A'B'$. \square

Theorem 1.3.15. *Suppose finite pencils of n rays h_1, h_2, \dots, h_n and k_1, k_2, \dots, k_n , where $n \geq 3$, have the property that every ray of the pencil, except the first (h_1, k_1) and the last (h_n, k_n , respectively), lies inside the angle formed by the rays of the pencil with the numbers adjacent (in \mathbb{N}) to the number of the given ray. Then if all angles formed by pairs of rays of the pencil h_1, h_2, \dots, h_n with adjacent (in \mathbb{N}) numbers are congruent to the corresponding angles ³⁰⁶ of the pencil k_1, k_2, \dots, k_n , the angles formed by the first and the last rays of the pencils are also congruent, $\angle(h_1, h_n) \equiv \angle(k_1, k_n)$. To recapitulate in more formal terms, let h_1, h_2, \dots, h_n and $k_1, k_2, \dots, k_n, n \geq 3$, be finite pencils of rays such that $h_{i+1} \subset Int\angle(h_i, h_{i+2}), k_{i+1} \subset Int\angle(k_i, k_{i+2})$ for all $i \in \mathbb{N}_{n-2}$ (i.e. $\forall i = 1, 2, \dots, n-2$). Then congruences $\angle(h_i, h_{i+1}) \equiv \angle(k_i, k_{i+1})$ for all $i \in \mathbb{N}_{n-1}$ imply $\angle(h_1, h_n) \equiv \angle(k_1, k_n)$.*

Proof. \square

Comparison of Angles

Lemma 1.3.16.1. *For any ray l having the same origin as rays h, k and lying inside the angle $\angle(h, k)$ formed by them, there are rays m, n with the same origin as h, k, l and lying inside $\angle(h, k)$, such that $\angle(h, k) \equiv \angle(m, n)$.*

Proof. See T 1.3.13, L 1.3.15.1. \square

The following lemma is opposite, in a sense, to L 1.3.16.1

Lemma 1.3.16.2. *For any two (distinct) rays m, n sharing the origin with (equioriginal to) rays h, k and lying inside the angle $\angle(h, k)$ formed by them, there is exactly one ray l with the same origin as h, k, l, m and lying inside $\angle(h, k)$ such that $\angle(m, n) \equiv \angle(h, l)$.*

Proof. See T 1.3.13, L 1.3.15.2.

³⁰⁶i.e., angles formed by pairs of rays with equal numbers

Lemma 1.3.16.3. *An angle $\angle(h', k')$ is (strictly) less than an angle $\angle(h, k)$ iff:*

– 1. *There exists a ray l equioriginal to rays h, k and lying inside the angle $\angle(h, k)$ formed by them, such that the angle $\angle(h', k')$ is congruent to the angle $\angle(h, l)$; ³⁰⁷ or*

– 2. *There are rays m, n equioriginal to rays h, k and lying inside the $\angle(h, k)$ such that $\angle(h', k') \equiv \angle(m, n)$.*

In other words, an angle $\angle(h', k')$ is strictly less than an angle $\angle(h, k)$ iff there is an angle $\angle(l, m)$, whose sides are equioriginal to h, k and both lie on a half-open angular interval $[hk)$ (half-closed angular interval $(hk]$), such that the angle $\angle(h', k')$ is congruent to the angle $\angle(h, k)$.

Proof. See T 1.3.13, L 1.3.15.3. \square

Observe that the lemma L 1.3.16.3 (in conjunction with A 1.3.4) indicates that we can lay off from any ray an angle less than a given angle. Thus, there is actually no such thing as the least possible angle.

Corollary 1.3.16.4. *If a ray l is equioriginal with rays h, k and lies inside the angle $\angle(h, k)$ formed by them, the angle $\angle(h, l)$ is (strictly) less than the angle $\angle(h, k)$.*

If two (distinct) rays m, n are equioriginal to rays h, k and both lie inside the angle $\angle(h, k)$ formed by them, the angle $\angle(m, n)$ is (strictly) less than the angle $\angle(h, k)$.

Suppose rays k, l are equioriginal with the ray h and lie on the same side of the line \bar{h} . Then the inequality $\angle(h, k) < \angle(h, l)$ implies $k \subset \text{Int}\angle(h, l)$.

Proof. See T 1.3.13, C 1.3.15.4, L 1.2.21.21. \square

Lemma 1.3.16.5. *An angle $\angle(h', k')$ is less than or congruent to an angle $\angle(h, k)$ iff there are rays l, m equioriginal to the rays h, k and lying on the closed angular interval $[hk]$, such that the angle $\angle(h', k')$ is congruent to the angle $\angle(h, k)$.*

Proof. See T 1.3.13, L 1.3.15.5. \square

Lemma 1.3.16.6. *If an angle $\angle(h'', k'')$ is congruent to an angle $\angle(h', k')$ and the angle $\angle(h', k')$ is less than an angle $\angle(h, k)$, the angle $\angle(h'', k'')$ is less than the angle $\angle(h, k)$.*

Proof. See T 1.3.14, L 1.3.15.6. \square

Lemma 1.3.16.7. *If an angle $\angle(h'', k'')$ is less than an angle $\angle(h', k')$ and the angle $\angle(h', k')$ is congruent to an angle $\angle(h, k)$, the angle $\angle(h'', k'')$ is less than the angle $\angle(h, k)$.*

Proof. See T 1.3.13, L 1.3.15.7. \square

Lemma 1.3.16.8. *If an angle $\angle(h'', k'')$ is less than an angle $\angle(h', k')$ and the angle $\angle(h', k')$ is less than an angle $\angle(h, k)$, the angle $\angle(h'', k'')$ is less than the angle $\angle(h, k)$.*

Proof. See T 1.3.13, L 1.3.15.8. \square

Lemma 1.3.16.9. *If an angle $\angle(h'', k'')$ is less than or congruent to an angle $\angle(h', k')$ and the angle $\angle(h', k')$ is less than or congruent to an angle $\angle(h, k)$, the angle $\angle(h'', k'')$ is less than or congruent to the angle $\angle(h, k)$.*

Proof. See T 1.3.13, L 1.3.15.9. \square

Lemma 1.3.16.10. *If an angle $\angle(h', k')$ is less than an angle $\angle(h, k)$, the angle $\angle(h, k)$ cannot be less than the angle $\angle(h', k')$.*

Proof. See T 1.3.13, L 1.3.15.10. \square

Lemma 1.3.16.11. *If an angle $\angle(h', k')$ is less than an angle $\angle(h, k)$, it cannot be congruent to that angle.*

Proof. See T 1.3.13, L 1.3.15.11. \square

Corollary 1.3.16.12. *If an angle $\angle(h', k')$ is congruent to an angle $\angle(h, k)$, neither $\angle(h', k')$ is less than $\angle(h, k)$, nor $\angle(h, k)$ is less than $\angle(h', k')$.*

Proof. See T 1.3.13, C 1.3.15.12. \square

Lemma 1.3.16.13. *If an angle $\angle(h', k')$ is less than or congruent to an angle $\angle(h, k)$ and the angle $\angle(h, k)$ is less than or congruent to the angle $\angle(h', k')$, the angle $\angle(h', k')$ is congruent to the angle $\angle(h, k)$.*

Proof. See T 1.3.13, L 1.3.15.13. \square

³⁰⁷Again, we could have said here also that $\angle(h', k') < \angle(h, k)$ iff there is a ray $o \subset \text{Int}\angle(h, k)$ equioriginal with h, k such that $\angle(h', k') \equiv \angle(o, k)$, but because of symmetry this adds nothing new to the statement of the theorem, so we do not need to consider this case separately.

Lemma 1.3.16.14. *If an angle $\angle(h', k')$ is not congruent to an angle $\angle(h, k)$, then either the angle $\angle(h', k')$ is less than the angle $\angle(h, k)$, or the angle $\angle(h, k)$ is less than the angle $\angle(h', k')$.*

Proof. See T 1.3.13, L 1.3.15.14. \square

Lemma 1.3.16.15. *If an angle $\angle(h', k')$ is less than an angle $\angle(h, k)$, the angle $\angle(h^c, k')$ adjacent supplementary to the former is greater than the angle $\angle(h^c, k)$ adjacent supplementary to the latter.*

Proof. $\angle(h', k') < \angle(h, k) \stackrel{\text{L1.3.16.3}}{\implies} \exists l \subset \text{Int}\angle(h, k) \& \angle(h', k') \equiv \angle(h, l) \stackrel{\text{P1.3.9.7}}{\implies} \exists k' k' \subset \text{Int}\angle(h', l') \& \angle(h, k) \equiv \angle(h', l')$. $k' \subset \text{Int}\angle(h', l') \stackrel{\text{L1.2.21.22}}{\implies} l' \subset \text{Int}\angle(h^c, k')$. Also, $\angle(h, k) \equiv \angle(h', l') \stackrel{\text{T1.3.6}}{\implies} \angle(h^c, k) \equiv \angle(h^c, l')$. Finally, $l' \subset \text{Int}\angle(h^c, k') \& \angle(h^c, k) \equiv \angle(h^c, l') \stackrel{\text{L1.3.16.3}}{\implies} \angle(h^c, k) < \angle(h^c, k')$. \square

Acute, Obtuse and Right Angles

An angle which is less than (respectively, greater than) its adjacent supplementary angle is called an acute (obtuse) angle.

Obviously, any angle is either an acute, right, or obtuse angle, and each of these attributes excludes the others. Also, the angle, adjacent supplementary to an acute (obtuse) angle, is obtuse (acute).

Lemma 1.3.16.16. *An angle $\angle(h', k')$ congruent to an acute angle $\angle(h, k)$ is also an acute angle. Similarly, an angle $\angle(h', k')$ congruent to an obtuse angle $\angle(h, k)$ is also an obtuse angle.*

Proof. Indeed, $\angle(h', k') \equiv \angle(h, k) \stackrel{\text{T1.3.6}}{\implies} \angle(h^c, k') \equiv \angle(h^c, k)$. Therefore, by L 1.3.16.6, L 1.3.56.18 we have $\angle(h', k') \equiv \angle(h, k) < \angle(h^c, k) \equiv \angle(h^c, k') \Rightarrow \angle(h', k') < \angle(h^c, k')$ and $\angle(h', k') \equiv \angle(h, k) > \angle(h^c, k) \equiv \angle(h^c, k') \Rightarrow \angle(h', k') > \angle(h^c, k')$, q.e.d. \square

Lemma 1.3.16.17. *Any acute angle $\angle(h', k')$ is less than any right angle $\angle(h, k)$.*

Proof. By T 1.3.8 there exists a right angle, i.e. an angle $\angle(h, k)$ such that $\angle(h, k) \equiv \angle(h^c, k)$. By A 1.3.4 $\exists l \bar{h}k \& \angle(h', k') \equiv \angle(h, l)$. $l \neq k$, because otherwise by L 1.3.8.2 $\angle(h', k') \equiv \angle(h, k)$ implies that $\angle(h', k')$ is a right angle. By L 1.3.16.16, $\angle(h', l')$ is also acute, i.e. $\angle(h, l) < \angle(h^c, l)$. We have by L 1.2.21.15, L 1.2.21.21 $l \neq k \& l \bar{h}k \subset \text{Int}\angle(h, k) \vee (l \subset \text{Int}\angle(h^c, k) \& k \subset \text{Int}\angle(h, l))$. Then $l \subset \text{Int}\angle(h^c, k) \& k \subset \text{Int}\angle(h, l) \stackrel{\text{C1.3.16.4}}{\implies} \angle(h^c, l) < \angle(h^c, k) \& \angle(h, k) < \angle(h, l)$. Together with $\angle(h, k) \equiv \angle(h^c, k)$, (recall that $\angle(h, k)$ is a right angle!) by L 1.3.16.6, L 1.3.56.18 $\angle(h^c, l) < \angle(h, l)$ - a contradiction. Thus, $l \subset \text{Int}\angle(h, k)$, which means, in view of L 1.3.16.5, that $\angle(h, l) < \angle(h, k)$. Finally, $\angle(h', k') \equiv \angle(h, l) \& \angle(h, l) < \angle(h, k) \stackrel{\text{L1.3.16.6}}{\implies} \angle(h', k') < \angle(h, k)$. \square

Lemma 1.3.16.18. *Any obtuse angle $\angle(h', k')$ is greater than any right angle $\angle(h, k)$.* ³⁰⁸

Proof. $\angle(h', k')$ is obtuse $\Rightarrow \angle(h^c, k')$ is acute $\stackrel{\text{L1.3.16.17}}{\implies} \angle(h^c, k') < \angle(h, k) \stackrel{\text{L1.3.16.15}}{\implies} \angle(h', k') = \angle((h^c)^c, k') > \angle(h^c, k)$. Finally, $\angle(h, k) \equiv \angle(h^c, k) \& \angle(h^c, k) < \angle(h', k') \stackrel{\text{L1.3.16.6}}{\implies} \angle(h, k) < \angle(h', k')$, q.e.d. \square

Lemma 1.3.16.19. *Any acute angle is less than any obtuse angle.*

Proof. Follows from T 1.3.8, L 1.3.16.17, L 1.3.16.18. \square

Corollary 1.3.16.20. *An angle less than a right angle is acute. An angle greater than a right angle is obtuse. An angle less than an acute angle is acute. An angle greater than an obtuse angle is obtuse.*

Theorem 1.3.16. *All right angles are congruent.*

Proof. Let $\angle(h', k')$, $\angle(h, k)$ be right angles. If, say, $\angle(h', k') < \angle(h, k)$ then by L 1.3.16.15 $\angle(h^c, k) < \angle(h^c, k')$, and by L 1.3.16.6, L 1.3.56.18 $\angle(h', k') < \angle(h, k) \& \angle(h, k) \equiv \angle(h^c, k) \& \angle(h^c, k) < \angle(h^c, k') \Rightarrow \angle(h', k') < \angle(h^c, k')$, which contradicts the assumption that $\angle(h', k')$ is a right angle. \square

Lemma 1.3.16.21. *Suppose that rays h, k, l have the same initial point, as do rays h', k', l' . Suppose, further, that $h\bar{k}l$ and $h'\bar{k}'l'$ (i.e. the rays h, l and h', l' lie on opposite sides of the lines \bar{k}, \bar{k}' , respectively, that is, the angles $\angle(h, k)$, $\angle(k, l)$ are adjacent, as are angles $\angle(h', k')$, $\angle(k', l')$) and $\angle(h, k) \equiv \angle(h', k')$, $\angle(k, l) \equiv \angle(k', l')$. Then the rays k, l lie on the same side of the line \bar{h} iff the rays k', l' lie on the same side of the line \bar{h}' , and the rays k, l lie on opposite sides of the line \bar{h} iff the rays k', l' lie on opposite sides of the line \bar{h} .*

³⁰⁸In different words:

Any right angle is less than any obtuse angle.

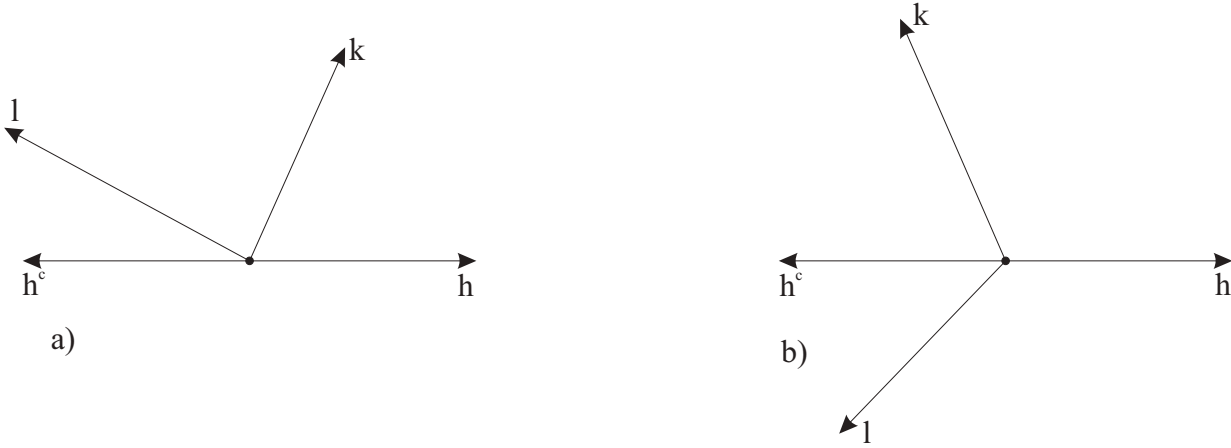

Figure 1.123: Suppose that rays h, k, l have the same initial point, as do rays h', k', l' . Suppose, further, that $h\bar{k}l$ and $h'\bar{k}'l'$ and $\angle(h, k) \equiv \angle(h', k')$, $\angle(k, l) \equiv \angle(k', l')$. Then k, l lie on the same side of \bar{h} iff k', l' lie on the same side of \bar{h}' , and k, l lie on opposite sides of \bar{h} iff k', l' lie on opposite sides of \bar{h}' .

Proof. Suppose that $kl\bar{h}$. Then certainly $l' \neq h'^c$, for otherwise in view of C 1.3.6.1 we would have $l = h^c$. Suppose now $k'\bar{h}'l'$ (see Fig. 1.123.). Using L 1.2.21.33 we can write $l \subset \text{Int}\angle(h^c, k)$, $h'^c \subset \text{Int}\angle(k', l')$. In addition, $\angle(h, k) \equiv \angle(h', k') \xrightarrow{\text{T1.3.6}} \angle(h^c, k) = \text{adjsp}\angle(h, k) \equiv \text{adsp}\angle(h', k') = \angle(h'^c, k')$. Hence, using C 1.3.16.4, L 1.3.16.6 – L 1.3.16.8, we can write $\angle(k, l) < \angle(h^c, k) \equiv \angle(h'^c, k') < \angle(k', l') \Rightarrow \angle(k, l) < \angle(k', l')$. Since, however, we have $\angle(h, l) \equiv \angle(h', l')$ by T 1.3.9, we arrive at a contradiction in view of L 1.3.16.11. Thus, we have $k'l'\bar{h}'$ as the only remaining option.

□

Lemma 1.3.16.22. *Suppose that a point D lies inside an angle $\angle BAC$ and the points A, D lie on the same side of the line a_{BC} . Then the angle $\angle BAC$ is less than the angle $\angle DC$.*

Proof. First, observe that the ray B_D lies inside the angle $\angle ABC$. In fact, the points C, D lie on the same side of the line $a_{AB} = a_{BA}$ by definition of interior of $\angle BAC$, and ADa_{BC} by hypothesis. From L 1.2.21.10 we see that the ray B_D meets the open interval (AC) in some point E . Since the points B, D lie on the same side of the line a_{AC} (again by definition of interior of $\angle BAC$), the points D lies between B, E (see also L 1.2.11.8). Finally, using T 1.3.17 (see also L 1.2.11.15), we can write $\angle BAC = \angle BAE < \angle BEC = \angle DEC < \text{angle}BDC$, whence $\angle BAC < \angle BDC$, as required. □

Suppose two lines a, b concur in a point O . Suppose further that the lines a, b are separated by the point O into the rays h, h^c and k, k^c , respectively. Obviously, we have either $\angle(h, k) \leq \angle(h^c, k)$ or $\angle(h^c, k) \leq \angle(h, k)$. If the angle $\angle(h, k)$ is not greater than the angle $\angle(h^c, k)$ adjacent supplementary to it, the angle $\angle(h, k)$, as well as the angle $\angle(h^c, k)$ will sometimes be (loosely³⁰⁹) referred to as the angle between the lines a, b .³¹⁰

Interior and Exterior Angles

Lemma 1.3.17.2. *If a point A lies between points B, D and a point C does not lie on the line a_{AB} , the angles $\angle CAD, \angle ACB$ cannot be congruent.*

Proof. (See Fig. 1.124.) Suppose the contrary, i.e. that $\angle CAD \equiv \angle ACB$. According to A 1.3.1, L 1.2.11.3, we can assume with no loss of generality that $CB \equiv AD$.³¹¹ $AD \equiv CB \& AC \equiv CA \& \angle CAD \equiv \angle ACB \xrightarrow{\text{A1.3.5}} \angle ACD \equiv \angle CAB$. Using A 1.2.2, choose a point E so that $[BCE]$ and therefore (see L 1.2.15.2) $C_E = (C_B)^c$. Then $\angle CAD \equiv \angle ACB \xrightarrow{\text{T1.3.6}} \angle CAB = \text{adjsp}\angle CAD \equiv \text{adjsp}\angle ACB = \angle ACE$. $[BAD] \& [BCE] \Rightarrow Ba_{AC}D \& Ba_{AC}E \xrightarrow{\text{L1.2.17.9}} DEa_{AC}$. $\angle CAB \equiv \angle ACD \& \angle CAB \equiv \angle ACE \& DEa_{AC} \xrightarrow{\text{L1.3.2.1}} C_D = C_E$ - a contradiction, for $C \notin a_{AB} = a_{BD} \Rightarrow D \notin a_{BC} = a_{CE}$. □

Lemma 1.3.17.3. *If an angle $\angle A'B'C'$ is less than an angle $\angle ABC$, there is a point D lying between A and C and such that the angle $\angle A'B'C'$ is congruent to the angle $\angle ABD$.*

Proof. (See Fig. 1.125.) $\angle A'B'C' < \angle ABC \xrightarrow{\text{L1.3.16.3}} \exists B_{D'} \ B_{D'} \subset \text{Int}\angle ABC \& \angle A'B'C' \equiv \angle ABD'$. $B_{D'} \subset \text{Int}\angle ABC \& A \in B_A \& C \in B_C \xrightarrow{\text{L1.2.21.10}} \exists D \ D \in B_{D'} \& [ADC]$. $D \in B_{D'} \xrightarrow{\text{L1.2.11.3}} B_D = B_{D'}$. □

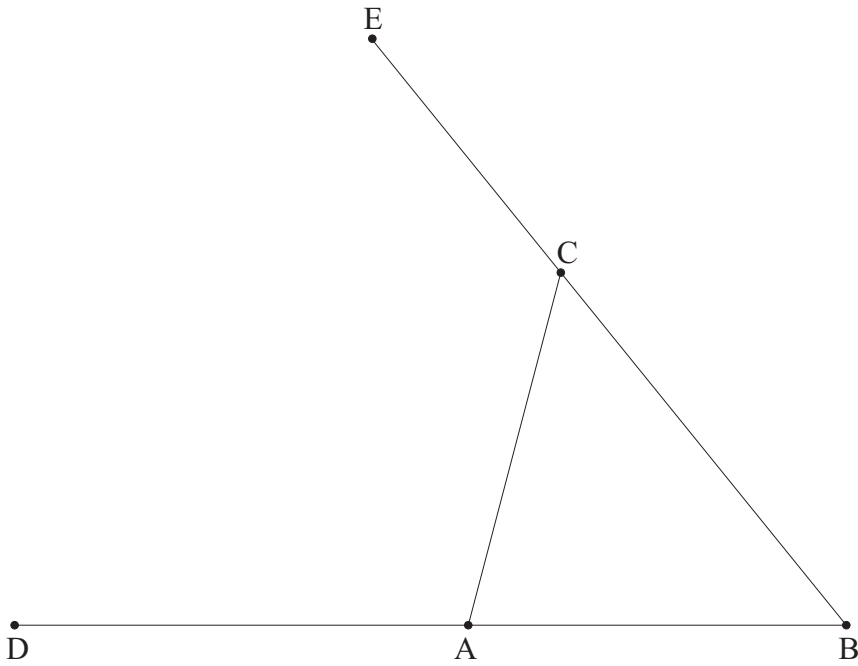

Figure 1.124: If a point A lies between points B, D and a point C does not lie on a_{AB} , the angles $\angle CAD, \angle ACB$ cannot be congruent.

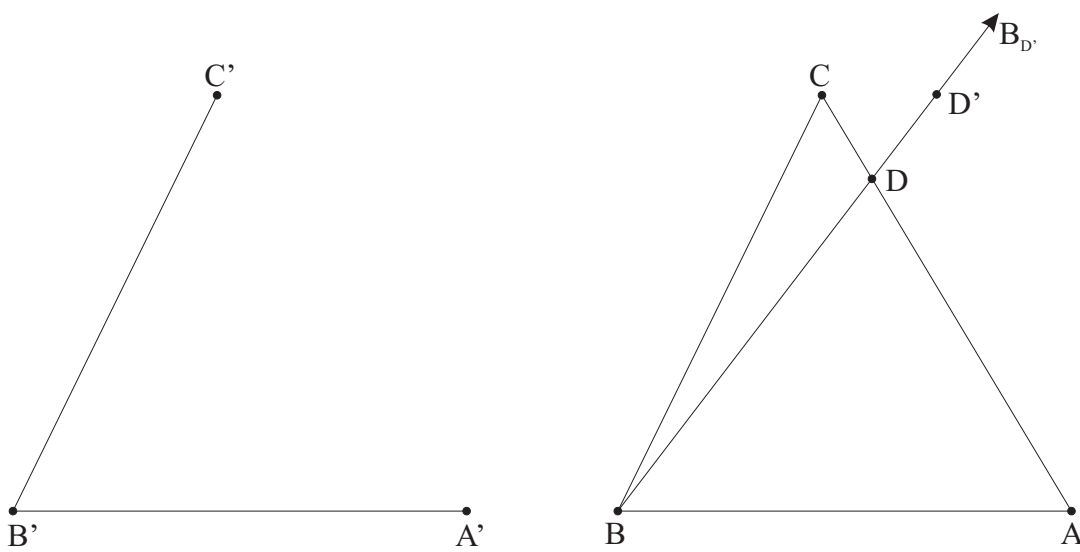

Figure 1.125: If an angle $\angle A'B'C'$ is less than an angle $\angle ABC$, there is a point D lying between A and C and such that $\angle A'B'C' \equiv ABD$.

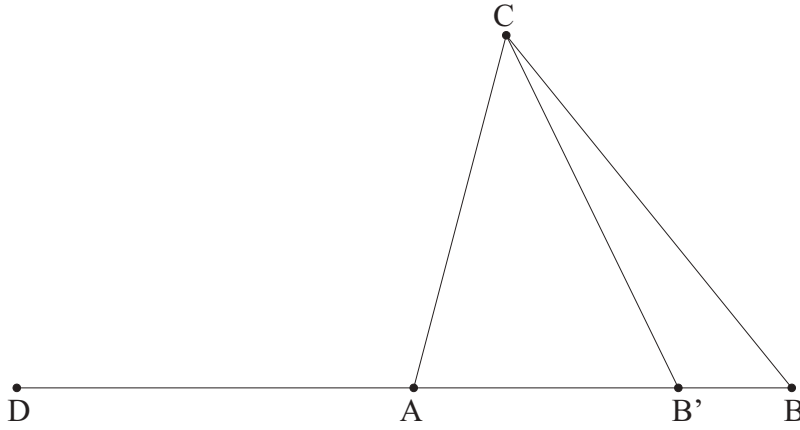

Figure 1.126: If a point A lies between points B, D and a point C does not lie on a_{AB} , the angle $\angle ACB$ is less than the angle $\angle CAD$.

Lemma 1.3.17.4. *If a point A lies between points B, D and a point C does not lie on the line a_{AB} , the angle $\angle ACB$ is less than the angle $\angle CAD$.*

Proof. (See Fig. 1.126.) By L 1.3.17.2 $\angle ACB \neq \angle CAD$. Therefore, by L 1.3.16.14 $\angle CAD < \angle ACB \vee \angle ACB < \angle CAD$. Suppose $\angle CAD < \angle ACB$. We have $\angle CAD < \angle ACB \stackrel{\text{L1.3.17.3}}{\implies} \exists B' [AB'B] \& \angle CAD \equiv \angle CB'B$. $[BB'A] \& [BAD] \stackrel{\text{L1.2.3.2}}{\implies} [B'AD]$. But $[B'AD] \& C \notin a_{AB'} = a_{AB} \stackrel{\text{L1.3.17.2}}{\implies} \angle CAB \neq \angle CAD$. \square

Theorem 1.3.17. *An exterior angle, say, $\angle CAD$, of a triangle $\triangle ACB$, is greater than either of the angles $\angle ACB$, $\angle ABC$ of $\triangle ACB$, not adjacent supplementary to it.*

Proof. $[BAD] \& C \notin a_{AB} \stackrel{\text{L1.3.17.4}}{\implies} \angle ACB < \angle CAD \& \angle ABC < \text{vert } \angle CAD \angle((A_C)^c, (A_D)^c) \equiv \angle CAD$. \square

Relations Between Intervals and Angles

Corollary 1.3.17.4. *In any triangle $\triangle ABC$ at least two angles are acute.*

Proof. If the angle $\angle C$ is right or obtuse, its adjacent supplementary angle is either right or acute. Since $\text{adjsp } \angle C$ is an exterior angle of $\triangle ABC$, by T 1.3.17 we have $\angle A < \text{adjsp } \angle C$, $\angle B < \text{adjsp } \angle C$. Hence $\angle A, \angle B$ are both acute angles. \square

Corollary 1.3.17.5. *All angles in an equilateral triangle are acute.*

Proof. See L 1.3.8.2, L 1.3.16.16, and the preceding corollary (C 1.3.17.4). \square

Corollary 1.3.17.6. *The right angle in a right triangle is greater than any of the two remaining angles.*

Proof. Follows immediately from C 1.3.17.4, L 1.3.16.17. \square

Theorem 1.3.18. *If a side, say, AB , of a triangle $\triangle ABC$, is greater than another side, say, BC of $\triangle ABC$, the same relation holds for the angles opposite to these sides, i.e. the angle $\angle C$ is then greater than the angle $\angle A$, $\angle ACB > \angle BAC$.*

Conversely, if an angle, say, $\angle C = \angle ACB$, of a triangle $\triangle ABC$, is greater than another angle, say, $\angle A = \angle BAC$ of $\triangle ABC$, the same relation holds for the opposite sides, i.e. the side AB is then greater than the side BC , $AB > BC$.

Proof. (See Fig. 1.127.) Suppose $BC < BA$. Then by L 1.3.13.3 $\exists D [BDA] \& BC \equiv BD$. $^{312} BC \equiv BD \stackrel{\text{T1.3.3}}{\implies} \angle BCD \equiv \angle BDC$. $B \in C_B \& A \in C_A \& [BDA] \stackrel{\text{L1.2.21.6, L1.2.21.4}}{\implies} C_D \subset \text{Int} \angle ACB \stackrel{\text{L1.3.16.3}}{\implies} \angle BCD < \angle ACB = \angle C$. $[BDA] \& C \notin a_{BD} \stackrel{\text{L1.3.17.4}}{\implies} \angle BDC > \angle BAC = \angle A$. Finally, by L 1.3.16.6, L 1.3.56.18, T 1.3.11 $\angle A < \angle BDC \& \angle BCD \equiv \angle BDC \& \angle BDC < \angle C \Rightarrow \angle A < \angle C$.

Suppose now $\angle A < \angle C$. Then $BC < AB$, because otherwise by L 1.3.16.14, T 1.3.3, and the preceding part of the present proof, $BC \equiv AB \vee AB < BC \Rightarrow \angle A \equiv \angle C \vee \angle C < \angle A$. Either result contradicts our assumption $\angle A < \angle C$ in view of L 1.3.13.10, L 1.3.13.11. \square

³⁰⁹Strictly speaking, we should refer to the appropriate classes of congruence instead, but that would be overly pedantic.

³¹⁰It goes without saying that in the case $\angle(h^c, k) \leq \angle(h, k)$ it is the angle $\angle(h^c, k)$ that is referred to as the angle between the lines a, b .

³¹¹Indeed, by A 1.3.1 $\exists D' D' \in A_D \& C_B \equiv AD'$. But $D' \in A_D \stackrel{\text{L1.2.11.3}}{\implies} A_{D'} = A_D$.

³¹²Note also that $A \notin a_{BC} \& [BDA] \stackrel{\text{C1.2.1.8}}{\implies} D \notin a_{BC} \stackrel{\text{C1.1.2.3}}{\implies} C \notin a_{BD}$.

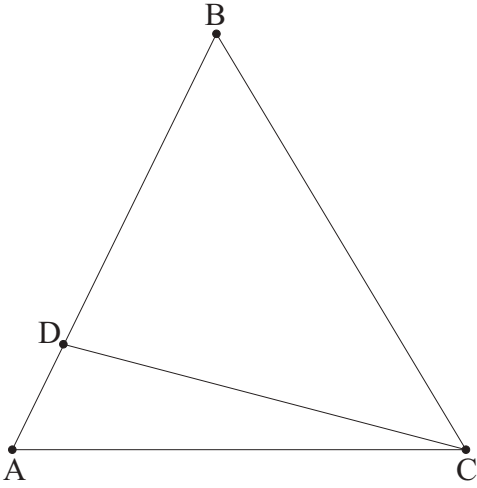

Figure 1.127: If a side AB , of $\triangle ABC$, is greater than another side BC , the same relation holds for the opposite angles, $\angle C < \angle A$. Conversely, if $\angle C > \angle A$, the same relation holds for the opposite sides, i.e. $AB > BC$.

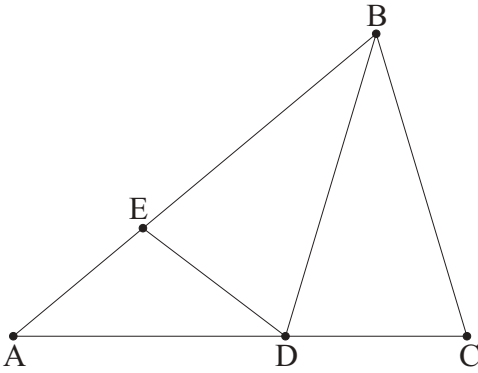

Figure 1.128: For a bisector BD of $\triangle ABC$ if $\angle C > \angle A$ then $CD < AD$.

Corollary 1.3.18.1. *If $a_{AC} \perp a$, $A \in a$, then for any point $B \in a$, $B \neq A$, we have $AC < BC$.*³¹³

Proof. Since $\angle BAC$ is right, the other two angles $\angle ACB$, $\angle ABC$ of the triangle $\triangle ACB$ are bound to be acute by C 1.3.17.4. This means, in particular, that $\angle ABC < \angle BAC$ (see L 1.3.16.17). Hence by the preceding theorem (T 1.3.18) we have $AC < BC$. \square

Corollary 1.3.18.2. *Any interval is longer than its orthogonal projection on an arbitrary line.*

Proof. Follows from the preceding corollary (C 1.3.18.1).³¹⁴ \square

A triangle with at least one right angle is called a right triangle. By L 1.3.8 right triangles exist, and by C 1.3.17.4 all of them have exactly one right angle. The side of a right triangle opposite to the right angle is called the hypotenuse of the right triangle, and the other two sides are called the legs. In terms of right triangles the corollary C 1.3.18.2 means that in any right triangle the hypotenuse is longer than either of the legs.

Corollary 1.3.18.3. *Suppose BD is a bisector of a triangle $\triangle ABC$. (That is, we have $[ADC]$ and $\angle ABD \equiv \angle CBD$, see p. 151.) If the angle $\angle C$ is greater than the angle $\angle A$ then the interval CD is shorter than the interval AD .*³¹⁵

Proof. (See Fig. 1.128.) We have $\angle A < \angle C \xrightarrow{T1.3.18} BC < AB \xrightarrow{L1.3.17.4} \exists E [BEA] \& BC \equiv BE$. $[ADC] \xrightarrow{L1.2.11.3} AD = AC \& CD = CA \Rightarrow \angle BAD = \angle A \& \angle BCD = \angle C$. $[AEB] \xrightarrow{L1.2.11.3} AE = AB \& BE = BA \Rightarrow \angle EAD = \angle A \& \angle EBD = \angle ABD$. $BC \equiv BE \& BD \equiv BD \& \angle EBD \equiv \angle CBD \xrightarrow{T1.3.4} \triangle EBD \equiv \triangle CBD \Rightarrow ED \equiv CD \& \angle BED \equiv \angle BCD$. Observe that $\text{adjsp} \angle C$, being an external angle of the triangle $\triangle ABC$, by T 1.3.17 is greater than the angle $\angle A$. Hence $\angle BED \equiv \angle BCD = \angle C \xrightarrow{T1.3.6} \angle AED = \text{adjsp} \angle BED \equiv \text{adjsp} \angle C$. $\angle AED = \angle A < \text{adjsp} \angle C \equiv \angle AED \xrightarrow{L1.3.56.18} \angle EAD < \angle AED \xrightarrow{T1.3.18} ED < AD$. Finally, $ED < AD \& ED \equiv CD \xrightarrow{L1.3.13.6} CD < AD$. \square

³¹³The reader can refer to Fig. 1.140 for the illustration.

³¹⁴See also the observation accompanying the definition of orthogonal projections on p. 117.

³¹⁵Observe that instead of $\angle A < \angle C$ we could directly require that $BC < AB$ (see beginning of proof).

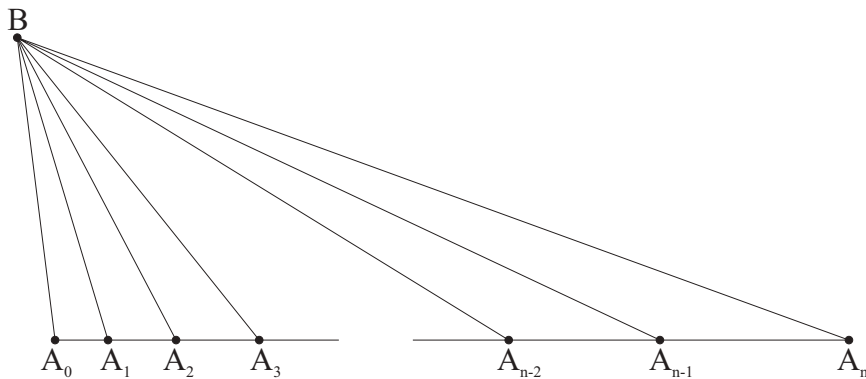

Figure 1.129: Illustration for proofs of C 1.3.18.4, C 1.3.18.5.

Corollary 1.3.18.4. *Let an interval A_0A_n , $n \geq 2$, be divided into n intervals $A_0A_1, A_1A_2, \dots, A_{n-1}A_n$ by the points A_1, A_2, \dots, A_{n-1} .³¹⁶ Suppose further that B is such a point that the angle $\angle BA_0A_1$ is greater than the angle $\angle BA_1A_0$.³¹⁷ Then the following inequalities hold: $\angle BA_nA_{n-1} < \angle BA_{n-1}A_{n-2} < \dots < \angle BA_3A_2 < \angle BA_2A_1 < \angle BA_1A_0 < \angle BA_0A_1 < \angle BA_1A_2 < \angle BA_2A_3 < \dots < \angle BA_{n-2}A_{n-1} < \angle BA_{n-1}A_n$, $\forall i \in \mathbb{N}_{n-1} \angle BA_{i+1}A_{i-1} < \angle BA_{i-1}A_{i+1}$, and $BA_0 < BA_1 < \dots < BA_{n-1} < BA_n$.*

Proof. (See Fig. 1.129.) We have (using L 1.2.11.3 to show the equality of rays) $\forall i \in \mathbb{N}_{n-1} ([A_{i-1}A_iA_{i+1}] \Rightarrow \angle A_{i-1}BA_i = \text{adjsp}\angle A_iBA_{i+1} \& A_{i-1}A_i = A_{i-1}A_{i+1} \& A_{i+1}A_i = A_{i-1}A_{i+1})$. Hence by T refT 1.3.17 we can write $\angle BA_nA_{n-1} < \angle BA_{n-1}A_{n-2} < \dots < \angle BA_3A_2 < \angle BA_2A_1 < \angle BA_1A_0 < \angle BA_0A_1 < \angle BA_1A_2 < \angle BA_2A_3 < \dots < \angle BA_{n-2}A_{n-1} < \angle BA_{n-1}A_n$. Applying repeatedly L 1.3.16.8 to these inequalities, we obtain $\forall i \in \mathbb{N}_{n-1} \angle BA_{i+1}A_i < \angle BA_{i-1}A_i$. Taking into account $A_{i-1}A_i = A_{i-1}A_{i+1}$, $A_{i+1}A_i = A_{i-1}A_{i+1}$, valid for all $i \in \mathbb{N}_{n-1}$, we have $\forall i \in \mathbb{N}_{n-1} \angle BA_{i+1}A_{i-1} < \angle BA_{i-1}A_{i+1}$. Also, using T 1.3.18 we conclude that $BA_0 < BA_1 < \dots < BA_{n-1} < BA_n$. \square

Corollary 1.3.18.5. *Let an interval A_0A_n , $n \geq 2$, be divided into n intervals $A_0A_1, A_1A_2, \dots, A_{n-1}A_n$ by the points A_1, A_2, \dots, A_{n-1} .³¹⁸ Suppose further that B is such a point that that all angles $\angle A_{i-1}BA_i$, $i \in \mathbb{N}_n$ are congruent and the angle $\angle BA_0A_1$ is greater than the angle $\angle BA_1A_0$. Then $A_0A_1 < A_1A_2 < A_2A_3 < \dots < A_{n-2}A_{n-1} < A_{n-1}A_n$.*

Proof. (See Fig. 1.129.) From the preceding corollary (C 1.3.18.4) we have $\forall i \in \mathbb{N}_{n-1} \angle BA_{i+1}A_{i-1} < \angle BA_{i-1}A_{i+1}$. Together with $\angle A_{i-1}BA_i \equiv \angle A_iBA_{i+1}$ (true by hypothesis), the corollary C 1.3.18.3 applied to every triangle $\triangle A_{i-1}BA_{i+1}$, $\forall i \in \mathbb{N}_{n-1}$, gives $\forall i \in \mathbb{N}_{n-1} A_{i-1}A_i < A_iA_{i+1}$, q.e.d. \square

Corollary 1.3.18.6. *Let an interval A_0A_n , $n \geq 2$, be divided into n intervals $A_0A_1, A_1A_2, \dots, A_{n-1}A_n$ by the points A_1, A_2, \dots, A_{n-1} . Suppose further that B is such a point that that all angles $\angle A_{i-1}BA_i$, $i \in \mathbb{N}_n$ are congruent and $\angle BA_0A_1$ is a right angle. Then $A_0A_1 < A_1A_2 < A_2A_3 < \dots < A_{n-2}A_{n-1} < A_{n-1}A_n$.*

Proof. Being a right angle, by C 1.3.17.6 the angle $\angle BA_0A_1$ is greater than the angle $\angle BA_1A_0$. The result then follows from the preceding corollary (C 1.3.18.5). \square

Corollary 1.3.18.7. *Suppose BE is a median of a triangle $\triangle ABC$. (That is, we have $[AEC]$ and $AE \equiv EC$, see p. 151.) If the angle $\angle C$ is greater than the angle $\angle A$ then the angle $\angle CBE$ is greater than the angle $\angle ABE$.³¹⁹*

Proof. (See Fig. 1.130.) Let BD be the bisector of the triangle $\triangle ABC$ drawn from the vertex B to the side AC . By C 1.3.18.3 we have $CD < AD$. This implies that $[AED]$ and $[EDC]$.³²⁰ Using L 1.2.21.6, L 1.2.21.4, C 1.3.16.4, we can write $[AED] \& [CDE] \Rightarrow \angle ABE < \angle ABD \& \angle CBD < \angle CBE$. Finally, by L 1.3.16.6 - L 1.3.16.8 we have $\angle ABE < \angle ABD \& \angle ABD \equiv \angle CBD \& \angle CBD < \angle CBE \Rightarrow \angle ABE < \angle CBE$, q.e.d. \square

³¹⁶In other words, the finite sequence of points A_i , where $i \in \mathbb{N}_n$, $n \geq 2$, has the property that every point of the sequence, except for the first and the last, lies between the two points with adjacent (in \mathbb{N}) numbers (see definition on p. 15).

³¹⁷Observe that this condition is always true if the angle $\angle BA_0A_1$ is either right or obtuse.

³¹⁸In other words, the finite sequence of points A_i , where $i \in \mathbb{N}_n$, $n \geq 2$, has the property that every point of the sequence, except for the first and the last, lies between the two points with adjacent (in \mathbb{N}) numbers (see definition on p. 15.)

³¹⁹Note again that instead of $\angle A < \angle C$ we could directly require that $BC < AB$ (see beginning of proof).

³²⁰ $[ADC] \& [AEC] \xrightarrow{T1.2.5} [ADE] \vee D = E \vee [EDC]$. $D \neq E$, for $CD < AD$ contradicts $CD \equiv AD$ in view of L 1.3.13.11. Also, $\neg[ADE]$, for otherwise $[ADE] \& [AEC] \xrightarrow{L1.2.3.2} [DEC]$, $[ADE] \& [DEC] \xrightarrow{C1.3.13.4} AD < AE \& CE < CD$, $AD < AE \& AE \equiv CE \& CE < CD \Rightarrow AD < CD$, which contradicts $CD < AD$ in view of L 1.3.13.10. Thus, we have the remaining case $[AED]$. Hence $[AED] \& [ADC] \xrightarrow{L1.2.3.2} [EDC]$.

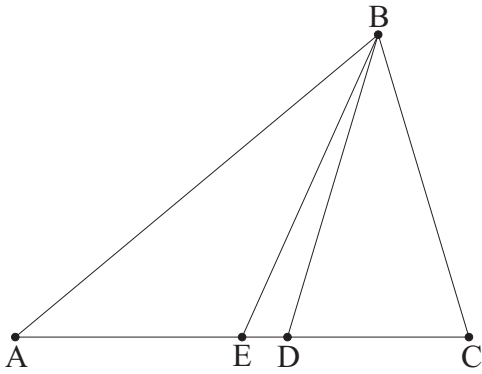

Figure 1.130: Given a median BE of a triangle $\triangle ABC$, iff the $\angle C > \angle A$ then the angle $\angle CBE > \angle ABE$.

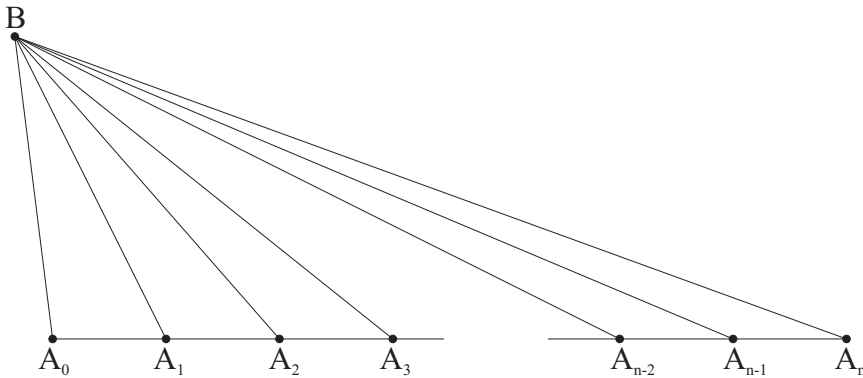

Figure 1.131: Let an interval A_0A_n , $n \geq 2$, be divided into n congruent intervals $A_0A_1, A_1A_2, \dots, A_{n-1}A_n$. Suppose further that B is such a point that $\angle BA_0A_1$ is greater than $\angle BA_1A_0$. Then we have: $\angle A_nBA_{n-1} < \angle A_{n-1}BA_{n-2} < \dots < \angle A_3BA_2 < \angle A_2BA_1 < \angle A_1BA_0$.

Corollary 1.3.18.8. *Let an interval A_0A_n , $n \geq 2$, be divided into n congruent intervals $A_0A_1, A_1A_2, \dots, A_{n-1}A_n$ by the points A_1, A_2, \dots, A_{n-1} .³²¹ Suppose further that B is such a point that the angle $\angle BA_0A_1$ is greater than the angle $\angle BA_1A_0$. Then the following inequalities hold: $\angle A_nBA_{n-1} < \angle A_{n-1}BA_{n-2} < \dots < \angle A_3BA_2 < \angle A_2BA_1 < \angle A_1BA_0$.*

Proof. (See Fig. 1.131.) From C 1.3.18.4 we have $\forall i \in \mathbb{N}_{n-1} \angle BA_{i+1}A_{i-1} < \angle BA_{i-1}A_{i+1}$. Together with $A_{i-1}A_i \equiv A_iA_{i+1}$ (true by hypothesis), the preceding corollary (C 1.3.18.7) applied to every triangle $\triangle A_{i-1}BA_{i+1}$ for all $i \in \mathbb{N}_{n-1}$, gives $\forall i \in \mathbb{N}_{n-1} \angle A_iBA_{i+1} < \angle A_{i-1}BA_i$, q.e.d. \square

Corollary 1.3.18.9. *Let an interval A_0A_n , $n \geq 2$, be divided into n congruent intervals $A_0A_1, A_1A_2, \dots, A_{n-1}A_n$ by the points A_1, A_2, \dots, A_{n-1} . Suppose further that B is such a point that the angle $\angle BA_0A_1$ is a right angle. Then the following inequalities hold: $\angle A_nBA_{n-1} < \angle A_{n-1}BA_{n-2} < \dots < \angle A_3BA_2 < \angle A_2BA_1 < \angle A_1BA_0$.*

Proof. Being a right angle, by C 1.3.17.6 the angle $\angle BA_0A_1$ is greater than the angle $\angle BA_1A_0$. The result then follows from the preceding corollary (C 1.3.18.8). \square

Corollary 1.3.18.10. *Let F be the foot of the perpendicular drawn through a point A on the side k of an angle $\angle(h, k)$ to the line \bar{h} containing the other side h . If $F \in h$ then $\angle(h, k)$ is an acute angle. If $F \in h^c$ then $\angle(h, k)$ is an obtuse angle.³²²*

Proof. Denote the vertex of $\angle(h, k)$ by O . Suppose first $F \in h$ (see Fig. 1.132, a). Then $A \in k \& F \in h \xrightarrow{L1.2.3.2} \angle AOF = \angle(h, k)$. From the condition of orthogonality $\angle AFO$ is a right angle. Since the triangle $\triangle AOF$ is required by C 1.3.17.4 to have at least two acute angles (and $\angle AFO$ is a right angle), the angle $\angle(h, k)$ is acute. Now suppose $F \in h^c$ (see Fig. 1.132, a). Using the preceding arguments, we see immediately that $\angle(h^c, k)$ is acute. Hence $\angle(h, k) = \text{adjsp} \angle(h^c, k)$ is obtuse, q.e.d. \square

The converse is also true.

³²¹In other words, the finite sequence of points A_i , where $i \in \mathbb{N}_n$, $n \geq 2$, has the property that every point of the sequence, except for the first and the last, lies between the two points with adjacent (in \mathbb{N}) numbers, and all intervals A_iA_{i+1} , where $i \in \mathbb{N}_n$, are congruent. (See p. 147.)

³²²Obviously, if $F = O$, where O is the vertex of $\angle(h, k)$, then $\angle(h, k)$ is a right angle.

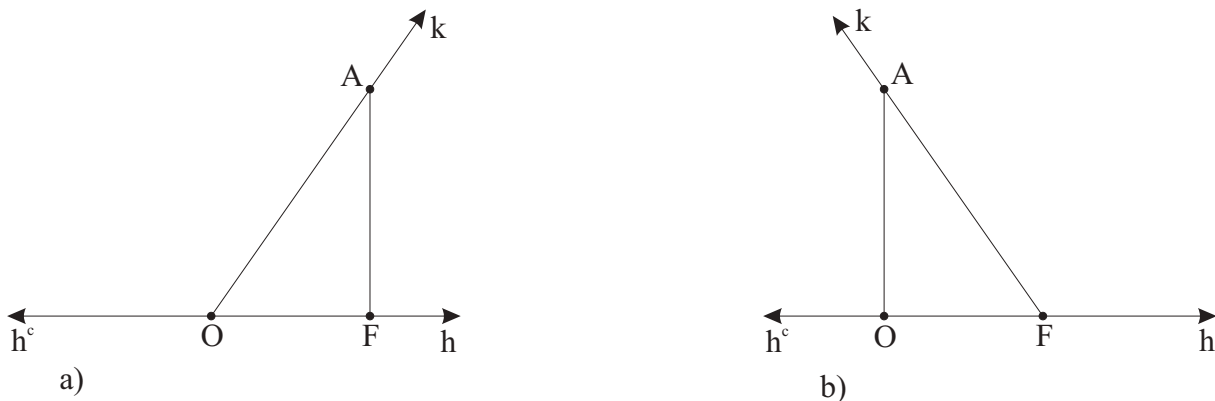

Figure 1.132: Let F be the foot of the perpendicular drawn through a point A on the side k of an angle $\angle(h, k)$ to the line \bar{h} containing the other side h . If $F \in h$ then $\angle(h, k)$ is an acute angle. If $F \in h^c$ then $\angle(h, k)$ is an obtuse angle.

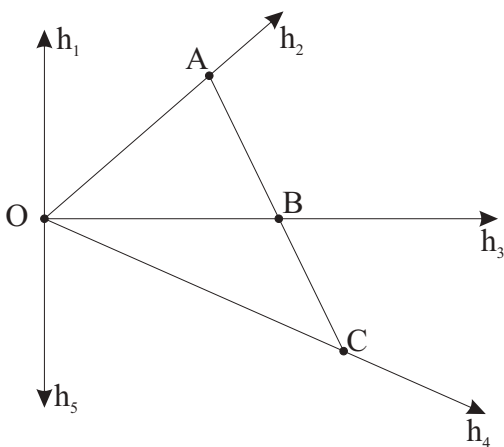

Figure 1.133: Suppose rays h_2, h_3, h_4 have a common origin O and the rays h_2, h_4 lie on opposite sides of the line \bar{h}_3 . Then the ray h_3 lies inside the angle $\angle(h_2, h_4)$, and the open interval (AC) , where $A \in h_2, C \in h_4$, meets the ray h_3 in some point B .

Corollary 1.3.18.11. *Let F be the foot of the perpendicular drawn through a point A on the side k of an angle $\angle(h, k)$ to the line \bar{h} containing the other side h . If $\angle(h, k)$ is an acute angle, then $F \in h$. If $\angle(h, k)$ is an obtuse angle then $F \in h^c$.*

Proof. Suppose $\angle(h, k)$ is an acute angle. Then $F \in h$. Indeed, if we had $F \in h^c$, the angle $\angle(h, k)$ would be obtuse by the preceding corollary (C 1.3.18.10) - a contradiction; and if $F = O$, where O is the vertex of $\angle(h, k)$, the angle $\angle(h, k)$ would be right. Similarly, the fact that $\angle(h, k)$ is an obtuse angle implies $F \in h^c$. \square

Corollary 1.3.18.12. *Suppose rays h_2, h_3, h_4 have a common origin O , the angles $\angle(h_2, h_3), \angle(h_3, h_4)$ are both acute, and the rays h_2, h_4 lie on opposite sides of the line \bar{h}_3 .³²³ Then the ray h_3 lies inside the angle $\angle(h_2, h_4)$, and the open interval (AC) , where $A \in h_2, C \in h_4$, meets the ray h_3 in some point B .*

Proof. Using L 1.3.8.3, draw a ray h_1 so that $\angle(h_1, h_3)$ is a right angle. Then the angle $\angle(h_3, h_5)$, where $h_5 \equiv h_1^c$ is, obviously, also a right angle. Since the rays h_1, h_5 lie on opposite sides of the line \bar{h}_3 , we can assume without loss of generality that the rays h_1, h_2 lie on one side of the line \bar{h}_3 (renaming $h_1 \rightarrow h_5, h_5 \rightarrow h_1$ if necessary). Taking into account that, by hypothesis, the rays h_2, h_4 lie on opposite sides of the line \bar{h}_3 , from L 1.2.18.4, L 1.2.18.5 we conclude that the rays h_4, h_5 lie on one side of the line \bar{h}_3 . Since the angles $\angle(h_2, h_3), \angle(h_3, h_4)$ are acute and $\angle(h_1, h_3), \angle(h_3, h_5)$ are right angles, using L 1.3.16.17 we can write $\angle(h_2, h_3) < \angle(h_2, h_3), \angle(h_3, h_4) < \angle(h_3, h_5)$. Together with the facts that h_1, h_2 lie on one side of the line \bar{h}_3 and that h_4, h_5 lie on one side of the line \bar{h}_3 , these inequalities give, respectively, the following inclusions: $h_2 \subset \text{Int}\angle(h_1, h_3), h_4 \subset \text{Int}\angle(h_3, h_5)$.³²⁴ Hence using L 1.2.21.27 we can write³²⁵ $[h_1 h_2 h_3] \& [h_1 h_3 h_5] \Rightarrow [h_2 h_3 h_5]. [h_2 h_3 h_5] \& [h_3 h_4 h_5] \Rightarrow [h_2 h_3 h_4]. \square$

Corollary 1.3.18.13. *Suppose adjacent angles $\angle(h, k), \angle(k, l)$ are both acute. Then the rays k, l lie on the same side of the line \bar{h} .³²⁶*

³²³In other words, we require that the angles $\angle(h_2, h_3), \angle(h_3, h_4)$ are adjacent (see p. 38) and are both acute.

³²⁴At this point it is instructive to note that the rays h_2, h_3, h_4 all lie on the same side of the line \bar{h}_3 .

³²⁵Recall that $[h_i h_j h_k]$ is a shorthand for $h_j \subset \text{Int}\angle(h_i, h_k)$.

³²⁶And then, of course, k, h lie on the same side of the line \bar{l} , but, due to symmetry this essentially adds nothing new.

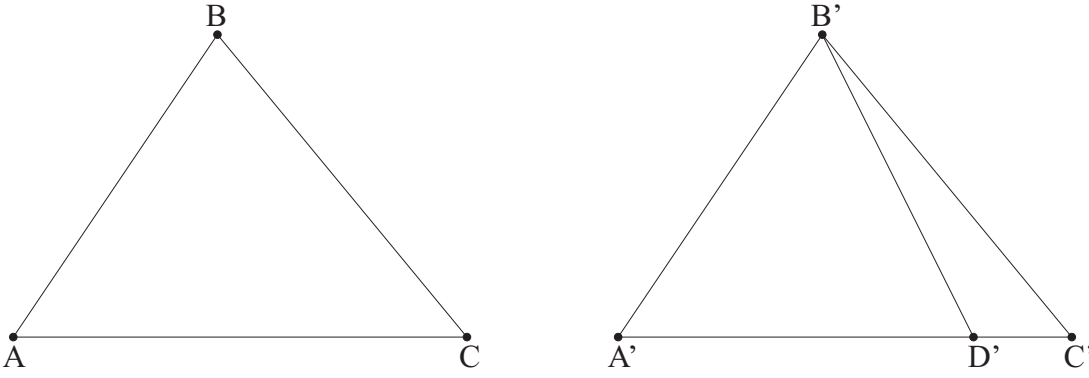

Figure 1.134: If a side AB and angles $\angle A$, $\angle C$ of a triangle $\triangle ABC$ are congruent, respectively, to a side $A'B'$ and angles $\angle A'$, $\angle C'$ of a triangle $\triangle A'B'C'$, the triangles $\triangle ABC$, $\triangle A'B'C'$ are congruent. (SAA, or The Fourth Triangle Congruence Theorem)

Proof. Take points $H \in h$, $L \in l$. By the preceding corollary (C 1.3.18.12) the ray k meets the open interval (HL) in some point K . Since the points K, L lie on the same ray H_L whose initial point H lies on \bar{h} , they lie on one side of \bar{h} (see L 1.2.11.13, L 1.2.19.8). Then by T 1.2.19 the rays k, l , containing these points, also lie on the same side of \bar{h} , q.e.d. \square

SAA

Theorem 1.3.19 (Fourth Triangle Congruence Theorem (SAA)). *If a side AB and angles $\angle A$, $\angle C$ of a triangle $\triangle ABC$ are congruent, respectively, to a side $A'B'$ and angles $\angle A'$, $\angle C'$ of a triangle $\triangle A'B'C'$, the triangles $\triangle ABC$, $\triangle A'B'C'$ are congruent.*

Proof. (See Fig. 1.134.) Suppose the contrary, i.e. $\triangle ABC \not\equiv \triangle A'B'C'$. Then by T 1.3.5 $\angle B \not\equiv \angle B'$.³²⁷ Let $\angle B < \angle B'$.³²⁸ $\angle B < \angle B' \xrightarrow{\text{L1.3.16.3}} \angle ABC \equiv \angle A'B'D' \ \& \ [A'D'C']$. $[A'D'C'] \xrightarrow{\text{L1.2.11.15}} A'D' = A'C' \Rightarrow \angle B'A'D' = \angle B'A'C' = \angle A'$. $AB \equiv A'B' \ \& \ \angle A \equiv \angle B'A'D' = \angle A' \ \& \ \angle ABC \equiv \angle A'B'D' \xrightarrow{\text{T1.3.5}} \triangle ABC \equiv \triangle A'B'D'$. But $\angle A'C'B' \equiv \angle ACB \ \& \ \angle ACB \equiv \angle A'D'B' \xrightarrow{\text{T1.3.11}} \angle A'C'B' \equiv \angle A'D'B'$, which contradicts T 1.3.17. \square

Proposition 1.3.19.1. *Consider two simple quadrilaterals, $ABCD$ and $A'B'C'D'$ with $AB \equiv A'B'$, $BC \equiv B'C'$, $\angle ABC \equiv \angle A'B'C'$, $\angle BAD \equiv \angle B'A'D'$, $\angle BCD \equiv \angle B'C'D'$. Suppose further that if A, D lie on the same side of the line a_{BC} then A', D' lie on the same side of the line $a_{B'C'}$, and if A, D lie on the opposite sides of the line a_{BC} then A', D' lie on the opposite sides of the line $a_{B'C'}$. Then the quadrilaterals are congruent, $ABCD \equiv A'B'C'D'$.*³²⁹

Proof. Denote $E \equiv a_{BC} \cap a_{AD}$. Evidently, $E \neq A$, $E \neq D$.³³⁰ Observe that $D \in A_E$. In fact, otherwise in view of C 1.2.1.7 we would have $\exists F$ ($[AFB] \ \& \ [DFC]$) contrary to simplicity of $ABCD$. Note also that $D \in A_E \ \& \ D \neq E \xrightarrow{\text{L1.2.11.8}} [ADE] \vee [AED]$. Similarly, $D' \in A'_{E'}$ and, consequently, we have either $[A'D'E']$ or $[A'E'D']$. Furthermore, $AB \equiv A'B' \ \& \ BC \equiv B'C' \ \& \ \angle ABC \equiv \angle A'B'C' \xrightarrow{\text{T1.3.4}} \triangle ABC \equiv \triangle A'B'C' \Rightarrow \angle BAC \equiv \angle B'A'C' \ \& \ \angle ACB \equiv \angle A'C'B' \ \& \ AC \equiv A'C'$.

According to T 1.2.2 we have either $[EBC]$, or $[BEC]$, or $[BCE]$. Suppose that $[EBC]$. Then $\neg[ADE]$, for otherwise $\exists F$ ($[CFD] \ \& \ [AFB]$) by C 1.2.1.7. Turning to the quadrilateral $A'B'C'D'$ we find that here, too, we always have $D' \in A'_{E'}$ and either $[E'B'C']$, or $[B'E'C']$, or $[B'C'E']$. We are going to show that under our current assumption that $[EBC]$ we have $[E'B'C']$. In fact, $[B'E'C']$ is inconsistent with $[A'E'D']$, for $E' \in (B'C') \cap (A'D')$ contradicts simplicity.³³¹ Suppose that $[B'C'E']$. Then using T 1.3.17 we can write $\angle BCD = \angle ECD < \angle CEA = \angle BEA < \angle ABC \equiv \angle A'B'C' < \text{angle } A'C'E' < \angle C'E'D' < \angle B'C'D'$, whence $\angle BCD < \angle B'C'D'$ (see L 1.3.16.6 – L 1.3.16.8), which contradicts $\angle BCD \equiv \angle B'C'D'$ (see L 1.3.16.11). Thus, we see that $[E'B'C']$. We can now write $\angle BAD \equiv \angle B'A'D' \ \& \ \angle BAC \equiv \angle B'A'C' \ \& \ A_B \subset \text{Int} \angle CAD \ \& \ A'_{B'} \subset \text{Int} \angle C'A'D' \xrightarrow{\text{T1.3.9}} \angle CAD \equiv \angle C'A'D'$,³³²

³²⁷For otherwise $AB \equiv A'B' \ \& \ \angle A \equiv \angle A' \ \& \ \angle B \equiv \angle B' \xrightarrow{\text{T1.3.5}} \triangle ABC \equiv \triangle A'B'C'$.

³²⁸Due to symmetry of the relations of congruence of intervals, angles, and, as a consequence, triangles (see T 1.3.1, T 1.3.11, C 1.3.11.2).

³²⁹Perhaps this is not a very elegant result with a proof that is still less elegant, but we are going to use it to prove some fundamental theorems. (See, for example, T 3.1.11.)

³³⁰Since $ABCD$ is simple, no three vertices of this quadrilateral are collinear.

³³¹We cannot have $[A'D'E']$, for this would mean that the points A', D' lie on the same side of the line $a_{B'C'}$. But since A, D lie on the opposite sides of a_{BC} , one of the conditions of our proposition dictates that A', D' lie on the opposite sides of $a_{B'C'}$.

³³²We take into account that in view of L 1.2.21.6, L 1.2.21.4 we have $B \in (EC) \Rightarrow A_B \subset \text{Int} \angle CAD$ and similarly $B' \in (E'C') \Rightarrow A'_{B'} \subset \text{Int} \angle C'A'D'$. We also take into account that $[AED] \xrightarrow{\text{L1.2.11.15}} A_E = A_D \Rightarrow \angle CAE = \angle CAD$. Similarly, we conclude that $\angle C'A'E' = \angle C'A'D'$.

$\angle ACB \equiv \angle A'C'B' \& \angle BCD \equiv \angle B'C'D' \& C_B \subset \text{Int}\angle ACD \& C'_{B'} \subset \text{Int}\angle A'C'D' \xrightarrow{\text{T1.3.9}} \angle ACD \equiv \angle A'C'D'$,³³³
 $AC \equiv A'C' \& \angle CAD \equiv \angle C'A'D' \& \angle ACD \equiv \angle A'C'D' \& \angle A'C'D' \xrightarrow{\text{T1.3.5}} \triangle ADC \equiv \triangle A'D'C' \Rightarrow AD \equiv A'D' \& CD \equiv C'D' \& \angle ADC \equiv \angle A'D'C'$.

Suppose now that $[BEC]$. Then, as we have seen, $[ADE]$. We are going to show that in this case we have $[B'E'C']$. In order to do this, suppose that $[B'C'E']$. (We have seen above that $[E'B'C']$ is incompatible with $[A'E'D']$). Then $A_D \subset \text{Int}\angle BAC \xrightarrow{\text{C1.3.13.4}} \angle BAD < \angle BAC$, $A'_{C'} \subset \text{Int}\angle B'A'D' \xrightarrow{\text{C1.3.13.4}} \angle B'A'C' < \angle B'A'D'$. Hence $\angle BAD < \angle BAC \& \angle BAC \equiv \angle B'A'C' \& \angle B'A'C' < \angle B'A'D' \Rightarrow \angle BAD < \angle B'A'D'$ (see L 1.3.16.6 – L 1.3.16.8), which contradicts the assumption $\angle BAD \equiv \angle B'A'D'$ (see L 1.3.16.11). Thus, we see that $[B'E'C']$. Using L 1.2.11.15, L 1.2.21.6, L 1.2.21.4, together with $[ADE]$, $[BEC]$ it is easy to see that $A_D \subset \text{Int}\angle BAC$, $C_D \subset \text{Int}\angle ACB$. Similarly, $A'_{D'} \subset \text{Int}\angle B'A'C'$, $C'_{D'} \subset \text{Int}\angle A'C'B'$. We can now write $\angle BAD \equiv \text{angle}B'A'D' \& \angle BAC \equiv \angle B'A'C' \& A_D \subset \text{Int}\angle BAC \& A'_{D'} \subset \text{Int}\angle B'A'C' \xrightarrow{\text{T1.3.9}} \angle CAD \equiv \angle C'A'D'$, $\angle BCD \equiv \angle B'C'D' \& \angle BCA \equiv \angle B'C'A' \& C_D \subset \text{Int}\angle BCA \& C'_{D'} \subset \text{Int}\angle B'C'A' \xrightarrow{\text{T1.3.9}} \angle ACD \equiv \angle A'C'D'$, $AC \equiv A'C' \& \angle CAD \equiv \angle C'A'D' \& \angle ACD \equiv \angle A'C'D' \xrightarrow{\text{T1.3.5}} \triangle ADC \equiv \triangle A'D'C' \Rightarrow AD \equiv A'D' \& CD \equiv C'D' \& \angle ADC \equiv \angle A'D'C'$.

Finally, suppose that $[BCE]$. The arguments given above show that $[B'C'E']$. Then we have $\angle BAC \equiv \angle B'A'C' \& \angle BAD \equiv \angle B'A'D' \& A_C \subset \text{Int}\angle BAD \& A'_{C'} \subset \text{Int}\angle B'A'D' \xrightarrow{\text{T1.3.9}} \angle CAD \equiv \angle C'A'D'$. First, suppose that $[ADE]$, i.e. that the points A, D lie on the same side of a_{BC} . Then, according to our assumption, A', D' lie on the same side of $a_{B'C'}$, which means in this case that $[A'D'E']$. We can write $[BCE] \Rightarrow \angle BCD = \text{adjsp}\angle ECD$, whence $C_D \subset \text{Int}\angle ACE \xrightarrow{\text{L1.2.21.22}} C_A \subset \text{Int}\angle BCD$. Similarly, we have $[B'C'E'] \Rightarrow \angle B'C'D' = \text{adjsp}\angle E'C'D'$, whence $C'_{D'} \subset \text{Int}\angle A'C'E' \xrightarrow{\text{L1.2.21.22}} C'_{A'} \subset \text{Int}\angle B'C'D'$. Hence $\angle BCA \equiv \angle B'C'A' \& \angle BCD \equiv \angle B'C'D' \& C_A \subset \text{Int}\angle BCD \& C'_{A'} \subset \text{Int}\angle B'C'D' \xrightarrow{\text{T1.3.9}} \angle ACD \equiv \angle A'C'D'$, $AC \equiv A'C' \& \angle CAD \equiv \angle C'A'D' \& \angle ACD \equiv \angle A'C'D' \xrightarrow{\text{T1.3.19}} \triangle ADC \equiv \triangle A'C'D' \Rightarrow CD \equiv C'D' \& AD \equiv A'D' \& \text{angle}CDA \equiv \angle C'D'A'$.

At last, suppose that $[AED]$, i.e. that the points A, D lie on opposite sides of the line a_{BC} . We have $[BCE] \Rightarrow \angle ACE = \text{adjsp}\angle ACB \& \angle DCE = \text{adjsp}\angle DCB$, $[B'C'E'] \Rightarrow \angle A'C'E' = \text{adjsp}\angle A'C'B' \& \angle D'C'E' = \text{adjsp}\angle D'C'B'$. Hence in view of T 1.3.6 we can write $\angle ACB \equiv \angle A'C'B' \Rightarrow \angle ACE \equiv \angle A'C'E'$, $\angle DCB \equiv \angle D'C'B' \Rightarrow \angle DCE \equiv \angle D'C'E'$. But from L 1.2.21.6, L 1.2.21.4 we have $[AED] \Rightarrow C_E \subset \text{Int}\angle ACD$, $[A'E'D'] \Rightarrow C'_{E'} \subset \text{Int}\angle A'C'D'$. Finally, we can write $\angle ACE \equiv \angle A'C'E' \& \angle DCE \equiv \angle D'C'E' \& C_E \subset \text{Int}\angle ACD \& C'_{E'} \subset \text{Int}\angle A'C'D' \xrightarrow{\text{T1.3.9}} \angle ACD \equiv \angle A'C'D'$ and $AC \equiv A'C' \& \angle CAD \equiv \angle C'A'D' \& \angle CDA \equiv \angle C'D'A' \xrightarrow{\text{T1.3.5}} \triangle CAD \equiv \triangle C'A'D'$, whence the result. \square

Proposition 1.3.19.2. *Consider two simple quadrilaterals, $ABCD$ and $A'B'C'D'$ with $AB \equiv A'B'$, $BC \equiv B'C'$, $\angle ABC \equiv \angle A'B'C'$, $\angle BAD \equiv \angle B'A'D'$, $\angle ACD \equiv \angle A'C'D'$. Suppose further that if C, D lie on the same side of the line a_{AB} then C', D' lie on the same side of the line $a_{A'B'}$, and if C, D lie on the opposite sides of the line a_{AB} then C', D' lie on the opposite sides of the line $a_{A'B'}$. Then the quadrilaterals are congruent, $ABCD \equiv A'B'C'D'$.*

Proof. As in the preceding proposition, we can immediately write $AB \equiv A'B' \& BC \equiv B'C' \& \angle ABC \equiv \angle A'B'C' \xrightarrow{\text{T1.3.4}} \triangle ABC \equiv \triangle A'B'C' \Rightarrow \angle BAC \equiv \angle B'A'C' \& \angle ACB \equiv \angle A'C'B' \& AC \equiv A'C'$. We start with the case where the points C, D lie on the same side of the line a_{AB} . Then, by hypothesis, C', D' lie on the same side of the line $a_{A'B'}$. First, suppose that also the points B, D lie on the same side of the line a_{AC} . This implies $B'D'a_{A'C'}$. In fact, since, as shown above, the points C', D' lie on the same side of $a_{A'B'}$, from L 1.2.21.21 we have either $A'_{C'} \subset \text{Int}\angle B'A'D'$ or $A'_{D'} \subset \text{Int}\angle B'A'D'$.³³⁴ But the first of these options in view of C ?? would imply $\angle BAC < \angle BAD \equiv \angle B'A'D' < \angle B'A'C'$, whence by L 1.3.16.6 - L 1.3.16.8 we have $\angle BAC < \angle B'A'C'$, which contradicts $\angle BAC \equiv \angle B'A'C'$ in view of L 1.3.16.8. Thus, we conclude that in this case $B'D'a_{A'C'}$.

We can write $\angle BAC \equiv \angle B'A'C' \& \angle BAD \equiv \angle B'A'D' \& CDa_{AB} \& C'D'a_{A'B'} \xrightarrow{\text{T1.3.9}} \angle CAD \equiv \angle C'A'D'$. $AC \equiv A'C' \& \angle CAD \equiv \angle C'A'D' \& \angle ADC \equiv \angle A'D'C' \xrightarrow{\text{T1.3.19}} \triangle ADC \equiv \triangle A'D'C' \Rightarrow AD \equiv A'D' \& CD \equiv C'D' \& \angle ACD \equiv \angle A'C'D'$. $\angle ACB \equiv \angle A'C'B' \& \angle ACD \equiv \angle A'C'D' \& BDa_{AC} \& B'D'a_{A'C'} \xrightarrow{\text{T1.3.9}} \angle BCD \equiv \angle B'C'D'$.

Now suppose that the points B, D lie on the opposite sides of the line a_{AC} .³³⁵ The points B', D' then evidently lie on the opposite sides of the line $a_{A'C'}$.³³⁶ Using the same arguments as above,³³⁷ we see that $AD \equiv A'D'$, $CD \equiv C'D'$, $\angle BCD \equiv \angle B'C'D'$, as required.

We now turn to the situations where the points C, D lie on the opposite sides of the line a_{AB} . Then, by hypothesis, the points C, D lie on the opposite sides of the line a_{AB} , and we can write $\angle BAD \equiv \angle B'A'D' \& \angle BAC \equiv$

³³³Again, we take into account that $[EBC] \xrightarrow{\text{L1.2.11.15}} C_E = C_B$ and $E \in (AD) \Rightarrow C_E \subset \text{Int}\angle ACD$ in view of L 1.2.21.6, L 1.2.21.4. Similarly, we conclude that $C'_{E'} = C'_{B'}$ and $E' \in (A'D') \Rightarrow C'_{E'} \subset \text{Int}\angle A'C'D'$.

³³⁴Of course, the rays $A'_{C'}$, $A'_{D'}$ cannot coincide due to simplicity of the quadrilateral $A'B'C'D'$.

³³⁵But the points C, D are still assumed to lie on the opposite sides of the line a_{AB} !

³³⁶If B', D' were on the same side of the line $a_{A'C'}$, the points B, D would lie on the same side of the line a_{AC} . This can shown be using essentially the same arguments as those used above to show that BDa_{AC} implies $B'D'a_{A'C'}$. (Observe that the quadrilaterals $ABCD, A'B'C'D'$ enter the conditions of the theorem symmetrically.)

³³⁷We can write $\angle BAC \equiv \angle B'A'C' \& \angle BAD \equiv \angle B'A'D' \& CDa_{AB} \& C'D'a_{A'B'} \xrightarrow{\text{T1.3.9}} \angle CAD \equiv \angle C'A'D'$. $AC \equiv A'C' \& \angle CAD \equiv \angle C'A'D' \& \angle ADC \equiv \angle A'D'C' \xrightarrow{\text{T1.3.19}} \triangle ADC \equiv \triangle A'D'C' \Rightarrow AD \equiv A'D' \& CD \equiv C'D' \& \angle ACD \equiv \angle A'C'D'$. $\angle ACB \equiv \angle A'C'B' \& \angle ACD \equiv \angle A'C'D' \& Ba_{AC}D \& B'a_{A'C'}D' \xrightarrow{\text{T1.3.9}} \angle BCD \equiv \angle B'C'D'$.

$\angle B'A'C' & Ca_{AB}D & C'a_{A'B'}D' \xrightarrow{T1.3.9} \angle CAD \equiv \angle C'A'D', AC \equiv A'C' & \angle CAD \equiv \angle C'A'D' & \angle ADC \equiv \angle A'D'C' \xrightarrow{T1.3.9} \triangle ACD \equiv \triangle A'C'D' \Rightarrow AD \equiv A'D' & CD \equiv C'D' & \angle ACD \equiv \angle A'C'D'.$

Again, we start proving the rest of the congruences by assuming that the points B, D lie on the same side of the line a_{AC} . We are going to show that in this case the points B', D' lie on the same side of the line $a_{A'C'}$. Suppose the contrary, i.e. that $B'a_{A'C'}D'$. Choosing a point E' such that $[C'A'E']$ (see A 1.2.2), it is easy to see that the ray $A'E'$ lies inside the angle $\angle B'A'D'$,³³⁸ which, in turn, implies that $\angle B'A'E' < \angle B'A'D'$ (see C 1.3.16.4). Note that $BDa_{AC} \xrightarrow{L1.2.21.21} A_D \subset \text{Int}\angle CAB \vee A_B \subset \text{Int}\angle CAD$. But $A_D \subset \text{Int}\angle CAB$ in view of definition of interior would imply that the points C, D lie on the same side of the line a_{AB} contrary to our assumption. Thus, we see that $A_B \subset \text{Int}\angle CAD$. By L 1.2.21.10 $\exists E(E \in A_B \cap (CD))$. We have $E \in A_B \xrightarrow{L1.2.21.21} [AEB] \vee E = B \vee [ABE]$. But $[ABE]$ and $E = B$ contradict simplicity of the quadrilateral $ABCD$. Thus, we conclude that $[ABE]$. Hence using T 1.3.17 (see also L 1.2.11.15) we can write $\angle BAD = \angle DAE < \angle AEC = \angle BEC < \angle ABC$, whence $\angle BAD < \angle ABC$ (see L 1.3.16.6 – L 1.3.16.8). On the other hand, we have $\angle A'B'C' < \angle B'A'E'$. Taking into account $\angle B'A'E' < \angle B'A'D'$ and using L 1.3.16.8, we find that $\angle A'B'C' < \angle B'A'D'$. Now we can write $\angle BAD < \angle ABC \equiv \angle A'B'C' < \angle B'A'D' \Rightarrow \angle BAD < \angle B'A'D'$ (see L 1.3.16.6 – L 1.3.16.8), which (in view of L 1.3.16.11) contradicts $\angle BAD \equiv \angle B'A'D'$ (the latter is true by hypothesis). This contradiction refutes our assumption that the points B', D' lie on the opposite sides of the line $a_{A'C'}$ given that the points B, D lie on the same side of a_{AC} . Thus, since we assume BDa_{AC} , we also have $B'D'a_{A'C'}$. Now we can write $\angle ACB \equiv \angle A'C'B' & \angle ACD \equiv \angle A'C'D' & BDa_{AC} & B'D'a_{A'C'} \xrightarrow{T1.3.9} \angle BCD \equiv \angle B'C'D'.$

Finally, observing that $Ba_{AC}D$ implies that $B'a_{A'C'}D'$,³³⁹ we can write $\angle ACB \equiv \angle A'C'B' & \angle ACD \equiv \angle A'C'D' & a_{AC}D & B'a_{A'C'}D' \xrightarrow{T1.3.9} \angle BCD \equiv \angle B'C'D'.$ \square

Proposition 1.3.19.3. *Consider two simple quadrilaterals, $ABCD$ and $A'B'C'D'$ with $AB \equiv A'B', BC \equiv B'C', CD \equiv C'D', \angle ABC \equiv \angle A'B'C', \angle BCD \equiv \angle B'C'D'$.³⁴⁰ Suppose further that if A, D lie on the same side of the line a_{BC} then A', D' lie on the same side of the line $a_{B'C'}$, and if A, D lie on the opposite sides of the line a_{BC}*

³³⁸We have $C'a_{A'B'}D' & C'a_{A'B'}E' \xrightarrow{L1.2.18.4} D'E'a_{A'B'}, D'E'a_{A'B'} \xrightarrow{L1.2.21.21} A'D' \subset \text{Int}\angle B'A'E' \vee A'D' \subset \text{Int}\angle B'A'E'$. But $A'D' \subset \text{Int}\angle B'A'E'$ in view of the definition of interior of the angle $\angle B'A'E'$ would imply that the points B', D' lie on the same side of the line $a_{A'C'}$, contrary to our assumption.

³³⁹Evidently, $B'D'a_{A'C'}$ would imply BDa_{AC} . This is easily seen using arguments completely symmetrical (with respect to priming) to those employed to show that BDa_{AC} implies $B'D'a_{A'C'}$.

³⁴⁰Actually, we need to assume simplicity only for $ABCD$. The simplicity of $A'B'C'D'$ can then be established using the other conditions of the proposition in the following less than elegant proof. Observe that $AB \equiv A'B' & BC \equiv B'C' & \angle ABC \equiv \angle A'B'C' \xrightarrow{T1.3.4} \triangle ABC \equiv \triangle A'B'C' \Rightarrow \angle ABC \equiv \angle A'B'C' & \angle ACB \equiv \angle A'C'B' & AC \equiv A'C', BC \equiv B'C' & CD \equiv C'D' & \angle BCD \equiv \angle B'C'D' \xrightarrow{T1.3.4} \triangle BCD \equiv \triangle B'C'D' \Rightarrow BD \equiv B'D' & \angle CBD \equiv \angle C'B'D' & \angle CDB \equiv \angle C'D'B'$. Since either both A, D lie on the same side of a_{BC} and A', D' lie on the same side of $a_{B'C'}$ or both A, D lie on the opposite side of a_{BC} and A', D' lie on the opposite sides of $a_{B'C'}$, taking into account the congruences $\angle ABC \equiv \angle A'B'C', \angle DBC \equiv \angle D'B'C', \angle ACB \equiv \angle A'C'B', \angle DCB \equiv \angle D'C'B'$, assuming that both A, B, D as well as A, D, C are not collinear (and, as we will see below, this is indeed the case given the conditions of the proposition) using T 1.3.9 we find that $\angle ABD \equiv \angle A'B'D', \angle ACD \equiv \angle A'C'D'$, whence $AB \equiv A'B' & BD \equiv B'D' & \angle ABD \equiv \angle A'B'D' \xrightarrow{T1.3.4} \triangle ABD \equiv \triangle A'B'D' \Rightarrow AD \equiv A'D' & \angle BAD \equiv \angle B'A'D' & \angle BDA \equiv \angle B'D'A', AC \equiv A'C' & CD \equiv C'D' & \angle ACD \equiv \angle A'C'D' \xrightarrow{T1.3.4} \triangle ACD \equiv \triangle A'C'D' \Rightarrow \angle CAD \equiv \angle C'A'D' & \angle CDA \equiv \angle C'D'A'$. Consider first the case where the points A, D lie on the opposite sides of the line a_{BC} and, consequently, the points A', D' lie on the opposite sides of the line $a_{B'C'}$. Given the assumptions implicit in the conditions of the theorem, we just need to establish that the open intervals $(AD), (BC)$ do not meet and that the points A', B', D' , as well as the points B', C', D' , are not collinear, for the only ways that the quadrilateral $A'B'C'D'$ can be not simple are if $(AD) \cap (BC) \neq \emptyset$, or $B' \in a_{A'D'}$, or $C' \in a_{A'D'}$. (Since the (non-straight) angles $\angle A'B'C', \angle B'C'D'$ are assumed to exist, the points A', B', C' are not collinear, as are points B', C', D' . Therefore, $(A'B') \cap (B'C') = \emptyset$ and $(B'C') \cap (C'D') = \emptyset$, as is easy to see using L 1.2.1.3. Furthermore, since points A', D' lie on the opposite sides of $a_{B'C'}$, the open intervals $(A'B'), (C'D')$ lie on the opposite sides of the line $a_{B'C'}$ (see T 1.2.20) and thus also have no common points.) Denote $E \equiv (AD) \cap a_{BC}, E' \equiv (A'D') \cap a_{B'C'}$. Evidently, $E \neq B, E \neq C$, and $\neg[BEC]$ due to simplicity of the quadrilateral $ABCD$. Hence by T 1.2.2 we have either $[EBC]$ or $[BCE]$. We are going to show that $E' \neq B'$ and $E' \neq C'$, which will imply that A', B', D' , as well as B', C', D' , are not collinear for the case in question. To do this, suppose the contrary, i.e. that, say, $E' = B'$. Then $\angle C'B'D'$ is adjacent supplementary to $\angle A'B'C'$, and in view of $\angle ABC \equiv \angle A'B'C', \angle CBD \equiv \angle C'B'D'$ using C 1.3.6.1 (recall that the points A, D lie on the opposite sides of the line a_{BC}), we conclude that the angle $\angle CBD$ is adjacent supplementary to the angle $\angle ABC$, which, in turn, implies that the points A, B, D are collinear, contrary to the simplicity of the quadrilateral $ABCD$. Similarly, assuming that $E' = C'$ (which obviously makes the angles $\angle A'C'B', \angle D'C'B'$ adjacent supplementary), taking into account that $Aa_{BC}D, \angle ACB \equiv \angle A'C'B', \angle DCB \equiv \angle D'C'B'$, and using C 1.3.6.1 we would find that the angles $\angle ACB, \angle DCB$ are adjacent supplementary in contradiction with the simplicity of $ABCD$. (Once we know that $E' \neq B'$, we can immediately conclude that $E' \neq C'$ because the conditions of the proposition are invariant with respect to the simultaneous substitutions $A \leftrightarrow D, B \leftrightarrow C, A' \leftrightarrow D', B' \leftrightarrow C'$.) To show that $\neg[B'E'C']$, suppose the contrary. If $[EBC]$ then using L 1.2.11.15, L 1.2.21.6, L 1.2.21.4, C 1.3.16.4 along the way, we can write $\angle BAC < \angle EAC = \angle CAD \equiv \angle C'A'D' = \angle C'A'E' < \angle B'A'C'$, whence (see L 1.3.16.6 – L 1.3.16.8) $\angle BAC < \angle B'A'C'$, which in view of L 1.3.16.11 contradicts the congruence $\angle BAC \equiv \angle B'A'C'$ established earlier. If $[BCE]$ then (using again L 1.2.11.15, L 1.2.21.6, L 1.2.21.4, C 1.3.16.4 along the way) we can write $\angle CDB < \angle BDE = \angle BDA \equiv \angle B'D'A' = \angle B'D'E' < \angle C'D'B'$, whence (see L 1.3.16.6 – L 1.3.16.8) $\angle CDB < \angle C'D'B'$, which in view of L 1.3.16.11 contradicts the congruence $\angle CDB \equiv \angle C'D'B'$ established earlier. (Again, once the case where $[EBC]$ has been considered, the contradiction for the case where $[BCE]$ can be immediately obtained from symmetry considerations; namely, from the fact that the conditions of the theorem are left unchanged by the simultaneous substitutions $A \leftrightarrow D, B \leftrightarrow C, A' \leftrightarrow D', B' \leftrightarrow C'$.) We now turn to the case where the points A, D lie on the same side of the line a_{BC} and, consequently, the points A', D' lie on the same side of the line $a_{B'C'}$. Obviously, the only way the quadrilateral $A'B'C'D'$ could be not simple given the conditions of the theorem is if the half-closed intervals $(B'A'], (C'D']$ have a common point, say, E' . But then it is easy to show using C 1.3.6.2 that the half-closed intervals $(BA], (CD]$ have a common point, say, E , which contradicts the assumed simplicity of $ABCD$. (In fact, since $E' = (B'A'] \cap (C'D']$ and $(B'A'] \subset B'A', (C'D'] \subset C'D'$ (see L 1.2.11.1, L 1.2.11.13), we have $E' = B'A' \cap C'D'$. Taking into account $\angle ABC \equiv \angle A'B'C', \angle BCD \equiv \angle B'C'D'$ and using C 1.3.6.2, we see that the rays B_A, C_D meet in some point E such that $\triangle AEC \equiv \triangle A'E'C'$, which implies that $AE \equiv A'E', CE \equiv C'E'$. Then from L 1.3.13.3, T 1.3.2 we find that the point E lies on the half-closed intervals $(BA], (CD]$ in contradiction with the assumed simplicity of $ABCD$.)

then A', D' lie on the opposite sides of the line $a_{B'C'}$. Then the quadrilaterals are congruent, $ABCD \equiv A'B'C'D'$.

Proof. As in the preceding two propositions, we can immediately write $AB \equiv A'B' \& BC \equiv B'C' \& \angle ABC \equiv \angle A'B'C' \xrightarrow{T1.3.4} \triangle ABC \equiv \triangle A'B'C' \Rightarrow \angle BAC \equiv \angle B'A'C' \& \angle ACB \equiv \angle A'C'B' \& AC \equiv A'C'$. We start with the case where the points A, D lie on the same side of the line a_{BC} . Then, by hypothesis, A', D' lie on the same side of the line $a_{B'C'}$. Using T 1.3.9 we find that $\angle ACD \equiv \angle A'C'D'$, whence $AC \equiv A'C' \& CD \equiv C'D' \& \angle ACD \equiv \angle A'C'D' \xrightarrow{T1.3.4} AD \equiv A'D' \& \angle CDA \equiv \angle C'D'A'$. From L 1.2.21.21 we have either $C_A \subset \text{Int}\angle BCD$ or $C_D \subset \text{Int}\angle BCA$. If $C_A \subset \text{Int}\angle BCD$ then by P 1.3.9.5 also $C'_{A'} \subset \text{Int}\angle B'C'D'$, and we can write $\angle BAC \equiv \angle B'A'C' \& \angle DAC \equiv \angle D'A'C' \& BD a_{AC} \& B'D' a_{A'C'} \xrightarrow{T1.3.9} \angle BAD \equiv \angle B'A'D'$. Suppose $C_D \subset \text{Int}\angle BCA$. Then $\exists E (E \in C_D \cap (BA))$. Hence (see also L 1.2.19.8) we can write $\angle CAD \equiv \angle C'A'D' \& \angle CAE \equiv \angle AE \& ED a_{AC} \& E'D' a_{A'C'} \xrightarrow{T1.3.9} \angle DAE \equiv \angle D'A'E'$, whence $\angle DAB \equiv \angle D'A'B'$ (we also take into account that $\angle CAE = \angle CAB, \angle DAB = \angle DAE, \angle C'A'E' = \angle C'A'B', \angle D'A'B' = \angle D'A'E'$ in view of L 1.2.11.15).

Consider now the case where $Aa_{BC}D$. Then, by hypothesis, also $A'a_{B'C'}D'$. We can write $\angle ACB \equiv \angle A'C'B' \& \angle DCB \equiv \angle D'C'B' \& Aa_{BC}D \& A'a_{B'C'}D' \xrightarrow{T1.3.9} \angle ACD \equiv \angle A'C'D', AC \equiv A'C' \& CD \equiv C'D' \& \angle ACD \equiv \angle A'C'D' \xrightarrow{T1.3.4} \triangle CDA \equiv \triangle C'D'A' \Rightarrow AD \equiv A'D' \& \angle CDA \equiv \angle C'D'A'$.

Denote $E \equiv (AD) \cap a_{BC}$,³⁴¹ $E' \equiv (A'D') \cap a_{B'C'}$. In view of T 1.2.2 we have either $[EBC]$ or $[BCE]$ and, similarly, either $[E'B'C']$ or $[B'C'E']$. (Evidently, due to simplicity of $ABCD$, we can immediately discard from our consideration the cases $E = B, [BEC], E = C, E' = B', [B'E'C'], E' = C'$. \square We are going to show that if $[EBC]$ then also $[E'B'C']$. To establish this suppose the contrary, i.e. that both $[EBC]$ and $[B'C'E']$. Then, using T 1.3.17 we would have $\angle BCD = \angle ECD < \angle AEC = \angle AEB < \angle ABC \equiv \angle A'B'C' = \angle A'B'E' < \angle B'E'D' = \angle C'E'D' < \angle B'C'D'$ (see also L 1.2.11.15), whence $\angle BCD < \angle B'C'D'$ (see L 1.3.16.6 – L 1.3.16.8), which contradicts $\angle BCD \equiv \angle B'C'D'$ in view of L 1.3.16.11. Thus, we see that $[BEC]$ implies $[B'E'C']$. Similar arguments show that $[BCE]$ implies $[B'C'E']$.³⁴² Consider first the case where $[EBC], [E'B'C']$. Then we can write $[EBC] \Rightarrow A_B A_D a_{AC}, [E'B'C'] \Rightarrow A'_{B'} A'_{D'} a_{A'C'}, \angle CAB \equiv \angle C'A'B' \& \angle CAD \equiv \angle C'A'D' \& A_B A_D a_{AC} \& A'_{B'} A'_{D'} a_{A'C'} \xrightarrow{T1.3.9} \angle BAD \equiv \angle B'A'D'$. Finally, suppose $[BCE], [B'C'E']$. Then $\angle CAB \equiv \angle C'A'B' \& \angle CAD \equiv \angle C'A'D' \& A_B a_{AC} A_D \& A'_{B'} a_{A'C'} A'_{D'} \xrightarrow{T1.3.9} \angle BAD \equiv \angle B'A'D'$.

Theorem 1.3.20. *Suppose a point B does not lie on a line a_{AC} and D is the foot of the perpendicular drawn to a_{AC} through B . Then:*

- The angle $\angle BAC$ is obtuse if and only if the point A lies between D, C .
- The angle $\angle BAC$ is acute if and only if the point D lies on the ray AC .³⁴³
- The point D lies between the points A, C iff the angles $\angle BCA, \angle BAC$ are both acute.

Proof. Suppose $[ADC]$ (see Fig. 1.135, a)). Then $[ADC] \xrightarrow{L1.2.11.15} A_D = A_C \Rightarrow \angle BAD = \angle BAC$. On the other hand, $\angle BDC$ is a right angle, and by T 1.3.17 $\angle BAD < \angle BDC$, which, in its turn, means that $\angle BAC$ is an acute angle. Since $[ADC] \Rightarrow [CDA]$, we immediately conclude that the angle $\angle BCA$ is also acute.

Suppose $[DAC]$ (see Fig. 1.135, b)). Then, again by T 1.3.17, $\angle BDA < \angle BAC$. Since $\angle BDA$ is a right angle,³⁴⁴ the angle $\angle BAC$ is bound to be obtuse in this case.

Suppose $\angle BAC$ is acute.³⁴⁵ Then $D \neq A$ and $\neg[DAC]$ - otherwise the angle $\angle BAC$ would be, respectively, either right or obtuse. But $D \in a_{AC} \& D \neq A \& \neg[DAC] \Rightarrow D \in A_C$.

Substituting A for C and C for A in the newly obtained result, we can conclude at once that if the angle $\angle BCA$ is acute, this implies that $D \in C_A$.

Therefore, when $\angle BAC$ and $\angle BCA$ are both acute, we can write $D \in A_C \cap C_A = (AC)$ (see L 1.2.15.1).

Finally, if $\angle BAC$ is obtuse, then $D \notin A_C$ (otherwise $\angle BAC$ would be acute), $D \in a_{AC}$, and $D \neq A$. Therefore, $[DAC]$. \square

Relations Between Intervals Divided into Congruent Parts

Lemma 1.3.21.1. *Suppose points B and B' lie between points A, C and A', C' , respectively. Then $AB \equiv A'B'$ and $BC < B'C'$ imply $AC < A'C'$.*

Proof. (See Fig. 1.136.) $BC < B'C' \xrightarrow{L1.3.13.3} \exists C'' [B'C''C'] \& BC \equiv B'C''$. $[A'B'C'] \& [B'C''C'] \xrightarrow{L1.2.3.2} [A'B'C''] \& [A'C''C']$. $[ABC] \& [A'B'C''] \& AB \equiv A'B' \& BC \equiv B'C'' \xrightarrow{A1.3.3} AC \equiv A'C'$. Since also $[A'C''C']$, by L 1.3.13.3 we conclude that $AC < A'C'$. \square

Lemma 1.3.21.2. *Suppose points B and B' lie between points A, C and A', C' , respectively. Then $AB \equiv A'B'$ and $AC < A'C'$ imply $BC < B'C'$.*

³⁴¹ Obviously, E exists by definition of "points A, D lie on the opposite sides of a_{BC} "

³⁴² Observe that the quadrilaterals $ABCD, A'B'C'D'$ enter the conditions of the theorem symmetrically.

³⁴³ And, of course, the angle $\angle BAC$ is right iff $D = A$.

³⁴⁴ Recall that, by hypothesis, $a_{BD} \perp a_{DA} = a_{AC}$.

³⁴⁵ The reader can refer to any of the figures Fig. 1.135, a), c), d) for this case.

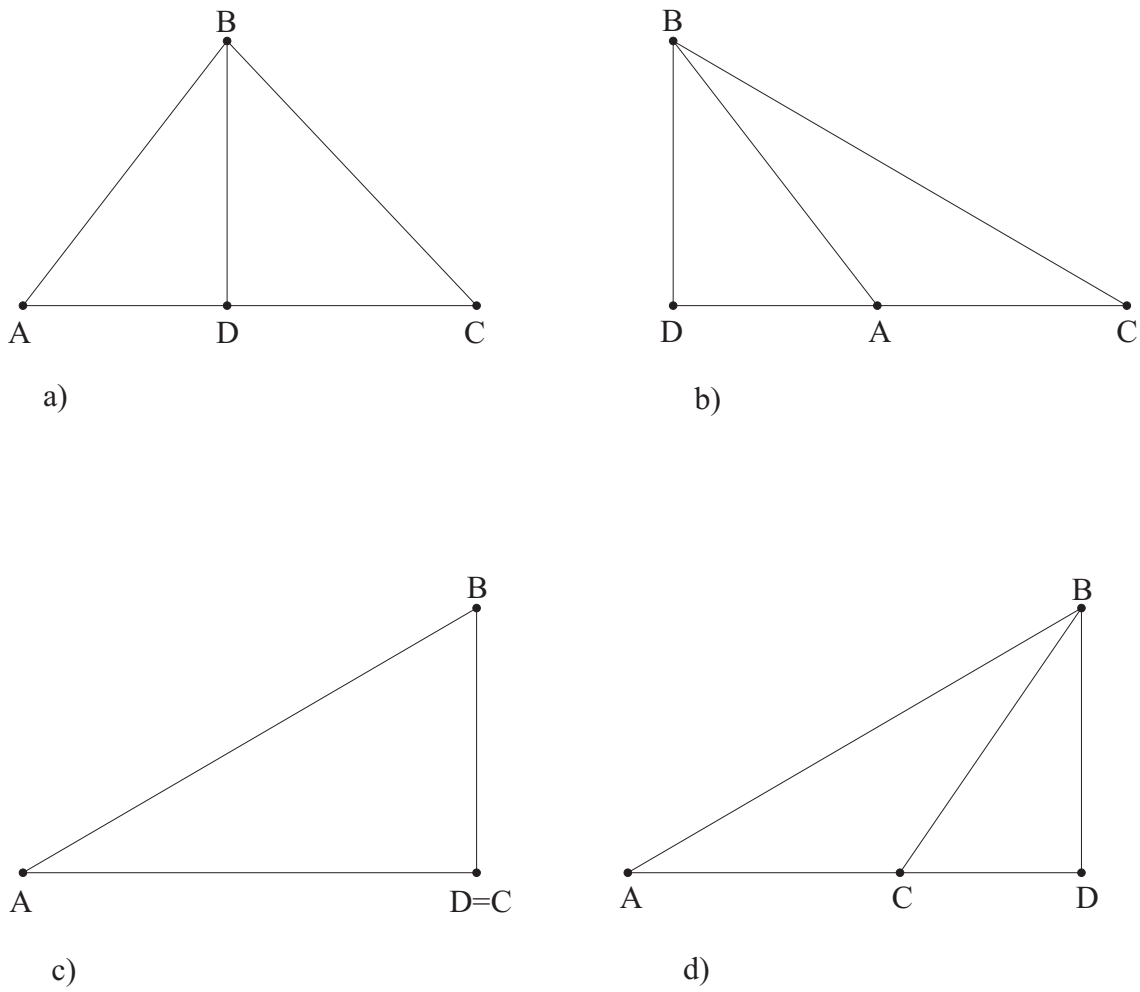

Figure 1.135: Illustration for proof of L 1.3.20.

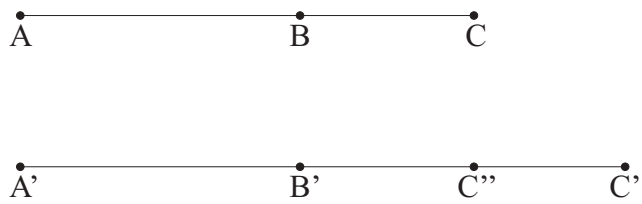

Figure 1.136: Suppose points B and B' lie between points A, C and A', C' , respectively. Then $AB \equiv A'B'$ and $BC < B'C'$ imply $AC < A'C'$.

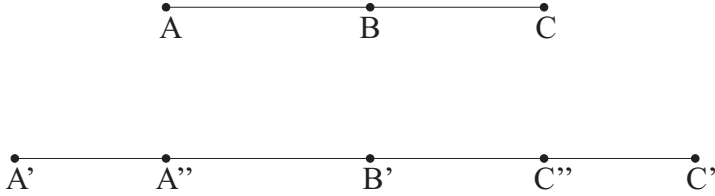

Figure 1.137: Suppose points B and B' lie between points A, C and A', C' , respectively. Then $AB < A'B'$ and $BC < B'C'$ imply $AC < A'C'$.

Proof. By L 1.3.13.14 we have either $BC \equiv B'C'$, or $B'C' < BC$, or $BC < B'C'$. Suppose $BC \equiv B'C'$. Then $[ABC] \& [A'B'C'] \& AB \equiv A'B' \& BC \equiv B'C' \xrightarrow{A1.3.3} AC \equiv A'C'$, which contradicts $AC < A'C'$ in view of L 1.3.13.11. Suppose $B'C' < BC$. In this case $[ABC] \& [A'B'C'] \& A'B' \equiv AB \& B'C' < BC \xrightarrow{L1.3.21.1} A'C' \equiv AC$, which contradicts $AC < A'C'$ in view of L 1.3.13.10. Thus, we have $BC < B'C'$ as the only remaining possibility. \square

Lemma 1.3.21.3. *Suppose points B and B' lie between points A, C and A', C' , respectively. Then $AB < A'B'$ and $BC < B'C'$ imply $AC < A'C'$.*

Proof. (See Fig. 1.137.) $AB < A'B' \& BC < B'C' \xrightarrow{L1.3.13.3} \exists A'' [B'A''A'] \& BA \equiv B'A'' \& \exists C'' [B'C''C'] \& BC \equiv B'C''$. $[A'B'C'] \& [A'A''B'] \& [B'C''C'] \xrightarrow{L1.2.3.2} [A'B'C''] \& [A'C''C'] \& [A'A''C'] \& [A''B'C']$. $[A''B'C'] \& [B'C''C'] \xrightarrow{L1.2.3.2} [A''B'C'']$. $[ABC] \& [A''B'C''] \& AB \equiv A''B' \& BC \equiv B'C'' \xrightarrow{A1.3.3} AC \equiv A''C''$. Finally, $[A'A''C'] \& [A'C''C'] \& AC \equiv A''C'' \xrightarrow{L1.3.13.3} AC < A'C'$. \square

In the following L 1.3.21.4 - L 1.3.21.7 we assume that finite sequences of n points A_1, A_2, \dots, A_n and B_1, B_2, \dots, B_n , where $n \geq 3$, have the property that every point of the sequence, except the first (A_1, B_1) and the last (A_n, B_n) , respectively, lies between the two points of the sequence with the numbers adjacent (in \mathbb{N}) to the number of the given point. Suppose, further, that $\forall i \in \mathbb{N}_{n-2} A_i A_{i+1} \equiv A_{i+1} A_{i+2}$, $B_i B_{i+1} \equiv B_{i+1} B_{i+2}$.³⁴⁶

Lemma 1.3.21.4. *If $\forall i \in \mathbb{N}_{n-1} A_i A_{i+1} \leq B_i B_{i+1}$ and $\exists i_0 \in \mathbb{N}_{n-1} A_{i_0} A_{i_0+1} < B_{i_0} B_{i_0+1}$, then $A_1 A_n < B_1 B_n$.*

Proof. Choose $i_0 \Leftarrow \min\{i | A_i A_{i+1} < B_i B_{i+1}\}$. For $i_0 \in \mathbb{N}_{n-2}$ we have by induction assumption $A_1 A_{n-1} < B_1 B_{n-1}$. Then we can write either $A_1 A_{n-1} < B_1 B_{n-1} \& A_{n-1} A_n \equiv B_{n-1} B_n \xrightarrow{L1.3.21.1} A_1 A_n < B_1 B_n$ or $A_1 A_{n-1} < B_1 B_{n-1} \& A_{n-1} A_n < B_{n-1} B_n \xrightarrow{L1.3.21.3} A_1 A_n < B_1 B_n$. For $i_0 = n-1$ we have by P 1.3.1.5 $A_1 A_{n-1} \equiv B_1 B_{n-1}$. Then $A_1 A_{n-1} \equiv B_1 B_{n-1} \& A_{n-1} A_n < B_{n-1} B_n \xrightarrow{L1.3.21.1} A_1 A_n < B_1 B_n$. \square

Corollary 1.3.21.5. *If $\forall i \in \mathbb{N}_{n-1} A_i A_{i+1} \leq B_i B_{i+1}$, then $A_1 A_n \leq B_1 B_n$.*

Proof. Immediately follows from P 1.3.1.5, L 1.3.21.4. \square

Lemma 1.3.21.6. *The inequality $A_1 A_n < B_1 B_n$ implies that $\forall i, j \in \mathbb{N}_{n-1} A_i A_{i+1} < B_j B_{j+1}$.*

Proof. It suffices to show that $A_1 A_2 < B_1 B_2$, because then by L 1.3.13.6, L 1.3.13.7 we have $A_1 A_2 < B_1 B_2 \& A_1 A_2 \equiv A_i A_{i+1} \& B_1 B_2 \equiv B_j B_{j+1} \Rightarrow A_i A_{i+1} < B_j B_{j+1}$ for all $i, j \in \mathbb{N}_{n-1}$. Suppose the contrary, i.e. that $B_1 B_2 \leq A_1 A_2$. Then by T 1.3.1, L 1.3.13.6, L 1.3.13.7 we have $B_1 B_2 \leq A_1 A_2 \& B_1 B_2 \equiv B_i B_{i+1} \& A_1 A_2 \equiv A_i A_{i+1} \Rightarrow B_i B_{i+1} \leq A_i A_{i+1}$ for all $i \in \mathbb{N}_{n-1}$, whence by C 1.3.21.5 $B_1 B_n \leq A_1 A_n$, which contradicts the hypothesis in view of L 1.3.13.10, C 1.3.13.12. \square

Lemma 1.3.21.7. *The congruence $A_1 A_n \equiv B_1 B_n$ implies that $\forall i, j \in \mathbb{N}_{n-k} A_i A_{i+k} \equiv B_j B_{j+k}$, where $k \in \mathbb{N}_{n-1}$.*³⁴⁷

Proof. Again, it suffices to show that $A_1 A_2 \equiv B_1 B_2$, for then we have $A_1 A_2 \equiv B_1 B_2 \& A_1 A_2 \equiv A_i A_{i+1} \& B_1 B_2 \equiv B_j B_{j+1} \xrightarrow{T1.3.1} A_i A_{i+1} \equiv B_j B_{j+1}$ for all $i, j \in \mathbb{N}_{n-1}$, whence the result follows in an obvious way from P 1.3.1.5 and T 1.3.1. Suppose $A_1 A_2 < B_1 B_2$.³⁴⁸ Then by L 1.3.13.6, L 1.3.13.7 we have $A_1 A_2 < B_1 B_2 \& A_1 A_2 \equiv A_i A_{i+1} \& B_1 B_2 \equiv B_i B_{i+1} \Rightarrow A_i A_{i+1} < B_i B_{i+1}$ for all $i \in \mathbb{N}_{n-1}$, whence $A_1 A_n < B_1 B_n$ by L 1.3.21.4, which contradicts $A_1 A_n \equiv B_1 B_n$ in view of L 1.3.13.11. \square

³⁴⁶Observe that these conditions imply, and this will be used in the ensuing proofs, that $[A_1 A_{n-1} A_n]$, $[B_1 B_{n-1} B_n]$ by L 1.2.7.3, and for all $i, j \in \mathbb{N}_{n-1}$ we have $A_i A_{i+1} \equiv A_j A_{j+1}$, $B_i B_{i+1} \equiv B_j B_{j+1}$ by T 1.3.1.

³⁴⁷Observe that the argument used to prove the present lemma, together with P 1.3.1.5, allows us to formulate the following facts: Given an interval AB consisting of k congruent intervals, each of which (or, equivalently, congruent to one which) results from division of an interval CD into n congruent intervals, and given an interval $A'B'$ consisting of k congruent intervals (congruent to those) resulting from division of an interval $C'D'$ into n congruent intervals, if $CD \equiv C'D'$ then $AB \equiv A'B'$. Given an interval AB consisting of k_1 congruent intervals, each of which (or, equivalently, congruent to one which) results from division of an interval CD into n congruent intervals, and given an interval $A'B'$ consisting of k_2 congruent intervals (congruent to those) resulting from division of an interval $C'D'$ into n congruent intervals, if $CD \equiv C'D'$, $AB \equiv A'B'$, then $k_1 = k_2$.

³⁴⁸Due to symmetry and T 1.3.1, we do not really need to consider the case $B_1 B_2 < A_1 A_2$.

If a finite sequence of points A_i , where $i \in \mathbb{N}_n$, $n \geq 3$, has the property that every point of the sequence, except for the first and the last, lies between the two points with adjacent (in \mathbb{N}) numbers, and, furthermore, $A_1A_2 \equiv A_2A_3 \equiv \dots \equiv A_{n-1}A_n$,³⁴⁹ we say that the interval A_1A_n is divided into $n - 1$ congruent intervals $A_1A_2, A_2A_3, \dots, A_{n-1}A_n$ (by the points A_2, A_3, \dots, A_{n-1}).

If an interval A_1A_n is divided into intervals A_iA_{i+1} , $i \in \mathbb{N}_{n-1}$, all congruent to an interval AB (and, consequently, to each other), we can also say, with some abuse of language, that the interval A_1A_n consists of $n - 1$ intervals AB (or, to be more precise, of $n - 1$ instances of the interval AB).

If an interval A_0A_n is divided into n intervals $A_{i-1}A_i$, $i \in \mathbb{N}_n$, all congruent to an interval CD (and, consequently, to each other), we shall say, using a different kind of folklore, that the interval CD is laid off n times from the point A_0 on the ray A_0P , reaching the point A_n , where P is some point such that the ray A_0P contains the points A_1, \dots, A_n .

Lemma 1.3.21.8. *If intervals A_1A_k and B_1B_n consist, respectively, of $k - 1$ and $n - 1$ intervals AB , where $k < n$, then the interval A_1A_k is shorter than the interval B_1B_n .*

Proof. We have, by hypothesis (and T 1.3.1) $AB \equiv A_1A_2 \equiv A_2A_3 \equiv \dots \equiv A_{k-1}A_k \equiv B_1B_2 \equiv B_2B_3 \equiv \dots \equiv B_{n-1}B_n$, where $[A_iA_{i+1}A_{i+2}]$ for all $i \in \mathbb{N}_{k-2}$ and $[B_iB_{i+1}B_{i+2}]$ for all $i \in \mathbb{N}_{n-2}$. Hence by P 1.3.1.5 $A_1A_k \equiv B_1B_k$, and by L 1.2.7.3 $[B_1B_kB_n]$. By L 1.3.13.3 this means $A_1A_k < B_1B_n$. \square

Lemma 1.3.21.9. *If an interval EF consists of $k - 1$ intervals AB , and, at the same time, of $n - 1$ intervals CD , where $k > n$, the interval AB is shorter than the interval CD .*

Proof. We have, by hypothesis, $EF \equiv A_1A_k \equiv B_1B_n$, where $AB \equiv A_1A_2 \equiv A_2A_3 \equiv \dots \equiv A_{k-1}A_k$, $CD \equiv B_1B_2 \equiv B_2B_3 \equiv \dots \equiv B_{n-1}B_n$, and, of course, $\forall i \in \mathbb{N}_{k-2} [A_iA_{i+1}A_{i+2}]$ and $\forall i \in \mathbb{N}_{n-2} [B_iB_{i+1}B_{i+2}]$. Suppose $AB \equiv CD$. Then the preceding lemma (L 1.3.21.8) would give $A_1A_k > B_1B_n$, which contradicts $A_1A_k \equiv B_1B_n$ in view of L 1.3.13.11. On the other hand, the assumption $AB > CD$ would again give $A_1A_k > B_1B_n$ by C 1.3.21.5, L 1.3.21.8. Thus, we conclude that $AB < CD$. \square

Corollary 1.3.21.10. *If an interval AB is shorter than the interval CD and is divided into a larger number of congruent intervals than is AB , then (any of) the intervals resulting from this division of AB are shorter than (any of) those resulting from the division of CD .*

Proof. \square

Lemma 1.3.21.11. *Any interval CD can be laid off from an arbitrary point A_0 on any ray A_0P any number $n > 1$ of times.*

Proof. By induction on n . Start with $n = 2$. By A 1.3.1 $\exists A_1 A_1 \in A_0P$ & $CD \equiv A_0A_1$. Using A 1.3.1 again, choose A_2 such that $A_2 \in (A_1A_0)^c$ & $CD \equiv A_1A_2$. Since $A_2 \in (A_1A_0)^c \xrightarrow{L1.2.15.2} [A_0A_1A_2]$, we obtain the required result. Observe now that if the conditions of the theorem are true for $n > 2$, they are also true for $n - 1$. Assuming the result for $n - 1$ so that $CD \equiv A_0A_1 \equiv \dots \equiv A_{n-1}A_n$ and $[A_{i-1}A_iA_{i+1}]$ for all $i \in \mathbb{N}_{n-1}$, choose A_n such that $A_n \in (A_{n-1}A_{n-2})^c$ & $CD \equiv A_{n-1}A_n$. Then $A_n \in (A_{n-1}A_{n-2})^c \xrightarrow{L1.2.15.2} [A_{n-2}A_{n-1}A_n]$, so we have everything that is required. \square

Let an interval A_0A_n be divided into n intervals $A_0A_1, A_1A_2, \dots, A_{n-1}A_n$ (by the points A_1, A_2, \dots, A_{n-1}) and an interval $A'_0A'_n$ be divided into n intervals $A'_0A'_1, A'_1A'_2, \dots, A'_{n-1}A'_n$ in such a way that $\forall i \in \mathbb{N}_n A_{i-1}A_i \equiv A'_{i-1}A'_i$. Also, let a point B' lie on the ray $A'_0A'_{i_0}$, where A'_{i_0} is one of the points A'_i , $i \in \mathbb{N}_n$; and, finally, let $AB \equiv A'B'$. Then:

Lemma 1.3.21.12. *– If B lies on the open interval $(A_{k-1}A_k)$, where $k \in \mathbb{N}_n$, then the point B' lies on the open interval $(A'_{k-1}A'_k)$.*

Proof. For $k = 1$ we obtain the result immediately from L 1.3.9.1, so we can assume without loss of generality that $k > 1$. Since A'_{i_0}, B' (by hypothesis) and A'_{i_0}, A'_{k-1}, A'_k (see L 1.2.11.18) lie on one side of A'_0 , so do A'_{k-1}, A'_k, B' . Since also (by L 1.2.7.3 $[A_0A_{k-1}A_k]$, $[A'_0A'_{k-1}A'_k]$, we have $[A_0A_{k-1}A_k] \& [A_{k-1}BA_k] \xrightarrow{L1.2.3.2} [A_0A_{k-1}B] \& [A_0BA_k]$. Taking into account that (by hypothesis) $A_0B \equiv A'_0B'$ and (by L 1.3.21.7) $A_0A_{k-1} \equiv A'_0 \equiv A'_{k-1}$, $A_0A_k \equiv A'_0 \equiv A'_k$, we obtain by L 1.3.9.1 $[A'_0A'_{k-1}B']$, $[A'_0B'A'_k]$, whence by L 1.2.3.1 $[A'_{k-1}B'A'_k]$, as required. \square

Lemma 1.3.21.13. *– If B coincides with the point A_{k_0} , where $k_0 \in \mathbb{N}_n$, then B' coincides with A'_{k_0} .*

Proof. Follows immediately from L 1.3.21.7, A 1.3.1. \square

Corollary 1.3.21.14. *– If B lies on the half-open interval $[A_{k-1}A_k)$, where $k \in \mathbb{N}_n$, then the point B' lies on the half-open interval $[A'_{k-1}A'_k)$.*

³⁴⁹In other words, all intervals A_iA_{i+1} , where $i \in \mathbb{N}_{n-1}$, are congruent

³⁵⁰For instance, it is obvious from L 1.2.7.3, L 1.2.11.15 that P can be any of the points A_1, \dots, A_n .

Proof. Follows immediately from the two preceding lemmas, L 1.3.21.12 and L 1.3.21.13. \square

Theorem 1.3.21. *Given an interval A_1A_{n+1} , divided into n congruent intervals $A_1A_2, A_2A_3, \dots, A_nA_{n+1}$, if the first of these intervals A_1A_2 is further subdivided into m_1 congruent intervals $A_{1,1}A_{1,2}, A_{1,2}A_{1,3}, \dots, A_{1,m_1}A_{1,m_1+1}$, where $\forall i \in \mathbb{N}_{m_1-1} [A_{1,i}A_{1,i+1}A_{1,i+2}]$, and we denote $A_{1,1} \equiv A_1$ and $A_{1,m_1+1} \equiv A_2$; the second interval A_2A_3 is subdivided into m_2 congruent intervals $A_{2,1}A_{2,2}, A_{2,2}A_{2,3}, \dots, A_{2,m_2}A_{2,m_2+1}$, where $\forall i \in \mathbb{N}_{m_2-1} [A_{2,i}A_{2,i+1}A_{2,i+2}]$, and we denote $A_{2,1} \equiv A_2$ and $A_{2,m_2+1} \equiv A_3$; dots; the n^{th} interval A_nA_{n+1} - into m_n congruent intervals $A_{n,1}A_{n,2}, A_{n,2}A_{n,3}, \dots, A_{n,m_n}A_{n,m_n+1}$, where $\forall i \in \mathbb{N}_{m_n-1} [A_{n,i}A_{n,i+1}A_{n,i+2}]$, and we denote $A_{n,1} \equiv A_n$ and $A_{n,m_n+1} \equiv A_{n+1}$. Then the interval A_1A_{n+1} is divided into the $m_1 + m_2 + \dots + m_n$ congruent intervals $A_{1,1}A_{1,2}, A_{1,2}A_{1,3}, \dots, A_{1,m_1}A_{1,m_1+1}, A_{2,1}A_{2,2}, A_{2,2}A_{2,3}, \dots, A_{2,m_2}A_{2,m_2+1}, \dots, A_{n,1}A_{n,2}, A_{n,2}A_{n,3}, \dots, A_{n,m_n}A_{n,m_n+1}$.*

In particular, if an interval is divided into n congruent intervals, each of which is further subdivided into m congruent intervals, the starting interval turns out to be divided into mn congruent intervals.

Proof. Using L 1.2.7.3, we have for any $j \in \mathbb{N}_{n-1}$: $[A_{j,1}A_{j,m_j}A_{j,m_j+1}]$, $[A_{j+1,1}A_{j+1,2}A_{j+1,m_{j+1}+1}]$. Since, by definition, $A_{j,1} = A_j$, $A_{j,m_j+1} = A_{j+1,1} = A_{j+1}$ and $A_{j+1,m_{j+1}+1} = A_{j+2}$, we can write $[A_jA_{j,m_j}A_{j+1}] \& [A_jA_{j+1}A_{j+2}] \xrightarrow{\text{L1.2.3.2}} [A_{j,m_j}A_{j+1}A_{j+2}]$ and $[A_{j,m_j}A_{j+1}A_{j+2}] \& [A_{j+1}A_{j+1,2}A_{j+2}] \xrightarrow{\text{L1.2.3.2}} [A_{j,m_j}A_{j+1}A_{j+2}]$. Since this is proven for all $j \in \mathbb{N}_{n-1}$, we have all the required betweenness relations. The rest is obvious. ³⁵¹ \square

Midpoints

A point M which divides an interval AB into congruent intervals AM , MB is called a midpoint of AB . If M is a midpoint of AB , ³⁵² we write this as $M = \text{mid } AB$.

We are going to show that every interval has a unique midpoint.

Lemma 1.3.22.1. *If $\angle CAB \equiv \angle ABD$, and the points C , D lie on opposite sides of the line a_{AB} , then the open intervals (CD) , (AB) concur in some point E .*

Proof. ³⁵³ $Ca_{ABD} \Rightarrow \exists E (E \in a_{AB}) \& [CED]$ (see Fig. 1.138, a)). We have $E \neq A$, because otherwise $[CAD] \& B \notin a_{AD} \xrightarrow{\text{L1.3.17.4}} \angle CAB > \angle ABD$, ³⁵⁴ which contradicts $\angle CAB \equiv \angle ABD$ in view of C 1.3.16.12. Similarly, $E \neq B$, for otherwise (see Fig. 1.138, b)) $[CBD] \& A \notin a_{BC} \xrightarrow{\text{L1.3.17.4}} \angle BAC < \angle ABD$ - a contradiction. ³⁵⁵ Therefore, $E \in a_{AB} \& E \neq A \& E \neq B \xrightarrow{\text{T1.2.2}} [AEB] \vee [EAB] \vee [ABE]$. But $\neg[EAB]$, because otherwise, using T 1.3.18, L 1.2.11.15, we would have $[EAB] \& C \notin a_{AE} \& [CED] \& B \notin a_{ED} \Rightarrow \angle BAC > \angle AEC = \angle BEC > \angle EBD = \angle ABD$ - a contradiction. Similarly, $\neg[ABE]$, for otherwise (see Fig. 1.138, c)) $[ABE] \& D \notin a_{EB} \& [CED] \& A \notin a_{EC} \Rightarrow \angle ABD > \angle BED = \angle AED > \angle EAC = \angle BAC$. ³⁵⁶ Thus, we see that $[AEB]$, which completes the proof. ³⁵⁷ \square

Making use of A 1.3.4, A 1.3.1, choose points C , D so that $\angle CAB \equiv \angle ABD$ and Then A point E which divides an interval AB into congruent intervals AE , EB is called a midpoint of AB . If E is a midpoint of AB , ³⁵⁸ we write this as $E = \text{mid } AB$.

Theorem 1.3.22. *Every interval AB has a unique midpoint E .*

Proof. Making use of A 1.3.4, A 1.3.1, choose points C , D so that $\angle CAB \equiv \angle ABD$, $AC \equiv BD$, and the points C , D lie on the opposite sides of the line a_{AB} . From the preceding lemma the open intervals (CD) , (AB) meet in some point E . Hence the angles $\angle AEC$, $\angle BED$, being vertical, are congruent (T 1.3.7). Furthermore, using L 1.2.11.15 we see that $\angle CAE = \angle CAB$, $\angle EBD = \angle ABD$. Now we can write $AC \equiv BD \& \angle CAE \equiv \angle EBD \& \angle AEC \equiv \angle BED \xrightarrow{\text{T1.3.19}} \triangle AEC \equiv \triangle BED \Rightarrow AE \equiv EB \& CE \equiv ED$. Thus, we see that E is a midpoint.

To show that the midpoint E is unique, suppose there is another midpoint F . Then $[AEB] \& [AFB] \& E \neq F \xrightarrow{\text{P1.2.3.4}} [AEF] \vee [AFE]$. Assuming $[AFE]$, ³⁵⁹ we have by C 1.3.13.4 $AF < AE$ and $[AFE] \& [AEB] \xrightarrow{\text{L1.2.3.2}} [FEB] \xrightarrow{\text{C1.3.13.4}} EB < FB$, so that $AF < AE \equiv EB < FB \Rightarrow AF < FB \Rightarrow AF \neq FB$ - a contradiction. Thus, E is the only possible midpoint. \square

³⁵¹All congruences we need are already true by hypothesis.

³⁵²And the following theorem T 1.3.22 shows that it is *the* midpoint of AB .

³⁵³The reader is encouraged to draw for himself figures for the cases left unillustrated in this proof.

³⁵⁴Observe that (see C 1.1.2.3, C 1.1.1.3) $C \notin a_{AB} \& D \notin a_{AB} \Rightarrow B \notin a_{AD} \& A \notin a_{BC}$; $C \notin a_{AE} = a_{AB} \Rightarrow A \notin a_{EC}$; $D \notin a_{EB} = a_{AB} \Rightarrow B \notin a_{ED}$.

³⁵⁵Once we have established that $E \neq A$, the inequality $E \neq B$ follows simply from symmetry considerations, because our construction is invariant with respect to the simultaneous substitution $A \leftrightarrow B$, $C \leftrightarrow D$, which maps the angle $\angle CAB$ into the angle $\angle ABD$, and the angle $\angle DBA$ into the angle $\angle BAC$, and so preserves the congruence (by construction) of $\angle CAB$ and $\angle ABD$.

³⁵⁶Again, once we know that $\neg[EAB]$, the fact that $\neg[ABE]$ follows already from the symmetry of our construction under the simultaneous substitution $A \leftrightarrow B$, $C \leftrightarrow D$.

³⁵⁷Obviously, E is the only common point of the open interval (CD) , (AB) , for otherwise the lines a_{CD} , a_{AB} would coincide, thus forcing the points C , D to lie on the line a_{AB} contrary to hypothesis.

³⁵⁸And the following theorem T 1.3.22 shows that it is *the* midpoint of AB .

³⁵⁹Due to symmetry, we do not need to consider the case $[AEF]$.

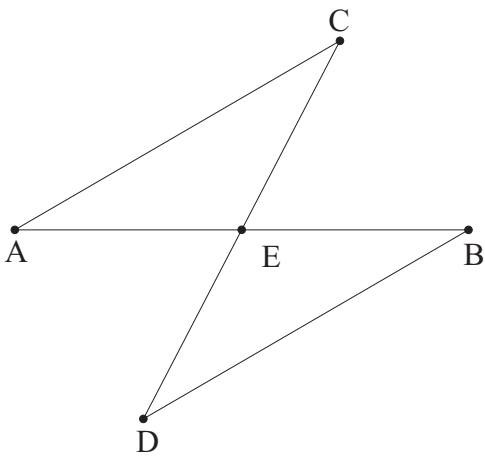

a)

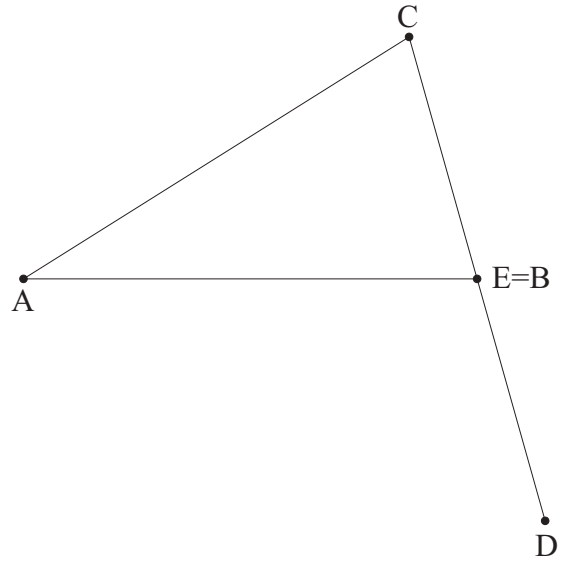

b)

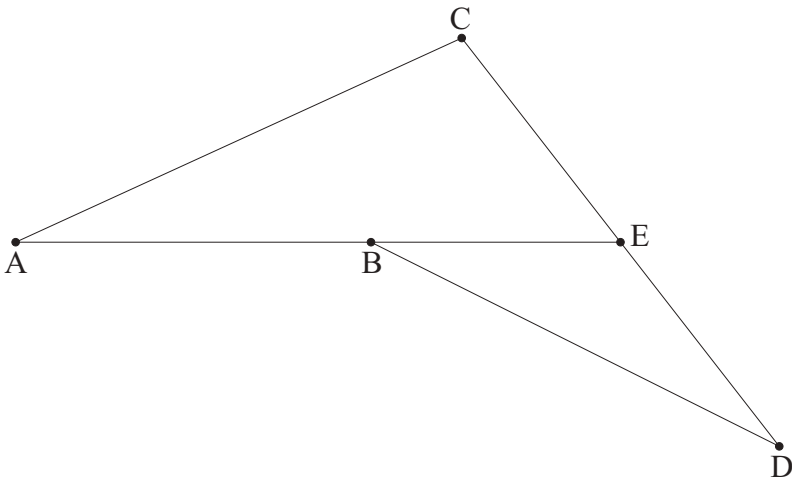

c)

Figure 1.138: Illustration for proof of T 1.3.22.

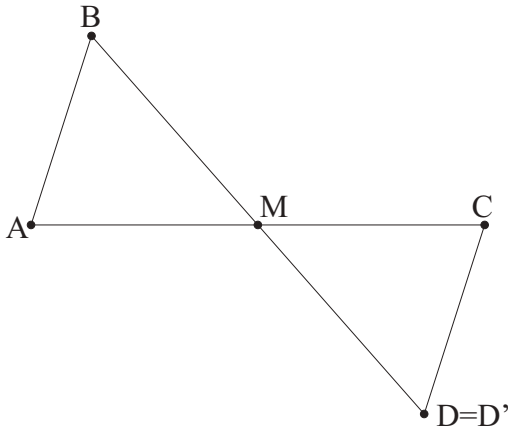

Figure 1.139: If $\angle BAC \equiv \angle ACD$, $AB \equiv CD$, and B, D lie on opposite sides of a_{AC} , then $(BD), (AC)$ concur in M which is the midpoint for both AC and BD .

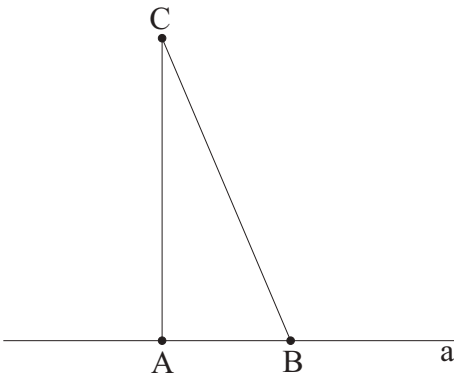

Figure 1.140: Given a line a , through any point C not on it at most one perpendicular to a can be drawn.

Corollary 1.3.23.1. *Every interval AB can be uniquely divided into 2^n congruent intervals, where n is any positive integer.*

Proof. By induction on n . The case of $n = 1$ is exactly T 1.3.22. If AB is divided into 2^{n-1} congruent intervals, dividing (by T 1.3.22) each of these intervals into two congruent intervals, we obtain by T 1.3.21 that AB is now divided into 2^n congruent intervals, q.e.d. \square

Corollary 1.3.23.2. *If a point E lies on a line a_{AB} and $AE \equiv EB$, then E is a midpoint of AB , i.e. also $[AEB]$.*

Proof. $E \in a_{AB} \& A \neq E \neq B \xrightarrow{T1.2,2} [ABE] \vee [EAB] \vee [AEB]$. But by C 1.3.13.4 $[ABE]$ would imply $BE < AE$, which by L 1.3.13.11 contradicts $AE \equiv EB$. Similarly, $[EAB] \xrightarrow{C1.3,13.4} AE < EB$ - again a contradiction. This leaves $[AEB]$ as the only option. ³⁶⁰ \square

Corollary 1.3.23.3. *Congruence of (conventional) intervals has the property P 1.3.5. ³⁶¹*

Corollary 1.3.23.4. *If $\angle BAC \equiv \angle ACD$, $AB \equiv CD$, and the points B, D lie on opposite sides of the line a_{AC} , then the open interval $(BD), (AC)$ concur in the point M which is the midpoint for both AC and BD .*

Proof. \square

Lemma 1.3.24.1. *Given a line a , through any point C not on it at most one perpendicular to a can be drawn. ³⁶²*

Proof. Suppose the contrary, i.e. that there are two perpendiculars to a drawn through C with feet A, B . (See Fig. 1.140.) Then we have $a_{CA} \perp a_{AB} = a$, $a_{CB} \perp a_{AB} = a$. This means that $\angle CAB$, $\text{adjsp } \angle CBA$, both being right angles, are congruent by T 1.3.16. On the other hand, since $\text{adjsp } \angle CBA$ is an exterior angle of $\triangle ACB$, by T 1.3.17 we have $\angle CAB < \text{adjsp } \angle CBA$. Thus, we arrive at a contradiction with L 1.3.16.11.

³⁶⁰ Again, due to symmetry with respect to the substitution $A \leftrightarrow B$, we do not really need to consider the case $[EAB]$ once the case $[ABE]$ has been considered and discarded.

³⁶¹ Thus, we have completed the proof that congruence of conventional intervals is a relation of generalized congruence.

³⁶² Combined with the present lemma, L 1.3.8.1 allows us to assert that given a line a_{OA} , through any point C not on it exactly one perpendicular to a_{OA} can be drawn. Observe also that if $a_{CA} \perp a$, $a_{CA'} \perp a$, where both $A \in a$, $A' \in a$, then $A' = A$.

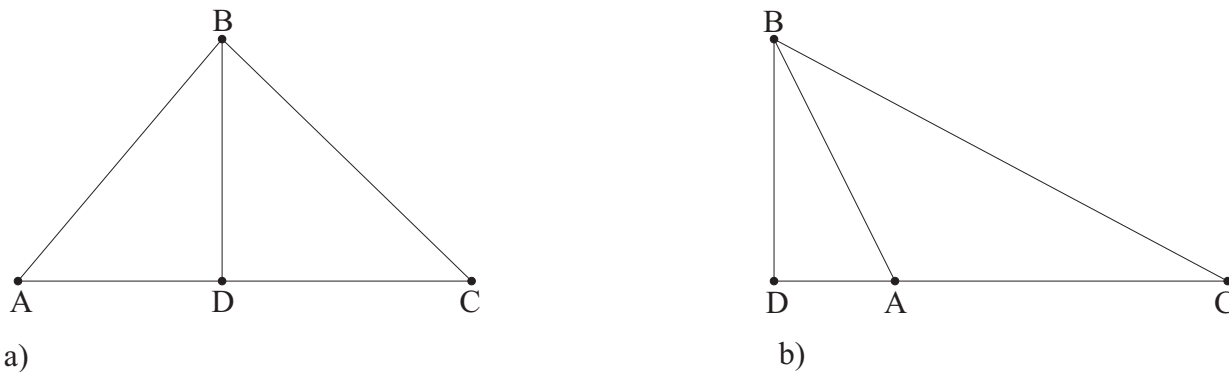

Figure 1.141: Illustration for proof of P 1.3.24.2.

Triangle Medians, Bisectors, and Altitudes

A vertex of a triangle is called opposite to its side (in which case the side, in turn, is called opposite to a vertex) if this side (viewed as an interval) does not have that vertex as one of its ends.

An interval joining a vertex of a triangle with a point on the line containing the opposite side is called a cevian. A cevian BD in a triangle $\triangle ABC$, $(AC) \ni D$, is called

- a median if $AD \equiv DC$;
- a bisector if $\angle ABD \equiv \angle CBD$;
- an altitude if $a_{BD} \perp a_{AC}$.

Proposition 1.3.24.2. *Consider an altitude BD of a triangle $\triangle ABC$. The foot D of the altitude BD lies between the points A, C iff both the angles $\angle BAC, \angle BCA$ are acute. In this situation we shall refer to BD as an interior, or proper, altitude of $\triangle ABC$. The foot D of the altitude BD coincides with the point A iff the angle $\angle BAC$ is right and the angle $\angle BCA$ is acute. In this situation we shall refer to BD as the side altitude of $\triangle ABC$. The points A, C, D are in the order $[DAC]$ iff both the angle $\angle BAC$ is obtuse and the angle $\angle BCA$ is acute. In this situation we shall refer to BD as the exterior altitude of $\triangle ABC$.³⁶³*

Proof. Suppose $[ADC]$ (see Fig. 1.141, a)). Then $\angle BAC = \angle BAD < \angle BDC$ (see L 1.2.11.15, T 1.3.17). $\angle BDC$ being a right angle, $\angle BAC$ is bound to be acute (C ??). Similarly, $\angle BCA$ is acute.

Suppose $A = D$. Then, obviously, $\angle BAC = \angle BDC$ is a right angle.

Suppose $[DAC]$ (see Fig. 1.141, b)). Then $\angle BDC = \angle BDA < \angle BAC$ (see L 1.2.11.15, T 1.3.17). Since $\angle BDC$ is a right angle, $\angle BAC$ has to be obtuse (C ??).

Observe now that, in view of T 1.2.2, for points A, C, D on one line, of which A, C are known to be distinct, we have either $[DAC]$, or $D = A$, or $[ADC]$, or $D = C$, or $[ACD]$. Suppose first that the angles $\angle BAC, \angle BCA$ are both acute. The first part of this proof then shows that this can happen only if the point D lies between A, C , for in the other four cases one of the angles $\angle BAC, \angle BCA$ would be either right or obtuse. Similarly, we see that $D = A$ only if $\angle BAC$ is right, and $[DAC]$ only if $\angle BAC$ is obtuse, which completes the proof. \square

Proposition 1.3.24.3. *If a median BD in a triangle $\triangle ABC$ is also an altitude, then BD is also a bisector, and $\triangle ABC$ is an isosceles triangle.³⁶⁴*

Proof. Since BD is a median, we have $AD \equiv CD$. Since it is also an altitude, the angles $\angle ABD, \angle CBD$, both being right angles, are also congruent. Hence $AD \equiv CD \& \angle ABD \equiv \angle CBD \& BD \equiv BD \xrightarrow{T1.3.4} \triangle ABD \equiv \triangle CBD \Rightarrow AB \equiv CB \& \angle ABD \equiv \angle CBD$. \square

Proposition 1.3.24.4. *If a bisector BD in a triangle $\triangle ABC$ is also an altitude, then BD is also a median, and $\triangle ABC$ is an isosceles triangle.*

Proof. The interval BD being a bisector implies $\angle ABD \equiv \angle CBD$. Since it is also an altitude, we have $\angle ABD \equiv \angle CBD$. Hence $\angle ABD \equiv \angle CBD \& BD \equiv BD \& \angle ABD \equiv \angle CBD \xrightarrow{T1.3.5} \triangle ABD \equiv \triangle CBD \Rightarrow AB \equiv CB \& AD \equiv CD$. \square

Proposition 1.3.24.5. *If a median BD in a triangle $\triangle ABC$ is also a bisector, then BD is also an altitude, and $\triangle ABC$ is an isosceles triangle.*

³⁶³One could add here the following two statements: The foot D of the altitude BD coincides with the point C iff the angle $\angle BCA$ is right and the angle $\angle BAC$ is acute. (In this situation we also refer to BD as the side altitude of $\triangle ABC$.) The points A, C, D are in the order $[ACD]$ iff both the angle $\angle BCA$ is obtuse and the angle $\angle BAC$ is acute. (In this situation we again refer to BD as the exterior altitude of $\triangle ABC$.) It is obvious, however, that due to symmetry these assertions add nothing essentially new. Observe also that any triangle can have at most one either exterior or side altitude and, of course, at least two interior altitudes. The exterior and side altitudes can also be sometimes referred to as improper altitudes.

³⁶⁴Note also an intermediate result of this proof that then the triangle $\triangle ABD$ is congruent to the triangle $\triangle CBD$

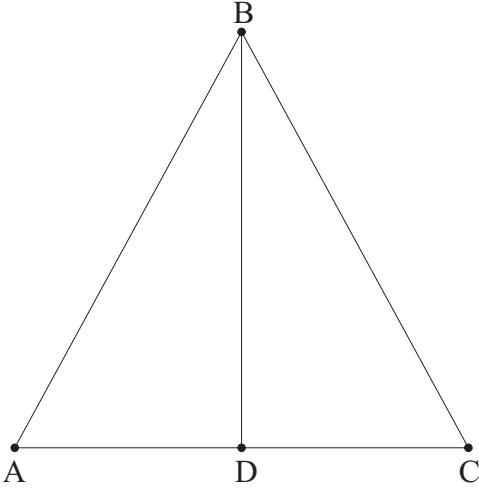

Figure 1.142: Given a cevian BD in $\triangle ABC$ with $AB \equiv CB$, if BD is a median, it is also a bisector and an altitude; if BD is a bisector, it is also a median and an altitude; if BD is an altitude, it is also a median and a bisector.

Proof. We have $\angle A \equiv \angle C$. In fact, the inequality $\angle A < \angle C$ would by C 1.3.18.3 imply $CD < AD$, which, in view of L 1.3.13.11, contradicts $AD \equiv DC$ (required by the fact that BD is a median). Similarly, $\angle C < \angle A$ would by C 1.3.18.3 imply $CD < AD$, which again contradicts $AD \equiv DC$.³⁶⁵ Thus, we have $\angle A \equiv \angle C$ as the remaining option. Hence the result by T 1.3.12, T 1.3.24. \square

Theorem 1.3.24. *Given a cevian BD , where $(AC) \ni D$, in an isosceles triangle $\triangle ABC$ with $AB \equiv CB$, we have:*

1. *If BD is a median, it is also a bisector and an altitude;*
2. *If BD is a bisector, it is also a median and an altitude;*
3. *If BD is an altitude, it is also a median and a bisector.*

Proof. (See Fig. 1.142.) 1. $AB \equiv CB \& DB \equiv DB \& AD \equiv DC \xrightarrow{T1.3.10} \triangle ABD \equiv \triangle CBD \Rightarrow \angle ABD \equiv \angle CBD \& \angle ADB \equiv \angle CDB$. Thus, BD is a bisector and an altitude (the latter because the relation $[ADC]$ implies that $\angle ADB, \angle CDB$ are adjacent complementary angles, and we have shown that $\angle ADB \equiv \angle CDB$).

2. $AB \equiv CB \& DB \equiv DB \& \angle ABD \equiv \angle CBD \xrightarrow{T1.3.4} \triangle ABD \equiv \triangle CBD \Rightarrow AD \equiv DC$, so BD is a median.

3. By T 1.3.3 $\angle BAC \equiv \angle BCA$. Also, $[ADC] \xrightarrow{L1.2.11.15} \angle BAC = \angle BAD \& \angle BCA \equiv \angle BCD$. Finally, $AB \equiv CB \& \angle BAD \equiv \angle BCD \& \angle ADB \equiv \angle CDB \xrightarrow{T1.3.19} \triangle ABD \equiv \triangle CBD$, whence the result.³⁶⁶ \square

Given a ray l lying (completely) inside an extended angle $\angle(h, k)$ ³⁶⁷ and having its initial point in the vertex of $\angle(h, k)$, if the angles $\angle(h, l), \angle(l, k)$ are congruent, the ray l is called a bisector of the extended angle $\angle(h, k)$. If a ray l is the bisector of an extended angle $\angle(h, k)$, we shall sometimes say that either of the angles $\angle(h, l), \angle(l, k)$ is half the extended angle $\angle(h, k)$.³⁶⁸

Theorem 1.3.25. *Every extended angle $\angle(h, k)$ has a unique bisector l .*

Proof. Obviously, for $h = h^c$ we have $l \perp \bar{h}$ (see L 1.3.8.3).³⁶⁹ (See Fig. 1.143.) Suppose now $h \neq h^c$. Using A 1.3.1, choose points $A \in k, C \in h$ such that $AB \equiv BC$. If D is the midpoint of AC (see T 1.3.22), by the previous theorem (T 1.3.24) and L 1.2.21.1 we have $\angle(k, l) = \angle ABD \equiv \angle CBD = \angle(l, h)$. To show uniqueness, suppose $\angle(h, k)$ has a bisector l' . By this bisector meets (AC) in a point D' , and thus BD' is a bisector in $\triangle ABC$. Hence by the previous theorem (T 1.3.24) D' is a midpoint of AC and is unique by T 1.3.22, which implies $D' = D$ and $l' = B_{D'} = B_D = l$. \square

Corollary 1.3.25.1. *For a given vertex, say, B , of a triangle $\triangle ABC$, there is only one median, joining this vertex with a point D on the opposite side AC . Similarly, there is only one bisector per every vertex of a given triangle.*

Proof. In fact, by T 1.3.22, the interval AC has a unique midpoint D , so there can be only one median for the given vertex B . The bisector l of the angle $\angle ABC$ exists and is unique by T 1.3.25. By L 1.2.21.4, L 1.2.21.6 $A \in B_A \& C \in B_C \& l \subset \text{Int}\angle ABC \Rightarrow \exists E \ E \in l \& [AEC]$, i.e. the ray l is bound to meet the open interval (AC) at some point E . Then BE is the required bisector. It is unique because the ray $l = B_E$ is unique, and the line a_{BE}

³⁶⁵Once we have shown that $\neg(\angle A < \angle C)$, the inequality $\neg(\angle C < \angle A)$ follows immediately from symmetry considerations expressed explicitly in the substitutions $A \rightarrow C, C \rightarrow A$.

³⁶⁶Note that this part of the proof can be made easier using L 1.3.24.1.

³⁶⁷That is $\angle(h, k)$ is either an angle (in the conventional sense of a pair of non-collinear rays) or a straight angle $\angle(h, h^c)$.

³⁶⁸More broadly, using the properties of congruence of angles, we can speak of any angle congruent to the angles $\angle(h, l), \angle(l, k)$, as half of the extended angle congruent to the $\angle(h, k)$.

³⁶⁹Thus, in the case of a straight angle $\angle(h, h^c)$ the role of the bisector is played by the perpendicular l to \bar{h} . The foot of the perpendicular is, of course, the common origin of the rays h and h^c .

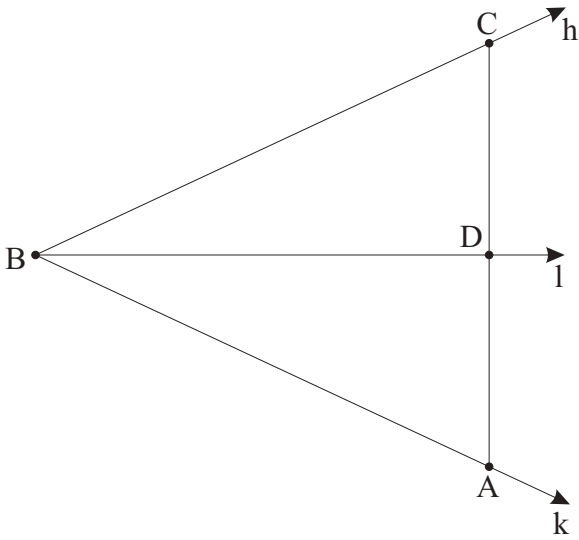

Figure 1.143: Every angle $\angle(h, k)$ has a unique bisector l .

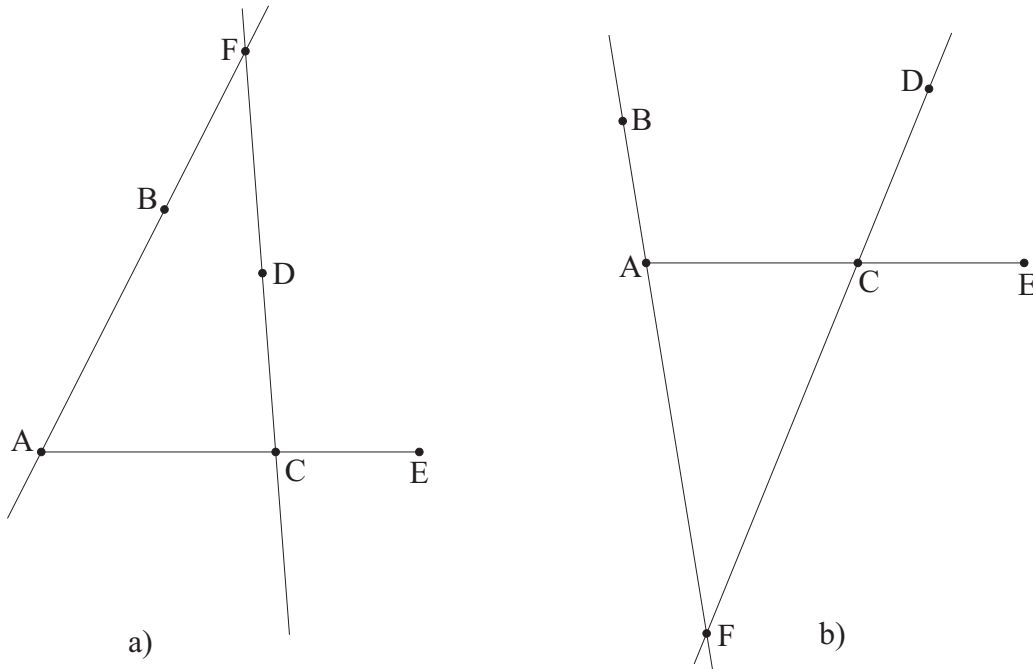

Figure 1.144: Illustration for proof of T 1.3.26.

containing it, by L 1.2.1.5 (we take into account that $A \notin a_{BE}$) cannot meet the line a_{AC} , and, consequently, the open interval (AC) (see L 1.2.1.3), in more than one point. \square

Corollary 1.3.25.2. *Congruence of (conventional) angles has the property P 1.3.5.* ³⁷⁰

Congruence and Parallelism

Theorem 1.3.26. *If points B, D lie on the same side of a line a_{AC} , the point C lies between A and a point E , and the angle $\angle BAC$ is congruent to the angle $\angle DCE$, then the lines a_{AB}, a_{CD} are parallel.*

Proof. Suppose the contrary, i.e. $\exists F \in a_{AB} \cap a_{CD}$. We have, by hypothesis, $B D a_{AC} \stackrel{T1.2,19}{\implies} A_B C_D a_{AC}$. Therefore, $F \in a_{AB} \cap a_{CD} \& A_B C_D a_{AC} \implies F \in A_B \cap C_D \vee F \in (A_B)^c \cap (C_D)^c$. In the first of these cases (see Fig. 1.144, a)) we would have by L 1.2.11.3, T 1.3.17 $F \in A_B \cap C_D \implies \angle BAC = \angle EAC \& \angle FCE = \angle DCE \& \angle FAC < \angle FCE \implies \angle BAC < \angle FCE$ which contradicts $\angle BAC \equiv \angle DCE$ in view of L 1.3.16.11. Similarly, for the second case (see Fig. 1.144, b)), using also L 1.3.16.15), we would have $F \in (A_B)^c \cap (C_D)^c \implies \angle FAC = \text{adjsp } \angle BAE \& \angle FCE = \text{adjsp } \angle DCE \& \angle FAC < \angle FCE \implies \text{adjsp } \angle BAE < \text{adjsp } \angle DCE \implies \angle DCE < \angle BAE$ - again a contradiction. \square

³⁷⁰ Thus, we have completed the proof that congruence of conventional angles is a relation of generalized congruence.

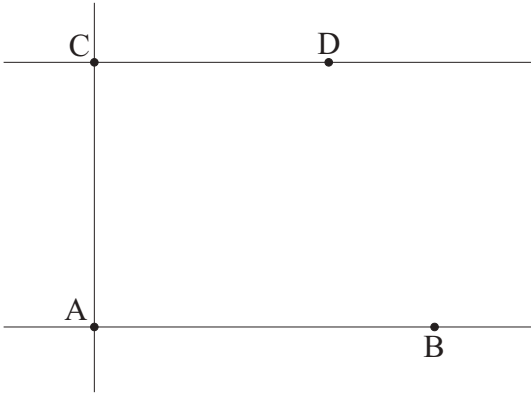

Figure 1.145: If A, B, C, D coplane and a_{AB}, a_{CD} are both perpendicular to a_{AC} , the lines a_{AB}, a_{CD} are parallel.

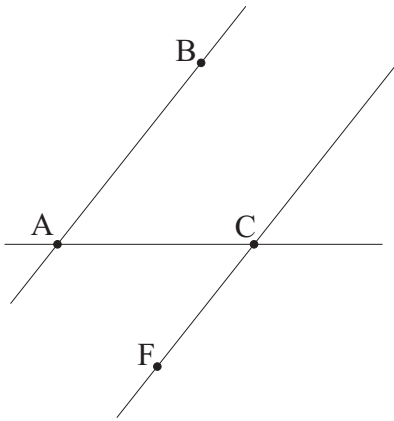

Figure 1.146: If B, F lie on opposite sides of a_{AC} and $\angle BAC, \angle ACF$ are congruent, then a_{AB}, a_{CF} are parallel.

Corollary 1.3.26.1. *If points B, D lie on the same side of a line a_{AC} and the angles $\angle BAC, \angle DCA$ are supplementary then $a_{AB} \parallel a_{CD}$.*

Proof. Since $\angle BAC = \text{suppl} \angle DCA$, we have $\angle BAC \equiv \text{adjsp} \angle DCE$, where $C_E = (C_A)^c$.³⁷¹ Hence the result of the present corollary by the preceding theorem (T 1.3.26). \square

Corollary 1.3.26.2. *If points A, B, C, D coplane and the lines a_{AB}, a_{CD} are both perpendicular to the line a_{AC} , the lines a_{AB}, a_{CD} are parallel. In other words, if two (distinct) lines b, c coplane and are both perpendicular to a line a , they are parallel to each other.*

Proof. (See Fig. 1.145.) By hypothesis, the lines a_{AB}, a_{CD} both form right angles with the line a_{AC} . But by T 1.3.16 all right angles are congruent. Therefore, we can consider the angles formed by a_{AB}, a_{CD} with a_{AC} as supplementary,³⁷² whence by the preceding corollary (C 1.3.26.1) we get the required result. \square

Corollary 1.3.26.3. *If points B, F lie on opposite sides of a line a_{AC} and the angles $\angle BAC, \angle ACF$ are congruent, then the lines a_{AB}, a_{CF} are parallel.*

Proof. (See Fig. 1.146.) Since, by hypothesis, B, F lie on opposite sides of a line a_{AC} , we have $B(C_F)^c a_{AC}$ (see L 1.2.19.8, L 1.2.18.4). Also, the angle formed by the rays $A_C, (C_F)^c$, is supplementary to $\angle BAC$. Hence the result by C 1.3.26.1. \square

Corollary 1.3.26.4. *Given a point A not on a line a in a plane α , at least one parallel to a goes through A .*

Corollary 1.3.26.5. *Suppose that $A, B, C \in a, A', B', C' \in b$, and $\angle A'AB \equiv \angle B'BC \equiv \text{adjsp} \angle C'CB$.³⁷³ If B lies between A, C then B' lies between A', C' .*

³⁷¹Obviously, using A 1.2.2, we can choose the point E so that $[ACE]$. Then, of course, $C_E = (C_A)^c$.

³⁷²See discussion accompanying the definition of orthogonality on p. 117.

³⁷³We can put the assumption $\angle B'BC \equiv \text{adjsp} \angle C'CB$ into a slightly more symmetric form by writing it as $\angle B'BC \equiv \angle C'CD$, where D is an arbitrary point such that $[BCD]$. Obviously, the two assumptions are equivalent.

Proof. According to T 1.3.26, C 1.3.26.3 we have $a_{AA'} \parallel a_{BB'}, a_{BB'} \parallel a_{CC'}$.³⁷⁴ Seeing that $a_{BB'}$ lies inside the strip $a_{AA'}a_{CC'}$, we conclude (using T 1.2.2) that $[A'B'C']$,³⁷⁵ as required. \square

Corollary 1.3.26.6. *Suppose that $A, B, C \in a$, $[ABC]$, $A', B', C' \in b$, where A, B, C , are respectively the feet of the perpendiculars to a drawn through A', B', C' .³⁷⁶ Then $[A'B'C']$.*

Proof. Follows immediately from the preceding corollary because all right angles are congruent (T 1.3.16). \square

Corollary 1.3.26.7. *Suppose that $A, B, C \in a$, $A', B', C' \in b$, and $[A'B'C']$, where A, B, C , are respectively the feet of the perpendiculars to a drawn through A', B', C' . Suppose further that the lines a, b are not perpendicular.³⁷⁷ Then $[ABC]$.*

Proof. Follows immediately from the preceding corollary because all right angles are congruent (T 1.3.16). \square

Corollary 1.3.26.8. *Suppose that $A_1, A_2, A_3, \dots, A_n(\dots) \in a$, $B_1, B_2, B_3, \dots, B_n(\dots) \in b$, and $\angle B_1A_1A_2 \equiv \angle B_2A_2A_3 \equiv \dots \equiv \angle B_{n-1}A_{n-1}A_n \equiv \angle B_nA_nA_{n+1}$. Suppose further that the points $A_1, A_2, \dots, A_n(\dots)$ have the following property: Every point A_i , where $i = 2, 3, \dots, n(\dots)$ lies between the two points (namely, A_{i-1}, A_{i+1}) with adjacent (in \mathbb{N}) numbers. Then the points $A_1, A_2, \dots, A_n(\dots)$ are in order $[B_1B_2 \dots B_n(\dots)]$.*

Proof. \square

Corollary 1.3.26.9. *Suppose that $A_1, A_2, A_3, \dots, A_n(\dots) \in a$, $B_1, B_2, B_3, \dots, B_n(\dots) \in b$, where $A_i, i = 1, 2, \dots, n(\dots)$ are the feet of the perpendiculars to a drawn through the corresponding points B_i . Suppose further that the points $A_1, A_2, \dots, A_n(\dots)$ have the following property: Every point A_i , where $i = 2, 3, \dots, n(\dots)$ lies between the two points (namely, A_{i-1}, A_{i+1}) with adjacent (in \mathbb{N}) numbers. Then the points $B_1, B_2, \dots, B_n(\dots)$ are in order $[B_1B_2 \dots B_n(\dots)]$.*

Proof. \square

Corollary 1.3.26.10. *Suppose that $A_1, A_2, A_3, \dots, A_n(\dots) \in a$, $B_1, B_2, B_3, \dots, B_n(\dots) \in b$, where $A_i, i = 1, 2, \dots, n(\dots)$ are the feet of the perpendiculars to a drawn through the corresponding points B_i . We assume that the lines a, b are not perpendicular (to each other). Suppose further that the points $B_1, B_2, \dots, B_n(\dots)$ have the following property: Every point B_i , where $i = 2, 3, \dots, n(\dots)$ lies between the two points (namely, B_{i-1}, B_{i+1}) with adjacent (in \mathbb{N}) numbers. Then the points $A_1, A_2, \dots, A_n(\dots)$ are in order $[A_1A_2 \dots A_n(\dots)]$.*

Proof. \square

Proposition 1.3.26.11. *Suppose we are given lines a, a' , points $B \notin a, B' \notin a'$, an angle $\angle(h, k)$, and points C, C' such that $AB \equiv A'B', BC \equiv B'C', \angle ABC \equiv \angle A'B'C'$, where $A \equiv \text{proj}(B, a, \angle(h, k))$, $A' \equiv \text{proj}(B', a', \angle(h, k))$. In addition, in the case $a' \neq a$ then we impose the following requirement on the orders used to define the projection on a, a' under $\angle(h, k)$ (see p. 117): if $A \prec D$ on a then $A' \prec D'$ on a' , and if $D \prec A$ on a then $A' \prec D'$ on a' . Then $AD \equiv A'D'$, where $D \equiv \text{proj}(C, a, \angle(h, k))$ if BCa_{AD} , $D' \equiv \text{proj}(C', a', \angle(h, k))$ if $B'C'a_{AD}$, $D \equiv \text{proj}(C, a, \text{suppl}\angle(h, k))$ if $Ba_{AD}C$, $D' \equiv \text{proj}(C', a', \text{suppl}\angle(h, k))$ if $B'a_{AD}C'$. Furthermore, if $C \notin a$ ³⁷⁸ then $CD \equiv C'D'$ and $\angle BCD \equiv \angle B'C'D'$.³⁷⁹*

Proof. First, observe that the points C, D always lie on the same side of the line a_{AB} and C', D' lie on the same side of $a_{A'B'}$. In fact, this is vacuously true if $D = C$ ($D' = C'$), and in the case $D \neq C$ ($D' \neq C'$) this follows from T 1.3.26, C 1.3.26.3.³⁸⁰ Furthermore, we have $AB \equiv A'B' \& BC \equiv B'C' \& \angle ABC \& \angle A'B'C' \xrightarrow{T1.3.4} \triangle ABC \equiv \triangle A'B'C' \Rightarrow AC \equiv A'C' \& \angle BAC \equiv \angle B'A'C'$. Note also that we can assume without loss of generality that $A \prec D$. Then, by hypothesis, $A' \prec D'$. This, in turn, means that the angles $\angle BAD, \angle B'A'D'$, both being congruent to the angle $\angle(h, k)$, are congruent to each other. Suppose that $C \in a$.³⁸¹ We are going to show that in this case also

³⁷⁴Note that the lines $a_{AA'}, a_{BB'}$ and $a_{BB'}, a_{CC'}$ are parallel no matter whether the points A', B', C' all lie on one side of a or one of them (evidently, this can only be either A or C but not B) lies on the side of a opposite to the one containing the other two points.

³⁷⁵We have $a_{AA'} \parallel a_{BB'} \Rightarrow B' \neq A', a_{BB'} \parallel a_{CC'} \Rightarrow B' \neq C'$. Then from T 1.2.2 we have either $[B'A'C']$, or $[A'C'B']$, or $[A'B'C']$. But $[B'A'C']$ would imply that the point B', C' lie on opposite sides of the line $a_{AA'}$. This, however, contradicts the fact that the line $a_{BB'}$ lies inside the strip $a_{AA'}a_{CC'}$. (Which, according to the definition of interior of a strip, means that the lines $a_{BB'}, a_{CC'}$ lie on the same side of the line $a_{AA'}$.) This contradiction shows that we have $\neg[B'A'C']$. Similarly, we can show that $\neg[A'C'B']$.

³⁷⁶Here we assume, of course, that $A' \neq A, B' \neq B, C' \neq C$.

³⁷⁷Again, we assume that $A' \neq A, B' \neq B, C' \neq C$.

³⁷⁸And then, as we shall see in the beginning of the proof, $C' \notin a'$

³⁷⁹In the important case of orthogonal projections this result can be formulated as follows: Suppose we are given a line a , points B, B' not on it, and points C, C' such that $AB \equiv A'B', BC \equiv B'C', \angle ABC \equiv \angle A'B'C'$, where $A \equiv \text{proj}(B, a)$, $A' \equiv \text{proj}(B', a')$. Then $AD \equiv A'D'$, where $D \equiv \text{proj}(C, a)$, $D' \equiv \text{proj}(C', a')$. Furthermore, if $C \notin a$ then $CD \equiv C'D'$ and $\angle BCD \equiv \angle B'C'D'$.

³⁸⁰Note the following properties: If the points B, C lie on the same side of a and $F \in a$ is such a point that $D \prec F$ on a , i.e. such that $[ADF]$, then $\angle BAD \equiv \angle CDF$, since both these angles are congruent to the $\angle(h, k)$ by hypothesis and by definition of projection under $\angle(h, k)$. Similarly, if B', C' lie on the same side of a' and $F' \in a'$ is such a point that $D' \prec F'$ on a' , i.e. such that $[A'D'F']$, then $\angle B'A'D' \equiv \angle C'D'F'$. On the other hand, it is easy to see that if B, C lie on the opposite sides of a then $\angle BAD \equiv \angle ADC$. (In fact, by hypothesis and by definition of projection under $\text{suppl}\angle(h, k)$ we then have $\angle CDF \equiv \text{suppl}\angle(h, k)$, where $F \in a$ is any point such that $D \prec F$ on a , i.e. such that $[ADF]$. Evidently, $\angle CDF = \text{adjsp}\angle ADC$, whence in view of T 1.3.6 we find that $\angle ADC \equiv \angle(h, k)$.) Similarly, B', C' lie on the opposite sides of a' then $\angle B'A'D' \equiv \angle A'D'C'$.

³⁸¹Which means, by definition, that $D = C$.

$C' \in a'$ and thus $D' = C'$. In fact, since the angle $\angle ABC = \angle ACD$ is congruent both to $\angle A'B'C'$ and $\angle A'B'D'$, and, as shown above, the points C', D' lie on the same side of the line $a_{A'B'}$, using A 1.3.4 we see that the points C', D' lie on the line a' on the same side of the point A' . But from the definition of projection it is evident that C' can lie on a' only if $D' = C'$.

Turning to the case $C \neq D$, we observe that either both B, C lie on the same side of a_{AD} and B', C' lie on the same side of $a_{A'D'}$, or B, C lie on the opposite sides of a_{AD} and B', C' lie on the opposite sides of $a_{A'D'}$. To show this in a clumsy yet logically sound manner suppose the contrary, i.e. that, say, ³⁸² B, C lie on the same side of a_{AD} and B', C' lie on the opposite sides of $a_{A'D'}$. Then $B'a'C' \& \angle B'A'D' \equiv \angle A'D'C' \xrightarrow{L1.3.22.1} \exists E'(E' \in (A'D') \cap (B'C'))$. Taking $E \in A_D$ such that $A'E' \equiv AE$ (see A 1.3.1), we find that $E \in A_D \& E' \in (A'D') \Rightarrow \angle BAD = \angle BAE \& \angle B'A'D' \equiv \angle B'A'E'$ (see L 1.2.11.3, L 1.2.11.15), whence $\angle BAE \equiv \angle B'A'E'$. Now we can write $A'B' \equiv AB \& A'E' \equiv AE \& \angle B'A'E' \equiv \angle BAE \xrightarrow{T1.3.4} \Delta A'B'E' \equiv \Delta ABE \Rightarrow \angle A'B'E' \equiv \angle ABE$. Since also $E' \in (B'C') \Rightarrow B'C' = B'E' \Rightarrow \angle A'B'C' = \angle A'B'E'$ (see L 1.2.11.15), $\angle A'B'C' \equiv \angle ABC$ (by hypothesis), and ECa_{AB} , ³⁸³ using A 1.3.4 we find that $E \in B_C$. $B'C' \equiv BC \& BE \equiv BE \& [B'E'C'] \& E \in B_C \xrightarrow{L1.3.22.1} [BEC]$, which implies that the points B, C lie on the opposite sides of the line a contrary to assumption.

Consider the case BCa . Then, as shown above, we have $B'C'a'$. Since the quadrilaterals $ABCD, A'B'C'D'$ are simple in this case (see L 1.2.62.5), in view of P 1.3.19.2 we have $ABCD \equiv A'B'C'D'$ whence, in particular, $AD \equiv A'D', CD \equiv C'D', \angle BCD \equiv \angle B'C'D'$.

Suppose now that BaC . Then, as we have seen, also $B'a'C'$. Furthermore, as shown above, $\exists E(E \in (AD) \cap (BC))$ and $\exists E'(E' \in (A'D') \cap (B'C'))$. In view of L 1.2.11.15 we have $\angle BAE = \angle BAD, \angle ABE = \angle ABC, \angle CDA = \angle CDE, \angle BCD = \angle ECD, \angle B'A'E' = \angle B'A'D', \angle A'B'E' = \angle A'B'C', \angle BCD \equiv \angle ECD$. Since, by hypothesis, $\angle ABC \equiv \angle A'B'C', \angle BAD \equiv \angle B'A'D', \angle C'D'A' = \angle C'D'E'$ and $AB \equiv A'B'$, in view of T 1.3.5 we have $\Delta ABE \equiv \Delta A'B'E'$, whence $AE \equiv A'E', BE \equiv B'E'$, and $\angle AEB \equiv \angle A'E'B'$. From L 1.3.9.1 we have $CE \equiv C'E'$, and using T 1.3.7 we find that $\angle CED \equiv \angle C'E'D'$. Hence $CE \equiv C'E' \& \angle CED \equiv \angle C'E'D' \& \angle CDE \equiv \angle C'D'E' \xrightarrow{T1.3.19} \Delta CED \equiv \Delta C'E'D'$, whence $CD \equiv C'D', DE \equiv D'E', \angle BCD \equiv \angle B'C'D'$. ³⁸⁴ Finally, we can write $AE \equiv A'E' \& DE \equiv D'E' \& [AED] \& [A'E'D'] \xrightarrow{A1.3.3} AD \equiv A'D'$. \square

Corollary 1.3.26.12. *Consider an acute angle $\angle(h, k)$. Let $A_1, A_2 \in k$ and let B_1, B_2 be the feet of the perpendiculars to \bar{h} drawn through A_1, A_2 , respectively. Then $[OA_1A_2]$ if and only if $[OB_1B_2]$, where O is the vertex of the angle $\angle(h, k)$.*

Proof. Since (by hypothesis) both $a_{A_1B_1} \perp \bar{h}, a_{A_2B_2} \perp \bar{h}$, we have $a_{A_1B_1} \parallel a_{A_2B_2}$ (see C ??). Then the required result follows from T 1.2.46. \square

Corollary 1.3.26.13. *Consider an acute angle $\angle(h, k)$. Let $A_1, A_2, \dots, A_n \in k, n \in \mathbb{N}, n \geq 2$ and let B_1, B_2, \dots, B_n be the feet of the perpendiculars to \bar{h} drawn through A_1, A_2, \dots, A_n , respectively. Then $[OA_1A_2 \dots A_n]$ if and only if $[OB_1B_2 \dots B_n]$, where O is the vertex of the angle $\angle(h, k)$.*

Proof. Follows from the preceding corollary (C 1.3.26.13) and C 1.3.26.9, C 1.3.26.10. \square

Lemma 1.3.26.14. *The altitude drawn from the vertex B of the right angle $\angle B = \angle ABC$ of a right triangle $\triangle ABC$ to the (line containing the) opposite side AC is an interior altitude. Furthermore, the feet of the perpendiculars drawn from points of the sides $(AB), (BC)$ to the line a_{AB} also lie between A and C .*

Proof. Since, by hypothesis, $\angle ABC$ is a right angle, the angles $\angle BAC, \angle BCA$ are acute. Therefore, $D \in A_C \cap C_A = (AC)$ (see C 1.3.18.11, L 1.2.15.1). Now suppose $E \in (AB), F \in a_{AC}$, and $a_{EF} \perp a_{AC}$. From C 1.3.26.12 we have $[AFD]$, and we can write $[AFD] \& [ADC] \xrightarrow{L1.2.3.2} [AFC]$. \square

Lemma 1.3.26.15. *Given an acute or right angle $\angle(h, k)$ and a point C inside it, the foot B of the perpendicular lowered from C to \bar{h} lies on h . Similarly, by symmetry the foot A of the perpendicular lowered from C to \bar{k} lies on k .*

Proof. Denote by O the vertex of the angle (h, k) and denote $l \equiv O_C$. Using L 1.2.21.4, C 1.3.16.4 we see that $\angle(h, l) < \angle(h, k)$. Since, by hypothesis, $\angle(h, k)$ is acute, the angle $\angle(h, l)$ is also acute in view of L 1.3.16.20. Hence $F \in h$ by C 1.3.18.11. \square

Theorem 1.3.27. *Let a point D lie between points A, C and the intervals AD, DC are congruent. Suppose, further, that the lines a_{AH}, a_{CL} are both perpendicular to the line a_{HL} and the points H, D, L collinear. Then the point D lies between the points H, L and $AH \equiv CL, \angle AHD \equiv \angle CLD$.*

³⁸²Due to symmetry we do not need to consider the other logically possible case, i.e. the one where B, C lie on the opposite sides of a_{AD} .

³⁸³We have $E \in A_D \xrightarrow{L1.2.19.8} DEa_{AB}, CDa_{AB} \& DEa_{AB} \Rightarrow CEa_{AB}$

³⁸⁴We take into account that $\angle BCD \equiv \angle ECD, \angle B'C'D' \equiv \angle E'C'D'$.

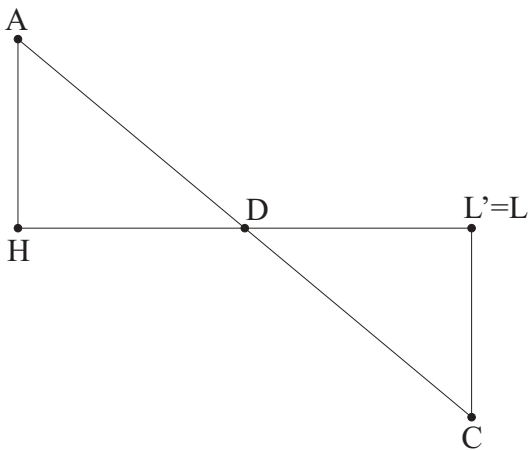

Figure 1.147: If point D lies between A, C , the intervals AD, DC are congruent, the lines a_{AH}, a_{CL} are both perpendicular to a_{HL} , and the points H, D, L collinear, then D lies between H, L and $AH \equiv CL, \angle AHD \equiv \angle CLD$.

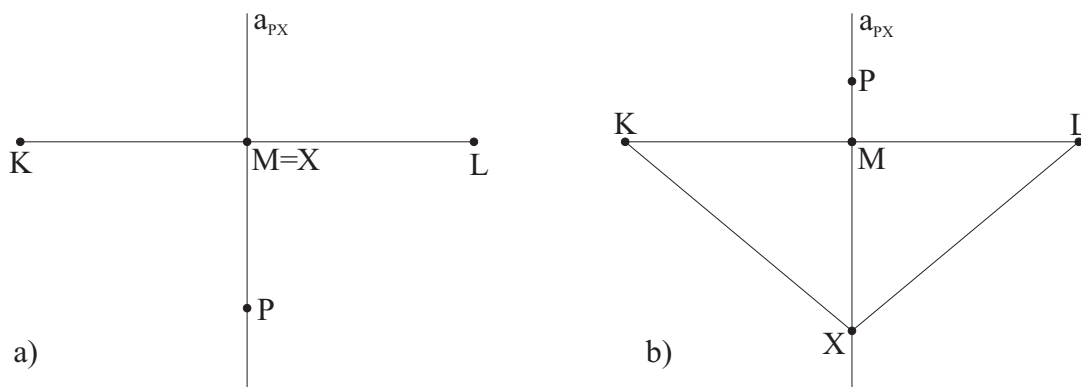

Figure 1.148: If a_{PX} is the right bisector of KL then $KX \equiv XL$.

Proof. (See Fig. 1.147.) Using A 1.2.2, A 1.3.1, choose a point L' so that $[HDL']$ and $DH \equiv DL'$. Then we have³⁸⁵ $AD \equiv DC \& DH \equiv DL' \& \angle ADH \equiv \angle CDL' \xrightarrow{A1.3.5} \angle AHD \equiv \angle CL'D$. Hence $a_{CL'} \perp a_{HL} \& a_{CL} \perp a_{HL} \& L' \in a_{HL} = a_{HD} \xrightarrow{L1.3.24.1} L' = L$. \square

Right Bisectors of Intervals

A line a drawn through the center of an interval KL and perpendicular to the line a_{KL} is called the right bisector of the interval KL .

Lemma 1.3.28.1. *Every interval has exactly one right bisector in the plane containing both the interval and the bisector.*

Proof. See T 1.3.22, L 1.3.8.3. \square

Lemma 1.3.28.2. *If a line a_{PX} is the right bisector of an interval KL then $KX \equiv XL$.*

Proof. Let $M = \text{mid } KL$. (Then, of course, $M \in a_{PX}$.) If $X = M$ (see Fig. 1.148, a)) then there is nothing to prove. If $M \neq X$ (see Fig. 1.148, b)) then³⁸⁶ We have $KM \equiv ML \& MX \equiv MX \& \angle KMX \equiv \angle LMX \xrightarrow{T1.3.4} \triangle KMX \equiv \triangle LMX \Rightarrow KX \equiv XL$. \square

Lemma 1.3.28.3. *If $KX \equiv XL$ and $a_{XY} \perp a_{KL}$, then the line a_{XY} is the right bisector of the interval KL .*

Proof. Denote $M = a_{XY} \cap a_{KL}$. By hypothesis, XM is the altitude, drawn from the vertex X of an isosceles (with $KX \equiv XL$) triangle $\triangle KXL$ to its side KL . Therefore, by T 1.3.25, XM is also a median. Hence $KM \equiv ML$ and $[KML]$, which makes a_{XY} the right bisector of the interval KL . \square

Lemma 1.3.28.4. *If $KX \equiv XL, KY \equiv YL, Y \neq X$, and the points K, L, X, Y are coplanar, then the line a_{XY} is the right bisector of the interval KL .*

³⁸⁵The angles $\angle ADH, \angle CDL'$, being vertical angles, are congruent. Observe also that the angles $\angle AHD, \angle AHL$ are identical in view of L 1.2.11.15, and the same is true for $\angle CLD, \angle CLH$.

³⁸⁶The angles $\angle KMX, \angle LMX$, both being right angles (because a_{PX} is the right bisector of KL), are congruent by T 1.3.16.

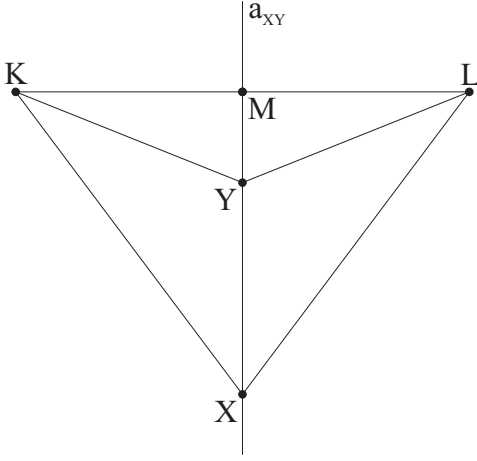

Figure 1.149: If $KX \equiv XL$, $KY \equiv YL$, $Y \neq X$, and the points K, L, X, Y are coplanar, then a_{XY} is the right bisector of KL .

Proof. (See Fig. 1.149.) Denote $M \Leftarrow \text{mid } KL$. Since $X \neq Y$, either X or Y is distinct from M . Suppose $X \neq M$.³⁸⁷ Since XM is the median joining the vertex X of the isosceles triangle $\triangle KXL$ with its base, by T 1.3.24 XM is also an altitude. That is, we have $a_{XM} \perp a_{KL}$. In the case when $Y = M$ there is nothing else to prove, as a_{XY} then has all the properties of a right bisector. If $Y \neq M$, we have $a_{YM} \perp a_{KL}$.³⁸⁸ Since the lines a_{XM}, a_{YM} perpendicular to the line a_{KL} at M lie in the same plane containing a_{KL} , by L 1.3.8.3 we have $a_{XM} = a_{YM} = a_{XY}$, which concludes the proof for this case. \square

Theorem 1.3.28. *Suppose points B, C lie on the same side of a line a_{KL} , the lines a_{KB}, a_{LC} are perpendicular to the line a_{KL} , and the interval KB is congruent to the interval LC . Then the right bisector of the interval KL (in the plane containing the points B, C, K, L) is also the right bisector of the interval BC , $\angle KBC \equiv \angle LCB$, and the lines a_{KL}, a_{BC} are parallel.*

Proof. (See Fig. 1.150.) Let a be the right bisector of the interval KL in the plane α_{BKL} . Denote $M \Leftarrow (KL) \cap a$. We have $a_{KB} \perp a_{KL} \& a \perp a_{KL} \& a_{LC} \perp a_{KL} \xrightarrow{C1.3.26.3} a_{KB} \parallel a \& a \parallel a_{LC} \& a_{KB} \parallel a_{LC}$. $a \subset \alpha_{BKL} \& M \in (KL) \cap a \parallel a_{KB} \xrightarrow{P1.2.44.1} \exists Y ([BYL] \& Y \in a)$. $a \subset \alpha_{BLC} \& Y \in (BL) \cap a \& a \parallel a_{LC} \xrightarrow{P1.2.44.1} \exists X ([BXC] \& X \in a)$.³⁸⁹ $BCa_{KL} \& X \in (BC) \xrightarrow{L1.2.19.9} Bxa_{KL} \& Cxa_{KL}$. Note that $M \in (KL) \cap a \& X \in a \& a \perp a_{KL} \Rightarrow \angle KMX \equiv \angle LMX$. Hence, $KM \equiv LM \& MX \equiv MX \& \angle KMX \equiv \angle LMX \xrightarrow{T1.3.4} \triangle KMX \equiv \triangle LMX \Rightarrow KX \equiv LX \& \angle MKX \equiv \angle MLX \& \angle KXM \equiv \angle LXM$. Since, evidently, $a_{KM} = a_{KL}$, we have $Bxa_{KL} \Rightarrow Bxa_{KM} \xrightarrow{L1.2.21.21} K_X \subset \text{Int}\angle MKB \vee K_B \subset \text{Int}\angle MKX \vee K_X = K_B$. But $K_B \subset \text{Int}\angle MKX \xrightarrow{L1.2.21.21} \exists P (P \in K_B \cap (MX)) \Rightarrow \exists P P \in a_{KB} \cap a$, which contradicts $a_{KB} \parallel a$. It is even easier to note that $K_X = K_B \Rightarrow X \in a_{KB} \cap a$ - again a contradiction. Thus, we have $K_X \subset \angle MKB$. Similarly, we can show that $L_X \subset \text{Int}\angle MLC$.³⁹⁰ By T 1.3.16 the angles $\angle MKB, \angle MLC$, both being right angles (recall that, by hypothesis, $a_{KB} \perp a_{KL} = a_{KM}$ and $a_{LC} \perp a_{KL} = a_{LM}$), are congruent. Therefore, we have $\angle MKB \equiv \angle MLC$. Hence $Bxa_{KM} \& Cxa_{LM} \& \angle MKB \equiv \angle MLC \& \angle MKX \equiv \angle MLX \xrightarrow{T1.3.9} \angle BKX \equiv \angle CLX$. $KB \equiv LC \& KX \equiv LX \& \angle BKX \equiv \angle CLX \xrightarrow{T1.3.4} \triangle BKX \equiv \triangle CLX \Rightarrow BX \equiv CX \& \angle KBX \equiv \angle LCX \& \angle KXB \equiv \angle LXC$. $[BXC] \xrightarrow{L1.2.11.15} B_X = B_C \& C_X = C_B \Rightarrow \angle KBX = \angle KBC \& \angle LCX = \angle LCB$. $\angle KBX \equiv \angle LCX \& \angle KBX = \angle KBC \& \angle LCX = \angle LCB \Rightarrow \angle KBC \equiv \angle LCB$. Since $\angle MKB$ is a right angle, by C 1.3.17.4 the other two angles, $\angle KMB$ and $\angle KBM$, of the triangle $\triangle MKB$, are bound to be acute. Since the angle $\angle KMB$ is acute and the angle $\angle KMX$ is a right angle, by L 1.3.16.17 we have $\angle KMB < \angle KMX$. Hence $Bxa_{KM} \& \angle KMB < \angle KMX \xrightarrow{C1.3.16.4} M_B \subset \text{Int}\angle KMX \xrightarrow{L1.2.21.10} \exists E ([KEX] \& E \in M_B)$. $[KEX] \xrightarrow{L1.2.11.15} K_E = K_X \& X_E = X_K$. $E \in M_B \xrightarrow{L1.2.11.8} [MEB] \vee [MBE] \vee E = B$. But the assumptions that $[MBE]$ or $E = B$ lead (by L 1.2.21.4, L 1.2.21.6, L 1.2.11.3) respectively, to $K_B \subset \text{Int}\angle MKX$ or $K_X = K_B$ - the possibilities discarded above. Thus, we have $[MEB]$. By L 1.2.21.4, L 1.2.21.6 $[MEB] \Rightarrow X_K = X_E \subset \text{Int}\angle BXM$. Similarly, it can be shown that $X_L \subset \text{Int}\angle CXM$.

³⁸⁷Due to symmetry of the assumptions of the theorem with respect to the interchange of X, Y , we can do so without any loss of generality.

³⁸⁸To show that $a_{YM} \perp a_{KL}$, one could proceed in full analogy with the previously considered case as follows:

Since YM is the median joining the vertex Y of the isosceles triangle $\triangle KYL$ with its base, by T 1.3.24 YM is also an altitude.

On the other hand, the same result is immediately apparent from symmetry considerations.

³⁸⁹We take into account that, obviously, $BCa_{KL} \Rightarrow \alpha_{BKL} = \alpha_{BLC}$.

³⁹⁰This can be done in the following way, using arguments fully analogous to those we have used to show that $K_X \subset \angle MKB$. Since $a_{LM} = a_{KL}$, we have $Cxa_{KL} \Rightarrow Cxa_{LM} \xrightarrow{L1.2.21.21} L_X \subset \text{Int}\angle MLC \vee L_C \subset \text{Int}\angle MLX \vee L_X = L_C$. But $L_C \subset \text{Int}\angle MLX \xrightarrow{L1.2.21.21} \exists P (P \in L_C \cap (MX)) \Rightarrow \exists P P \in a_{LC} \cap a$, which contradicts $a_{LC} \parallel a$. It is even easier to note that $L_X = L_C \Rightarrow X \in a_{LC} \cap a$ - again a contradiction. Thus, we have $L_X \subset \angle MLC$. Alternatively, we can simply observe that the conditions of the theorem are symmetric with respect to the simultaneous substitutions $K \leftrightarrow L, B \leftrightarrow C$.

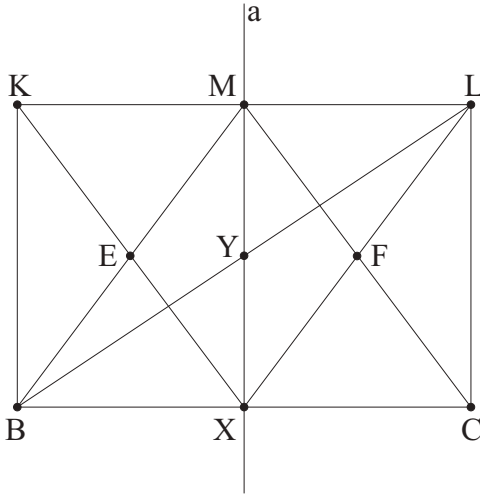

Figure 1.150: Suppose points B, C lie on the same side of a_{KL} , the lines a_{KB}, a_{LC} are perpendicular to a_{KL} , and the interval $KB \equiv LC$. Then the right bisector of KL (in the plane containing B, C, K, L) is also the right bisector of BC , $\angle KBC \equiv \angle LCB$, and $a_{KL} \parallel a_{BC}$.

³⁹¹ $\angle KXM \equiv \angle LXM$ & $\angle KXB \equiv \angle LXC$ & $X_K \subset \text{Int}\angle BXM$ & $X_L \subset \text{Int}\angle CXM \xrightarrow{\text{T1.3.9}} \angle BXM \equiv \angle CXM$. In view of $[BXC]$ this implies that $\angle BXM, \angle CXM$ are both right angles. Together with $BX \equiv CX$ and $X \in a$ this means that the line a is the right bisector of the interval BC . Finally, the lines $a_{KL} = a_{KM}, a_{BC} = a_{CX}$, both being perpendicular to the line $a = a_{MX}$, are parallel by C 1.3.26.2. \square

Proposition 1.3.28.1. *If F, D are the midpoints of the sides AB, AC , respectively, of a triangle $\triangle ABC$, then the right bisector of the interval BC is perpendicular to the line a_{FD} and the lines a_{BC}, a_{FD} are parallel.*

Proof. Obviously, $F \neq D \Rightarrow \exists a_{FD}$. Using L 1.3.8.1, draw through points A, B, C the perpendiculars to a_{FD} with feet H, K, L , respectively. ³⁹² If $D = H$ (see Fig. 1.151, a), then, obviously, also $D = L$, but certainly $F \neq K \neq D$. If $F = H$ (see Fig. 1.151, b), then also $F = K$, but $D \neq L \neq F$. In both of these cases we have $a_{KB} \perp a_{KL} = a_{FD}$, $a_{LC} \perp a_{KL}$. On the other hand, if both $D \neq H$ and $F \neq H$ (and then, consequently, $D \neq K, D \neq L, F \neq K, F \neq L, H \neq K, H \neq L, K \neq L$ - see Fig. 1.151, c) then $[ADC] \& a_{AH} \perp a_{HL} = a_{FD} \& a_{LC} \perp a_{HL} \& [AFB] \& a_{KB} \perp a_{KH} = a_{FD} \& H \in a_{FD} \& K \in a_{FD} \& L \in a_{FD} \xrightarrow{\text{T1.3.9}} AH \equiv KB \& AH \equiv LC \Rightarrow KB \equiv LC$. ³⁹³ We have also $[AFB] \& [ADC] \& A \notin a_{FD} \& B \notin a_{FD} \& C \notin a_{FD} \& Aa_{FD}B \& Aa_{FD}C \xrightarrow{\text{L1.2.17.9}} BCa_{FD} = a_{KL}$. Since $a_{KB} \perp a_{KL}$, $a_{LC} \perp a_{KL}$, and BCa_{KL} , by T 1.3.28 the right bisector a of the interval KL is also the right bisector of the interval. This means that the line a is perpendicular to a_{FD} and the lines a_{BC}, a_{FD} are parallel. \square

Proposition 1.3.28.2. *If $ABCD$ is a simple plane quadrilateral with $AB \equiv CD, BC \equiv AD$, then $ABCD$ is a parallelogram. ³⁹⁴ Furthermore, we have $AE \equiv EC, BE \equiv ED$, where $E = (AC) \cap (BD)$. ³⁹⁵*

Proof. $AB \equiv CD \& BC \equiv AD \& AC \equiv AC \xrightarrow{\text{T1.3.10}} \triangle ABC \equiv \triangle CDA \Rightarrow \angle ABC \equiv \angle CDA \& \angle BAC \equiv \angle ACD \& \angle ACB \equiv \angle CAD$. Since, by hypothesis, the points A, B, C, D are coplanar and no three of them are collinear, by L 1.2.17.8 the points B, D lie either on one side or on opposite sides of the line a_{AC} . Suppose the former. Then $BDa_{AC} \& A_B \neq A_D \xrightarrow{\text{L1.2.21.21}} A_D \subset \text{Int}\angle BAC \vee A_B \subset \text{Int}\angle CAD$. ³⁹⁶ Suppose $A_D \subset \text{Int}\angle BAC$ (see Fig. 1.152, a). Then $\xrightarrow{\text{L1.2.21.10}} \exists X (X \in A_D \& [BXC])$. $X \in A_D \xrightarrow{\text{L1.2.11.8}} [ADX] \vee X = D \vee [AXD]$. But the last two options contradict the simplicity of $ABCD$ in view of Pr 1.2.10, Pr 1.2.11. Thus, $[ADX]$ is the only remaining option. But $[BXC] \xrightarrow{\text{L1.2.11.15}} C_X = C_B$, and by L 1.2.21.6, L 1.2.21.4 $[ADX] \Rightarrow C_D \subset \text{Int}\angle ACX$.

³⁹¹ Again, this can be done using arguments fully analogous to those employed to prove $X_K \subset \text{Int}\angle BXM$. Since $\angle MLC$ is a right angle, by C 1.3.17.4 the other two angles, $\angle LMC$ and $\angle LCM$, of the triangle $\triangle MLC$, are bound to be acute. Since the angle $\angle LMC$ is acute and the angle $\angle LMX$ is a right angle, by L 1.3.16.17 we have $\angle LMC < \angle LMX$. Hence $CXa_{LM} \& \angle LMC < \angle LMX \xrightarrow{\text{C1.3.16.4}} M_C \subset \text{Int}\angle LMX \xrightarrow{\text{L1.2.21.10}} \exists F ([LFX] \& F \in M_C)$. $[LFX] \xrightarrow{\text{L1.2.11.15}} L_F = L_X \& X_F = X_L$. $F \in M_C \xrightarrow{\text{L1.2.11.8}} [MFC] \vee [MCF] \vee F = C$. But the assumptions that $[MCF]$ or $F = C$ lead (by L 1.2.21.4, L 1.2.21.6, L 1.2.11.3) respectively, to $L_C \subset \text{Int}\angle MLX$ or $L_X = L_C$ - the possibilities discarded above. Thus, we have $[MFC]$. By L 1.2.21.4, L 1.2.21.6 $[MFC] \Rightarrow X_L = X_F \subset \text{Int}\angle CXM$. Alternatively, it suffices to observe that the conditions of the theorem are symmetric with respect to the simultaneous substitutions $K \leftrightarrow L, B \leftrightarrow C$.

³⁹² Observe that $F \in (AB) \cap a_{FD} \& D \in (AC) \cap a_{FD} \xrightarrow{\text{C1.2.1.12}} A \notin a_{FD} \& B \notin a_{FD} \& C \notin a_{FD}$.

³⁹³ Obviously, since all of the points D, F, H, K, L are distinct in this case, and we know that $H \in a_{FD}, K \in a_{FD}, L \in a_{FD}$, by A 1.1.2 the line formed by any two of the five points is identical to a_{FD} .

³⁹⁴ Note also the congruences $\angle ABC \equiv \angle CDA, \angle BAC \equiv \angle ACD, \angle ACB \equiv \angle CAD$, obtained as by-products of the proof.

³⁹⁵ Note also the congruence of the following vertical angles: $\angle AED \equiv \angle BEC, \angle AEB \equiv \angle CED$.

³⁹⁶ We can safely discard the possibility that $A_B = A_D$, for it would imply that the points A, B, D are collinear contrary to simplicity of $ABCD$.

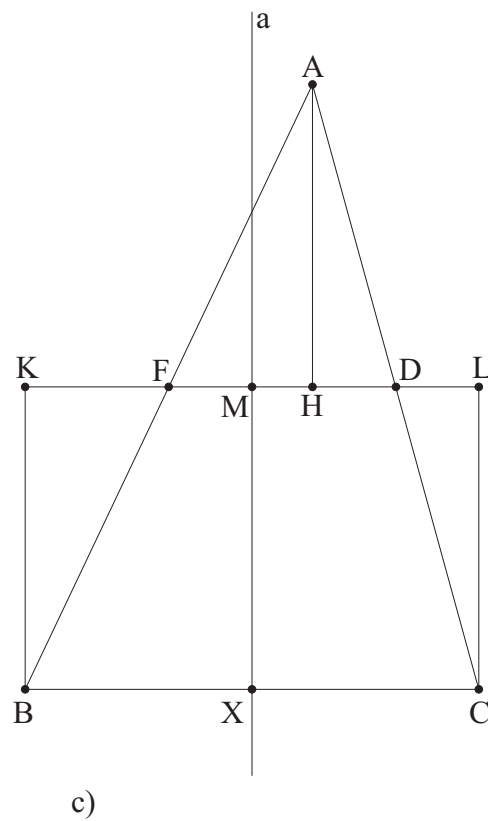
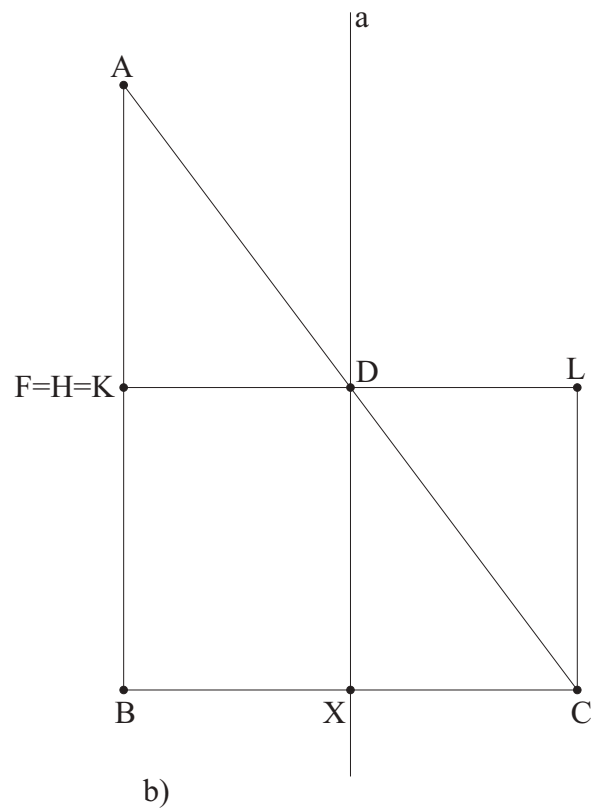
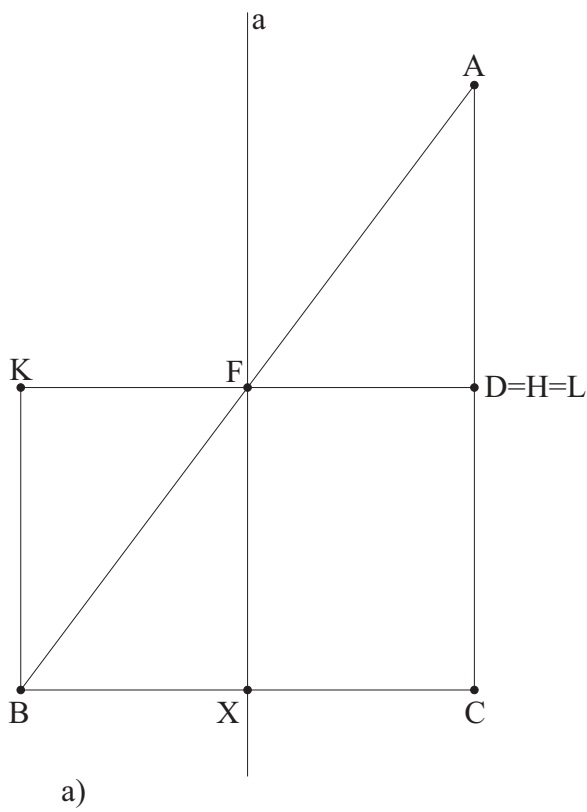
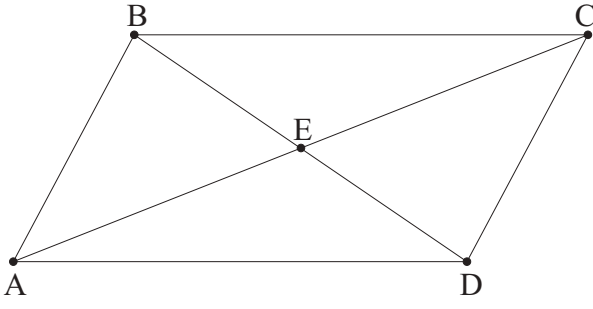
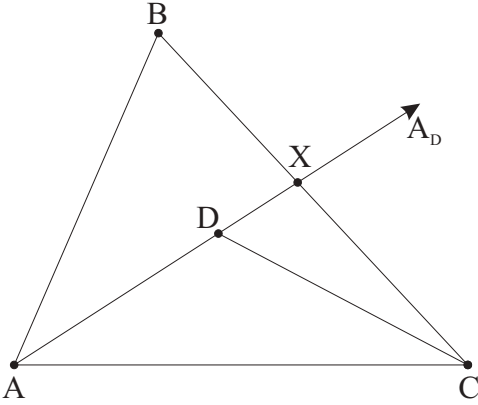

Figure 1.151: If F , D are the midpoints of the sides AB , AC , respectively, of $\triangle ABC$, then the right bisector of BC is perpendicular to a_{FD} and a_{BC} , a_{FD} are parallel.



a)



b)

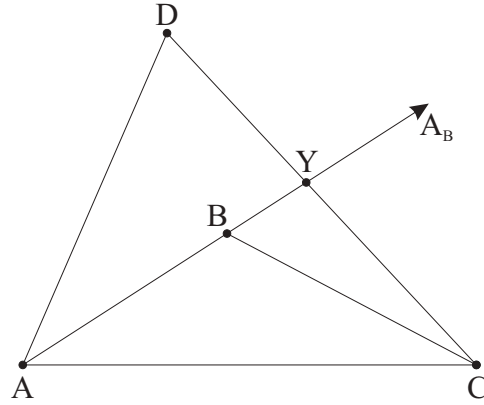

c)

Figure 1.152: If $ABCD$ is a simple plane quadrilateral with $AB \equiv CD$, $BC \equiv AD$, then $ABCD$ is a parallelogram.

Using C 1.3.16.4 then gives $\angle ACD < \angle ACX = \angle ACB \equiv \angle CAD < \angle BAC$. Hence by L 1.3.16.6 - L 1.3.16.8 $\angle ACD < \angle BAC$, which contradicts $\angle BAC \equiv \angle ACD$ in view of L 1.3.16.11. Similarly, suppose $A_B \subset \text{Int}\angle CAD$ (see Fig. 1.152, b)). Then $\xrightarrow{\text{L1.2.21.10}} \exists Y (Y \in A_B \& [CYD])$. $Y \in A_B \xrightarrow{\text{L1.2.11.8}} [ABY] \vee Y = B \vee [AYB]$. But the last two options contradict the simplicity of $ABCD$ in view of Pr 1.2.10, Pr 1.2.11. Thus, $[ABY]$ is the only remaining option. But $[CYD] \xrightarrow{\text{L1.2.11.15}} C_Y = C_D$, and by L 1.2.21.6, L 1.2.21.4 $[ABY] \Rightarrow C_B \subset \text{Int}\angle ACY$. Using C 1.3.16.4 then gives $\angle ACB < \angle ACY = \angle ACD \equiv \angle BAC < \angle CAD$. Hence by L 1.3.16.6 - L 1.3.16.8 $\angle ACB < \angle CAD$, which contradicts $\angle ACB \equiv \angle CAD$ in view of L 1.3.16.11. The two contradictions show that, in fact, the points B, D lie on opposite sides of the line a_{AC} . Hence $Ba_{AC}D \& \angle BAC \equiv \angle ACD \xrightarrow{\text{C1.3.26.3}} a_{AB} \parallel a_{CD}$. Since the conditions of the theorem obviously apply also to the quadrilateral $BCDA$ (see, for instance, T 1.2.49 about simplicity), we can conclude immediately that the lines a_{BC}, a_{AD} are also parallel, so $ABCD$ is indeed a parallelogram. Since $ABCD$ is a parallelogram, by L 1.2.47.2 the open intervals $(AC), (BD)$ concur at some point E . We have $[AEC] \& [BED] \xrightarrow{\text{L1.2.11.15}} A_E = A_C \& C_E = C_A \& B_E = B_D \& D_E = D_B$. Hence $AB \equiv CD \& \angle BAE = \angle BAC \equiv \angle DCA = \angle DCE \& \angle ABE = \angle ABD \equiv \angle CDB = \angle CDE \xrightarrow{\text{T1.3.5}} \triangle AEB \equiv \triangle CED \Rightarrow AE \equiv CE \& BE \equiv ED$. \square

Consider a pair (just a two-element set) of lines $\{a, b\}$ (in particular, we can consider a strip ab) and points $A \in a, B \in b$. If for all $A_1 \in a, B_1 \in b$ such that $A_1 \neq A, B_1 \neq B$ and the points A_1, B_1 lie on the same side of the line a_{AB} we have $\angle ABB_1 \equiv \angle BAA_1$, we say that the interval AB (or, for that matter, the line a_{AB}) is equally inclined with respect to the pair $\{a, b\}$ or simply that it is equally inclined to (the lines) a, b .

Using T 1.3.6 it is easy to see that for the interval AB (line a_{AB}) to be equally inclined to the strip ab it suffices to find just one pair $A_1 \in a, B_1 \in b$ such that $A_1 \neq A, B_1 \neq B, A_1B_1a_{AB}$ and $\angle ABB_1 \equiv \angle BAA_1$.

Given an interval AB equally inclined to a strip ab , where $A \in a, B \in b$, draw through the midpoint M of AB the line c perpendicular to a_{AB} (see T 1.3.22, L 1.3.8.1). In other words, c is the right bisector of AB . Then we have

Proposition 1.3.29.1. *The line c is parallel to both a and b . Furthermore, c is the right bisector of any interval $A'B'$, where $A' \in a, B' \in b$, equally inclined to the strip ab .*

Proof. To show that c is parallel to both a and b suppose the contrary, i.e. that c meets, say, a in some point A_1 . Using A 1.3.1 take a point B_1 such that $AA_1 \equiv BB_1$ and the points A_1, B_1 lie on the same side of the line a_{AB} . Since, by hypothesis, the interval AB is equally inclined to the strip ab , we have $\angle A_1AB \equiv \angle ABB_1$. As M is the midpoint of AB , we have (by definition of midpoint) $[AMB]$ and $AM \equiv MB$. Hence $[AMB] \xrightarrow{\text{L1.2.11.15}} A_M = A_B \& B_M =$

$B_A \Rightarrow \angle A_1AM = \angle A_1AB \& \angle MBB_1 = \angle ABB_1$ Now we can write $AA_1 \equiv BB_1 \& \angle A_1AM \equiv \angle MBB_1 \& AM \equiv MB \xrightarrow{T1.3.4} \triangle MAA_1 \equiv \triangle MBB_1 \Rightarrow \angle AMA_1 \equiv \angle BMB_1 \& MA_1 \equiv MB_1$. Since, by hypothesis, the line $c \ni A_1$ is perpendicular to a_{AB} at M , the angles $\angle AMA_1, \angle BMA_1$ are congruent to each other (they are both right angles). As $\angle BMA_1 \equiv \angle BMB_1$ ³⁹⁷ and the points A_1, B_1 lie on the same side of the line a_{AB} , we have $MA_1 = MB_1$. But $B_1 \in M_{A_1} \& MA_1 \equiv MB_1 \xrightarrow{T1.3.2} B_1 = A_1$, which implies that the line $a \ni A_1$ meets the line $b \ni B_1$ contrary to our assumption that $a \parallel b$. This contradiction shows that in fact we have $c \parallel a, c \parallel b$.

Now from L 1.2.19.26 we have $\exists M' \in c \cap (A'B')$. Using L 1.2.19.9 (see also L 1.2.1.3) we see that the points A', M' , as well as M', B' lie on the same side of the line $a_{AM} = a_{MB} = a_{AB}$. Since $AM \equiv MB \& MM' \equiv MM' \& \angle AMM' \equiv \angle BMM' \xrightarrow{T1.3.4} \triangle AMM' \equiv \triangle BMM' \Rightarrow AM' \equiv BM' \& \angle MAM' \equiv \angle MBM' \& \angle AM'M \equiv \angle BM'M$. Taking into account that $\angle BAA' \equiv \angle ABB'$ (recall that AB is equally inclined to the strip ab by hypothesis) and $[AMB] \xrightarrow{L1.2.11.15} A_M = A_B \& B_M = B_A \Rightarrow \angle A'AM = \angle A'AB \& \angle MBB' = \angle ABB'$, we have $\angle MAA' \equiv \angle MBB'$. In view of the fact that the points A', M' , as well as M', B' lie on the same side of the line $a_{AM} = a_{MB} = a_{AB}$, from T 1.3.9 we find that $\angle M'AA' \equiv \angle M'BB'$. Since the points A', B' lie on the same side of the line a_{AB} and the lines $a = a_{AA'}, b = b_{BB'}$ are parallel, the points A, B lie on the same side of the line $a_{A'B'}$ (see C 1.2.47.5). Arguing as above (using L 1.2.19.9, L 1.2.1.3), or directly using C 1.2.47.5,³⁹⁸ we see that the points A, M , as well as M, B lie on the same side of the line $a_{A'M'} = a_{M'B'} = a_{A'B'}$. Furthermore, in view of C 1.2.47.6 the ray M'_A lies inside the angle $\angle M'M'A'$ and the ray M'_B lies inside the angle $\angle M'M'B'$. In view of the fact that the interval $A'B'$ is equally inclined with respect to the strip ab , this implies that $\angle AA'B' \equiv \angle BB'A'$. Taking into account $[A'M'B'] \xrightarrow{L1.2.11.15} A'_{M'} = A'_{B'} \& B'_{M'} = B'_{A'} \Rightarrow \angle AA'M' = \angle AA'B \& \angle M'B'B = \angle A'B'B$, we have $\angle AA'M' \equiv \angle BB'M'$. Now we can write $AM' \equiv BM' \& \angle M'AA' \equiv \angle M'BB' \& \angle AA'M' \equiv \angle BB'M' \xrightarrow{T1.3.19} \triangle AA'M' \equiv \triangle BB'M' \Rightarrow A'M' \equiv B'M' \& \angle AM'A' \equiv \angle BM'B'$. Finally, $\angle AM'M \equiv \angle BM'M \& \angle AM'A' \equiv \angle BM'B' \& M'_A \subset \text{Int}\angle A'M'M \& M'_B \subset \text{Int}\angle B'M'M \xrightarrow{T1.3.9} \angle A'M'M \equiv \angle B'M'M$. But the relation $[A'M'B']$ implies that the angles $\angle A'M'M, \angle B'M'M$ are adjacent supplementary, and we see that these angles are right, as required.

□

Isometries on the Line

Lemma 1.3.29.2. *If $[ABC], AB \equiv A'B', BC \equiv B'C', AC \equiv A'C'$, then $[A'B'C']$.*

Proof. First, observe that using L 1.3.13.3, L 1.3.13.7³⁹⁹ $[ABC] \& AB \equiv A'B' \& BC \equiv B'C' \& AC \equiv A'C' \Rightarrow A'B' < A'C' \& B'C' < A'C'$. To show that $B' \in a_{A'C'}$, suppose the contrary, i.e. $B' \notin a_{A'C'}$. Let B'' be the foot of the perpendicular to $a_{A'C'}$ drawn through B' . Obviously, $B'' \neq A'$ (see Fig. 1.153, a), c), for otherwise by C 1.3.18.2 $A'C' = B''C' < B'C'$, which (in view of L 1.3.16.10) contradicts the inequality $B'C' < A'C'$ proven above. Similarly, we have $B'' \neq C'$, because the assumption $B'' = C'$ would imply $A'C' = A'B'' < A'B'$ - a contradiction with $A'B' < A'C'$ shown above.⁴⁰⁰ We can write $B'' \in a_{A'C'} \& B'' \neq A' \& B'' \neq C' \xrightarrow{T1.2.2} [B''A'C'] \vee [A'B''C'] \vee [A'C'B'']$. The assumption that $[B''A'C']$ (see Fig. 1.153, a), d)) would (by L 1.3.13.3) imply $A'C' < B''C'$, whence $A'C' < B''C' \& B''C' < B'C' \xrightarrow{L1.3.13.8} A'C' < B'C'$ - a contradiction with $B'C' < A'C'$. Similarly, $[A'C'B'']$ would (by L 1.3.13.3) imply $A'C' < B''C'$, whence $A'C' < B''C' \& B''C' < B'C' \xrightarrow{L1.3.13.8} A'C' < B'C'$ - a contradiction with $B'C' < A'C'$.⁴⁰¹ But the remaining variant $[A'B''C']$ (see Fig. 1.153, a), b)) also leads to contradiction, for (using T 1.3.1, L 1.3.13.7) $A'B'' < A'B' \& AB \equiv A'B' \Rightarrow A'B'' < AB, B''C' < B'C' \& B'C' \equiv BC \Rightarrow B''C' < BC$, and $[A'B''C'] \& [ABC] \& A'B'' < AB \& B''C' < BC \xrightarrow{L1.3.21.3} A'C' < AC$, which (in view of L 1.3.13.11) contradicts $AC \equiv A'C'$. The resulting major contradiction shows that in fact the point B' has to lie on the line $a_{A'C'}$. We have $B' \in a_{A'C'} \& B' \neq A' \& B' \neq C' \xrightarrow{T1.2.2} [B'A'C'] \vee [A'B'C'] \vee [A'C'B']$. But the first of these cases leads to contradiction, as does the third, because $[B'A'C'] \xrightarrow{C1.3.13.4} A'C' < B'C', [A'C'B'] \xrightarrow{C1.3.13.4} A'C' < A'B'$. Thus, we conclude that $[A'B'C']$, q.e.d. □

Corollary 1.3.29.3. *Isometries transform line figures (sets of points lying on one line) into line figures.*⁴⁰²

Proof. Obviously, we need to consider only figures containing at least 3 points. If we take such a figure \mathcal{A} and a line $a_{A_1A_3}$ defined by two arbitrarily chosen points A_1, A_3 of \mathcal{A} , by L 1.1.1.4 any other point A_2 of \mathcal{A} will lie on $a_{A_1A_3}$. Using T 1.2.2, we can assume without any loss of generality that $[A_1A_2A_3]$. If $\phi : \mathcal{A} \rightarrow \mathcal{B}$ is a motion, mapping the

³⁹⁷We take into account that $\angle AMA_1 \equiv \angle BMA_1 \& \angle AMA_1 \equiv \angle BMB_1 \Rightarrow \angle BMA_1 \equiv \angle BMB_1$.

³⁹⁸Recall that $a \parallel c \parallel b$, and thus the quadrilaterals $AMM'A', BMM'B'$ are trapezoids.

³⁹⁹Actually, we are also using T 1.3.1, but we do not normally cite our usage of this theorem and other highly familiar facts explicitly to avoid cluttering the proofs with trivial details.

⁴⁰⁰Observe that, having proven $B'' \neq A'$, we could get $B'' \neq C'$ simply out of symmetry considerations. Namely, we need to note that the conditions of the lemma are invariant with respect to the simultaneous interchanges $A \leftrightarrow C, A' \leftrightarrow C'$, and make the appropriate substitutions.

⁴⁰¹Again, once we know that $\neg[B''A'C']$, we can immediately exclude the possibility that $[A'C'B'']$ using symmetry considerations, namely, that the conditions of the lemma are invariant with respect to the substitutions $A \leftrightarrow C, A' \leftrightarrow C'$.

⁴⁰²This corollary can be given a more precise formulation as follows: Given two points A, B in a line figure \mathcal{A} , all points of the image $A' = f(A)$ of the set \mathcal{A} under an isometry f lie on the line $a_{A'B'}$, where $A' = f(A), B' = f(B)$.

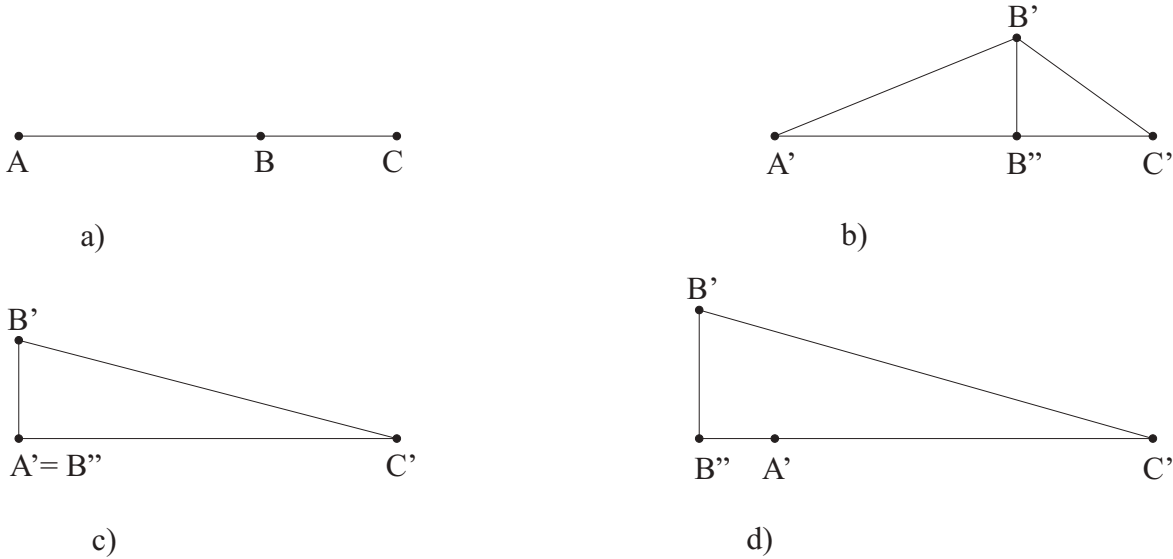

Figure 1.153: Illustration for proof of L 1.3.29.2.

figure \mathcal{A} into a point set \mathcal{B} , we have by the preceding lemma (L 1.3.34.1): $[B_1B_2B_3]$, where $B_i = \phi(A_i)$, $i = 1, 2, 3$. Hence by L 1.2.1.3 the points B_1, B_2, B_3 are collinear, q.e.d. \square

Corollary 1.3.29.4. *Isometries transform lines into lines.* ⁴⁰³

Proof. From the preceding corollary we immediately have $f(a) \subset a'$. ⁴⁰⁴ \square

Lemma 1.3.29.5. *Given a collinear set of points \mathcal{A} congruent to a set of points \mathcal{A}' , for any point O , lying on the line a containing the set \mathcal{A} and distinct from points $A, B \in \mathcal{A}$, there is exactly one point O' lying on the line a' containing the set \mathcal{A}' such that the sets $\mathcal{A} \cup O, \mathcal{A}' \cup O'$ are congruent.*

Proof. Suppose an interval AB is congruent to an interval $A'B'$, where $A, B \in \mathcal{A}, A', B' \in \mathcal{A}'$. Since the points A, B, O are collinear, by T 1.2.2 either $[OAB]$, or $[OBA]$, or $[AOB]$. Suppose first A lies between O, B . Using A 1.3.1, choose $A' \in \mathcal{A}'$ (unique by T 1.3.1) such that $OA \equiv O'A'$. Now we can write $[OAB] \& [O'A'B'] \& OA \equiv O'A' \& AB \equiv A'B' \xrightarrow{P1.3.9.3} OB \equiv O'B'$. Thus, we have $\{O, A, B\} \equiv \{O', A', B'\}$. Similarly, by symmetry for the case when B lies between O, A we also have $\{O, A, B\} \equiv \{O', A', B'\}$. ⁴⁰⁵ Finally, if O lies between A, B , by C 1.3.9.2 we have $\exists O' [A'O'B'] \& OA \equiv O'A' \& OB \equiv O'B'$. Thus, again $\{O, A, B\}, \{O', A', B'\}$ are congruent. To complete the proof of the lemma we need to show that for all $P \in \mathcal{A}$ we have $OP \equiv O'P'$, where $P' \in \mathcal{A}'$. We already know this result to be correct for $P = A$ and $P = B$. We need to prove it for $P \neq A, P \neq B$. We further assume that the point $P' \in \mathcal{A}'$ is chosen so that $AP \equiv A'P'$. Then, of course, also $BP \equiv B'P'$. These facts reflect the congruence of the sets $\mathcal{A}, \mathcal{A}'$. Again, we start with the case when $[OAB]$. Since the points O, A, B, P are collinear and distinct, from T 1.2.2, T 1.2.5 we have either $[POB]$, or $[OPA]$, or $[APB]$, or $[OBP]$ (see Fig. 1.154, a-d), respectively). Suppose first $[POB]$. We then have: $[POB] \& [OAB] \xrightarrow{L1.2.3.2} [POA] \& [PAB]$. $[PAB] \& PA \equiv P'A' \& AB \equiv A'B' \& PB \equiv P'B' \xrightarrow{L1.3.29.2} [P'A'B']$. $[P'A'B'] \& [O'A'B'] \xrightarrow{L1.2.15.2} P' \in A'_B \& O' \in A'_B$. $[POA] \& P' \in A'_B \& O' \in A'_B \& AP \equiv A'P' \& OA \equiv O'A' \xrightarrow{L1.3.9.1} OP \equiv O'P'$. Suppose now $[OPA]$. Then $[OPA] \& [OAB] \xrightarrow{L1.2.3.2} [PAB] \& [OPB]$. $[PAB] \& PA \equiv P'A' \& AB \equiv A'B' \& PB \equiv P'B' \xrightarrow{L1.3.29.2} [P'A'B']$. $[P'A'B'] \& [O'A'B'] \xrightarrow{L1.2.15.2} P' \in A'_B \& O' \in A'_B$. $[OPA] \& P' \in A'_B \& O' \in A'_B \& AP \equiv A'P' \& OA \equiv O'A' \xrightarrow{L1.3.9.1} OP \equiv O'P'$. Suppose $[APB]$. Then $[APB] \& AP \equiv A'P' \& PB \equiv P'B' \& AB \equiv A'B' \xrightarrow{L1.3.29.2} [A'P'B']$. $[OAB] \& [APB] \xrightarrow{L1.2.3.2} [OAP]$. $[O'A'B'] \& [A'P'B'] \xrightarrow{L1.2.3.2} [O'A'P']$. $[OAP] \& [O'A'P'] \& OA \equiv O'A' \& AP \equiv A'P' \xrightarrow{P1.3.9.3} OP \equiv O'P'$. Finally, suppose $[OBP]$. Then $[OBP] \& [OAB] \xrightarrow{L1.2.3.2} [OAP] \& [ABP]$. $[ABP] \& AB \equiv A'B' \& BP \equiv B'P' \& AP \equiv A'P' \xrightarrow{L1.3.29.2} [A'B'P']$. $[O'A'B'] \& [A'B'P'] \xrightarrow{L1.2.3.1} [O'A'P']$. $[OAP] \& [O'A'P'] \& OA \equiv O'A' \& AP \equiv A'P' \xrightarrow{P1.3.9.3} OP \equiv O'P'$. Similarly, it can be shown that when $[OBA]$ the congruence $OP \equiv O'P'$ always holds. ⁴⁰⁶ We turn to the remaining case, when O lies between A, B . Since the points O, A, B, P are collinear

⁴⁰³This corollary can be stated more precisely as follows: Any isometry f whose domain contains the set \mathcal{P}_a of all points of a line a transforms \mathcal{P}_a into the set \mathcal{P}'_a of all points of a line a' , not necessarily distinct from a .

⁴⁰⁴For convenience, we are making use of a popular jargon, replacing the notation for the set (say, \mathcal{P}_a in our example) of points of a line a by the notation for the line itself.

⁴⁰⁵In fact, since A, B , as well as A', B' enter the conditions symmetrically, we just need to substitute $A \rightarrow B, B \rightarrow A$ in the preceding arguments: Using A 1.3.1, choose $B' \in \mathcal{A}'$ (unique by T 1.3.1) such that $OB \equiv O'B'$. Now we can write $[OBA] \& [O'B'A'] \& OB \equiv O'B' \& BA \equiv B'A' \xrightarrow{P1.3.9.3} OA \equiv O'A'$.

⁴⁰⁶Due to symmetry, we just need to make the substitutions $A \rightarrow B, B \rightarrow A$ in our preceding arguments concerning the case $[OAB]$. To further convince the reader, we present here the result of this mechanistic replacement. Since the points O, A, B ,

and distinct, from T 1.2.2, T 1.2.5 we have either $[PAB]$, or $[APO]$, or $[OPB]$, or $[ABP]$ (see Fig. 1.154, e)-h), respectively). Suppose first $[PAB]$. We have: $[PAB] \& PA \equiv P'A' \& AB \equiv A'B' \& PB \equiv P'B' \xrightarrow{L1.3.29.2} [P'A'B']$. $[PAB] \& [AOB] \xrightarrow{L1.2.3.2} [PAO]$. $[P'A'B'] \& [A'O'B'] \xrightarrow{L1.2.3.2} [P'A'O']$. $[PAO] \& [P'A'O'] \& OA \equiv O'A' \& AP \equiv A'P' \xrightarrow{P1.3.9.3} OP \equiv O'P'$. Suppose now $[OPB]$. Then $[AOB] \& [OPB] \xrightarrow{L1.2.3.2} [AOP] \& [APB]$. $[APB] \& AP \equiv A'P' \& PB \equiv P'B' \& AB \equiv A'B' \xrightarrow{L1.3.29.2} [A'P'B']$. $[A'O'B'] \& [A'P'B'] \xrightarrow{L1.2.11.13} O' \in A'B' \& P' \in A'B'$. $[AOP] \& O' \in A'B' \& P' \in A'B' \& AO \equiv A'O' \& AP \equiv A'P' \& OA \equiv O'A' \xrightarrow{L1.3.9.1} OP \equiv O'P'$. The cases when $[ABP]$, $[APO]$ can be reduced to the cases $[PAB]$, $[OPB]$, respectively by the substitutions $A \rightarrow B$, $B \rightarrow A$.⁴⁰⁷ \square

Theorem 1.3.29. *Let A_i , where $i \in \mathbb{N}_n$, $n \geq 3$, be a finite sequence of points with the property that every point of the sequence, except for the first and the last, lies between the two points with adjacent (in \mathbb{N}) numbers. Suppose, further, that the sequence A_i is congruent to a sequence B_i , where $i \in \mathbb{N}_n$.⁴⁰⁸ Then the points B_1, B_2, \dots, B_n are in order $[B_1B_2 \dots B_n]$, i.e. the sequence of points B_i , $i \in \mathbb{N}_n$, $n \geq 3$ ($n \in \mathbb{N}$) on one line has the property that a point lies between two other points iff its number has an intermediate value between the numbers of these two points.*

Proof. By induction on n . For $n = 3$ see the preceding lemma (L 1.3.29.2). Observe further that when $n \geq 4$ the conditions of the theorem, being true for the sequences A_i , B_i of n points, are also true for the sequences A_1, A_2, \dots, A_{n-1} and B_1, B_2, \dots, B_{n-1} , each consisting of $n - 1$ points. The induction assumption then tells us that the points B_1, B_2, \dots, B_{n-1} are in order $[B_1B_2 \dots B_{n-1}]$. Since the points A_1, A_2, \dots, A_n are in order $[A_1A_2 \dots A_n]$ (see L 1.2.7.3), we can write $[A_1A_{n-1}A_n] \& A_1A_{n-1} \equiv B_1B_{n-1} \& A_{n-1}A_n \equiv B_{n-1}B_n \& A_1A_n \equiv B_1B_n \xrightarrow{L1.3.29.2} [B_1B_{n-1}B_n]$. $[B_1B_{n-2}B_{n-1}] \& [B_1B_{n-1}B_n] \xrightarrow{L1.2.3.2} [B_{n-2}B_{n-1}B_n]$. Applying L 1.2.7.3 again, we see that the points B_1, B_2, \dots, B_n are in order $[B_1B_2 \dots B_n]$, q.e.d. \square

Corollary 1.3.29.1. *Isometries are either sense-preserving or sense-reversing transformations.*

Proof. \square

Theorem 1.3.30. *Given a figure \mathcal{A} containing a point O on line a , a point A on a , and a line a' containing points O', A' , there exists exactly one motion $f : \mathcal{A} \rightarrow \mathcal{A}'$ and, correspondingly, one figure \mathcal{A}' such that $f(O) = O'$ and if A, B lie (on line a) on the same side (on opposite sides) of the point O , where $B \in \mathcal{A}$ then the points A' and $B' = f(B)$ also lie (on line a') on the same side (on opposite sides) of the point O' .⁴⁰⁹*

Proof. We set, by definition, $f(O) \stackrel{\text{def}}{\iff} O'$. For $B \in O_A \cap \mathcal{A}$, using A 1.3.1, choose $B' \in O'_{A'}$ so that $OB \equiv O'B'$. Similarly, for $B \in O'_A \cap \mathcal{A}$, using A 1.3.1, choose $B' \in (O'_{A'})^c$ so that again $OB \equiv O'B'$. In both cases we let, by definition, $f(B) \equiv B'$. Note that, by construction, if $B, C \in \mathcal{A}$ and $B' = f(B)$, $C' = f(C)$, then the point pairs B, C and B', C' lie either both on one side (see Fig. 1.155, a)) or both on opposite sides (see Fig. 1.155, b)) of the points O, O' , respectively. Hence by P 1.3.9.3 $BC \equiv B'C'$ for all $B, C \in \mathcal{A}$, which completes the proof.⁴¹⁰ \square

P are collinear and distinct, from T 1.2.2, T 1.2.5 we have either $[POA]$, or $[OPB]$, or $[BPA]$, or $[OAP]$. Suppose first $[POA]$. We then have: $[POA] \& [OBA] \xrightarrow{L1.2.3.2} [POB] \& [PBA]$. $[PBA] \& PB \equiv P'B' \& BA \equiv B'A' \& PA \equiv P'A' \xrightarrow{L1.3.29.2} [P'B'A']$. $[P'B'A'] \& [O'B'A'] \xrightarrow{L1.2.15.2} P' \in B'_A' \& O' \in B'_A'$. $[POB] \& P' \in B'_A' \& O' \in B'_A' \& BP \equiv B'P' \& OB \equiv O'B' \xrightarrow{L1.3.9.1} OP \equiv O'P'$. Suppose now $[OPB]$. Then $[OPB] \& [OBA] \xrightarrow{L1.2.3.2} [PBA] \& [OPA]$. $[PBA] \& PB \equiv P'B' \& BA \equiv B'A' \& PA \equiv P'A' \xrightarrow{L1.3.29.2} [P'B'A']$. $[P'B'A'] \& [O'B'A'] \xrightarrow{L1.2.15.2} P' \in B'_A' \& O' \in B'_A'$. $[OPB] \& P' \in B'_A' \& O' \in B'_A' \& BP \equiv B'P' \& OB \equiv O'B' \xrightarrow{L1.3.9.1} OP \equiv O'P'$. Suppose $[BPA]$. Then $[BPA] \& BP \equiv B'P' \& PA \equiv P'A' \& BA \equiv B'A' \xrightarrow{L1.3.29.2} [B'P'A']$. $[OBA] \& [BPA] \xrightarrow{L1.2.3.2} [OBP]$. $[O'B'A'] \& [B'P'A'] \xrightarrow{L1.2.3.2} [O'B'P']$. $[OBP] \& [O'B'P'] \& OB \equiv O'B' \& BP \equiv B'P' \xrightarrow{P1.3.9.3} OP \equiv O'P'$. Finally, suppose $[OAP]$. Then $[OAP] \& [OAB] \xrightarrow{L1.2.3.2} [OAP] \& [BAP]$. $[BAP] \& BA \equiv B'A' \& AP \equiv A'P' \& BP \equiv B'P' \xrightarrow{L1.3.29.2} [B'A'P']$. $[O'B'A'] \& [B'A'P'] \xrightarrow{L1.2.3.1} [O'B'P']$. $[OBP] \& [O'B'P'] \& OB \equiv O'B' \& BP \equiv B'P' \xrightarrow{P1.3.9.3} OP \equiv O'P'$.

⁴⁰⁷Again, to further convince the reader of the validity of these substitutions and the symmetry considerations underlying them, we present here the results of such substitutions. Suppose first $[PBA]$. We have: $[PBA] \& PB \equiv P'B' \& BA \equiv B'A' \& PA \equiv P'A' \xrightarrow{L1.3.29.2} [P'B'A']$. $[PBA] \& [BOA] \xrightarrow{L1.2.3.2} [PBO]$. $[P'B'A'] \& [B'O'A'] \xrightarrow{L1.2.3.2} [P'B'O']$. $[PBO] \& [P'B'O'] \& OB \equiv O'B' \& BP \equiv B'P' \xrightarrow{P1.3.9.3} OP \equiv O'P'$. Suppose now $[OPA]$. Then $[BOA] \& [OPA] \xrightarrow{L1.2.3.2} [BOP] \& [BPA]$. $[BPA] \& BP \equiv B'P' \& PA \equiv P'A' \& BA \equiv B'A' \xrightarrow{L1.3.29.2} [B'P'A']$. $[B'O'A'] \& [B'P'A'] \xrightarrow{L1.2.11.13} O' \in B'_A' \& P' \in B'_A'$. $[BOP] \& O' \in B'_A' \& P' \in B'_A' \& BO \equiv B'O' \& BP \equiv B'P' \& O' \in B'_A' \& P' \in B'_A' \& BP \equiv B'P' \& OB \equiv O'B' \xrightarrow{L1.3.9.1} OP \equiv O'P'$.

⁴⁰⁸According to the definition, two sequences can be congruent only if they consist of equal number of points.

⁴⁰⁹That is, for $B \in \mathcal{A}$ if $B \in O_A$ then $B' \in O'_{A'}$ and $B \in O'_A$ implies $B' \in O'^c_{A'}$.

⁴¹⁰Uniqueness is obvious from A 1.3.1.



a)

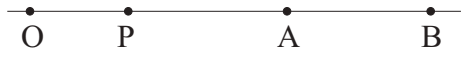

b)

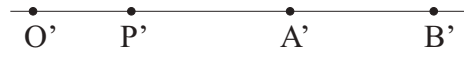

c)



d)

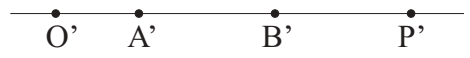

e)



f)



g)



h)



Figure 1.154: Illustration for proof of L 1.3.29.5.



a)

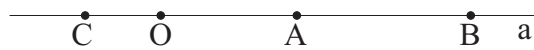

b)



Figure 1.155: Illustration for proof of T 1.3.30.

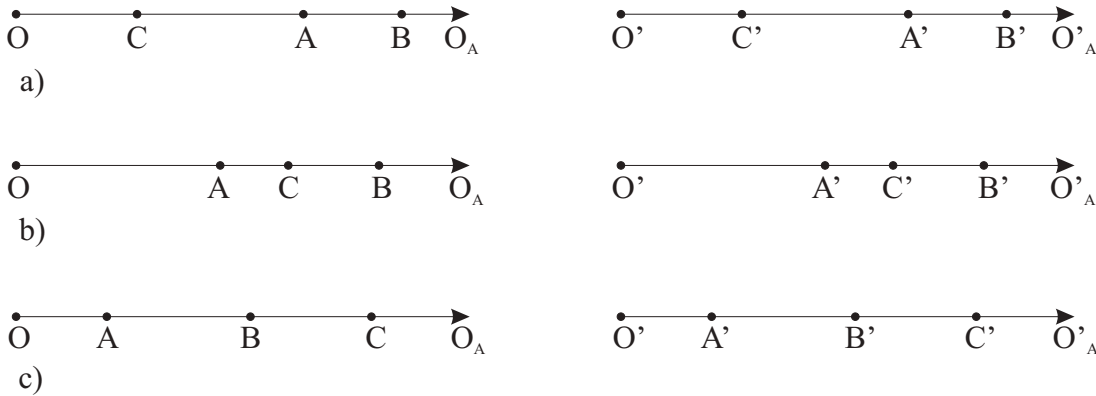

Figure 1.156: Isometries transform rays into rays.

Isometries of Collinear Figures

Corollary 1.3.30.1. *Isometries transform rays into rays. If a ray O_A is transformed into $O'_{A'}$ then O maps into O' .*

Proof. Taking a point B such that $[OAB]$,⁴¹¹ using A 1.3.1, we can choose O' with the properties $[O'A'B']$ (i.e., $O' \in A'^c_{B'}$), $OA \equiv O'A'$, where $A' = f(A)$, $B' = f(B)$, f being a given isometry. Suppose now C is an arbitrary point on the ray O_A , distinct from A , B . Denote $C' = f(C)$.⁴¹² We have $C \in O_A = O_B \& C \neq A \& CneB \xrightarrow{T1.2,15} C \in (OA) \vee C \in (AB) \vee C \in B^c_A$.

Consider first the case when $[OCA]$ (see Fig. 1.156, a)). We have then $[OCA] \& [OAB] \xrightarrow{L1.2,3,2} [CAB]$. By congruence we can write $[CAB] \& AB \equiv A'B' \& BC \equiv B'C' \& AC \equiv A'C' \xrightarrow{L1.3,29,2} [C'A'B']$. Also, we have $[O'A'B'] \& [C'A'B'] \xrightarrow{L1.2,11,16} O' \in B'_{A'} \& C' \in B'_{A'}$. Hence $[OCA] \& OA \equiv O'A' \& AC \equiv A'C' \& O' \in A'^c_{B'} \& C' \in A'^c_{B'} \xrightarrow{L1.3,9,1} [O'C'A'] \& OC \equiv O'C' \xrightarrow{L1.2,11,13} C' \in O'_{A'}$.

Now we turn to the case when $[ACB]$ (see Fig. 1.155, b)). Note that this implies $[OAB] \& [ACB] \xrightarrow{L1.2,3,2} [OAC]$. By congruence we can write $[ACB] \& AB \equiv A'B' \& BC \equiv B'C' \& AC \equiv A'C' \xrightarrow{L1.3,29,2} [A'C'B']$. Hence $[O'A'B'] \& [A'B'C'] \xrightarrow{L1.2,3,2} [O'A'C'] \xrightarrow{L1.2,11,16} C' \in O'_{A'}$.

Finally, suppose $C \in B^c_A$, i.e. $[ABC]$ (see Fig. 1.155, c)). Note that this implies $[OAB] \& [ABC] \xrightarrow{L1.2,3,1} [OAC]$. By congruence we can write $[ABC] \& AB \equiv A'B' \& BC \equiv B'C' \& AC \equiv A'C' \xrightarrow{L1.3,29,2} [A'B'C']$. Hence $[O'A'B'] \& [A'B'C'] \xrightarrow{L1.2,3,1} [O'A'C'] \xrightarrow{L1.2,11,16} C' \in O'_{A'}$.

Furthermore, in the last two cases we can write $[OAC] \& [O'A'C'] \& OA \equiv O'A' \& AC \equiv A'C' \xrightarrow{P1.3,9,3} OC \equiv O'C'$.

Thus, we have shown that $C \in O_A$ implies $C' \in O'_{A'}$, where $C' = f(C)$. This fact can be written down as $f(O_A) \subset O'_{A'}$. Also, we have $OC \equiv O'C'$, where $C' = f(C)$.

To show that $f(O) = O'$ denote $O'' = f(O)$ (now we assume that the domain of f includes O). f being an isometry, we have $[OAB] \& OA \equiv O''A' \& OB \equiv O''B' \& AB \equiv A'B' \xrightarrow{L1.3,29,2} [O''A'B']$. $[O'A'B'] \& [O''A'B'] \xrightarrow{L1.2,15,2} O' \in A'^c_{B'} \& O'' \in A'^c_{B'}$. Hence by T 1.3.1 $O'' = O'$.

To show that $f(O_A) = O'_{A'}$ we need to prove that for all $C' \in O'_{A'}$ there exists $C \in O_A$ such that $f(C) = C'$. To achieve this, given $C' \in O'_{A'}$ it suffices to choose (using A 1.3.1) $C \in O_A$ so that $OC \equiv O'C'$. Then C' will coincide with $f(C)$ (this follows from T 1.3.1 and the arguments given above showing that $OC \equiv O'f(C)$ for any $C \in O_A$.)

□

Corollary 1.3.30.2. *Isometries transform open intervals into open intervals. If an open interval (AB) is transformed into an open interval $(A'B')$ then A maps into one of the ends of the interval $A'B'$, and B maps into its other end.*

Proof. Let C, D be two points on the open interval (AB) (see T 1.2.8). Without loss of generality we can assume that $[ACD]$.⁴¹³ Then $[ACD] \& [ADB] \xrightarrow{L1.2,3,2} [CDB] \& [ACB]$. Thus, the points A, B, C, D are in the order $[ACDB]$. Suppose f is a given isometry. We need to prove that the image of the open interval (AB) under f is an open interval. Denote $C' = f(C)$, $D' = f(D)$. Using A 1.3.1, choose points $A' \in C'^c_{D'}$, $B' \in D'^c_{C'}$ (in view of L 1.2.15.2 this means that $[A'C'D']$, $[C'D'B']$, respectively) such that $AC \equiv A'C'$, $DB \equiv D'B'$. Note that $[A'C'D'] \& [C'D'B'] \xrightarrow{L1.2,3,1} [A'C'B'] \& [A'D'B']$. In order to prove that the open interval $(A'B')$ is the image (AB) we need to show that $\forall P \in (AB) f(P) \in (A'B')$. Denote $P' = f(P)$. We have $P \in (AB) \& P \neq$

⁴¹¹Note that, obviously, $[OAB] \Rightarrow B \in O_A$ (see L 1.2.11.16).

⁴¹²Since the points A, B, C are, obviously, collinear, by T 1.2.2 one of them lies between the two others. Using L 1.2.30.1 it will be shown that the points A', B', C' are in the same lexicographic order as A, B, C . That is, $[ABC]$ implies $[A'B'C']$, $[CAB]$ implies $[C'A'B']$, ACB implies $[A'C'B']$.

⁴¹³By P 1.2.3.4 we have either $[ACD]$ or $[ADC]$. In the latter case we can simply rename $C \rightarrow D, D \rightarrow C$.

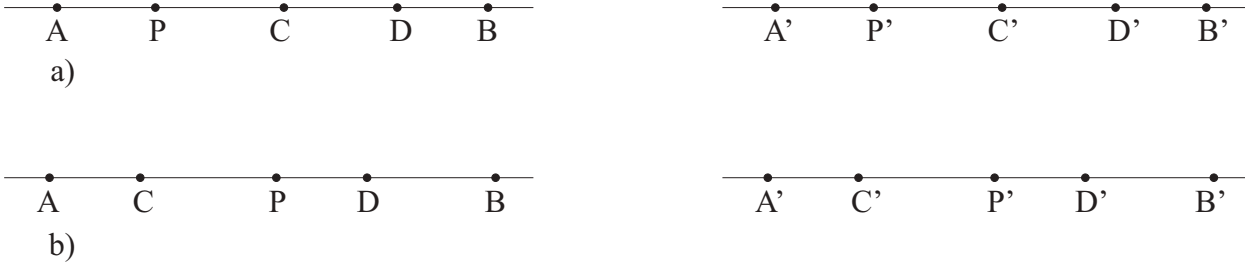

Figure 1.157: Illustration for proof of C 1.3.30.2.

$A \& P \neq C \& P \neq D \xrightarrow{L1.2.7.7} P \in (AC) \vee P \in (CD) \vee P \in (DB)$. Suppose first $P \in (AC)$ (see Fig. 1.157, a)). Then $[ACD] \& [APC] \xrightarrow{L1.2.3.2} [PCD]$. Since f is a motion, we can write $[PCD] \& PC \equiv P'C' \& CD \equiv C'D' \& PD \equiv P'D' \xrightarrow{L1.3.29.2} [P'C'D']$. $[A'C'D'] \& [P'C'D'] \xrightarrow{L1.2.15.2} A' \in C'_D \& P' \in C'_D$. $[APC] \& A' \in C'_D \& P' \in C'_D \& AC \equiv A'C' \& CP \equiv C'P' \xrightarrow{L1.3.9.1} [A'P'C'] \& AP \equiv A'P'$. $[A'P'C'] \& [A'C'B'] \xrightarrow{L1.2.3.2} [A'P'B']$. Suppose now $P \in (CD)$ (see Fig. 1.157, b)). f being a motion, we have $[CPD] \& CP \equiv C'P' \& PD \equiv P'D' \& CD \equiv C'D' \xrightarrow{L1.3.29.2} [C'P'D']$. $[C'P'D'] \& C' \in (A'B') \& D' \in (A'B') \xrightarrow{T1.2.3} P' \in (A'B')$. $[A'C'D'] \& [C'P'D'] \xrightarrow{L1.2.3.2} [A'C'P']$. $[ACP] \& [A'C'P'] \& AC \equiv A'C' \& CP \equiv C'P' \xrightarrow{L1.3.9.1} AP \equiv A'P'$. With the aid of the substitutions $A \rightarrow B, B \rightarrow A, C \rightarrow D, D \rightarrow C, A' \rightarrow B', B' \rightarrow A', C' \rightarrow D', D' \rightarrow C'$ we can show that the congruence $BP \equiv B'P'$ holds in this case as well.⁴¹⁴ Finally, for $[DPB]$ we can show that $P' \in (A'B')$ using the substitutions $A \rightarrow B, B \rightarrow A, C \rightarrow D, D \rightarrow C, A' \rightarrow B', B' \rightarrow A', C' \rightarrow D', D' \rightarrow C'$, and our result for the case $[APC]$.⁴¹⁵

Making the substitutions $A \rightarrow B, C \rightarrow D, D \rightarrow C, A' \rightarrow B', C' \rightarrow D', D' \rightarrow C', A'' \rightarrow B''$, we find that $f(B) = B'$.⁴¹⁷

To show that $f(AB) = (A'B')$ we need to prove that for all $P' \in (A'B')$ there exists $P \in (AB)$ such that $f(P) = P'$.

To achieve this, given $P' \in (A'B')$ it suffices to choose (using C 1.3.9.2) $P \in (AB)$ so that $AP \equiv A'P'$. Then P' will coincide with $f(P)$ (this follows from T 1.3.1 and the arguments given above showing that $AP \equiv A'f(P)$ for any $P \in (AB)$). \square

Corollary 1.3.30.3. *Isometries transform half-open (half-closed) intervals into half-open (half-closed) intervals.*

Proof. \square

Corollary 1.3.30.4. *Isometries transform closed intervals into closed intervals.*

Proof. \square

General Notion of Symmetry

Some general definitions are in order.⁴¹⁸ Consider an arbitrary set \mathcal{M} .⁴¹⁹ A function $f : \mathcal{M} \rightarrow \mathcal{M}$, mapping the set \mathcal{M} onto itself, will be referred to as a transformation of the set \mathcal{M} . Given a subset $\mathcal{A} \subset \mathcal{M}$ of the set \mathcal{M} , a transformation f of \mathcal{M} is called a symmetry transformation, or a symmetry element, of the set \mathcal{A} iff it has the following properties:

Property 1.3.6. *The function f transforms elements of the set \mathcal{A} into elements of the same set, i.e. $\forall x \in \mathcal{A} f(x) \in \mathcal{A}$.*

⁴¹⁴In fact, making the substitutions indicated above, we write: $[B'D'C'] \& [D'P'C'] \xrightarrow{L1.2.3.2} [B'D'P']$. $[BDP] \& [B'D'P'] \& BD \equiv B'D' \& DP \equiv D'P' \xrightarrow{L1.3.9.1} BP \equiv B'P'$.

⁴¹⁵To make our arguments more convincing, we write down the results of the substitutions explicitly: Suppose $P \in (BD)$. Then $[BDC] \& [BPD] \xrightarrow{L1.2.3.2} [PDC]$. Since f is a motion, we can write $[PDC] \& PD \equiv P'D' \& DC \equiv D'C' \& PC \equiv P'C' \xrightarrow{L1.3.29.2} [P'D'C']$. $[B'D'C'] \& [P'D'C'] \xrightarrow{L1.2.15.2} B' \in D'_C \& P' \in D'_C$. $[BPD] \& B' \in D'_C \& P' \in D'_C \& BD \equiv B'D' \& DP \equiv D'P' \xrightarrow{L1.3.9.1} [B'P'D'] \& BP \equiv B'P'$. $[B'P'D'] \& [B'D'A'] \xrightarrow{L1.2.3.2} [B'P'A']$.

Thus, we have shown that $P \in (AB)$ implies $P' \in (A'B')$, where $P' = f(P)$. This fact can be written down as $f(AB) \subset (A'B')$. Also, we have $AP \equiv A'P', BP \equiv B'P'$, where $P' = f(P)$.

To show that $f(A) = A'$ denote $A'' = f(A)$ (now we assume that the domain of f includes A).⁴¹⁶ f being an isometry, we have $[ACD] \& AC \equiv A''C' \& AD \equiv A''D' \& CD \equiv C'D' \xrightarrow{L1.3.29.2} [A''C'D']$. $[A'C'D'] \& [A''C'D'] \xrightarrow{L1.2.15.2} A' \in C'_D \& A'' \in C'_D$. Hence by T 1.3.1 $A'' = A'$.

⁴¹⁷To show that $f(B) = B'$ denote $B'' = f(B)$ (now we assume that the domain of f includes B). f being an isometry, we have $[BDC] \& BD \equiv B''D' \& BC \equiv B''C' \& DC \equiv D'C' \xrightarrow{L1.3.29.2} [B''D'C']$. $[B'D'C'] \& [B''D'C'] \xrightarrow{L1.2.15.2} B' \in D'_C \& B'' \in D'_C$. Hence by T 1.3.1 $B'' = B'$.

⁴¹⁸In volume 1 we reiterate some of the material presented here in small print. This is done for convenience of the reader and to make exposition in each volume more self-contained.

⁴¹⁹Generally speaking, \mathcal{M} need not be a set of points or any other geometric objects. However, virtually all examples of \mathcal{M} we will encounter in this volume will be point sets, also referred to as geometric figures.

Property 1.3.7. f transforms distinct elements of \mathcal{A} into distinct elements of this set, i.e. $x_1 \neq x_2 \Rightarrow f(x_1) \neq f(x_2)$, where $x_1, x_2 \in \mathcal{A}$.⁴²⁰

Property 1.3.8. Every element y of \mathcal{A} is an image of some element x of this set: $\forall y \in \mathcal{A} \exists x \in \mathcal{A} y = f(x)$.⁴²¹

If f is a symmetry element of \mathcal{A} , we also say that \mathcal{A} is symmetric with respect to (or symmetric under) the transformation \mathcal{A} . Let $S_0(\mathcal{A})$ be the set of all symmetry elements of \mathcal{A} . Define multiplication on $S_0(\mathcal{A})$ by $\psi \circ \varphi(x) = \psi(\varphi(x))$, where $\psi, \varphi \in S_0$. Then $(S_0(\mathcal{A}), \circ)$ is a group⁴²² with identity function as the identity element, and inverse functions as inverse elements. We call this group the full symmetry group of \mathcal{A} . However, the full symmetry group is so broad as to be practically useless. Therefore, for applications to concrete problems, we need to restrict it as outlined below. Let $S(\mathcal{A})$ be the set of all elements of $S_0(\mathcal{A})$, satisfying conditions C_1, C_2, \dots , so that for each condition C_i the following properties hold:

1. If $\varphi(x)$ and $\psi(x)$ satisfy the condition C_i then their product $\psi(x) \circ \varphi(x)$ also satisfies this condition;
2. If $\varphi(x)$ satisfies the condition C_i , then its inverse function $(\varphi(x))^{-1}$ also satisfies this condition.

Thus $(S(\mathcal{A}), \circ)$ forms a subgroup of the full symmetry group and is also termed a (partial) symmetry⁴²³ group.

With these definitions, we immediately obtain the following simple, but important theorems.

Theorem 1.3.31. If the object \mathcal{A} is a (set-theoretical) union of objects $A_\alpha, \alpha \in \mathcal{A}$, its symmetry group contains as a subgroup the intersection of the groups of symmetry of all objects A_α . This can be written as

$$S\left(\bigcup_{\alpha \in \mathcal{A}} A_\alpha\right) \supset \bigcap_{\alpha \in \mathcal{A}} S(A_\alpha) \quad (1.1)$$

Proof. Let $f \in \bigcap_{\alpha \in \mathcal{A}} S(A_\alpha)$ and $x \in \bigcup_{\alpha \in \mathcal{A}} A_\alpha$. Then $\exists \alpha_0$ such that $x \in A_{\alpha_0}$. Because $f \in S(A_{\alpha_0})$, we have $f(x) \in A_{\alpha_0}$, whence $f(x) \in \bigcup_{\alpha \in \mathcal{A}} A_\alpha$ and therefore $f \in S\left(\bigcup_{\alpha \in \mathcal{A}} A_\alpha\right)$. If $y \in \bigcup_{\alpha \in \mathcal{A}} A_\alpha$, since $y \in A_{\alpha_0}$ and $f \in S(A_{\alpha_0})$, there exists $x \in A_{\alpha_0}$ such that $y = f(x)$. Therefore, for every $y \in \bigcup_{\alpha \in \mathcal{A}} A_\alpha$ we can find $x \in \bigcup_{\alpha \in \mathcal{A}} A_\alpha$ such that $y = f(x)$. \square

Theorem 1.3.32. If the object \mathcal{A} is a (set-theoretical) union of objects $A_\alpha, \alpha \in \mathcal{A}$, and all its symmetry transformations f satisfy $f(A_\alpha) \cap A_\beta = \emptyset$, where $\alpha \neq \beta, \alpha, \beta \in \mathcal{A}$, then

$$S\left(\bigcup_{\alpha \in \mathcal{A}} A_\alpha\right) = \bigcap_{\alpha \in \mathcal{A}} S(A_\alpha) \quad (1.2)$$

Proof. Given the condition of the theorem, we need to prove that

$$S\left(\bigcup_{\alpha \in \mathcal{A}} A_\alpha\right) \subset \bigcap_{\alpha \in \mathcal{A}} S(A_\alpha) \quad (1.3)$$

Let $f \in S\left(\bigcup_{\alpha \in \mathcal{A}} A_\alpha\right)$ and $x \in A_{\alpha_0}, \alpha_0 \in \mathcal{A}$. Then $x \in \bigcup_{\alpha \in \mathcal{A}} A_\alpha$ and therefore $f(x) \in \bigcup_{\alpha \in \mathcal{A}} A_\alpha$. But since $f(A_\alpha) \cap A_\beta = \emptyset$, where $\alpha \neq \beta, \alpha, \beta \in \mathcal{A}$, we have $f(x) \in A_{\alpha_0}$. If $y \in A_{\alpha_0} \subset \bigcup_{\alpha \in \mathcal{A}} A_\alpha$, there exists $x \in \bigcup_{\alpha \in \mathcal{A}} A_\alpha$ such that $y = f(x)$. Then $x \in A_{\alpha_0}$, because otherwise $x \in A_\beta$, where $\alpha_0 \neq \beta$, and $f(x) \in A_\beta \cap A_{\alpha_0} = \emptyset$ - a contradiction. Since the choice of $\alpha_0 \in \mathcal{A}$ was arbitrary, we have proven that $f \in \bigcap_{\alpha \in \mathcal{A}} S(A_\alpha)$. \square

In what follows, we shall usually refer to transformations on a line a , i.e. functions $\mathcal{P}_a \rightarrow \mathcal{P}_a$ (transformations on a plane α , i.e. functions $\mathcal{P}_\alpha \rightarrow \mathcal{P}_\alpha$; transformations in space, i.e. functions $\mathcal{C}^{Pt} \rightarrow \mathcal{C}^{Pt}$) as line transformations (plane transformations; spatial, or space transformations).

For convenience we denote the identity transformation (the transformation sending every element of the set into itself: $x \mapsto x$ for all $x \in \mathcal{M}$.) of an arbitrary set \mathcal{M} by $\text{id}\mathcal{M}$, or simply id when \mathcal{M} is assumed to be known from context or not relevant.

Given a point O on a line a , define the transformation $f = \text{refl}_{(a,O)}$ of the set \mathcal{P}_a of the points of the line a , as follows: For $A \in \mathcal{P}_a \setminus \{O\}$ we choose, using A 1.3.1, $A' \in O_A^c$ so that $OA \equiv OA'$, and let, by definition, $f(A) \doteq A'$. Finally, we let $f(O) \doteq O$. This transformation is called the reflection of (the points of) the line a in the point O .

Observe that, of the two rays into which the point O separates the line a , the reflection of the set of points of a in O transforms the first ray into the second ray and the second into the first.

Theorem 1.3.33. Given a set of at least two points⁴²⁴ \mathcal{A} on a line a and a point O' on a line a' , there are at most two figures on a' congruent to \mathcal{A} and containing the point O' . To be precise, there is exactly one figure \mathcal{A}' if it is symmetric under the transformation of reflection in the point O' . There are two figures $\mathcal{A}', \mathcal{A}''$, both containing O' and congruent to \mathcal{A} when \mathcal{A}' (and then, of course, also \mathcal{A}'') is not symmetric under the reflection in O' .

Proof. \square

Lemma 1.3.33.1. The reflection of a line a in a point O is a bijection.

⁴²⁰Obviously, Pr 1.3.7 means that the restriction of f on \mathcal{A} is an injection.

⁴²¹Obviously, Pr 1.3.8 means that the restriction of f on \mathcal{A} is a surjection.

⁴²²Obviously, a combination of any two symmetry transformations is again a symmetry transformation, and this composition law is associative

⁴²³Except as in this definition, we will virtually never use the word partial when speaking about these symmetry groups, since in practice we will encounter only such groups, and almost never deal with S_0 -type (unrestricted) groups.

⁴²⁴It is evident that we need to have at least two points in the set \mathcal{A} to be able to speak about congruence. In the future we may choose to omit obvious conditions of this type.

Proof. Obvious from A 1.3.1, T 1.3.1, T 1.3.2. \square

Lemma 1.3.33.2. *The reflection of a line a in a point O preserves distances between points. That is, the reflection of a line a in a point O is an isometry.*

Proof. We need to show that $AB \equiv A'B'$, where $A' \equiv \text{refl}_{(a,O)}(A)$, $B' \equiv \text{refl}_{(a,O)}(B)$ for all points $A \in a$, $B \in a$. In the case where one of the points A , B coincides with O this is already obvious from the definition of the reflection transformation.

Suppose now that the points O , A , B are all distinct. Then from T 1.2.2 we have either $[AOB]$, or $[OAB]$, or $[OBA]$.

Assuming the first of these variants, we can write using the definition of reflection $[AOB] \& [A'OB'] \& OA \equiv OA' \& OB \equiv OB' \xrightarrow{A1.3.3} AB \equiv A'B'$.

Suppose now that $[OAB]$. Then $[OAB] \& B' \in O'A' \& OA \equiv OA' \& OB \equiv OB' \xrightarrow{L1.3.9.1} AB \equiv A'B' \& [O'A'B']$.
425 \square

Lemma 1.3.33.3. *Double reflection of the same line a in the same point O (i.e. a composition of this reflection with itself) is the identity transformation, i.e. $\text{refl}_{(a,O)}^2 = \text{id}$.⁴²⁶*

Proof. \square

Lemma 1.3.33.4. *The point O is the only fixed point of the reflection of the line a in O .*

Proof. \square

Lemma 1.3.33.5. *The reflection of a line a in a point O is a sense-reversing transformation.*

Proof. In view of L 1.2.13.4 we can assume without loss of generality that O is the origin with respect to which the given order on a is defined. The result then follows in a straightforward way from the definition of order on the line a and the trivial details are left to the reader to work out.⁴²⁷ \square

Theorem 1.3.34. *Proof.* \square

Given a line a on a plane α , define the transformation $f = \text{refl}_{(\alpha,a)}$ of the set \mathcal{P}_α of the points of the plane α , as follows: For $A \in \mathcal{P}_\alpha \setminus \mathcal{P}_a$ we choose, using A 1.3.1, $A' \in O_A^c$ so that $OA \equiv OA'$, where O is the foot of the perpendicular lowered from A to a (this perpendicular exists according to L 1.3.8.1), and let, by definition, $f(A) \equiv A'$. Finally, we let $f(P) \equiv P$ for any $P \in a$.

This transformation is called the reflection of (the points of) the plane α in the line a .

Lemma 1.3.34.1. *The reflection of a plane α in a line a is a bijection.*

Proof. \square

Lemma 1.3.34.2. *The reflection of a plane α in a line a preserves distances between points. That is, the reflection of a plane α in a line a is an isometry.*

Proof. \square

Lemma 1.3.34.3. *Double reflection of the same plane α in the same line a (i.e. a composition this reflection with itself) is the identity transformation, i.e. $\text{refl}_{(\alpha,a)}^2 = \text{id}$.⁴²⁸*

Proof. \square

Lemma 1.3.34.4. *The set \mathcal{P}_a is the maximum fixed set of the reflection of the line α in the line a .*

Proof. \square

Theorem 1.3.34. *Consider a non-collinear point set \mathcal{A} , points $A, B \in \mathcal{A}$, and points A', B', C' such that $AB \equiv A'B'$ and $C' \notin a_{A'B'}$. Then there are at most four figures \mathcal{A}' containing A', B' , lying in the plane $\alpha_{A'B'C'}$ and such that $\mathcal{A} \equiv \mathcal{A}'$. Given one such figure \mathcal{A}' the remaining figures are obtained by reflection in the line $a_{A'B'}$, by reflection in the line drawn through the midpoint M' of $A'B'$ perpendicular to it, and by the combination of the two reflections (this combination is reflection in M').*

⁴²⁵Since A, B lie on a on the same side of O but (by definition of reflection) A, A' as well as B, B' lie on opposite sides of O , using L 1.2.17.9, L 1.2.17.10 we see that A', B' lie on the same side of O .

⁴²⁶In other words, a reflection of a line a in a point O coincides with its inverse function.

⁴²⁷Suppose $A < B$ on a . Denote $A' \equiv \text{refl}_{(a,O)}(A)$, $B' \equiv \text{refl}_{(a,O)}(B)$. We need to show that $B' < A'$ on a . Suppose that A, B both lie on the first ray (see p. 22). The definition of order on a then tells us that $[ABO]$. This, in turn, implies that $[OB'A']$. (This can be seen either directly, using L 1.3.9.1 and the observation that the points A', B' lie on the same side of O (both A', B' lie on the opposite side of O from A, B), or using L 1.3.33.2, L 1.3.29.2.) We see that B' precedes A' on the second ray, and thus on the whole line a . Most of the other cases to consider are even simpler. For example, if A lies on the first ray and B on the second ray, then, evidently, A' lies on the second ray, and B' on the first ray. Hence $B' < A'$ in this case.

⁴²⁸In other words, a reflection of a plane α in a line a coincides with its inverse function.

Proof. \square

Theorem 1.3.36. *Motion preserves angles. That is, if a figure \mathcal{A} is congruent to a figure \mathcal{B} , the angle $\angle A_1A_2A_3$ formed by any three non-collinear points $A_1, A_2, A_3 \in \mathcal{A}$ of the first figure is congruent to the angle formed by the corresponding three points B_1, B_2, B_3 of the second figure, i.e. $\angle A_1A_2A_3 \equiv \angle B_1B_2B_3$, where $B_i = \phi(A_i)$ (ϕ being the motion), $i = 1, 2, 3$.*

Proof. By hypothesis, the points A_1, A_2, A_3 are not collinear. Neither are B_1, B_2, B_3 (see C 1.3.29.3). Since $\phi \mathcal{A} \rightarrow \mathcal{B}$ is a motion, we can write $A_1A_2 \equiv B_1B_2$, $A_1A_3 \equiv B_1B_3$, $A_2A_3 \equiv B_2B_3$, whence by T 1.3.10 $\triangle A_1A_2A_3 \equiv \triangle B_1B_2B_3$, which implies $\angle A_1A_2A_3 \equiv \angle B_1B_2B_3$, q.e.d. \square

Theorem 1.3.37. *Suppose we are given:*

- A figure \mathcal{A} lying in plane α and containing at least three non-collinear points;
- A line $a \subset \alpha$, containing a point O of \mathcal{A} and a point A (not necessarily lying in \mathcal{A});
- A point E lying in plane α not on a ;
- Two distinct points O', A' on a line a' lying in a plane α' , and a point E' lying in α' not on a' .

Then there exists exactly one motion $f : \mathcal{A} \rightarrow \mathcal{A}'$ and, correspondingly, one figure \mathcal{A}' , such that:

1. $O' = f(O)$.
2. If A, B lie on line a on the same side (on opposite sides) of the point O , then the points A' and $B' = f(B)$ also lie on line a' on the same side (on opposite sides) of the point O' .
3. If E, F lie in plane α on the same side (on opposite sides) of the line a , then the points E' and $F' = f(F)$ also lie (in plane α') on the same side (on opposite sides) of the line a' .⁴²⁹

Proof. 1, 2 are proved exactly as in T 1.3.30.⁴³⁰ Thus, we have constructed the restriction of f to $\mathcal{A} \cap \mathcal{P}_a$, which is itself a motion (see proof of T 1.3.30). Suppose now $F \in \mathcal{A}$, $F \notin a$. Using A 1.3.4, A 1.3.1, construct a point F' such that $F' \in \alpha'$, $F' \notin a'$, $\angle AOF \equiv \angle A'O'F'$, $OF \equiv O'F'$, and, finally, if E, F lie in plane α on one side (on opposite sides) of the line a , then E', F' lie in plane α' on one side (on opposite sides) of the line a' .⁴³¹ (See Fig. 1.158, a.) We set, by definition, $f(F) = F'$. For the case $B \in O_A$, $B' \in O'_{A'}$ we have by L 1.2.11.3 $O_B = O_A$, $O'_{B'} = O'_{A'}$, whence $\angle AOF = \angle BOF$, $\angle A'O'F' = \angle B'O'F'$. Thus, we have $\angle BOF \equiv \angle B'O'F'$. Recall that also $OB \equiv O'B'$, where $B \in O_A \cap \mathcal{A}$, $B' \in O'_{A'} \cap \mathcal{A}'$, $B' = f(B)$, for, as we have shown above, the restriction of f to $\mathcal{A} \cap \mathcal{P}_a$ is itself a motion. Therefore, we obtain $OB \equiv O'B' \& OF \equiv O'F' \& \angle BOF \equiv \angle B'O'F' \xrightarrow{T1.3.4} \triangle BOF \equiv \triangle B'O'F' \Rightarrow BF \equiv B'F'$. Observe further, that $\angle AOF \equiv \angle A'O'F' \xrightarrow{T1.3.6} \text{adjsp} \angle AOF \equiv \text{adjsp} \angle A'O'F'$. If $C \in O_A$, i.e. if $[AOC]$ (see L 1.2.15.2), then $\angle COF = \text{adjsp} \angle AOF$. Similarly, $C' \in O'_{A'}$ implies $\angle C'O'F' = \text{adjsp} \angle A'O'F'$. Recall again that for points C, C' such that $C \in O_A \cap \mathcal{A}$, $C' \in O'_{A'} \cap \mathcal{A}'$, $C' = f(C)$, in view of the already established properties of line motion, we can write $OC \equiv O'C'$. Hence $OC \equiv O'C' \& OF \equiv O'F' \& \angle COF \equiv \angle C'O'F' \xrightarrow{T1.3.4} \triangle COF \equiv \triangle C'O'F' \Rightarrow CF \equiv C'F'$. Thus, we have proven that for all points $B \in \mathcal{P}_a \cap \mathcal{A}$ and all points $F \in \mathcal{P}_\alpha \setminus \mathcal{P}_a \cap \mathcal{A}$ we have $BF \equiv B'F' = f(B)f(F)$.

Suppose now $F \in \mathcal{P}_\alpha \setminus \mathcal{P}_a \cap \mathcal{A}$, $G \in \mathcal{P}_\alpha \setminus \mathcal{P}_a \cap \mathcal{A}$. We need to prove that always $FG \equiv F'G'$, where $F' = f(F) \in \mathcal{P}_{\alpha'} \setminus \mathcal{P}_{a'} \cap \mathcal{A}'$, $G' = f(G) \in \mathcal{P}_{\alpha'} \setminus \mathcal{P}_{a'} \cap \mathcal{A}'$. Consider first the case when the points F, O, G are collinear. Then either $G \in O_F$ or $G \in O'_F$. Suppose first $G \in O_F$. (See Fig. 1.158, b.) Then by L 1.2.11.3 $O_G = O_F$, whence $\angle AOF = \angle AOG$. In view of L 1.2.19.8 $G \in O_F$ implies that F, G lie in α on one side of a . We also have by construction above: $\angle AOF \equiv \angle A'O'F'$, $\angle AOG \equiv \angle A'O'G'$. Consider the case when E, F lie in α on one side of a . Then E, G also lie on the same side of a . In fact, otherwise $Efa \& EaG \xrightarrow{L1.2.17.10} FaG$, which contradicts our assumption that FGa . Since both E, F and E, G lie on one side of a , by construction the pairs E', F' and E', G' lie in α' on the same side of a' . And, obviously, by transitivity of the relation "to lie on one side", we have $F'G'a'$. Now turn to the case when E, F lie in α on opposite sides of a .⁴³² Then E, G also lie on opposite sides of a . In fact, otherwise $EaF \& EGa \xrightarrow{L1.2.17.10} FaG$, which contradicts our assumption that FGa . Since both E, F and E, G lie on opposite sides of a , by construction the pairs E', F' and E', G' lie in α' on opposite sides of a' . Hence $E'a'F' \& E'a'G' \xrightarrow{L1.2.17.9} F'G'a'$. Now we can write $\angle AOF \equiv \angle A'O'F' \& \angle AOG \equiv \angle A'O'G' \& \angle AOF = \angle AOG \& F'G'a' \xrightarrow{L1.3.2.1} O'_{F'} = O'_{G'} \Rightarrow G' \in O'_{F'}$. Thus, we have shown that once F, G lie on one side of O , the points F', G' lie on one side of O' . Suppose now $G \in O'_F$, i.e. $[FOG]$. In view of L 1.2.19.8 $G \in O'_F$ implies that F, G lie in α on opposite sides of a . We also have by construction above: $\angle AOF \equiv \angle A'O'F'$, $\angle AOG \equiv \angle A'O'G'$. Consider the case when E, F lie in α on one side of a . Then E, G lie on opposite sides of a . (See Fig. 1.158, c.) In fact, otherwise transitivity of the relation "to lie on one side of a line" would give $Efa \& EGa \Rightarrow FaG$, which contradicts our assumption that FGa . Since E, F lie in α on one side of a and E, G lie on opposite sides of a , by construction it follows that the points E', F' lie in α' on one side of a' and E', G' lie on opposite sides of a' . Hence $E'F'a' \& E'a'G' \xrightarrow{L1.2.17.10} F'a'G'$. Now turn to the case when E, F lie in α on opposite sides of a . Then E, G lie on one side of a . In fact, otherwise $EaF \& EaG \xrightarrow{L1.2.17.9} FGa$, which contradicts our assumption that FGa . Since E, F

⁴²⁹That is, for $F \in \mathcal{A}$ if $F \in a_E$ then $F' \in a'_{E'}$ and $F \in a'_E$ implies $F' \in a'_{E'}$.

⁴³⁰We set, by definition, $f(O) \stackrel{\text{def}}{=} O'$. For $B \in O_A \cap \mathcal{A}$, using A 1.3.1, choose $B' \in O'_{A'}$ so that $OB \equiv O'B'$. Similarly, for $B \in O'_A \cap \mathcal{A}$, using A 1.3.1, choose $B' \in (O'_{A'})^c$ so that again $OB \equiv O'B'$. In both cases we let, by definition, $f(B) = B'$.

⁴³¹For $F \in a_E$ we let $F' \in a'_{E'}$ and for $F \in a'_E$ we let $F' \in a'_{E'}$.

⁴³²The reader is encouraged to draw for himself the figure for this case, as well as all other cases left unillustrated in this proof.

lie in α on opposite sides of a and E, G lie on one side of a , by construction the points E', F' lie in α' on opposite sides of a' and E', G' lie on one side of a' . Hence $E'a'F' \& E'G'a' \xrightarrow{L1.2.17.10} F'a'G'$. Now, using C 1.3.6.1,⁴³³ we can write $\angle AOF \equiv \angle A'O'F' \& \angle AOG \equiv \angle A'O'G' \& \angle AOG = \text{adjsp} \angle AOF \& F'a'G' \Rightarrow O'_{G'} = O'_{F'} \Rightarrow G' \in O'_{F'}$.

Thus, we conclude that in the case when the points F, O, G are collinear, either F, G lie on one side of O and F', G' lie on one side of O' , or F, G lie on opposite sides of O and F', G' lie on opposite sides of O' . Combined with the congruences (true by construction) $OF \equiv O'F', OG \equiv O'G'$, by P 1.3.9.3 this gives us $FG \equiv F'G'$.

Suppose now F, O, G are not collinear. Then, obviously, $O_G \neq O'_G$. We also know that if the points F, G lie in α on one side (on opposite sides) of a , the points F', G' lie in α' on one side (on opposite sides) of a' . (See Fig. 1.158, d), e).) Hence, taking into account $\angle AOF \equiv \angle A'O'F', \angle AOG \equiv \angle A'O'G'$, by T 1.3.9 we get $\angle FOG \equiv \angle F'O'G'$. Finally, we have $OF \equiv O'F' \& \angle FOG \equiv \angle F'O'G' \& OG \equiv O'G' \xrightarrow{T1.3.4} \triangle FOG \equiv \triangle F'O'G' \Rightarrow FG \equiv F'G'$, which completes the proof.

□

Lemma 1.3.37.1. *Isometries transform a cross into a cross.*⁴³⁴

Proof. □

Theorem 1.3.38. *Proof.* □

Denote by μAB the equivalence class of congruent intervals containing an interval AB . We define addition of classes of congruent intervals as follows: Take an element AB of the first class μAB and, using A 1.3.1, lay off the interval BC of the second class μBC into the ray B'_A , complementary to the ray A_B .⁴³⁵ Then the sum of the classes AB, BC is, by definition, the class μAC , containing the interval AC . Note that this addition of classes is well defined, for $AB \equiv A_1B_1 \& BC \equiv B_1C_1 \& [ABC] \& [A_1B_1C_1] \xrightarrow{L1.3.9.1} AC \equiv A_1C_1$, which implies that the result of summation does not depend on the choice of representatives in each class. Thus, put simply, we have $[ABC] \Rightarrow \mu AC = \mu AB + \mu BC$. Conversely, the notation $AC \in \mu_1 + \mu_2$ means that there is a point B such that $[ABC]$ and $AB \in \mu_1, BC \in \mu_2$. In the case when $\mu AB + \mu CD = \mu EF$ and $A'B' \equiv AB, C'D' \equiv CD, E'F' \equiv EF$ (that is, when $\mu AB + \mu CD = \mu EF$ and $A'B' \in \mu AB, C'D' \in \mu CD, E'F' \in \mu EF$), we can say, with some abuse of terminology, that the interval $E'F'$ is the sum of the intervals $A'B', C'D'$.

The addition (of classes of congruent intervals) thus defined has the properties of commutativity and associativity, as the following two theorems (T 1.3.39, T 1.3.40) indicate:

Theorem 1.3.39. *The addition of classes of congruent intervals is commutative: For any classes μ_1, μ_2 we have $\mu_1 + \mu_2 = \mu_2 + \mu_1$.*

Proof. Suppose $A'C' \in \mu_1 + \mu_2$. According to our definition of the addition of classes of congruent intervals this means that there is an interval AC such that $[ABC]$ and $AB \in \mu_1 = \mu AB, BC \in \mu_2 = \mu BC$. But the fact that $CB \in \mu_2 = \mu CB, BA \in \mu_1 = \mu BA, [CBA]$, and $A'C' \equiv CA$ implies $A'C' \in \mu_2 + \mu_1$. Thus, we have proved that $\mu_1 + \mu_2 \subset \mu_2 + \mu_1$ for any two classes μ_1, μ_2 of congruent intervals. By symmetry, we immediately have $\mu_2 + \mu_1 \subset \mu_1 + \mu_2$. Hence $\mu_1 + \mu_2 = \mu_2 + \mu_1$, q.e.d. □

Theorem 1.3.40. *The addition of classes of congruent intervals is associative: For any classes μ_1, μ_2, μ_3 we have $(\mu_1 + \mu_2) + \mu_3 = \mu_1 + (\mu_2 + \mu_3)$.*

Proof. Suppose $AD \in (\mu_1 + \mu_2) + \mu_3$. Then there is a point C such that $[ACD]$ and $AC \in \mu_1 + \mu_2, CD \in \mu_3$. In its turn, $AC \in \mu_1 + \mu_2$ implies that $\exists B [ABC] \& AB \in \mu_1 \& BC \in \mu_2$. We have $[ABC] \& [ACD] \xrightarrow{L1.2.3.2} [ABD] \& [BCD]$. Hence $[BCD] \& BC \in \mu_2 \& CD \in \mu_3 \Rightarrow BD \in \mu_2 + \mu_3$. $[ABD] \& AB \in \mu_1 \& BD \in \mu_2 + \mu_3 \Rightarrow AD \in \mu_1 + (\mu_2 + \mu_3)$. Thus, we have proved that $(\mu_1 + \mu_2) + \mu_3 \subset \mu_1 + (\mu_2 + \mu_3)$ for any classes μ_1, μ_2, μ_3 of congruent intervals. □

Once the associativity is established, a standard algebraic argumentation can be used to show that we may write $\mu_1 + \mu_2 + \dots + \mu_n$ for the sum of n classes $\mu_1, \mu_2, \dots, \mu_n$ of congruent intervals without needing to care about where we put the parentheses.

If a class μBC of congruent intervals is equal to the sum $\mu B_1C_1 + \mu B_2C_2 + \dots + \mu B_nC_n$ of classes $\mu B_1C_1, \mu B_2C_2, \dots, \mu B_nC_n$ of congruent intervals, and $\mu B_1C_1 = \mu B_2C_2 = \dots = \mu B_nC_n$ (that is, $B_1C_1 \equiv B_2C_2 \equiv \dots \equiv B_nC_n$), we write $\mu BC = n\mu B_1C_1$ or $\mu B_1C_1 = (1/n)\mu BC$.

Proposition 1.3.40.1. *If $\mu AB + \mu CD = \mu EF, A'B' \in \mu AB, C'D' \in \mu CD, E'F' \in \mu EF$, then $A'B' < E'F', C'D' < E'F'$.*

⁴³³Observing also that $F'a'G' \Rightarrow \angle A'O'G' = \text{adj} \angle A'O'F'$.

⁴³⁴A cross is a couple of intersecting lines (see definition on p. 4).

⁴³⁵In other words, we take the point $C \in B'_A$ (recall that $C \in B'_A$ means that $[ABC]$, see L 1.2.15.2) such that the interval BC lies in the second class, which we denote μBC . The notation employed here is perfectly legitimate: we know that $A_1B_1 \in \mu AB \Rightarrow A_1B_1 \equiv AB \Rightarrow \mu A_1B_1 = \mu AB$. In our future treatment of classes of congruent intervals we shall often resort to this convenient abuse of notation. Although we have agreed previously to use Greek letters to denote planes, we shall sometimes use the letter μ (possibly with subscripts) without the accompanying name of defining representative to denote congruence classes of intervals whenever giving a particular defining representative for a class is not relevant.

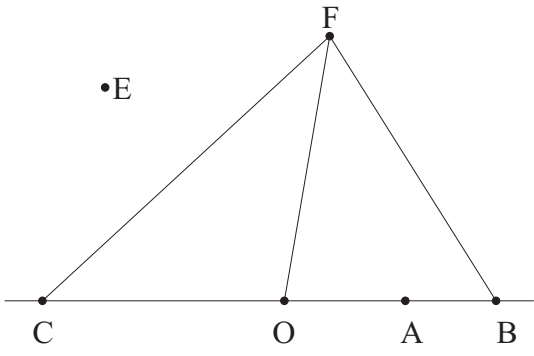

a)

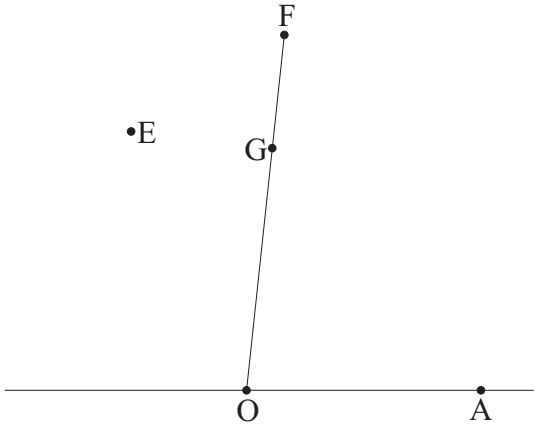
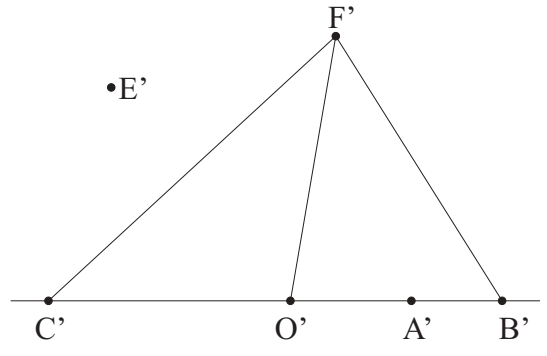

b)

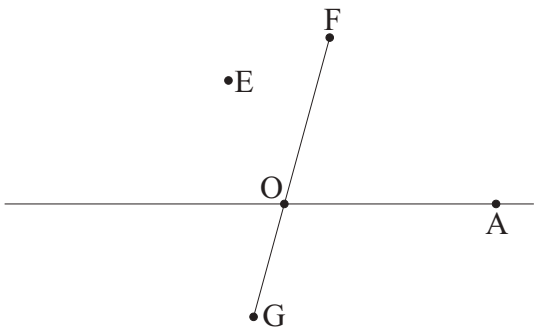
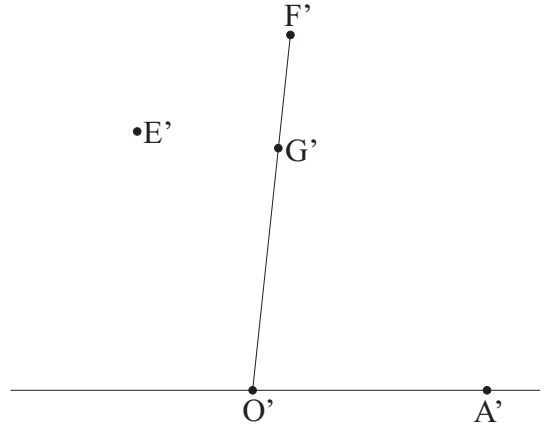

c)

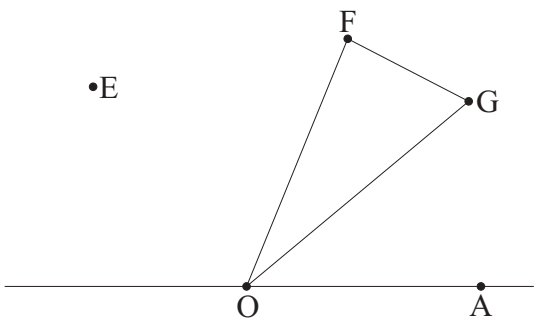
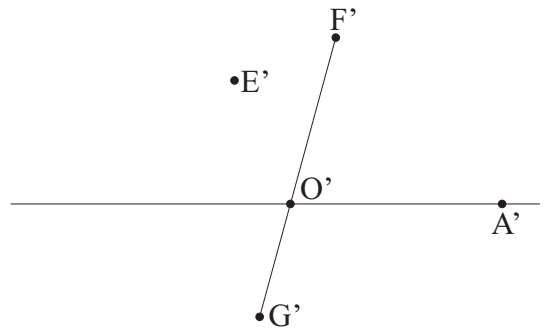

d)

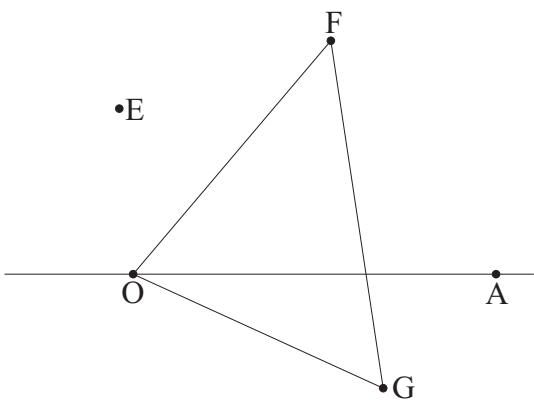
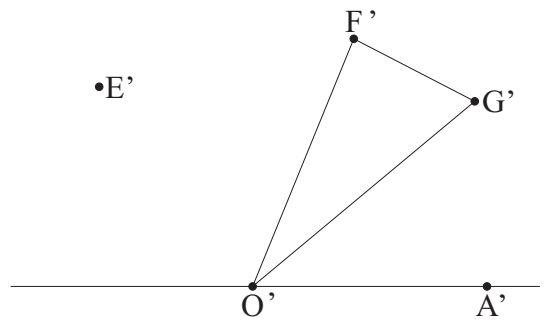

e)

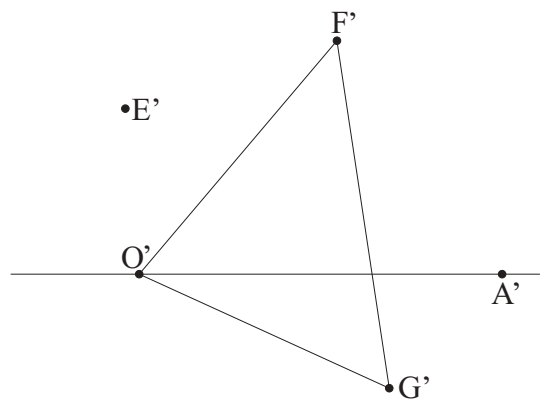

Proof. By the definition of addition of classes of congruent intervals, there are intervals $LM \in \mu AB$, $MN \in CD$, $LN \in EF$ such that $[LMN]$. By C 1.3.13.4 $LM < LN$. Finally, using T 1.3.1, L 1.3.13.6, L 1.3.13.7 we can write $A'B' \equiv AB \& LM \equiv AB \& E'F' \equiv EF \& LN \equiv EF \& LM < LN \Rightarrow A'B' < E'F'$. Similarly, $C'D' < E'F'$. \square

At this point we can introduce the following jargon. For classes μAB , μCD or congruent intervals we write $\mu AB < \mu CD$ or $\mu CD > \mu AB$ if there are intervals $A'B' \in \mu AB$, $C'D' \in \mu CD$ such that $A'B' < C'D'$. T 1.3.1, L 1.3.13.6, L 1.3.13.7 then show that this notation is well defined: it does not depend on the choice of the intervals $A'B'$, $C'D'$. For arbitrary classes μAB , μCD of congruent intervals we then have either $\mu AB < \mu CD$, or $\mu AB = \mu CD$, or $\mu AB > \mu CD$ (with the last inequality being equivalent to $\mu CD < \mu AB$). From L 1.3.13.11 we see also that any one of these options excludes the two others.

Proposition 1.3.40.2. *If $\mu AB + \mu CD = \mu EF$, $\mu AB + \mu GH = \mu LM$, and $CD < GH$, then $EF < LM$.* ⁴³⁶

Proof. By hypothesis, there are intervals $PQ \in \mu AB$, $QR \in \mu CD$, $P'Q' \in \mu AB$, $Q'R' \in \mu GH$, such that $[PQR]$, $[P'Q'R']$, $PR \in \mu EF$, $P'R' \in \mu LM$. Obviously, $PQ \equiv AB \& P'Q' \equiv AB \xrightarrow{T1.3.1} PQ \equiv P'Q'$. Using L 1.3.13.6, L 1.3.13.7 we can also write $QR \equiv CD \& CD < GH \& Q'R' \equiv GH \Rightarrow QR < Q'R'$. We then have $[PQR] \& [P'Q'R'] \& PQ \equiv P'Q' \& QR < Q'R' \xrightarrow{L1.3.21.1} PR < P'R'$. Finally, again using L 1.3.13.6, L 1.3.13.7, we obtain $PR \equiv EF \& PR < P'R' \& P'R' \equiv LM \Rightarrow EF < LM$. \square

Proposition 1.3.40.3. *If $\mu AB + \mu CD = \mu EF$, $\mu AB + \mu GH = \mu LM$, and $EF < LM$, then $CD < GH$.* ⁴³⁷

Proof. We know that either $\mu CD = \mu GH$, or $\mu GH < \mu CD$, or $\mu CD < \mu GH$. But $\mu CD = \mu GH$ would imply $\mu EF = \mu LM$, which contradicts $EF < LM$ in view of L 1.3.13.11. Suppose $\mu GH < \mu CD$. Then, using the preceding proposition (P 1.3.40.2), we would have $LM < EF$, which contradicts $EF < LM$ in view of L 1.3.13.10. Thus, we have $CD < GH$ as the only remaining possibility. \square

Proposition 1.3.40.4. *A class μBC of congruent intervals is equal to the sum $\mu B_1C_1 + \mu B_2C_2 + \dots + \mu B_nC_n$ of classes $\mu B_1C_1, \mu B_2C_2, \dots, \mu B_nC_n$ of congruent intervals iff there are points A_0, A_1, \dots, A_n such that $[A_{i-1}A_iA_{i+1}]$ for all $i \in \mathbb{N}_{n-1}$, $A_{i-1}A_i \in \mu B_iC_i$ for all $i \in \mathbb{N}_n$ and $A_0A_n \in \mu BC$.* ⁴³⁸

Proof. Suppose $\mu BC = \mu B_1C_1 + \mu B_2C_2 + \dots + \mu B_nC_n$. We need to show that there are points A_0, A_1, \dots, A_n such that $[A_{i-1}A_iA_{i+1}]$ for all $i \in \mathbb{N}_{n-1}$, $A_{i-1}A_i \equiv B_iC_i$ for all $i \in \mathbb{N}_n$, and $A_0A_n \equiv BC$. For $n = 2$ this has been established previously. ⁴³⁹ Suppose now that for the class $\mu_{n-1} = \mu B_1C_1 + \mu B_2C_2 + \dots + \mu B_{n-1}C_{n-1}$ there are points A_0, A_1, \dots, A_{n-1} such that $[A_{i-1}A_iA_{i+1}]$ for all $i \in \mathbb{N}_{n-2}$, $A_{i-1}A_i \in \mu B_iC_i$ for all $i \in \mathbb{N}_{n-1}$, and $A_0A_{n-1} \in \mu_{n-1}$. Using A 1.3.1, choose a point A_n such that $A_0A_n \equiv BC$ and the points A_{n-1}, A_n lie on the same side of the point A_0 . Since, by hypothesis, $\mu BC = \mu_{n-1} + \mu B_nC_n$, there are points D_0, D_{n-1}, D_n such that $D_0D_{n-1} \in \mu_{n-1}$, $D_{n-1}D_n \in \mu B_nC_n$, $D_0D_n \in \mu BC$, and $[D_0D_{n-1}D_n]$. Since $D_0D_{n-1} \in \mu_{n-1} \& A_0A_{n-1} \in \mu_{n-1} \Rightarrow D_0D_{n-1} \equiv A_0A_{n-1}$, $D_0D_n \in \mu BC \& A_0A_n \in \mu BC \Rightarrow D_0D_n \equiv A_0A_n$, $[D_0D_{n-1}D_n]$, and A_{n-1}, A_n lie on the same side of A_0 , by L 1.3.9.1 we have $D_{n-1}D_n \equiv A_{n-1}A_n$, $[A_0A_{n-1}A_n]$. By L 1.2.7.3 the fact that $[A_{i-1}A_iA_{i+1}]$ for all $i \in \mathbb{N}_{n-2}$ implies that the points A_0, A_1, \dots, A_{n-1} are in order $[A_0A_1 \dots A_{n-1}]$. In particular, we have $[A_0A_{n-2}A_{n-1}]$. Hence, $\& [A_0A_{n-1}A_n] \xrightarrow{L1.2.3.2} [A_{n-2}A_{n-1}A_n]$. Thus, we have completed the first part of the proof.

To prove the converse statement suppose that there are points A_0, A_1, \dots, A_n such that $[A_{i-1}A_iA_{i+1}]$ for all $i \in \mathbb{N}_{n-1}$, $A_{i-1}A_i \in \mu B_iC_i$ for all $i \in \mathbb{N}_n$ and $A_0A_n \in \mu BC$. We need to show that the class μBC of congruent intervals is equal to the sum $\mu B_1C_1 + \mu B_2C_2 + \dots + \mu B_nC_n$ of the classes $\mu B_1C_1, \mu B_2C_2, \dots, \mu B_nC_n$. For $n = 2$ this has been proved before. Denote μ_{n-1} the class containing the interval A_0A_{n-1} . Now we can assume that $\mu_{n-1} = \mu B_1C_1 + \mu B_2C_2 + \dots + \mu B_{n-1}C_{n-1}$. ⁴⁴⁰ Since the points A_0, A_1, \dots, A_n are in the order $[A_0A_1 \dots A_n]$ (see L 1.2.7.3), we have, in particular, $[A_0A_{n-1} \dots A_n]$. As also $A_0A_{n-1} \in \mu_{n-1}$, $A_{n-1}A_n \in \mu B_nC_n$, $A_0A_n \in \mu BC$, it follows that $\mu BC = \mu_{n-1} + \mu B_nC_n = \mu B_1C_1 + \mu B_2C_2 + \dots + \mu B_{n-1}C_{n-1} + \mu B_nC_n$, q.e.d. \square

Proposition 1.3.40.5. *For classes μ_1, μ_2, μ_3 of congruent intervals we have: $\mu_1 + \mu_2 = \mu_1 + \mu_3$ implies $\mu_2 = \mu_3$.*

Proof. We know that either $\mu_2 < \mu_3$, or $\mu_2 = \mu_3$, or $\mu_2 > \mu_3$. But by P 1.3.40.2 $\mu_2 < \mu_3$ would imply $\mu_1 + \mu_2 < \mu_1 + \mu_3$, and $\mu_2 > \mu_3$ would imply $\mu_1 + \mu_2 > \mu_1 + \mu_3$. But both $\mu_1 + \mu_2 < \mu_1 + \mu_3$ and $\mu_1 + \mu_2 > \mu_1 + \mu_3$ contradict $\mu_1 + \mu_2 = \mu_1 + \mu_3$, whence the result. \square

Proposition 1.3.40.6. *For any classes μ_1, μ_3 of congruent intervals such that $\mu_1 < \mu_3$, there is a unique class μ_2 of congruent intervals with the property $\mu_1 + \mu_2 = \mu_3$.*

Proof. Uniqueness follows immediately from the preceding proposition. To show existence recall that $\mu_1 < \mu_3$ in view of L 1.3.13.3 implies that there are points A, B, C such that $AB \in \mu_1$, $AC \in \mu_3$, and $[ABC]$. Denote $\mu_2 = \mu BC$. ⁴⁴¹

⁴³⁶This proposition can be formulated in more abstract terms for congruence classes μ_1, μ_2, μ_3 of intervals as follows: $\mu_2 < \mu_3$ implies $\mu_1 + \mu_2 < \mu_1 + \mu_3$.

⁴³⁷This proposition can be formulated in more abstract terms for congruence classes μ_1, μ_2, μ_3 of intervals as follows: $\mu_1 + \mu_2 < \mu_1 + \mu_3$ implies $\mu_2 < \mu_3$.

⁴³⁸That is, we have $A_{i-1}A_i \equiv B_iC_i$ for all $i \in \mathbb{N}_n$, and $A_0A_n \equiv BC$.

⁴³⁹See the discussion following the definition of addition of classes of congruent intervals.

⁴⁴⁰Observe that if the n points A_0, A_1, \dots, A_n are such that $[A_{i-1}A_iA_{i+1}]$ for all $i \in \mathbb{N}_{n-1}$, $A_{i-1}A_i \in \mu B_iC_i$ for all $i \in \mathbb{N}_n$, then all these facts remain valid for the $n - 1$ points A_0, A_1, \dots, A_{n-1} . Furthermore, we have $A_0A_{n-1} \in \mu_{n-1}$ from the definition of μ_{n-1} .

⁴⁴¹That is, we take μ_2 to be the class of congruent intervals containing the interval BC .

From the definition of sum of classes of congruent intervals then follows that $\mu_1 + \mu_2 = \mu_3$. \square

If $\mu_1 + \mu_2 = \mu_3$ (and then, of course, $\mu_2 + \mu_1 = \mu_3$ in view of T 1.3.39), we shall refer to the class μ_2 of congruent intervals as the difference of the classes μ_3, μ_1 of congruent intervals and write $\mu_2 = \mu_3 - \mu_1$. That is, $\mu_2 = \mu_3 - \mu_1 \stackrel{\text{def}}{\iff} \mu_1 + \mu_2 = \mu_3$. The preceding proposition shows that the difference of classes of congruent intervals is well defined.

With subtraction of classes of congruent intervals thus defined, the familiar rules of algebra apply, analogous to the corresponding properties of subtraction of natural numbers. For example, we have the following identities:

Proposition 1.3.40.7. $\mu_1 + (\mu_2 - \mu_3) = (\mu_1 - \mu_3) + \mu_2 = (\mu_1 + \mu_2) - \mu_3$ for any classes μ_1, μ_2, μ_3 of congruent intervals assuming, of course, that $\mu_2 > \mu_3$.

Proof. \square

Proposition 1.3.40.8. $\mu_1 - (\mu_1 - \mu_2) = \mu_2$ for any classes μ_1, μ_2 of congruent intervals assuming, of course, that $\mu_1 > \mu_2$.

Proof. \square

Proposition 1.3.40.9 (The Triangle Inequality). *Any side of a triangle is less than the sum of its other two sides. In other words, in a triangle $\triangle ABC$ we have $\mu AC < \mu AB + \mu BC$, etc.*

Proof. Follows from C 1.3.18.2. \square

A line a , meeting a plane α in the point O ,⁴⁴² is said to be perpendicular to α (at the point O) if it is perpendicular to any line b drawn in plane α through O . We will write this as $a \perp \alpha$, or sometimes as $(a \perp \alpha)_O$.⁴⁴³ If a line a is perpendicular to a plane α (at a point O), the plane α is said to be perpendicular to the line a , written $\alpha \perp a$, or we can also say that the line a and the plane α (mentioned in any order) are perpendicular (at O).

Theorem 1.3.41. *Suppose a line d is perpendicular to two (distinct) lines a, c , drawn in a plane α through a point O .⁴⁴⁴ Then d is perpendicular to α , i.e. it is perpendicular to any line b drawn in plane α through O .*

Proof. Let lines a, b, c be divided by the point O into the following pairs of rays: h and h^c, k and k^c, l and l^c , respectively. In other words, we have $\mathcal{P}_a = h \cup \{O\} \cup h^c, \mathcal{P}_b = k \cup \{O\} \cup k^c, \mathcal{P}_c = l \cup \{O\} \cup l^c$. It should be obvious that by renaming the rays h, k, l and their complementary rays h^c, k^c, l^c appropriately, we can arrange them so that $k \subset \text{Int}\angle(h, l)$.⁴⁴⁵ Making use of A 1.1.3, A 1.3.1, choose points $D_1 \in d, D_2 \in d$ so that $[D_1OD_2], OD_1 \equiv OD_2$. Taking some points $A \in h, C \in l$, we have $\angle D_1OA \equiv \angle D_2OA, \angle D_1OC \equiv \angle D_2OC$ (the angles in question being right angles, because, by hypothesis, $a_{OD_1} = d \perp a, a_{OD_2} = d \perp c$.) Hence $OD_1 \equiv OD_2 \& OA \equiv OA \& \angle D_1OA \equiv \angle D_2OA \stackrel{\text{T1.3.4}}{\implies} \triangle AOD_1 \equiv \triangle AOD_2 \Rightarrow AD_1 \equiv AD_2, OD_1 \equiv OD_2 \& OC \equiv OC \& \angle D_1OC \equiv \angle D_2OC \stackrel{\text{T1.3.4}}{\implies} \triangle COD_1 \equiv \triangle COD_2 \Rightarrow CD_1 \equiv CD_2$. Therefore, $AD_1 \equiv AD_2 \& CD_1 \equiv CD_2 \& AC \equiv AC \stackrel{\text{T1.3.10}}{\implies} \triangle AD_1C \equiv \triangle AD_2C \Rightarrow \angle D_1AC \equiv \angle D_2AC$. We also have $k \subset \text{Int}\angle(h, l) \stackrel{\text{L1.2.21.10}}{\implies} \exists B (B \in k \& [ABC])$. But $[ABC] \stackrel{\text{L1.2.11.15}}{\implies} AB = AC \Rightarrow \angle D_1AB = \angle D_1AC \& \angle D_2AB = \angle D_2AC$, and we have $\angle D_1AC \equiv \angle D_2AC \& \angle D_1AB = \angle D_1AC \& \angle D_2AB = \angle D_2AC \Rightarrow \angle D_1AB \equiv \angle D_2AB$. Hence $AD_1 \equiv AD_2 \& AB \equiv AB \& \angle D_1AB \equiv \angle D_2AB \stackrel{\text{T1.3.4}}{\implies} \triangle D_1AB \equiv \triangle D_2AB \Rightarrow BD_1 \equiv BD_2$. Finally, we have $OD_1 \equiv OD_2 \& BD_1 \equiv BD_2 \Rightarrow \angle a_{OB} \perp a_{D_1D_2}$,⁴⁴⁶ which obviously amounts to $b \perp d$, q.e.d. \square

Theorem 1.3.42. *Suppose a line d is perpendicular to two (distinct) lines a, c , meeting in a point O . Then any line b perpendicular to d in O ⁴⁴⁷ lies in the plane α defined by the intersecting lines a, c . In particular, if a line d is perpendicular to a plane α at a point O , any line b drawn through O perpendicular to d lies in the plane α .*

⁴⁴²Obviously, O is the only point that a and α can have in common (see T 1.1.4.)

⁴⁴³The point of intersection (denoted here O) is often assumed to be known from context or not relevant, so we write simply $a \perp \alpha$, as is customary.

⁴⁴⁴Observe that O is the only point that d and α can have in common. In fact, if d and α have another common point, the line d lies in the plane α . Then d cannot meet both a and c at O , as this would contradict the uniqueness of the perpendicular with the given point (see L 1.3.8.3.) Suppose d meets a, c in two distinct points A_1, C_1 , respectively. Then the triangle $\triangle A_1OC_1$ (This IS a triangle, the three (obviously distinct) points O, A_1, C_1 being not collinear.) would have two right angles, which contradicts C 1.3.17.4. Thus, the contradictions we have arrived to convince us that the line d and the plane α have no common points other than O .

⁴⁴⁵In fact, suppose $B_2 \in b, C_2 \in c$, where $B_2 \neq O, C_2 \neq O$. Then both $B_2 \notin a, C_2 \notin a$, for if $B_2 \in a$ or $C_2 \in a$ then, respectively, either b or c would coincide with a , having two points in common with it (see A 1.1.2.) We have $B_2 \text{ in } \mathcal{P}_a \setminus \mathcal{P}_a \& \mathcal{P}_a \setminus \mathcal{P}_a \stackrel{\text{L1.2.17.8}}{\implies} BCa \vee BaC$. Denoting $k \equiv O_B$ and $l \equiv O_C$ if $BCa, l \equiv (O_C)^c$ if BaC , we see that in both cases the rays k, l lie (in plane α) on the same side of the line $a = \bar{h}$. (see L 1.2.18.4, T 1.2.19.) But $kla \stackrel{\text{L1.2.21.21}}{\implies} k \subset \text{Int}\angle(h, l) \vee l \subset \text{Int}\angle(h, k)$. Making the substitution $b \leftrightarrow c$, which, in its turn, induces the substitution $k \leftrightarrow l$, we see that, indeed, no generality is lost in assuming that $k \subset \text{Int}\angle(h, l)$.

⁴⁴⁶This implication can be substantiated using either T 1.3.24 or T 1.3.10.

⁴⁴⁷I.e. such that $O = b \cap d, b \perp d$

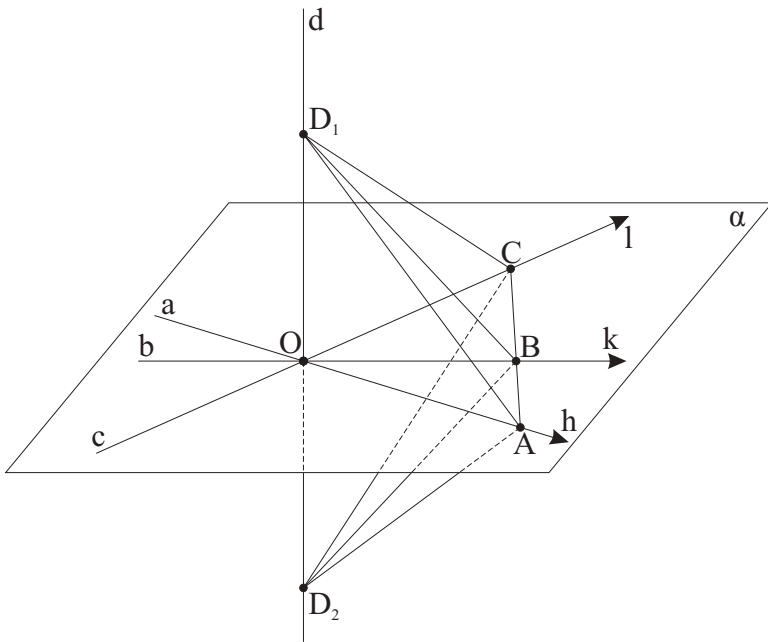

Figure 1.159: Suppose a line d is perpendicular to two lines a, c , drawn in a plane α through a point O . Then d is perpendicular to α .

Proof. By T 1.1.3 $\exists \alpha (a \subset \alpha \& c \subset \alpha)$. By T 1.3.41 $d \perp \alpha$. Let b be a line, perpendicular to d at O , i.e. $O = b \cap d$, $b \perp d$. Using T 1.1.3, draw a plane β containing the lines b, d , intersecting at O . Since the point O lies on both planes α, β , these planes by T 1.1.5 have a common line f . Note that, from definition, $d \perp \alpha \& f \subset \alpha \Rightarrow d \perp f$. But since the lines b, f both lie in one plane β and are both perpendicular to d at the same point O , by L 1.3.8.3 we have $b = f \subset \alpha$, q.e.d. \square

Theorem 1.3.43. *Given a line a and an arbitrary point O on it, there is exactly one plane α perpendicular to a at O .*

Proof. (See Fig. 1.161.) By L 1.1.2.1 $\exists B B \notin a$. By T 1.2.1 $\exists \beta (a \subset \beta \& B \in \beta)$. By L 1.1.2.6 $\exists C C \notin \beta$. By T 1.2.1 $\exists \gamma (a \subset \gamma \& C \in \gamma)$. $C \notin \beta \& C \in \gamma \Rightarrow \beta \neq \gamma$. Using L 1.3.8.3, we can draw in plane β a line b perpendicular to a . Similarly, by L 1.3.8.3 $\exists c (c \subset \gamma \& c \perp a)$. Obviously, $b \neq c$, for otherwise the planes β and γ , both drawn through the lines a and $b = c$, intersecting at O , would coincide. Since the lines b, c are distinct and concur at O , by T 1.1.3 there exists a plane α containing both b and c . Then by T 1.3.41 $a \perp \alpha$.

To show uniqueness, suppose there are two distinct planes $\alpha, \beta, \alpha \neq \beta$, both perpendicular to the line a at the same point O . (See Fig. 1.162.) Since the planes α, β are distinct, there is a point B such that $B \in \beta, B \notin \alpha$. We have $B \notin \alpha \xrightarrow{T1.1.2} \exists \gamma (a \subset \gamma \& B \in \gamma)$.⁴⁴⁸ We have $O \in \alpha \cap \gamma \xrightarrow{T1.1.5} \exists c (c = \alpha \cap \gamma)$.⁴⁴⁹ $a \perp \alpha \& c \subset \alpha \& O \in c \Rightarrow a \perp c$. $a \perp \beta \& a_{OB} \subset \beta \& O \in a_{OB} \Rightarrow a \perp a_{OB}$. We see now that the lines a_{OB}, c , lying in the plane γ , are both perpendicular to the line a at the same point O . By L 1.3.8.3 this means that $a_{OB} = c$, which implies $B \in c \subset \alpha$ - a contradiction with B having been chosen so that $B \notin \alpha$. The contradiction shows that in fact there can be no more than one plane perpendicular to a given line at a given point, q.e.d. \square

Theorem 1.3.44. *Given a plane α and an arbitrary point O on it, there is exactly one line a perpendicular to α at O .*

Proof. It is convenient to start by proving uniqueness. Suppose the contrary, i.e. that there are two distinct lines, a and b , both perpendicular to the plane α at the same point O (see Fig. 1.163.) Since a, b are distinct lines concurrent at O , by T 1.1.3 there is a plane β containing both of them. We have $O \in \alpha \cap \beta \xrightarrow{T1.1.5} \exists f f = \alpha \cap \beta$. $a \perp \alpha \& b \perp \alpha \& f \subset \alpha \Rightarrow a \perp f \& b \perp f$. We come to the conclusion that the lines a, b , lying in the same plane β as the line f , are both perpendicular to f in the same point O , in contradiction with L 1.3.8.3. This contradiction shows that in fact there can be no more than one line perpendicular to a given plane at a given point.

To show existence of a line a such that $a \perp \alpha$ at O (See Fig. 1.164), take in addition to O two other points B, C on α such that O, B, C do not colline (see T 1.1.6). Using the preceding theorem (T 1.3.43), construct planes β, γ such that $(a_{OB} \perp \beta)_O, (a_{OC} \perp \gamma)_O$.⁴⁵⁰ Observe, further, that $\beta \neq \gamma$, for otherwise, using the result of the proof of uniqueness given above, we would have $(a_{OB} \perp \beta)_O \& (a_{OC} \perp \gamma)_O \& \beta = \gamma \Rightarrow a_{OB} = a_{OC}$, which contradicts the

⁴⁴⁸Obviously, $O \in \alpha \& B \notin \alpha \Rightarrow B \neq O$. Therefore, $B \notin \alpha, O$ being the only point that the line a and the plane B have in common. Note also that by A 1.1.6 $a_{OB} \subset \gamma$.

⁴⁴⁹Note that it is absolutely obvious that, containing all common points of the planes α, γ , the line c is bound to contain O .

⁴⁵⁰In other words $a_{OB} \perp \beta$ at O and $a_{OC} \perp \gamma$ at O - see p. 174.

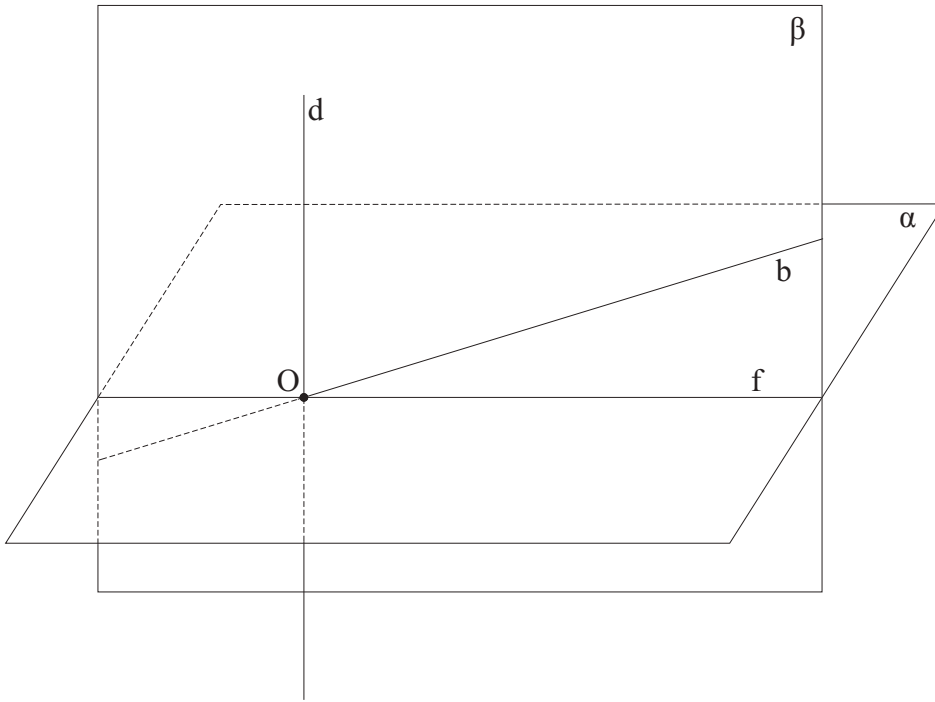

Figure 1.160: Suppose a line d is perpendicular to two (distinct) lines a, c , meeting in a point O . Then any line b perpendicular to d in O lies in the plane α defined by the intersecting lines a, c .

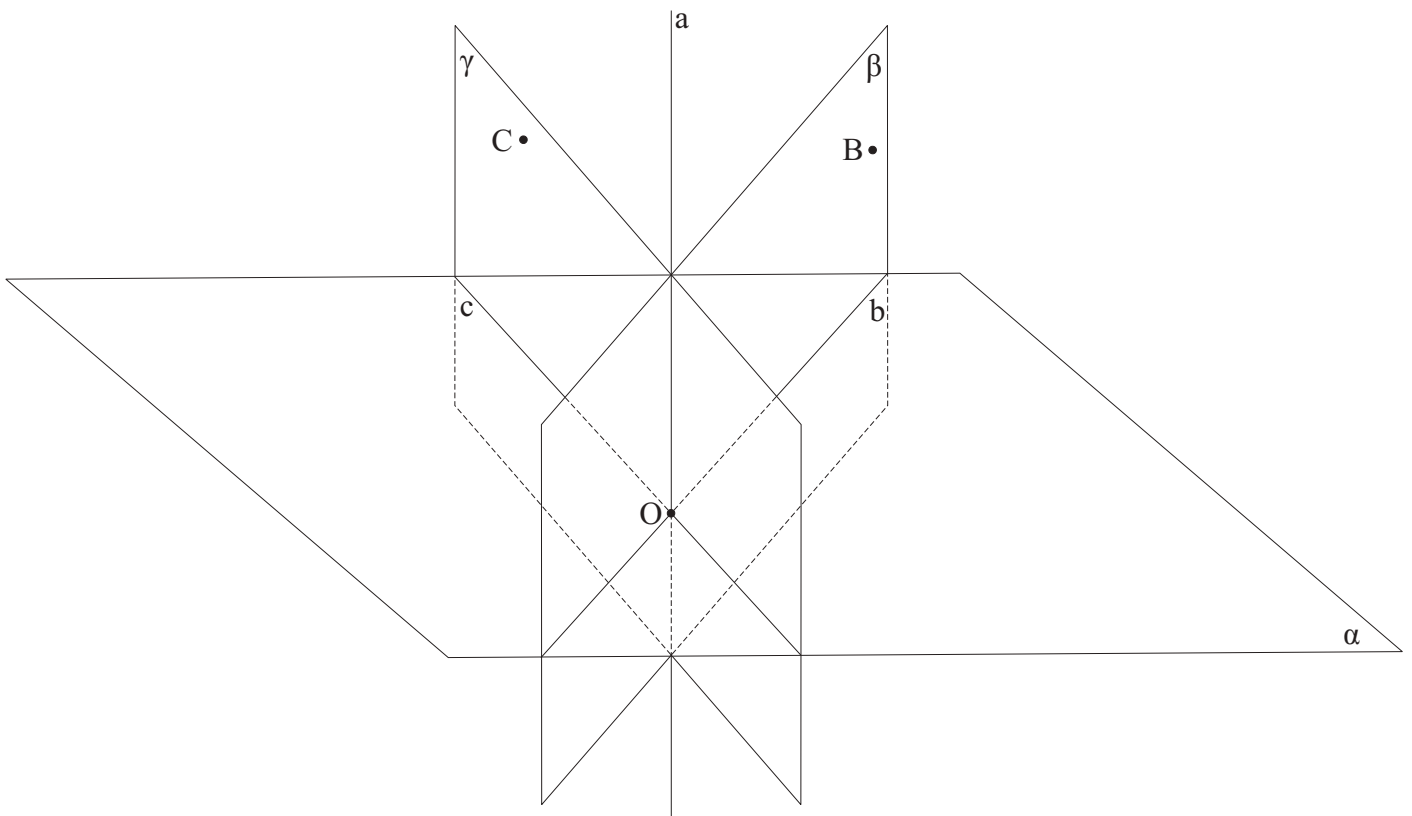

Figure 1.161: Illustration for proof of existence in T 1.3.43.

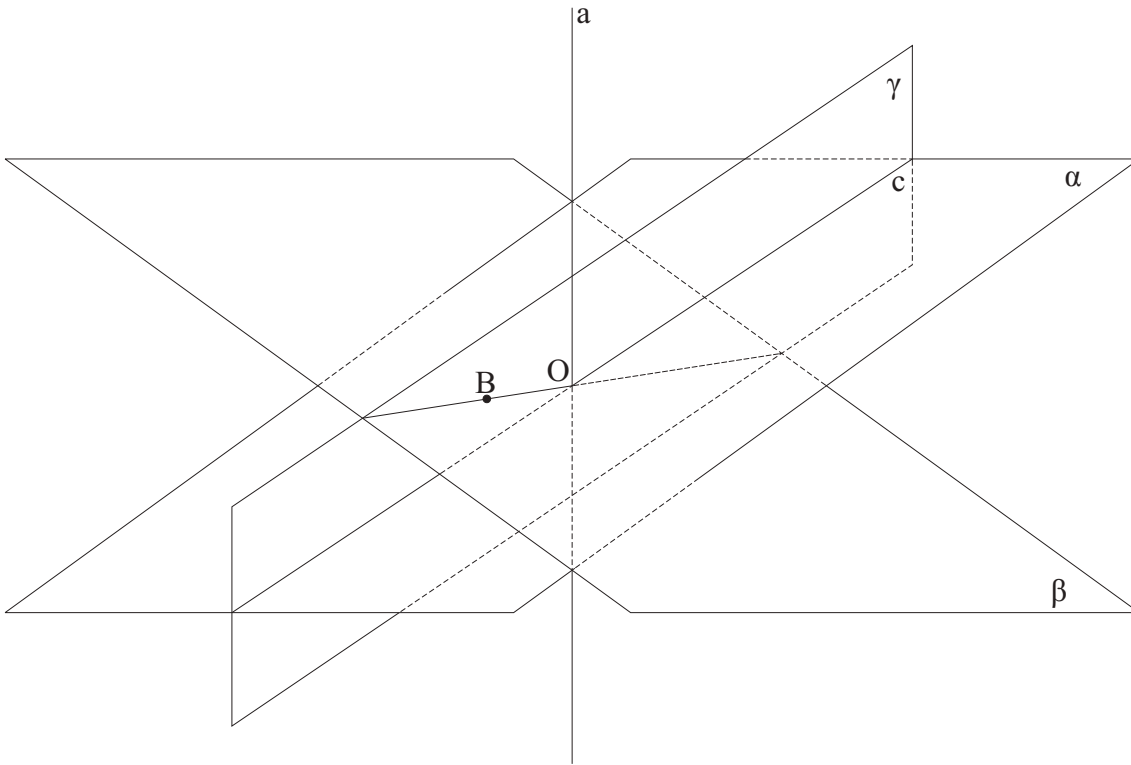

Figure 1.162: Illustration for proof of uniqueness in T 1.3.43.

choice of the points B, C as non-collinear with O . Sharing a point O , the distinct planes β, γ have in common a whole line a by T 1.1.5. We have $a_{OB} \perp \beta$ & $a \subset \beta \Rightarrow a \perp a_{OB}$, $a_{OC} \perp \gamma$ & $a \subset \gamma \Rightarrow a \perp a_{OC}$. Being perpendicular at the same point O to both lines a_{OB}, a_{OC} lying in plane α , the line a is perpendicular to α by T 1.3.41. \square

Theorem 1.3.45. *Given a plane α and an arbitrary point O not on it, exactly one line a perpendicular to α can be drawn through O .*

Proof. (See Fig. 1.165.) Draw a line a in plane α (see C 1.1.6.4). Using L 1.3.8.1, draw through O a line b perpendicular to a at some point Q . Using L 1.3.8.3, draw in α a line c perpendicular to a at Q . Using L 1.3.8.3 again, draw through O a line d perpendicular to c at some point P . If $P = Q$, the line a_{OP} , being perpendicular at the point $P = Q$ to two distinct lines a, c in the plane α , is perpendicular to the plane α itself by T 1.3.41. Suppose now $P \neq Q$. Using A 1.3.1, choose a point O' such that $[OPO']$, $OP \equiv O'P$. Note that $(d \perp c)_P$ implies that $\angle OPQ, \angle O'PQ$ are both right angles. Now we can write $OP \equiv O'P$ & $\angle OPQ \equiv \angle O'PQ$ & $PQ \equiv PQ \xrightarrow{T1.3.4} \triangle OPQ \equiv \triangle O'PQ \Rightarrow OQ \equiv O'Q$. Using T 1.1.3, draw a plane β through the two distinct lines a_{OQ}, a_{PQ} meeting at Q . Since the line a is perpendicular at Q to both $a_{OQ} = b, a_{PQ} = c$, it is perpendicular to the plane β by T 1.3.41, which means, in particular, that a is perpendicular to $a_{O'Q} \subset \beta$. Since $a \perp a_{OQ}, a \perp a_{O'Q}$, where $a_{OQ} \subset \beta, a_{O'Q} \subset \beta$,⁴⁵¹ choosing on the line a a point A distinct from Q , we have by T 1.3.16 ($\angle AQO, \angle AQO'$ both being right angles) $\angle AQO \equiv \angle AQO'$. Hence $AQ \equiv AQ$ & $\angle AQO \equiv \angle AQO'$ & $\angle OQO' \equiv \angle O'QO' \xrightarrow{T1.3.4} \triangle AQO \equiv \triangle AQO' \Rightarrow AO \equiv AO'$. The interval AP , being the median of the isosceles triangle $\triangle OAO'$ joining the vertex A with the base OO' , is also an altitude. That is, we have $a_{AP} \perp a_{OO'}$, where $a_{OO'} = d$. Note that $A \in a \subset \alpha$ & $P \in c \subset \alpha \xrightarrow{A1.1.6} a_{AP} \subset \alpha$. Since the line d is perpendicular at P to both $c \subset \alpha, a_{AP} \subset \alpha$, by T 1.3.41 we obtain $d \perp \alpha$, which completes the proof of existence.

To show uniqueness, suppose the contrary, i.e. suppose there are two lines a, b , both drawn through a point O , such that a, b are both perpendicular to a plane $\alpha \not\ni O$ at two distinct points A and B , respectively (See Fig. 1.166.) . Then $A \in \alpha$ & $B \in \alpha \xrightarrow{A1.1.6} a_{AB} \subset \alpha$, and the angles $\angle OAB, \angle OBA$ of the triangle $\triangle OAB$ would both be right angles, which contradicts This contradiction shows that in fact through a point O not lying on a plane α at most one line perpendicular to α can be drawn. \square

In geometry, the set of geometric objects (usually points) with a given property is often referred to as the *locus* of points with that property.

Given an interval AB , a plane α , perpendicular to the line a_{AB} at the midpoint M of AB , is called a perpendicular plane bisector of the interval AB .

Theorem 1.3.46. *Every interval has exactly one perpendicular plane bisector.*

⁴⁵¹Making use of L 1.2.1.3, A 1.1.6, we can write $O \in a_{OQ} \subset \beta$ & $P \in a_{PQ} \subset \beta \Rightarrow a_{OP} \subset \beta$, $[OPO'] \Rightarrow O' \in a_{OP}, Q \in a_{PQ} \subset \beta$ & $O' \in a_{OP} \subset \beta \Rightarrow a_{O'Q} \subset \beta$.

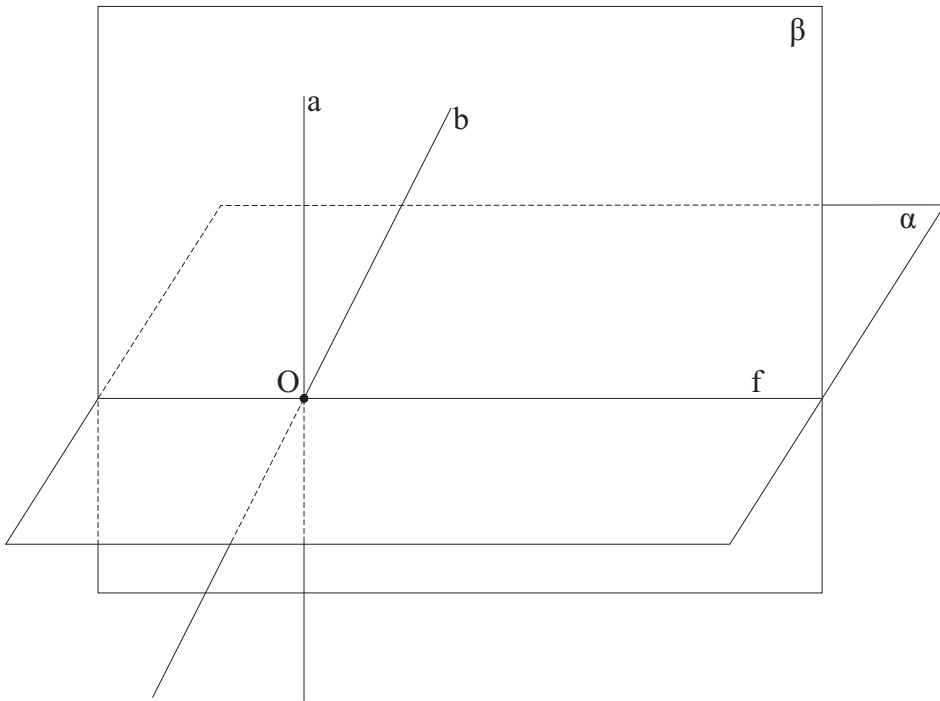

Figure 1.163: Illustration for proof of uniqueness in T 1.3.44.

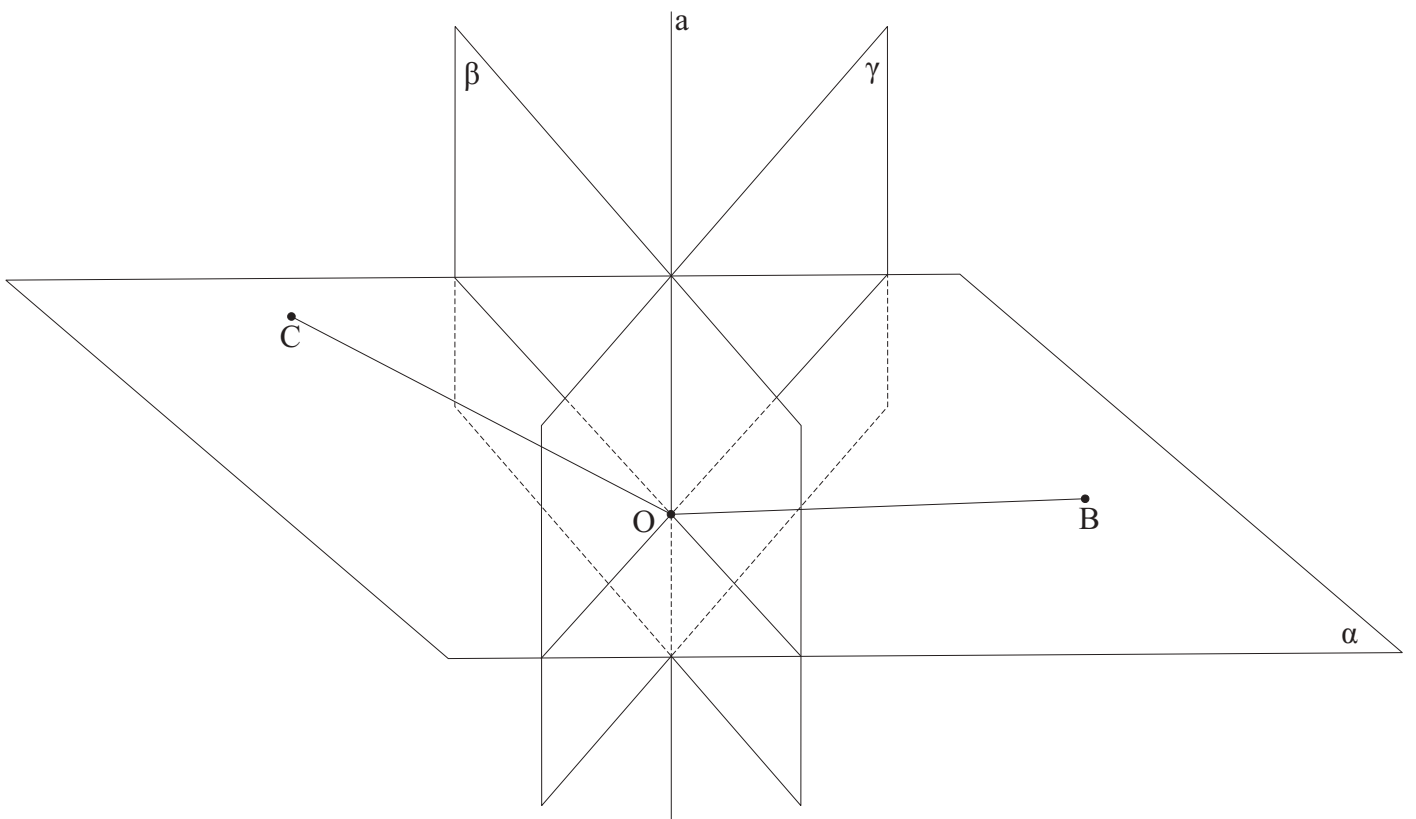

Figure 1.164: Illustration for proof of existence in T 1.3.44.

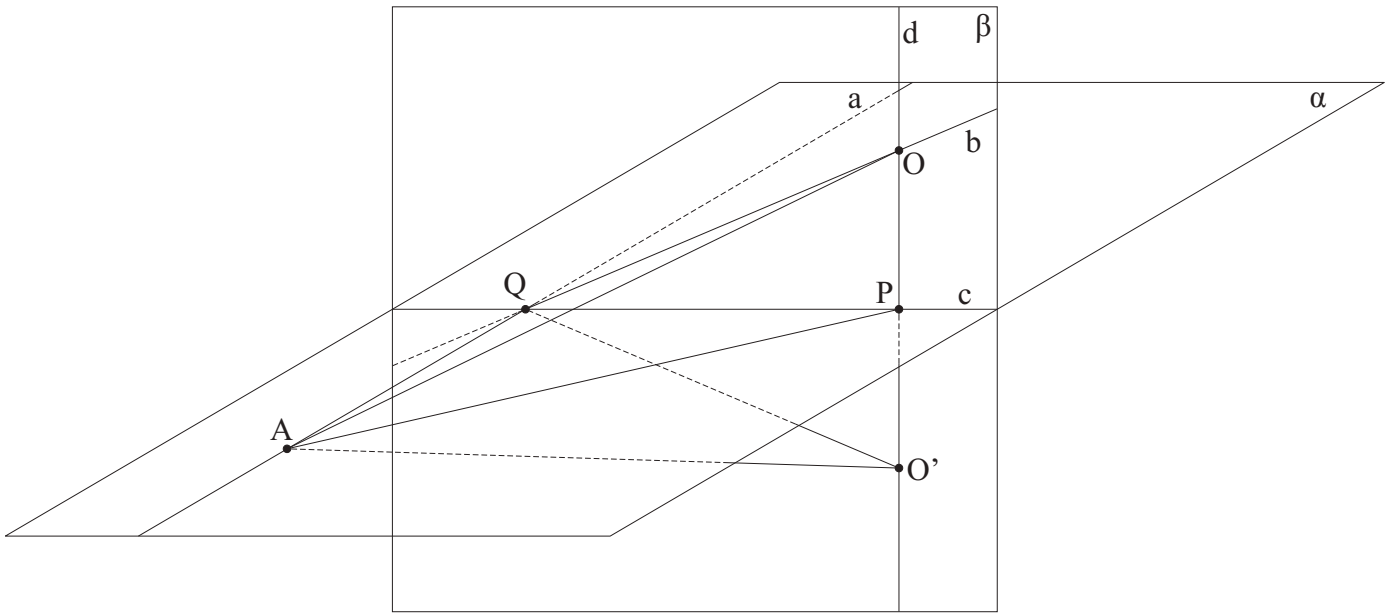

Figure 1.165: Illustration for proof of existence in T 1.3.45.

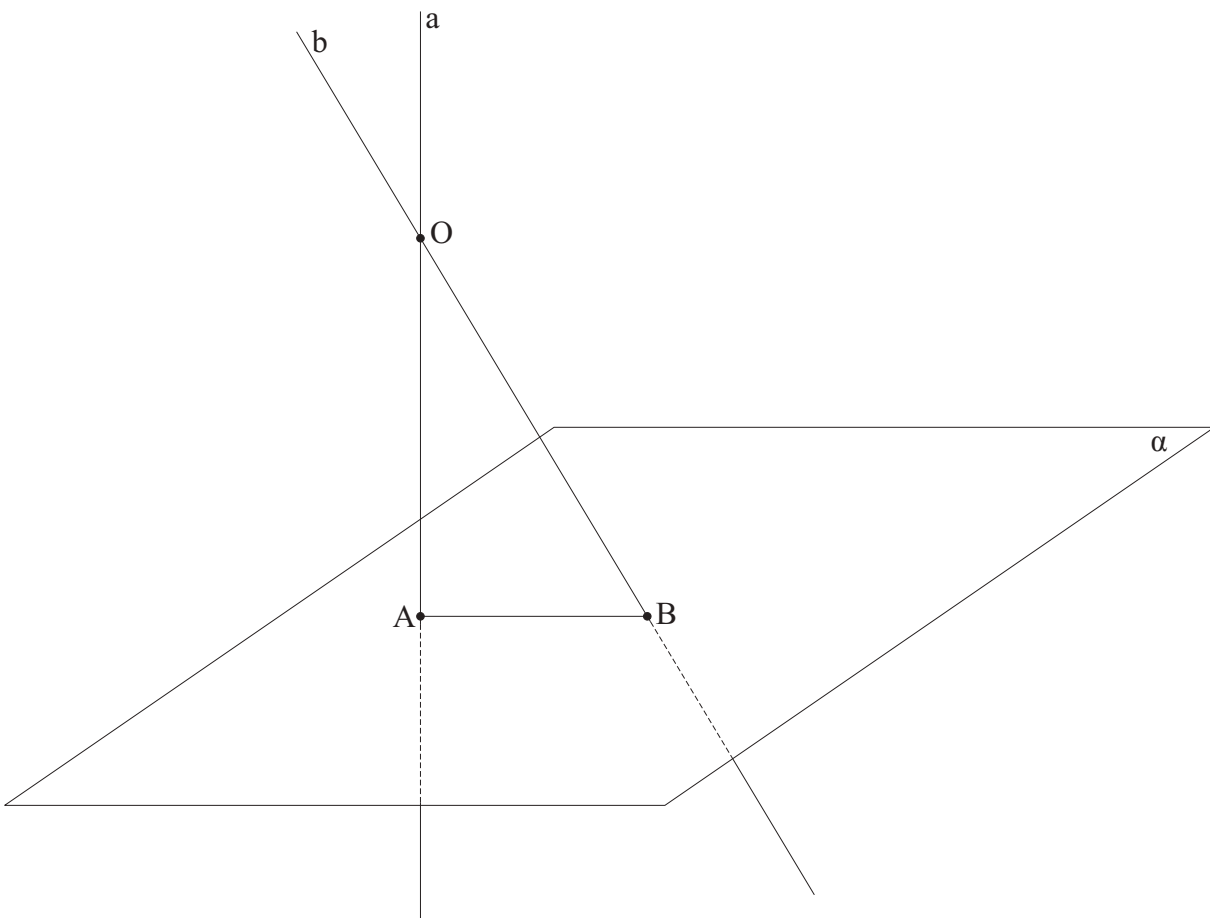

Figure 1.166: Illustration for proof of uniqueness in T 1.3.45.

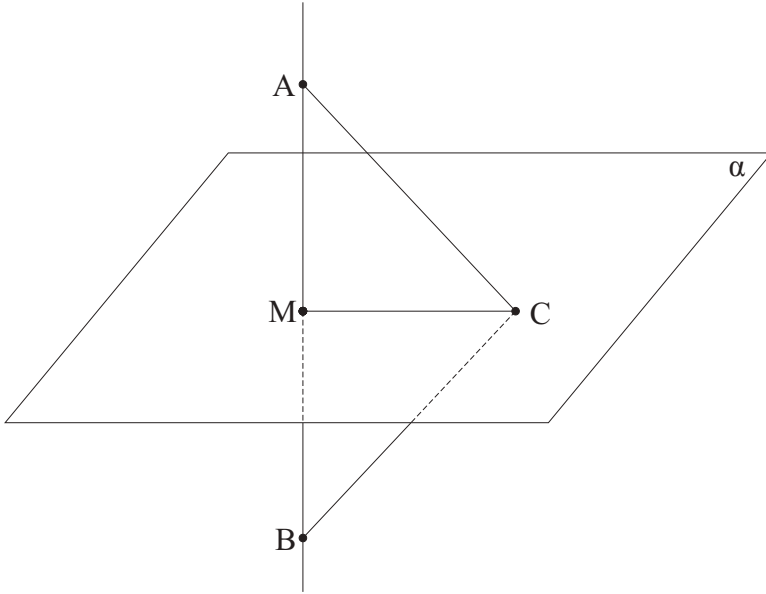

Figure 1.167: The locus of points, equidistant (in space) from two given points A, B , is the perpendicular plane bisector of the interval AB .

Proof. In fact, by T 1.3.22 every interval AB has exactly one midpoint M . By T 1.3.43 there is exactly one plane perpendicular to a_{AB} at M . \square

Theorem 1.3.47. *The locus of points, equidistant (in space) from two given points A, B , is the perpendicular plane bisector of the interval AB .*

Proof. (See Fig. 1.167.) Using T 1.3.43, draw a plane α perpendicular to a_{AB} at $M = \text{mid } AB$. Obviously, $AM \equiv MB$ by the definition of midpoint. If $C \neq M, C \in \alpha$, then $a_{AB} \perp \alpha$ implies $\angle AMC \equiv \angle BMC$, both $\angle AMC, \angle BMC$ being right angles. Hence $AM \equiv MB \& \angle AMC \equiv \angle BMC \& CM \equiv CM \xrightarrow{\text{T1.3.4}} \triangle ACM \equiv \triangle BCM \Rightarrow AC \equiv CB$,⁴⁵² i.e. the point C is equidistant from A, B .

Suppose now that a point C is equidistant from A, B , and show that C lies in α . For $C = M$ this is true by construction. Suppose $C \neq M$. Then $C \notin a_{AB}$, the midpoint M of AB being (by C 1.3.23.2) the only point of the line a_{AB} equidistant from A, B . Hence we can write $AC \equiv BC \& AM \equiv BM \xrightarrow{\text{T1.3.24}} a_{CM} \perp a_{AB}$, whence by T 1.3.42 $a_{CM} \subset \alpha$. \square

Theorem 1.3.48. *Proof.* \square

Theorem 1.3.49. *Proof.* \square

Theorem 1.3.50. *Proof.* \square

Consider a subclass \mathcal{C}^{gbr} of the class \mathcal{C}_0^{gbr} of all those sets \mathfrak{J} that are equipped with a (weak) generalized betweenness relation. Let $\mathfrak{J} = \{\{A, B\} \mid \exists \mathfrak{J} \in \mathcal{C}^{gbr} \ A \in \mathfrak{J} \& B \in \mathfrak{J}\}$ be a set (of two - element subsets of \mathcal{C}^{gbr}) where a relation of generalized congruence is defined.⁴⁵³ Then we have:⁴⁵⁴

Lemma 1.3.51.1. *Suppose geometric objects $B \in \mathfrak{J}$ and $B' \in \mathfrak{J}'$ lie between geometric objects $A \in \mathfrak{J}, C \in \mathfrak{J}$ and $A' \in \mathfrak{J}', C' \in \mathfrak{J}'$, respectively. Then $AB \equiv A'B'$ and $BC < B'C'$ imply $AC < A'C'$.*

Proof. $BC < B'C' \xrightarrow{\text{L1.3.15.3}} \exists C'' \ [B'C''C'] \& BC \equiv B'C''$. $[A'B'C'] \& [B'C''C'] \xrightarrow{\text{Pr1.2.7}} [A'B'C'']$ & $[A'C''C']$. $[ABC] \& [A'B'C''] \& AB \equiv A'B' \& BC \equiv B'C'' \xrightarrow{\text{Pr1.3.3}} AC \equiv A'C'$. Since also $[A'C''C']$, by L 1.3.15.3 we conclude that $AC < A'C'$. \square

Lemma 1.3.51.2. *Suppose geometric objects B and B' lie between geometric objects A, C and A', C' , respectively. Then $AB \equiv A'B'$ and $AC < A'C'$ imply $BC < B'C'$.*

Proof. By L 1.3.15.14 we have either $BC \equiv B'C'$, or $B'C' < BC$, or $BC < B'C'$. Suppose $BC \equiv B'C'$. Then $[ABC] \& [A'B'C'] \& AB \equiv A'B' \& BC \equiv B'C' \xrightarrow{\text{L1.3.14.4}} AC \equiv A'C'$, which contradicts $AC < A'C'$ in view of L 1.3.15.11. Suppose $B'C' < BC$. In this case $[ABC] \& [A'B'C'] \& A'B' \equiv AB \& B'C' < BC \xrightarrow{\text{L1.3.51.1}} A'C' \equiv AC$, which contradicts $AC < A'C'$ in view of L 1.3.15.10. Thus, we have $BC < B'C'$ as the only remaining possibility. \square

⁴⁵²See also P 1.3.24.3 for a shorter way to demonstrate $AC \equiv CB$.

⁴⁵³The latter, by definition, has properties given by Pr 1.3.1 – Pr 1.3.5 (see p 126).

⁴⁵⁴We assume that all sets $\mathfrak{J}, \mathfrak{J}', \dots$ with generalized betweenness relation belong to the class \mathcal{C}^{gbr} .

Lemma 1.3.51.3. *Suppose geometric objects \mathcal{B} and \mathcal{B}' lie between geometric objects \mathcal{A} , \mathcal{C} and \mathcal{A}' , \mathcal{C}' , respectively. Then $\mathcal{AB} < \mathcal{A}'\mathcal{B}'$ and $\mathcal{BC} < \mathcal{B}'\mathcal{C}'$ imply $\mathcal{AC} < \mathcal{A}'\mathcal{C}'$.⁴⁵⁵*

Proof. $\mathcal{AB} < \mathcal{A}'\mathcal{B}'$ & $\mathcal{BC} < \mathcal{B}'\mathcal{C}' \xrightarrow{\text{L1.3.15.3}} \exists \mathcal{A}'' ([\mathcal{B}'\mathcal{A}''\mathcal{A}'])$ & $\mathcal{BA} \equiv \mathcal{B}'\mathcal{A}''$ & $\exists \mathcal{C}'' ([\mathcal{B}'\mathcal{C}''\mathcal{C}'])$ & $\mathcal{BC} \equiv \mathcal{B}'\mathcal{C}''$. $[\mathcal{A}'\mathcal{B}'\mathcal{C}']$ & $[\mathcal{A}'\mathcal{A}''\mathcal{B}']$ & $[\mathcal{B}'\mathcal{C}''\mathcal{C}'] \xrightarrow{\text{L1.2.7}} [\mathcal{A}'\mathcal{B}'\mathcal{C}''']$ & $[\mathcal{A}'\mathcal{C}''\mathcal{C}']$ & $[\mathcal{A}'\mathcal{A}''\mathcal{C}']$ & $[\mathcal{A}''\mathcal{B}'\mathcal{C}']$. $[\mathcal{A}''\mathcal{B}'\mathcal{C}']$ & $[\mathcal{B}'\mathcal{C}''\mathcal{C}'] \xrightarrow{\text{Pr1.2.7}} [\mathcal{A}''\mathcal{B}'\mathcal{C}''']$. $[\mathcal{ABC}]$ & $[\mathcal{A}''\mathcal{B}'\mathcal{C}''']$ & $\mathcal{AB} \equiv \mathcal{A}''\mathcal{B}'$ & $\mathcal{BC} \equiv \mathcal{B}'\mathcal{C}'' \xrightarrow{\text{Pr1.3.3}} \mathcal{AC} \equiv \mathcal{A}''\mathcal{C}''$. Finally, $[\mathcal{A}'\mathcal{A}''\mathcal{C}']$ & $[\mathcal{A}'\mathcal{C}''\mathcal{C}']$ & $\mathcal{AC} \equiv \mathcal{A}''\mathcal{C}'' \xrightarrow{\text{L1.3.15.3}} \mathcal{AC} < \mathcal{A}'\mathcal{C}'$. \square

In the following L 1.3.51.4 - L 1.3.51.7 we assume that finite sequences of n geometric objects $\mathcal{A}_1, \mathcal{A}_2, \dots, \mathcal{A}_n \in \mathfrak{J}$ and $\mathcal{B}_1, \mathcal{B}_2, \dots, \mathcal{B}_n \in \mathfrak{J}'$, where $n \geq 3$, have the property that every geometric object of the sequence, except the first ($\mathcal{A}_1, \mathcal{B}_1$) and the last ($\mathcal{A}_n, \mathcal{B}_n$, respectively), lies between the two geometric objects of the sequence with the numbers adjacent (in \mathbb{N}) to the number of the given geometric object. Suppose, further, that $\forall i \in \mathbb{N}_{n-2} \mathcal{A}_i\mathcal{A}_{i+1} \equiv \mathcal{A}_{i+1}\mathcal{A}_{i+2}$, $\mathcal{B}_i\mathcal{B}_{i+1} \equiv \mathcal{B}_{i+1}\mathcal{B}_{i+2}$.⁴⁵⁶

Lemma 1.3.51.4. *If $\forall i \in \mathbb{N}_{n-1} \mathcal{A}_i\mathcal{A}_{i+1} \leq \mathcal{B}_i\mathcal{B}_{i+1}$ and $\exists i_0 \in \mathbb{N}_{n-1} \mathcal{A}_{i_0}\mathcal{A}_{i_0+1} < \mathcal{B}_{i_0}\mathcal{B}_{i_0+1}$, then $\mathcal{A}_1\mathcal{A}_n < \mathcal{B}_1\mathcal{B}_n$.*

Proof. Choose $i_0 \equiv \min\{i | \mathcal{A}_i\mathcal{A}_{i+1} < \mathcal{B}_i\mathcal{B}_{i+1}\}$. For $i_0 \in \mathbb{N}_{n-2}$ we have by the induction assumption $\mathcal{A}_1\mathcal{A}_{n-1} < \mathcal{B}_1\mathcal{B}_{n-1}$. Then we can write either $\mathcal{A}_1\mathcal{A}_{n-1} < \mathcal{B}_1\mathcal{B}_{n-1}$ & $\mathcal{A}_{n-1}\mathcal{A}_n \equiv \mathcal{B}_{n-1}\mathcal{B}_n \xrightarrow{\text{L1.3.51.1}} \mathcal{A}_1\mathcal{A}_n < \mathcal{B}_1\mathcal{B}_n$, or $\mathcal{A}_1\mathcal{A}_{n-1} < \mathcal{B}_1\mathcal{B}_{n-1}$ & $\mathcal{A}_{n-1}\mathcal{A}_n < \mathcal{B}_{n-1}\mathcal{B}_n \xrightarrow{\text{L1.3.51.3}} \mathcal{A}_1\mathcal{A}_n < \mathcal{B}_1\mathcal{B}_n$. For $i_0 = n-1$ we have by T 1.3.14 $\mathcal{A}_1\mathcal{A}_{n-1} \equiv \mathcal{B}_1\mathcal{B}_{n-1}$. Then $\mathcal{A}_1\mathcal{A}_{n-1} \equiv \mathcal{B}_1\mathcal{B}_{n-1}$ & $\mathcal{A}_{n-1}\mathcal{A}_n < \mathcal{B}_{n-1}\mathcal{B}_n \xrightarrow{\text{L1.3.51.1}} \mathcal{A}_1\mathcal{A}_n < \mathcal{B}_1\mathcal{B}_n$. \square

Corollary 1.3.51.5. *If $\forall i \in \mathbb{N}_{n-1} \mathcal{A}_i\mathcal{A}_{i+1} \leq \mathcal{B}_i\mathcal{B}_{i+1}$, then $\mathcal{A}_1\mathcal{A}_n \leq \mathcal{B}_1\mathcal{B}_n$.*

Proof. Immediately follows from T 1.3.14, L 1.3.51.4. \square

Lemma 1.3.51.6. *The inequality $\mathcal{A}_1\mathcal{A}_n < \mathcal{B}_1\mathcal{B}_n$ implies that $\forall i, j \in \mathbb{N}_{n-1} \mathcal{A}_i\mathcal{A}_{i+1} < \mathcal{B}_j\mathcal{B}_{j+1}$.*

Proof. It suffices to show that $\mathcal{A}_1\mathcal{A}_2 < \mathcal{B}_1\mathcal{B}_2$, because then by L 1.3.15.6, L 1.3.15.7 we have $\mathcal{A}_1\mathcal{A}_2 < \mathcal{B}_1\mathcal{B}_2$ & $\mathcal{A}_1\mathcal{A}_2 \equiv \mathcal{A}_i\mathcal{A}_{i+1}$ & $\mathcal{B}_1\mathcal{B}_2 \equiv \mathcal{B}_j\mathcal{B}_{j+1} \Rightarrow \mathcal{A}_i\mathcal{A}_{i+1} < \mathcal{B}_j\mathcal{B}_{j+1}$ for all $i, j \in \mathbb{N}_{n-1}$. Suppose the contrary, i.e. that $\mathcal{B}_1\mathcal{B}_2 \leq \mathcal{A}_1\mathcal{A}_2$. Then by L 1.3.14.1, L 1.3.15.6, L 1.3.15.7 we have $\mathcal{B}_1\mathcal{B}_2 \leq \mathcal{A}_1\mathcal{A}_2$ & $\mathcal{B}_1\mathcal{B}_2 \equiv \mathcal{B}_i\mathcal{B}_{i+1}$ & $\mathcal{A}_1\mathcal{A}_2 \equiv \mathcal{A}_i\mathcal{A}_{i+1} \Rightarrow \mathcal{B}_i\mathcal{B}_{i+1} \leq \mathcal{A}_i\mathcal{A}_{i+1}$ for all $i \in \mathbb{N}_{n-1}$, whence by C 1.3.51.5 $\mathcal{B}_1\mathcal{B}_n \leq \mathcal{A}_1\mathcal{A}_n$, which contradicts the hypothesis in view of L 1.3.15.10, C 1.3.15.12. \square

Lemma 1.3.51.7. *The congruence $\mathcal{A}_1\mathcal{A}_n \equiv \mathcal{B}_1\mathcal{B}_n$ implies that $\forall i, j \in \mathbb{N}_{n-k} \mathcal{A}_i\mathcal{A}_{i+k} \equiv \mathcal{B}_j\mathcal{B}_{j+k}$, where $k \in \mathbb{N}_{n-1}$.*⁴⁵⁷

Proof. Again, it suffices to show that $\mathcal{A}_1\mathcal{A}_2 \equiv \mathcal{B}_1\mathcal{B}_2$, for then we have $\mathcal{A}_1\mathcal{A}_2 \equiv \mathcal{B}_1\mathcal{B}_2$ & $\mathcal{A}_1\mathcal{A}_2 \equiv \mathcal{A}_i\mathcal{A}_{i+1}$ & $\mathcal{B}_1\mathcal{B}_2 \equiv \mathcal{B}_j\mathcal{B}_{j+1} \xrightarrow{\text{L1.3.14.1}} \mathcal{A}_i\mathcal{A}_{i+1} \equiv \mathcal{B}_j\mathcal{B}_{j+1}$ for all $i, j \in \mathbb{N}_{n-1}$, whence the result follows in an obvious way from T 1.3.14 and L 1.3.14.1. Suppose $\mathcal{A}_1\mathcal{A}_2 < \mathcal{B}_1\mathcal{B}_2$.⁴⁵⁸ Then by L 1.3.15.6, L 1.3.15.7 we have $\mathcal{A}_1\mathcal{A}_2 < \mathcal{B}_1\mathcal{B}_2$ & $\mathcal{A}_1\mathcal{A}_2 \equiv \mathcal{A}_i\mathcal{A}_{i+1}$ & $\mathcal{B}_1\mathcal{B}_2 \equiv \mathcal{B}_i\mathcal{B}_{i+1} \Rightarrow \mathcal{A}_i\mathcal{A}_{i+1} < \mathcal{B}_i\mathcal{B}_{i+1}$ for all $i \in \mathbb{N}_{n-1}$, whence $\mathcal{A}_1\mathcal{A}_n < \mathcal{B}_1\mathcal{B}_n$ by L 1.3.51.4, which contradicts $\mathcal{A}_1\mathcal{A}_n \equiv \mathcal{B}_1\mathcal{B}_n$ in view of L 1.3.15.11. \square

If a finite sequence of geometric objects \mathcal{A}_i , where $i \in \mathbb{N}_n$, $n \geq 4$, has the property that every geometric object of the sequence, except for the first and the last, lies between the two geometric objects with adjacent (in \mathbb{N}) numbers, and, furthermore, $\mathcal{A}_1\mathcal{A}_2 \equiv \mathcal{A}_2\mathcal{A}_3 \equiv \dots \equiv \mathcal{A}_{n-1}\mathcal{A}_n$,⁴⁵⁹ we say that the generalized interval $\mathcal{A}_1\mathcal{A}_n$ is divided into $n-1$ congruent intervals $\mathcal{A}_1\mathcal{A}_2, \mathcal{A}_2\mathcal{A}_3, \dots, \mathcal{A}_{n-1}\mathcal{A}_n$ (by the geometric objects $\mathcal{A}_2, \mathcal{A}_3, \dots, \mathcal{A}_{n-1}$).

If a generalized interval $\mathcal{A}_1\mathcal{A}_n$ is divided into generalized intervals $\mathcal{A}_i\mathcal{A}_{i+1}$, $i \in \mathbb{N}_{n-1}$, all congruent to a generalized interval \mathcal{AB} (and, consequently, to each other), we can also say, with some abuse of language, that the generalized interval $\mathcal{A}_1\mathcal{A}_n$ consists of $n-1$ generalized intervals \mathcal{AB} (or, to be more precise, of $n-1$ instances of the generalized interval \mathcal{AB}).

If a generalized interval $\mathcal{A}_0\mathcal{A}_n$ is divided into n intervals $\mathcal{A}_{i-1}\mathcal{A}_i$, $i \in \mathbb{N}_n$, all congruent to a generalized interval \mathcal{CD} (and, consequently, to each other), we shall say, using a different kind of folklore, that the generalized interval \mathcal{CD} is laid off n times from the geometric object \mathcal{A}_0 on the generalized ray $\mathcal{A}_0\mathcal{P}$, reaching the geometric object \mathcal{A}_n , where \mathcal{P} is some geometric object such that the generalized ray $\mathcal{A}_0\mathcal{P}$ contains the geometric objects $\mathcal{A}_1, \dots, \mathcal{A}_n$.⁴⁶⁰

⁴⁵⁵As before, in order to avoid clumsiness in statements and proofs, we often do not mention explicitly the set with generalized betweenness relation where a given geometric object lies whenever this is felt to be obvious from context or not particularly relevant.

⁴⁵⁶Observe that these conditions imply, and this will be used in the ensuing proofs, that $[\mathcal{A}_1\mathcal{A}_{n-1}\mathcal{A}_n]$, $[\mathcal{B}_1\mathcal{B}_{n-1}\mathcal{B}_n]$ by L 1.2.22.11, and for all $i, j \in \mathbb{N}_{n-1}$ we have $\mathcal{A}_i\mathcal{A}_{i+1} \equiv \mathcal{A}_j\mathcal{A}_{j+1}$, $\mathcal{B}_i\mathcal{B}_{i+1} \equiv \mathcal{B}_j\mathcal{B}_{j+1}$ by L 1.3.14.1.

⁴⁵⁷Observe that the argument used to prove the present lemma, together with T 1.3.14, allows us to formulate the following facts: Given a generalized interval \mathcal{AB} consisting of k congruent generalized intervals, each of which (or, equivalently, congruent to one which) results from division of a generalized interval \mathcal{CD} into n congruent generalized intervals, and given a generalized interval $\mathcal{A}'\mathcal{B}'$ consisting of k congruent generalized intervals (congruent to those) resulting from division of a generalized interval $\mathcal{C}'\mathcal{D}'$ into n congruent generalized intervals, if $\mathcal{CD} \equiv \mathcal{C}'\mathcal{D}'$ then $\mathcal{AB} \equiv \mathcal{A}'\mathcal{B}'$. Given a generalized interval \mathcal{AB} consisting of k_1 congruent generalized intervals, each of which (or, equivalently, congruent to one which) results from division of a generalized interval \mathcal{CD} into n congruent generalized intervals, and given a generalized interval $\mathcal{A}'\mathcal{B}'$ consisting of k_2 congruent generalized intervals (congruent to those) resulting from division of a generalized interval $\mathcal{C}'\mathcal{D}'$ into n congruent generalized intervals, if $\mathcal{CD} \equiv \mathcal{C}'\mathcal{D}'$, $\mathcal{AB} \equiv \mathcal{A}'\mathcal{B}'$, then $k_1 = k_2$.

⁴⁵⁸Due to symmetry and T 1.3.14, we do not really need to consider the case $\mathcal{B}_1\mathcal{B}_2 < \mathcal{A}_1\mathcal{A}_2$.

⁴⁵⁹In other words, all generalized intervals $\mathcal{A}_i\mathcal{A}_{i+1}$, where $i \in \mathbb{N}_{n-1}$, are congruent

⁴⁶⁰For instance, it is obvious from L 1.2.22.11, L 1.2.25.15 that \mathcal{P} can be any of the geometric objects $\mathcal{A}_1, \dots, \mathcal{A}_n$.

Lemma 1.3.51.8. *If generalized intervals $\mathcal{A}_1\mathcal{A}_k$ and $\mathcal{B}_1\mathcal{B}_n$ consist, respectively, of $k - 1$ and $n - 1$ generalized intervals $\mathcal{A}\mathcal{B}$, where $k < n$, then the generalized interval $\mathcal{A}_1\mathcal{A}_k$ is shorter than the generalized interval $\mathcal{B}_1\mathcal{B}_n$.*

Proof. We have, by hypothesis (and T 1.3.1) $\mathcal{A}\mathcal{B} \equiv \mathcal{A}_1\mathcal{A}_2 \equiv \mathcal{A}_2\mathcal{A}_3 \equiv \dots \equiv \mathcal{A}_{k-1}\mathcal{A}_k \equiv \mathcal{B}_1\mathcal{B}_2 \equiv \mathcal{B}_2\mathcal{B}_3 \equiv \dots \equiv \mathcal{B}_{n-1}\mathcal{B}_n$, where $[\mathcal{A}_i\mathcal{A}_{i+1}\mathcal{A}_{i+2}]$ for all $i \in \mathbb{N}_{k-2}$ and $[\mathcal{B}_i\mathcal{B}_{i+1}\mathcal{B}_{i+2}]$ for all $i \in \mathbb{N}_{n-2}$. Hence by T 1.3.14 $\mathcal{A}_1\mathcal{A}_k \equiv \mathcal{B}_1\mathcal{B}_k$, and by L 1.2.22.11 $[\mathcal{B}_1\mathcal{B}_k\mathcal{B}_n]$. By L 1.3.15.3 this means $\mathcal{A}_1\mathcal{A}_k < \mathcal{B}_1\mathcal{B}_n$. \square

Lemma 1.3.51.9. *If a generalized interval $\mathcal{E}\mathcal{F}$ consists of $k - 1$ generalized intervals $\mathcal{A}\mathcal{B}$, and, at the same time, of $n - 1$ generalized intervals $\mathcal{C}\mathcal{D}$, where $k > n$, the generalized interval $\mathcal{A}\mathcal{B}$ is shorter than the generalized interval $\mathcal{C}\mathcal{D}$.*

Proof. We have, by hypothesis, $\mathcal{E}\mathcal{F} \equiv \mathcal{A}_1\mathcal{A}_k \equiv \mathcal{B}_1\mathcal{B}_n$, where $\mathcal{A}\mathcal{B} \equiv \mathcal{A}_1\mathcal{A}_2 \equiv \mathcal{A}_2\mathcal{A}_3 \equiv \dots \equiv \mathcal{A}_{k-1}\mathcal{A}_k$, $\mathcal{C}\mathcal{D} \equiv \mathcal{B}_1\mathcal{B}_2 \equiv \mathcal{B}_2\mathcal{B}_3 \equiv \dots \equiv \mathcal{B}_{n-1}\mathcal{B}_n$, and, of course, $\forall i \in \mathbb{N}_{k-2} [\mathcal{A}_i\mathcal{A}_{i+1}\mathcal{A}_{i+2}]$ and $\forall i \in \mathbb{N}_{n-2} [\mathcal{B}_i\mathcal{B}_{i+1}\mathcal{B}_{i+2}]$. Suppose $\mathcal{A}\mathcal{B} \equiv \mathcal{C}\mathcal{D}$. Then the preceding lemma (L 1.3.51.8) would give $\mathcal{A}_1\mathcal{A}_k > \mathcal{B}_1\mathcal{B}_n$, which contradicts $\mathcal{A}_1\mathcal{A}_k \equiv \mathcal{B}_1\mathcal{B}_n$ in view of L 1.3.15.11. On the other hand, the assumption $\mathcal{A}\mathcal{B} > \mathcal{C}\mathcal{D}$ would again give $\mathcal{A}_1\mathcal{A}_k > \mathcal{A}_1\mathcal{A}_n > \mathcal{B}_1\mathcal{B}_n$ by C 1.3.51.5, L 1.3.51.8. Thus, we conclude that $\mathcal{A}\mathcal{B} < \mathcal{C}\mathcal{D}$. \square

Corollary 1.3.51.10. *If a generalized interval $\mathcal{A}\mathcal{B}$ is shorter than the generalized interval $\mathcal{C}\mathcal{D}$ and is divided into a larger number of congruent generalized intervals than is $\mathcal{A}\mathcal{B}$, then (any of) the generalized intervals resulting from this division of $\mathcal{A}\mathcal{B}$ are shorter than (any of) those resulting from the division of $\mathcal{C}\mathcal{D}$.*

Proof. \square

Lemma 1.3.51.11. *Proof.* \square

Let a generalized interval $\mathcal{A}_0\mathcal{A}_n$ be divided into n generalized intervals $\mathcal{A}_0\mathcal{A}_1, \mathcal{A}_1\mathcal{A}_2, \dots, \mathcal{A}_{n-1}\mathcal{A}_n$ (by the geometric objects $\mathcal{A}_1, \mathcal{A}_2, \dots, \mathcal{A}_{n-1}$) and a generalized interval $\mathcal{A}'_0\mathcal{A}'_n$ be divided into n generalized intervals $\mathcal{A}'_0\mathcal{A}'_1, \mathcal{A}'_1\mathcal{A}'_2, \dots, \mathcal{A}'_{n-1}\mathcal{A}'_n$ in such a way that $\forall i \in \mathbb{N}_n \mathcal{A}_{i-1}\mathcal{A}_i \equiv \mathcal{A}'_{i-1}\mathcal{A}'_i$. Also, let a geometric object \mathcal{B}' lie on the generalized ray $\mathcal{A}'_0\mathcal{A}'_0$, where \mathcal{A}'_0 is one of the geometric objects \mathcal{A}'_i , $i \in \mathbb{N}_n$; and, finally, let $\mathcal{A}\mathcal{B} \equiv \mathcal{A}'\mathcal{B}'$. Then:

Lemma 1.3.51.12. *– If \mathcal{B} lies on the generalized open interval $(\mathcal{A}_{k-1}\mathcal{A}_k)$, where $k \in \mathbb{N}_n$, then the geometric object \mathcal{B}' lies on the generalized open interval $(\mathcal{A}'_{k-1}\mathcal{A}'_k)$.*

Proof. For $k = 1$ we obtain the result immediately from Pr 1.3.3, so we can assume without loss of generality that $k > 1$. Since $\mathcal{A}'_{i_0}, \mathcal{B}'$ (by hypothesis) and $\mathcal{A}'_{i_0}, \mathcal{A}'_{k-1}, \mathcal{A}'_k$ (see L 1.2.56.18) lie on one side of \mathcal{A}'_0 , so do $\mathcal{A}'_{k-1}, \mathcal{A}'_k, \mathcal{B}'$. Since also (by L 1.2.22.11) $[\mathcal{A}_0\mathcal{A}_{k-1}\mathcal{A}_k], [\mathcal{A}'_0\mathcal{A}'_{k-1}\mathcal{A}'_k]$, we have $[\mathcal{A}_0\mathcal{A}_{k-1}\mathcal{A}_k] \& [\mathcal{A}_{k-1}\mathcal{B}\mathcal{A}_k] \xrightarrow{\text{Pr1.2.7}} [\mathcal{A}_0\mathcal{A}_{k-1}\mathcal{B}] \& [\mathcal{A}_0\mathcal{B}\mathcal{A}_k]$. Taking into account that (by hypothesis) $\mathcal{A}_0\mathcal{B} \equiv \mathcal{A}'_0\mathcal{B}'$ and (by L 1.3.51.7) $\mathcal{A}_0\mathcal{A}_{k-1} \equiv \mathcal{A}'_0\mathcal{A}'_{k-1}$, $\mathcal{A}_0\mathcal{A}_k \equiv \mathcal{A}'_0\mathcal{A}'_k$, we obtain by Pr 1.3.3 $[\mathcal{A}'_0\mathcal{A}'_{k-1}\mathcal{B}'], [\mathcal{A}'_0\mathcal{B}'\mathcal{A}'_k]$, whence by Pr 1.2.6 $[\mathcal{A}'_{k-1}\mathcal{B}'\mathcal{A}'_k]$, as required. \square

Lemma 1.3.51.13. *– If \mathcal{B} coincides with the geometric object \mathcal{A}_{k_0} , where $k_0 \in \mathbb{N}_n$, then \mathcal{B}' coincides with \mathcal{A}'_{k_0} .*

Proof. Follows immediately from L 1.3.51.7, Pr 1.3.1. \square

Corollary 1.3.51.14. *– If \mathcal{B} lies on the generalized half-open interval $[\mathcal{A}_{k-1}\mathcal{A}_k)$, where $k \in \mathbb{N}_n$, then the geometric object \mathcal{B}' lies on the generalized half-open interval $[\mathcal{A}'_{k-1}\mathcal{A}'_k)$.*

Proof. Follows immediately from the two preceding lemmas, L 1.3.51.12 and L 1.3.51.13. \square

Theorem 1.3.51. *Given a generalized interval $\mathcal{A}_1\mathcal{A}_{n+1}$, divided into n congruent generalized intervals $\mathcal{A}_1\mathcal{A}_2, \mathcal{A}_2\mathcal{A}_3, \dots, \mathcal{A}_n\mathcal{A}_{n+1}$, if the first of these generalized intervals $\mathcal{A}_1\mathcal{A}_2$ is further subdivided into m_1 congruent generalized intervals $\mathcal{A}_{1,1}\mathcal{A}_{1,2}, \mathcal{A}_{1,2}\mathcal{A}_{1,3}, \dots, \mathcal{A}_{1,m_1}\mathcal{A}_{1,m_1+1}$, where $\forall i \in \mathbb{N}_{m_1-1} [\mathcal{A}_{1,i}\mathcal{A}_{1,i+1}\mathcal{A}_{1,i+2}]$, and we denote $\mathcal{A}_{1,1} \equiv \mathcal{A}_1$ and $\mathcal{A}_{1,m_1+1} \equiv \mathcal{A}_2$; the second generalized interval $\mathcal{A}_2\mathcal{A}_3$ is subdivided into m_2 congruent generalized intervals $\mathcal{A}_{2,1}\mathcal{A}_{2,2}, \mathcal{A}_{2,2}\mathcal{A}_{2,3}, \dots, \mathcal{A}_{2,m_2}\mathcal{A}_{2,m_2+1}$, where $\forall i \in \mathbb{N}_{m_2-1} [\mathcal{A}_{2,i}\mathcal{A}_{2,i+1}\mathcal{A}_{2,i+2}]$, and we denote $\mathcal{A}_{2,1} \equiv \mathcal{A}_2$ and $\mathcal{A}_{2,m_2+1} \equiv \mathcal{A}_3$; \dots ; the n^{th} generalized interval $\mathcal{A}_n\mathcal{A}_{n+1}$ - into m_n congruent generalized intervals $\mathcal{A}_{n,1}\mathcal{A}_{n,2}, \mathcal{A}_{n,2}\mathcal{A}_{n,3}, \dots, \mathcal{A}_{n,m_n}\mathcal{A}_{n,m_n+1}$, where $\forall i \in \mathbb{N}_{m_n-1} [\mathcal{A}_{n,i}\mathcal{A}_{n,i+1}\mathcal{A}_{n,i+2}]$, and we denote $\mathcal{A}_{n,1} \equiv \mathcal{A}_n$ and $\mathcal{A}_{n,m_n+1} \equiv \mathcal{A}_{n+1}$. Then the generalized interval $\mathcal{A}_1\mathcal{A}_{n+1}$ is divided into the $m_1 + m_2 + \dots + m_n$ congruent generalized intervals $\mathcal{A}_{1,1}\mathcal{A}_{1,2}, \mathcal{A}_{1,2}\mathcal{A}_{1,3}, \dots, \mathcal{A}_{1,m_1}\mathcal{A}_{1,m_1+1}, \mathcal{A}_{2,1}\mathcal{A}_{2,2}, \mathcal{A}_{2,2}\mathcal{A}_{2,3}, \dots, \mathcal{A}_{2,m_2}\mathcal{A}_{2,m_2+1}, \dots, \mathcal{A}_{n,1}\mathcal{A}_{n,2}, \mathcal{A}_{n,2}\mathcal{A}_{n,3}, \dots, \mathcal{A}_{n,m_n}\mathcal{A}_{n,m_n+1}$.*

In particular, if a generalized interval is divided into n congruent generalized intervals, each of which is further subdivided into m congruent generalized intervals, the starting generalized interval turns out to be divided into mn congruent generalized intervals.

Proof. Using L 1.2.22.11, we have for any $j \in \mathbb{N}_{n-1}$: $[\mathcal{A}_{j,1}\mathcal{A}_{j,m_j}\mathcal{A}_{j,m_j+1}], [\mathcal{A}_{j+1,1}\mathcal{A}_{j+1,2}\mathcal{A}_{j+1,m_{j+1}+1}]$. Since, by definition, $\mathcal{A}_{j,1} = \mathcal{A}_j$, $\mathcal{A}_{j,m_j+1} = \mathcal{A}_{j+1,1} = \mathcal{A}_{j+1}$ and $\mathcal{A}_{j+1,m_{j+1}+1} = \mathcal{A}_{j+2}$, we can write $[\mathcal{A}_j\mathcal{A}_{j,m_j}\mathcal{A}_{j+1}] \& [\mathcal{A}_j\mathcal{A}_{j+1}\mathcal{A}_{j+2}] \xrightarrow{\text{Pr1.2.7}} [\mathcal{A}_{j,m_j}\mathcal{A}_{j+1}\mathcal{A}_{j+2}]$ and $[\mathcal{A}_{j,m_j}\mathcal{A}_{j+1}\mathcal{A}_{j+2}] \& [\mathcal{A}_{j+1}\mathcal{A}_{j+1,2}\mathcal{A}_{j+2}] \xrightarrow{\text{Pr1.2.7}} [\mathcal{A}_{j,m_j}\mathcal{A}_{j+1}\mathcal{A}_{j+1,2}]$. Since this is proven for all $j \in \mathbb{N}_{n-1}$, we have all the required betweenness relations. The rest is obvious. ⁴⁶¹ \square

⁴⁶¹All congruences we need are already true by hypothesis.

Let $\mathfrak{J}, \mathfrak{J}'$ be, respectively, either the pencil $\mathfrak{J}_0, \mathfrak{J}'_0$ of all rays lying in a plane α, α' on the same side of a line a, a' containing the initial point O, O' of the rays, or the pencil $\mathfrak{J}_0, \mathfrak{J}'_0$ just described, augmented by the rays h, h^c and h', h'^c , respectively, where $h \cup \{O\}h^c = \mathcal{P}_a, h' \cup \{O'\}h'^c = \mathcal{P}_{a'}$.⁴⁶² Then we have the following results through T 1.3.52:

Lemma 1.3.52.1. *Suppose rays $k \in \mathfrak{J}$ and $k' \in \mathfrak{J}'$ lie between rays $h \in \mathfrak{J}, l \in \mathfrak{J}$ and $h' \in \mathfrak{J}', l' \in \mathfrak{J}'$, respectively. Then $\angle(h, k) \equiv \angle(h', k')$ and $\angle(k, l) < \angle(k', l')$ imply $\angle(h, l) < \angle(h', l')$.*

Lemma 1.3.52.2. *Suppose rays $k \in \mathfrak{J}$ and $k' \in \mathfrak{J}'$ lie between rays $h \in \mathfrak{J}, l \in \mathfrak{J}$ and $h' \in \mathfrak{J}', l' \in \mathfrak{J}'$, respectively. Then $\angle(h, k) \equiv \angle(h', k')$ and $\angle(h, l) < \angle(h', l')$ imply $\angle(k, l) < \angle(k', l')$.*

Lemma 1.3.52.3. *Suppose rays h and h' lie between rays h, l and h', l' , respectively. Then $\angle(h, k) < \angle(h', k')$ and $\angle(k, l) < \angle(k', l')$ imply $\angle(h, l) < \angle(h', l')$.⁴⁶³*

In the following L 1.3.52.4 - L 1.3.52.7 we assume that finite sequences of n rays $h_1, h_2, \dots, h_n \in \mathfrak{J}$ and $k_1, k_2, \dots, k_n \in \mathfrak{J}'$, where $n \geq 3$, have the property that every ray of the sequence, except the first (h_1, k_1) and the last (h_n, k_n , respectively), lies between the two rays of the sequence with the numbers adjacent (in \mathbb{N}) to the number of the given ray. Suppose, further, that $\forall i \in \mathbb{N}_{n-2} \angle(h_i, h_{i+1}) \equiv \angle(h_{i+1}, h_{i+2}), \angle(k_i, k_{i+1}) \equiv \angle(k_{i+1}, k_{i+2})$.

Lemma 1.3.52.4. *If $\forall i \in \mathbb{N}_{n-1} \angle(h_i, h_{i+1}) \leq \angle(k_i, k_{i+1})$ and $\exists i_0 \in \mathbb{N}_{n-1} \angle(h_{i_0}, h_{i_0+1}) < \angle(k_{i_0}, k_{i_0+1})$, then $\angle(h_1, h_n) < \angle(k_1, k_n)$.*

Corollary 1.3.52.5. *If $\forall i \in \mathbb{N}_{n-1} \angle(h_i, h_{i+1}) \leq \angle(k_i, k_{i+1})$, then $\angle(h_1, h_n) \leq \angle(k_1, k_n)$.*

Lemma 1.3.52.6. *The inequality $\angle(h_1, h_n) < \angle(k_1, k_n)$ implies that $\forall i, j \in \mathbb{N}_{n-1} \angle(h_i, h_{i+1}) < \angle(k_j, k_{j+1})$.*

Lemma 1.3.52.7. *The congruence $\angle(h_1, h_n) \equiv \angle(k_1, k_n)$ implies that $\forall i, j \in \mathbb{N}_{n-k} \angle(h_i, h_{i+k}) \equiv \angle(k_j, k_{j+k})$, where $k \in \mathbb{N}_{n-1}$.⁴⁶⁴*

If a finite sequence of rays h_i , where $i \in \mathbb{N}_n, n \geq 4$, has the property that every ray of the sequence, except for the first and the last, lies between the two rays with adjacent (in \mathbb{N}) numbers, and, furthermore, $\angle(h_1, h_2) \equiv \angle(h_2, h_3) \equiv \dots \equiv \angle(h_{n-1}, h_n)$,⁴⁶⁵ we say that the angle $\angle(h_1, h_n)$ is divided into $n - 1$ congruent angles $\angle(h_1, h_2), \angle(h_2, h_3), \dots, \angle(h_{n-1}, h_n)$ (by the rays h_2, h_3, \dots, h_{n-1}).

If an angle $\angle(h_1, h_n)$ is divided angles $\angle(h_i, h_{i+1}), i \in \mathbb{N}_{n-1}$, all congruent to an angle $\angle(h, k)$ (and, consequently, to each other), we can also say, with some abuse of language, that the angle $\angle(h_1, h_n)$ consists of $n - 1$ angles $\angle(h, k)$ (or, to be more precise, of $n - 1$ instances of the angle $\angle(h, k)$).

Lemma 1.3.52.8. *If angles $\angle(h_1, h_k)$ and $\angle(k_1, k_n)$ consist, respectively, of $k - 1$ and $n - 1$ angles $\angle(h, k)$, where $k < n$, then the angle $\angle(h_1, h_k)$ is less than the angle $\angle(k_1, k_n)$.*

Lemma 1.3.52.9. *If an angle $\angle(p, q)$ consists of $k - 1$ angles $\angle(h, k)$, and, at the same time, of $n - 1$ angles $\angle(l, m)$, where $k > n$, the angle $\angle(h, k)$ is less than the angle $\angle(l, m)$.*

Corollary 1.3.52.10. *If an angle $\angle(h, k)$ is less than the angle $\angle(l, m)$ and is divided into a larger number of congruent angles than is $\angle(h, k)$, then (any of) the angles resulting from this division of $\angle(h, k)$ are less than (any of) those resulting from the division of $\angle(l, m)$.*

Let an angle $\angle(h_0, h_n)$ be divided into n angles $\angle(h_0, h_1), \angle(h_1, h_2), \dots, \angle(h_{n-1}, h_n)$ (by the rays h_1, h_2, \dots, h_{n-1}) and an angle $\angle(h'_0, h'_n)$ be divided into n angles $\angle(h'_0, h'_1), \angle(h'_1, h'_2), \dots, \angle(h'_{n-1}, h'_n)$ in such a way that $\forall i \in \mathbb{N}_n h_{i-1}h_i \equiv h'_{i-1}h'_i$. Also, let a ray k' lie on the angular ray $h'_{0h'_{i_0}}$, where h'_{i_0} is one of the rays $h'_i, i \in \mathbb{N}_n$; and, finally, let $\angle(h, k) \equiv \angle(h', k')$. Then:

Lemma 1.3.52.11. *If the ray k lies inside the angle $\angle(h_{k-1}, h_k)$, where $k \in \mathbb{N}_n$, then the ray k' lies inside the angle $\angle(h'_{k-1}, h'_k)$.*

Lemma 1.3.52.12. *If k coincides with the ray h_{k_0} , where $k_0 \in \mathbb{N}_n$, then k' coincides with h'_{k_0} .*

Corollary 1.3.52.13. *If k lies on the angular half-open interval $[h_{k-1}h_k)$, where $k \in \mathbb{N}_n$, then the ray k' lies on the angular half-open interval $[h'_{k-1}h'_k)$.*

⁴⁶²That is, in the second case $\mathfrak{J} = \mathfrak{J}_0 \cup \{h, h^c\}, \mathfrak{J}' = \mathfrak{J}'_0 \cup \{h', h'^c\}$.

⁴⁶³As before, in order to avoid clumsiness in statements, we often do not mention explicitly the pencil in question whenever this is felt to be obvious from context or not particularly relevant.

⁴⁶⁴We can also formulate the following facts: Given an angle $\angle(h, k)$ consisting of p congruent angles, each of which (or, equivalently, congruent to one which) results from division of an angle $\angle(l, m)$ into n congruent angles, and given a generalized interval $\angle(h', k')$ consisting of p congruent angles (congruent to those) resulting from division of an angle $\angle(l', m')$ into n congruent angle, if $\angle(l, m) \equiv \angle(l', m')$ then $\angle(h, k) \equiv \angle(h', k')$. Given an angle $\angle(h, k)$ consisting of k_1 congruent angles, each of which (or, equivalently, congruent to one which) results from division of an angle $\angle(l, m)$ into n congruent angles, and given an angle $\angle(h', k')$ consisting of k_2 congruent angles (congruent to those) resulting from division of an angle $\angle(l', m')$ into n congruent angles, if $\angle(l, m) \equiv \angle(l', m'), \angle(h, k) \equiv \angle(h', k')$, then $k_1 = k_2$.

⁴⁶⁵In other words, all angles $\angle(h_i, h_{i+1})$, where $i \in \mathbb{N}_{n-1}$, are congruent

Theorem 1.3.52. Given an angle $\angle(h_1, h_{n+1})$, divided into n congruent angles $\angle(h_1, h_2), \angle(h_2, h_3), \dots, \angle(h_n, h_{n+1})$, if the first of these angles $\angle(h_1, h_2)$ is further subdivided into m_1 congruent angles $\angle(h_{1,1}, h_{1,2}), \angle(h_{1,2}, h_{1,3}), \dots, \angle(h_{1,m_1}, h_{1,m_1+1})$, where $\forall i \in \mathbb{N}_{m_1-1} h_{1,i+1} \subset \text{Int}\angle(h_{1,i}, h_{1,i+2})$, and we denote $h_{1,1} \equiv h_1$ and $h_{1,m_1+1} \equiv h_2$; the second angle h_2h_3 is subdivided into m_2 congruent angles $h_{2,1}h_{2,2}, h_{2,2}h_{2,3}, \dots, h_{2,m_2}h_{2,m_2+1}$, where $\forall i \in \mathbb{N}_{m_2-1} h_{2,i+1} \subset \text{Int}\angle(h_{2,i}, h_{2,i+2})$, and we denote $h_{2,1} \equiv h_2$ and $h_{2,m_2+1} \equiv h_3$; ...; the n^{th} angle $\angle(h_n, h_{n+1})$ - into m_n congruent angles $\angle(h_{n,1}, h_{n,2}), \angle(h_{n,2}, h_{n,3}), \dots, \angle(h_{n,m_n}, h_{n,m_n+1})$, where $\forall i \in \mathbb{N}_{m_n-1} h_{n,i+1} \subset \text{Int}\angle(h_{n,i}, h_{n,i+2})$, and we denote $h_{1,1} \equiv h_1$ and $h_{1,m_1+1} \equiv h_{n+1}$. Then the angle $\angle(h_1, h_{n+1})$ is divided into the $m_1 + m_2 + \dots + m_n$ congruent angles $\angle(h_{1,1}, h_{1,2}), \angle(h_{1,2}, h_{1,3}), \dots, \angle(h_{1,m_1}, h_{1,m_1+1}), \angle(h_{2,1}, h_{2,2}), \angle(h_{2,2}, h_{2,3}), \dots, \angle(h_{2,m_2}, h_{2,m_2+1}), \dots, \angle(h_{n,1}, h_{n,2}), \angle(h_{n,2}, h_{n,3}), \dots, \angle(h_{n,m_n}, h_{n,m_n+1})$.

In particular, if an angle is divided into n congruent angles, each of which is further subdivided into m congruent angles, the starting angle turns out to be divided into mn congruent angles.

Theorem 1.3.53. Suppose that we are given:

- A line a is perpendicular to planes γ, γ' at points O, O' , respectively.

- Two (distinct) planes α, β containing the line a .

Suppose further that:

- Points $A \in \alpha \cap \gamma, A_1 \in \alpha \cap \gamma'$, where $A \neq O, A_1 \neq O'$, lie (in the plane α) on the same side of the line a .

- Points $B \in \beta \cap \gamma, B_1 \in \beta \cap \gamma'$, where $B \neq O, B_1 \neq O'$, lie (in the plane β) on the same side of the line a .

Then the angles $\angle AOB, \angle A_1O'B_1$ are congruent.

Proof. Using A 1.3.1 take points A', B' so that $OA \equiv O'A', OB \equiv O'B', [A_1O'A'], [B_1O'B']$. Since $a_{OO'} = a \perp \gamma \Rightarrow a \perp a_{OA} \& a \perp a_{OB}, a \perp \gamma' \Rightarrow a \perp a_{O'A_1} \& a \perp a_{O'B_1}$, and by T 1.3.16 all right angles are congruent, we can write $\angle AOO' \equiv \angle A'O'O, \angle BOO' \equiv \angle B'O'O$.⁴⁶⁶ Evidently, $AA_1a \& [A_1O'A'] \Rightarrow AaA'$ (see L 1.2.17.10). Similarly, $BB_1a \& [B_1O'B'] \Rightarrow BaB'$ (see L 1.2.17.10). Since $OA \equiv O'A', \angle AOO' \equiv \angle A'O'O, AaA'$, and $OB \equiv O'B', \angle BOO' \equiv \angle B'O'O, BaB'$, we can use C 1.3.23.4 to conclude that the open intervals $(OO'), (AA'), (BB')$ concur in the single point M which is the midpoint to all these intervals. This means that $AM \equiv A'M, BM \equiv B'M, [AMA'], [BMB']$.⁴⁶⁷ The relations $[AMA'], [BMB']$ imply that the angles $\angle AMB, \angle A'MB'$ are congruent and are, therefore, vertical. Hence $AM \equiv A'M \& BM \equiv B'M, \angle AMB \equiv \angle A'MB' \xrightarrow{\text{T1.3.4}} \triangle AMB \equiv \triangle A'MB' \Rightarrow AB \equiv A'B'$. Finally, $OA \equiv O'A' \& OB \equiv O'B' \& AB \equiv A'B' \xrightarrow{\text{T1.3.10}} \triangle AOB \equiv \triangle A'O'B'$. \square

Consider two half-planes χ, κ , forming the dihedral angle $\widehat{\chi\kappa}$, and let a be their common edge. Take a point $O \in a$. Let further α be the plane perpendicular to a at O (T 1.3.43). From L 1.2.55.8, the rays h, k that are the sections by the plane α of the half-planes χ, κ , respectively, form an angle $\angle(h, k)$ with the vertex O .⁴⁶⁸ We shall refer to such an angle $\angle(h, k)$ as a plane angle of the dihedral angle $\widehat{\chi\kappa}$. Evidently, any dihedral angle has infinitely many plane angles, actually, there is a one-to-one correspondence between the points of a and the corresponding plane angles.⁴⁶⁹ But the preceding theorem (T 1.3.53) shows that all the plane angles of a given dihedral angles are congruent. This observation legalizes the following definition: Dihedral angles are called congruent if their plane angles are congruent. We see from T 1.3.53 (and T 1.3.11) that congruence of angles is well defined.

Theorem 1.3.54. Congruence of dihedral angles satisfies the properties P 1.3.1 - P 1.3.3, P 1.3.6. Here the sets \mathfrak{J} with generalized betweenness relation are the pencils of half-planes lying on the same side of a given plane α and having the same edge $a \in \alpha$ (Of course, every pair consisting of a plane α and a line a on it gives rise to exactly two such pencils.); each of these pencils is supplemented with the (two) half-planes into which the appropriate line a (the pencil's origin, i.e. the common edge of the half-planes that constitute the pencil) divides the appropriate plane α .
470

Proof. To show that P 1.3.1 is satisfied, consider a dihedral angle $\widehat{\chi\kappa}$ with a plane angle $\angle(h, k)$. Basically, we need to show that, given an arbitrary half-plane χ' with the line a' as its edge, we can draw in any of the two subspaces (defined by the plane containing χ') a half-plane κ' with edge a' , such that $\widehat{\chi\kappa} \equiv \widehat{\chi'\kappa'}$. Take a point $O' \in a'$ and draw (using T 1.3.43) the plane α' perpendicular to a' at O' . Denote by h' the ray that is the section of χ' by α' . Using A 1.3.4, we then find the ray k' with initial point O' such that k' lies on appropriate side of χ' (i.e. on appropriate side of the plane $\bar{\chi}'$ containing it) and $\angle(h, k) \equiv \angle(h', k')$.⁴⁷¹ Now, drawing a plane β' through a' and a point on k' (see T 1.1.2), we see from our definition of congruence of dihedral angles that $\widehat{\chi\kappa} \equiv \widehat{\chi'\kappa'}$, where κ' is the half-plane of β' with edge a' , containing the ray k' , i.e. $k' \subset \kappa'$. Uniqueness of κ' is shown similarly using C 1.2.55.24, A 1.3.4.

⁴⁶⁶Obviously, $A \neq O \& B \neq O \& A_1 \neq O' \& B_1 \neq O' \xrightarrow{\text{A1.1.1}} \exists a_{OA} \& \exists a_{OB} \& \exists a_{O'A_1} \& \exists a_{O'B_1}. O \in \gamma \& A \in \gamma \xrightarrow{\text{A1.1.6}} a_{OA} \subset \gamma. O \in \gamma \& B \in \gamma \xrightarrow{\text{A1.1.6}} a_{OB} \subset \gamma. O' \in \gamma' \& A_1 \in \gamma' \xrightarrow{\text{A1.1.6}} a_{O'A_1} \subset \gamma'. O' \in \gamma' \& B_1 \in \gamma' \xrightarrow{\text{A1.1.6}} a_{O'B_1} \subset \gamma'.$ Hence $a \perp \gamma \Rightarrow a \perp a_{OA} \& a \perp a_{OB}, a \perp \gamma' \Rightarrow a \perp a_{O'A_1} \& a \perp a_{O'B_1}$.

⁴⁶⁷Obviously, the points A, M, B are non-collinear, for $M \in a \perp \gamma \cap a_{AB}, M \neq O$. In a similar manner, the points A', M, B' are also not collinear.

⁴⁶⁸This angle is referred to as the section of $\widehat{\chi\kappa}$ by α .

⁴⁶⁹Loosely speaking, one can say that the (transfinite) "number" of plane angles corresponding to the given dihedral angle with edge a equal the "number" of points on a .

⁴⁷⁰Worded another way, we can say that each of the sets \mathfrak{J} is formed by the two sides of the corresponding straight dihedral angle plus all the half-planes with the same edge inside that straight dihedral angle.

⁴⁷¹Note that each of the two sides (half-planes) of the line h' in α' is a subset of the corresponding side of the plane $\bar{\chi}'$ in space (see L 1.2.53.11).

The property P 1.3.2 in our case follows immediately from the definition of congruence of dihedral angles and L 1.3.11.1.

To check P 1.3.3 consider three half-planes χ, κ, λ with common edge a , such that κ lies inside the dihedral angle $\widehat{\chi\kappa}$. Consider further the half-planes κ', λ' with common edge a' lying on the same side of the plane χ' (with the same edge a') with the requirement that $\widehat{\chi\kappa} \equiv \widehat{\chi'\kappa'}$, $\widehat{\chi\lambda} \equiv \widehat{\chi'\lambda'}$. Denote by h, k, l the sections of χ, κ, λ , respectively, by a plane $\alpha \perp a$, drawn through a point $O \in a$ (T 1.3.43). Similarly, denote by h', k', l' the sections of χ', κ', λ' , respectively, by a plane $\alpha' \perp a'$, drawn through a point $O' \in a'$ (T 1.3.43). From definition of congruence of dihedral angles we immediately obtain $\angle(h, k) \equiv \angle(h', k')$, $\angle(h, l) \equiv \angle(h', l')$. Using C 1.2.55.24 we conclude that k', l' lie (in plane α') on the same side of the line \bar{h} . Hence $\angle(k, l) \equiv \angle(k', l')$ (T 1.3.9) and $k' \subset \text{Int}\angle(h', l')$ (P 1.3.9.5). The result now follows from definition of congruence of dihedral angles and L 1.2.55.3.

To demonstrate P 1.3.6, suppose a half-plane ν lies in a pencil \mathfrak{J} between half-planes λ, μ .⁴⁷² Suppose now that the half-planes λ, μ also belong to another pencil \mathfrak{J}' . The result then follows from L 1.2.56.3 applied to \mathfrak{J}' viewed as a straight dihedral angle.⁴⁷³ \square

Lemma 1.3.55.1. *If a dihedral angle $\widehat{\chi\kappa}$ is congruent to a dihedral angle $\widehat{\chi\kappa}$, the dihedral angle $\widehat{\chi^c\kappa}$ adjacent supplementary to the dihedral angle $\widehat{\chi\kappa}$ is congruent to the dihedral angle $\widehat{\chi^c\kappa}$ adjacent supplementary to the dihedral angle $\widehat{\chi'\kappa'}$.⁴⁷⁴*

Proof. Follows immediately from C 1.2.55.14, T 1.3.6. \square

Corollary 1.3.55.2. *Suppose $\widehat{\chi\kappa}, \widehat{\kappa\lambda}$ are two adjacent supplementary dihedral angles (i.e. $\lambda = \chi^c$) and $\widehat{\chi'\kappa'}, \widehat{\kappa'\lambda'}$ are two adjacent dihedral angles such that $\widehat{\chi\kappa} \equiv \widehat{\chi'\kappa'}$, $\widehat{\kappa\lambda} \equiv \widehat{\kappa'\lambda'}$. Then the dihedral angles $\widehat{\chi'\kappa'}, \widehat{\kappa'\lambda'}$ are adjacent supplementary, i.e. $\lambda' = \chi'^c$.*

Proof. Since, by hypothesis, the dihedral angles $\widehat{\chi'\kappa'}, \widehat{\kappa'\lambda'}$ are adjacent, by definition of adjacency the half-planes χ', λ' lie on opposite sides of $\bar{\kappa}'$. Since the dihedral angles $\widehat{\chi\kappa}, \widehat{\kappa\lambda}$ are adjacent supplementary, as are the dihedral angles $\widehat{\chi'\kappa'}, \widehat{\kappa'\lambda'}$, we have from the preceding lemma (L 1.3.55.1) $\widehat{\kappa\lambda} \equiv \widehat{\kappa'\lambda'}$. We also have, obviously, $\chi'\bar{\kappa}'\chi'^c$. Hence $\chi'\bar{\kappa}'\lambda' \& \chi'\bar{\kappa}'\chi'^c \xrightarrow{\text{L1.2.52.4}} \lambda'\chi'^c\bar{\kappa}'$. $\widehat{\kappa\lambda} \equiv \widehat{\kappa'\lambda'}$ & $\widehat{\kappa\lambda} \equiv \widehat{\kappa\chi^c}$ & $\lambda'\chi'^c\bar{\kappa}' \xrightarrow{\text{T1.3.54}} \chi'^c = \lambda'$. Thus, the dihedral angles $\widehat{\chi'\kappa'}, \widehat{\kappa'\lambda'}$ are adjacent supplementary, q.e.d. \square

Lemma 1.3.55.3. *Every dihedral angle $\widehat{\chi\kappa}$ is congruent to its vertical dihedral angle $\widehat{\chi^c\kappa^c}$.*

Proof. Follows immediately from C 1.2.55.14, T 1.3.6. \square

Corollary 1.3.55.4. *If dihedral angles $\widehat{\chi\kappa}$ and $\widehat{\chi^c\kappa'}$ (where χ^c is, as always, the half-plane complementary to the half-plane χ) are congruent and the half-planes κ, κ' lie on opposite sides of the plane $\bar{\chi}$, then the dihedral angles $\widehat{\chi\kappa}$ and $\widehat{\chi^c\kappa'}$ are vertical dihedral angles (and thus are congruent).*

*Proof.*⁴⁷⁵ By the preceding lemma (L ??) the vertical dihedral angles $\widehat{\chi\kappa}, \widehat{\chi^c\kappa^c}$ are congruent. We have also $\kappa\bar{\chi}\kappa^c \& \kappa\bar{\chi}\kappa' \xrightarrow{\text{L1.2.52.4}} \kappa^c\kappa'\bar{\chi}$. Therefore, $\widehat{\chi\kappa} \equiv \widehat{\chi^c\kappa^c}$ & $\widehat{\chi\kappa} \equiv \widehat{\chi^c\kappa'}$ & $\kappa^c\kappa'\bar{\chi} \xrightarrow{\text{T1.3.54}} \kappa' = \kappa^c$, which completes the proof. \square

Now we are in a position to obtain for half-planes/dihedral angles the results analogous to T 1.3.9, C 1.3.9.6, and P 1.3.9.7 for conventional angles.

Theorem 1.3.56. *Let χ, κ, λ and χ', κ', λ' be triples of half-planes with edges a and a' , respectively. Let also half-planes χ, κ and χ', κ' lie either both on one side or both on opposite sides of the planes λ, λ' , respectively.⁴⁷⁶ In the case when χ, κ lie on opposite sides of λ we require further that the half-planes χ, κ do not lie on one plane.⁴⁷⁷ Then congruences $\widehat{\chi\lambda} \equiv \widehat{\chi'\lambda'}$, $\widehat{\kappa\lambda} \equiv \widehat{\kappa'\lambda'}$ imply $\widehat{\chi\kappa} \equiv \widehat{\chi'\kappa'}$.*

⁴⁷²Here the pencil \mathfrak{J} is formed by the half-planes lying on the same side of a given plane α and having the same edge $a \in \alpha$, plus the two half-planes into which the line a divides the plane α .

⁴⁷³Moreover, we are then able to immediately claim that the half-plane ν lies between λ, μ in \mathfrak{J}' as well. (See also L 1.3.14.2.)

⁴⁷⁴Under the conditions of the theorem, the dihedral angle $\widehat{\chi\kappa}$ (which is obviously also adjacent supplementary to the dihedral angle $\widehat{\chi\kappa}$) is also congruent to the dihedral angle $\widehat{\chi'\kappa'}$ (adjacent supplementary to the dihedral angle $\widehat{\chi'\kappa'}$). But due to symmetry in the definition of dihedral angle, this fact adds nothing new to the statement of the theorem.

⁴⁷⁵Alternatively, to prove this corollary we can write: $\angle(h^c, k) = \text{adjsp}\angle(h, k) \& \angle(h^c, k) = \text{adj}\angle(h^c, k') \& \angle(h, k) \equiv \angle(h^c, k') \& \angle(h^c, k) \equiv \angle(h^c, k) \xrightarrow{\text{C1.3.6.1}} k' = k^c$. Hence the result follows immediately by the preceding theorem T 1.3.7.

⁴⁷⁶These conditions are met, in particular, when both $\kappa \subset \text{Int}\widehat{\chi\lambda}$, $\kappa' \subset \text{Int}\widehat{\chi'\lambda'}$ (see proof).

⁴⁷⁷In the case when χ, κ do lie on one plane, i.e. when the half-plane κ is the complementary half-plane of χ and thus the dihedral angle $\widehat{\chi\lambda}$ is adjacent supplementary to the angle $\widehat{\lambda\kappa} = \widehat{\lambda\chi^c}$, the theorem is true only if we extend the notion of dihedral angle to include straight dihedral angles and declare all straight dihedral angles congruent. In this latter case we can write $\widehat{\chi\lambda} \equiv \widehat{\chi'\lambda'}$ & $\widehat{\lambda\kappa} \equiv \widehat{\lambda'\kappa'}$ & $\widehat{\lambda\kappa} = \text{adjsp}\widehat{\chi\lambda} \& \widehat{\lambda'\kappa'} = \text{adj}\widehat{\chi'\lambda'} \xrightarrow{\text{C1.3.55.2}} \lambda' = \chi'^c$.

Proof. Take points $O \in a$, $O' \in a'$ and draw planes $\alpha \ni O$, $\alpha' \ni O'$ such that $\alpha \perp a$, $\alpha' \perp a'$. Denote by h, k, l , respectively, the sections of the half-planes χ, κ, λ by the plane α , and by h', k', l' , respectively, the sections of the half-planes χ', κ', λ' by the plane α' . Since, by hypothesis, we have $\widehat{\chi\lambda} \equiv \widehat{\chi'\lambda'}$, $\widehat{\kappa\lambda} \equiv \widehat{\kappa'\lambda'}$, using the definition of congruence of dihedral angles we see that $\angle(h, l) \equiv \angle(h', l')$, $\angle(k, l) \equiv \angle(k', l')$. Hence, taking into account C 1.2.55.24, C 1.2.55.26, and T 1.3.9, we see that $\angle(h, k) \equiv \angle(h', k')$. Finally, using the definition of congruence of dihedral angles again, we conclude that $\widehat{\chi\kappa} \equiv \widehat{\chi'\kappa'}$, q.e.d. \square

Proposition 1.3.56.5. *Let χ, κ, λ and χ', κ', λ' be triples of half-planes with edges a and a' . If the half-plane χ lies inside the dihedral angle $\widehat{\lambda\kappa}$, and the half-planes χ', κ' lie on one side of the line $\bar{\lambda}'$, the congruences $\widehat{\chi\lambda} \equiv \widehat{\chi'\lambda'}$, $\widehat{\kappa\lambda} \equiv \widehat{\kappa'\lambda'}$ imply $\chi' \subset \text{Int}\widehat{\lambda'\kappa'}$.⁴⁷⁸*

Proof. Follows from L 1.2.55.16, C 1.2.55.24, P 1.3.9.5 and the definition of interior of dihedral angle.⁴⁷⁹ \square

Corollary 1.3.56.6. *Let half-planes χ, κ and χ', κ' lie on one side of planes $\bar{\lambda}$ and $\bar{\lambda}'$, and let the dihedral angles $\widehat{\lambda\chi}$, $\widehat{\lambda\kappa}$ be congruent, respectively, to the dihedral angles $\widehat{\lambda'\chi'}$, $\widehat{\lambda'\kappa'}$. Then if the half-plane χ' lies outside the dihedral angle $\widehat{\lambda'\kappa}$, the half-plane χ lies outside the dihedral angle $\widehat{\lambda\kappa}$.*

Proof. Indeed, if $\chi = \kappa$ then $\chi = \kappa$ & $\widehat{\lambda\chi} \equiv \widehat{\lambda'\chi'}$ & $\widehat{\lambda\kappa} \equiv \widehat{\lambda'\kappa'}$ & $\chi' \subset \text{Int}\widehat{\lambda'\kappa'}$ $\stackrel{T1.3.54}{\implies}$ $\widehat{\lambda'\chi'} = \widehat{\lambda'\kappa'} \Rightarrow \chi' = \kappa'$ - a contradiction; if $\chi \subset \text{Int}\widehat{\lambda\kappa}$ then $\chi \subset \text{Int}\widehat{\lambda\kappa}$ & $\chi' \subset \text{Int}\widehat{\lambda'\kappa'}$ & $\widehat{\lambda\chi} \equiv \widehat{\lambda'\chi'}$ & $\widehat{\lambda\kappa} \equiv \widehat{\lambda'\kappa'}$ $\stackrel{P1.3.56.5}{\implies}$ $\chi' \subset \text{Int}\widehat{\lambda'\kappa'}$ - a contradiction. \square

Proposition 1.3.56.7. *Let a dihedral angle $\widehat{\lambda\kappa}$ be congruent to an angle $\widehat{\lambda'\kappa'}$. Then for any half-plane χ with the same edge as λ, κ , lying inside the dihedral angle $\widehat{\lambda\kappa}$, there is exactly one half-plane χ' with the same edge as λ', κ' , lying inside the dihedral angle $\widehat{\lambda'\kappa'}$ such that $\widehat{\lambda\chi} \equiv \widehat{\lambda'\chi'}$, $\widehat{\chi\kappa} \equiv \widehat{\chi'\kappa'}$.*

Proof. Using T 1.3.54, choose χ' so that $\chi' \subset \text{Int}\widehat{\lambda'\kappa'}$ & $\widehat{\lambda\chi} \equiv \widehat{\lambda'\chi'}$. The rest follows from P 1.3.56.5, T 1.3.56. \square

An (extended) dihedral angle $\widehat{\chi'\kappa'}$ is said to be less than or congruent to an (extended) dihedral angle $\widehat{\chi\kappa}$ if there is a dihedral angle $\widehat{\lambda\mu}$ with the same edge a as $\widehat{\chi\kappa}$ such that the dihedral angle $\widehat{\chi'\kappa'}$ is congruent to the dihedral angle $\widehat{\lambda\mu}$ and the interior of the dihedral angle $\widehat{\lambda\mu}$ is included in the interior of the dihedral angle $\widehat{\chi\kappa}$. If $\widehat{\chi'\kappa'}$ is less than or congruent to $\widehat{\chi\kappa}$, we shall write this fact as $\widehat{\chi'\kappa'} \leq \widehat{\chi\kappa}$. If a dihedral angle $\widehat{\chi'\kappa'}$ is less than or congruent to a dihedral angle $\widehat{\chi\kappa}$, we shall also say that the dihedral angle $\widehat{\chi\kappa}$ is greater than or congruent to the dihedral angle $\widehat{\chi'\kappa'}$, and write this as $\widehat{\chi\kappa} \geq \widehat{\chi'\kappa'}$.

A dihedral angle congruent to its adjacent supplementary dihedral angle will be referred to as a right dihedral angle.

Lemma 1.3.56.8. *Any plane angle $\angle(h, k)$ of a right dihedral angle $\widehat{\chi\kappa}$ is a right angle. Conversely, any dihedral angle $\widehat{\chi\kappa}$ having a right plane angle $\angle(h, k)$ is right.*

Proof. Follows from the definition of congruence of dihedral angles and C 1.2.55.14. \square

Lemma 1.3.56.9. *Any dihedral angle $\widehat{\chi'\kappa'}$, congruent to a right dihedral angle $\widehat{\chi\kappa}$, is a right dihedral angle.*

Proof. Denote by $\angle(h, k)$, $\angle(h', k')$ plane angles (chosen arbitrarily) of $\widehat{\chi\kappa}$, $\widehat{\chi'\kappa'}$, respectively. By the preceding lemma (L 1.3.56.8) $\angle(h, k)$ is a right angle. From definition of congruence of dihedral angles we have $\angle(h, k) \equiv \angle(h', k')$. Hence by L ?? the angle $\angle(h', k')$ is a right angle. Using the preceding lemma (L 1.3.56.8) again, we see that $\widehat{\chi\kappa}$ is a right dihedral angle, as required. \square

If half-planes χ, κ form a right dihedral angle $\widehat{\chi\kappa}$, the plane $\bar{\chi}$ is said to be perpendicular, or orthogonal, to the plane $\bar{\kappa}$. If a plane α is perpendicular to a plane β , we write this as $\alpha \perp \beta$.

Lemma 1.3.56.10. *Orthogonality of planes is symmetric, i.e. $\alpha \perp \beta$ implies $\beta \perp \alpha$.*

Proof. \square

Lemma 1.3.56.11. *Suppose $\alpha \perp \beta$ and $\gamma \perp c$, where $c = \alpha \cap \beta$. Then the lines $c, b = \alpha \cap \gamma, a = \beta \cap \gamma$ are mutually perpendicular (i.e. each is so to each), and so are the planes α, β, γ . Also, $a \perp \alpha, b \perp \beta$.*

Proof. Since, by hypothesis, the line c is perpendicular to the plane γ , by definition of orthogonality of a line and a plane the line c is perpendicular to any line in γ through O , where $O = c \cap \gamma = \alpha \cap \beta \cap \gamma$ is the point where the line c meets the plane γ . In particular, we have $c \perp a, c \perp b$. Also, we see that $a \perp b$, for the angle between lines a, b is a plane angle of the dihedral angle between planes α, β (see L 1.3.56.8). Since $a \perp c \subset \alpha, a \perp b \subset \alpha, a \ni O = b \cap c$, from T 1.3.41 we see that the line a is perpendicular to the plane α . Similarly, $b \perp \beta$. Finally, since $a \perp b$ and the angle between

\square

⁴⁷⁸ According to T 1.3.56, they also imply in this case $\widehat{\chi\kappa} \equiv \widehat{\chi'\kappa'}$.

⁴⁷⁹ At the outset we proceed exactly as in the proof of the preceding theorem. Then we use L 1.2.55.16 to show that $h \subset \angle(k, l)$ and C 1.2.55.24 to show that $h' \subset \angle(k', l')$.

If a dihedral angle $\widehat{\chi'\kappa'}$ is less than or congruent to a dihedral angle $\widehat{\chi\kappa}$, and, on the other hand, the dihedral angle $\widehat{\chi'\kappa'}$ is known to be incongruent (not congruent) to the dihedral angle $\widehat{\chi\kappa}$, we say that the dihedral angle $\widehat{\chi'\kappa'}$ is strictly less⁴⁸⁰ than the dihedral angle $\widehat{\chi\kappa}$, and write this as $\widehat{\chi'\kappa'} < \widehat{\chi\kappa}$. If a dihedral angle $\widehat{\chi'\kappa'}$ is (strictly) less than a dihedral angle $\widehat{\chi\kappa}$, we shall also say that the dihedral angle $\widehat{\chi\kappa}$ is strictly greater⁴⁸¹ than the dihedral angle $\widehat{\chi'\kappa'}$.

Obviously, this definition implies that any proper (non-straight) dihedral angle is less than a straight dihedral angle.

We are now in a position to prove for dihedral angles the properties of the relations "less than" and "less than or congruent to" (and, for that matter, the properties of the relations "greater than" and greater than or congruent to") analogous to those of the corresponding relations of (point) intervals and conventional angles.

Comparison of Dihedral Angles

Lemma 1.3.56.12. *For any half-plane λ having the same edge as the half-planes χ , κ and lying inside the dihedral angle $\widehat{\chi\kappa}$ formed by them, there are dihedral angles μ , ν with the same edge as χ , κ , λ and lying inside $\widehat{\chi\kappa}$, such that $\widehat{\chi\kappa} \equiv \widehat{\mu\nu}$.*

Proof. See T 1.3.54, L 1.3.15.1. \square

The following lemma is opposite, in a sense, to L 1.3.56.12

Lemma 1.3.56.13. *For any two (distinct) half-planes μ , ν sharing the edge with the half-planes χ , κ and lying inside the dihedral angle $\widehat{\chi\kappa}$ formed by them, there is exactly one half-plane λ with the same edge as χ , κ , λ , μ and lying inside $\widehat{\chi\kappa}$ such that $\widehat{\mu\nu} \equiv \widehat{\chi\kappa}$.*

Proof. See T 1.3.54, L 1.3.15.2.

Lemma 1.3.56.14. *A dihedral angle $\widehat{\chi'\kappa'}$ is (strictly) less than an angle $\widehat{\chi\kappa}$ iff:*

- 1. *There exists a half-plane λ sharing the edge with the half-planes χ , κ and lying inside the dihedral angle $\widehat{\chi\kappa}$ formed by them, such that the dihedral angle $\widehat{\chi'\kappa'}$ is congruent to the dihedral angle $\widehat{\chi\lambda}$;⁴⁸² or*
- 2. *There are half-planes μ , ν sharing the edge with the half-planes χ , κ and lying inside the dihedral angle $\widehat{\chi\kappa}$ such that $\widehat{\chi'\kappa'} \equiv \angle(\mu, \nu)$.*

In other words, a dihedral angle $\widehat{\chi'\kappa'}$ is strictly less than a dihedral angle $\widehat{\chi\kappa}$ iff there is a dihedral angle $\widehat{\lambda\mu}$, whose sides have the same edge as χ , κ and both lie on a half-open dihedral angular interval $[\chi\kappa)$ (half-closed dihedral angular interval $(\chi\kappa]$), such that the dihedral angle $\widehat{\chi'\kappa'}$ is congruent to the dihedral angle $\widehat{\lambda\mu}$.

Proof. See T 1.3.54, L 1.3.15.3. \square

Observe that the lemma L 1.3.56.14 (in conjunction with A 1.3.4) indicates that we can lay off from any half-plane a dihedral angle less than a given dihedral angle. Thus, there is actually no such thing as the least possible dihedral angle.

Corollary 1.3.56.15. *If a half-plane λ shares the edge with half-planes χ , κ and lies inside the dihedral angle $\widehat{\chi\kappa}$ formed by them, the dihedral angle $\widehat{\chi\lambda}$ is (strictly) less than the dihedral angle $\widehat{\chi\kappa}$.*

If two (distinct) half-planes μ , ν share the edge with half-planes χ , κ and both lie inside the dihedral angle $\widehat{\chi\kappa}$ formed by them, the dihedral angle $\widehat{\mu\nu}$ is (strictly) less than the dihedral angle $\widehat{\chi\kappa}$.

Suppose half-planes κ , λ share the edge with the half-plane χ and lie on the same side of the plane $\bar{\chi}$. Then the inequality $\widehat{\chi\kappa} < \widehat{\chi\lambda}$ implies $\kappa \subset \text{Int}\widehat{\chi\lambda}$.

Proof. See T 1.3.54, C 1.3.15.4, L 1.2.55.22. \square

Lemma 1.3.56.16. *A dihedral angle $\widehat{\chi'\kappa'}$ is less than or congruent to a dihedral angle $\widehat{\chi\kappa}$ iff there are half-planes λ , μ with the same edge as χ , κ and lying on the closed dihedral angular interval $[\chi\kappa]$, such that the dihedral angle $\widehat{\chi\kappa}$ is congruent to the dihedral angle $\widehat{\lambda\mu}$.*

Proof. See T 1.3.54, L 1.3.15.5. \square

Lemma 1.3.56.17. *If a dihedral angle $\widehat{\chi''\kappa''}$ is congruent to a dihedral angle $\widehat{\chi'\kappa'}$ and the dihedral angle $\widehat{\chi'\kappa'}$ is less than a dihedral angle $\widehat{\chi\kappa}$, the dihedral angle $\widehat{\chi''\kappa''}$ is less than the dihedral angle $\widehat{\chi\kappa}$.*

Proof. See T 1.3.54, L 1.3.15.6. \square

⁴⁸⁰We shall usually omit the word 'strictly'.

⁴⁸¹Again, the word 'strictly' is normally omitted

⁴⁸²Again, we could have said here also that $\widehat{\chi'\kappa'} < \widehat{\chi\kappa}$ iff there is a half-plane $\phi \subset \text{Int}\widehat{\chi\kappa}$ sharing the edge with χ , κ such that $\widehat{\chi'\kappa'} \equiv \widehat{\chi\phi}$, but because of symmetry this adds nothing new to the statement of the theorem, so we do not need to consider this case separately.

Lemma 1.3.56.18. *If a dihedral angle $\widehat{\chi''\kappa''}$ is less than a dihedral angle $\widehat{\chi'\kappa'}$ and the dihedral angle $\widehat{\chi'\kappa'}$ is congruent to a dihedral angle $\widehat{\chi\kappa}$, the dihedral angle $\widehat{\chi''\kappa''}$ is less than the dihedral angle $\widehat{\chi\kappa}$.*

Proof. See T 1.3.54, L 1.3.15.7. \square

Lemma 1.3.56.19. *If a dihedral angle $\widehat{\chi''\kappa''}$ is less than a dihedral angle $\widehat{\chi'\kappa'}$ and the dihedral angle $\widehat{\chi'\kappa'}$ is less than a dihedral angle $\widehat{\chi\kappa}$, the dihedral angle $\widehat{\chi''\kappa''}$ is less than the dihedral angle $\widehat{\chi\kappa}$.*

Proof. See T 1.3.54, L 1.3.15.8. \square

Lemma 1.3.56.20. *If a dihedral angle $\widehat{\chi''\kappa''}$ is less than or congruent to a dihedral angle $\widehat{\chi'\kappa'}$ and the dihedral angle $\widehat{\chi'\kappa'}$ is less than or congruent to a dihedral angle $\widehat{\chi\kappa}$, the dihedral angle $\widehat{\chi''\kappa''}$ is less than or congruent to the dihedral angle $\widehat{\chi\kappa}$.*

Proof. See T 1.3.54, L 1.3.15.9. \square

Lemma 1.3.56.21. *If a dihedral angle $\widehat{\chi'\kappa'}$ is less than a dihedral angle $\widehat{\chi\kappa}$, the dihedral angle $\widehat{\chi\kappa}$ cannot be less than the dihedral angle $\widehat{\chi'\kappa'}$.*

Proof. See T 1.3.54, L 1.3.15.10. \square

Lemma 1.3.56.22. *If a dihedral angle $\widehat{\chi'\kappa'}$ is less than a dihedral angle $\widehat{\chi\kappa}$, it cannot be congruent to that dihedral angle.*

Proof. See T 1.3.54, L 1.3.15.11. \square

Corollary 1.3.56.23. *If a dihedral angle $\widehat{\chi'\kappa'}$ is congruent to a dihedral angle $\widehat{\chi\kappa}$, neither $\widehat{\chi'\kappa'}$ is less than $\widehat{\chi\kappa}$, nor $\widehat{\chi\kappa}$ is less than $\widehat{\chi'\kappa'}$.*

Proof. See T 1.3.54, C 1.3.15.12. \square

Lemma 1.3.56.24. *If a dihedral angle $\widehat{\chi'\kappa'}$ is less than or congruent to a dihedral angle $\widehat{\chi\kappa}$ and the angle $\widehat{\chi\kappa}$ is less than or congruent to the dihedral angle $\widehat{\chi'\kappa'}$, the dihedral angle $\widehat{\chi'\kappa'}$ is congruent to the dihedral angle $\widehat{\chi\kappa}$.*

Proof. See T 1.3.54, L 1.3.15.13. \square

Lemma 1.3.56.25. *If a dihedral angle $\widehat{\chi'\kappa'}$ is not congruent to a dihedral angle $\widehat{\chi\kappa}$, then either the dihedral angle $\widehat{\chi'\kappa'}$ is less than the dihedral angle $\widehat{\chi\kappa}$, or the dihedral angle $\widehat{\chi\kappa}$ is less than the angle $\widehat{\chi'\kappa'}$.*

Proof. See T 1.3.54, L 1.3.15.14. \square

Lemma 1.3.56.26. *If a dihedral angle $\widehat{\chi'\kappa'}$ is less than a dihedral angle $\widehat{\chi\kappa}$, the dihedral angle $\widehat{\chi'^c\kappa'^c}$ adjacent supplementary to the former is greater than the dihedral angle $\widehat{\chi^c\kappa^c}$ adjacent supplementary to the latter.*

Proof. $\widehat{\chi'\kappa'} < \widehat{\chi\kappa} \xrightarrow{\text{L1.3.56.14}} \exists \lambda \subset \widehat{\chi\kappa} \ \& \ \widehat{\chi'\kappa'} \equiv \widehat{\chi\lambda} \xrightarrow{\text{P1.3.56.7}} \exists \kappa' \ \kappa' \subset \text{Int}\widehat{\chi'\lambda'} \ \& \ \widehat{\chi\kappa} \equiv \widehat{\chi'\lambda'}. \ \kappa' \subset \text{Int}\widehat{\chi'\lambda'} \xrightarrow{\text{L1.2.55.27}} \lambda' \subset \text{Int}\widehat{\chi'^c\kappa'^c}. \text{ Also, } \widehat{\chi\kappa} \equiv \widehat{\chi'\lambda'} \xrightarrow{\text{L1.3.55.1}} \widehat{\chi^c\kappa^c} \equiv \widehat{\chi'\lambda'}. \text{ Finally, } \lambda' \subset \text{Int}\widehat{\chi'\kappa'} \ \& \ \widehat{\chi^c\kappa^c} \equiv \widehat{\chi'\lambda'} \xrightarrow{\text{L1.3.56.14}} \widehat{\chi^c\kappa^c} < \widehat{\chi'^c\kappa'^c}. \ \square$

Lemma 1.3.56.27. *Suppose $\angle(h, k)$, $\angle(h', k')$ are plane angles of the angles $\widehat{\chi\kappa}$, $\widehat{\chi'\kappa'}$, respectively. Then $\angle(h, k) < \angle(h', k')$ implies $\widehat{\chi\kappa} < \widehat{\chi'\kappa'}$.*

Proof. By hypothesis, the angles $\angle(h, k)$, $\angle(h', k')$ are, respectively, the sections of the dihedral angles $\widehat{\chi\kappa}$, $\widehat{\chi'\kappa'}$ by planes α , α' drawn perpendicular to the edges a , a' of $\widehat{\chi\kappa}$, $\widehat{\chi'\kappa'}$. Since $\angle(h, k) < \angle(h', k')$, there is a ray $l' \subset \text{Int}\angle(h', k')$ such that $\angle(h, k) \equiv \angle(h', l')$ (see L 1.3.16.3). Drawing a plane β through a' and a point $L' \in l'$ (see T ??), from L 1.2.55.3 we have $\lambda' \subset \text{Int}\widehat{\chi'\kappa'}$, where λ' is the half-plane with edge a containing L' . Since also, obviously, $\widehat{\chi\kappa} \equiv \widehat{\chi\lambda'}$ (by definition of congruence of dihedral angles), we obtain the desired result. \square

The following lemma is converse, in a sense, to the one just proved.

Lemma 1.3.56.28. *Suppose that a dihedral angle $\widehat{\chi\kappa}$ is less than a dihedral angle $\widehat{\chi'\kappa'}$. Then any plane angle $\angle(h, k)$ of $\widehat{\chi\kappa}$ is less than any plane angle $\angle(h', k')$ of $\widehat{\chi'\kappa'}$.*

Proof. By hypothesis, the angles $\angle(h, k)$, $\angle(h', k')$ are, respectively, the sections of the dihedral angles $\widehat{\chi\kappa}$, $\widehat{\chi'\kappa'}$ by planes α , α' drawn perpendicular to the edges a , a' of $\widehat{\chi\kappa}$, $\widehat{\chi'\kappa'}$. Since $\widehat{\chi\kappa} < \widehat{\chi'\kappa'}$, there is a half-plane $\lambda' \subset \text{Int}\widehat{\chi\kappa}$ such that $\widehat{\chi\kappa} \equiv \widehat{\chi\lambda'}$ (see L 1.3.55.3). Denote by l' the section of the half-plane λ' by the plane α' (l' is a ray by L 1.2.19.13). Using L 1.2.55.16, we see that $l' \subset \text{Int}\angle(h', k')$. Since also, obviously, $\angle(h, k) \equiv \angle(h', l')$ (by definition of congruence of dihedral angles), from L 1.3.16.3 we see that $\angle(h, k) < \angle(h', k')$, as required.

Acute, Obtuse and Right Dihedral Angles

A dihedral angle which is less than (respectively, greater than) its adjacent supplementary dihedral angle is called an acute (obtuse) dihedral angle.

Obviously, any dihedral angle is either an acute, right, or obtuse dihedral angle, and each of these attributes excludes the others. Also, the dihedral angle, adjacent supplementary to an acute (obtuse) dihedral angle, is obtuse (acute).

Furthermore, any plane angle of an acute (obtuse) dihedral angle is an acute angle. Conversely, if a plane angle of a given dihedral angle is acute (obtuse), the dihedral angle itself is acute (obtuse), as the following two lemmas show.

Lemma 1.3.56.29. *A dihedral angle $\widehat{\chi'\kappa'}$ congruent to an acute dihedral angle $\widehat{\chi\kappa}$ is also an acute dihedral angle. Similarly, a dihedral angle $\widehat{\chi'\kappa'}$ congruent to an obtuse dihedral angle $\widehat{\chi\kappa}$ is also an obtuse dihedral angle.*

Proof. Follows from L 1.3.56.27, L 1.3.16.16, L 1.3.56.28. \square

Lemma 1.3.56.30. *Any acute dihedral angle $\widehat{\chi'\kappa'}$ is less than any right dihedral angle $\widehat{\chi\kappa}$.*

Proof. Follows from L 1.3.56.27, L 1.3.16.17, L 1.3.56.28. \square

Lemma 1.3.56.31. *Any obtuse dihedral angle $\widehat{\chi'\kappa'}$ is greater than any right dihedral angle $\widehat{\chi\kappa}$.* ⁴⁸³

Proof. Follows from L 1.3.56.27, L 1.3.16.18, L 1.3.56.28. \square

Lemma 1.3.56.32. *Any acute dihedral angle is less than any obtuse dihedral angle.*

Proof. Follows from L 1.3.56.27, L 1.3.16.19, L 1.3.56.28. \square

Lemma 1.3.56.33. *A dihedral angle less than a right dihedral angle is acute. A dihedral angle greater than a right dihedral angle is obtuse.*

Theorem 1.3.56. *All right dihedral angles are congruent.*

Proof. Follows from L 1.3.56.8, T 1.3.16. \square

Lemma 1.3.56.21. *Suppose that half-planes χ, κ, λ have the same initial edge, as do half-planes χ', κ', λ' . Suppose, further, that $\widehat{\chi\bar{\kappa}\lambda}$ and $\widehat{\chi'\bar{\kappa}'\lambda'}$ (i.e. the half-planes χ, λ and χ', λ' lie on opposite sides of the planes $\bar{\kappa}, \bar{\kappa}'$, respectively, that is, the dihedral angles $\widehat{\chi\bar{\kappa}}, \widehat{\bar{\kappa}\lambda}$ are adjacent, as are dihedral angles $\widehat{\chi'\bar{\kappa}'}, \widehat{\bar{\kappa}'\lambda'}$) and $\widehat{\chi\bar{\kappa}} \equiv \widehat{\chi'\bar{\kappa}'}, \widehat{\bar{\kappa}\lambda} \equiv \widehat{\bar{\kappa}'\lambda'}$. Then the half-planes κ, λ lie on the same side of the plane $\bar{\chi}$ iff the half-planes κ', λ' lie on the same side of the plane $\bar{\chi}'$, and the half-planes κ, λ lie on opposite sides of the plane $\bar{\chi}$ iff the rays κ', λ' lie on opposite sides of the plane $\bar{\chi}$.*

Proof. Suppose that $\kappa\lambda\bar{\chi}$. Then certainly $\lambda' \neq \chi'^c$, for otherwise in view of C 1.3.55.2 we would have $\lambda = \chi'^c$. Suppose now $\kappa'\bar{\chi}'\lambda'$. Using L 1.2.55.32 we can write $\lambda \subset \text{Int}\widehat{\chi\bar{\kappa}\kappa}, \chi'^c \subset \text{Int}\widehat{\chi'\bar{\kappa}'\lambda'}$. In addition, $\widehat{\chi\bar{\kappa}} \equiv \widehat{\chi'\bar{\kappa}'}$ ^{T1.3.55.1} $\widehat{\chi^c\bar{\kappa}} = \text{adjsp}\widehat{\chi\bar{\kappa}} \equiv \text{adsp}\widehat{\chi'\bar{\kappa}'} = \widehat{\chi'^c\bar{\kappa}'}$. Hence, using C 1.3.56.15, L 1.3.56.17 – L 1.3.56.19, we can write $\widehat{\bar{\kappa}\lambda} < \widehat{\bar{\kappa}'\lambda'} \equiv \widehat{\chi'^c\bar{\kappa}'} < \widehat{\bar{\kappa}'\lambda'} \Rightarrow \widehat{\bar{\kappa}\lambda} < \widehat{\bar{\kappa}'\lambda'}$. Since, however, we have $\widehat{\chi\bar{\lambda}} \equiv \widehat{\chi'\bar{\lambda}'}$ by T 1.3.56, we arrive at a contradiction in view of L 1.3.56.22. Thus, we have $\kappa'\bar{\chi}'\lambda'$ as the only remaining option. \square

Suppose two planes α, β have a common line a . Suppose further that the planes α, β are separated by the line a into the half-planes χ, χ^c and κ, κ^c , respectively. Obviously, we have either $\widehat{\chi\bar{\kappa}} \leq \widehat{\chi^c\bar{\kappa}}$ or $\widehat{\chi^c\bar{\kappa}} \leq \widehat{\chi\bar{\kappa}}$. If the dihedral angle $\widehat{\chi\bar{\kappa}}$ is not greater than the dihedral angle $\angle(\chi^c, \kappa)$ adjacent supplementary to it, the dihedral angle $\widehat{\chi\bar{\kappa}}$, as well as the dihedral angle $\widehat{\chi^c\bar{\kappa}}$ will sometimes be (loosely ⁴⁸⁴) referred to as the dihedral angle between the planes α, β . ⁴⁸⁵

Proposition 1.3.56.22. *Suppose α, β are two (distinct) planes drawn through a common point O and points P, Q are chosen so that $a_{OP} \perp \alpha, a_{OP} \perp \beta$. Then any plane angle of the dihedral angle between α, β is congruent either to the angle $\angle POQ$ or to the angle adjacent supplementary to $\angle POQ$.*

Proof. \square

Proposition 1.3.56.23. *Suppose α, β are two (distinct) planes drawn through a common point O and points P, Q are chosen so that $a_{OP} \perp \alpha, a_{OP} \perp \beta$. Then any plane angle of the dihedral angle between α, β is congruent either to the angle $\angle POQ$ or to the angle adjacent supplementary to $\angle POQ$.*

Proof. \square

??

⁴⁸³In different words: Any right dihedral angle is less than any obtuse dihedral angle.

⁴⁸⁴Strictly speaking, we should refer to the appropriate classes of congruence instead, but that would be overly pedantic.

⁴⁸⁵It goes without saying that in the case $\widehat{\chi^c\bar{\kappa}} \leq \widehat{\chi\bar{\kappa}}$ it is the dihedral angle $\widehat{\chi^c\bar{\kappa}}$ that is referred to as the dihedral angle between the planes α, β .

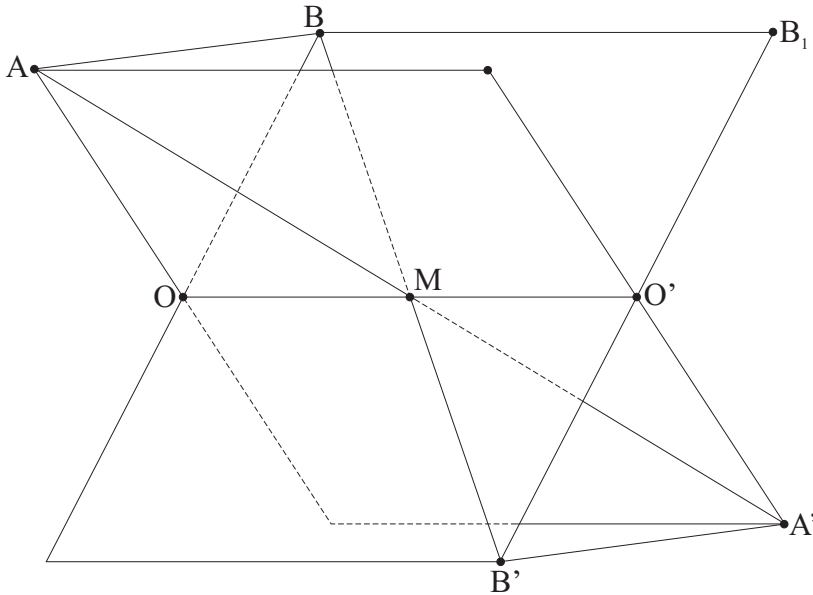

Figure 1.168:

Theorem 1.3.58. *Suppose we are given:*

- A figure \mathcal{A} containing at least four non-coplanar points;
- A plane α ;
- A line $a \subset \alpha$, containing a point O of \mathcal{A} and a point A (not necessarily lying in \mathcal{A});
- A point E lying in plane α not on a ;
- A point P lying outside α ;
- A line a' lying in a plane α' , two distinct points O', A' on a' , a point E' lying in α' not on a' , and a point P' lying outside α' .

Then there exists exactly one motion $f : \mathcal{A} \rightarrow \mathcal{A}'$ and, correspondingly, one figure \mathcal{A}' , such that:

1. $O' = f(O)$.
2. If A, B lie on line a on the same side (on opposite sides) of the point O , then the points A' and $B' = f(B)$ also lie on line a' on the same side (on opposite sides) of the point O' .
3. If E, F lie in plane α on the same side (on opposite sides) of the line a , then the points E' and $F' = f(F)$ also lie (in plane α') on the same side (on opposite sides) of the line a' .
3. If P, Q lie on the same side (on opposite sides) of the plane α , then the points P' and $Q' = f(Q)$ also lie on the same side (on opposite sides) of the plane α' .

486

Proof. \square

Denote by $\mu\mathcal{AB}$ the equivalence class of congruent generalized intervals, containing a generalized interval \mathcal{AB} . This class consists of all generalized intervals $\mathcal{CD} \in \mathcal{I}$ congruent to the given generalized interval $\mathcal{AB} \in \mathcal{I}$. We define addition of classes of congruent generalized intervals as follows: Take an element \mathcal{AB} of the first class $\mu\mathcal{AB}$. Suppose that we are able to lay off the generalized interval \mathcal{BC} of the second class $\mu\mathcal{BC}$ into the generalized ray $\mathcal{B}\mathcal{A}'$, complementary to the generalized ray $\mathcal{A}\mathcal{B}$.⁴⁸⁷ Then the sum of the classes $\mathcal{AB}, \mathcal{BC}$ is, by definition, the class $\mu\mathcal{AC}$, containing the generalized interval \mathcal{AC} . Note that this addition of classes is well defined, for $\mathcal{AB} \equiv \mathcal{A}_1\mathcal{B}_1$ & $\mathcal{BC} \equiv \mathcal{B}_1\mathcal{C}_1$ & $[\mathcal{ABC}] \equiv [\mathcal{A}_1\mathcal{B}_1\mathcal{C}_1] \xrightarrow{\text{Pr1.3.3}} \mathcal{AC} \equiv \mathcal{A}_1\mathcal{C}_1$, which implies that the result of summation does not depend on the choice of representatives in each class. Thus, put simply, we have $[\mathcal{ABC}] \Rightarrow \mu\mathcal{AC} = \mu\mathcal{AB} + \mu\mathcal{BC}$. Conversely, the notation $\mathcal{AC} \in \mu_1 + \mu_2$ means that there is a geometric object \mathcal{B} such that $[\mathcal{ABC}]$ and $\mathcal{AB} \in \mu_1, \mathcal{BC} \in \mu_2$.

In the case when $\mu\mathcal{AB} + \mu\mathcal{CD} = \mu\mathcal{EF}$ and $\mathcal{A}'\mathcal{B}' \equiv \mathcal{AB}, \mathcal{C}'\mathcal{D}' \equiv \mathcal{CD}, \mathcal{E}'\mathcal{F}' \equiv \mathcal{EF}$ (that is, when $\mu\mathcal{AB} + \mu\mathcal{CD} = \mu\mathcal{EF}$ and $\mathcal{A}'\mathcal{B}' \in \mu\mathcal{AB}, \mathcal{C}'\mathcal{D}' \in \mu\mathcal{CD}, \mathcal{E}'\mathcal{F}' \in \mu\mathcal{EF}$), we can say, with some abuse of terminology, that the generalized interval $\mathcal{E}'\mathcal{F}'$ is the sum of the generalized intervals $\mathcal{A}'\mathcal{B}', \mathcal{C}'\mathcal{D}'$.

The addition (of classes of congruent generalized intervals) thus defined has the properties of commutativity and associativity, as the following two theorems (T 1.3.59, T 1.3.60) indicate:

⁴⁸⁶That is, for $Q \in \mathcal{A}$ if $Q \in \alpha_P$ then $Q' \in \alpha'_{P'}$ and $Q \in \alpha_P^c$ implies $Q' \in \alpha'_{P'}^c$.

⁴⁸⁷In other words, we must be in a position to take a geometric object $\mathcal{C} \in \mathcal{B}_A^c$ (recall that $\mathcal{C} \in \mathcal{B}_A^c$ means that $[\mathcal{ABC}]$, see L 1.2.29.2) such that the generalized interval \mathcal{BC} lies in the second class, which we denote $\mu\mathcal{BC}$. The notation employed here is perfectly legitimate: we know that $\mathcal{A}_1\mathcal{B}_1 \in \mu\mathcal{AB} \Rightarrow \mathcal{A}_1\mathcal{B}_1 \equiv \mathcal{AB} \Rightarrow \mu\mathcal{A}_1\mathcal{B}_1 = \mu\mathcal{AB}$. As in the case of classes of (traditional) congruent intervals, in our future treatment of classes of congruent generalized intervals we shall often resort to this convenient abuse of notation. Although we have agreed previously to use Greek letters to denote planes, we shall sometimes use the letter μ (possibly with subscripts) without the accompanying name of defining representative to denote congruence classes of generalized intervals whenever giving a particular defining representative for a class is not relevant.

Theorem 1.3.59. *The addition of classes of congruent generalized intervals is commutative: For any classes μ_1, μ_2 , for which the addition is defined, we have $\mu_1 + \mu_2 = \mu_2 + \mu_1$.*

Proof. Suppose $A'C' \in \mu_1 + \mu_2$. According to our definition of the addition of classes of congruent generalized intervals this means that there is a generalized interval \mathcal{AC} such that $[ABC]$ and $\mathcal{AB} \in \mu_1 = \mu\mathcal{AB}, \mathcal{BC} \in \mu_2 = \mu\mathcal{BC}$. But the fact that $\mathcal{CB} \in \mu_2 = \mu\mathcal{CB}, \mathcal{BA} \in \mu_1 = \mu\mathcal{BA}, [CBA]$, and $A'C' \equiv \mathcal{CA}$ implies $A'C' \in \mu_2 + \mu_1$. Thus, we have proved that $\mu_1 + \mu_2 \subset \mu_2 + \mu_1$ for any two classes μ_1, μ_2 of congruent generalized intervals. By symmetry, we immediately have $\mu_2 + \mu_1 \subset \mu_1 + \mu_2$. Hence $\mu_1 + \mu_2 = \mu_2 + \mu_1$, q.e.d. \square

Theorem 1.3.60. *The addition of classes of congruent generalized intervals is associative: For any classes μ_1, μ_2, μ_3 , for which the addition is defined, we have $(\mu_1 + \mu_2) + \mu_3 = \mu_1 + (\mu_2 + \mu_3)$.*

Proof. Suppose $\mathcal{AD} \in (\mu_1 + \mu_2) + \mu_3$. Then there is a geometric object \mathcal{C} such that $[\mathcal{ACD}]$ and $\mathcal{AC} \in \mu_1 + \mu_2, \mathcal{CD} \in \mu_3$. In its turn, $\mathcal{AC} \in \mu_1 + \mu_2$ implies that $\exists \mathcal{B} [ABC] \& \mathcal{AB} \in \mu_1 \& \mathcal{BC} \in \mu_2$.⁴⁸⁸ We have $[ABC] \& [\mathcal{ACD}] \xrightarrow{\text{Pr1.2.7}} [\mathcal{ABD}] \& [\mathcal{BCD}]$. Hence $[\mathcal{BCD}] \& \mathcal{BC} \in \mu_2 \& \mathcal{CD} \in \mu_3 \Rightarrow \mathcal{BD} \in \mu_2 + \mu_3$. $[\mathcal{ABD}]\mathcal{AB} \in \mu_1 \& \mathcal{BD} \in \mu_2 + \mu_3 \Rightarrow \mathcal{AD} \in \mu_1 + (\mu_2 + \mu_3)$. Thus, we have proved that $(\mu_1 + \mu_2) + \mu_3 \subset \mu_1 + (\mu_2 + \mu_3)$ for any classes μ_1, μ_2, μ_3 of congruent intervals. \square

Once the associativity is established, a standard algebraic argumentation can be used to show that we may write $\mu_1 + \mu_2 + \dots + \mu_n$ for the sum of n classes $\mu_1, \mu_2, \dots, \mu_n$ of congruent generalized intervals without needing to care about where we put the parentheses.

If a class $\mu\mathcal{BC}$ of congruent generalized intervals is equal to the sum $\mu\mathcal{B}_1\mathcal{C}_1 + \mu\mathcal{B}_2\mathcal{C}_2 + \dots + \mu\mathcal{B}_n\mathcal{C}_n$ of classes $\mu\mathcal{B}_1\mathcal{C}_1, \mu\mathcal{B}_2\mathcal{C}_2, \dots, \mu\mathcal{B}_n\mathcal{C}_n$ of congruent intervals, and $\mu\mathcal{B}_1\mathcal{C}_1 = \mu\mathcal{B}_2\mathcal{C}_2 = \dots = \mu\mathcal{B}_n\mathcal{C}_n$ (that is, $\mathcal{B}_1\mathcal{C}_1 \equiv \mathcal{B}_2\mathcal{C}_2 \equiv \dots \equiv \mathcal{B}_n\mathcal{C}_n$), we write $\mu\mathcal{BC} = n\mu\mathcal{B}_1\mathcal{C}_1$ or $\mu\mathcal{B}_1\mathcal{C}_1 = (1/n)\mu\mathcal{BC}$.

Proposition 1.3.60.1. *If $\mu\mathcal{AB} + \mu\mathcal{CD} = \mu\mathcal{EF}$,⁴⁸⁹ $\mathcal{A}'\mathcal{B}' \in \mu\mathcal{AB}, \mathcal{C}'\mathcal{D}' \in \mu\mathcal{CD}, \mathcal{E}'\mathcal{F}' \in \mu\mathcal{EF}$, then $\mathcal{A}'\mathcal{B}' < \mathcal{E}'\mathcal{F}'$, $\mathcal{C}'\mathcal{D}' < \mathcal{E}'\mathcal{F}'$.*

Proof. By the definition of addition of classes of congruent generalized intervals, there are generalized intervals $\mathcal{LM} \in \mu\mathcal{AB}, \mathcal{MN} \in \mathcal{CD}, \mathcal{LN} \in \mathcal{EF}$ such that $[\mathcal{LMN}]$. By C 1.3.15.4 $\mathcal{LM} < \mathcal{LN}$. Finally, using L 1.3.14.1, L 1.3.15.6, L 1.3.15.7 we can write $\mathcal{A}'\mathcal{B}' \equiv \mathcal{AB} \& \mathcal{LM} \equiv \mathcal{AB} \& \mathcal{E}'\mathcal{F}' \equiv \mathcal{EF} \& \mathcal{LN} \equiv \mathcal{EF} \& \mathcal{LM} < \mathcal{LN} \Rightarrow \mathcal{A}'\mathcal{B}' < \mathcal{E}'\mathcal{F}'$. Similarly, $\mathcal{C}'\mathcal{D}' < \mathcal{E}'\mathcal{F}'$. \square

At this point we can introduce the following jargon. For classes $\mu\mathcal{AB}, \mu\mathcal{CD}$ or congruent generalized intervals we write $\mu\mathcal{AB} < \mu\mathcal{CD}$ or $\mu\mathcal{CD} > \mu\mathcal{AB}$ if there are generalized intervals $\mathcal{A}'\mathcal{B}' \in \mu\mathcal{AB}, \mathcal{C}'\mathcal{D}' \in \mathcal{CD}$ such that $\mathcal{A}'\mathcal{B}' < \mathcal{C}'\mathcal{D}'$. L 1.3.14.1, L 1.3.15.6, L 1.3.15.7 then show that this notation is well defined: it does not depend on the choice of the generalized intervals $\mathcal{A}'\mathcal{B}', \mathcal{C}'\mathcal{D}'$. For arbitrary classes $\mu\mathcal{AB}, \mu\mathcal{CD}$ of congruent generalized intervals we then have either $\mu\mathcal{AB} < \mu\mathcal{CD}$, or $\mu\mathcal{AB} = \mu\mathcal{CD}$, or $\mu\mathcal{AB} > \mu\mathcal{CD}$ (with the last inequality being equivalent to $\mu\mathcal{CD} < \mu\mathcal{AB}$). From L 1.3.15.11 we see also that any one of these options excludes the two others.

Proposition 1.3.60.2. *If $\mu\mathcal{AB} + \mu\mathcal{CD} = \mu\mathcal{EF}, \mu\mathcal{AB} + \mu\mathcal{GH} = \mu\mathcal{LM}$, and $\mathcal{CD} < \mathcal{GH}$, then $\mathcal{EF} < \mathcal{LM}$.*⁴⁹⁰

Proof. By hypothesis, there are generalized intervals $\mathcal{PQ} \in \mu\mathcal{AB}, \mathcal{QR} \in \mu\mathcal{CD}, \mathcal{P}'\mathcal{Q}' \in \mu\mathcal{AB}, \mathcal{Q}'\mathcal{R}' \in \mu\mathcal{GH}$, such that $[\mathcal{PQR}], [\mathcal{P}'\mathcal{Q}'\mathcal{R}']$, $\mathcal{PR} \in \mu\mathcal{EF}, \mathcal{P}'\mathcal{R}' \in \mu\mathcal{LM}$. Obviously, $\mathcal{PQ} \equiv \mathcal{AB} \& \mathcal{P}'\mathcal{Q}' \equiv \mathcal{AB} \xrightarrow{\text{T1.3.1}} \mathcal{PQ} \equiv \mathcal{P}'\mathcal{Q}'$. Using L 1.3.15.6, L 1.3.15.7 we can also write $\mathcal{QR} \equiv \mathcal{CD} \& \mathcal{CD} < \mathcal{GH} \& \mathcal{Q}'\mathcal{R}' \equiv \mathcal{GH} \Rightarrow \mathcal{QR} < \mathcal{Q}'\mathcal{R}'$. We then have $[\mathcal{PQR}] \& [\mathcal{P}'\mathcal{Q}'\mathcal{R}'] \& \mathcal{PQ} \equiv \mathcal{P}'\mathcal{Q}' \& \mathcal{QR} < \mathcal{Q}'\mathcal{R}' \xrightarrow{\text{L1.3.21.1}} \mathcal{PR} < \mathcal{P}'\mathcal{R}'$. Finally, again using L 1.3.15.6, L 1.3.15.7, we obtain $\mathcal{PR} \equiv \mathcal{EF} \& \mathcal{PR} < \mathcal{P}'\mathcal{R}' \& \mathcal{P}'\mathcal{R}' \equiv \mathcal{LM} \Rightarrow \mathcal{EF} < \mathcal{LM}$. \square

Proposition 1.3.60.3. *If $\mu\mathcal{AB} + \mu\mathcal{CD} = \mu\mathcal{EF}, \mu\mathcal{AB} + \mu\mathcal{GH} = \mu\mathcal{LM}$, and $\mathcal{EF} < \mathcal{LM}$, then $\mathcal{CD} < \mathcal{GH}$.*⁴⁹¹

Proof. We know that either $\mu\mathcal{CD} = \mu\mathcal{GH}$, or $\mu\mathcal{GH} < \mu\mathcal{CD}$, or $\mu\mathcal{CD} < \mu\mathcal{GH}$. But $\mu\mathcal{CD} = \mu\mathcal{GH}$ would imply $\mu\mathcal{EF} = \mu\mathcal{LM}$, which contradicts $\mathcal{EF} < \mathcal{LM}$ in view of L 1.3.15.11. Suppose $\mu\mathcal{GH} < \mu\mathcal{CD}$. Then, using the preceding proposition (P 1.3.60.2), we would have $\mathcal{LM} < \mathcal{EF}$, which contradicts $\mathcal{EF} < \mathcal{LM}$ in view of L 1.3.15.10. Thus, we have $\mathcal{CD} < \mathcal{GH}$ as the only remaining possibility. \square

Proposition 1.3.60.4. *A class $\mu\mathcal{BC}$ of congruent generalized intervals is equal to the sum $\mu\mathcal{B}_1\mathcal{C}_1 + \mu\mathcal{B}_2\mathcal{C}_2 + \dots + \mu\mathcal{B}_n\mathcal{C}_n$ of classes $\mu\mathcal{B}_1\mathcal{C}_1, \mu\mathcal{B}_2\mathcal{C}_2, \dots, \mu\mathcal{B}_n\mathcal{C}_n$ of congruent generalized intervals iff there are geometric objects $\mathcal{A}_0, \mathcal{A}_1, \dots, \mathcal{A}_n$ such that $[\mathcal{A}_{i-1}\mathcal{A}_i\mathcal{A}_{i+1}]$ for all $i \in \mathbb{N}_{n-1}$, $\mathcal{A}_{i-1}\mathcal{A}_i \in \mu\mathcal{B}_i\mathcal{C}_i$ for all $i \in \mathbb{N}_n$ and $\mathcal{A}_0\mathcal{A}_n \in \mu\mathcal{BC}$.*⁴⁹²

⁴⁸⁸There is a tricky point here. $\mathcal{AD} \in (\mu_1 + \mu_2) + \mu_3$ implies that there is a geometric object \mathcal{C} lying between \mathcal{A} and \mathcal{D} in some set \mathfrak{J} . In its turn, $\mathcal{AC} \in \mu_1 + \mu_2$ implies that there is a geometric object \mathcal{B} lying between \mathcal{A} and \mathcal{C} in some set \mathfrak{J}' . Note that the set \mathfrak{J}' , generally speaking, is distinct from the set \mathfrak{J} . L 1.3.14.2 asserts, however, that in this case \mathcal{B} will lie between \mathcal{A} and \mathcal{C} in \mathfrak{J} as well.

⁴⁸⁹We assume that the classes $\mu\mathcal{AB}, \mu\mathcal{CD}$ can indeed be added.

⁴⁹⁰This proposition can be formulated in more abstract terms for congruence classes μ_1, μ_2, μ_3 of generalized intervals as follows: $\mu_2 < \mu_3$ implies $\mu_1 + \mu_2 < \mu_1 + \mu_3$.

⁴⁹¹This proposition can be formulated in more abstract terms for congruence classes μ_1, μ_2, μ_3 of generalized intervals as follows: $\mu_1 + \mu_2 < \mu_1 + \mu_3$ implies $\mu_2 < \mu_3$. Note also that, due to the commutativity property of addition, $\mu_1 + \mu_2 < \mu_1 + \mu_3$ is the same as $\mu_2 + \mu_1 < \mu_3 + \mu_1$. In the future we will often implicitly use such trivial consequences of commutativity.

⁴⁹²That is, we have $\mathcal{A}_{i-1}\mathcal{A}_i \equiv \mathcal{B}_i\mathcal{C}_i$ for all $i \in \mathbb{N}_n$, and $\mathcal{A}_0\mathcal{A}_n \equiv \mathcal{BC}$.

Proof. Suppose $\mu\mathcal{BC} = \mu\mathcal{B}_1\mathcal{C}_1 + \mu\mathcal{B}_2\mathcal{C}_2 + \cdots + \mu\mathcal{B}_n\mathcal{C}_n$. We need to show that there are geometric objects $\mathcal{A}_0, \mathcal{A}_1, \dots, \mathcal{A}_n$ such that $[\mathcal{A}_{i-1}\mathcal{A}_i\mathcal{A}_{i+1}]$ for all $i \in \mathbb{N}_{n-1}$, $\mathcal{A}_{i-1}\mathcal{A}_i \equiv \mathcal{B}_i\mathcal{C}_i$ for all $i \in \mathbb{N}_n$, and $\mathcal{A}_0\mathcal{A}_n \equiv \mathcal{BC}$. For $n = 2$ this has been established previously.⁴⁹³ Suppose now that for the class $\mu_{n-1} \equiv \mu\mathcal{B}_1\mathcal{C}_1 + \mu\mathcal{B}_2\mathcal{C}_2 + \cdots + \mu\mathcal{B}_{n-1}\mathcal{C}_{n-1}$ there are geometric objects $\mathcal{A}_0, \mathcal{A}_1, \dots, \mathcal{A}_{n-1}$ such that $[\mathcal{A}_{i-1}\mathcal{A}_i\mathcal{A}_{i+1}]$ for all $i \in \mathbb{N}_{n-2}$, $\mathcal{A}_{i-1}\mathcal{A}_i \in \mu\mathcal{B}_i\mathcal{C}_i$ for all $i \in \mathbb{N}_{n-1}$, and $\mathcal{A}_0\mathcal{A}_{n-1} \in \mu_{n-1}$. Using Pr 1.3.1, choose a geometric object \mathcal{A}_n such that $\mathcal{A}_0\mathcal{A}_n \equiv \mathcal{BC}$ and the geometric objects $\mathcal{A}_{n-1}, \mathcal{A}_n$ lie on the same side of the geometric object \mathcal{A}_0 . Since, by hypothesis, $\mu\mathcal{BC} = \mu_{n-1} + \mu\mathcal{B}_n\mathcal{C}_n$, there are geometric objects $\mathcal{D}_0, \mathcal{D}_{n-1}, \mathcal{D}_n$ such that $\mathcal{D}_0\mathcal{D}_{n-1} \in \mu_{n-1}$, $\mathcal{D}_{n-1}\mathcal{D}_n \in \mu\mathcal{B}_n\mathcal{C}_n$, $\mathcal{D}_0\mathcal{D}_n \in \mu\mathcal{BC}$, and $[\mathcal{D}_0\mathcal{D}_{n-1}\mathcal{D}_n]$. Since $\mathcal{D}_0\mathcal{D}_{n-1} \in \mu_{n-1} \& \mathcal{A}_0\mathcal{A}_{n-1} \in \mu_{n-1} \Rightarrow \mathcal{D}_0\mathcal{D}_{n-1} \equiv \mathcal{A}_0\mathcal{A}_{n-1}$, $\mathcal{D}_0\mathcal{D}_n \in \mu\mathcal{BC} \& \mathcal{A}_0\mathcal{A}_n \in \mu\mathcal{BC} \Rightarrow \mathcal{D}_0\mathcal{D}_n \equiv \mathcal{A}_0\mathcal{A}_n$, $[\mathcal{D}_0\mathcal{D}_{n-1}\mathcal{D}_n]$, and $\mathcal{A}_{n-1}, \mathcal{A}_n$ lie on the same side of \mathcal{A}_0 , by Pr ?? we have $\mathcal{D}_{n-1}\mathcal{D}_n \equiv \mathcal{A}_{n-1}\mathcal{A}_n$, $[\mathcal{A}_0\mathcal{A}_{n-1}\mathcal{A}_n]$. By L 1.2.22.11 the fact that $[\mathcal{A}_{i-1}\mathcal{A}_i\mathcal{A}_{i+1}]$ for all $i \in \mathbb{N}_{n-2}$ implies that the geometric objects $\mathcal{A}_0, \mathcal{A}_1, \dots, \mathcal{A}_{n-1}$ are in order $[\mathcal{A}_0\mathcal{A}_1 \dots \mathcal{A}_{n-1}]$. In particular, we have $[\mathcal{A}_0\mathcal{A}_{n-2}\mathcal{A}_{n-1}]$. Hence, $[\mathcal{A}_0\mathcal{A}_{n-2}\mathcal{A}_{n-1}] \& [\mathcal{A}_0\mathcal{A}_{n-1}\mathcal{A}_n] \xrightarrow{\text{Pr 1.2.7}} [\mathcal{A}_{n-2}\mathcal{A}_{n-1}\mathcal{A}_n]$. Thus, we have completed the first part of the proof.

To prove the converse statement suppose that there are geometric objects $\mathcal{A}_0, \mathcal{A}_1, \dots, \mathcal{A}_n$ such that $[\mathcal{A}_{i-1}\mathcal{A}_i\mathcal{A}_{i+1}]$ for all $i \in \mathbb{N}_{n-1}$, $\mathcal{A}_{i-1}\mathcal{A}_i \in \mu\mathcal{B}_i\mathcal{C}_i$ for all $i \in \mathbb{N}_n$ and $\mathcal{A}_0\mathcal{A}_n \in \mu\mathcal{BC}$. We need to show that the class $\mu\mathcal{BC}$ of congruent generalized intervals is equal to the sum $\mu\mathcal{B}_1\mathcal{C}_1 + \mu\mathcal{B}_2\mathcal{C}_2 + \cdots + \mu\mathcal{B}_n\mathcal{C}_n$ of the classes $\mu\mathcal{B}_1\mathcal{C}_1, \mu\mathcal{B}_2\mathcal{C}_2, \dots, \mu\mathcal{B}_n\mathcal{C}_n$. For $n = 2$ this has been proved before. Denote μ_{n-1} the class containing the generalized interval $\mathcal{A}_0\mathcal{A}_{n-1}$. Now we can assume that $\mu_{n-1} = \mu\mathcal{B}_1\mathcal{C}_1 + \mu\mathcal{B}_2\mathcal{C}_2 + \cdots + \mu\mathcal{B}_{n-1}\mathcal{C}_{n-1}$.⁴⁹⁴ Since the points $\mathcal{A}_0, \mathcal{A}_1, \dots, \mathcal{A}_n$ are in the order $[\mathcal{A}_0\mathcal{A}_1 \dots \mathcal{A}_n]$ (see L 1.2.22.11), we have, in particular, $[\mathcal{A}_0\mathcal{A}_{n-1} \dots \mathcal{A}_n]$. As also $\mathcal{A}_0\mathcal{A}_{n-1} \in \mu_{n-1}$, $\mathcal{A}_{n-1}\mathcal{A}_n \in \mu\mathcal{B}_n\mathcal{C}_n$, $\mathcal{A}_0\mathcal{A}_n \in \mu\mathcal{BC}$, it follows that $\mu\mathcal{BC} = \mu_{n-1} + \mu\mathcal{B}_n\mathcal{C}_n = \mu\mathcal{B}_1\mathcal{C}_1 + \mu\mathcal{B}_2\mathcal{C}_2 + \cdots + \mu\mathcal{B}_{n-1}\mathcal{C}_{n-1} + \mu\mathcal{B}_n\mathcal{C}_n$, q.e.d. \square

Proposition 1.3.60.5. *For classes μ_1, μ_2, μ_3 of congruent generalized intervals we have: $\mu_1 + \mu_2 = \mu_1 + \mu_3$ implies $\mu_2 = \mu_3$.*

Proof. We know that either $\mu_2 < \mu_3$, or $\mu_2 = \mu_3$, or $\mu_2 > \mu_3$. But by P 1.3.60.2 $\mu_2 < \mu_3$ would imply $\mu_1 + \mu_2 < \mu_1 + \mu_3$, and $\mu_2 > \mu_3$ would imply $\mu_1 + \mu_2 > \mu_1 + \mu_3$. But both $\mu_1 + \mu_2 < \mu_1 + \mu_3$ and $\mu_1 + \mu_2 > \mu_1 + \mu_3$ contradict $\mu_1 + \mu_2 = \mu_1 + \mu_3$, whence the result. \square

Proposition 1.3.60.6. *For any classes μ_1, μ_3 of congruent generalized intervals such that $\mu_1 < \mu_3$, there is a unique class μ_2 of congruent generalized intervals with the property $\mu_1 + \mu_2 = \mu_3$.*

Proof. Uniqueness follows immediately from the preceding proposition. To show existence recall that $\mu_1 < \mu_3$ in view of L 1.3.15.3 implies that there are geometric objects $\mathcal{A}, \mathcal{B}, \mathcal{C}$ such that $\mathcal{AB} \in \mu_1$, $\mathcal{AC} \in \mu_3$, and $[\mathcal{ABC}]$. Denote $\mu_2 \equiv \mu\mathcal{BC}$.⁴⁹⁵ From the definition of sum of classes of congruent generalized intervals then follows that $\mu_1 + \mu_2 = \mu_3$. \square

If $\mu_1 + \mu_2 = \mu_3$ (and then, of course, $\mu_2 + \mu_1 = \mu_3$ in view of T 1.3.59), we shall refer to the class μ_2 of congruent generalized intervals as the difference of the classes μ_3, μ_1 of congruent generalized intervals and write $\mu_2 = \mu_3 - \mu_1$. That is, $\mu_2 = \mu_3 - \mu_1 \stackrel{\text{def}}{\iff} \mu_1 + \mu_2 = \mu_3$. The preceding proposition shows that the difference of classes of congruent generalized intervals is well defined.

Proposition 1.3.60.7. *For classes $\mu_1, \mu_2, \mu_3, \mu_4$ of congruent generalized intervals the inequalities $\mu_1 < \mu_2, \mu_3 < \mu_4$ imply $\mu_1 + \mu_3 < \mu_2 + \mu_4$.*⁴⁹⁶

Proof. Using P 1.3.60.2 twice, we can write: $\mu_1 + \mu_3 < \mu_2 + \mu_3 < \mu_2 + \mu_4$, which, in view of transitivity of the relation $<$ gives the result. \square

Proposition 1.3.60.8. *For classes $\mu_1, \mu_2, \mu_3, \mu_4$ of congruent generalized intervals we have: $\mu_1 + \mu_2 \leq \mu_3 + \mu_4$ and $\mu_2 > \mu_4$ implies $\mu_1 < \mu_3$.*

Proof. We know that either $\mu_1 < \mu_3$, or $\mu_1 = \mu_3$, or $\mu_1 > \mu_3$. But by P 1.3.60.2 $\mu_1 = \mu_3$ would imply $\mu_1 + \mu_2 > \mu_3 + \mu_4$, and $\mu_1 > \mu_3$ would imply $\mu_1 + \mu_2 > \mu_1 + \mu_3$ in view of the preceding proposition (P 1.3.60.7). But $\mu_1 + \mu_2 > \mu_3 + \mu_4$ contradicts $\mu_1 + \mu_2 \leq \mu_3 + \mu_4$, whence the result. \square

Denote by $\mu\angle(h, k)$ the equivalence class of congruent angles, containing an angle $\angle(h, k)$. This class consists of all angles $\angle(l, m)$ congruent to the given angle $\angle(h, k)$. We define addition of classes of congruent angles as follows: Take an angle $\angle(h, k)$ of the first class $\mu\angle(h, k)$. Suppose that we are able to lay off the angle $\angle(k, l)$ of the second

⁴⁹³See the discussion following the definition of addition of classes of congruent generalized intervals.

⁴⁹⁴Observe that if the n geometric objects $\mathcal{A}_0, \mathcal{A}_1, \dots, \mathcal{A}_n$ are such that $[\mathcal{A}_{i-1}\mathcal{A}_i\mathcal{A}_{i+1}]$ for all $i \in \mathbb{N}_{n-1}$, $\mathcal{A}_{i-1}\mathcal{A}_i \in \mu\mathcal{B}_i\mathcal{C}_i$ for all $i \in \mathbb{N}_n$, then all these facts remain valid for the $n - 1$ geometric objects $\mathcal{A}_0, \mathcal{A}_1, \dots, \mathcal{A}_{n-1}$. Furthermore, we have $\mathcal{A}_0\mathcal{A}_{n-1} \in \mu_{n-1}$ from the definition of μ_{n-1} .

⁴⁹⁵That is, we take μ_2 to be the class of congruent generalized intervals containing the generalized interval BC .

⁴⁹⁶And, of course, the inequalities $\mu_1 > \mu_2, \mu_3 > \mu_4$ imply $\mu_1 + \mu_3 > \mu_2 + \mu_4$. The inequalities involved will also hold for any representatives of the corresponding classes.

class $\mu\angle(k, l)$ into the angular ray k_h^c , complementary to the angular ray h_k .⁴⁹⁷ Then the sum of the classes $\angle(h, k)$, $\angle(k, l)$ is, by definition, the class $\mu\angle(h, l)$, containing the extended angle $\angle(h, l)$. Note that this addition of classes is well defined, for $\angle(h, k) \equiv \angle(h_1, k_1) \& \angle(k, l) \equiv \angle(k_1, l_1) \& [hkl] \& [h_1k_1l_1] \xrightarrow{T1.3.9} \angle(h, l) \equiv \angle(h_1, l_1)$, which implies that the result of summation does not depend on the choice of representatives in each class. Thus, put simply, we have $[hkl] \Rightarrow \mu\angle(h, l) = \mu\angle(h, k) + \mu\angle(k, l)$. Conversely, the notation $\angle(h, l) \in \mu_1 + \mu_2$ means that there is a ray k such that $[hkl]$ and $\angle(h, k) \in \mu_1$, $\angle(k, l) \in \mu_2$.

Observe that in our definition we allow the possibility that the sum of classes of congruent angles may turn out to be the class of straight angles.⁴⁹⁸ We shall find it convenient to denote this equivalence class by $\pi^{(abs)}$, where the superscript is used to indicate that we are dealing with equivalence classes, not numerical angular measures.

Note further that $\mu\angle(h, k) + \mu\angle(l, m) = \pi^{(abs)}$ iff the angles $\angle(h, k)$, $\angle(l, m)$ are supplementary.

In the case when $\mu\angle(h, k) + \mu\angle(l, m) = \mu\angle(p, q)$ and $\angle(h', k') \equiv \angle(h, k)$, $\angle(l', m') \equiv \angle(l, m)$, $\angle(p, q) \equiv \angle(p', q')$ (that is, when $\mu\angle(h, k) + \mu\angle(l, m) = \mu\angle(p, q)$ and $\angle(h', k') \in \mu\angle(h, k)$, $\angle(l', m') \in \mu\angle(l, m)$, $\angle(p, q) \in \mu\angle(p', q')$), we can say, with some abuse of terminology, that the angle $\angle(p', q')$ is the sum of the angles $\angle(h', k')$, $\angle(l', m')$.

The addition (of classes of congruent angles) thus defined has the properties of commutativity and associativity, as the following two theorems (T 1.3.61, T 1.3.62) indicate:

Theorem 1.3.61. *The addition of classes of congruent angles is commutative: For any classes μ_1 , μ_2 , for which the addition is defined, we have $\mu_1 + \mu_2 = \mu_2 + \mu_1$.*

Proof. \square

Theorem 1.3.62. *The addition of classes of congruent angles is associative: For any classes μ_1 , μ_2 , μ_3 for which the addition is defined, we have $(\mu_1 + \mu_2) + \mu_3 = \mu_1 + (\mu_2 + \mu_3)$.*

Proof. \square

Note that we may write $\mu_1 + \mu_2 + \cdots + \mu_n$ for the sum of n classes $\mu_1, \mu_2, \dots, \mu_n$ of angles without needing to care about where we put the parentheses.

If a class $\mu\angle(k, l)$ of congruent angles is equal to the sum $\mu\angle(k_1, l_1) + \mu\angle(k_2, l_2) + \cdots + \mu\angle(k_n, l_n)$ of classes $\mu\angle(k_1, l_1), \mu\angle(k_2, l_2), \dots, \mu\angle(k_n, l_n)$ of congruent angles, and $\mu\angle(k_1, l_1) = \mu\angle(k_2, l_2) = \cdots = \mu\angle(k_n, l_n)$ (that is, $\angle(k_1, l_1) \equiv \angle(k_2, l_2) \equiv \cdots \equiv \angle(k_n, l_n)$), we write $\mu\angle(k, l) = n\mu\angle(k_1, l_1)$ or $\mu\angle(k_1, l_1) = (1/n)\mu\angle(k, l)$.

Proposition 1.3.63.1. *If $\mu\angle(h, k) + \mu\angle(l, m) = \mu\angle(p, q)$,⁴⁹⁹ $\angle(h', k') \in \mu\angle(h, k)$, $\angle(l', m') \in \mu\angle(l, m)$, $\angle(p', q') \in \mu\angle(p, q)$, then $\angle(h', k') < \angle(p', q')$, $\angle(l', m') < \angle(p', q')$.*

Proof. \square

At this point we can introduce the following jargon. For classes $\mu\angle(h, k)$, $\mu\angle(l, m)$ or congruent angles we write $\mu\angle(h, k) < \mu\angle(l, m)$ or $\mu\angle(l, m) > \mu\angle(h, k)$ if there are angles $\angle(h', k') \in \mu\angle(h, k)$, $\angle(l', m') \in \mu\angle(l, m)$ such that $\angle(h', k') < \angle(l', m')$. T 1.3.11, L 1.3.16.6, L 1.3.56.18 then show that this notation is well defined: it does not depend on the choice of the angles $\angle(h', k')$, $\angle(l', m')$. For arbitrary classes $\mu\angle(h, k)$, $\mu\angle(l, m)$ of congruent angles we then have either $\mu\angle(h, k) < \mu\angle(l, m)$, or $\mu\angle(h, k) = \mu\angle(l, m)$, or $\mu\angle(h, k) > \mu\angle(l, m)$ (with the last inequality being equivalent to $\mu\angle(l, m) < \mu\angle(h, k)$). From L 1.3.16.10 – C 1.3.16.12 we see also that any one of these options excludes the two others.

Proposition 1.3.63.2. *If $\mu\angle(h, k) + \mu\angle(l, m) = \mu\angle(p, q)$, $\mu\angle(h, k) + \mu\angle(r, s) = \mu\angle(u, v)$, and $\angle(l, m) < \angle(r, s)$, then $\angle(p, q) < \angle(u, v)$.⁵⁰⁰*

Proof. \square

Proposition 1.3.63.3. *If $\mu\angle(h, k) + \mu\angle(l, m) = \mu\angle(p, q)$, $\mu\angle(h, k) + \mu\angle(r, s) = \mu\angle(u, v)$, and $\angle(p, q) < \angle(u, v)$, then $\angle(l, m) < \angle(r, s)$.⁵⁰¹*

Proof. \square

⁴⁹⁷In other words, we must be in a position to take a ray $l \in k_h^c$ (recall that $l \in k_h^c$ means that $[hkl]$, see L 1.2.36.2) such that the angle $\angle(k, l)$ lies in the second class, which we denote $\mu\angle(k, l)$. The notation employed here is perfectly legitimate: we know that $\angle(h_1, k_1) \in \mu\angle(h, k) \Rightarrow \angle(h_1, k_1) \equiv \angle(h, k) \Rightarrow \mu\angle(h_1, k_1) = \mu\angle(h, k)$. As in the case of classes of congruent intervals, both traditional and generalized ones, in our future treatment of classes of congruent angles we shall often resort to this convenient abuse of notation. Although we have agreed previously to use Greek letters to denote planes, we shall sometimes use the letter μ (possibly with subscripts) without the accompanying name of defining representative to denote congruence classes of angles whenever giving a particular defining representative for a class is not relevant.

⁴⁹⁸Recall that by definition all straight angles are congruent to each other and are not congruent to non-straight angles. Thus, all straight angles lie in the single class of equivalence.

⁴⁹⁹We assume that the classes $\mu\angle(h, k)$, $\mu\angle(l, m)$ can indeed be added.

⁵⁰⁰This proposition can be formulated in more abstract terms for congruence classes μ_1, μ_2, μ_3 of angles as follows: $\mu_2 < \mu_3$ implies $\mu_1 + \mu_2 < \mu_1 + \mu_3$.

⁵⁰¹This proposition can be formulated in more abstract terms for congruence classes μ_1, μ_2, μ_3 of angles as follows: $\mu_1 + \mu_2 < \mu_1 + \mu_3$ implies $\mu_2 < \mu_3$.

Proposition 1.3.63.4. A class $\mu\angle(k, l)$ of congruent angles is equal to the sum $\mu\angle(k_1, l_1) + \mu\angle(k_2, l_2) + \cdots + \mu\angle(k_n, l_n)$ of classes $\mu k_1 l_1, \mu k_2 l_2, \dots, \mu k_n l_n$ of congruent angles iff there are rays h_0, h_1, \dots, h_n such that $[h_{i-1} h_i h_{i+1}]$ for all $i \in \mathbb{N}_{n-1}$, $\angle(h_{i-1}, h_i) \in \mu\angle(k_i, l_i)$ for all $i \in \mathbb{N}_n$, and $\angle(h_0, h_n) \in \mu\angle(k, l)$.⁵⁰²

Proof. \square

Proposition 1.3.63.5. For classes μ_1, μ_2, μ_3 of congruent angles we have: $\mu_1 + \mu_2 = \mu_1 + \mu_3$ implies $\mu_2 = \mu_3$.

Proposition 1.3.63.6. For any classes μ_1, μ_3 of congruent angles such that $\mu_1 < \mu_3$, there is a unique class μ_2 of congruent angles with the property $\mu_1 + \mu_2 = \mu_3$.

If $\mu_1 + \mu_2 = \mu_3$ (and then, of course, $\mu_2 + \mu_1 = \mu_3$ in view of T 1.3.59), we shall refer to the class μ_2 of congruent angles as the difference of the classes μ_3, μ_1 of congruent angles, and write $\mu_2 = \mu_3 - \mu_1$. That is, $\mu_2 = \mu_3 - \mu_1 \stackrel{\text{def}}{\iff} \mu_1 + \mu_2 = \mu_3$. The preceding proposition shows that the difference of classes of congruent angles is well defined.

Proposition 1.3.63.7. For classes $\mu_1, \mu_2, \mu_3, \mu_4$ of congruent angles the inequalities $\mu_1 < \mu_2, \mu_3 < \mu_4$ imply $\mu_1 + \mu_3 < \mu_2 + \mu_4$.⁵⁰³

Proof. See P ???. \square

Proposition 1.3.63.8. For classes $\mu_1, \mu_2, \mu_3, \mu_4$ of congruent angles we have: $\mu_1 + \mu_2 \leq \mu_3 + \mu_4$ and $\mu_2 > \mu_4$ implies $\mu_1 < \mu_3$.

Proof. See P ???. \square

Corollary 1.3.63.9. In a triangle $\triangle ABC$ we have $\mu\angle BAC + \mu\angle ACB < \pi^{(abs)}$.⁵⁰⁴

Proof. In fact, $\angle BAC < \text{adjsp}\angle ACB$ by T 1.3.17. Hence using P 1.3.63.2 we can write $\mu\angle ABC + \mu\angle ACB < \mu\text{adjsp}\angle ACB + \mu\angle ACB = \pi^{(abs)}$, which gives the desired result. \square

We shall refer to an (ordered) pair $(\angle(h, k), n)$ consisting of an extended angle $\angle(h, k)$ and a positive integer $n \in \mathbb{N}_n$ (here $\mathbb{N}^0 = \{0, 1, 2, \dots\}$ is the set of all positive integers) as an overextended angle. Overextended angles with $n = 0$ will be called improper, while those with $n \in \mathbb{N}$ will be termed proper overextended angles. Evidently, we can identify improper overextended angles with extended angles. In fact, there is a one-to-one correspondence between improper overextended angles of the form $(\angle, 0)$ and the corresponding extended angles \angle .

Overextended angles $(\angle(h_1, k_1), n_1), (\angle(h_2, k_2), n_2)$ will be called congruent iff $\angle(h_1, k_1) = \angle(h_2, k_2)$ and $n_1 = n_2$. Obviously, the congruence relation thus defined is an equivalence relation.

We shall denote by $\mu(\angle(h, k), n)$ the equivalence class of overextended angles congruent to the overextended angle $(\angle(h, k), n)$. When there is no danger of confusion, we will also use a shorter notation $\mu(\angle, n)$ ⁵⁰⁵ or simply $\mu^{(xt)}$.

Given classes $\mu(\angle_1, n_1), \mu(\angle_2, n_2)$ of congruent overextended angles, we define their sum as follows:

Consider first the case when both \angle_1 and \angle_2 are non-straight angles. In this case we take an angle $\angle(h, k) \in \mu\angle_1$ and construct, using A 1.3.4, the ray l such that $\angle(k, l) \in \angle_2$ and the rays h, l lie on opposite sides of the line \bar{k} . If it so happens that the ray k lies inside the extended angle $\angle(h, l)$ (which is the case when either k, l lie on the same side of the line \bar{h} or $l = h^c$), we define the sum of $\mu(\angle_1, n_1), \mu(\angle_2, n_2)$ as $\mu(\angle(h, l), n)$, where $n = n_1 + n_2$. In the case when the ray k lies outside the (extended) angle $\angle(h, l)$, i.e. when the rays k, l lie on opposite sides of the line \bar{h} and the ray k^c lies inside the angle $\angle(h, l)$ (see L 1.2.21.33), we define the sum of $\mu(\angle_1, n_1), \mu(\angle_2, n_2)$ as $\mu(\angle(h^c, l), n)$, where $n = n_1 + n_2 + 1$. Suppose now \angle_1 (respectively, \angle_2) is a straight angle. Then we define the sum of $\mu(\angle_1, n_1), \mu(\angle_2, n_2)$ as $\mu(\angle_2, n)$ ($\mu(\angle_1, n)$), where $n = n_1 + n_2 + 1$.

It follows from T 1.3.9, L 1.3.16.21 that the addition of overextended angles is well defined.

The addition (of classes of congruent angles) thus defined has the properties of commutativity and associativity, as the following two theorems (T 1.3.64, T 1.3.65) indicate:

Theorem 1.3.64. The addition of classes of congruent overextended angles is commutative: For any classes $\mu_1^{(xt)}, \mu_2^{(xt)}$, for which the addition is defined, we have $\mu_1^{(xt)} + \mu_2^{(xt)} = \mu_2^{(xt)} + \mu_1^{(xt)}$.

Proof. Suppose $(\angle(h, l), n) \in \mu_1^{(xt)} + \mu_2^{(xt)}$. Then, according to our definition above, the following situations are possible:

1) The rays h, l lie on opposite sides of the line \bar{k} , where $(\angle(h, k), n_1) \in \mu_1^{(xt)}, (\angle(k, l), n_2) \in \mu_2^{(xt)}$.

(a) Suppose first that the ray k lies inside the extended angle $\angle(h, l)$ and $n = n_1 + n_2$. Interchanging the rays h, l and the subscripts "1" and "2" and noticing that they enter the appropriate part of the definition symmetrically, we see that $(\angle(h, l), n) \in \mu_2^{(xt)} + \mu_1^{(xt)}$. Thus, we have $\mu_1^{(xt)} + \mu_2^{(xt)} \subset \mu_2^{(xt)} + \mu_1^{(xt)}$.

Reversing our argument in an obvious way, we obtain $\mu_2^{(xt)} + \mu_1^{(xt)} \subset \mu_1^{(xt)} + \mu_2^{(xt)}$.

⁵⁰²That is, we have $\angle(h_{i-1}, h_i) \equiv \angle(k_i, l_i)$ for all $i \in \mathbb{N}_n$, and $\angle(h_0, h_n) \equiv \angle(k, l)$.

⁵⁰³And, of course, the inequalities $\mu_1 > \mu_2, \mu_3 > \mu_4$ imply $\mu_1 + \mu_3 > \mu_2 + \mu_4$. The inequalities involved will also hold for any representatives of the corresponding classes.

⁵⁰⁴Loosely speaking, the sum of any two angles of any triangle is less than two right angles.

⁵⁰⁵Here we omit the letters that denote sides of the defining angle when they are not relevant.

(b) Suppose now that the ray k^c lies inside the extended angle $\angle(h, l)$ and $n = n_1 + n_2 + 1$. Again, interchanging the rays h, l and the subscripts "1" and "2", we see that $(\angle(h, l), n) \in \mu_2^{(xt)} + \mu_1^{(xt)}$ in this case, too.

2) Suppose, finally, that $(\angle(h, h^c), n_1) \in \mu_1^{(xt)}$. Then, according to our definition, $(\angle(h, l), n_2) \in \mu_2^{(xt)}$, where $n_1 + n_2 + 1$. Hence $(\angle(h, l), n) \in \mu_2^{(xt)} + \mu_1^{(xt)}$. Similar considerations apply to the case when $(\angle(l, l^c), n_1) \in \mu_2^{(xt)}$.

□

Theorem 1.3.65. *The addition of classes of congruent overextended angles is associative: For any classes $\mu_1^{(xt)}$, $\mu_2^{(xt)}$, $\mu_3^{(xt)}$, for which the addition is defined, we have $(\mu_1^{(xt)} + \mu_2^{(xt)}) + \mu_3^{(xt)} = \mu_1^{(xt)} + (\mu_2^{(xt)} + \mu_3^{(xt)})$.*

Proof. 1) Suppose that $(\angle(h, k), n_1) \in \mu_1^{(xt)}$, $(\angle(k, l), n_2) \in \mu_2^{(xt)}$, and the ray k lies inside the non-straight angle $\angle(h, l)$. Then, according to our definition of the sum of overextended angles, we have $(\angle(h, l), n_1 + n_2) \in \mu_1^{(xt)} + \mu_2^{(xt)}$.

Taking a ray m such that $(\angle(l, m), n_3) \in \mu_3^{(xt)}$ and the rays h, m lie on opposite sides of the line \bar{l} , consider the following possible situations:

(a) The ray l lies inside the extended angle $\angle(h, m)$ (see Fig. 1.169, a), b)). Then $(\angle(h, m), n_1 + n_2 + n_3) \in (\mu_1^{(xt)} + \mu_2^{(xt)}) + \mu_3^{(xt)}$. But in this case the ray l also lies between k, m , and the ray k lies between the rays h, m (see P 1.2.21.29). Hence $(\angle(k, m), n_2 + n_3) \in \mu_2^{(xt)} + \mu_3^{(xt)}$ and $(\angle(h, m), n_1 + n_2 + n_3) \in \mu_1^{(xt)} + (\mu_2^{(xt)} + \mu_3^{(xt)})$.

(b) Suppose now that the rays l, m lie on opposite sides of the line \bar{h} . Then (from the definition of addition of overextended angles) $(\angle(h^c, m), n_1 + n_2 + n_3 + 1) \in (\mu_1^{(xt)} + \mu_2^{(xt)}) + \mu_3^{(xt)}$. Observe also that in this case the ray h^c lies inside the angle $\angle(l, m)$ by L 1.2.21.33, and $\angle(h, m^c) \equiv \angle(h^c, m)$ as vertical angles (see T 1.3.7).

In addition, using the definition of the interior of an angle, we can write $h^c \subset \text{Int}\angle(l, m) \& k \subset \text{Int}\angle(h, l) \Rightarrow lh^c\bar{m} \& mh^c\bar{l} \& hk\bar{l}$. Hence $mh^c\bar{l} \& h^c\bar{l}h \& hk\bar{l} \xrightarrow{\text{L1.2.18.6}} m\bar{l}k$

Consider first the case when k, l lie on the same side of \bar{m} (see Fig. 1.169, c)). Since both $m\bar{l}k$ and $kl\bar{m}$, we conclude that $(\angle(k, m), n_2 + n_3) \in \mu_2^{(xt)} + \mu_3^{(xt)}$. $kl\bar{m} \& m\bar{l}k \xrightarrow{\text{L1.2.21.33}} l \subset \text{Int}\angle(m, k) \Rightarrow m\bar{l}k$. $m\bar{l}k \& \bar{l}k\bar{h} \xrightarrow{\text{L1.2.18.6}} m\bar{k}h$. Also, (by L 1.2.18.2, L 1.2.18.5) we have $kl\bar{m} \& lh^c\bar{m} \& h^c\bar{m}h \Rightarrow k\bar{m}h$. According to the definition of addition of overextended angles, this implies $(\angle(h, m^c), n_1 + n_2 + n_3 + 1) \in \mu_1^{(xt)} + (\mu_2^{(xt)} + \mu_3^{(xt)})$. Note also that $\angle(h, m^c) \equiv \angle(h^c, m)$ as vertical angles (see T 1.3.7).

We now turn to the case when the rays l, k lie on opposite sides of the line \bar{m} (see Fig. 1.169, d)). Since both $l\bar{m}k$ and $m\bar{l}k$ (see above), in this situation we have $(\angle(k, m^c), n_2 + n_3 + 1) \in \mu_2^{(xt)} + \mu_3^{(xt)}$. Also, $h^c l\bar{m} \& l\bar{m}k \& h^c\bar{m}h \Rightarrow hk\bar{m}$. $kl\bar{h} \& k\bar{h}m \& m^c\bar{h}m\bar{l}m\bar{h} \Rightarrow m^c k\bar{h}$. Using the definition of interior points of an angle, we can write $hk\bar{m} \& m^c k\bar{h} \Rightarrow k \subset \text{Int}\angle(h, m^c)$. Taking into account the fact that $(\angle(h, k), n_1) \in \mu_1^{(xt)}$, we finally obtain $(\angle(h, m^c), n_1 + n_2 + n_3 + 1) \in \mu_1^{(xt)} + (\mu_2^{(xt)} + \mu_3^{(xt)})$.

There is also the case when $m^c = k$ (see Fig. 1.169, e)). In this case we have, evidently, $(\angle(m, m^c), n_2 + n_3) \in \mu_2^{(xt)} + \mu_3^{(xt)}$, $(\angle(h, m^c), n_1 + n_2 + n_3 + 1) \in \mu_1^{(xt)} + (\mu_2^{(xt)} + \mu_3^{(xt)})$.

Consider now the situation when $(\angle(l, m), n_3) \in \mu_3^{(xt)}$ and $m = l^c$, i.e. when $\angle(l, m)$ is a straight angle. Then, obviously, $(\angle(h, l), n_1 + n_2 + n_3 + 1) \in (\mu_1^{(xt)} + \mu_2^{(xt)}) + \mu_3^{(xt)}$, $(\angle(k, l), n_2 + n_3 + 1) \in \mu_2^{(xt)} + \mu_3^{(xt)}$, $(\angle(h, m), n_1 + n_2 + n_3 + 1) \in \mu_1^{(xt)} + (\mu_2^{(xt)} + \mu_3^{(xt)})$.

2) Suppose now that $(\angle(h, k), n_1) \in \mu_1^{(xt)}$, $(\angle(k, l), n_2) \in \mu_2^{(xt)}$, and $h^c = l$, i.e. $\angle(h, l)$ is a straight angle. Then, according to our definition of the sum of overextended angles, we have $(\angle(h, h^c), n_1 + n_2) \in \mu_1^{(xt)} + \mu_2^{(xt)}$.

Taking a ray m such that $(\angle(h^c, m), n_3) \in \mu_3^{(xt)}$ and the rays k, m lie on opposite sides of the line $\bar{l} = \bar{h}$, we can write $(\angle(h^c, m), n_1 + n_2 + n_3 + 1) \in (\mu_1^{(xt)} + \mu_2^{(xt)}) + \mu_3^{(xt)}$ and consider the following possible situations (we have $m\bar{h}k \& m\bar{h}m^c \xrightarrow{\text{L1.2.18.6}} m^c k\bar{h}$, whence in view of L 1.2.21.21 either $k \subset \text{Int}\angle(h, m^c)$, or $m^c \subset \text{Int}\angle(h, k)$, or $m^c = k$ (see Fig. 1.169, f)-h)):

(a) $k \subset \text{Int}\angle(h, m^c)$ (see Fig. 1.169, f)). From definition of interior we have $hk\bar{m}$. Hence $hk\bar{m} \& h\bar{m}h^c \xrightarrow{\text{L1.2.18.5}} k\bar{m}l$. Thus, we can write $(\angle(m^c, k), n_2 + n_3 + 1) \in \mu_2^{(xt)} + \mu_3^{(xt)}$ and $(\angle(m^c, h), n_1 + n_2 + n_3 + 1) \in \mu_1^{(xt)} + (\mu_2^{(xt)} + \mu_3^{(xt)})$.

(b) $m^c \subset \text{Int}\angle(h, k)$ (see Fig. 1.169, g)). Hence $h\bar{m}k$ (see C 1.2.21.11). Writing $h\bar{m}k \& h\bar{m}h^c \xrightarrow{\text{L1.2.18.4}} h^c k\bar{m}$ and taking into account that $k\bar{h}m$, we see that $(\angle(k, m), n_2 + n_3) \in \mu_2^{(xt)} + \mu_3^{(xt)}$. Also, ${}^{506}hm^c\bar{k} \& m^c\bar{k}m \xrightarrow{\text{L1.2.18.5}} h\bar{k}m$. Thus, we see that $(\angle(m^c, h), n_1 + n_2 + n_3 + 1) \in \mu_1^{(xt)} + (\mu_2^{(xt)} + \mu_3^{(xt)})$.

3) Suppose that $(\angle(h, k), n_1) \in \mu_1^{(xt)}$, $(\angle(k, l), n_2) \in \mu_2^{(xt)}$, the rays h, l lie on opposite sides of the line \bar{k} , and the rays k, l lie on opposite sides of the line \bar{h} . Then, according to our definition of the sum of overextended angles, we have $(\angle(h^c, l), n_1 + n_2 + 1) \in \mu_1^{(xt)} + \mu_2^{(xt)}$.

Furthermore, by L 1.2.21.33 $h^c \subset \text{Int}\angle(k, l)$.

Taking a ray m such that $(\angle(l, m), n_3) \in \mu_3^{(xt)}$ and the rays h^c, m lie on opposite sides of the line \bar{l} , consider the following possible situations:

(a) The rays l, m lie on the same side of the line \bar{h} . Then from L 1.2.21.32 we have $l \subset \text{Int}\angle(h^c, m)$. Hence $(\angle(h^c, m), n_1 + n_2 + n_3 + 1) \in (\mu_1^{(xt)} + \mu_2^{(xt)}) + \mu_3^{(xt)}$.

⁵⁰⁶Using definition of the interior of $\angle(h, k)$, we can write $m^c \subset \text{Int}\angle(h, k) \Rightarrow hm^c\bar{k}$.

Consider first the case when l, m lie on the same side of k (see Fig. 1.170, a)). Then, of course, $h^c \subset \text{Int}\angle(k, l) \& l \subset \text{Int}\angle(h^c, m) \& lm\bar{k} \xrightarrow{\text{L1.2.21.29}} l \subset \text{Int}\angle(k, m) \& h^c \subset \text{Int}\angle(k, m) \Rightarrow h^c m\bar{k} \& kh^c \bar{m}$. Hence (using L 1.2.18.5) we can write $h\bar{k}h^c \& h^c m\bar{k} \Rightarrow h\bar{k}m, kh^c \bar{m} \& h^c \bar{m}h \Rightarrow k\bar{m}h$. These relations imply that $(\angle(m^c, h), n_1 + n_2 + n_3 + 1) \in (\mu_1^{(xt)} + (\mu_2^{(xt)} + \mu_3^{(xt)}))$.

We turn now to the situation when l, m lie on opposite sides of k (see Fig. 1.170, b)). Taking into account that $h^c \subset \text{Int}\angle(k, l) \Rightarrow kh^c \bar{l}$ (by definition of interior) and $l \subset \text{Int}\angle(h^c, m) \xrightarrow{\text{C1.2.21.11}} h^c \bar{l}m$, we can write $kh^c \bar{l} \& h^c \bar{l}m \xrightarrow{\text{L1.2.18.5}} k\bar{l}m$. This, together with $l\bar{k}m$, implies $(\angle(k^c, m), n_2 + n_3 + 1) \in \mu_2^{(xt)} + \mu_3^{(xt)}$. Using L 1.2.18.4, L 1.2.18.5 we can write $k\bar{h}l \& lm\bar{h} \& k\bar{h}k^c \Rightarrow k^c m\bar{h}$. In view of L 1.2.21.32 this implies $m \subset \text{Int}\angle(h^c, k^c)$, whence $m^c \subset \text{Int}\angle(h, k)$ by L 1.2.21.16. Thus, again $(\angle(m^c, h), n_1 + n_2 + n_3 + 1) \in (\mu_1^{(xt)} + (\mu_2^{(xt)} + \mu_3^{(xt)}))$.

(b) The rays l, m lie on opposite same sides of the line h (see Fig. 1.170, c)). In this case $(\angle(h, m), n_1 + n_2 + n_3 + 2) \in (\mu_1^{(xt)} + \mu_2^{(xt)} + \mu_3^{(xt)})$.

Using L 1.2.18.4, L 1.2.18.5 we can write $kh^c \bar{l} \& h\bar{l}h^c \& k\bar{l}m \Rightarrow m\bar{h}l. m\bar{h}l \& l\bar{h}m \xrightarrow{\text{L1.2.21.32}} h \subset \text{Int}\angle(l, m) \xrightarrow{\text{L1.2.21.22}} m \subset \text{Int}\angle(h, l^c) \xrightarrow{\text{L1.2.21.16}} m^c \subset \text{Int}\angle(h^c, l). m^c \subset \text{Int}\angle(h^c, l) \& h^c \subset \text{Int}\angle(k, l) \xrightarrow{\text{L1.2.21.27}} m^c \subset \text{Int}\angle(k, l) \& h^c \subset \text{Int}\angle(k, m^c)$. Hence $m^c \subset \text{Int}\angle(k, l) \xrightarrow{\text{C1.2.21.11}} k\bar{m}l$. Also, $kh^c \bar{l} \& h^c \bar{l}h \& h\bar{l}m \xrightarrow{\text{L1.2.18.5}} k\bar{l}m$. Thus, $(\angle(k, m^c), n_2 + n_3 + 1) \in \mu_2^{(xt)} + \mu_3^{(xt)}$. By definition of interior we have $h^c \subset \text{Int}\angle(k, m^c) \Rightarrow h^c m^c \bar{k}$. Hence $h^c m^c \bar{k} \& h^c \bar{k}h \xrightarrow{\text{L1.2.18.5}} m^c \bar{k}h$. Also, $k\bar{h}l \& l\bar{h}m \& m\bar{h}m^c \Rightarrow k\bar{h}m^c$. Thus, we see that $(\angle(h, m), n_1 + n_2 + n_3 + 2) \in (\mu_1^{(xt)} + (\mu_2^{(xt)} + \mu_3^{(xt)}))$.

c) Suppose $m = h$ (see Fig. 1.170, d)). Then, obviously, $(\angle(h, h^c), n_1 + n_2 + n_3 + 1) \in (\mu_1^{(xt)} + \mu_2^{(xt)} + \mu_3^{(xt)})$. We know that $k\bar{h}l$, and $kh^c \bar{l} \& h^c \bar{l}h \xrightarrow{\text{L1.2.18.5}} k\bar{l}h$. Since $(\angle(h, k), n_1) \in \mu_1^{(xt)}$, it is now evident that $(\angle(h, h^c), n_1 + n_2 + n_3 + 1) \in (\mu_1^{(xt)} + (\mu_2^{(xt)} + \mu_3^{(xt)}))$.

Finally, the case when at least one of the overextended angles $(\angle_i, n_i) \in \mu_i^{(xt)}$, $i = 1, 2, 3$ is straight, is almost trivial and can be safely left as an exercise to the reader. \square

It turns out that we can compare overextended angles just as easily as we compare extended or only conventional angles. We shall say that an overextended angle $(\angle(h_1, k_1), n_1)$ is less than an overextended angle $(\angle(h_2, k_2), n_2)$ iff:

- either $n_1 < n_2$;
- or $n_1 = n_2$ and $\angle(h_1, k_1) < \angle(h_2, k_2)$.

In short, $(\angle(h_1, k_1), n_1) < (\angle(h_2, k_2), n_2) \stackrel{\text{def}}{\iff} (n_1 < n_2) \vee ((n_1 = n_2) \& \angle(h_1, k_1) < \angle(h_2, k_2))$.

Theorem 1.3.66. *The relation "less than" for overextended angles is transitive. That is, $(\angle(h_1, k_1), n_1) < (\angle(h_2, k_2), n_2)$ and $(\angle(h_2, k_2), n_2) < (\angle(h_3, k_3), n_3)$ imply $(\angle(h_1, k_1), n_1) < (\angle(h_3, k_3), n_3)$.*

Proof. See L 1.3.56.18. \square

Other properties of this relation are also fully analogous to those of the corresponding relation for extended angles (cf. L 1.3.16.6 – L 1.3.16.14):

Proposition 1.3.66.1. *If an overextended angle $(\angle(h'', k''), n'')$ is congruent to an overextended angle $(\angle(h', k'), n')$ and the overextended angle $(\angle(h', k'), n')$ is less than an overextended angle $(\angle(h, k), n)$, the overextended angle $(\angle(h'', k''), n'')$ is less than the overextended angle $(\angle(h, k), n)$.*

Proof. See L 1.3.16.6. \square

Proposition 1.3.66.2. *If an overextended angle $(\angle(h'', k''), n'')$ is less than an overextended angle $(\angle(h', k'), n')$ and the overextended angle $(\angle(h', k'), n')$ is congruent to an overextended angle $(\angle(h, k), n)$, the overextended angle $(\angle(h'', k''), n'')$ is less than the overextended angle $(\angle(h, k), n)$.*

Proof. See L 1.3.56.18. \square

Proposition 1.3.66.3. *If an overextended angle $(\angle(h'', k''), n'')$ is less than or congruent to an overextended angle $(\angle(h', k'), n')$ and the overextended angle $(\angle(h', k'), n')$ is less than or congruent to an overextended angle $(\angle(h, k), n)$, the overextended angle $(\angle(h'', k''), n'')$ is less than or congruent to the overextended angle $(\angle(h, k), n)$.*

Proof. See L 1.3.16.9. \square

Proposition 1.3.66.4. *If an overextended angle $(\angle(h', k'), n')$ is less than an overextended angle $(\angle(h, k), n)$, the overextended angle $(\angle(h, k), n)$ cannot be less than the overextended angle $(\angle(h', k'), n')$.*

Proof. See L 1.3.16.10. \square

Proposition 1.3.66.5. *If an overextended angle $\angle(h', k')$ is less than an overextended angle $\angle(h, k)$, it cannot be congruent to that angle.*

Proof. See L 1.3.16.11. \square

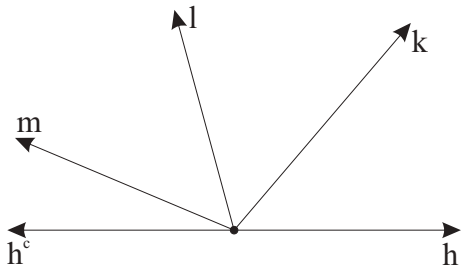

a)

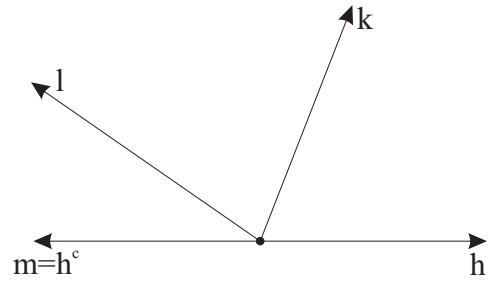

b)

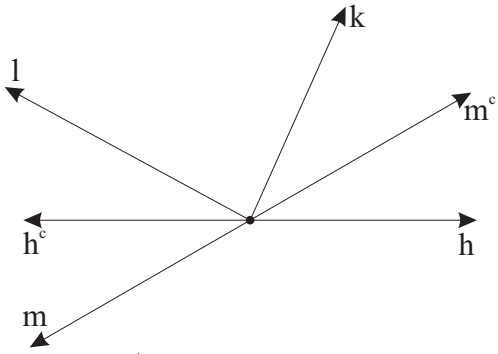

c)

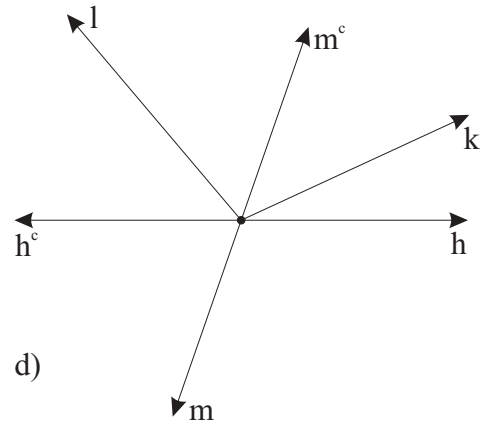

d)

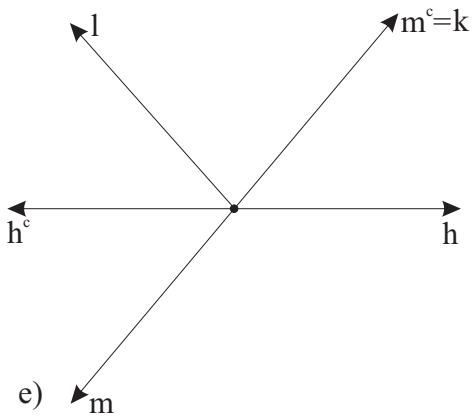

e)

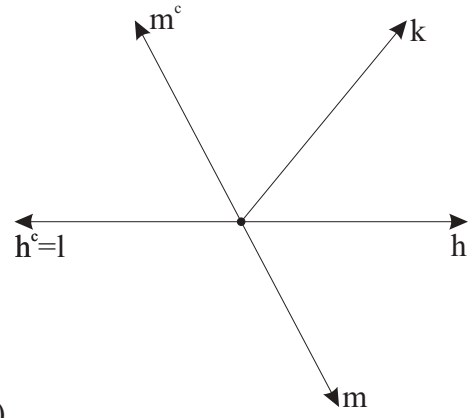

f)

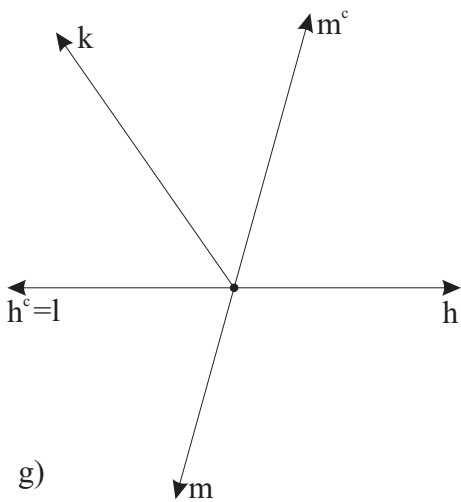

g)

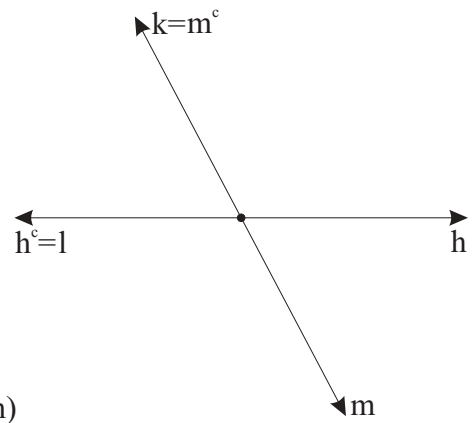

h)

Figure 1.169: Illustration for proof of T 1.3.65.

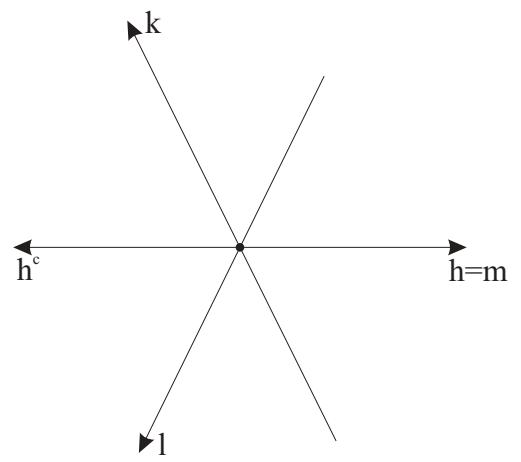
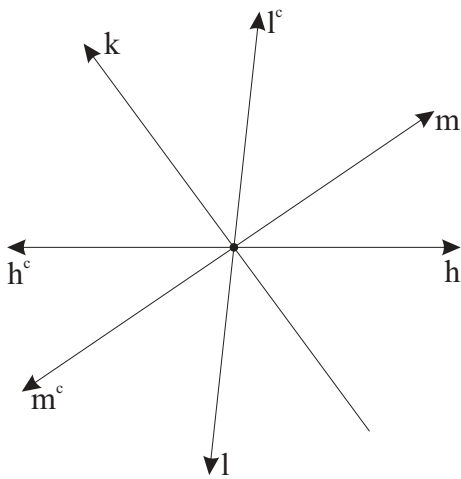
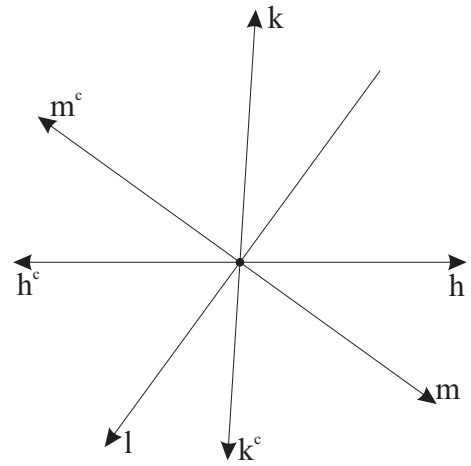
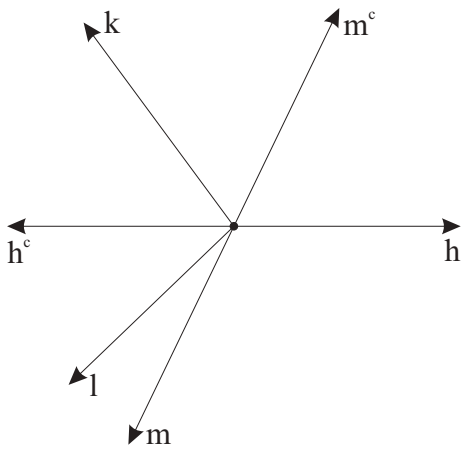

Figure 1.170: Illustration for proof of T 1.3.65 (continued).

Proposition 1.3.66.6. *If an overextended angle $(\angle(h', k'), n')$ is congruent to an overextended angle $(\angle(h, k), n)$, neither $(\angle(h', k'), n')$ is less than $(\angle(h, k), n)$, nor $(\angle(h, k), n)$ is less than $(\angle(h', k'), n')$.*

Proof. See C 1.3.16.12. \square

Proposition 1.3.66.7. *If an overextended angle $(\angle(h', k'), n')$ is less than or congruent to an overextended angle $(\angle(h, k), n)$ and the overextended angle $(\angle(h, k), n)$ is less than or congruent to the overextended angle $(\angle(h', k'), n')$, the overextended angle $(\angle(h', k'), n')$ is congruent to the overextended angle $(\angle(h, k), n)$.*

Proof. See L 1.3.16.13. \square

Proposition 1.3.66.8. *If an overextended angle $(\angle(h', k'), n')$ is not congruent to an overextended angle $(\angle(h, k), n)$, then either the overextended angle $(\angle(h', k'), n')$ is less than the overextended angle $(\angle(h, k), n)$, or the overextended angle $(\angle(h, k), n)$ is less than the overextended angle $(\angle(h', k'), n')$.*

Proof. See L 1.3.16.14. \square

The relation "less than" for overextended angles induces in an obvious way the corresponding relation for classes of overextended angles. For classes $\mu(\angle(h, k), n_1)$, $\mu(\angle(l, m), n_2)$ or congruent overextended angles we write $\mu(\angle(h, k), n_1) < \mu(\angle(l, m), n_2)$ or $\mu(\angle(l, m), n_2) > \mu(\angle(h, k), n_1)$ if there are overextended angles $(\angle(h', k'), n_1) \in \mu(\angle(h, k), n_1)$, $(\angle(l', m'), n_2) \in \mu(\angle(l, m), n_2)$ such that $(\angle(h', k'), n_1) < (\angle(l', m'), n_2)$. T 1.3.11, P 1.3.66.1, P 1.3.66.2 then show that this notation is well defined: it does not depend on the choice of the overextended angles $(\angle(h', k'), n_1)$, $(\angle(l', m'), n_2)$. For arbitrary classes $\mu(\angle(h, k), n_1)$, $\mu(\angle(l, m), n_2)$ of congruent overextended angles we then have either $\mu(\angle(h, k), n_1) < \mu(\angle(l, m), n_2)$, or $\mu(\angle(h, k), n_1) = \mu(\angle(l, m), n_2)$, or $\mu(\angle(h, k), n_1) > \mu(\angle(l, m), n_2)$ (with the last inequality being equivalent to $\mu\angle(l, m) < \mu\angle(h, k)$). From P 1.3.66.4 – P 1.3.66.6 we see also that any one of these options excludes the two others.

Proposition 1.3.66.9. *If $\mu(\angle(h, k), n_1) + \mu(\angle(l, m), n_2) = \mu(\angle(p, q), n_3)$, $\mu(\angle(h, k), n_1) + \mu(\angle(r, s), n_4) = \mu(\angle(u, v), n_5)$, and $(\angle(l, m), n_2) < (\angle(r, s), n_4)$, then $(\angle(p, q), n_3) < (\angle(u, v), n_5)$.*⁵⁰⁷

Proof. \square

Proposition 1.3.66.10. *If $\mu(\angle(h, k), n_1) + \mu(\angle(l, m), n_2) = \mu(\angle(p, q), n_3)$, $\mu(\angle(h, k), n_1) + \mu(\angle(r, s), n_4) = \mu(\angle(u, v), n_5)$, and $(\angle(p, q), n_3) < (\angle(u, v), n_5)$, then $(\angle(l, m), n_2) < (\angle(r, s), n_4)$.*⁵⁰⁸

Proof. \square

Proposition 1.3.66.11. *For classes $\mu_1^{(xt)}$, $\mu_2^{(xt)}$, $\mu_3^{(xt)}$ of congruent overextended angles we have: $\mu_1^{(xt)} + \mu_2^{(xt)} = \mu_1^{(xt)} + \mu_3^{(xt)}$ implies $\mu_2^{(xt)} = \mu_3^{(xt)}$.*

Proof. We know that either $\mu_2^{(xt)} < \mu_3^{(xt)}$, or $\mu_2^{(xt)} = \mu_3^{(xt)}$, or $\mu_2^{(xt)} > \mu_3^{(xt)}$. But by P 1.3.66.9 $\mu_2^{(xt)} < \mu_3^{(xt)}$ would imply $\mu_1^{(xt)} + \mu_2^{(xt)} < \mu_1^{(xt)} + \mu_3^{(xt)}$, and $\mu_2^{(xt)} > \mu_3^{(xt)}$ would imply $\mu_1^{(xt)} + \mu_2^{(xt)} > \mu_1^{(xt)} + \mu_3^{(xt)}$. But both $\mu_1^{(xt)} + \mu_2^{(xt)} < \mu_1^{(xt)} + \mu_3^{(xt)}$ and $\mu_1^{(xt)} + \mu_2^{(xt)} > \mu_1^{(xt)} + \mu_3^{(xt)}$ contradict $\mu_1^{(xt)} + \mu_2^{(xt)} = \mu_1^{(xt)} + \mu_3^{(xt)}$, whence the result. \square

Proposition 1.3.66.12. *For any classes $\mu_3^{(xt)}$ of congruent overextended angles such that $\mu_1^{(xt)} < \mu_3^{(xt)}$, there is a unique class $\mu_2^{(xt)}$ of congruent overextended angles with the property $\mu_1^{(xt)} + \mu_2^{(xt)} = \mu_3^{(xt)}$.*

Proof. Uniqueness follows immediately from the preceding proposition. To show existence, we take an arbitrary ray h and then construct (using A 1.3.4) rays k, l such that $(\angle(h, k), n_1) \in \mu_1^{(xt)}$, $(\angle(h, l), n_3) \in \mu_3^{(xt)}$, where, of course, $n_1, n_3 \in \mathbb{N}$. From L 1.2.21.21 we know that either the ray k lies inside the ray $\angle(h, l)$, or the ray l lies inside the angle $\angle(h, k)$, or the rays k, l coincide. In the case $k \subset \text{Int}\angle(h, l)$ (see Fig. 1.171, a)) from the definition of sum of classes of congruent overextended angles immediately follows that if we denote $\mu_2^{(xt)} \equiv \mu(\angle(k, l), n_3 - n_1)$, we have $\mu_1^{(xt)} + \mu_2^{(xt)} = \mu_3^{(xt)}$. Suppose now $l \subset \text{Int}\angle(h, k)$ (see Fig. 1.171, b)). Then we have (from definition of interior) $l \subset \text{Int}\angle(h, k) \Rightarrow h\bar{k} \& k\bar{l}h$. Since $k\bar{l}h \& h\bar{l}k \xrightarrow{\text{L1.2.18.5}} k\bar{h}l^c$, $h\bar{l}k \& k\bar{l}h \xrightarrow{\text{L1.2.18.5}} h\bar{k}l^c$, we see that defining $\mu_2^{(xt)} \equiv \mu(\angle(k, l^c), n_3 - n_1 - 1)$, we have (from definition of interior)⁵⁰⁹ $\mu_1^{(xt)} + \mu_2^{(xt)} = \mu_3^{(xt)}$, as required. Finally, in the case $k = l$ we let $\mu_2^{(xt)} \equiv \mu(\angle(k, k^c), n_3 - n_1 - 1)$, which, obviously, again gives $\mu_1^{(xt)} + \mu_2^{(xt)} = \mu_3^{(xt)}$. \square

⁵⁰⁷This proposition can be formulated in more abstract terms for congruence classes $\mu_1^{(xt)}$, $\mu_2^{(xt)}$, $\mu_3^{(xt)}$ of overextended angles as follows: $\mu_2^{(xt)} < \mu_3^{(xt)}$ implies $\mu_1^{(xt)} + \mu_2^{(xt)} < \mu_1^{(xt)} + \mu_3^{(xt)}$.

⁵⁰⁸This proposition can be formulated in more abstract terms for congruence classes $\mu_1^{(xt)}$, $\mu_2^{(xt)}$, $\mu_3^{(xt)}$ of overextended angles as follows: $\mu_1^{(xt)} + \mu_2^{(xt)} < \mu_1^{(xt)} + \mu_3^{(xt)}$ implies $\mu_2^{(xt)} < \mu_3^{(xt)}$.

⁵⁰⁹Observe that the requirement $\mu_1^{(xt)} < \mu_3^{(xt)}$ gives $n_1 \leq n_3$. The fact that $l \subset \text{Int}\angle(h, k) \xrightarrow{\text{C1.3.16.4}} \angle(h, l) < \angle(h, k)$ in view of $\mu_1^{(xt)} < \mu_3^{(xt)}$ gives $n_1 \neq n_3$. Thus, we have $n_1 + 1 \leq n_3$.

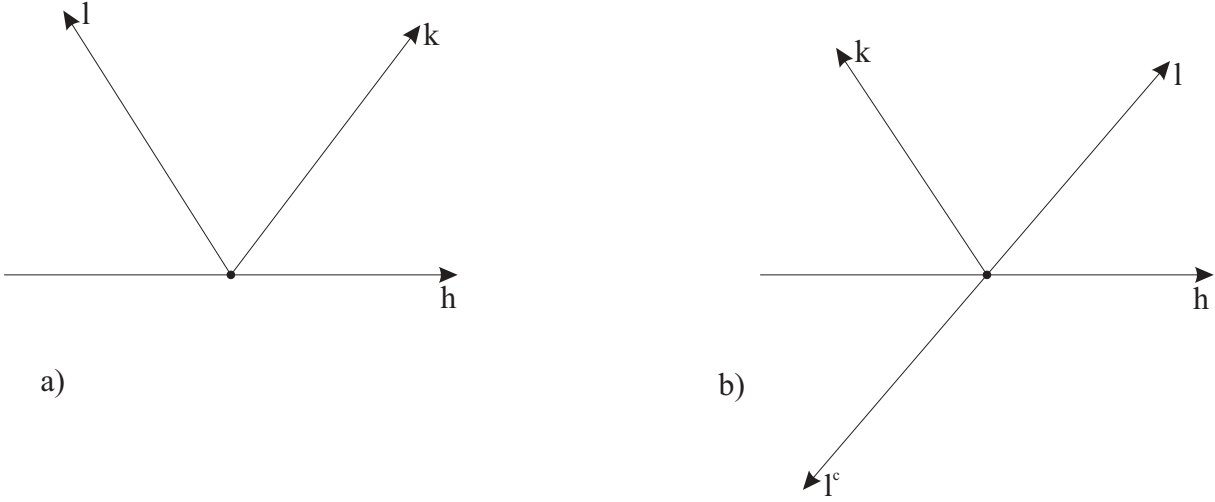

Figure 1.171: Illustration for proof of P 1.3.66.12.

If $\mu_1^{(xt)} + \mu_2^{(xt)} = \mu_3^{(xt)}$ (and then, of course, $\mu_2^{(xt)} + \mu_1^{(xt)} = \mu_3^{(xt)}$ in view of T 1.3.64), we shall refer to the class $\mu_2^{(xt)}$ of congruent overextended angles as the difference of the classes $\mu_3^{(xt)}, \mu_1^{(xt)}$ of congruent overextended angles, and write $\mu_2^{(xt)} = \mu_3^{(xt)} - \mu_1^{(xt)}$. That is, $\mu_2^{(xt)} = \mu_3^{(xt)} - \mu_1^{(xt)} \stackrel{\text{def}}{\iff} \mu_1^{(xt)} + \mu_2^{(xt)} = \mu_3^{(xt)}$. The preceding proposition shows that the difference of classes of congruent overextended angles is well defined.

Proposition 1.3.66.13. For classes $\mu_1^{(xt)}, \mu_2, \mu_3, \mu_4$ of congruent overextended angles the inequalities $\mu_1^{(xt)} < \mu_2^{(xt)}, \mu_3^{(xt)} < \mu_4^{(xt)}$ imply $\mu_1^{(xt)} + \mu_3^{(xt)} < \mu_2^{(xt)} + \mu_4^{(xt)}$. ⁵¹⁰

Proof. \square

Proposition 1.3.66.14. For classes $\mu_1^{(xt)}, \mu_2^{(xt)}, \mu_3^{(xt)}, \mu_4^{(xt)}$ of congruent overextended angles we have: $\mu_1^{(xt)} + \mu_2^{(xt)} = \mu_3^{(xt)} + \mu_4^{(xt)}$ and $\mu_2^{(xt)} > \mu_4^{(xt)}$ implies $\mu_1 < \mu_3$.

Proof. \square

The preceding results can be directly extended to any finite number of (congruence classes) of overextended angles.

Corollary 1.3.66.15. Given a natural number $n \in \mathbb{N}$, if $\mu(\angle(h_i, k_i), n_i) \leq \mu(\angle(l_i, m_i), p_i)$ for all $i \in \mathbb{N}_n$ then $\sum_{i=1}^n \mu(\angle(h_i, k_i), n_i) \leq \sum_{i=1}^n \mu(\angle(l_i, m_i), p_i)$. Furthermore, if there exists an $i_0 \in i \in \mathbb{N}_n$ such that $\mu(\angle(h_{i_0}, k_{i_0}), n_{i_0}) \leq \mu(\angle(l_{i_0}, m_{i_0}), p_{i_0})$ then $\sum_{i=1}^n \mu(\angle(h_i, k_i), n_i) < \sum_{i=1}^n \mu(\angle(l_i, m_i), p_i)$. In particular, $\mu(\angle(h, k), p) \leq \mu(\angle(l, m), p)$ implies $n\mu(\angle(h, k), n) \leq n\mu(\angle(l, m), p)$ for any $n \in \mathbb{N}$.

Proof. \square

A similar result is obviously valid for classes of congruent overextended angles:

Corollary 1.3.66.16. Given a natural number $n \in \mathbb{N}$, if $\mu_i^{(xt)} \leq \mu_i'^{(xt)}$ for all $i \in \mathbb{N}_n$ then $\sum_{i=1}^n \mu_i^{(xt)} \leq \sum_{i=1}^n \mu_i'^{(xt)}$. Furthermore, if there exists an $i_0 \in i \in \mathbb{N}_n$ such that $\mu_{i_0}^{(xt)} \leq \mu_{i_0}'^{(xt)}$ then $\sum_{i=1}^n \mu_i^{(xt)} < \sum_{i=1}^n \mu_i'^{(xt)}$. In particular, if $\mu^{(xt)} < \mu'^{(xt)}$ then $n\mu^{(xt)} < n\mu'^{(xt)}$.

Proof. \square

Proposition 1.3.66.17. *Proof.* \square

Proposition 1.3.66.18. *Proof.* \square

Proposition 1.3.66.19. *Proof.* \square

Given a triangle $\triangle ABC$, we shall refer to the sum $\Sigma_{\triangle ABC}^{(abs)\angle} \equiv \mu(\angle BAC, 0) + \mu(\angle ABC, 0) + \mu(\angle ACB, 0)$ of the classes $\mu(\angle BAC, 0), \mu(\angle ABC, 0), \mu(\angle ACB, 0)$ of overextended angles as the abstract sum of the angles of the triangle $\triangle ABC$.

Evidently, congruent triangles always have equal abstract sums of angles.

We shall denote $\pi^{(abs,xt)}$ the class of congruent overextended angles formed by all pairs $(\angle(h, h^c), 0)$, where $\angle(h, h^c)$ is, of course, a straight angle.

⁵¹⁰And, of course, the inequalities $\mu_1^{(xt)} > \mu_2^{(xt)}, \mu_3^{(xt)} > \mu_4^{(xt)}$ imply $\mu_1^{(xt)} + \mu_3^{(xt)} > \mu_2^{(xt)} + \mu_4^{(xt)}$. The inequalities involved will also hold for any representatives of the corresponding classes.

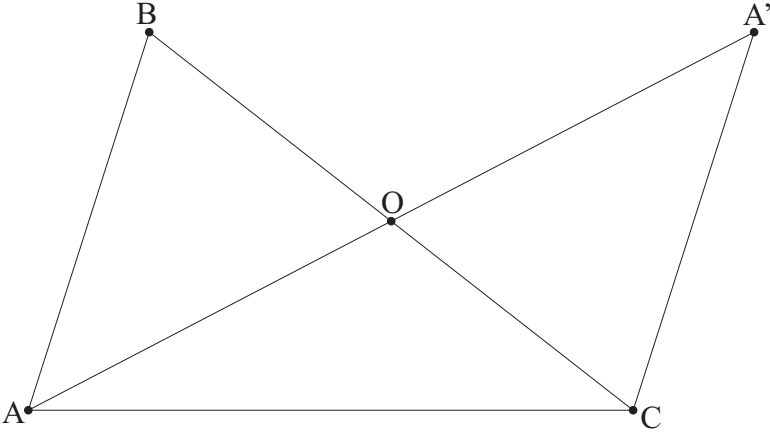

Figure 1.172: Given a triangle $\triangle ABC$, there is a triangle one of whose angles is at least two times smaller than $\angle A$.

Since $\mu(\angle_1, 0) + \mu(\angle_2, 0) + \dots + \mu(\angle_n, 0) = \mu(\angle, 0) \Leftrightarrow \mu\angle_1 + \mu\angle_2 + \dots + \mu\angle_n = \mu\angle$, given a triangle $\triangle ABC$, we shall sometimes refer synonymously to the sum $\mu\angle A + \mu\angle B + \mu\angle C$, whenever it makes sense and is equal to some congruence class $\mu\angle$ of extended angles, as the abstract sum of the angles of the triangle $\triangle ABC$.

Proposition 1.3.67.8. *Given a triangle $\triangle ABC$, there is a triangle with the same abstract sum of angles, one of whose angles is at least two times smaller than $\angle A$.*

Proof. (See Fig. 1.172.) Denote $O \equiv \text{mid}AC$ (see T 1.3.22). Take A' so that $[AOA']$, $OA \equiv OA'$ (see A 1.3.1). Then $[AOA'] \& [BOC] \Rightarrow \angle A'OC = \text{vert}\angle AOB \stackrel{\text{T1.3.7}}{\Rightarrow} \angle A'OC \equiv \angle AOB$. $AO \equiv OA' \& BO = OC \angle A'OC \equiv \angle AOB \stackrel{\text{T1.3.4}}{\Rightarrow} \triangle A'OC \equiv \triangle AOB \Rightarrow \angle OA'C \equiv \angle OAB \& \angle OCA' \equiv \angle OAB$. Using L 1.2.21.6, L 1.2.21.4, we can write $O \in (BC) \cap (AA') \Rightarrow A_O \subset \text{Int}\angle BAC \& C_O \subset \text{Int}\angle ACA' \Rightarrow \mu\angle BAC = \mu\angle BAO + \mu\angle CAO \& \mu\angle ACA' = \mu\angle ACO + \mu\angle A'CO$. Also, we shall make use of the fact that $O \in (BC) \cap (AA') \stackrel{\text{L1.2.11.15}}{\Rightarrow} \angle ABO = \angle ABC \& \angle OA'C = \angle AA'C \& \angle OAC = \angle A'AC$. We can now write $\Sigma_{\triangle ABC}^{(\text{abs})\angle} = \mu(\angle BAC, 0) + \mu(\angle ABC, 0) + \mu(\angle ACB, 0) = \mu(\angle BAO, 0) + \mu(\angle CAO, 0) + \mu(\angle ABC, 0) + \mu(\angle ACB, 0) = \mu(\angle OA'C, 0) + \mu(\angle CAA', 0) + \mu(\angle OCA', 0) + \mu(\angle ACO, 0) = \mu(\angle AA'C, 0) + \mu(\angle CAA', 0) + \mu(\angle ACA', 0) = \Sigma_{\triangle AA'C}^{(\text{abs})\angle}$. Furthermore, since $\mu\angle BAC = \mu\angle BAO + \mu\angle CAO = \mu\angle AA'C + \mu\angle CAA'$, one of the angles of $\triangle AA'C$ is at least two times smaller than $\angle BAC$. ⁵¹¹ \square

Proposition 1.3.67.9. *Given a cevian BD in a triangle $\triangle ABC$, if the abstract sums of angles in the triangles $\triangle ABD$, $\triangle CBD$ are both equal to $\pi^{(\text{abs}, xt)}$, then the abstract sum of angles in the triangle $\triangle ABC$ also equals $\pi^{(\text{abs}, xt)}$.*

Proof. By definition, $\Sigma_{\triangle ABD}^{(\text{abs})\angle} = \mu(\angle BAD, 0) + \mu(\angle ABD, 0) + \mu(\angle ADB, 0)$, $\Sigma_{\triangle DBC}^{(\text{abs})\angle} = \mu(\angle BDC, 0) + \mu(\angle DBC, 0) + \mu(\angle DCB, 0)$, $\Sigma_{\triangle ABC}^{(\text{abs})\angle} = \mu(\angle BAC, 0) + \mu(\angle ABC, 0) + \mu(\angle ACB, 0)$. Taking into account that $\mu(\angle ABC, 0) = \mu(\angle ABD, 0) + \mu(\angle DBC, 0)$, $\mu(\angle ADB, 0) + \mu(\angle BDC, 0) = \pi^{(\text{abs}, xt)}$, we have $\Sigma_{\triangle ABD}^{(\text{abs})\angle} + \Sigma_{\triangle DBC}^{(\text{abs})\angle} = \Sigma_{\triangle ABC}^{(\text{abs})\angle} + \pi^{(\text{abs}, xt)}$. Since, by hypothesis, $\Sigma_{\triangle ABD}^{(\text{abs})\angle} = \Sigma_{\triangle DBC}^{(\text{abs})\angle} = \pi^{(\text{abs}, xt)}$, from P 1.3.66.11 we have immediately $\Sigma_{\triangle ABC}^{(\text{abs})\angle} = \pi^{(\text{abs}, xt)}$, as required. \square

Proposition 1.3.67.10. *Given a triangle $\triangle ACB$ such that $\angle ACB$ is a right angle and $\Sigma_{\triangle ACB}^{(\text{abs})\angle} = \pi^{(\text{abs}, xt)}$, in the triangle $\triangle CDA$ such that $[CBD]$, $BC \equiv BD$ we also have $\Sigma_{\triangle CDA}^{(\text{abs})\angle} = \pi^{(\text{abs}, xt)}$.*

Proof. (See Fig. 1.173.) Using A 1.3.4, A 1.3.1, construct a point C' such that C, C' lie on opposite sides of the line a_{AB} and $\angle CAB \equiv \angle ABC'$, $AC \equiv BC'$. By T 1.3.4 $\triangle ACB \equiv \triangle AC'B$. It follows that $\angle AC'B$ is a right angle (see L 1.3.8.2) and $\angle ABC \equiv \angle BAC'$. By C 1.3.17.4 the angles $\angle CAB, \angle ABC$ are acute, as consequently are angles $\angle C'AB, \angle C'BA$ (see L 1.3.16.16). Hence by C 1.3.18.12 the ray A_B lies inside the angle $\angle CAC'$ and the ray B_A lies inside the angle $\angle CBC'$. This, in turn, implies $\mu\angle CAB + \mu\angle C'AB = \mu\angle CAC'$, $\mu\angle CBA + \mu\angle C'BA = \mu\angle C'BC$. Since $\angle ACB, \angle AC'B$ are right angles and $\Sigma_{\triangle ACB}^{(\text{abs})\angle} = \Sigma_{\triangle AC'B}^{(\text{abs})\angle} = \pi^{(\text{abs}, xt)}$, we conclude that $\mu\angle CAC' = \mu\angle C'BC = (1/2)\pi^{(\text{abs})}$, i.e. $\angle CAC', \angle C'BC$ are both right angles. Using A 1.3.1, choose D so that $[CBD]$ and $BC \equiv BD$. By L 1.2.21.6, L 1.2.21.4 we have $A_B \subset \text{Int}\angle CAD$. Since also $A_B \subset \text{Int}\angle CAC'$, by definition of interior both A_B, A_C' and A_B, A_D lie on the same side of the line a_{AC} . Hence by L 1.2.18.2 the rays A_D, A_C' lie on the same side of a_{AC} . Since $\angle CAD < \angle CAC'$ (the angle $\angle CAD$ being an acute angle, and $\angle CAC'$ a right angle), we have $A_D \subset \text{Int}\angle CAC'$ (see C 1.3.16.4). Now we can write $A_B \subset \text{Int}\angle CAD \& A_D \subset \text{Int}\angle CAC' \stackrel{\text{L1.2.21.27}}{\Rightarrow} A_D \subset \text{Int}\angle BAC' \stackrel{\text{L1.2.21.10}}{\Rightarrow} \exists O \ O \in A_D \cap (BC')$. $O \in A_D \stackrel{\text{L1.2.11.8}}{\Rightarrow} [AOD] \vee [ADO] \vee O = D$. Using C 1.3.18.4

⁵¹¹In fact, if this were not the case, we would have $\mu\angle AA'C > (1/2)\mu\angle BAC$, $\mu\angle CAA' > (1/2)\mu\angle BAC$, whence $\mu\angle BAC > \mu\angle AA'C + \mu\angle CAA'$, which contradicts $\mu\angle BAC = \mu\angle AA'C + \mu\angle CAA'$.

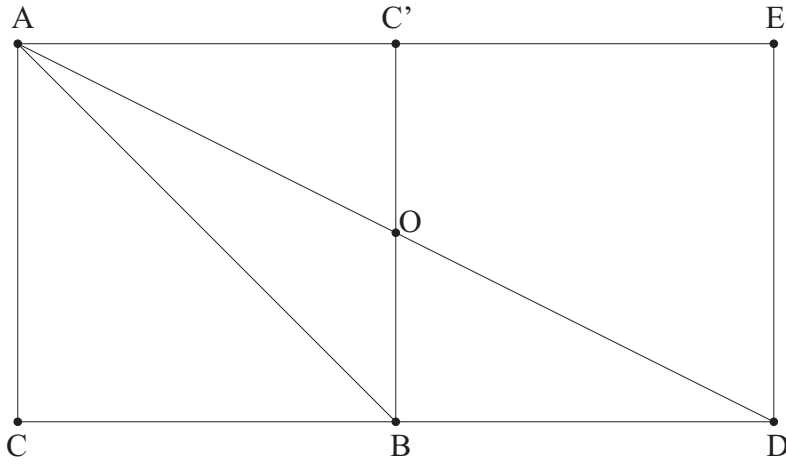

Figure 1.173: Given a triangle $\triangle ACB$ such that $\angle ACB$ is a right angle and $\Sigma_{\triangle ACB}^{(abs)\angle} = \pi^{(abs,xt)}$, in the triangle $\triangle CDA$ such that $[CBD]$, $BC \equiv BD$ we also have $\Sigma_{\triangle CDA}^{(abs)\angle} = \pi^{(abs,xt)}$.

we see that $AO < AB < AD$.⁵¹² These inequalities imply that $[AOD]$.⁵¹³ Thus, the angles $\angle AOC'$, $\angle BOD$ are vertical. They are, consequently, congruent (T 1.3.7). Evidently, $[BOC'] \xrightarrow{L1.2.11.15} B_O = B_{C'} \& C'_O = C_B \Rightarrow \angle AC'B = \angle AC'O \& \angle OBD = \angle C'BD$. Furthermore, since the right angles $\angle AC'B = \angle AC'O$ and $\angle OBD = \angle C'BD = \text{adjsp}\angle C'BC$ are congruent (T 1.3.16) and $BC \equiv AC' \& BC \equiv BD \Rightarrow AC' \equiv BD$, by T 1.3.19 we have $\triangle AOC' \equiv \triangle BOD$, whence $\angle C'AO \equiv \angle BDO$. Using A 1.3.1, choose a point E such that $[AC'E]$ and $AC' \equiv C'E$. Since $[AC'E]$, $[AOD]$, and $[CBD]$, using L 1.2.11.15 we can write $\angle C'AO = \angle EAD$, $\angle BDO = \angle CDA$. Hence $\angle EAD \equiv \angle CDA$. Furthermore, in view of $BC \equiv BD \equiv AC' \equiv C'E$ and $[CBD]$, $[AC'E]$, by A 1.3.3 we have $CD \equiv AE$. Hence from T 1.3.4 we have $\triangle CDA \equiv \triangle EAD$. In particular, $\angle CAD \equiv \angle ADE$, $\angle ACD \equiv \angle AED$. The latter means that $\angle AED$ is a right angle (see L 1.3.8.2). Since $\mu\angle CAD + \mu\angle EAD = \mu\angle CAC' = (1/2)\pi^{(abs)}$, the congruences $\angle CDA \equiv \angle EAD$, $\angle CAD \equiv \angle ADE$ imply that also $\mu\angle CDA + \mu\angle EDA = (1/2)\pi^{(abs)}$. Therefore, we have $\Sigma_{\triangle CDA}^{(abs)\angle} + \Sigma_{\triangle EAD}^{(abs)\angle} = \mu(\angle ACD, 0) + \mu(\angle CDA, 0) + \mu(\angle CAD, 0) + \mu(\angle AED, 0) + \mu(\angle EAD, 0) + \mu(\angle ADE, 0) = \pi^{(abs,xt)} + \pi^{(abs,xt)}$. Finally, since the congruence $\triangle CDA \equiv \triangle EAD$ implies $\Sigma_{\triangle CDA}^{(abs)\angle} = \Sigma_{\triangle EAD}^{(abs)\angle}$, we conclude that $\Sigma_{\triangle CDA}^{(abs)\angle} = \pi^{(abs,xt)}$, as required. \square

Proposition 1.3.67.11. *Suppose that the (abstract) sum of the angles of a triangle $\triangle ABC$ is equal to $\pi^{(abs,xt)}$. Then $\mu\angle A + \mu\angle B = \mu(\text{adjsp}\angle C)$.*

Proof. We can write $\mu\angle A + \mu\angle B + \mu\angle C = \pi^{(abs)} = \mu\angle C + \mu(\text{adjsp}\angle C)$. Hence the result follows by P 1.3.63.5. \square

In the case of triangles whose angle sums are less than $\pi^{(abs,xt)}$ we can take our consideration of angle sums in triangles one step further with the following definitions, which have played a key role in the development of the foundations of hyperbolic geometry:

A quadrilateral $ABCD$ with right angles $\angle ABC$, $\angle BCD$ is called a birectangle. We shall assume that the vertices A , D lie on the same side of the line a_{BC} containing the side BC . This guarantees that, as will be shown below in a broader context, the birectangle is convex and, in particular, simple.

An isosceles birectangle $ABCD$, i.e. a birectangle $ABCD$ whose sides AB , CD are congruent, is called a Saccheri quadrilateral. The side BC is called the base, and the side AD the summit of the Saccheri quadrilateral. The angles $\angle BAD$, $\angle CDA$ are referred to as the summit angles of the quadrilateral $ABCD$. Finally, the interval MN joining the midpoints M , N of the summit and the base, respectively, is referred to as the altitude of the Saccheri quadrilateral, and the line a_{MN} as the altitude line of the quadrilateral $ABCD$.

Consider a triangle $\triangle ABC$ with its (abstract) sum of the angles $\Sigma_{\triangle ABC}^{(abs)\angle}$ less than $\pi^{(abs,xt)}$. We shall refer to the difference $\delta_{\triangle ABC}^{(abs)\angle} \equiv \pi^{(abs,xt)} - \Sigma_{\triangle ABC}^{(abs)\angle}$ ⁵¹⁴ as the angular defect of the triangle $\triangle ABC$. Evidently, congruent

⁵¹²In fact, since $\angle AC'O = \angle AC'B$ is a right angle, as is $\angle ACB$, from L 1.3.16.17, C 1.3.17.4 we have $\angle AOC' < \angle AC'O$, $\angle ABC < \angle ACB$.

⁵¹³There are multiple ways to show that of the three alternatives $[AOD]$, $[ADO]$, $A = D$ we must choose $[AOD]$. Unfortunately, the author has failed to find an easy one. (Assuming such an easy way exists!) In addition to the one presented above, we outline here a couple of other possible approaches. The first of them starts with the observation that $a_{AC} = a_{BC'}$, so that the points A , C lie on the same side of the line $a_{BC'}$. But $[CBD]$ implies that C , D lie on opposite sides of the line $a_{BC'}$. By L 1.2.17.10 A , D lie on opposite sides of the line $a_{BC'}$. Hence $\exists O' \in (AD) \cap a_{BC'}$. Since the lines a_{AD} , $a_{BC'}$ are obviously distinct ($A \notin a_{BC'}$), $O' = O$ is the only point they can have in common (T 1.1.1), whence the result. Perhaps the most perverse way to show that $[AOD]$ involves the observation that the line $a_{BC'}$ lies in the plane α_{ACD} , does not contain any of the points A , C , D , and meets the open interval (CD) in the point B . The Pasch's axiom (A 1.2.4) then shows that the line $a_{BC'}$ then meets the open interval (AD) in a point O' which is bound to coincide with O since the lines a_{AD} , $a_{BC'}$ are distinct.

⁵¹⁴Since $\Sigma_{\triangle ABC}^{(abs)\angle} < \pi^{(abs,xt)}$ the subtraction makes sense.

triangles have equal angular defects.

Proposition 1.3.67.12. *Given a cevian BD in a triangle $\triangle ABC$, the sum of angular defects of the triangles $\triangle ABD$, $\triangle DBC$ equals the angular defect of the triangle ABC .*

Proof. Using the definition of angular defect, we can write

$$\mu(\angle DAB, 0) + \mu(\angle ABD, 0) + \mu(\angle BDA, 0) + \delta_{\triangle ABD}^{(abs)\angle} = \pi^{(abs,xt)} \quad (1.4)$$

and

$$\mu(\angle DCB, 0) + \mu(\angle CBD, 0) + \mu(\angle BDC, 0) + \delta_{\triangle CBD}^{(abs)\angle} = \pi^{(abs,xt)}. \quad (1.5)$$

Adding up the equations (1.4), (1.5) and taking into account that $\mu(\angle ADB, 0) + \mu(\angle CDB, 0) = \pi^{(abs,xt)}$ ⁵¹⁵, $\mu(\angle ABD, 0) + \mu(\angle CBD, 0) = \mu(\angle ABC, 0)$,⁵¹⁶ we obtain

$$\mu(\angle CAB, 0) + \mu(\angle ABC, 0) + \mu(\angle BCA, 0) + \delta_{\triangle ABD}^{(abs)\angle} + \delta_{\triangle CBD}^{(abs)\angle} + \pi^{(abs,xt)} = \pi^{(abs,xt)} + \pi^{(abs,xt)},$$

whence (see Pr 1.3.63.5)

$$\mu(\angle CAB, 0) + \mu(\angle ABC, 0) + \mu(\angle BCA, 0) + \delta_{\triangle ABD}^{(abs)\angle} + \delta_{\triangle CBD}^{(abs)\angle} = \pi^{(abs,xt)}.$$

But from the definition of the defect of $\triangle ABC$ we have $\mu(\angle CAB, 0) + \mu(\angle ABC, 0) + \mu(\angle BCA, 0) + \delta_{\triangle ABC}^{(abs)\angle} = \pi^{(abs,xt)}$. Hence, using Pr 1.3.63.5 again, we see that $\delta_{\triangle ABD}^{(abs)\angle} + \delta_{\triangle CBD}^{(abs)\angle} = \delta_{\triangle ABC}^{(abs)\angle}$, q.e.d. \square

Corollary 1.3.67.13. *Given a cevian BD in a triangle $\triangle ABC$, the angular defect of each of the triangles $\triangle ABD$, $\triangle DBC$ is less than the angular defect of the triangle ABC .*

Proof. Follows from the preceding proposition (P 1.3.67.12) and P 1.3.63.1. \square

Corollary 1.3.67.14. *Given a triangle $\triangle ABC$ and points $D \in (AC)$, $E \in (AB)$, the angular defect of the triangle $\triangle ADE$ is less than the angular defect of the triangle ABC .*

Proof. We just need to apply the preceding corollary (C 1.3.67.13) twice⁵¹⁷ and then use T 1.3.66. \square

The preceding two corollaries can be reformulated in terms of the angle sums of the triangles involved as follows:

Corollary 1.3.67.15. *Given a cevian BD in a triangle $\triangle ABC$, the (abstract) angle sum of each of the triangles $\triangle ABD$, $\triangle DBC$ is less than the (abstract) angle sum of the triangle ABC .*

Proof. Follows from C 1.3.67.13, P 1.3.66.8. \square

Corollary 1.3.67.16. *Given a triangle $\triangle ABC$ and points $D \in (AC)$, $E \in (AB)$, the angle sum of the triangle $\triangle ADE$ is greater than the angle sum of the triangle ABC .*

Proof. Follows from C 1.3.67.14, P 1.3.66.9. \square

Theorem 1.3.67. *Suppose that the (abstract) sum of the angles of any triangle $\triangle ABC$ equals $\pi^{(abs,xt)}$. Then the sum of the angles of any convex polygon with $n > 3$ sides is $(n - 2)\pi^{(abs,xt)}$.*

Proof. \square

Theorem 1.3.68. *Suppose that the (abstract) sum of the angles of any triangle $\triangle ABC$ is less than $\pi^{(abs,xt)}$. Then the sum of the angles of any convex polygon with $n > 3$ sides is less than $(n - 2)\pi^{(abs,xt)}$.*

Proof. \square

We have saw previously that the summit of any Saccheri quadrilateral is parallel to its base (see T 1.3.28). This implies, in particular, that any Saccheri quadrilateral is convex. It can be proved that the summit angles of any Saccheri quadrilateral are congruent. We are going to do this, however, in a more general context.

Consider a quadrilateral $ABCD$ such that the vertices A , D lie on the same side of the line a_{BC} ⁵¹⁸ and $\angle ABC \equiv \angle BCD$, $BA \equiv CD$. We will refer any such quadrilateral as an isosceles quadrilateral.

Lemma 1.3.68.1. *Any isosceles quadrilateral $ABCD$ ⁵¹⁹ is a trapezoid.*

⁵¹⁵Since $D \in (AC)$, the angles $\angle ADB$, $\angle CDB$ are adjacent supplementary.

⁵¹⁶We take into account that the ray B_D lies completely inside the angle $\angle ABC$, which, in its turn, implies that $\mu(\angle ABD, 0) + \mu(\angle CBD, 0) = \mu(\angle ABC, 0)$ (see L 1.2.21.6, L 1.2.21.4). We also silently use the obvious equalities $\angle BAD = \angle BAC$, $\angle BCD = \angle BCA$.

⁵¹⁷From C 1.3.67.13 the angular defect of $\triangle ADE$ is less than the angular defect of the triangle ABD , which, in turn, is less than the angular defect of $\triangle ABC$.

⁵¹⁸This condition is required for the quadrilateral to be simple.

⁵¹⁹That is, a quadrilateral $ABCD$ with $AD \parallel BC$ and $\angle ABC \equiv \angle BCD$, $BA \equiv CD$.

Proof. Denote by E, F , respectively the feet of the perpendiculars drawn through the points A, D to the line a_{BC} . To show that E, F are distinct, suppose the contrary, i.e. that $E = F$. Then we have $A \in E_D$ from L 1.3.24.1. Furthermore, in this case $E \neq B$ by L 1.3.8.1, and for the same reason $E \neq C$. Thus, the points A, B, E are not collinear, as are the points D, C, E . Additionally, we can claim that $[BEC]$. In fact, since $B \neq E \neq C$, in view of T 1.2.2 we have either $[EBC]$, or $[BCE]$, or $[BEC]$. Suppose that $[EBC]$. Then the angle $\angle BCD = \angle ECD$ is acute as being a non-right angle in a right-angled triangle $\triangle DEC$. Since $\angle AEB$ is, by construction, a right angle, we have $\angle BCD < \angle AEB$ (see L 1.3.16.17). On the other hand, by T 1.3.17 we have $\angle AEB < \angle ABC$. Thus, we obtain $\angle BCD < \angle ABC$, in contradiction with $\angle ABC \equiv \angle BCD$ (by hypothesis). This contradiction shows that the assumption that $[EBC]$ is not valid. Similarly, it can be shown that $\neg[BCE]$.⁵²⁰ Thus, $[BEC]$, which implies that $\angle ABE = \angle ABC$, $\angle ECD = \angle BCD$. Consequently, we have $\angle ABE \equiv \angle ECD$, which together with $\angle AEB \equiv \angle DEC$ (see T 1.3.16) gives $\triangle AEB \equiv \triangle DEC$, whence $EA \equiv ED$. But $EA \equiv ED \& D \in E_A \xrightarrow{A1.3.1} A = D$, in contradiction with the requirements $A \neq D$, necessary if the quadrilateral $ABCD$ is to make any sense. The contradiction shows that in reality $E \neq F$. Suppose now $E = B$. Then also $F = C$ (see L 1.3.8.1, L 1.3.8.2), and $ABCD$ is a Saccheri quadrilateral, and, consequently, a trapezoid by T 1.3.28. Suppose $E \neq B$. Then also $F \neq C$.⁵²¹ We are going to show that $\angle ABE \equiv \angle DCF$. Suppose that $\angle ABC$ is acute.⁵²² Then $E \in B_C$ (see C 1.3.18.11), whence $\angle ABE = \angle ABC$ (see L 1.2.11.3). Similarly, we have $F \in C_B$,⁵²³ whence $\angle DCF = \angle DCB$. Taking into account $\angle ABC \equiv \angle BCD$, we conclude that $\angle ACE \equiv \angle DCF$. Suppose now that $\angle ABC$ is obtuse. Then $\angle DCB$ is also obtuse and, using C 1.3.18.11, L 1.2.11.3, and, additionally, T 1.3.6, we again find that $\angle ACE \equiv \angle DCF$. Now we can write⁵²⁴ $BA \equiv CD \& \angle ABE \equiv \angle DCF \& \angle AEB \equiv \angle DFC \xrightarrow{T1.3.19} \triangle AEB \equiv \triangle DFC \Rightarrow AE \equiv DF$. Finally, applying T 1.3.28 to the Saccheri quadrilateral $AEFD$, we reach the required result. \square

Lemma 1.3.68.2. *Consider an arbitrary isosceles quadrilateral $ABCD$, in which, by definition ADa_{BC} , $\angle ABC \equiv \angle BCD$, and $BA \equiv CD$. Suppose further that its sides $(AB), CD$ do not meet. Then:*

1. *The diagonals $(AC), (BD)$ concur in a point O .*
2. *The quadrilateral $ABCD$ is convex.*
3. *The summit angles $\angle BAD, \angle CDA$ are congruent.*
4. *Furthermore, we have $BO \equiv CO, AO \equiv DO, \angle BAC \equiv \angle CDB, \angle BDA \equiv \angle CAD, \angle BCA \equiv \angle CBD, \angle ABD \equiv \angle DCA$.*

Proof. 1. See T 1.2.42 (see also the preceding lemma, L 1.3.68.1).

2. See L 1.2.62.3.

3, 4. $AB \equiv DC \& \angle ABC \equiv \angle DCB \& BC \equiv CB \xrightarrow{T1.3.4} \triangle ABC \equiv \triangle DCB \Rightarrow \angle BAC \equiv \angle CDB \& \angle BCA \equiv \angle CBD \& AC \equiv DB$. $AB \equiv DC \& AD \equiv DA \& BD \equiv CA \xrightarrow{T1.3.10} \triangle BAD \equiv \triangle CDA \Rightarrow \angle BAD \equiv \angle CDA \& \angle BDA \equiv \angle CAD \& \angle ABD \equiv \angle DCA$. Using L 1.2.11.15 we can write $[AOC] \& [DOB] \Rightarrow \angle BCO = \angle BCA \& \angle CBO = \angle CBD \& \angle DAO \equiv \angle DAC \& \angle ADO \equiv \angle ADB$. Hence $\angle BCO \equiv \angle CBO, \angle ADO \equiv \angle DAO$. \square

Corollary 1.3.69.1. *Suppose that the (abstract) sum of the angles of any triangle $\triangle ABC$ equals $\pi^{(abs,xt)}$. Then any Saccheri quadrilateral is a rectangle.*

Proof. \square

Corollary 1.3.69.2. *Suppose that the (abstract) sum of the angles of any triangle $\triangle ABC$ is less than $\pi^{(abs,xt)}$. Then any Saccheri quadrilateral has two acute angles.*

Proof. \square

A quadrilateral $ABCD$ with three right angles (say, $\angle DAB, \angle ABC$, and $\angle BCD$) is called a Lambert quadrilateral.

Corollary 1.3.69.3. *Suppose that the (abstract) sum of the angles of any triangle $\triangle ABC$ equals $\pi^{(abs,xt)}$. Then any Lambert quadrilateral is a rectangle.*

Proof. \square

Corollary 1.3.69.4. *Suppose that the (abstract) sum of the angles of any triangle $\triangle ABC$ is less than $\pi^{(abs,xt)}$. Then any Lambert quadrilateral has an acute angle.*

Proof. \square

⁵²⁰It is convenient to do this by substituting $A \leftrightarrow D, B \leftrightarrow C$ and using the symmetry of the conditions of the lemma with respect to these substitutions.

⁵²¹Otherwise we would have $E = B$.

⁵²²We silently employ the facts that any angle is either acute, or right, or obtuse, and that there is at most one right angle in a right triangle.

⁵²³If $\angle ABC$ is acute, then the angle BCD , congruent to it, is also acute.

⁵²⁴T 1.3.16 ensures that $\angle AEB \equiv \angle DFC$.

In general, it is not possible to introduce plane or space vectors in absolute geometry so that all axioms of vector space concerning addition of vectors are satisfied. However, this can be successfully achieved on the line.

In all cases vectors are defined as equivalence classes of ordered abstract intervals. By definition, any zero ordered abstract interval is equivalent to any zero ordered abstract interval (including itself) and is not equivalent to any non-zero ordered abstract interval. Zero vectors will be denoted by $\vec{0}$. We shall say that a non-zero ordered abstract interval \vec{AB} is equivalent⁵²⁵ to a non-zero ordered abstract interval \vec{CD} collinear to it (i.e. such that there is a line a such that $A \in a, B \in a, C \in a, D \in a$), and write $\vec{AB} \equiv \vec{CD}$ if and only if:

Either $\vec{AB} = \vec{CD}$, i.e. $A = C$ and $B = D$;

or $AB \equiv CD$ and $AC \equiv BD$.

Evidently, the condition $\vec{AB} \equiv \vec{CD}$ is equivalent to $\vec{AC} \equiv \vec{BD}$.

Theorem 1.3.71. *An ordered abstract interval \vec{AB} is equivalent to an ordered abstract interval \vec{CD} collinear to it if and only if:*

$AB \equiv CD$ and in any order on a (direct or inverse) $A \prec B \& C \prec D$ or $B \prec A \& D \prec C$.

Also, $\vec{AB} \equiv \vec{CD}$ iff either $B = C = \text{mid}AD$, or $A = D = \text{mid}BC$, or $\text{mid}BC = \text{mid}AD$.⁵²⁶

Proof. Suppose $AB \equiv CD, AC \equiv BD$, and $B \neq C$. Then, obviously, $A \neq D$. In fact, the three points B, C are necessarily distinct in this case.⁵²⁷ Hence $[ABC] \vee [BAC] \vee [ACB]$ by T 1.2.2. But all these options contradict either $AB \equiv CD$ or $AC \equiv BD$ in view of C 1.3.13.4, L 1.3.13.11. Denote $M = \text{mid}BC$. By definition of midpoint, $M = \text{mid}BC \Rightarrow BM \equiv MC \& [BMC]$. For distinct collinear points A, B, C, D we have one of the following six orders $[ABCD], [ABDC], [ACBD], [ACDB], [ADBC], [ADCB]$ or one of the 18 orders obtained from these 6 orders either by the simultaneous substitutions $A \leftrightarrow B, C \leftrightarrow D$, or by the simultaneous substitutions $A \leftrightarrow C, B \leftrightarrow D$ (see T 1.2.7). Due to symmetry of the conditions $AB \equiv CD, AC \equiv BD, B \neq C, A = D$ with respect to these substitutions, we can without any loss of generality restrict our consideration to the six orders mentioned above. Applying C 1.3.13.4, L 1.3.13.11 we can immediately disregard $[ABDC], [ACDB], [ADBC]$, and $[ADCB]$. For example, $[ABDC]$ is incompatible with $AC \equiv BD$. Thus, of the six cases $[ABCD], [ABDC], [ACBD], [ACDB], [ADBC], [ADCB]$ only $[ABCD], [ACBD]$ are actually possible. Observe further that $[ABCD] \stackrel{L??}{\Rightarrow} (A \prec B \prec C \prec D) \vee (D \prec C \prec B \prec A) \Rightarrow (A \prec B) \& (C \prec D) \vee (D \prec C) \& (B \prec A)$. Similarly, $[ACBD] \Rightarrow (A \prec B) \& (C \prec D) \vee (D \prec C) \& (B \prec A)$. Conversely, if both $AB \equiv CD$ and $(A \prec B) \& (C \prec D) \vee (D \prec C) \& (B \prec A)$, of the six cases $[ABCD], [ABDC], [ACBD], [ACDB], [ADBC], [ADCB]$ only $[ABCD], [ACBD]$ survive the conditions.⁵²⁸ Observe also that if we have $(A \prec B) \& (C \prec D) \vee (D \prec C) \& (B \prec A)$, this remains true after the simultaneous substitutions $A \leftrightarrow B, C \leftrightarrow D$, as well as $A \leftrightarrow C, B \leftrightarrow D$.

Suppose $[ABCD]$. Then $[ABC] \& [BMC] \& \stackrel{L1.2.3.2}{\Rightarrow} [ABM] \& [MCD]$ and $AB \equiv CD \& BM \equiv MC \& [ABM] \& [MCD] \stackrel{A1.3.3}{\Rightarrow} AM \equiv MD$, i.e. M is the midpoint of AD as well. The case $[ACBD]$ is considered by full analogy with $[ABCD]$; we need only to substitute $B \leftrightarrow C$ and use $AC \equiv BD$ in place of $AB \equiv CD$.⁵²⁹

Conversely, suppose that either $B = C = \text{mid}AD$, or $A = D = \text{mid}BC$, or $\text{mid}BC = \text{mid}AD$. If $B = C = \text{mid}AD$ or $A = D = \text{mid}BC$ the congruences $AB \equiv CD$ and $AC \equiv BD$ are obtained trivially from definition of midpoint. Suppose now that $\text{mid}BC = \text{mid}AD$, where $A \neq B$, and the points A, B, C, D colline.⁵³⁰ Suppose further that A, C lie (on the single line containing the points A, B, C, D) on the same side of $M = \text{mid}AD$. Then L 1.2.11.8 either A lies between M, C , or C lies between M, A , or $A = C$. Furthermore, taking into account that $M = \text{mid}BC = \text{mid}AD \Rightarrow [BMC] \& [AMD]$ and using L 1.2.11.9, L 1.2.11.10, we see that B, D also lie on the same side of the point M . Hence if $A = C$, then also $B = D$ and evidently $AB \equiv CD$.⁵³¹ Suppose now $[MCA]$. Then from L 1.3.9.1 we see that $AC \equiv BD$ and $[MBD]$. $[ACM] \& [CMB] \stackrel{L1.2.3.2}{\Rightarrow} [ACB], [CMB] \& [MBD] \stackrel{L1.2.3.2}{\Rightarrow} [CBD]$. $[ACB] \& [CBD] \& AC \equiv BD \& CB \equiv CB \stackrel{A1.3.3}{\Rightarrow} AB \equiv CD$.⁵³² \square

Theorem 1.3.72. *The relation of equivalence of ordered abstract intervals on a given line is indeed an equivalence relation, i.e. it possesses the properties of reflexivity, symmetry, and transitivity.*

Proof. Reflexivity and symmetry are obvious. In order to show transitivity, suppose $\vec{AB} \equiv \vec{CD}$ and $\vec{CD} \equiv \vec{EF}$. In view of the preceding theorem $AB \equiv CD$ and in any order on a (direct or inverse) $A \prec B \& C \prec D$ or $B \prec A \& D \prec C$.

⁵²⁵Strictly speaking, it is an offence against mathematical rigor to call a relation an equivalence before it is shown to possess the properties of reflexivity symmetry sand transitivity. However, as long as these properties are eventually shown to hold, in practice this creates no problem.

⁵²⁶In the last case we also assume that $A \neq B$ (and then it follows in an obvious way that $C \neq D$), so that the abstract intervals AB, CD make sense. We also require, of course, that three of (and thus all of) the points A, B, C, D are collinear.

⁵²⁷ $A \neq B, A \neq C$ because AB, AC make sense by hypothesis.

⁵²⁸In fact, using C 1.2.14.1, L 1.2.13.6, we can write $[ABDC] \Rightarrow A \prec D \prec B \prec C \Rightarrow (A \prec B) \& (D \prec C), [ADBC] \Rightarrow A \prec D \prec B \prec C \Rightarrow (A \prec B) \& (D \prec C), [ADCB] \Rightarrow A \prec D \prec C \prec B \Rightarrow (A \prec B) \& (D \prec C)$, i.e. in all cases we have a contradiction in view of L 1.2.13.5.

⁵²⁹Suppose $[ACBD]$. Then $[ACB] \& [CMB] \& [CBD] \stackrel{L1.2.3.2}{\Rightarrow} [ACM] \& [MBD]$ and $AC \equiv BD \& CM \equiv MB \& [ACM] \& [MBD] \stackrel{A1.3.3}{\Rightarrow} AM \equiv MD$, i.e. M is the midpoint of AD .

⁵³⁰As mentioned above, it suffices to require that any three of them colline.

⁵³¹In fact, $BM \equiv MC \& AM \equiv MD \& A = C \Rightarrow BM \equiv MD$, whence $B = D$ by T 1.3.2.

⁵³²Observe that we do not need to consider the case $[MAC]$ as the result of the simultaneous substitutions $A \leftrightarrow C, B \leftrightarrow D$ which do not alter our assumptions.

Similarly, $CD \equiv EF$ and in any order on a (direct or inverse) $C \prec D \& E \prec F$ or $D \prec C \& F \prec E$. Suppose $A \prec B \& C \prec D$. Then necessarily $C \prec D \& E \prec F$. Thus, we have $A \prec B \& E \prec F$. Since also, obviously, $AB \equiv CD \& CD \equiv EF \xrightarrow{T1.3.1} AB \equiv EF$. Thus, in this case $\overrightarrow{AB} \equiv \overrightarrow{CD}$. The case $B \prec A \& D \prec C$ is considered similarly. \square

A line vector is a class of equivalence of ordered abstract intervals on a given line a . Denote the class of equivalence of ordered abstract intervals on a given line a ⁵³³ containing the ordered abstract interval \overrightarrow{AB} by $\overrightarrow{\mathbf{a}}$. We shall also denote vectors by small letters as follows: $\overrightarrow{\mathbf{a}}$ (of course, the letter a used in this way has nothing to do with the letter a employed to denote lines; this coincidence merely reflects the regretful (but objective) tendency to run out of the letters of the alphabet in mathematical and scientific notation), $\overrightarrow{\mathbf{b}}$, $\overrightarrow{\mathbf{c}}$, ...

Lemma 1.3.73.1. *Given an ordered abstract interval \overrightarrow{AB} and a point C on the line a_{AB} , there is exactly one ordered abstract interval \overrightarrow{CD} (having C as its initial point), equivalent to \overrightarrow{AB} on a_{AB} .*

Proof. If $A = C$, we just let $B = D$. Suppose now that B, C lie on the same side of A . In view of L 1.2.11.8 this implies that either $[ACB]$, or $B = C$, or $[ABC]$. Using A 1.3.1, choose a point D such that $AB \equiv CD$ and the points A, D lie on opposite sides of the point C (i.e. $D \in C_A^c$). Suppose first that $[ACB]$. Then B, D lie on the same side of the point C (see L 1.2.11.10), and using L 1.2.11.8 we see that either $[CDB]$, or $B = D$, or $[CBD]$. But the first two options would give $CD < AB$ by C 1.3.13.4, which contradicts $AB \equiv CD$ in view of L 1.3.13.11. In the case when $[ABC]$, we can write $[ABC] \& [ACD] \xrightarrow{L1.2.3.2} [BCD]$. We see that in all cases we have either $[ACBD]$, or $B = C$, or $[ABCD]$, which, together with $AB \equiv CD$ in view of the preceding theorem (T 1.3.72) implies that $\overrightarrow{AB} \equiv \overrightarrow{CD}$. Suppose now that B, C lie on opposite sides of A , i.e. $[CAB]$. Then from C 1.3.9.2 there is a unique point $D \in (CB)$ such that $AB \equiv CD$. Obviously, in any order on a_{AB} we either have both $C \prec A \prec B$ and $C \prec D \prec B$, or $B \prec A \prec C$ and $B \prec D \prec C$ from T 1.2.14. Thus, we have either both $A \prec B$ and $C \prec D$, or $B \prec A$ and $D \prec C$, and using the preceding theorem (T 1.3.72) we again conclude that $\overrightarrow{AB} \equiv \overrightarrow{CD}$. To show uniqueness suppose $\overrightarrow{AB} \equiv \overrightarrow{CD}$, $\overrightarrow{AB} \equiv \overrightarrow{CE}$, where $C, D, E \in a_{AB}$ and $D \neq E$, so that \overrightarrow{CD} , \overrightarrow{CE} are distinct ordered abstract intervals. Since from the preceding theorem (T 1.3.72) we have both $AB \equiv CD$ and $AB \equiv CE$, in view of T 1.3.2 (see also T 1.3.1) the points D, E must lie on opposite sides of C if they are to be distinct. Hence in any order on a_{AB} we have either $E \prec C \prec D$ or $D \prec C \prec E$. But from our assumption $\overrightarrow{AB} \equiv \overrightarrow{CD}$, $\overrightarrow{AB} \equiv \overrightarrow{CE}$ and the preceding theorem (T 1.3.72) it is clear that we must have either both $E \prec C$, $D \prec C$, or both $C \prec D$ and $C \prec E$. Thus, in view of L 1.2.13.5 we obtain a contradiction, which shows that in fact the point $D \in a_{AB}$ with the property $\overrightarrow{AB} \equiv \overrightarrow{CD}$ is unique. \square

Given two vectors $\overrightarrow{\mathbf{a}}$, $\overrightarrow{\mathbf{b}}$, we define their sum $\overrightarrow{\mathbf{a}} + \overrightarrow{\mathbf{b}}$ as follows: By definition, $\overrightarrow{\mathbf{a}} + \overrightarrow{\mathbf{0}} = \overrightarrow{\mathbf{0}} + \overrightarrow{\mathbf{a}} = \overrightarrow{\mathbf{a}}$ for any vector a including the case when $\overrightarrow{\mathbf{a}}$ is itself a zero vector. In order to define the sum of non-zero vectors $\overrightarrow{\mathbf{a}}$, $\overrightarrow{\mathbf{b}}$, take an ordered abstract interval $\overrightarrow{AB} \in \overrightarrow{\mathbf{a}}$ and construct an ordered abstract interval $\overrightarrow{BC} \in \overrightarrow{\mathbf{b}}$. This is always possible to do by the preceding lemma (L 1.3.73.1). The sum $\overrightarrow{\mathbf{a}} + \overrightarrow{\mathbf{b}}$ of the vectors $\overrightarrow{\mathbf{a}}$ and $\overrightarrow{\mathbf{b}}$ is then by definition the vector $\overrightarrow{\mathbf{c}}$ (which, by the way, may happen to be a zero vector) containing the ordered abstract interval \overrightarrow{AC} .

To establish that the sum of $\overrightarrow{\mathbf{a}}$, $\overrightarrow{\mathbf{b}}$ is well defined, consider ordered abstract intervals $\overrightarrow{AB} \in \overrightarrow{\mathbf{a}}$, $\overrightarrow{A'B'} \in \overrightarrow{\mathbf{a}}$, $\overrightarrow{BC} \in \overrightarrow{\mathbf{b}}$, $\overrightarrow{B'C'} \in \overrightarrow{\mathbf{b}}$. We need to show that $\overrightarrow{AC} \equiv \overrightarrow{A'C'}$. Since $A \neq B$ and $B \neq C$ (we disregard the trivial cases where either $\overrightarrow{\mathbf{a}} = \overrightarrow{\mathbf{0}}$ or $\overrightarrow{\mathbf{b}} = \overrightarrow{\mathbf{0}}$ and where the result is obvious), by T 1.2.2 we have either $[ABC]$, or $[ACB]$, or $A = C$, or $[CAB]$. Suppose first $[ABC]$. Then by T 1.2.14 we have either $A \prec B \prec C$ or $C \prec B \prec A$. Assuming for definiteness the first option (the other option is handled automatically by the substitutions $A \leftrightarrow C$, $A' \leftrightarrow C'$) and using T 1.3.72, we can write $\overrightarrow{AB} \equiv \overrightarrow{A'B'} \& \overrightarrow{BC} \equiv \overrightarrow{B'C'} \& A \prec B \prec C \Rightarrow A' \prec B' \prec C' \xrightarrow{L1.2.13.6} A' \prec C'$. Also, $[A'B'C']$ from T 1.2.14, whence $[ABC] \& [A'B'C'] \& AB \equiv A'B' \& BC \equiv B'C' \xrightarrow{A1.3.3} AC \equiv A'C'$. Thus, we have $AC \equiv A'C'$ and either both $A \prec C$ and $A' \prec C'$, or $C \prec A$ and $C' \prec A'$, which means that $\overrightarrow{AC} \equiv \overrightarrow{A'C'}$. Suppose now that $[ACB]$. Then $A \prec C \prec B$ (see T 1.2.14). Using the fact that $\overrightarrow{AB} \equiv \overrightarrow{A'B'}$ and $\overrightarrow{BC} \equiv \overrightarrow{B'C'}$ and T 1.3.72, we can write $A' \prec B'$, $C' \prec B'$. Hence by C 1.2.14.2 the points A', C' are on the same side of B' . But $[ACB] \& C' \in B'A' \& AB \equiv A'B' \& BC \equiv B'C' \xrightarrow{L1.3.9.1} AC \equiv A'C' \& [A'C'B']$. Using T 1.2.14, we see again that either both $A \prec C$ and $A' \prec C'$, or $C \prec A$ and $C' \prec A'$. Suppose $A = C$. Then $\overrightarrow{AB} \equiv \overrightarrow{A'B'} \& \overrightarrow{BC} \equiv \overrightarrow{B'C'} \& C = A \prec B \xrightarrow{T1.3.72} A' \prec B' \& C' \prec B' \xrightarrow{C1.2.14.2} C' \in B'A'$. Hence $C' = B'$ by T 1.3.2. Finally, for $[CAB]$ the result is obtained immediately from the already considered case $[ACB]$ by the simultaneous substitutions $A \leftrightarrow C$, $A' \leftrightarrow C'$.

Theorem 1.3.73. *Addition of vectors on a line is commutative: $\overrightarrow{\mathbf{a}} + \overrightarrow{\mathbf{b}} = \overrightarrow{\mathbf{b}} + \overrightarrow{\mathbf{a}}$.*

Proof. Taking an ordered abstract interval $\overrightarrow{AB} \in \overrightarrow{\mathbf{a}}$ and laying off from B an ordered abstract interval $\overrightarrow{BC} \in \overrightarrow{\mathbf{b}}$, we see (from definition of addition of line vectors) that $\overrightarrow{AC} \in \overrightarrow{\mathbf{a}} + \overrightarrow{\mathbf{b}}$. Now laying off $\overrightarrow{CD} \in \overrightarrow{\mathbf{a}}$, we see that $\overrightarrow{BD} \in \overrightarrow{\mathbf{b}} + \overrightarrow{\mathbf{a}}$. Since the vector $\overrightarrow{\mathbf{a}}$ is an equivalence class of ordered abstract intervals, we have $\overrightarrow{AB} \equiv \overrightarrow{CD}$. If $A = C$, then using the preceding lemma (L 1.3.73.1) we see that also $B = D$, which implies that $\overrightarrow{\mathbf{a}} + \overrightarrow{\mathbf{b}} = \overrightarrow{\mathbf{b}} + \overrightarrow{\mathbf{a}} = \overrightarrow{\mathbf{0}}$. Suppose now $A \neq C$

⁵³³We usually assume the line a to be known and fixed and so do not include it in our notation for line vectors.

and, consequently, $B \neq D$. Then (from definition) both $AB \equiv CD$ and $AC \equiv BD$, which implies the equivalence of the ordered abstract intervals: $\overrightarrow{AB} \equiv \overrightarrow{CD}$ if and only if $\overrightarrow{AC} \equiv \overrightarrow{BD}$. But from our construction $\overrightarrow{AC} \in \overrightarrow{\mathbf{a}} + \overrightarrow{\mathbf{b}}$, $\overrightarrow{BD} \in \overrightarrow{\mathbf{b}} + \overrightarrow{\mathbf{a}}$, whence from definition of vector as a class of congruent intervals we have $\overrightarrow{\mathbf{a}} + \overrightarrow{\mathbf{b}} = \overrightarrow{\mathbf{b}} + \overrightarrow{\mathbf{a}}$, as required. \square

Theorem 1.3.74. *Addition of vectors on a line is associative: $(\overrightarrow{\mathbf{a}} + \overrightarrow{\mathbf{b}}) + \overrightarrow{\mathbf{c}} = \overrightarrow{\mathbf{a}} + (\overrightarrow{\mathbf{b}} + \overrightarrow{\mathbf{c}})$.*

Proof. Taking an ordered abstract interval $\overrightarrow{AB} \in \overrightarrow{\mathbf{a}}$, laying off from B an ordered abstract interval $\overrightarrow{BC} \in \overrightarrow{\mathbf{b}}$, and then laying off $\overrightarrow{CD} \in \overrightarrow{\mathbf{a}}$, we see that $\overrightarrow{AC} \in \overrightarrow{\mathbf{a}} + \overrightarrow{\mathbf{b}}$, $\overrightarrow{BD} \in \overrightarrow{\mathbf{b}} + \overrightarrow{\mathbf{c}}$. Therefore, $\overrightarrow{AD} \in (\overrightarrow{\mathbf{a}} + \overrightarrow{\mathbf{b}}) + \overrightarrow{\mathbf{c}}$, $\overrightarrow{AD} \in \overrightarrow{\mathbf{a}} + (\overrightarrow{\mathbf{b}} + \overrightarrow{\mathbf{c}})$, whence (recall that classes of equivalence either have no common elements or coincide) $(\overrightarrow{\mathbf{a}} + \overrightarrow{\mathbf{b}}) + \overrightarrow{\mathbf{c}} = \overrightarrow{\mathbf{a}} + (\overrightarrow{\mathbf{b}} + \overrightarrow{\mathbf{c}})$. \square

Now observe that for any vector $\overrightarrow{\mathbf{a}}$ there is, evidently, exactly one vector $\overrightarrow{\mathbf{b}}$ such that $\overrightarrow{\mathbf{a}} + \overrightarrow{\mathbf{b}} = \overrightarrow{\mathbf{b}} + \overrightarrow{\mathbf{a}} = \overrightarrow{\mathbf{O}}$. We shall denote this vector $-\overrightarrow{\mathbf{a}}$ and refer to it as the vector, opposite to $\overrightarrow{\mathbf{a}}$.

Note also that, given a representative \overrightarrow{AB} of a vector $\overrightarrow{\mathbf{a}}$, the vector $-\overrightarrow{\mathbf{a}}$ will be the class of ordered intervals equivalent to \overrightarrow{BA} .

We are now in a position to define the subtraction of arbitrary vectors $\overrightarrow{\mathbf{a}}$, $\overrightarrow{\mathbf{b}}$ as follows: $\overrightarrow{\mathbf{a}} - \overrightarrow{\mathbf{b}} \equiv \overrightarrow{\mathbf{a}} + (-\overrightarrow{\mathbf{b}})$.

We see that all vectors on a given line a form an abelian additive group.

Consider a line a and a vector $\overrightarrow{\mathbf{t}}$ on this line. We define the transformation $f = \text{transl}_{(a, \overrightarrow{\mathbf{t}})}$ of translation of the line a by the vector $\overrightarrow{\mathbf{t}}$ as follows: Take a point $A \in a$ and lay off the vector $\overrightarrow{\mathbf{t}}$ from it to obtain the ordered (abstract) interval $\overrightarrow{AB} \in \overrightarrow{\mathbf{t}}$. Then by definition the point B is the image of the point A under translation $\overrightarrow{\mathbf{t}}$. We write this as $B = \text{transl}_{(a, \overrightarrow{\mathbf{t}})}(A)$.

Theorem 1.3.75. *A translation by a vector $\overrightarrow{\mathbf{t}}$ (lying on a) is a bijective sense-preserving isometric transformation of the line a .*

Proof. Consider an arbitrary point $A \in a$. To establish surjectivity we have to find a point $B \in a$ such that $A = \text{transl}_{(a, \overrightarrow{\mathbf{t}})}(B)$. This is achieved by laying off the vector $-\overrightarrow{\mathbf{t}}$ from A to obtain the ordered interval \overrightarrow{AB} whose end B , obviously, has the property that $A = \text{transl}_{(a, \overrightarrow{\mathbf{t}})}(B)$.

Now consider two points $A, B \in a$. Denote $A' \equiv \text{transl}_{(a, \overrightarrow{\mathbf{t}})}(A)$, $B' \equiv \text{transl}_{(a, \overrightarrow{\mathbf{t}})}(B)$. Since both $\overrightarrow{AA'} \in \overrightarrow{\mathbf{t}}$, $\overrightarrow{BB'} \in \overrightarrow{\mathbf{t}}$, we have $\overrightarrow{AA'} \equiv \overrightarrow{BB'}$. But this is equivalent to $\overrightarrow{AB} \equiv \overrightarrow{A'B'}$, which, in turn, implies that $AB \equiv A'B'$ and either $(A \prec B) \& (A' \prec B')$, or $(B \prec A) \& (B' \prec A')$.⁵³⁴ Thus, we see that $\text{transl}_{(a, \overrightarrow{\mathbf{t}})}$ is isometric (preserves distances) and, in particular, it is injective (transforms different points into different points); furthermore, it preserves direction. \square

Theorem 1.3.76. *Any isometry on a line is either a translation or a reflection.*

Proof. We know from C 1.3.29.1 that any isometry f on a line a is either sense-preserving or sense reversing. Consider first the case where f is a sense-reversing transformation. Take an arbitrary point $A \in a$. Denote $A' \equiv \text{transl}_{(a, \overrightarrow{\mathbf{t}})}(A)$. We are going to show that the transformation f is in this case the reflection of the line a in the point O , where, by definition, O is the midpoint of the interval AA' .⁵³⁵ To achieve this, we need to check that for any point $B \in a$ distinct from A we have $BO \equiv OB'$, where $B' \equiv \text{transl}_{(a, \overrightarrow{\mathbf{t}})}(B)$. Of the two possible orders on a with O as origin we choose the one in which the ray O_A is the first.⁵³⁶

Suppose first that $B \prec A$ on a in this order. Then $A' \prec B'$ by assumption. Since A' lies on the second ray (on the opposite side of O from A), so does B' (otherwise we would have $B' \prec A'$). Furthermore, from the definition of order on a we have $[OA'B']$. Now we can write $[OAB] \& [OA'B'] \& OA \equiv OA' \& AB \equiv A'B' \xrightarrow{A1.3.3} OB \equiv OB'$.

Suppose now $A \prec B$. First assume that $B \in O_A$. Evidently, in this case the points O, B' lie on the same side of the point A' . (Otherwise we would have $[OA'B']$, whence $A' \prec B'$ in view of the definition of order on a , and we arrive at a contradiction with our assumption that order is reversed.) $[ABO] \& B' \in A'_O \& AO \equiv A'_O \& AB \equiv A'B' \xrightarrow{L1.3.9.1} OB \equiv OB'$.

Consider now the case $B \in O_A^c$, i.e. $[AOB]$. As above, we see that $B' \in A'_O$. In view of L 1.2.11.8 we must have either $[A'B'O]$, or $B' = O$, or $A'OB'$. But $[A'B'O] \xrightarrow{C1.3.13.4} A'B' \prec A'O$, $[AOB] \xrightarrow{C1.3.13.4} AO \prec AB$, $AO \prec AB \& AB \equiv A'B' \& A'B' \prec A'O' \Rightarrow AO \prec A'O'$ (see L 1.3.13.6 – L 1.3.13.8), which contradicts $AO \equiv A'O'$ (see L 1.3.13.11).

Thus, we see that in the case when the isometry on the line a reverses order, it is a reflection.

Finally, consider the case when the transformation is sense-preserving. Then for arbitrary points $A, B \in a$ we have $AB \equiv A'B'$ (isometry!) and either $(A \prec B) \& (A' \prec B')$ or $(B \prec A) \& (B' \prec A')$. But in view of T 1.3.71 this

⁵³⁴In other words, we can say that the vectors $\overrightarrow{AB}, \overrightarrow{A'B'}$ have equal magnitudes and the same direction.

⁵³⁵Of course, we take care to choose the point A in such a way that $A' \neq A$. This is always possible for a sense-reversing transformation.

⁵³⁶How we choose this order is purely a matter of convenience.

is equivalent to $\overrightarrow{AB} \equiv \overrightarrow{A'B'}$, which, in turn, is equivalent to $\overrightarrow{AA'} \equiv \overrightarrow{BB'}$. We see that our transformation in this case is the translation by the vector defined as the class of ordered intervals equivalent to $\overrightarrow{AA'}$.

□

1.4 Continuity, Measurement, and Coordinates

Axioms of Continuity

The continuity axioms allow us to put into correspondence

- With every interval a positive real number called the measure or length of the interval;
- With every point of an arbitrary line a real number called the coordinate of the point on the line;
- With every point of an arbitrary plane an ordered pair of numbers called the (plane) coordinates of the point;
- With every point of space an ordered triple of real numbers called spatial coordinates the point.

These correspondences enable us to study geometric objects by powerful analytical methods. This study forms the subject of analytical geometry.

Furthermore, from the continuity axioms, combined with the axioms listed in the preceding sections, it follows that the set \mathcal{P}_a of all points of an arbitrary line a has essentially the same topological properties as the ordered field \mathbb{R} . Consequently, the set \mathcal{P}_α of all points of an arbitrary plane has essentially the same topological properties as \mathbb{R}^2 (or \mathbb{C} , depending on the viewpoint), and the class of all points (of space) has essentially the same topological properties as \mathbb{R}^3 .

Axiom 1.4.1 (Archimedes Axiom). *Given a point P on a ray A_0A_1 , there is a positive integer n such that if $[A_{i-1}A_iA_{i+1}]$ for all $i \in \mathbb{N}_{n-1}$ and $A_0A_1 \equiv A_1A_2 \equiv \dots \equiv A_{n-1}A_n$ then $[A_0PA_n]$.*

By definition, a sequence of closed sets $\mathcal{X}_1, \mathcal{X}_2, \dots, \mathcal{X}_n, \dots$ is said to be nested if $\mathcal{X}_1 \supset \mathcal{X}_2 \supset \dots \supset \mathcal{X}_n \supset \dots$, i.e. if every set of the sequence contains the next. In particular, for a nested sequence of closed intervals $[A_1B_1], [A_2, B_2], \dots, [A_nB_n], \dots$ we have $[A_1B_1] \supset [A_2, B_2] \supset \dots \supset [A_nB_n] \supset \dots$

Axiom 1.4.2 (Cantor's Axiom). *Let $[E_iF_i]$, $i \in \{0\} \cup \mathbb{N}$ be a nested sequence of closed intervals with the property that given (in advance) an arbitrary interval B_1B_2 , there is a number $n \in \{0\} \cup \mathbb{N}$ such that the (abstract) interval E_nF_n is shorter than the interval B_1B_2 . Then there is at least one point B lying on all closed intervals $[E_0F_0], [E_1F_1], \dots, [E_nF_n], \dots$ of the sequence.*

The following lemma gives a more convenient formulation of the Archimedes axiom:

Lemma 1.4.1.1. *Given any two intervals A_0B, CD , there is a positive integer n such that if $[A_{i-1}A_iA_{i+1}]$ for all $i \in \mathbb{N}_{n-1}$ and $\forall i \in \mathbb{N}_n CD \equiv A_{i-1}A_i$ then $[A_0BA_n]$.⁵³⁷*

Proof. Using A 1.3.1, choose $A_1 \in A_0B$ such that $CD \equiv A_0A_1$. Then by L 1.2.11.3 $B \in A_0A_1$, and $\forall i \in \mathbb{N}_{n-1} [A_{i-1}A_iA_{i+1}]$ together with $CD \equiv A_0A_1 \equiv A_1A_2 \equiv \dots \equiv A_{n-1}A_n$ by A 1.4.1 implies $[A_0BA_n]$. □

It can be further refined as follows:

Lemma 1.4.1.2. *Given any two intervals A_0B, CD , there is a positive integer n such that if $[A_{i-1}A_iA_{i+1}]$ for all $i \in \mathbb{N}_{n-1}$ and $\forall i \in \mathbb{N}_n CD \equiv A_{i-1}A_i$ then $B \in [A_{n-1}A_n]$.⁵³⁸*

Proof. Let n be a minimal element of the set of natural numbers m such that if $[A_{i-1}A_iA_{i+1}]$ for all $i \in \mathbb{N}_{m-1}$ and $\forall i \in \mathbb{N}_m CD \equiv A_{i-1}A_i$ then $[A_0BA_m]$. (The set is not empty by the preceding lemma L 1.4.1.1.) By L 1.2.7.7 $\exists i \in \mathbb{N}_n B \in [A_{i-1}A_i]$. But $B \in [A_{i-1}A_i] \xrightarrow{L1.2.7.7} B \in [A_1A_i]$, so $i < n$ would contradict the minimality of n . Therefore, $i = n$ and $B \in [A_{i-1}A_i]$, q.e.d. □

Lemma 1.4.1.3. *Given any two intervals A_0B, CD , the interval A_0B can be divided into congruent intervals shorter than CD .*

Proof. Using L 1.3.21.11, L 1.4.1.1, find a positive integer n such that $\forall i \in \mathbb{N}_{n-1} [A_{i-1}A_iA_{i+1}]$, $\forall i \in \mathbb{N}_n CD \equiv A_{i-1}A_i$, and $[A_0BA_n]$. We have $[A_0BA_n] \xrightarrow{C1.3.13.4} A_0B < A_0A_n$. Hence, dividing (according to C 1.3.23.1) A_0B into 2^n congruent intervals and taking into account that $\forall n \in \mathbb{N} n < 2^n$, we obtain by C 1.3.21.10 intervals shorter than CD . □

⁵³⁷In other words, given any two intervals A_0B, CD , there is a positive integer n such that if the interval CD is laid off n times from the point A_0 on the ray A_0B , reaching the point A_n , then the point B divides A_0 and A_n .

⁵³⁸In other words, for any two intervals A_0B, CD , there is a natural number n such that if CD is laid off n times from the point A_0 on A_0B , reaching A_n , then the point B lies on the half - open interval $[A_{n-1}A_n)$.

Lemma 1.4.1.4. Let $[E_i F_i]$, $i \in \{0\} \cup \mathbb{N}$ be a nested sequence of closed intervals with the property that given (in advance) an arbitrary interval $B_1 B_2$, there is a number $n \in \{0\} \cup \mathbb{N}$ such that the (abstract) interval $E_n F_n$ is shorter than the interval $B_1 B_2$. Then there is at most one point B lying on all closed intervals $[E_0 F_0], [E_1 F_1], \dots, [E_n F_n], \dots$ of the sequence. ⁵³⁹

Proof. Suppose the contrary, i.e. let there be two points B_1, B_2 lying on the intervals $[E_0 F_0], [E_1 F_1], \dots, [E_n F_n], \dots$. Then, using C 1.3.13.4, we see that $\forall n \in \{0\} \cup \mathbb{N} B_1 B_2 \leq E_n F_n$. On the other hand, we have, by hypothesis $\exists n \in \{0\} \cup \mathbb{N} E_n F_n < B_1 B_2$. Thus, we arrive at a contradiction with L 1.3.13.10, L 1.3.13.11. \square

In this book we shall refer to the process whereby we put into correspondence with any interval its length as the measurement construction for the given interval.

We further assume that all intervals are measured against the interval CD , chosen and fixed once and for all. This "etalon" interval (and, for that matter, any interval congruent to it) will be referred to as the unit interval, and its measure (length) as the unit of measurement.

Given an interval $A_0 B$, its measurement construction consists of the following steps (countably infinite in number): ⁵⁴⁰

– Step 0: Using L 1.3.21.11, L 1.4.1.2, construct points $A_1, A_2, \dots, A_{n-1}, A_n$ such that $[A_{i-1} A_i A_{i+1}]$ for all $i \in \mathbb{N}_{n-1}$, $CD \equiv A_0 A_1 \equiv A_1 A_2 \equiv \dots \equiv A_{n-1} A_n$, and $B \in [A_{n-1} A_n]$. Denote $E_0 \equiv A_{n-1}$, $F_0 \equiv A_n$, $e_0 \equiv n-1$, $f_0 \equiv n$.

The other steps are defined inductively:

– Step 1: Denote C_1 the midpoint of $A_{n-1} A_n$, i.e. the point C_1 such that $[A_{n-1} C_1 A_n]$ and $A_{n-1} C_1 \equiv C_1 A_n$. By T 1.3.22 this point exists and is unique. Worded another way, the fact that C_1 is the midpoint of $A_{n-1} A_n$ means that the interval $D_{1,0} D_{1,2}$ is divided into two congruent intervals $D_{1,0} D_{1,1}$, $D_{1,1} D_{1,2}$, where we denote $D_{1,0} \equiv A_{n-1}$, $D_{1,1} \equiv C_1$, $D_{1,2} \equiv A_n$. ⁵⁴¹ We have $B \in [D_{1,0} D_{1,2}] \stackrel{L1.2.7.7}{\implies} B \in [D_{1,0} D_{1,1}] \vee B \in [D_{1,1} D_{1,2}]$. If $B \in [D_{1,0} D_{1,1}]$, we let, by definition $E_1 \equiv D_{1,0}$, $F_1 \equiv D_{1,1}$, $e_1 \equiv n-1$, $f_1 \equiv e_1 + \frac{1}{2} = n-1 + \frac{1}{2}$. For $B \in [D_{1,1} D_{1,2}]$, we denote $E_1 \equiv D_{1,1}$, $F_1 \equiv D_{1,2}$, $f_1 \equiv n$, $e_1 \equiv f_1 - \frac{1}{2} = n - \frac{1}{2}$. Obviously, in both cases we have the inclusions $[E_1 F_1] \subset [E_0 F_0]$ and $[e_1 f_1] \subset [e_0 f_0]$.

Step m:

As the result of the previous $m-1$ steps the interval $A_{n-1} A_n$ is divided into 2^{m-1} congruent intervals $D_{m-1,0} D_{m-1,1}, D_{m-1,1} D_{m-1,2}, \dots, D_{m-1,2^{m-1}-1} D_{m-1,2^{m-1}}$, where we let $D_{m-1,0} \equiv A_{n-1}$, $D_{m-1,2^{m-1}} \equiv A_n$. That is, we have $D_{m-1,0} D_{m-1,1} \equiv D_{m-1,1} D_{m-1,2} \equiv \dots \equiv D_{m-1,2^{m-1}-2} D_{m-1,2^{m-1}-1} \equiv D_{m-1,2^{m-1}-1} D_{m-1,2^{m-1}}$ and $[D_{m-1,j-1} D_{m-1,j} D_{m-1,j+1}]$, $j = 1, 2, \dots, 2^{m-1}-1$. We also know that $B \in [E_{m-1} F_{m-1}]$, $e_{m-1} = (n-1) + \frac{k-1}{2^{m-1}}$, $f_{m-1} = (n-1) + \frac{k}{2^{m-1}}$, where $E_{m-1} = D_{m-1,k-1}$, $F_{m-1} = D_{m-1,k}$, $k \in \mathbb{N}_{2^{m-1}}$. Dividing each of the intervals $D_{m-1,0} D_{m-1,1}, D_{m-1,1} D_{m-1,2}, \dots, D_{m-1,2^{m-1}-1} D_{m-1,2^{m-1}}$ into two congruent intervals ⁵⁴², we obtain by T 1.3.21 the division of $A_{n-1} A_n$ into $2^{m-1} \cdot 2 = 2^m$ congruent intervals $D_{m,0} D_{m,1}, D_{m,1} D_{m,2}, \dots, D_{m,2^m-1} D_{m,2^m}$, where we let $D_{m,0} \equiv A_{n-1}$, $D_{m,2^m} \equiv A_n$. That is, we have $D_{m,0} D_{m,1} \equiv D_{m,1} D_{m,2} \equiv \dots \equiv D_{m,2^m-2} D_{m,2^m-1} \equiv D_{m,2^m-1} D_{m,2^m}$ and $[D_{m,j-1} D_{m,j} D_{m,j+1}]$, $j = 1, 2, \dots, 2^m-1$. Furthermore, note that (see L 1.2.7.3) when $n > 1$ the points $A_0, \dots, A_{n-1} = D_{m,0}, D_{m,1}, \dots, D_{m,2^m-1}, A_n = D_{m,2^m}$ are in order $[A_0 \dots D_{m,0} D_{m,1} \dots D_{m,2^m-1} D_{m,2^m}]$. Denote $C_m \equiv \text{mid } E_{m-1} F_{m-1}$. By L 1.2.7.7 $B \in [E_{m-1} F_{m-1}] \implies [E_{m-1} C_m] \vee B \in [C_m F_{m-1}]$. In the former case we let, by definition, $E_m \equiv E_{m-1}$, $F_m \equiv C_m$, $e_m \equiv e_{m-1}$, $f_m \equiv e_m + \frac{1}{2^m}$; in the latter $E_m \equiv C_m$, $F_m \equiv F_{m-1}$, $e_m \equiv e_{m-1}$, $f_m \equiv f_{m-1} - \frac{1}{2^m}$. Obviously, we have in both cases $[E_m F_m] \subset [E_{m-1} F_{m-1}]$, $[e_m, f_m] \subset [e_{m-1}, f_{m-1}]$, $f_m - e_m = \frac{1}{2^m}$. Also, note that if $E_m = D_{m,l-1}$, $F_m = D_{m,l}$, $l \in \mathbb{N}_{2^m}$, then $e_m = (n-1) + \frac{l-1}{2^m}$, $f_m = (n-1) + \frac{l}{2^m}$. ⁵⁴³ Observe further that if $n-1 > 0$, concurrently with the m^{th} step of the measurement construction, we can divide each of the intervals $A_0 A_1, A_1 A_2, \dots, A_{n-2} A_{n-1}$ into 2^m intervals. Now, using T 1.3.21, we can conclude that the interval $A_0 E_m$, whenever it is defined, ⁵⁴⁴ turns out to be divided into $(n-1)2^m + l - 1$ congruent intervals, and the interval $A_0 F_m$ into $(n-1)2^m + l$ congruent intervals.

Continuing this process indefinitely (for all $m \in \mathbb{N}$), we conclude that either $\exists m_0 E_{m_0} = B$, and then, obviously, $\forall m \in \mathbb{N} \setminus \mathbb{N}_{m_0} E_m = B$; or $\forall m \in \mathbb{N} B \in (E_m F_m)$. In the first case we also have $\forall p \in \mathbb{N} e_{m_0+p} = e_{m_0}$, and we let, by definition, $|A_0 B| \equiv e_{m_0}$. In the second case we define $|A_0 B|$ to be the number lying on all the closed numerical

⁵³⁹Thus, we can now reformulate Cantor's Axiom A 1.4.2 in the following form: Let $[E_i F_i]$, $i \in \{0\} \cup \mathbb{N}$ be a nested sequence of closed intervals with the property that given (in advance) an arbitrary interval $B_1 B_2$, there is a number $n \in \{0\} \cup \mathbb{N}$ such that the (abstract) interval $E_n F_n$ is shorter than the interval $B_1 B_2$. Then there is exactly one point B lying on all closed intervals $[E_0 F_0], [E_1 F_1], \dots, [E_n F_n], \dots$ of the sequence. We can write this fact as $B = \bigcap_{i=0}^{\infty} [E_i F_i]$.

⁵⁴⁰The argumentation used in proofs in this section will appear to be somewhat more laconic than in the preceding ones. I believe that the reader who has reached this place in sequential study of the book does not need the material to be chewed excessively before being put into his mouth, as it tends to spoil the taste.

⁵⁴¹The first index here refers to the step of the measurement construction.

⁵⁴²In each case, such division is possible and unique due to T 1.3.22.

⁵⁴³In fact, after $m-1$ steps we have $B \in [D_{m-1,k-1} D_{m-1,k}] = [E_{m-1} F_{m-1}]$, and after m steps $B \in [D_{m-1,l-1} D_{m-1,l}] = [E_m F_m]$. First, consider the case $B \in [E_{m-1} C_m]$, where $C_m = \text{mid } E_{m-1} F_{m-1}$. Then, evidently, $l-1 = 2(k-1)$ and (see above) $e_m = e_{m-1}$, $f_m = e_m + 1/2^m$. Hence we have $e_m = e_{m-1} = (n-1) + (k-1)/2^{m-1} = (n-1) + 2(k-1)/2^m = (n-1) + (l-1)/2^m$, $f_m = (n-1) + (l-1)/2^m + 1/2^m = (n-1) + l/2^m$. Suppose now $B \in [C_m F_{m-1}]$. Then $l = 2k$ and $f_m = f_{m-1}$. Hence $f_m = f_{m-1} = (n-1) + k/2^{m-1} = (n-1) + 2k/2^m = (n-1) + l/2^m$, $e_m = (n-1) + l/2^m - 1/2^m = (n-1) + (l-1)/2^m$.

⁵⁴⁴The interval $A_0 E_m$ is defined when either $n > 1$ or $l > 1$.

intervals $[e_m, f_m]$, $m \in \mathbb{N}$. We can do so because the closed numerical intervals $[e_m, f_m]$, $m \in \mathbb{N}$, as well as the closed point intervals $[E_m F_m]$, form a nested sequence, where the difference $f_m - e_m = \frac{1}{2^m}$ can be made less than any given positive real number $\epsilon > 0$.⁵⁴⁵ Thus, we have proven

Theorem 1.4.1. *The measurement construction puts into correspondence with every interval AB a unique positive real number $|AB|$ called the length, or measure, of AB . A unit interval has length 1.*

Note than we can write

$$A_0B < \cdots \leq A_0F_m \leq A_0F_{m-1} \leq \cdots \leq A_0F_1 \leq A_0F_0. \quad (1.6)$$

and

$$e_0 \leq e_1 \leq \cdots \leq e_{m-1} \leq e_m \leq \cdots \leq |A_0B| < \cdots \leq f_m \leq f_{m-1} \leq \cdots \leq f_1 \leq f_0. \quad (1.7)$$

If $n > 1$, we also have

$$A_0E_0 \leq A_0E_1 \leq \cdots \leq A_0E_{m-1} \leq A_0E_m \leq \cdots \leq A_0B. \quad (1.8)$$

Some additional properties of the measurement construction are given by

Lemma 1.4.2.1. *Given an arbitrary interval GH , in the measurement construction for any interval A_0B there is an (appropriately defined) interval $E_m F_m$ shorter than GH .*

Proof. By L 1.4.1.3 the interval $A_{n-1}A_n$ (appropriately defined for the measurement construction in question) can be divided into some number m of congruent intervals shorter than GH . Since $m < 2^m$, dividing $A_{n-1}A_n$ into 2^m intervals at the m^{th} step of the measurement construction for A_0B gives by L 1.3.21.9 still shorter intervals. Hence the result. \square

This lemma shows that even if $n = 1$, for sufficiently large m the intervals $A_0E_m, A_0E_{m+1}, \dots$ are defined, i.e. $E_m \neq A_0$, etc., and we have⁵⁴⁶

$$A_0E_m \leq A_0E_{m+1} \leq \cdots \leq A_0B. \quad (1.9)$$

Lemma 1.4.2.2. *In the measurement process for an interval A_0B there can be no more than one point lying on all closed intervals $[E_0F_0], [E_1F_1], \dots, [E_nF_n], \dots$ defined appropriately for the measurement construction in question, and this point, when it exists, coincides with the point B .*

Proof. As is evident from our exposition of the measurement construction, the closed intervals $[E_0F_0], [E_1F_1], \dots, [E_nF_n], \dots$ form a nested sequence, i.e. we have $[E_1F_1] \supset [E_2, F_2] \supset \dots \supset [E_nF_n] \supset \dots$. The result then follows from L 1.4.2.1, L 1.4.1.4. \square

Theorem 1.4.2. *Congruent intervals have equal lengths.*⁵⁴⁷

Proof. Follows from C 1.3.21.14, L 1.3.21.12, L 1.3.21.13 applied to the measurement constructions of these intervals. In fact, let $A_0B \equiv A'_0B'$. On step 0, if $B \in [A_{n-1}A_n)$ then, by C 1.3.21.14, also $B' \in [A'_{n-1}A'_n)$, and therefore $e'_0 = e_0, f'_0 = f_0$.⁵⁴⁸ If $B \in [D_{1,0}D_{1,1})$ then (again by C 1.3.21.14) $B' \in [D'_{1,0}D'_{1,1})$, and if $B \in [D_{1,1}D_{1,2})$ then $B' \in [D'_{1,1}D'_{1,2})$. Therefore (see the exposition of measurement construction) $e'_1 = e_1, f'_1 = f_1$. Now assume inductively that after the $m - 1^{\text{th}}$ step of the measurement constructions the interval $A_{n-1}A_n$ is divided into 2^{m-1} congruent intervals $D_{m-1,0}D_{m-1,1}, D_{m-1,1}D_{m-1,2}, \dots, D_{m-1,2^{m-1}-1}D_{m-1,2^m-1}$ with $D_{m-1,0} = A_{n-1}, D_{m-1,2^m-1} = A_n$ and $A'_{n-1}A'_n$ is divided into 2^{m-1} congruent intervals $D'_{m-1,0}D'_{m-1,1}, D'_{m-1,1}D'_{m-1,2}, \dots, D'_{m-1,2^{m-1}-1}D'_{m-1,2^m-1}$ with $D'_{m-1,0} = A'_{n-1}, D'_{m-1,2^m-1} = A'_n$. Then we have (induction assumption implies here that we have the same k in both cases) $B \in [E_{m-1}F_{m-1})$, $e_{m-1} = (n-1) + \frac{k-1}{2^{m-1}}, f_{m-1} = (n-1) + \frac{k}{2^{m-1}}$, where $E_{m-1} = D_{m-1,k-1}, F_{m-1} = D_{m-1,k}$, $k \in \mathbb{N}_{2^{m-1}}$ and $B' \in [E'_{m-1}F'_{m-1})$, $e'_{m-1} = (n-1) + \frac{k-1}{2^{m-1}}, f'_{m-1} = (n-1) + \frac{k}{2^{m-1}}$, where $E'_{m-1} = D'_{m-1,k-1}, F'_{m-1} = D'_{m-1,k}$, $k \in \mathbb{N}_{2^{m-1}}$.

At the m^{th} step we divide each of the intervals $D_{m-1,0}D_{m-1,1}, D_{m-1,1}D_{m-1,2}, \dots, D_{m-1,2^{m-1}-1}D_{m-1,2^m-1}$ into two congruent intervals to obtain the division of $A_{n-1}A_n$ into 2^m congruent intervals $D_{m,0}D_{m,1}, D_{m,1}D_{m,2}, \dots, D_{m,2^{m-1}}D_{m,2^m}$, where, by definition, $D_{m,0} = A_{n-1}, D_{m,2^m} = A_n$. That is, we have $D_{m,0}D_{m,1} \equiv D_{m,1}D_{m,2} \equiv \dots \equiv D_{m,2^{m-2}}D_{m,2^{m-1}} \equiv D_{m,2^{m-1}}D_{m,2^m}$ and $[D_{m,j-1}D_{m,j}D_{m,j+1}]$, $j = 1, 2, \dots, 2^m - 1$.

⁵⁴⁵By the properties of real numbers, these conditions imply that the number lying on all closed numerical intervals $[e_m, f_m]$ exists and is unique.

⁵⁴⁶In fact, once $E_m F_m$ is shorter than A_0B , the point E_m cannot coincide with A_0 any longer. To demonstrate this, take the case $n = 1$ (if $n > 1$ we have the result as a particular case of the equation (1.7)) and consider the congruent intervals $D_{m,0}D_{m,1}, D_{m,1}D_{m,2}, \dots, D_{m,2^{m-1}}D_{m,2^m}$ into which the interval $A_0A_1 = A_0 = A_n$ is divided after m steps of the measurement construction. If B were to lie on the first of the division intervals, as it would be the case if $E_m = A_0$, we would have $B \in [D_{m,0}D_{m,1}) = [E_m F_m)$, whence (see C 1.3.13.4) $A_0B < E_m F_m$, contrary to our choice of m large enough for the inequality $E_m F_m < A_0B$ to hold.

⁵⁴⁷In particular, every unit interval has length 1.

⁵⁴⁸For the duration of this proof, all elements of the measurement construction for A'_0B' appear primed; for other notations, please refer to the exposition of the measurement construction.

Similarly, we divide each of the intervals $D'_{m-1,0}D'_{m-1,1}, D'_{m-1,0}D'_{m-1,1}, \dots, D'_{m-1,2^{m-1}-1}D'_{m-1,2^{m-1}}$ into two congruent intervals to obtain the division of $A'_{n-1}A'_n$ into 2^m congruent intervals $D'_{m,0}D'_{m,1}, D'_{m,1}D'_{m,2}, \dots, D'_{m,2^{m-1}-1}D'_{m,2^m}$, where $D'_{m,0} \equiv A'_{n-1}, D'_{m,2^m} \equiv A'_n$. That is, we have $D'_{m,0}D'_{m,1} \equiv D'_{m,1}D'_{m,2} \equiv \dots \equiv D'_{m,2^{m-1}-1}D'_{m,2^m} \equiv D'_{m,2^{m-1}-1}D'_{m,2^m}$ and $[D'_{m,j-1}D'_{m,j}, D'_{m,j+1}], j = 1, 2, \dots, 2^m - 1$.

Since the points $(A_0, \dots, A_{n-1}) = D_{m,0}, D_{m,1}, \dots, D_{m,2^m-1}, A_n = D_{m,2^m}$ ⁵⁴⁹ are in order $[(A_0 \dots)D_{m,0}D_{m,1} \dots D_{m,2^m-1}D_{m,2^m}]$ and the points $(A'_0, \dots, A'_{n-1}) = D'_{m,0}, D'_{m,1}, \dots, D'_{m,2^m-1}, A'_n = D'_{m,2^m}$ are in order $[(A'_0 \dots)D'_{m,0}D'_{m,1} \dots D'_{m,2^m-1}D'_{m,2^m}]$, if $B \in [E_m F_m] = [D_{m,l-1}D_{m,l}]$ then by C 1.3.21.14 $B' \in [E'_m F'_m] = [D'_{m,l-1}D'_{m,l}]$, and we have $e'_m = e_m = (n-1) + \frac{l-1}{2^m}, f'_m = f_m = (n-1) + \frac{l}{2^m}$. Furthermore, if $B = E_m$ then by L 1.3.21.13 also $B' = E'_m$ and in this case $|A_0 B| = e_m, |A'_0 B'| = e'_m$, whence $|A'_0 B'| = |A_0 B|$. On the other hand, if $\forall m \in \mathbb{N} B \in (E_m F_m)$, and, therefore (see L 1.3.21.12), $\forall m \in \mathbb{N} B' \in (E'_m F'_m)$, then both $\forall m \in \mathbb{N} |A_0 B| \in (e_m, f_m)$ and $\forall m \in \mathbb{N} |A'_0 B'| \in (e'_m, f'_m)$. But since, as we have shown, $e'_m = e_m, f'_m = f_m$, using the properties of real numbers, we again conclude that $|A'_0 B'| = |A_0 B|$. \square

Note that the theorem just proven shows that our measurement construction for intervals is completely well-defined. When applied to the identical intervals AB, BA , the procedure of measurement gives identical results.

Lemma 1.4.3.1. *Every interval, consisting of k congruent intervals resulting from division of a unit interval into 2^m congruent intervals, has length $k/2^m$.*

Proof. Given an interval $A_0 B$, consisting of k congruent intervals resulting from division of a unit interval into 2^m congruent intervals, at the m^{th} step of the measurement construction for $A_0 B$ we obtain the interval $A_0 E_m$ consisting of k intervals resulting from division of the unit interval into 2^m congruent intervals, and we have $A_0 E_m \equiv A_0 B$ (see L 1.2.21.6). Then by T 1.3.2 $E_m = B$. As explained in the text describing the measurement construction, in this case we have $k = (n-1)2^m + l - 1$. Hence $|A_0 B| = |A_0 E_m| = e_m = (n-1) + (l-1)/2^m = k/2^m$. \square

Theorem 1.4.3. *If an interval $A'B'$ is shorter than the interval $A_0 B$ then $|A'B'| < |A_0 B|$.*

Proof. Using L 1.3.13.3, find $B_1 \in (A_0 B)$ so that $A'B' \equiv A_0 B_1$. Consider the measurement construction of $A_0 B$, which, as will become clear in the process of the proof, induces the measurement construction for $A_0 B_1$. Suppose $B \in [A_{n-1} A_n], n \in \mathbb{N}$. Then by L 1.2.9.4 $B_1 \in [A_{k-1} A_k], k \leq n, k \in \mathbb{N}$. Agreeing to supply (whenever it is necessary to avoid confusion) the numbers (and sometimes points) related to the measurement constructions for $A_0 B, A_0 B_1$ with superscript indices $(B), (B_1)$, respectively, from 1.7 we can write for the case $k < n$: $e_0^{(B_1)} \leq |A_0 B_1| < f_0^{(B_1)} \leq e_0^{(B)} \leq |A_0 B| < f_0^{(B)}$, whence $|A_0 B_1| < |A_0 B|$. Suppose now $k = n$. Let there be a step number m in the measurement process for $A_0 B$ such that when after the $m-1^{\text{th}}$ step of the measurement construction the interval $A_{n-1} A_n$ is divided into 2^{m-1} congruent intervals $D_{m-1,0}D_{m-1,1}, D_{m-1,1}D_{m-1,2}, \dots, D_{m-1,2^{m-1}-1}D_{m-1,2^m}$ with $D_{m-1,0} = A_{n-1}, D_{m-1,2^m} = A_n$ and both B_1 and B lie on the same half-open interval $[D'_{m-1,p-1}D'_{m-1,p}], p \in \mathbb{N}_{2^{m-1}}$, at the m^{th} step B_1, B lie on different half-open intervals $[D'_{m,l-2}D'_{m,l-1}], [D'_{m,l-1}D'_{m,l}]$, where $l \in \mathbb{N}_{2^m}$, resulting from the division of the interval $D'_{m-1,p-1}D'_{m-1,p}$ into two congruent intervals $D'_{m,l-2}D'_{m,l-1}, D'_{m,l-1}D'_{m,l}$.⁵⁵⁰ Then, using 1.7, we have $|A_0 B_1| < f_m^{(B_1)} = (n-1) + \frac{l-1}{2^m} = e_m^{(B)} \leq |A_0 B|$, whence $|A_0 B_1| < |A_0 B|$. Finally, consider the case when for all $m \in \mathbb{N}$ the points B_1, B lie on the same half-open interval $[E_m F_m]$, where $E_m = E_m^{(B_1)} = E_m^{(B)}, F_m = F_m^{(B_1)} = F_m^{(B)}$. By L 1.4.2.2 B_1, B cannot lie both at once on all closed intervals $[E_0 F_0], [E_1 F_1], \dots, [E_n F_n], \dots$. Therefore, by L 1.2.9.4, we are left with $B_1 = E_m, B \in (E_m F_m)$ for some m as the only remaining option. In this case we have, obviously, $|A_0 B_1| = e_m < |A_0 B|$. \square

Corollary 1.4.3.2. *If $|A'B'| = |AB|$ then $A'B' \equiv AB$.*

Proof. See L 1.3.13.14, T 1.4.3. \square

Corollary 1.4.3.3. *If $|A'B'| < |AB|$ then $A'B' < AB$.*

Proof. See L 1.3.13.14, T 1.4.2, T 1.4.3. \square

Theorem 1.4.4. *If a point B lies between A and C , then $|AB| + |BC| = |AC|$*

Proof. After the m^{th} step of the measurement construction for the interval BC we find that the point C lies on the half-open interval $[E_m^{(C)}, F_m^{(C)})$, where the intervals $BE_m^{(C)}, BF_m^{(C)}$ consist, respectively, of some numbers $k \in \mathbb{N}, k+1$ of congruent intervals resulting from division of a unit interval into 2^m congruent intervals, and, consequently, have lengths $k/2^m, (k+1)/2^m$.⁵⁵¹ Hence, using (1.6, 1.9) and applying the preceding theorem (T 1.4.3), we can write the following inequalities:

$$k/2^m \leq |BC| < (k+1)/2^m. \quad (1.10)$$

⁵⁴⁹The expression in parentheses in this paragraph pertain to the case $n > 1$.

⁵⁵⁰The fact that $B_1 \in [D'_{m,l-2}D'_{m,l-1}]$ and $B \in [D'_{m,l-1}D'_{m,l}]$ and not the other way round, follows from L 1.2.9.4.

⁵⁵¹We take m large enough for the points $B, E_m^{(C)}$ to be distinct and thus for the interval $BE_m^{(C)}$ to make sense. (See the discussion accompanying the equation (1.9).)

(The superscripts A, C are being employed here to signify that we are using elements of the measurement constructions for the intervals BA and BC , respectively.) Similarly, after the m^{th} step of the measurement construction for the interval BA the point A lies on $[E_m^{(A)}, F_m^{(A)}]$, where the intervals $BE_m^{(A)}, BF_m^{(A)}$ consist, respectively, of $l, l + 1$ congruent intervals resulting from division of a unit interval into 2^m congruent intervals, and have lengths $l/2^m, (l + 1)/2^m$.⁵⁵² Again, using (1.6), (1.9) and applying the preceding theorem (T 1.4.3), we can write:

$$l/2^m \leq |BA| < (l + 1)/2^m. \quad (1.11)$$

Since, from the properties of the measurement constructions, the points $E_m^{(A)}, A, F_m^{(A)}$ all lie on the same side of the point B , the points $E_m^{(C)}, C, F_m^{(C)}$ lie on the same side of B ,⁵⁵³ and, by hypothesis, the point B lies between A, C , it follows that B also lies between $F_m^{(A)}, E_m^{(C)}$, as well as between $E_m^{(A)}, F_m^{(C)}$, i.e., we have $[F_m^{(A)}BE_m^{(C)}]$ and $[E_m^{(A)}F_m^{(C)}]$. Furthermore, by T 1.3.21 the interval $F_m^{(A)}E_m^{(C)}$ then consists of $l + k$ intervals resulting from division of a unit interval into 2^m congruent intervals, and the interval $E_m^{(A)}F_m^{(C)}$ then consists of $(l + 1) + (k + 1)$ of such intervals. By L 1.4.3.1 this implies $|F_m^{(A)}E_m^{(C)}| = (k + l)/2^m, |E_m^{(A)}F_m^{(C)}| = (k + l + 2)/2^m$. From the properties of the measurement constructions for the intervals BA, BC and the lemmas L 1.2.9.5, L 1.2.9.6 it follows that the points A, C both lie on the closed interval $[E_m^{(A)}F_m^{(C)}]$ and the points $F_m^{(A)}, E_m^{(C)}$ both lie on the closed interval $[AC]$. By C 1.3.13.4 these facts imply $F_m^{(A)}E_m^{(C)} \leq AC \leq E_m^{(A)}F_m^{(C)}$, whence we obtain (we can use T 1.4.3 to convince ourselves of this)

$$(k + l)/2^m = |F_m^{(A)}E_m^{(C)}| \leq |AC| < |E_m^{(A)}F_m^{(C)}| = (k + l + 2)/2^m. \quad (1.12)$$

On the other hand, adding together the inequalities (1.10), (1.11) gives

$$(k + l)/2^m = |F_m^{(A)}E_m^{(C)}| \leq |AB| + |BC| < |E_m^{(A)}F_m^{(C)}| = (k + l + 2)/2^m. \quad (1.13)$$

Subtracting (1.13) from (1.12), we get

$$||AB| + |BC| - |AC|| < 2/2^m = 1/2^{m-1}. \quad (1.14)$$

Finally, taking the limit $m \rightarrow \infty$ in (1.14), we obtain $|AB| + |BC| - |AC| = 0$, as required. \square

Corollary 1.4.4.1. *If a class μAB of congruent intervals is the sum of classes of congruent intervals $\mu CD, \mu EF$ (i.e. if $\mu AB = \mu CD + \mu EF$), then for any intervals $A_1B_1 \in \mu AB, C_1D_1 \in \mu CD, E_1F_1 \in \mu EF$ we have $|A_1B_1| = |C_1D_1| + |E_1F_1|$.*

Proof. See T 1.4.2, T 1.4.4. \square

Corollary 1.4.4.2. *If a class μAB of congruent intervals is the sum of classes of congruent intervals $\mu A_1B_1, \mu A_2B_2, \dots, \mu A_nB_n$ (i.e. if $\mu AB = \mu A_1B_1 + \mu A_2B_2 + \dots + \mu A_nB_n$), then for any intervals $CD \in \mu AB, C_1D_1 \in \mu A_1B_1, C_2D_2 \in \mu A_2B_2, \dots, C_nD_n \in \mu A_nB_n$ we have $|CD| = |C_1D_1| + |C_2D_2| + \dots + |C_nD_n|$. In particular, if $\mu AB = n\mu A_1B_1$ and $CD \in \mu AB, C_1D_1 \in \mu A_1B_1$, then $|CD| = n|C_1D_1|$.⁵⁵⁴*

Theorem 1.4.5. *For any positive real number x there is an interval (and, in fact, an infinity of intervals congruent to it) whose length equals to x .*

Proof. The construction of the required interval consists of the following steps (countably infinite in number):⁵⁵⁵ – Step 0: By the Archimedes axiom applied to \mathbb{R} there is a number $n \in \mathbb{N}$ such that $n - 1 \leq x < n$.

Starting with the point A_0 and using L 1.3.21.11, construct points $A_1, A_2, \dots, A_{n-1}, A_n$ such that $[A_{i-1}A_iA_{i+1}]$ for all $i \in \mathbb{N}_{n-1}, CD \equiv A_0A_1 \equiv A_1A_2 \equiv \dots \equiv A_{n-1}A_n$. Denote $E_0 \equiv A_{n-1}, F_0 \equiv A_n, e_0 \equiv n - 1, f_0 \equiv n$.

The other steps are defined inductively:

– Step 1: Denote C_1 the midpoint of $A_{n-1}A_n$, i.e. the point C_1 such that $[A_{n-1}C_1A_n]$ and $A_{n-1}C_1 \equiv C_1A_n$. By T 1.3.22 this point exists and is unique. Worded another way, the fact that C_1 is the midpoint of $A_{n-1}A_n$ means that the interval $D_{1,0}D_{1,2}$ is divided into two congruent intervals $D_{1,0}D_{1,1}, D_{1,1}D_{1,2}$, where we denote $D_{1,0} \equiv A_{n-1}, D_{1,1} \equiv C_1, D_{1,2} \equiv A_n$.⁵⁵⁶ If $x \in [n - 1, n - \frac{1}{2})$, i.e. for $n - 1 \leq x < n - \frac{1}{2}$, we let, by definition $E_1 \equiv D_{1,0}, F_1 \equiv D_{1,1}, e_1 \equiv n - 1, f_1 \equiv e_1 + \frac{1}{2} = n - 1 + \frac{1}{2}$. For $x \in [n - \frac{1}{2}, n)$, we denote $E_1 \equiv D_{1,1}, F_1 \equiv D_{1,2}, f_1 \equiv n, e_1 \equiv f_1 - \frac{1}{2} = n - \frac{1}{2}$. Obviously, in both cases we have the inclusions $[E_1F_1] \subset [E_0F_0]$ and $[e_1, f_1] \subset [e_0, f_0]$.

.....
Step m:

⁵⁵²We take m large enough for the points $B, E_m^{(A)}$ to be distinct and thus for the interval $BE_m^{(A)}$ to make sense. (See the discussion accompanying the equation (1.9).)

⁵⁵³Obviously, as we shall explain shortly, the points $E_m^{(C)}, C, F_m^{(C)}$ lie on the opposite side (i.e. ray) of the point B from the points $E_m^{(A)}, A, F_m^{(A)}$.

⁵⁵⁴Obviously, $\mu AB = (1/n)\mu A_1B_1$ and $CD \in \mu AB, C_1D_1 \in \mu A_1B_1$ then imply $|CD| = (1/n)|C_1D_1|$.

⁵⁵⁵We will construct an interval A_0B with $|A_0B| = x$ in a way very similar to its measurement construction. In fact, we'll just make the measurement construction go in reverse direction - from numbers to intervals, repeating basically the same steps

⁵⁵⁶Again, the first index here refers to the step of the measurement construction.

As the result of the previous $m - 1$ steps the interval $A_{n-1}A_n$ is divided into 2^{m-1} congruent intervals $D_{m-1,0}D_{m-1,1}, D_{m-1,1}D_{m-1,2}, \dots, D_{m-1,2^{m-1}-1}D_{m-1,2^m-1}$, where we let $D_{m-1,0} \hat{=} A_{n-1}$, $D_{m-1,2^m-1} \hat{=} A_n$. That is, we have $D_{m-1,0}D_{m-1,1} \equiv D_{m-1,1}D_{m-1,2} \equiv \dots \equiv D_{m-1,2^{m-1}-2}D_{m-1,2^{m-1}-1} \equiv D_{m-1,2^{m-1}-1}D_{m-1,2^m-1}$ and $[D_{m-1,j-1}D_{m-1,j}D_{m-1,j+1}]$, $j = 1, 2, \dots, 2^{m-1} - 1$. We also know that $x \in [e_{m-1}, f_{m-1})$, $e_{m-1} = (n-1) + \frac{k-1}{2^{m-1}}$, $f_{m-1} = (n-1) + \frac{k}{2^{m-1}}$, where $E_{m-1} = D_{m-1,k-1}$, $F_{m-1} = D_{m-1,k}$, $k \in \mathbb{N}_{2^{m-1}}$. Dividing each of the intervals $D_{m-1,0}D_{m-1,1}, D_{m-1,1}D_{m-1,2}, \dots, D_{m-1,2^{m-1}-1}D_{m-1,2^m-1}$ into two congruent intervals⁵⁵⁷, we obtain by T 1.3.21 the division of $A_{n-1}A_n$ into $2^{m-1} \cdot 2 = 2^m$ congruent intervals $D_{m,0}D_{m,1}, D_{m,1}D_{m,2}, \dots, D_{m,2^m-1}D_{m,2^m}$, where we let $D_{m,0} \hat{=} A_{n-1}$, $D_{m,2^m} \hat{=} A_n$. That is, we have $D_{m,0}D_{m,1} \equiv D_{m,1}D_{m,2} \equiv \dots \equiv D_{m,2^m-2}D_{m,2^m-1} \equiv D_{m,2^m-1}D_{m,2^m}$ and $[D_{m,j-1}D_{m,j}D_{m,j+1}]$, $j = 1, 2, \dots, 2^m - 1$. Furthermore, note that (see L 1.2.7.3) when $n > 1$ the points $A_0, \dots, A_{n-1} = D_{m,0}, D_{m,1}, \dots, D_{m,2^m-1}$, $A_n = D_{m,2^m}$ are in order $[A_0 \dots D_{m,0}D_{m,1} \dots D_{m,2^m-1}D_{m,2^m}]$. From the properties of real numbers it follows that either $x \in [e_{m-1}, (e_{m-1} + f_{m-1})/2)$ or $x \in [(e_{m-1} + f_{m-1})/2, f_{m-1})$. In the former case we let, by definition, $E_m \hat{=} E_{m-1}$, $F_m \hat{=} C_m$, $e_m \hat{=} e_{m-1}$, $f_m \hat{=} e_m + \frac{1}{2^m}$; in the latter $E_m \hat{=} C_m$, $F_m \hat{=} F_{m-1}$, $e_m \hat{=} e_{m-1}$, $f_m \hat{=} f_{m-1} - \frac{1}{2^m}$. Obviously, we have in both cases $(E_m F_m) \subset (E_{m-1} F_{m-1})$, $(e_m f_m) \subset (e_{m-1} f_{m-1})$, $f_m - e_m = \frac{1}{2^m}$.

Continuing this process indefinitely (for all $m \in \mathbb{N}$), we conclude that either $\exists m_0 e_{m_0} = x$, and then, obviously, $\forall m \in \mathbb{N} \setminus \mathbb{N}_{m_0} e_m = x$; or $\forall m \in \mathbb{N} x \in (e_m, f_m)$. In the first case we let, by definition, $B \hat{=} E_{m_0}$.

In the second case we define B to be the (unique) point lying on all the closed intervals $[E_m F_m]$, $m \in \mathbb{N}$. We can do this by the Cantor's axiom A 1.4.2 because the closed point intervals $[E_m F_m]$ form a nested sequence, where by L 1.4.2.1 the interval $E_m F_m$ can be made shorter than any given interval.

Since from our construction it is obvious that the number x is the result of measurement construction applied to the interval $A_0 B$, we can write $|A_0 B| = x$, as required. \square

Having established that any interval can be measured, we can proceed to associate with every point on any given line a unique real number called the coordinate of the point on that line.

Toward this end, consider an arbitrary line a . Let $O \in a$, $P \in a$, $[POQ]$. We refer to the point O as the origin, and the rays OP , OQ as the first and the second rays, respectively. The line coordinate x_M of an arbitrary point $M \in a$ is then defined as follows. If $M = O$, we let, by definition, $x_M \hat{=} 0$. If the point M lies on the first ray OP , we define $x_M \hat{=} -|OM|$. Finally, in the case $M \in OQ$, we let $x_M \hat{=} |OM|$.⁵⁵⁸ The number x_M is called the coordinate of the point M on the line a . From our construction it follows that for any point on any given line this number exists and is unique.

We can state the following:

Theorem 1.4.6. *If a point A precedes a point B in the direct order defined on a line a , the coordinate x_A of the point A is less than the coordinate x_B of the point B .*

Proof. If A precedes B in the direct order on a then⁵⁵⁹

- Both A and B lie on the first ray and B precedes A on it; or
- A lies on the first ray, and B lies on the second ray or coincides with O ; or
- $A = O$ and B lies on the second ray; or
- Both A and B lie on the second ray, and A precedes B on it.

If $(B \prec A)_{OP}$, then by the definition of order on the ray OP (see p. 21) the point B lies between points O and A , and we can write $[OBA] \xrightarrow{C1.3.13.4} OB < OA \xrightarrow{T1.4.3} |OB| < |OA| \Rightarrow -x_B < -x_A \Rightarrow x_A < x_B$.

For the other three cases we have:

$$A \in OP \ \& \ (B = O \vee B \in OQ) \Rightarrow x_A = -|OA| \ \& \ (x_B = 0 \vee x_B = |OB|) \Rightarrow x_A < 0 \leq x_B;$$

$$A = O \ \& \ B \in OQ \Rightarrow x_A = 0 < |OB| = x_B;$$

$$(A \prec B)_{OQ} \Rightarrow [OAB] \xrightarrow{C1.3.13.4} OA < OB \xrightarrow{T1.4.3} |OA| < |OB| \Rightarrow x_A < x_B. \quad \square$$

Theorem 1.4.7. *There is a bijective correspondence between the set \mathcal{P}_a of (all) points of an arbitrary line a and the set \mathbb{R} of (all) real numbers.*

Proof. The correspondence is injective. In fact, suppose $A, B \in a$, $A \neq B$. We have $A \in a \ \& \ B \in a \ \& \ A \neq B \xrightarrow{L1.2.13.5} (A \prec B)_a \vee (B \prec A)_a \xrightarrow{T1.4.6} x_A < x_B \vee x_B < x_A \Rightarrow x_A \neq x_B$.

The surjectivity follows from T 1.4.5. \square

We are now in a position to introduce plane coordinates, i.e. associate with every point on a given plane an ordered pair of real numbers.

Let α be a given plane. Taking a line a_1 lying in this plane, construct another line $a_2 \subset \alpha$ such that $a_2 \perp a_1$. Denote $O \hat{=} a_1 \cap a_2$ (that is, O is the point where the lines a_1 , a_2 concur) and call the point O the origin of the coordinate system. We shall refer to the line a_1 as the horizontal axis, the x - axis, or the abscissa line of the coordinate system, and the line a_2 as the vertical axis, the y - axis, or the ordinate line.

⁵⁵⁷In each case, such division is possible and unique due to T 1.3.22.

⁵⁵⁸Recall that $\mathcal{P}_a = O_P \cup \{O\} \cup O_Q$, the union being disjoint.

⁵⁵⁹See definition on p. 22.

Theorem 1.4.8. *There is a bijective correspondence between the set \mathcal{P}_α of (all) points of an arbitrary plane α and the set \mathbb{R}^2 of (all) ordered pairs of real numbers.*

Proof. \square

Theorem 1.4.9. *Proof.* \square

Theorem 1.4.10. *Proof.* \square

Angles and even dihedral angles have continuity properties partly analogous to those of intervals. Before we demonstrate this, however, it is convenient to put our concept of continuity into a broader perspective.

Consider a set \mathfrak{J} , equipped with a relation of generalized congruence (see p. 46). By definition, the elements of \mathfrak{J} possess the properties Pr 1.3.1 – Pr 1.3.5. Recall that the elements of \mathfrak{J} are pairs $\mathcal{AB} \rightleftharpoons \{\mathcal{A}, \mathcal{B}\}$ (called generalized abstract intervals) of geometric objects. Each such pair \mathcal{AB} lies in (i.e. is a subset in at least) one of the sets \mathfrak{J} equipped with a generalized betweenness relation. The sets \mathfrak{J} are, in their turn, elements of some special class \mathcal{C}^{gbr} of sets with generalized betweenness relation, such as the class of all lines, the class of all pencils of rays lying on the same side of a given line, the class of all pencils of half-planes lying on the same side of a given plane, etc.

We are now in a position to define a measurement construction for elements of such a set \mathfrak{J} whose class \mathcal{C}^{gbr} consists of *specialy chosen* sets \mathfrak{J} with generalized *angular* betweenness relation.⁵⁶⁰

We shall assume that the sets \mathfrak{J} with generalized angular betweenness relation in \mathcal{C}^{gbr} are chosen in such a way that the generalized abstract intervals formed by their ends are congruent: if $\mathfrak{J} = [\mathcal{AB}] \in \mathcal{C}^{gbr}$, $\mathfrak{J}' = [\mathcal{A}'\mathcal{B}'] \in \mathcal{C}^{gbr}$ then $\mathcal{AB} \equiv \mathcal{A}'\mathcal{B}'$.

We shall further assume that the generalized abstract intervals involved (elements of the set \mathfrak{J}) have the following property:

Property 1.4.1. *Given any two generalized intervals \mathcal{AB} , \mathcal{CD} , the generalized interval \mathcal{AB} can be divided into congruent generalized intervals shorter than \mathcal{CD} .*

as well as the following generalized Cantor property:

Property 1.4.2 (Generalized Cantor's Axiom). *Let $[\mathcal{E}_i\mathcal{F}_i]$, $i \in \{0\} \cup \mathbb{N}$ be a nested sequence⁵⁶¹ of generalized closed intervals with the property that given (in advance) an arbitrary generalized interval $\mathcal{B}_1\mathcal{B}_2$, there is a number $n \in \{0\} \cup \mathbb{N}$ such that the (abstract) generalized interval $\mathcal{E}_n\mathcal{F}_n$ is shorter than the generalized interval $\mathcal{B}_1\mathcal{B}_2$. Then there is at least one geometric object \mathcal{B} lying on all closed intervals $[\mathcal{E}_0\mathcal{F}_0], [\mathcal{E}_1\mathcal{F}_1], \dots, [\mathcal{E}_n\mathcal{F}_n], \dots$ of the sequence.*

which we can reformulate in the following stronger form:

Lemma 1.4.11.1. *Let $[\mathcal{E}_i\mathcal{F}_i]$, $i \in \{0\} \cup \mathbb{N}$ be a nested sequence of generalized closed intervals with the property that given (in advance) an arbitrary generalized interval $\mathcal{B}_1\mathcal{B}_2$, there is a number $n \in \{0\} \cup \mathbb{N}$ such that the generalized (abstract) interval $\mathcal{E}_n\mathcal{F}_n$ is less than the generalized interval $\mathcal{B}_1\mathcal{B}_2$. Then there is at most one geometric object \mathcal{B} lying on all generalized closed intervals $[\mathcal{E}_0\mathcal{F}_0], [\mathcal{E}_1\mathcal{F}_1], \dots, [\mathcal{E}_n\mathcal{F}_n], \dots$ of the sequence.⁵⁶²*

Proof. Suppose the contrary, i.e. let there be two geometric objects $\mathcal{B}_1, \mathcal{B}_2$ lying on the generalized closed intervals $[\mathcal{E}_0\mathcal{F}_0], [\mathcal{E}_1\mathcal{F}_1], \dots, [\mathcal{E}_n\mathcal{F}_n], \dots$. Then by C 1.3.15.4 $\forall n \in \{0\} \cup \mathbb{N} \mathcal{B}_1\mathcal{B}_2 < \mathcal{E}_n\mathcal{F}_n$. On the other hand, we have, by hypothesis $\exists n \in \{0\} \cup \mathbb{N} \mathcal{E}_n\mathcal{F}_n < \mathcal{B}_1\mathcal{B}_2$. Thus, we arrive at a contradiction with L 1.3.15.10. \square

Now, given a set $\mathfrak{J} = [\mathcal{AB}]$ with angular generalized betweenness relation, of the kind just defined, we can construct the measurement construction for any interval of the form \mathcal{AP} ,⁵⁶³ where $\mathcal{P} \in \mathfrak{J}$, as follows:

We set, by definition, the measure of the generalized interval $\mathcal{AB} \in \mathfrak{J}$, as well as of all generalized intervals $\mathcal{A}'\mathcal{B}'$ congruent to it,⁵⁶⁴ equal to a positive real number b . For example, in practice of angle measurement b can be equal to π (radian) or 180 (degrees). We denote the measure of \mathcal{AB} by *mes* \mathcal{AB} or $|\mathcal{AB}|$.

– Step 0: Denote $\mathcal{A}_0 \rightleftharpoons \mathcal{A}$, $\mathcal{B}_0 \rightleftharpoons \mathcal{B}$, $a_0 \rightleftharpoons 0$, $b_0 \rightleftharpoons b$.

The other steps are defined inductively:

– Step 1: Denote \mathcal{C}_1 the middle of \mathcal{AB} , i.e. the geometric object \mathcal{C}_1 such that $[\mathcal{AC}_1\mathcal{B}]$ and $\mathcal{AC}_1 \equiv \mathcal{C}_1\mathcal{B}$. By Pr 1.3.5 this point exists and is unique. Worded another way, the fact that \mathcal{C}_1 is the middle of \mathcal{AB} means that the generalized interval $\mathcal{D}_{1,0}\mathcal{D}_{1,2}$ is divided into two congruent intervals $\mathcal{D}_{1,0}\mathcal{D}_{1,1}$, $\mathcal{D}_{1,1}\mathcal{D}_{1,2}$, where we denote $\mathcal{D}_{1,0} \rightleftharpoons \mathcal{A}$, $\mathcal{D}_{1,1} \rightleftharpoons \mathcal{C}_1$,

⁵⁶⁰See p. 48. Similarly, the measurement construction given above for intervals could have been easily generalized to the general case of a set \mathfrak{J} whose class \mathcal{C}^{gbr} consists of sets \mathfrak{J} with generalized *linear* betweenness relation if we additionally require the following generalized Archimedean property: Given a geometric object \mathcal{P} on a generalized ray $\mathcal{A}_0\mathcal{A}_1$, there is a positive integer n such that if $[\mathcal{A}_{i-1}\mathcal{A}_i\mathcal{A}_{i+1}]$ for all $i \in \mathbb{N}_{n-1}$ and $\mathcal{A}_0\mathcal{A}_1 \equiv \mathcal{A}_1\mathcal{A}_2 \equiv \dots \equiv \mathcal{A}_{n-1}\mathcal{A}_n$ then $[\mathcal{A}_0\mathcal{P}\mathcal{A}_n]$. However, all conceivable examples of the sets \mathfrak{J} of this kind seem too contrived to merit a separate procedure of measurement.

⁵⁶¹In accordance with the general definition, a sequence of generalized closed intervals $[\mathcal{A}_1\mathcal{B}_1], [\mathcal{A}_2\mathcal{B}_2], \dots, [\mathcal{A}_n\mathcal{B}_n], \dots$ is said to be nested if $[\mathcal{A}_1\mathcal{B}_1] \supset [\mathcal{A}_2\mathcal{B}_2] \supset \dots \supset [\mathcal{A}_n\mathcal{B}_n] \supset \dots$

⁵⁶²Thus, we can now reformulate the Generalized Cantor's Axiom Pr 1.4.2 in the following form: Let $[\mathcal{E}_i\mathcal{F}_i]$, $i \in \{0\} \cup \mathbb{N}$ be a nested sequence of generalized closed intervals with the property that given (in advance) an arbitrary generalized interval $\mathcal{B}_1\mathcal{B}_2$, there is a number $n \in \{0\} \cup \mathbb{N}$ such that the generalized (abstract) interval $\mathcal{E}_n\mathcal{F}_n$ is shorter than the generalized interval $\mathcal{B}_1\mathcal{B}_2$. Then there is exactly one geometric object \mathcal{B} lying on all generalized closed intervals $[\mathcal{E}_0\mathcal{F}_0], [\mathcal{E}_1\mathcal{F}_1], \dots, [\mathcal{E}_n\mathcal{F}_n], \dots$ of the sequence.

⁵⁶³Given the properties of angles and dihedral angles, even after restriction to the intervals of this form, our consideration is sufficient for all practical purposes.

⁵⁶⁴Generalized intervals \mathcal{AB} such that $[\mathcal{AB}] = \mathfrak{J} \in \mathcal{C}^{gbr}$ can sometimes for convenience be referred to as reference generalized intervals.

$\mathcal{D}_{1,2} \rightleftharpoons \mathcal{B}$.⁵⁶⁵ We have $\mathcal{P} \in [\mathcal{D}_{1,0}\mathcal{D}_{1,2}] \xrightarrow{\text{L1.2.22.15}} \mathcal{P} \in [\mathcal{D}_{1,0}\mathcal{D}_{1,1}] \vee \mathcal{P} \in [\mathcal{D}_{1,1}\mathcal{D}_{1,2}]$. If $B \in [\mathcal{D}_{1,0}\mathcal{D}_{1,1}]$, we let, by definition $\mathcal{A}_1 \rightleftharpoons \mathcal{D}_{1,0}$, $\mathcal{B}_1 \rightleftharpoons \mathcal{D}_{1,1}$, $a_1 \rightleftharpoons a_0 = 0$, $b_1 \rightleftharpoons a_0 + b/2 = b/2$. For $\mathcal{P} \in [\mathcal{D}_{1,1}\mathcal{D}_{1,2}]$, we denote $\mathcal{A}_1 \rightleftharpoons \mathcal{D}_{1,1}$, $\mathcal{B}_1 \rightleftharpoons \mathcal{D}_{1,2}$, $b_1 \rightleftharpoons a$, $a_1 \rightleftharpoons b_1 - b/2 = b/2$. Obviously, in both cases we have the inclusions $[\mathcal{A}_1\mathcal{B}_1] \subset [\mathcal{A}_0\mathcal{B}_0]$ and $[a_1, b_1] \subset [a_0, b_0]$.

Step m:

As the result of the previous $m - 1$ steps the generalized interval \mathcal{AB} is divided into 2^{m-1} congruent generalized intervals $\mathcal{D}_{m-1,0}\mathcal{D}_{m-1,1}, \mathcal{D}_{m-1,1}\mathcal{D}_{m-1,2}, \dots, \mathcal{D}_{m-1,2^{m-1}-1}\mathcal{D}_{m-1,2^m-1}$, where we let $\mathcal{D}_{m-1,0} \rightleftharpoons \mathcal{A}$, $\mathcal{D}_{m-1,2^m-1} \rightleftharpoons \mathcal{B}$. That is, we have $\mathcal{D}_{m-1,0}\mathcal{D}_{m-1,1} \equiv \mathcal{D}_{m-1,1}\mathcal{D}_{m-1,2} \equiv \dots \equiv \mathcal{D}_{m-1,2^{m-1}-2}\mathcal{D}_{m-1,2^m-1-1} \equiv \mathcal{D}_{m-1,2^{m-1}-1}\mathcal{D}_{m-1,2^m-1}$ and $[\mathcal{D}_{m-1,j-1}\mathcal{D}_{m-1,j}\mathcal{D}_{m-1,j+1}]$, $j = 1, 2, \dots, 2^{m-1} - 1$. We also know that $\mathcal{P} \in [\mathcal{A}_{m-1}\mathcal{B}_{m-1}]$, $a_{m-1} = \frac{k-1}{2^{m-1}} \cdot b$, $b_{m-1} = \frac{k}{2^{m-1}} \cdot b$, where $\mathcal{A}_{m-1} = \mathcal{D}_{m-1,k-1}$, $\mathcal{B}_{m-1} = \mathcal{D}_{m-1,k}$, $k \in \mathbb{N}_{2^{m-1}}$. Dividing each of the generalized intervals $\mathcal{D}_{m-1,0}\mathcal{D}_{m-1,1}, \mathcal{D}_{m-1,1}\mathcal{D}_{m-1,2}, \dots, \mathcal{D}_{m-1,2^{m-1}-1}\mathcal{D}_{m-1,2^m-1}$ into two congruent generalized intervals⁵⁶⁶, we obtain by T 1.3.51 the division of \mathcal{AB} into $2^{m-1} \cdot 2 = 2^m$ congruent generalized intervals $\mathcal{D}_{m,0}\mathcal{D}_{m,1}, \mathcal{D}_{m,1}\mathcal{D}_{m,2}, \dots, \mathcal{D}_{m,2^m-1}\mathcal{D}_{m,2^m}$, where we let $\mathcal{D}_{m,0} \rightleftharpoons \mathcal{A}$, $\mathcal{D}_{m,2^m} \rightleftharpoons \mathcal{B}$. That is, we have $\mathcal{D}_{m,0}\mathcal{D}_{m,1} \equiv \mathcal{D}_{m,1}\mathcal{D}_{m,2} \equiv \dots \equiv \mathcal{D}_{m,2^m-2}\mathcal{D}_{m,2^m-1} \equiv \mathcal{D}_{m,2^m-1}\mathcal{D}_{m,2^m}$ and $[\mathcal{D}_{m,j-1}\mathcal{D}_{m,j}\mathcal{D}_{m,j+1}]$, $j = 1, 2, \dots, 2^m - 1$.

Denote $\mathcal{C}_m \rightleftharpoons \text{mid } \mathcal{A}_{m-1}\mathcal{B}_{m-1}$. By L 1.2.22.15 $\mathcal{P} \in [\mathcal{A}_{m-1}\mathcal{B}_{m-1}] \Rightarrow \mathcal{P} \in [\mathcal{A}_{m-1}\mathcal{C}_m] \vee \mathcal{P} \in [\mathcal{C}_m\mathcal{B}_{m-1}]$. In the former case we let, by definition, $\mathcal{A}_m \rightleftharpoons \mathcal{A}_{m-1}$, $\mathcal{B}_m \rightleftharpoons \mathcal{C}_m$, $a_m \rightleftharpoons a_{m-1}$, $b_m \rightleftharpoons a_m + \frac{1}{2^m}$; in the latter $\mathcal{A}_m \rightleftharpoons \mathcal{C}_m$, $\mathcal{B}_m \rightleftharpoons \mathcal{B}_{m-1}$, $a_m \rightleftharpoons a_{m-1}$, $b_m \rightleftharpoons b_{m-1} - \frac{1}{2^m}$. Obviously, we have in both cases $[\mathcal{A}_m\mathcal{B}_m] \subset [\mathcal{A}_{m-1}\mathcal{B}_{m-1}]$, $[a_m, b_m] \subset [a_{m-1}, b_{m-1}]$, $b_m - a_m = \frac{1}{2^m}$. Also, note that if $\mathcal{A}_m = \mathcal{D}_{m,l-1}$, $\mathcal{B}_m = \mathcal{D}_{m,l}$, $l \in \mathbb{N}_{2^m}$, then $a_m = \frac{l-1}{2^m}$, $b_m = (n-1) + \frac{l}{2^m}$.⁵⁶⁷

Continuing this process indefinitely (for all $m \in \mathbb{N}$), we conclude that either $\exists m_0 \mathcal{A}_{m_0} = \mathcal{P}$, and then, obviously, $\forall m \in \mathbb{N} \setminus \mathbb{N}_{m_0} \mathcal{A}_m = \mathcal{P}$; or $\forall m \in \mathbb{N} \mathcal{P} \in [\mathcal{A}_m\mathcal{B}_m]$. In the first case we also have $\forall p \in \mathbb{N} a_{m_0+p} = a_{m_0}$, and we let, by definition, $|\mathcal{AP}| \rightleftharpoons e_{m_0}$. In the second case we define $|\mathcal{AP}|$ to be the number lying on all the closed numerical intervals $[a_m, b_m]$, $m \in \mathbb{N}$. We can do so because the closed numerical intervals $[a_m, b_m]$, $m \in \mathbb{N}$, as well as the generalized closed intervals $(\mathcal{A}_m\mathcal{B}_m)$, form a nested sequence, where the difference $b_m - a_m = \frac{1}{2^m}$ can be made less than any given positive real number $\epsilon > 0$.⁵⁶⁸ Thus, we have proved

Theorem 1.4.11. *The measurement construction puts into correspondence with every generalized interval \mathcal{AP} , where $\mathcal{P} \in (\mathcal{AB})$ and $[\mathcal{AB}] = \mathfrak{J} \in \mathcal{C}^{gbr}$, a unique positive real number $|\mathcal{AP}|$ called the measure, of \mathcal{AP} . The reference generalized interval, as well as any generalized interval congruent to it, has length b .*

Note than we can write

$$\mathcal{AP} < \dots \leq \mathcal{AB}_m \leq \mathcal{AB}_{m-1} \leq \dots \leq \mathcal{AB}_1 \leq \mathcal{AB}_0. \quad (1.15)$$

and

$$a_0 \leq a_1 \leq \dots \leq a_{m-1} \leq a_m \leq \dots \leq |\mathcal{AP}| < \dots \leq f_m \leq f_{m-1} \leq \dots \leq f_1 \leq f_0. \quad (1.16)$$

Some additional properties of the measurement construction are given by

Lemma 1.4.12.1. *Given an arbitrary generalized interval \mathcal{GH} , in the measurement construction for any generalized interval \mathcal{AP} there is an (appropriately defined) generalized interval $\mathcal{A}_m\mathcal{B}_m$ shorter than \mathcal{GH} .*

Proof. By Pr 1.4.1 the generalized interval \mathcal{AB} (appropriately defined for the measurement construction in question) can be divided into some number m of congruent generalized intervals shorter than \mathcal{GH} . Since $m < 2^m$, dividing \mathcal{AB} into 2^m generalized intervals at the m^{th} step of the measurement construction for \mathcal{AP} gives by L 1.3.51.9 still shorter generalized intervals. Hence the result. \square

This lemma shows that for sufficiently large m the generalized intervals $\mathcal{AA}_m, \mathcal{AA}_{m+1}, \dots$ are defined, i.e. $\mathcal{A}_m \neq \mathcal{A}$, etc., and we have⁵⁶⁹

$$\mathcal{AA}_m \leq \mathcal{AA}_{m+1} \leq \dots \leq \mathcal{AP}. \quad (1.17)$$

⁵⁶⁵The first index here refers to the step of the measurement construction.

⁵⁶⁶In each case, such division is possible and unique due to Pr 1.3.5.

⁵⁶⁷In fact, after $m - 1$ steps we have $\mathcal{P} \in [\mathcal{D}_{m-1,k-1}\mathcal{D}_{m-1,k}] = [\mathcal{A}_{m-1}\mathcal{B}_{m-1}]$, and after m steps $\mathcal{P} \in [\mathcal{D}_{m-1,l-1}\mathcal{D}_{m-1,l}] = [\mathcal{A}_m\mathcal{B}_m]$. First, consider the case $\mathcal{P} \in [\mathcal{A}_{m-1}\mathcal{C}_m]$, where $\mathcal{C}_m = \text{mid } \mathcal{A}_{m-1}\mathcal{B}_{m-1}$. Then, evidently, $l - 1 = 2(k - 1)$ and (see above) $a_m = a_{m-1}$, $b_m = a_m + 1/2^m$. Hence we have $a_m = a_{m-1} = (n - 1) + (k - 1)/2^{m-1} = (n - 1) + 2(k - 1)/2^m = (n - 1) + (l - 1)/2^m$, $b_m = (n - 1) + (l - 1)/2^m + 1/2^m = (n - 1) + l/2^m$. Suppose now $\mathcal{P} \in [\mathcal{C}_m\mathcal{B}_{m-1}]$. Then $l = 2k$ and $b_m = b_{m-1}$. Hence $b_m = b_{m-1} = (n - 1) + k/2^{m-1} = (n - 1) + 2k/2^m = (n - 1) + l/2^m$, $a_m = (n - 1) + l/2^m - 1/2^m = (n - 1) + (l - 1)/2^m$.

⁵⁶⁸By the properties of real numbers, these conditions imply that the number lying on all open numerical intervals (a_m, b_m) exists and is unique.

⁵⁶⁹In fact, once $\mathcal{A}_m\mathcal{B}_m$ is shorter than \mathcal{AP} , the geometric object \mathcal{A}_m cannot coincide with \mathcal{A} any longer. To demonstrate this, consider the congruent generalized intervals $\mathcal{D}_{m,0}\mathcal{D}_{m,1}, \mathcal{D}_{m,1}\mathcal{D}_{m,2}, \dots, \mathcal{D}_{m,2^m-1}\mathcal{D}_{m,2^m}$ into which the generalized interval \mathcal{AB} is divided after m steps of the measurement construction. If \mathcal{P} were to lie on the first of the division intervals, as it would be the case if $\mathcal{A}_m = \mathcal{A}$, we would have $\mathcal{P} \in [\mathcal{D}_{m,0}\mathcal{D}_{m,1}] = [\mathcal{A}_m\mathcal{B}_m]$, whence (see C 1.3.15.4) $\mathcal{AP} < \mathcal{A}_m\mathcal{B}_m$, contrary to our choice of m large enough for the inequality $\mathcal{A}_m\mathcal{B}_m < \mathcal{AP}$ to hold.

Lemma 1.4.12.2. *In the measurement process for a generalized interval \mathcal{AP} there can be no more than one geometric object lying on all generalized closed intervals $[\mathcal{A}_0\mathcal{B}_0], [\mathcal{A}_1\mathcal{B}_1], \dots, [\mathcal{A}_n\mathcal{B}_n], \dots$ defined appropriately for the measurement construction in question, and this geometric object, when it exists, coincides with the geometric object \mathcal{P} .*

Proof. As is evident from our exposition of the measurement construction, the closed generalized intervals $[\mathcal{A}_0\mathcal{B}_0], [\mathcal{A}_1\mathcal{B}_1], \dots, [\mathcal{A}_n\mathcal{B}_n], \dots$ form a nested sequence, i.e. we have $[\mathcal{A}_1\mathcal{B}_1] \supset [\mathcal{A}_2\mathcal{B}_2] \supset \dots \supset [\mathcal{A}_n\mathcal{B}_n] \supset \dots$. The result then follows from L 1.4.12.1, L 1.4.11.1. \square

Theorem 1.4.12. *Congruent generalized intervals have equal measures.*

Proof. Suppose $\mathcal{AP} \equiv \mathcal{A}'\mathcal{P}'$. On step 0, if $\mathcal{P} \in [\mathcal{AB}]$ then also $\mathcal{P}' \in [\mathcal{A}'\mathcal{B}']$, and therefore $a'_0 = a_0, b'_0 = b_0$.⁵⁷⁰ If $\mathcal{P} \in [\mathcal{D}_{1,0}\mathcal{D}_{1,1}]$ then (by C 1.3.51.14) $\mathcal{P}' \in [\mathcal{D}'_{1,0}\mathcal{D}'_{1,1}]$, and if $\mathcal{B} \in [\mathcal{D}_{1,1}\mathcal{D}_{1,2}]$ then $\mathcal{P}' \in [\mathcal{D}'_{1,1}\mathcal{D}'_{1,2}]$. Therefore (see the exposition of measurement construction) $a'_1 = a_1, b'_1 = b_1$. Now assume inductively that after the $m-1$ th step of the measurement constructions the generalized interval \mathcal{AB} is divided into 2^{m-1} congruent generalized intervals $\mathcal{D}_{m-1,0}\mathcal{D}_{m-1,1}, \mathcal{D}_{m-1,1}\mathcal{D}_{m-1,2}, \dots, \mathcal{D}_{m-1,2^{m-1}-1}\mathcal{D}_{m-1,2^{m-1}}$ with $\mathcal{D}_{m-1,0} = \mathcal{A}, \mathcal{D}_{m-1,2^{m-1}} = \mathcal{B}$ and $\mathcal{A}'\mathcal{B}'$ is divided into 2^{m-1} congruent generalized intervals $\mathcal{D}'_{m-1,0}\mathcal{D}'_{m-1,1}, \mathcal{D}'_{m-1,1}\mathcal{D}'_{m-1,2}, \dots, \mathcal{D}'_{m-1,2^{m-1}-1}\mathcal{D}'_{m-1,2^{m-1}}$ with $\mathcal{D}'_{m-1,0} = \mathcal{A}', \mathcal{D}'_{m-1,2^{m-1}} = \mathcal{B}'$. Then we have (induction assumption implies here that we have the same k in both cases) $\mathcal{P} \in [\mathcal{A}_{m-1}\mathcal{B}_{m-1}], a_{m-1} = \frac{k-1}{2^{m-1}} \cdot b, b_{m-1} = \frac{k}{2^{m-1}} \cdot b$, where $\mathcal{A}_{m-1} = \mathcal{D}_{m-1,k-1}, \mathcal{B}_{m-1} = \mathcal{D}_{m-1,k}, k \in \mathbb{N}_{2^{m-1}}$ and $\mathcal{P}' \in [\mathcal{A}'_{m-1}\mathcal{B}'_{m-1}], a'_{m-1} = \frac{k-1}{2^{m-1}} \cdot b, b'_{m-1} = \frac{k}{2^{m-1}} \cdot b$, where $\mathcal{A}'_{m-1} = \mathcal{D}'_{m-1,k-1}, \mathcal{B}'_{m-1} = \mathcal{D}'_{m-1,k}, k \in \mathbb{N}_{2^{m-1}}$.

At the m th step we divide each of the generalized intervals $\mathcal{D}_{m-1,0}\mathcal{D}_{m-1,1}, \mathcal{D}_{m-1,1}\mathcal{D}_{m-1,2}, \dots, \mathcal{D}_{m-1,2^{m-1}-1}\mathcal{D}_{m-1,2^{m-1}}$ into two congruent generalized intervals to obtain the division of \mathcal{AB} into 2^m congruent generalized intervals $\mathcal{D}_{m,0}\mathcal{D}_{m,1}, \mathcal{D}_{m,1}\mathcal{D}_{m,2}, \dots, \mathcal{D}_{m,2^m-1}\mathcal{D}_{m,2^m}$, where, by definition, $\mathcal{D}_{m,0} \equiv \mathcal{A}, \mathcal{D}_{m,2^m} \equiv \mathcal{B}$. That is, we have $\mathcal{D}_{m,0}\mathcal{D}_{m,1} \equiv \mathcal{D}_{m,1}\mathcal{D}_{m,2} \equiv \dots \equiv \mathcal{D}_{m,2^m-2}\mathcal{D}_{m,2^m-1} \equiv \mathcal{D}_{m,2^m-1}\mathcal{D}_{m,2^m}$ and $[\mathcal{D}_{m,j-1}\mathcal{D}_{m,j}\mathcal{D}_{m,j+1}], j = 1, 2, \dots, 2^m - 1$.

Similarly, we divide each of the generalized intervals $\mathcal{D}'_{m-1,0}\mathcal{D}'_{m-1,1}, \mathcal{D}'_{m-1,1}\mathcal{D}'_{m-1,2}, \dots, \mathcal{D}'_{m-1,2^{m-1}-1}\mathcal{D}'_{m-1,2^{m-1}}$ into two congruent generalized intervals to obtain the division of $\mathcal{A}'\mathcal{B}'$ into 2^m congruent generalized intervals $\mathcal{D}'_{m,0}\mathcal{D}'_{m,1}, \mathcal{D}'_{m,1}\mathcal{D}'_{m,2}, \dots, \mathcal{D}'_{m,2^m-1}\mathcal{D}'_{m,2^m}$, where $\mathcal{D}'_{m,0} \equiv \mathcal{A}', \mathcal{D}'_{m,2^m} \equiv \mathcal{B}'$. That is, we have $\mathcal{D}'_{m,0}\mathcal{D}'_{m,1} \equiv \mathcal{D}'_{m,1}\mathcal{D}'_{m,2} \equiv \dots \equiv \mathcal{D}'_{m,2^m-2}\mathcal{D}'_{m,2^m-1} \equiv \mathcal{D}'_{m,2^m-1}\mathcal{D}'_{m,2^m}$ and $[\mathcal{D}'_{m,j-1}\mathcal{D}'_{m,j}\mathcal{D}'_{m,j+1}], j = 1, 2, \dots, 2^m - 1$.

Since the geometric objects $\mathcal{A} = \mathcal{D}_{m,0}, \mathcal{D}_{m,1}, \dots, \mathcal{D}_{m,2^m-1}, \mathcal{B} = \mathcal{D}_{m,2^m}$ are in order $[\mathcal{D}_{m,0}\mathcal{D}_{m,1} \dots \mathcal{D}_{m,2^m-1}\mathcal{D}_{m,2^m}]$ and the geometric objects $\mathcal{A}' = \mathcal{D}'_{m,0}, \mathcal{D}'_{m,1}, \dots, \mathcal{D}'_{m,2^m-1}, \mathcal{B}' = \mathcal{D}'_{m,2^m}$ are in order $[\mathcal{D}'_{m,0}\mathcal{D}'_{m,1} \dots \mathcal{D}'_{m,2^m-1}\mathcal{D}'_{m,2^m}]$, if $\mathcal{P} \in [\mathcal{A}_m\mathcal{B}_m] = [\mathcal{D}_{m,l-1}\mathcal{D}_{m,l}]$ then by C 1.3.51.14 $\mathcal{P}' \in [\mathcal{A}'_m\mathcal{B}'_m] = [\mathcal{D}'_{m,l-1}\mathcal{D}'_{m,l}]$, and we have $a'_m = a_m = \frac{l-1}{2^m} \cdot b, b'_m = b_m = \frac{l}{2^m} \cdot b$. Furthermore, if $\mathcal{P} = \mathcal{A}_m$ then by L 1.3.51.13 also $\mathcal{P}' = \mathcal{A}'_m$ and in this case $|\mathcal{AP}| = a_m, |\mathcal{A}'\mathcal{P}'| = a'_m$, whence $|\mathcal{A}'\mathcal{P}'| = |\mathcal{AP}|$. On the other hand, if $\forall m \in \mathbb{N} \mathcal{P} \in [\mathcal{A}_m\mathcal{B}_m]$, and, therefore (see L 1.3.51.12), $\forall m \in \mathbb{N} \mathcal{P}' \in [\mathcal{A}'_m\mathcal{B}'_m]$, then both $\forall m \in \mathbb{N} |\mathcal{AP}| \in [a_m, b_m]$ and $\forall m \in \mathbb{N} |\mathcal{A}'\mathcal{P}'| \in [a'_m, b'_m]$. But since, as we have shown, $a'_m = a_m, b'_m = b_m$, using the properties of real numbers, we again conclude that $|\mathcal{A}'\mathcal{P}'| = |\mathcal{AP}|$. \square

Note that the theorem just proven shows that our measurement construction for generalized intervals is completely well-defined. When applied to the identical generalized intervals $\mathcal{AB}, \mathcal{BA}$, the procedure of measurement gives identical results.

Lemma 1.4.13.1. *Every generalized interval, consisting of k congruent generalized intervals resulting from division of a reference generalized interval into 2^m congruent intervals, has measure $(k/2^m) \cdot b$.*

Proof. Given a generalized interval \mathcal{AP} , consisting of k congruent generalized intervals resulting from the division of a reference generalized interval into 2^m congruent generalized intervals, at the m th step of the measurement construction for \mathcal{AP} we obtain the generalized interval \mathcal{AA}_m consisting of k generalized intervals resulting from division of the reference generalized interval into 2^m congruent generalized intervals, and we have $\mathcal{AA}_m \equiv \mathcal{AP}$ (see L 1.2.51.6). Then by Pr 1.3.1 $\mathcal{A}_m = \mathcal{P}$. As explained in the text describing the measurement construction, in this case we have $k = l-1$. Hence $|\mathcal{AP}| = |\mathcal{AA}_m| = a_m = ((l-1)/2^m) \cdot b = (k/2^m) \cdot b$. \square

Theorem 1.4.13. *If a generalized interval $\mathcal{A}'\mathcal{P}'$ is shorter than the generalized interval \mathcal{AP} then $|\mathcal{A}'\mathcal{P}'| < |\mathcal{AP}|$.*

Proof. Using L 1.3.15.3, find $\mathcal{P}_1 \in (\mathcal{AP})$ so that $\mathcal{A}'\mathcal{P}' \equiv \mathcal{AP}_1$. Consider the measurement construction of \mathcal{AP} , which, as will become clear in the process of the proof, induces the measurement construction for \mathcal{AP}_1 . Suppose $\mathcal{P} \in [\mathcal{AB}]$, where \mathcal{A}, \mathcal{B} are the ends of an appropriate⁵⁷¹ set \mathfrak{J} with generalized betweenness relation. Let there be a step number m in the measurement process for \mathcal{AP} such that when after the $m-1$ th step of the measurement construction the generalized interval \mathcal{AB} is divided into 2^{m-1} congruent generalized intervals $\mathcal{D}_{m-1,0}\mathcal{D}_{m-1,1}, \mathcal{D}_{m-1,1}\mathcal{D}_{m-1,2}, \dots, \mathcal{D}_{m-1,2^{m-1}-1}\mathcal{D}_{m-1,2^{m-1}}$ with $\mathcal{D}_{m-1,0} = \mathcal{A}, \mathcal{D}_{m-1,2^{m-1}} = \mathcal{B}$ and both \mathcal{P}_1 and \mathcal{P} lie on the same generalized half-open interval $[\mathcal{D}'_{m-1,p-1}\mathcal{D}'_{m-1,p}), p \in \mathbb{N}_{2^{m-1}}$, at the m th step $\mathcal{P}_1, \mathcal{P}$ lie on different

⁵⁷⁰For the duration of this proof, all elements of the measurement construction for $\mathcal{A}'\mathcal{P}'$ appear primed; for other notations, please refer to the exposition of the measurement construction.

⁵⁷¹Appropriate means here conforming to the conditions set forth above. Namely, we assume the set \mathfrak{J} to be equipped with a relation of generalized congruence, and the sets \mathfrak{J} with generalized angular betweenness relation in \mathcal{C}^{gbr} are chosen in such a way that the abstract intervals formed by their ends are congruent: if $\mathfrak{J} = [\mathcal{AB}] \in \mathcal{C}^{gbr}, \mathfrak{J}' = [\mathcal{A}'\mathcal{B}'] \in \mathcal{C}^{gbr}$ then $\mathcal{AB} \equiv \mathcal{A}'\mathcal{B}'$.

generalized half-open intervals $[\mathcal{D}'_{m,l-2}\mathcal{D}'_{m,l-1}]$, $[\mathcal{D}'_{m,l-1}\mathcal{D}'_{m,l}]$, where $l \in \mathbb{N}_{2^m}$, resulting from the division of the generalized interval $\mathcal{D}'_{m-1,p-1}\mathcal{D}'_{m-1,p}$ into two congruent generalized intervals $\mathcal{D}'_{m,l-2}\mathcal{D}'_{m,l-1}$, $\mathcal{D}'_{m,l-1}\mathcal{D}'_{m,l}$.⁵⁷² Then, using 1.16, we have $|\mathcal{AP}_1| < f_m^{(\mathcal{P}_1)} = \frac{l-1}{2^m} \cdots b = a_m^{(\mathcal{P})} \leq |\mathcal{AP}|$, whence $|\mathcal{AP}_1| < |\mathcal{AP}|$. Finally, consider the case when for all $m \in \mathbb{N}$ the geometric objects \mathcal{P}_1 , \mathcal{P} lie on the same generalized half-open interval $[\mathcal{A}_m\mathcal{B}_m]$, where $\mathcal{A}_m = \mathcal{A}_m^{\mathcal{P}_1} = \mathcal{A}_m^{\mathcal{P}}$, $\mathcal{B}_m = \mathcal{B}_m^{\mathcal{P}_1} = \mathcal{B}_m^{\mathcal{P}}$. By L 1.4.12.2 \mathcal{P}_1 , \mathcal{P} cannot lie both at once on all closed generalized intervals $[\mathcal{A}_0\mathcal{B}_0]$, $[\mathcal{A}_1\mathcal{B}_1]$, \dots , $[\mathcal{A}_n\mathcal{B}_n]$, \dots . Therefore, by L 1.2.24.6, we are left with $\mathcal{P}_1 = \mathcal{A}_m$, $\mathcal{P} \in (\mathcal{A}_m\mathcal{B}_m)$ as the only remaining option. In this case we have, obviously, $|\mathcal{AP}_1| = a_m < |\mathcal{AP}|$. \square

Corollary 1.4.13.2. *If $|\mathcal{A}'\mathcal{B}'| = |\mathcal{AB}|$ then $\mathcal{A}'\mathcal{B}' \equiv \mathcal{A}$.*

Proof. See L 1.3.15.14, T 1.4.13. \square

Corollary 1.4.13.3. *If $|\mathcal{A}'\mathcal{B}'| < |\mathcal{AB}|$ then $\mathcal{A}'\mathcal{B}' < \mathcal{AB}$.*

Proof. See L 1.3.15.14, T 1.4.12, T 1.4.13. \square

Theorem 1.4.14. *If a geometric object \mathcal{P} lies between \mathcal{A} and \mathcal{Q} , then $|\mathcal{AP}| + |\mathcal{PQ}| = |\mathcal{AQ}|$.*

Proof. After the m^{th} step of the measurement construction for the generalized interval \mathcal{AP} we find that the geometric object \mathcal{P} lies on the generalized half-open interval $[\mathcal{A}_m, \mathcal{B}_m)$, where the generalized intervals \mathcal{AA}_m , \mathcal{AB}_m consist, respectively, of some numbers $k \in \mathbb{N}$, $k+1$ of congruent generalized intervals resulting from division of a reference generalized interval into 2^m congruent generalized intervals, and, consequently, have measures equal to $\frac{k}{2^m} \cdot b$ and $\frac{k+1}{2^m} \cdot b$, respectively.

⁵⁷³ Hence, using (1.15, 1.17) and applying the preceding theorem (T 1.4.13), we can write the following inequalities:

$$\frac{k}{2^m} \cdot b \leq |\mathcal{AP}| < \frac{k+1}{2^m} \cdot b \quad (1.18)$$

Consider first the case $\mathcal{Q} = \mathcal{B}$.

We know that after the m^{th} step of the measurement construction for \mathcal{AP} we obtain the division of \mathcal{AB} into 2^m congruent generalized intervals $\mathcal{D}_{m,0}\mathcal{D}_{m,1}, \mathcal{D}_{m,1}\mathcal{D}_{m,2}, \dots, \mathcal{D}_{m,2^m-1}\mathcal{D}_{m,2^m}$, where $\mathcal{D}_{m,0} \equiv \mathcal{A}$, $\mathcal{D}_{m,2^m} \equiv \mathcal{B}$. We know also that \mathcal{P} lies on the generalized half-open interval $[\mathcal{D}_{m,k}\mathcal{D}_{m,k+1})$, where $\mathcal{D}_{m,k} = \mathcal{A}_m$, $\mathcal{D}_{m,k+1} = \mathcal{B}_m$. Observe now that the interval $\mathcal{BD}_{m,k+1} = \mathcal{B}_m\mathcal{B}$ ⁵⁷⁴ consists of $2^m - k - 1$ congruent generalized intervals $\mathcal{D}_{m,k+1}\mathcal{D}_{m,k+2}, \mathcal{D}_{m,k+2}\mathcal{D}_{m,k+3}, \dots, \mathcal{D}_{m,2^m-1}\mathcal{D}_{m,2^m}$. Similarly, the interval $\mathcal{BD}_{m,k} = \mathcal{A}_m\mathcal{B}$ ⁵⁷⁵ consists of $2^m - k$ congruent generalized intervals $\mathcal{D}_{m,k}\mathcal{D}_{m,k+1}, \mathcal{D}_{m,k+1}\mathcal{D}_{m,k+2}, \mathcal{D}_{m,k+2}\mathcal{D}_{m,k+3}, \dots, \mathcal{D}_{m,2^m-1}\mathcal{D}_{m,2^m}$. Hence by L 1.4.13.1 the generalized intervals \mathcal{BB}_m , \mathcal{BA}_m have measures equal to $1 - \frac{k}{2^m} \cdot b$ and $1 - \frac{k+1}{2^m} \cdot b$, respectively. Hence, using (1.15, 1.17) and applying the preceding theorem (T 1.4.13), we can write the following inequalities:

$$1 - \frac{k+1}{2^m} \cdot b < |\mathcal{BP}| \leq 1 - \frac{k}{2^m} \cdot b \quad (1.19)$$

Adding together 1.18 and 1.19, we can write

$$\left(1 - \frac{1}{2^m}\right) \cdot b < |\mathcal{AP}| + |\mathcal{BP}| \leq \left(1 + \frac{k}{2^m}\right) \cdot b. \quad (1.20)$$

Finally, taking in 1.20 the limit $m \rightarrow \infty$, we have $|\mathcal{AP}| + |\mathcal{BP}| = b$, q.e.d.

Suppose now \mathcal{Q} lies on \mathcal{AB} . Since $[\mathcal{APQ}]$ and $\mathcal{Q} \in (\mathcal{AB})$, after the m^{th} step of the measurement construction for \mathcal{AQ} by L 1.2.24.6 we have $\mathcal{P} \in [\mathcal{D}_{m,k-1}\mathcal{D}_{m,k})$, $\mathcal{Q} \in [\mathcal{D}_{m,l-1}\mathcal{D}_{m,l})$, where $0 < k \leq l \leq 2^m$. Observe that, making use of L 1.2.12.2, we can take m so large that $k < l - 1$.⁵⁷⁶ Furthermore, our previous discussion shows that m can also be taken so large that $k > 1$. With these assumptions concerning the choice of m , we see that the interval

⁵⁷²The fact that $\mathcal{P}_1 \in [\mathcal{D}'_{m,l-2}\mathcal{D}'_{m,l-1})$ and $\mathcal{P} \in [\mathcal{D}'_{m,l-1}\mathcal{D}'_{m,l})$ and not the other way round, follows from L 1.2.24.6.

⁵⁷³We take m large enough for the geometric objects \mathcal{A} , \mathcal{A}_m to be distinct and thus for the generalized interval \mathcal{AA}_m to make sense. (See the discussion accompanying the equation (1.17).)

⁵⁷⁴We take m large enough for the geometric objects \mathcal{B} , \mathcal{B}_m to be distinct and thus for the generalized interval \mathcal{BB}_m to make sense. (See the discussion accompanying the equation (1.17)). Note also how symmetric is our discussion of this with the discussion in the preceding footnote.

⁵⁷⁵We take m large enough for the geometric objects \mathcal{B} , \mathcal{B}_m to be distinct and thus for the generalized interval \mathcal{BB}_m to make sense. (See the discussion accompanying the equation (1.17).) Note also how symmetric is our discussion of this with the discussion in the preceding footnote.

⁵⁷⁶First, we note that we can take m so large that $k < l$. In fact, if both \mathcal{P} and \mathcal{Q} were to lie on $\mathcal{P} \in [\mathcal{D}_{m,k(m)-1}\mathcal{D}_{m,k(m)})$ (note that the number k (of the generalized interval $\mathcal{D}_{m,k-1}\mathcal{D}_{m,k}$ resulting from the division of \mathcal{AB} into 2^m congruent intervals) depends on m , which is reflected in the self-explanatory notation used here), then by C 1.3.15.4 we would have $\mathcal{PQ} < \mathcal{D}_{m,k-1}\mathcal{D}_{m,k}$ for all $m \in \mathbb{N}$, which contradicts L 1.2.12.2. Thus, we conclude that $\exists m \in \mathbb{N}$ such that $\mathcal{P} \in [\mathcal{D}_{m,k-1}\mathcal{D}_{m,k})$, $\mathcal{Q} \in [\mathcal{D}_{m,l-1}\mathcal{D}_{m,l})$, where $0 < k < l \leq 2^m$. To prove that we can go even further and find such $m \in \mathbb{N}$ that $\mathcal{P} \in [\mathcal{D}_{m,k-1}\mathcal{D}_{m,k})$, $\mathcal{Q} \in [\mathcal{D}_{m,l-1}\mathcal{D}_{m,l})$, where $k < l - 1$, suppose that there is a natural number m_0 such that $\mathcal{P} \in [\mathcal{D}_{m_0,k(m_0)-1}\mathcal{D}_{m_0,k(m_0)})$, $\mathcal{Q} \in [\mathcal{D}_{m_0,k(m_0)}\mathcal{D}_{m_0,k(m_0)+1})$ (note that if there is no such natural number m_0 , then there is nothing else to prove). Now, using L 1.4.12.1, we choose a (still larger) number m such that $\mathcal{D}_{m,k(m)-1}\mathcal{D}_{m,k(m)} < \mathcal{PD}_{m_0,k(m_0)}$. If we still had $\mathcal{P} \in [\mathcal{D}_{m,k(m)-1}\mathcal{D}_{m,k(m)})$, $\mathcal{Q} \in [\mathcal{D}_{m,l(m)-1}\mathcal{D}_{m,l(m)})$, where $l(m) - k(m) = 1$ and $\mathcal{D}_{m,l(m)-1} = \mathcal{D}_{m_0,k(m_0)}$, then this would imply $\mathcal{P} \in [\mathcal{D}_{m,k(m)-1}\mathcal{D}_{m,k(m)}) = [\mathcal{D}_{m,k(m)-1}\mathcal{D}_{m,l(m)-1}) = [\mathcal{D}_{m,k(m)-1}\mathcal{D}_{m,k(m_0)}) \Rightarrow \mathcal{PD}_{m_0,k(m_0)} < \mathcal{D}_{m,k(m)-1}\mathcal{D}_{m,k(m)}$, contrary to our choice of m . This contradiction shows that the number m can be chosen large enough for the inequality $l - 1 > k$ to hold when $\mathcal{P} \in [\mathcal{D}_{m,k-1}\mathcal{D}_{m,k})$, $\mathcal{Q} \in [\mathcal{D}_{m,l-1}\mathcal{D}_{m,l})$.

$\mathcal{D}_{m,k}\mathcal{D}_{m,l-1}$ consists of $l-1-k$ congruent intervals obtained by division of the reference interval \mathcal{AB} into 2^m congruent intervals and by L 1.4.13.1 has measure $\frac{l-1-k}{2^m} \cdot b$. Similarly, the interval $\mathcal{D}_{m,k-1}\mathcal{D}_{m,l}$ consists of $l+1-k$ congruent intervals of the type described above and has measure $\frac{l+1-k}{2^m} \cdot b$. In this way we also obtain $|\mathcal{AD}_{m,k-1}| = \frac{k-1}{2^m} \cdot b$, $|\mathcal{AD}_{m,k}| = \frac{k}{2^m} \cdot b$, $|\mathcal{AD}_{m,l-1}| = \frac{l-1}{2^m} \cdot b$, $|\mathcal{AD}_{m,l}| = \frac{l}{2^m} \cdot b$. Since $\mathcal{AD}_{m,k-1} \subseteq \mathcal{AP} < \mathcal{AD}_{m,k}$, $\mathcal{AD}_{m,l-1} \subseteq \mathcal{AQ} < \mathcal{AD}_{m,l}$, $\mathcal{D}_{m,k}\mathcal{D}_{m,l-1} < \mathcal{PQ} < \mathcal{D}_{m,k-1}\mathcal{D}_{m,l}$, we have

$$\frac{k-1}{2^m} \cdot b < |\mathcal{AP}| < \frac{k}{2^m} \cdot b, \quad (1.21)$$

$$\frac{l-k-1}{2^m} \cdot b < |\mathcal{PQ}| < \frac{l+1-k}{2^m} \cdot b, \quad (1.22)$$

$$\frac{l-1}{2^m} \cdot b < |\mathcal{AQ}| < \frac{l}{2^m} \cdot b. \quad (1.23)$$

Adding together the inequalities (1.21), (1.22) gives

$$\frac{l-2}{2^m} \cdot b < |\mathcal{AP}| + |\mathcal{PQ}| < \frac{l+1}{2^m} \cdot b. \quad (1.24)$$

Subtracting (1.24) from (1.23), we get

Finally, taking the limit $m \rightarrow \infty$ in (??), we obtain $|\mathcal{AP}| + |\mathcal{PQ}| - |\mathcal{AQ}| = 0$, as required. \square

Corollary 1.4.14.1. *If a class $\mu\mathcal{AB}$ of congruent generalized intervals is the sum of classes of congruent generalized intervals $\mu\mathcal{CD}$, $\mu\mathcal{EF}$ (i.e. if $\mu\mathcal{AB} = \mu\mathcal{CD} + \mu\mathcal{EF}$), then for any generalized intervals $\mathcal{A}_1\mathcal{B}_1 \in \mu\mathcal{AB}$, $\mathcal{C}_1\mathcal{D}_1 \in \mu\mathcal{CD}$, $\mathcal{E}_1\mathcal{F}_1 \in \mu\mathcal{EF}$ we have $|\mathcal{A}_1\mathcal{B}_1| = |\mathcal{C}_1\mathcal{D}_1| + |\mathcal{E}_1\mathcal{F}_1|$.*

Proof. See T 1.4.12, T 1.4.14. \square

Corollary 1.4.14.2. *If a class $\mu\mathcal{AB}$ of congruent generalized intervals is the sum of classes of congruent generalized intervals $\mu\mathcal{A}_1\mathcal{B}_1, \mu\mathcal{A}_2\mathcal{B}_2, \dots, \mu\mathcal{A}_n\mathcal{B}_n$ (i.e. if $\mu\mathcal{AB} = \mu\mathcal{A}_1\mathcal{B}_1 + \mu\mathcal{A}_2\mathcal{B}_2 + \dots + \mu\mathcal{A}_n\mathcal{B}_n$), then for any generalized intervals $\mathcal{CD} \in \mu\mathcal{AB}$, $\mathcal{C}_1\mathcal{D}_1 \in \mu\mathcal{A}_1\mathcal{B}_1, \mathcal{C}_2\mathcal{D}_2 \in \mu\mathcal{A}_2\mathcal{B}_2, \dots, \mathcal{C}_n\mathcal{D}_n \in \mu\mathcal{A}_n\mathcal{B}_n$ we have $|\mathcal{CD}| = |\mathcal{C}_1\mathcal{D}_1| + |\mathcal{C}_2\mathcal{D}_2| + \dots + |\mathcal{C}_n\mathcal{D}_n|$. In particular, if $\mu\mathcal{AB} = n\mu\mathcal{A}_1\mathcal{B}_1$ and $\mathcal{CD} \in \mu\mathcal{AB}$, $\mathcal{C}_1\mathcal{D}_1 \in \mu\mathcal{A}_1\mathcal{B}_1$, then $|\mathcal{CD}| = n|\mathcal{C}_1\mathcal{D}_1|$.⁵⁷⁷*

Theorem 1.4.15. *For any positive real number $0 < x \leq b$ there is a generalized interval \mathcal{AP} (and, in fact, an infinity of generalized intervals congruent to it) whose measure is equal to x .*

Proof. The construction of the required generalized interval consists of the following steps (countably infinite in number):⁵⁷⁸

– Step 0: Denote $\mathcal{A}_0 \equiv \mathcal{A}$, $\mathcal{B}_0 \equiv \mathcal{B}$, $a_0 \equiv 0$, $b_0 \equiv b$.

The other steps are defined inductively:

– Step 1: Denote \mathcal{C}_1 the middle of \mathcal{AB} , i.e. the geometric object \mathcal{C}_1 such that $[\mathcal{AC}_1\mathcal{B}]$ and $\mathcal{AC}_1 \equiv \mathcal{C}_1\mathcal{B}$. By Pr 1.3.5 this geometric object exists and is unique. Worded another way, the fact that \mathcal{C}_1 is the middle of \mathcal{AB} means that the generalized interval $\mathcal{D}_{1,0}\mathcal{D}_{1,2}$ is divided into two congruent generalized intervals $\mathcal{D}_{1,0}\mathcal{D}_{1,1}$, $\mathcal{D}_{1,1}\mathcal{D}_{1,2}$, where we denote $\mathcal{D}_{1,0} \equiv \mathcal{A}$, $\mathcal{D}_{1,1} \equiv \mathcal{C}_1$, $\mathcal{D}_{1,2} \equiv \mathcal{B}$.⁵⁷⁹ If $x \in (0, \frac{1}{2} \cdot b)$, i.e. for $0 < x < \frac{1}{2} \cdot b$, we let, by definition $\mathcal{A}_1 \equiv \mathcal{D}_{1,0}$, $\mathcal{B}_1 \equiv \mathcal{D}_{1,1}$, $a_1 \equiv 0$, $b_1 \equiv a_1 + \frac{1}{2} \cdot b = \frac{1}{2} \cdot b$. For $x \in [\frac{1}{2} \cdot b, b)$, we denote $\mathcal{A}_1 \equiv \mathcal{D}_{1,1}$, $\mathcal{B}_1 \equiv \mathcal{D}_{1,2}$, $b_1 \equiv b$, $a_1 \equiv b_1 - \frac{1}{2} \cdot b = \frac{1}{2} \cdot b$. Obviously, in both cases we have the inclusions $[\mathcal{A}_1\mathcal{B}_1] \subset [\mathcal{A}_0\mathcal{B}_0]$ and $[a_1, b_1] \subset [a_0, b_0]$.

.....
Step m:

As the result of the previous $m-1$ steps the generalized interval \mathcal{AB} is divided into 2^{m-1} congruent generalized intervals $\mathcal{D}_{m-1,0}\mathcal{D}_{m-1,1}, \mathcal{D}_{m-1,1}\mathcal{D}_{m-1,2}, \dots, \mathcal{D}_{m-1,2^{m-1}-1}\mathcal{D}_{m-1,2^m-1}$, where we let $\mathcal{D}_{m-1,0} \equiv \mathcal{A}$, $\mathcal{D}_{m-1,2^m-1} \equiv \mathcal{B}$. That is, we have $\mathcal{D}_{m-1,0}\mathcal{D}_{m-1,1} \equiv \mathcal{D}_{m-1,1}\mathcal{D}_{m-1,2} \equiv \dots \equiv \mathcal{D}_{m-1,2^{m-1}-2}\mathcal{D}_{m-1,2^m-1-1} \equiv \mathcal{D}_{m-1,2^{m-1}-1}\mathcal{D}_{m-1,2^m-1}$ and $[\mathcal{D}_{m-1,j-1}\mathcal{D}_{m-1,j}\mathcal{D}_{m-1,j+1}]$, $j = 1, 2, \dots, 2^{m-1} - 1$. We also know that $x \in [a_{m-1}b_{m-1})$, $a_{m-1} = \frac{k-1}{2^{m-1}} \cdot b$, $b_{m-1} = \frac{k}{2^{m-1}} \cdot b$, where $\mathcal{A}_{m-1} = \mathcal{D}_{m-1,k-1}$, $\mathcal{B}_{m-1} = \mathcal{D}_{m-1,k}$, $k \in \mathbb{N}_{2^{m-1}}$. Dividing each of the generalized intervals $\mathcal{D}_{m-1,0}\mathcal{D}_{m-1,1}, \mathcal{D}_{m-1,1}\mathcal{D}_{m-1,2}, \dots, \mathcal{D}_{m-1,2^{m-1}-1}\mathcal{D}_{m-1,2^m-1}$ into two congruent intervals⁵⁸⁰, we obtain by T 1.3.21 the division of \mathcal{AB} into $2^{m-1} \cdot 2 = 2^m$ congruent generalized intervals $\mathcal{D}_{m,0}\mathcal{D}_{m,1}, \mathcal{D}_{m,1}\mathcal{D}_{m,2}, \dots, \mathcal{D}_{m,2^m-1}\mathcal{D}_{m,2^m}$, where we let $\mathcal{D}_{m,0} \equiv \mathcal{A}$, $\mathcal{D}_{m,2^m} \equiv \mathcal{B}$. That is, we have $\mathcal{D}_{m,0}\mathcal{D}_{m,1} \equiv \mathcal{D}_{m,1}\mathcal{D}_{m,2} \equiv \dots \equiv \mathcal{D}_{m,2^m-2}\mathcal{D}_{m,2^m-1} \equiv \mathcal{D}_{m,2^m-1}\mathcal{D}_{m,2^m}$ and $[\mathcal{D}_{m,j-1}\mathcal{D}_{m,j}\mathcal{D}_{m,j+1}]$, $j = 1, 2, \dots, 2^m - 1$.

From the properties of real numbers it follows that either $x \in [a_{m-1}, (a_{m-1} + b_{m-1})/2)$ or $x \in [(a_{m-1} + b_{m-1})/2, b_{m-1})$. In the former case we let, by definition, $\mathcal{A}_m \equiv \mathcal{A}_{m-1}$, $\mathcal{B}_m \equiv \mathcal{C}_m$, $a_m \equiv a_{m-1}$, $b_m \equiv a_m + \frac{1}{2^m} \cdot b$; in the latter $\mathcal{A}_m \equiv \mathcal{C}_m$, $\mathcal{B}_m \equiv \mathcal{B}_{m-1}$, $a_m \equiv a_{m-1}$, $b_m \equiv b_{m-1} - \frac{1}{2^m} \cdot b$. Obviously, we have in both cases $[\mathcal{A}_m\mathcal{B}_m] \subset [\mathcal{A}_{m-1}\mathcal{B}_{m-1}]$, $[a_m, b_m] \subset [a_{m-1}b_{m-1}]$, $b_m - a_m = \frac{1}{2^m}$.

⁵⁷⁷ Obviously, $\mu\mathcal{AB} = (1/n)\mu\mathcal{A}_1\mathcal{B}_1$ and $\mathcal{CD} \in \mu\mathcal{AB}$, $\mathcal{C}_1\mathcal{D}_1 \in \mu\mathcal{A}_1\mathcal{B}_1$ then imply $|\mathcal{CD}| = (1/n)|\mathcal{C}_1\mathcal{D}_1|$.

⁵⁷⁸ We will construct a generalized interval \mathcal{AP} with $|\mathcal{AP}| = x$ in a way very similar to its measurement construction. In fact, we'll just make the measurement construction go in reverse direction - from numbers to intervals, repeating basically the same steps

⁵⁷⁹ Again, the first index here refers to the step of the measurement construction.

⁵⁸⁰ In each case, such division is possible and unique due to Pr 1.3.5

Continuing this process indefinitely (for all $m \in \mathbb{N}$), we conclude that either $\exists m_0 a_{m_0} = x$, and then, obviously, $\forall m \in \mathbb{N} \setminus \mathbb{N}_{m_0} a_m = x$; or $\forall m \in \mathbb{N} x \in (a_m b_m)$. In the first case we let, by definition, $\mathcal{P} \doteq \mathcal{A}_{m_0}$.

In the second case we define \mathcal{P} to be the (unique) geometric object lying on all the generalized closed intervals $[\mathcal{A}_m \mathcal{B}_m]$, $m \in \mathbb{N}$. We can do this by the Cantor's axiom Pr 1.4.2 because the closed generalized intervals $[\mathcal{A}_m \mathcal{B}_m]$ form a nested sequence, where by L 1.4.2.1 the generalized interval $\mathcal{A}_m \mathcal{B}_m$ can be made shorter than any given generalized interval.

Since from our construction it is obvious that the number x is the result of measurement construction applied to the generalized interval \mathcal{AP} , we can write $|\mathcal{AP}| = x$, as required. \square

In the forthcoming treatment we shall assume that whenever we are given a line a , one of the two possible opposite orders is chosen on it (see p. 22 ff.). Given such a line a with order \prec and a (non-empty) set $\mathcal{A} \subset \mathcal{P}_a$ of points on a , we call a point $B \in a$ an upper bound (respectively, lower bound) of \mathcal{A} iff $A \preceq B$ ($B \preceq A$) for all $A \in \mathcal{A}$. An upper bound B_0 is called a least upper bound, or supremum, written $\sup \mathcal{A}$ (greatest lower bound, or infimum, written $\inf \mathcal{A}$) of \mathcal{A} iff $B_0 \preceq B$ for any upper bound B of \mathcal{A} . Thus, $\sup \mathcal{A}$ is the least element in the set of upper bounds of \mathcal{A} , and $\inf \mathcal{A}$ is the greatest element in the set of lower bounds of \mathcal{A} . Obviously, the second requirement in the definition of least upper bound (namely, that $B_0 \preceq B$ for any upper bound B of \mathcal{A}) can be reformulated as follows: For whatever point $B' \in a$ preceding B_0 (i.e. such that $B' \prec B_0$) there is a point X succeeding B' (i.e. with the property that $X \succ B'$).

It is also convenient to assume, unless explicitly stated otherwise, that for an interval AB we have $A \prec B$.⁵⁸¹ With this convention in mind, we can view the open interval (AB) as the set $\{X | A \prec X \prec B\}$ (see T 1.2.14). Also, obviously, we have $[AB] = \{X | A \preceq X \prec B\}$, $(AB] = \{X | A \prec X \preceq B\}$, $[AB] = \{X | A \preceq X \preceq B\}$. A ray O_A may be viewed as the set of all such points X that $O \prec X$ (or $X \succ O$, which is the same) if $O \prec A$, and as the set of all such points X that $X \prec O$ if $A \prec O$. Moreover, if $X \in O_A$ then either $O \prec X \preceq A$ or $A \prec X$.⁵⁸² These facts will be extensively used in the succeeding exposition.⁵⁸³

Theorem 1.4.16. *If a non-empty set of points \mathcal{A} on a line a has an upper bound (respectively, a lower bound), it has a least upper bound (greatest lower bound).*⁵⁸⁴

*Proof.*⁵⁸⁵ By hypothesis, there is a point $B_1 \in a$ such that $A \preceq B_1$ for all $A \in \mathcal{A}$. Without loss of generality we can assume that $A \prec B_1$ for all $A \in \mathcal{A}$.⁵⁸⁶

We shall refer to an interval XY as normal iff:

a) there is $A \in \mathcal{A}$ such that $A \in [XY]$; and b) for all $B \in a$ the relation $B \succ Y$ implies $B \notin \mathcal{A}$. Observe that at least one of the halves⁵⁸⁷ of a normal interval is normal.⁵⁸⁸

Take an arbitrary point $A_1 \in \mathcal{A}$. Then, evidently, the interval $A_1 B_1$ is normal. Denote by $A_2 B_2$ its normal half. Continuing inductively this process of division of intervals into halves, we denote $A_{n+1} B_{n+1}$ a normal half of the interval $A_n B_n$.

With the sequence of intervals thus constructed, there is a unique point C lying on all the closed intervals $[A_i B_i]$, $i \in \mathbb{N}$ (see L 1.4.1.4, T 1.4.1). This can be written as $\{C\} = \bigcap_{i=0}^{\infty} [A_i B_i]$.

We will show that $C = \sup \mathcal{A}$. First, we need to show that C is an upper bound of \mathcal{A} . If C were not an upper bound of \mathcal{A} , there would exist a point $A_0 \in \mathcal{A}$ such that $C < A_0$. But then $A_0 \notin \bigcap_{i=0}^{\infty} [A_i B_i] = \{C\}$, whence we would have $\exists n_0 \in \mathbb{N} (A_{n_0} \leq C \leq B_{n_0} < A_0)$, i.e. the closed interval $[A_{n_0} B_{n_0}]$ cannot be normal - a contradiction. Thus, we have $\forall A \in \mathcal{A} (A \preceq C)$. In order to establish that $C = \sup \mathcal{A}$, we also need to prove that given any $X_1 \in \mathcal{P}_a$ with the property $X_1 \prec C$, there is a point $A \in \mathcal{A}$ such that $X_1 \prec A$ (see the discussion accompanying the definition of least upper bound).

Observe that for any $X_1 \in \mathcal{P}_a$ with the property $X_1 \prec C$ there is a number $n_1 \in \mathbb{N}$ such that $X_1 \prec A_{n_1} \preceq C \preceq B_{n_1}$. Otherwise (if $A_n \preceq X_1$ for all $n \in \mathbb{N}$) we would have $X_1 \in \bigcap_{i=0}^{\infty} [A_i B_i] = \{C\} \Rightarrow X_1 = C$, which contradicts $X_1 \prec C$. But then in view of normality of $[A_{n_1} B_{n_1}]$ there is $A \in \mathcal{A}$ such that $A \in [A_{n_1} B_{n_1}]$, i.e. $A_{n_1} \preceq A \preceq B_{n_1}$. Together with $X_1 \prec A_{n_1}$, this gives $X_1 \prec A$, whence the result. \square

⁵⁸¹ That is, the point denoted by the letter written first in the notation of the interval precedes in the chosen order the point designated by the letter written in the second position.

⁵⁸² This can be shown either referring to L 1.2.15.4, or directly using the facts presented above.

⁵⁸³ Basically, they mean that we can work with order on sets of points on a line just like we are accustomed to work with order on sets of "points" (numbers) on the "real line".

⁵⁸⁴ The arguments in the proof of this and the following two theorems are completely similar to those used to establish the corresponding results for real numbers in calculus.

⁵⁸⁵ The proof will be done for upper bound. The case of lower bound is completely analogous to the lower bound case.

⁵⁸⁶ In fact, if $A \prec B_1$ for all $A \in \mathcal{A}$ and $B_1 \in \mathcal{A}$, we would immediately have $B_1 \in \mathcal{A}$, and the proof would be complete.

⁵⁸⁷ If D is the midpoint of the interval AB , the intervals AD , DB are (as sometimes are intervals congruent to them) referred to as the halves of AB .

⁵⁸⁸ In fact, if $A \in [XY]$ and $M = \text{mid}XY$, then either $A \in [XM]$ or $A \in [MY]$ (see T 1.2.5). If $A \in [MY]$ then the second condition in the definition of normal interval is unchanged, so that it holds for MY if it does for XY . If $A \notin [MY]$ then necessarily $A \in [XM]$. In this case the relation $B \succ M$ (together with $X \prec M \prec Y$) implies that either $M \prec B \preceq Y$ (which amounts to $B \in [MY]$), or $B \succ Y$.

Theorem 1.4.17 (Dedekind). *Let \mathcal{A}, \mathcal{B} be two non-empty sets on a line a such that $\mathcal{A} \cup \mathcal{B} = \mathcal{P}_a$. Suppose, further, that any element of the set \mathcal{A} (strictly) precedes any element of the set \mathcal{B} , i.e. $(\forall A \in \mathcal{A})(\forall B \in \mathcal{B})(A \prec B)$. Then either there is a point C such that all points of \mathcal{A} precede C , or there is a point C such that C precedes all points of \mathcal{B} .*

In this case we say that the point C makes a Dedekind cut in \mathcal{P}_a . We can also say that \mathcal{A}, \mathcal{B} define a Dedekind cut in \mathcal{P}_a .

Proof. Since \mathcal{A} is not empty and has an upper bound, by the preceding theorem (T 1.4.16) it has the least upper bound $C = \sup \mathcal{A}$.

Observe that $\mathcal{A} \cap \mathcal{B} = \emptyset$. Otherwise we would have (by hypothesis) $A_0 \in \mathcal{A} \cap \mathcal{B} \Rightarrow (A_0 \in \mathcal{A}) \& \mathcal{B} \Rightarrow A_0 \prec A_0$, which is impossible.

Since $\mathcal{A} \cap \mathcal{B} = \emptyset$, we have either $C \in \mathcal{A}$, or $C \in \mathcal{B}$, but not both. If $C \in \mathcal{A}$ then $(\forall A \in \mathcal{A})(A \preceq C)$ because $C = \sup \mathcal{A}$. Suppose now $C \in \mathcal{B}$. To show that $(\forall B \in \mathcal{B})(C \prec B)$ suppose the contrary, i.e. that there is $B_0 \in \mathcal{B}$ such that $B_0 \prec C$. Since $C = \sup \mathcal{A}$, from the properties of least upper bound (see discussion following its definition) it would then follow that there exists $A_0 \in \mathcal{A}$ such that $B_0 \prec A_0$. But this would contradict the assumption that any point of \mathcal{A} precedes any point of \mathcal{B} (see L 1.2.13.5). Thus, in the case $C \in \mathcal{B}$ we have $C \prec B$ for all $B \in \mathcal{B}$, which completes the proof. \square

Theorem 1.4.18. *Let \mathcal{A}, \mathcal{B} be two non-empty sets on a line a with the property that any element of the set \mathcal{A} (strictly) precedes any element of the set \mathcal{B} , i.e. $(\forall A \in \mathcal{A})(\forall B \in \mathcal{B})(A \prec B)$. Then there is a point C such that $A \preceq C \preceq B$ for all $A \in \mathcal{A}, B \in \mathcal{B}$.*

Proof. Construct a Dedekind cut in \mathcal{P}_a defined by sets $\mathcal{A}_1, \mathcal{B}_1$ such that $\mathcal{A}_1 \neq \emptyset, \mathcal{B}_1 \neq \emptyset, \mathcal{A}_1 \cup \mathcal{B}_1 = \mathcal{P}_a, \mathcal{A} \subset \mathcal{A}_1, \mathcal{B} \subset \mathcal{B}_1$. To achieve this, we define $\mathcal{B}_1 = \{B_1 \in a | (\exists B \in \mathcal{B})(B \preceq B_1)\}$ and $\mathcal{A}_1 = \mathcal{P}_a \setminus \mathcal{B}_1$. To show that $\mathcal{B} \subset \mathcal{B}_1$ observe that for any point $B_1 \in \mathcal{B}_1$ there is $B = B_1 \in \mathcal{B}$, i.e. $B_1 \in \mathcal{B}$. To show that $\mathcal{A} \cap \mathcal{B}_1 = \emptyset$ suppose the contrary, i.e. that there is a point $A_0 \in \mathcal{A} \cap \mathcal{B}_1$. Then from the definition of \mathcal{B}_1 we would have $(\exists B_0 \in \mathcal{B})(B_0 \preceq A_0)$. But this contradicts the assumption $(\forall A \in \mathcal{A})(\forall B \in \mathcal{B})(A \prec B)$. Thus, we have $\mathcal{A} \cap \mathcal{B}_1 = \emptyset$, whence $\mathcal{A} \subset \mathcal{P}_a \setminus \mathcal{A}_1 = \mathcal{A}_1$.

To demonstrate that any point of the set \mathcal{A}_1 precedes any point of the set \mathcal{B}_1 suppose the contrary, i.e. that there are $A_0 \in \mathcal{A}_1, B_0 \in \mathcal{B}_1$ such that $B_0 \prec A_0$. Then using the definition of the set \mathcal{B}_1 we can write $B \preceq B_0 \preceq A_0$, whence by the same definition $A_0 \in \mathcal{B}_1 = \mathcal{P}_a \setminus \mathcal{A}_1$ - a contradiction. Thus, we have $\mathcal{P}_a = \mathcal{A}_1 \cup \mathcal{B}_1$, where $\mathcal{A}_1 \supset \mathcal{A} \neq \emptyset, \mathcal{B}_1 \supset \mathcal{B} \neq \emptyset$, and $(\forall A_1 \in \mathcal{A}_1)(\forall B_1 \in \mathcal{B}_1)(A_1 \prec B_1)$, which implies that the sets define a Dedekind cut in \mathcal{P}_a . Now by the preceding theorem (T 1.4.17) we can find a point $C \in a$ such that $(\forall A_1 \in \mathcal{A}_1)(\forall B_1 \in \mathcal{B}_1)(A_1 \preceq C \preceq B_1)$. But then from the inclusions $\mathcal{A} \subset \mathcal{A}_1, \mathcal{B} \subset \mathcal{B}_1$ we conclude that $(\forall A \in \mathcal{A})(\forall B \in \mathcal{B})(A \preceq C \preceq B)$, as required. \square

Lemma 1.4.18.1. *Given an arbitrary angle $\angle(h, k)$, a straight angle can be divided into congruent angles less than $\angle(h, k)$.*

Proof. (See Fig. 1.174.) Consider a right angle $\angle BOC$, whose side O_C is also one of the sides of a given straight angle. Using L 1.2.21.1, A 1.3.1, we can choose points B, C so that $OB \equiv OC$. Using C 1.3.25.1 (or T 1.3.22), choose the point A_0 such that the (abstract) interval OA_0 is a median of $\triangle BOC$. That is, we have $[BA_0C]$ and $BA_0 \equiv A_0C$. Then by T 1.3.24 OA_0 is also a bisector and an altitude. That is, we have $\angle BOA_0 \equiv \angle COA_0$ and $\angle BA_0O, \angle CA_0O$ are right angles. We can assume that $\angle(h, k) < \angle BOA_0$.⁵⁸⁹ Then we can find $A_1 \in (A_0B)$ such that $\angle(h, k) \equiv \angle A_0OA_1$.⁵⁹⁰ Using L 1.3.21.11 and the Archimedes' axiom (A 1.4.1), construct points $A_2, A_3, \dots, A_{n-1}, A_n$ such that $[A_{i-1}A_iA_{i+1}]$ for all $i \in \mathbb{N}_{n-1}$, $A_0A_1 \equiv A_1A_2 \equiv \dots \equiv A_{n-1}A_n$, and $[A_0BA_n]$. Using L 1.2.21.6, L 1.2.21.4, L 1.3.16.4, we obtain $\angle A_0OB < \angle A_0OA_n$. We construct further a sequence of rays $h_0, h_1, h_2, \dots, h_m, \dots$ with origin at O inductively as follows: Denote $h_0 = OA_0, h_1 = OA_1$. With $h_0, h_1, h_2, \dots, h_m$ already constructed, we choose (using A 1.3.4) h_{m+1} such that the rays h_{m-1}, h_{m+1} lie on opposite sides of the ray h_m and $\angle(h_{m-1}, h_m) \equiv \angle(h_m, h_{m+1})$. Then there is a number $k \in \mathbb{N}$ such that $h_{k-1} \subset \text{Int}\angle A_0OB$, but the ray h_k either coincides with O_B or lies inside the angle $\angle BOD$, adjacent supplementary to the angle $\angle BOC$. We will take k to be the least number with this property,⁵⁹¹ should there be more than one such number. We need to prove that there is at least such number. Suppose there are none and the rays h_i lie inside the angle $\angle A_0OB$ for all $i \in \mathbb{N}$. By construction (and T 1.3.1) the angles $\angle(h_i, h_{i+1}), i \in \mathbb{N}$, are all congruent to the angle $\angle(h, k)$ and thus are all acute. Since the rays h_{i-1}, h_{i+1} lie on opposite sides of the line \bar{h}_i and the angles $\angle(h_{i-1}, h_i), \angle(h_i, h_{i+1})$ are congruent, using C 1.3.18.12 we conclude that the ray h_i lies inside the angle $\angle(h_{i-1}, h_{i+1})$ for all $i \in \mathbb{N}$. By construction, $\angle OA_0A_1$ is a right angle. This, together with the fact that $A_0A_1 \equiv A_1A_2 \equiv \dots \equiv A_{n-1}A_n$ and $[A_{i-1}A_iA_{i+1}]$ for all $i \in \mathbb{N}_{n-1}$, gives the following inequalities: $\angle A_nOA_{n-1} < \angle A_{n-1}OA_{n-2} < \dots < \angle A_3OA_2 < \angle A_2OA_1 < \angle A_1OA_0$.

⁵⁸⁹Since the angle $\angle BOA_0$ is obtained by repeated congruent dichotomy (i.e. by repeated division into two congruent angles) of the original straight angle (see T 1.3.52), in the case when $\angle BOA_0 < \angle(h, k)$ we have nothing more to prove. Likewise, for $\angle BOA_0 \equiv \angle(h, k)$ we only need to divide $\angle BOA_0$ into two congruent parts once to get a division of our straight angle into congruent parts smaller than $\angle(h, k)$. Thus, we can safely assume that $\angle(h, k) < \angle BOA_0$, the only remaining option.

⁵⁹⁰In fact, we have $\angle(h, k) < \angle BOA_0 \xrightarrow{\text{L1.3.16.3}} \exists h_1; h_1 \subset \text{Int}\angle A_0OB \& \angle(OA_0, h_1) \equiv \angle(h, k) \xrightarrow{\text{L1.2.21.10}} \exists A_1 \in (A_0B) \cup h_1$. By L 1.2.11.3 $OA_1 = h_1$.

⁵⁹¹That is, with the property that $h_{k-1} \subset \text{Int}\angle A_0OB$, but h_k either coincides with O_B or lies inside the angle $\angle BOD$, adjacent supplementary to the angle $\angle BOC$. In reality, there are infinitely many k 's satisfying these conditions, but the proof of this would be too messy and pointless. For our purposes in this proof we can be content with knowing that there is at least one such k .

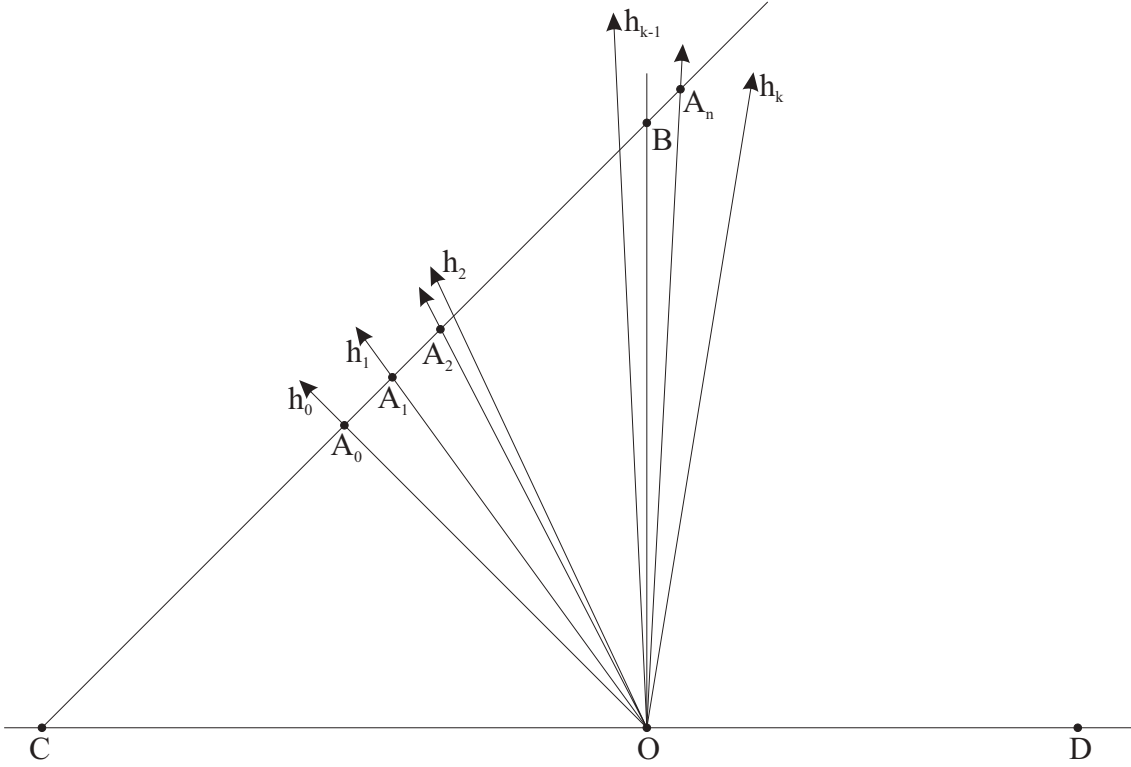

Figure 1.174: Given an arbitrary angle $\angle(h, k)$, a straight angle can be divided into congruent angles less than $\angle(h, k)$.

⁵⁹² Note also that by L 1.2.21.6, L 1.2.21.4 the ray OA_i lies inside the angle $\angle A_{i-1}OA_{i+1}$ for all $i \in \mathbb{N}$. Hence by L 1.3.52.4 we have $\angle A_0OA_n < \angle(h_0, h_n)$. On the other hand, by our assumption the rays h_i lie inside the angle $\angle A_0OB$ for all $i \in \mathbb{N}$. In view of C 1.3.16.4 this implies $\angle(h_0, h_n) < \angle A_0OB$, which, together with the inequality $\angle A_0OB < \angle A_0OA_n$ gives $\angle(h_0, h_n) < \angle A_0OA_n$, which contradicts $\angle A_0OA_n < \angle(h_0, h_n)$ (see L 1.3.16.10). Thus, we have shown that there is a positive integer k such that the ray h_k does not lie inside the angle $\angle A_0OB$. As we have already pointed out, we shall take as k the least number with this property. Then all the rays in the sequence h_1, h_2, \dots, h_{k-1} lie inside the angle $\angle A_0OB$, but h_k does not. Obviously, the rays h_0, h_1, \dots, h_{k-1} lie on one side of the line a_{OC} . ⁵⁹³ Furthermore, by L 1.2.22.11 these rays are in order $[h_0h_1h_2 \dots h_{k-1}]$. ⁵⁹⁴ This implies, in particular, that $[h_0h_{k-2}h_{k-1}]$, or, equivalently, $h_{k-2} \subset \text{Int}\angle(h_0, h_{k-1})$, which means, by definition, that the rays h_0, h_{k-2} lie on the same side of the ray h_{k-1} . On the other hand, by hypothesis, the rays h_{n-2}, h_n lie on opposite sides of the line \bar{h}_{n-1} . Hence $h_0h_{n-2}\bar{h}_{n-1} \& h_{n-2}\bar{h}_{n-1}h_n \xrightarrow{\text{L1.2.18.5}} h_0\bar{h}_{n-1}h_n$. Since the angles $\angle(h_0, h_{n-1}), \angle(h_{n-1}, h_n)$ are both acute, ⁵⁹⁵ by C 1.3.18.12 we can write $h_{n-1} \subset \text{Int}\angle(h_0, h_n)$, or, in different notation, $[h_0h_{n-1}h_n]$. Taking into account that $[h_0h_{n-1}O_B] \xrightarrow{\text{L1.2.21.11}} h_0\bar{h}_{n-1}O_B$, we have $h_0\bar{h}_{n-1}h_n \& h_0\bar{h}_{n-1} \xrightarrow{\text{L1.2.18.4}} O_Bh_n\bar{h}_{n-1} \xrightarrow{\text{L1.2.21.21}} [h_{n-1}h_nO_B] \vee [h_{n-1}O_Bh_n]$. We have to exclude the first of these alternatives, for choosing it would give: $[h_0h_{n-1}O_B] \& [h_{n-1}h_nO_B] \xrightarrow{\text{L1.2.21.27}} [h_0h_nO_B]$, contrary to our assumption. Thus, we have $[h_{n-1}O_Bh_n]$, whence $[h_0h_{n-1}h_n] \& [h_{n-1}O_Bh_n] \xrightarrow{\text{L1.2.21.27}} [h_0O_Bh_n] \xrightarrow{\text{L??}} \angle A_0OB < \angle(h_0, h_n)$. Divide the angle $\angle A_0OB$ into 2^n congruent angles. The straight angle $\angle COD$ then turns out to be divided into 2^{n+2} congruent angles. Since $2^{n+2} > n$ and $\angle(h_0, h_n) < \angle COD$, using C 1.3.52.10 we see that these angles are less than $\angle(h, k)$.

Corollary 1.4.18.2. *Given an arbitrary angle $\angle(h, k)$, any other angle can be divided into congruent angles less than $\angle(h, k)$.*

Corollary 1.4.18.3. *Given two (arbitrary) overextended angles $(\angle(h, k), p_1), (\angle(l, m), p_2)$, there is a natural number $n \in \mathbb{N}$ such that $n(\angle(h, k), p_1) > n(\angle(l, m), p_2)$.*

Theorem 1.4.19. *Suppose $\angle(h_1, k_1), \angle(h_2, k_2), \dots, \angle(h_n, k_n), \dots$ is a nested sequence of angles with common vertex. That is, the angles $\angle(h_1, k_1), \angle(h_2, k_2), \dots, \angle(h_n, k_n), \dots$ of the sequence all share the same vertex O and we have*

⁵⁹²Observe that under our assumption that all rays h_i , for $i \in \mathbb{N}$, lie inside the angle $\angle A_0OB$, all these rays lie on the same side of the line a_{OC} .

⁵⁹³The reader can refer to L 1.2.31.14 to convince himself of this.

⁵⁹⁴That is, h_j lies inside $\angle(h_i, h_k)$ iff either $i < j < k$ or $k < j < i$ (see p. 65).

⁵⁹⁵In fact, we have $h_{n-1} \subset \text{Int}\angle A_0OB, A_0 \subset \text{Int}\angle COB$. This implies, respectively, $\angle(h_0, h_{n-1}) < \angle A_0OB, \angle A_0OB < \angle COB$, which together give (in view of transitivity of the relation $<$, demonstrated in L 1.3.16.8) $\angle(h_0, h_{n-1}) < \angle COB$. But $\angle COB$ is a right angle, so it follows that $\angle(h_0, h_{n-1})$ is acute. \square

$Int\angle(h_1, k_1) \cup \mathcal{P}_{\angle(h_1, k_1)} \supset Int\angle(h_2, k_2) \cup \mathcal{P}_{\angle(h_2, k_2)} \supset \dots \supset Int\angle(h_n, k_n) \cup \mathcal{P}_{\angle(h_n, k_n)} \supset \dots$ ⁵⁹⁶ Suppose, further, that for whatever angle $\angle(h, k)$ (given in advance) there is a lesser angle in the sequence $\angle(h_1, k_1), \angle(h_2, k_2), \dots, \angle(h_n, k_n), \dots$. That is, given any $\angle(h, k)$ there is $n \in \mathbb{N}$ such that $\angle(h_n, k_n) < \angle(h, k)$. Then there is a ray l with origin O such that for all the angles of the sequence $\angle(h_1, k_1), \angle(h_2, k_2), \dots, \angle(h_n, k_n), \dots$ the ray l either lies inside or coincides with the side, i.e. $\forall n \in \mathbb{N} l \subset Int\angle(h_n, k_n)$.

Proof. (See Fig. 1.175.) Take points $A_1 \in h_1, B_1 \in k_1$. Consider the rays h_2, k_2 . ⁵⁹⁷ It is easy to show that they necessarily meet the closed interval $[A_1B_1]$ in the points which we will denote A_2, B_2 , respectively (see L 1.2.37.12, L 1.2.21.10).

Of the two orders of points possible on the line a (see T 1.2.14) containing the points A_1, B_1 , we shall choose the one where the point A_1 precedes the point B_1 . It is easy to show that the notation for the points $A_1, A_2, \dots, A_n, \dots$ and $B_1, B_2, \dots, B_n, \dots$, as well as, ultimately, for the rays $h_1, h_2, \dots, h_n, \dots$ and $k_1, k_2, \dots, k_n, \dots$, can then be chosen in such a way that $A_1 \preceq A_2 \preceq A_n \prec B_n \preceq B_2 \preceq B_1$ for any $n \in \mathbb{N}$. Denote $\mathcal{A} = \{A_i | i \in \mathbb{N}\}$, $A = \sup \mathcal{A}$; $\mathcal{B} = \{B_i | i \in \mathbb{N}\}$, $B = \inf \mathcal{B}$.

⁵⁹⁸

Since $\mathcal{A} \neq \emptyset, \mathcal{B} \neq \emptyset$, and $(\forall A \in \mathcal{A})(\forall B \in \mathcal{B})(A \prec B)$, from T 1.4.18 there is a point P such that $(\forall A \in \mathcal{A})(\forall B \in \mathcal{B})(A \preceq P \preceq B)$. Then from the properties of the precedence relation (see T 1.2.14) it follows that the point P lies on all the closed intervals $[A_iB_i], i \in \mathbb{N}$. This, in view of L 1.2.21.6, L 1.2.21.4, L 1.2.11.3 implies that for all $i \in \mathbb{N}$ the ray OP lies on all the closed angular intervals $[h_i, k_i]$. In other words, for all $i \in \mathbb{N}$ the ray OP either lies completely inside the angle $\angle(h_i, k_i)$, or coincides with one of the rays h_i, k_i . ⁵⁹⁹ \square

Theorem 1.4.20. We can put into correspondence with every extended angle $\angle(h, k)$ a unique real number $|\angle(h, k)|$, $0 < |\angle(h, k)| \geq \pi$, referred to as its (numerical ⁶⁰⁰) measure. Furthermore, for a straight angle $\angle(h, h^c)$ we have $|\angle(h, h^c)| = \pi$, and for any angle $\angle(h, k)$ which is not straight, we have $0 < |\angle(h, k)| < \pi$.

Proof. We let $b = \pi$ in the generalized treatment of measurement construction. The theorem then follows from L 1.4.18.1, T 1.4.19, Pr 1.4.1, Pr 1.4.2. \square

Theorem 1.4.21. Congruent angles have equal measures.

Proof. \square

Theorem 1.4.22. If an angle $\angle(h', k')$ is less than an extended angle $\angle(h, k)$ then $|\angle(h', k')| < |\angle(h, k)|$.

Proof. \square

Corollary 1.4.22.1. If $|\angle(h', k')| = |\angle(h, k)|$ then $\angle(h', k') \equiv \angle(h, k)$. \square

Corollary 1.4.22.2. If $|\angle(h', k')| < |\angle(h, k)|$ then $\angle(h', k') < \angle(h, k)$. \square

Theorem 1.4.23. If a ray l lies inside an extended angle $\angle(h, k)$, the measure of $\angle(h, k)$ is the sum of the measures of the angles $\angle(h, l), \angle(h, k)$, i.e. $|\angle(h, k)| = |\angle(h, l)| + |\angle(l, k)|$.

Proof. \square

Corollary 1.4.23.1. If a class $\mu\angle(h, k)$ of extended angles is the sum of classes of congruent angles $\mu\angle(l, m), \mu\angle(p, q)$ (i.e. if $\mu\angle(h, k) = \mu\angle(l, m) + \mu\angle(p, q)$), then for any angles $\angle(h_1, k_1) \in \mu\angle(h, k), \angle(l_1, m_1) \in \mu\angle(l, m), \angle(p_1, q_1) \in \mu\angle(p, q)$ we have $|\angle(h_1, k_1)| = |\angle(l_1, m_1)| + |\angle(p_1, q_1)|$.

⁵⁹⁶It would be more precise to call $\angle(h_1, k_1), \angle(h_2, k_2), \dots, \angle(h_n, k_n), \dots$ a nested sequence of set-theoretical complements of angle exteriors. We, however, prefer shorter, albeit somewhat misleading, description.

⁵⁹⁷Note that we do not assume h_2, k_2 to be distinct from h_1, k_1 , although we still need to assume that $h_i \neq k_i$ for all $i \in \mathbb{N}$ for the corresponding angles to exist.

⁵⁹⁸Without T 1.4.18 this theorem can be proved by the following lengthy argument. While being absolutely redundant (it can be replaced by a mere reference to T 1.4.18 and thus rendered useless) and having substantial overlaps with the proofs of T 1.4.17, T 1.4.18, it might still help to clarify some points. Observe that any of the points $B_1, B_2, \dots, B_n, \dots$ may serve as an upper bound for the set $\mathcal{A} = \{A_i | i \in \mathbb{N}\}$. Similarly, any of the points $A_1, A_2, \dots, A_n, \dots$ may serve as a lower bound for the set $\mathcal{B} = \{B_i | i \in \mathbb{N}\}$. Evidently, $A \preceq B$. To show that actually $A = B$ suppose the contrary, i.e. $A \prec B$. Taking two (distinct) points C, D on the open interval (AB) (see C 1.2.8.2), we see that the angle $\angle COD$ is then less than any angle of the sequence $\angle(h_1, k_1), \angle(h_2, k_2), \dots, \angle(h_n, k_n), \dots$ (by L 1.2.21.6, L 1.2.21.4, C 1.3.16.4), contrary to hypothesis. Taking an arbitrary interval, construct an interval EF congruent to it, such that the points E, F lie on a , and the point $A = B$ lies between them. This can be done as follows: Choose $E \in A_{A_1}$ so that EA is shorter than the given interval (see comment following L 1.3.13.3). Then choose $F \in E_A$ such that EF is congruent to the given interval. Evidently, we have $[EAF]$ (see L 1.3.13.3, T 1.3.2). Since $E \prec A \prec F$ (recall that if $A_1 \prec A$ in the chosen order, as it is in our case, the ray A_{A_1} is the collection of points preceding A), $A = \sup\{A_i | i \in \mathbb{N}\} = B = \inf\{B_i | i \in \mathbb{N}\}$, from the definitions of least upper bound and greatest lower bound we conclude that there are points $G \in \mathcal{A}, H \in \mathcal{B}$ such that $E \prec G \preceq A = B \preceq H \prec F$. Since $E \prec G \prec F \Rightarrow [EGF]$, $E \prec H \prec F \Rightarrow [EHF]$ (see T 1.2.14), in view of L 1.3.13.3 we have $GH \prec EF$. Thus, for any given interval we can find a shorter one in the sequence $A_iB_i, i \in \mathbb{N}$. Hence by Cantor's axiom there is a point P lying on all the closed intervals $[A_iB_i], i \in \mathbb{N}$. But, obviously, so does also $A = B$. Since, in view of L 1.4.1.4, there is exactly one point with this property, we have $P = A = B$.

⁵⁹⁹Using L 1.3.16.4 it can be seen independently that the ray OP with this property is unique, for if there were another such ray OQ , the (fixed) angle $\angle POQ$ would be less than any angle $\angle(h_i, k_i), i \in \mathbb{N}$.

⁶⁰⁰In contrast to an "abstract measure" which can be defined as a class of equivalence of congruent extended angles.

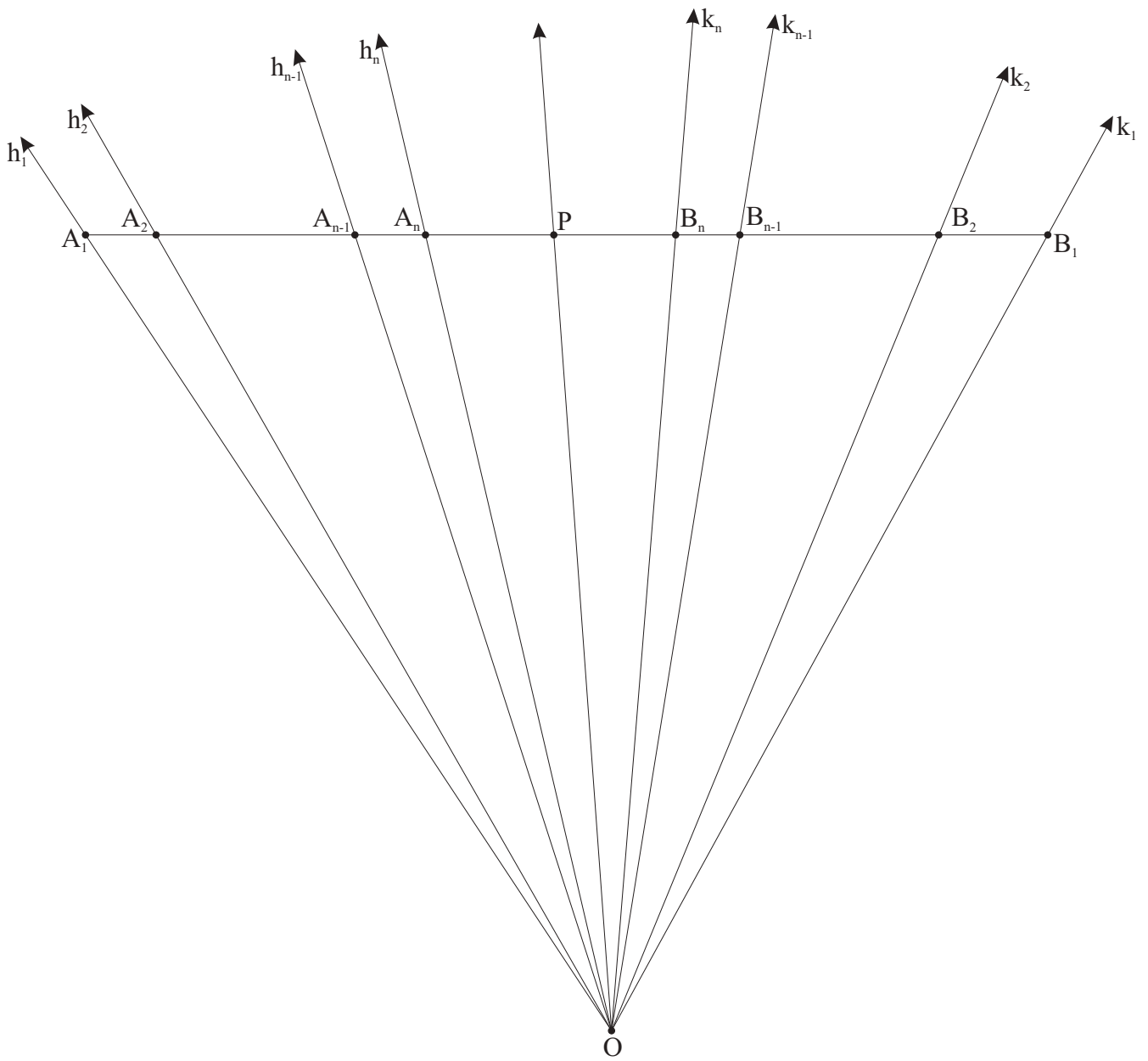

Figure 1.175:

Proof. See T 1.4.21, T 1.4.23. \square

Corollary 1.4.23.2. *If a class $\mu\angle(h, k)$ of congruent extended is the sum of classes of congruent angles $\mu\angle(h_1, k_1), \mu\angle(h_2, k_2), \dots, \mu\angle(h_n k_n)$ (i.e. if $\mu\angle(h, k) = \mu\angle(h_1 k_1) + \mu\angle(h_2 k_2) + \dots + \mu\angle(h_n k_n)$), then for any angles $\angle(l, m) \in \mu\angle(h, k)$, $\angle(l_1, m_1) \in \mu\angle(h_1, k_1), \angle(l_2, m_2) \in \mu\angle(h_2, k_2), \dots, \angle(l_n, m_n) \in \mu\angle(h_n k_n)$ we have $|\angle(l, m)| = |\angle(l_1, m_1)| + |\angle(l_2, m_2)| + \dots + |\angle(l_n, m_n)|$. In particular, if $\mu\angle(h, k) = n\mu\angle(h_1, k_1)$ and $\angle(l, m) \in \mu\angle(h, k)$, $\angle(l_1, m_1) \in \mu\angle(h_1, k_1)$, then $|\angle(l, m)| = n|\angle(l_1, m_1)|$.⁶⁰¹*

Theorem 1.4.24. *For any real number x such that $0 < x \leq \pi$ there is an angle $\angle(h, k)$ (and, in fact, an infinity of angles congruent to it) whose measure equals x , i.e. $|\angle(h, k)| = x$.*

The concept of angular measure can be extended to overextended⁶⁰² angles. Denote $|\angle(h, k, n)| \equiv |\angle(h, k)| + \pi n$. We see that

Theorem 1.4.25. *We can put into correspondence with every overextended angle $(\angle(h, k), n)$, $n \in \mathbb{N}^0$, a unique real number $|\angle(h, k)| > 0$, referred to as its (numerical⁶⁰³) measure.*

Theorem 1.4.26. *The abstract sum of angles of a triangle never exceeds a straight angle. That is, for any triangle $\triangle ABC$ we have $\Sigma_{\triangle ABC}^{(abs)\angle} \equiv \mu(\angle BAC, 0) + \mu(\angle ABC, 0) + \mu(\angle ACB, 0) \leq \pi^{(abs, xt)}$.*

Proof. Suppose the contrary, i.e. that there is a triangle $\triangle A'B'C'$ such that $\Sigma_{\triangle A'B'C'}^{(abs)\angle} > \pi^{(abs, xt)}$. Without any loss of generality we can assume that $\Sigma_{\triangle A'B'C'}^{(abs)\angle} = (\angle(h', k'), 1)$, where $\angle(h', k')$ is some non-straight angle. (See C 1.3.63.9.) Using P 1.3.67.8 repeatedly, we can construct a triangle $\triangle ABC$ with $\Sigma_{\triangle ABC}^{(abs)\angle} = \Sigma_{\triangle A'B'C'}^{(abs)\angle} = (\angle(h', k'), 1)$, one of whose angles $\angle A$ is less than $\angle(h', k')$. In view of C 1.3.63.9 the (abstract) sum of the remaining two angles $\angle B, \angle C$ of the triangle $\triangle ABC$ is less than $\pi^{(abs, xt)}$. Hence $\Sigma_{\triangle ABC}^{(abs)\angle} = (\angle A, 0) + (\angle B, 0) + (\angle C, 0) < (\angle(h', k'), 0) + \pi^{(abs, xt)} = (\angle(h', k'), 1) = \Sigma_{\triangle A'B'C'}^{(abs)\angle} = \Sigma_{\triangle ABC}^{(abs)\angle}$ - a contradiction which shows that in fact we always have $\Sigma_{\triangle ABC}^{(abs)\angle} \leq \pi^{(abs, xt)}$ for any triangle $\triangle ABC$. \square

Corollary 1.4.26.1. *The (abstract) sum of any two angles of a triangle is no greater than the angle, adjacent complementary to the third angle of the same triangle. That is, in any $\triangle ABC$ we have $\mu\angle A + \mu\angle B \leq \mu(\text{adjsp}\angle C)$.*

Proof. Using the preceding theorem (T 1.4.26), we can write $\mu\angle A + \mu\angle B + \mu\angle C \leq \pi^{(abs)} = \mu\angle C + \mu(\text{adjsp}\angle C)$. Hence the result follows by P 1.3.63.3, P 1.3.63.5. \square

Proposition 1.4.26.2. *Given a cevian BD in a triangle $\triangle ABC$ such that $D \in (AC)$, if the abstract sum of angles in the triangle $\triangle ABC$ equals $\pi^{(abs, xt)}$, the abstract sums of angles in the triangles $\triangle ABD, \triangle CBD$ are also both equal to $\pi^{(abs, xt)}$.*

Proof. We know that $\Sigma_{\triangle ABD}^{(abs)\angle} + \Sigma_{\triangle DBC}^{(abs)\angle} = \Sigma_{\triangle ABC}^{(abs)\angle} + \pi^{(abs, xt)}$ (see proof of P 1.3.67.9). Also, by hypothesis, $\Sigma_{\triangle ABC}^{(abs)\angle} = \pi^{(abs, xt)}$. Since, from T 1.4.26, we also have $\Sigma_{\triangle ABD}^{(abs)\angle} \leq \pi^{(abs, xt)}$, $\Sigma_{\triangle DBC}^{(abs)\angle} \leq \pi^{(abs, xt)}$, we conclude that $\Sigma_{\triangle ABD}^{(abs)\angle} = \pi^{(abs, xt)}$, $\Sigma_{\triangle DBC}^{(abs)\angle} = \pi^{(abs, xt)}$, for otherwise we would have $\Sigma_{\triangle ABD}^{(abs)\angle} + \Sigma_{\triangle DBC}^{(abs)\angle} < \Sigma_{\triangle ABC}^{(abs)\angle} + \pi^{(abs, xt)}$. \square

Corollary 1.4.26.3. *Given a $\triangle ABC$ with the abstract sum of angles equal to $\pi^{(abs, xt)}$, for any points $X \in (AB)$, $Y \in (AC)$, the abstract sum of angles of the triangle $\triangle AXY$ also equals $\pi^{(abs, xt)}$.*

Proof. Follows immediately from the preceding proposition (P 1.4.26.2). \square

Lemma 1.4.26.4. *Suppose that there is a right triangle $\triangle ABC$ whose abstract sum of angles equals $\pi^{(abs, xt)}$. Then every right triangle has abstract sum of angles equal to $\pi^{(abs, xt)}$.*

Proof. Consider an arbitrary right triangle $\triangle A'B'C'$. Using A 1.3.1 choose points $B'' \in A_B, C'' \in A_C$ such that $A'B' \equiv AB'', A'C' \equiv AC''$. Now choose B_1 such that $[ABB_1]$ and $AB \equiv BB_1$. Continuing this process, we can construct inductively a sequence of points $B_1, B_2, \dots, B_n, \dots$ on the ray A_B as follows: choose B_n such that $[AB_{n-1}B_n]$ and $AB_{n-1} \equiv B_{n-1}B_n$. Evidently, for the construction formed in this way we have $\mu AB_{n+1} = 2\mu AB_n$ for all $n \in \mathbb{N}$, where the points $A, B, B_1, B_2, \dots, B_n, \dots$ are in order $[ABB_1B_2 \dots B_n \dots]$ (see also L 1.3.21.11). Since $\mu AB_n = 2^n \mu AB$ for all $n \in \mathbb{N}$, Archimedes' axiom (A 1.4.1) guarantees that there is $l \in \mathbb{N}$ such that $[AB''B_l]$.⁶⁰⁴ Similarly, we can choose C_1 such that $[ACC_1]$ and $AC \equiv CC_1$. Then we go on to construct inductively a sequence of points $C_1, C_2, \dots, C_n, \dots$ on the ray A_C as follows: choose C_n such that $[AC_{n-1}C_n]$ and $AC_{n-1} \equiv C_{n-1}C_n$. Again, we have $\mu AC_{n+1} = 2\mu AC_n$ for all $n \in \mathbb{N}$, where the points $A, C, C_1, C_2, \dots, C_n, \dots$ are in order $[ACC_1C_2 \dots C_n \dots]$ (see also L 1.3.21.11). Since $\mu AC_n = 2^n \mu AC$ for all $n \in \mathbb{N}$, Archimedes' axiom (A 1.4.1) again ensures that there is $m \in \mathbb{N}$ such that $[AC''C_m]$. Consider the triangle $\triangle AB_l C_m$. From the way its sides AB_l, AC_m were constructed

⁶⁰¹ Obviously, $\mu\angle(h, k) = (1/n)\mu\angle(h_1, k_1)$ and $\angle(l, m) \in \mu\angle(h, k)$, $\angle(l_1, m_1) \in \mu\angle(h_1, k_1)$ then imply $|\angle(l, m)| = (1/n)|\angle(l_1, m_1)|$.

⁶⁰² No pun intended.

⁶⁰³ In contrast to an "abstract measure" which can be defined as a class of equivalence of congruent overextended angles.

⁶⁰⁴ Basically, Archimedes' axiom and its immediate corollaries assert that for any two intervals AB, CD there is always a positive integer n such that $\mu AB < n\mu CD$. Then, of course, $\mu AB < 2^n \mu CD$.

using P 1.3.67.10 we have $\Sigma_{\triangle AB_l C_m}^{(abs)\angle} = \pi^{(abs,xt)}$. Since $B_l \in (AB'']$, $C_m \in (AC''']$, in view of the preceding corollary (C 1.4.26.3) we conclude that the abstract sum of angles of the triangle $\triangle AB''C''$, as well as the abstract sum of the triangle $\triangle A'B'C'$ congruent to $\triangle AB''C''$ by T 1.3.4, is equal to $\pi^{(abs,xt)}$. \square

Corollary 1.4.26.5. *Any birectangle has at least one acute angle.*

Proof. See T 1.4.26, T 1.3.67, T 1.3.68. \square

Theorem 1.4.27. *Suppose that there is a triangle $\triangle ABC$ whose abstract sum of angles equals $\pi^{(abs,xt)}$. Then every triangle has abstract sum of angles equal to $\pi^{(abs,xt)}$.*

Proof. We can assume without loss of generality that the angle $\angle A$ is acute.⁶⁰⁵ Then by P 1.3.24.2 the foot D of the altitude BD in $\triangle ABC$ lies between A, C . Consider also an arbitrary triangle $A'B'C'$ with the altitude $B'D'$ such that $D' \in (AC)$. From P 1.4.26.2 the abstract sum of angles of the right triangle $\triangle ABD$ is $\pi^{(abs,xt)}$. But then, by the preceding lemma (L 1.4.26.4) every right triangle has the same abstract sum of angles, and this applies, in particular, to the right triangles $\triangle A'B'D'$, $\triangle C'B'D'$. Hence from P 1.3.67.9 $\Sigma_{\triangle A'B'C'}^{(abs)\angle} = \pi^{(abs,xt)}$, as required. \square

Theorem 1.4.28. *Suppose every triangle has abstract sum of angles equal to $\pi^{(abs,xt)}$. Then for any line a and any point A not on it, in the plane α_{aA} there is exactly one line a' through A parallel to a .*

Proof. Consider a line a and a point A not on it. Denote by B the foot of the perpendicular to a drawn through A (see L 1.3.8.1). Draw through A the line a' perpendicular to a_{AB} (see L 1.3.8.3). By C 1.3.26.2 the lines a, a' are parallel. We need to show that any line other than a' , drawn through A , meets a in some point. Denote by h the ray with initial point A lying on such a line $b \neq a'$. We can assume without loss of generality that the ray h lies inside the angle $\angle BAA_1$, where $A_1 \in a'$.⁶⁰⁶ Construct now a sequence of points $B_1, B_2, \dots, B_n, \dots$ as follows: Choose a point B_1 so that A_1, B_1 lie on the same side of the line a_{AB} and $AB \equiv BB_1$. Then choose a point B_2 so that $[BB_1B_2]$ and $BB_1 \equiv B_1B_2$. At the n^{th} , where $n \in \mathbb{N}$, step of the construction we choose B_n so that $[B_{n-2}B_{n-1}B_n]$, and $AB_{n-1} \equiv B_{n-1}B_n$. Hence from T 1.3.3 we have $\angle BAB_1 \equiv \angle BB_1A, \angle B_1AB_2 \equiv \angle B_1B_2A, \dots, \angle B_{n-1}AB_n \equiv \angle B_{n-1}B_nA, \dots$. According to hypothesis, all the triangles involved have the same abstract sum of angles equal to $\pi^{(abs,xt)}$. This fact will be used throughout the proof. Since, from construction, $\angle ABB_1$ is a right angle, in view of $\angle BAB_1 \equiv \angle BB_1A$ we have $\mu\angle BAB_1 = \mu\angle BB_1A = (1/4)\pi^{(abs)}$. Observe also the following interesting fact: since $A_{B_1} \subset \text{Int}\angle BAA_1$,⁶⁰⁷ we have $\mu\angle BAB_1 + \mu\angle B_1AA_1 = \mu\angle BAA_1$. In view of $\mu\angle BAA_1 = (1/2)\pi^{(abs)}$, we obtain $\mu\angle B_1AA_1 = (1/4)\pi^{(abs)}$. Since $\mu\angle AB_1B = \mu\angle B_1AB_2 + \mu\angle AB_2B_1$ (in view of P 1.3.67.11) and $\mu\angle AB_1B = (1/4)\pi^{(abs)}$, we have $\mu\angle B_1AB_2 = \mu\angle AB_2B_1 = (1/8)\pi^{(abs)}$. It is easy to see that $A_{B_2} \subset B_1AA_1$ (see below), and thus $\mu\angle B_1AA_1 = \mu\angle B_1AB_2 + \mu\angle A_1AB_2$. Since $\mu\angle B_1AA_1 = (1/4)\pi^{(abs)}$ and $\mu\angle B_1AB_2 = (1/8)\pi^{(abs)}$, this implies $\mu\angle B_2AA_1 = (1/8)\pi^{(abs)}$. Continuing inductively, suppose that $\mu\angle B_{n-2}AB_{n-1} = \mu\angle B_{n-1}AA_1 = (1/2^n)\pi^{(abs)}$. Observe that by L 1.2.21.31 the rays $A_B, A_{B_1}, A_{B_2}, \dots, A_{B_n}A_{A_1}$ are in order $[A_BA_{B_1}A_{B_2} \dots A_{B_n}A_{A_1}]$. Since $\angle B_{n-2}AB_{n-1} \equiv \angle AB_{n-1}B_{n-2}, \angle B_{n-1}AB_n \equiv \angle AB_nB_{n-1}, \mu\angle B_{n-2}B_{n-1}A = \mu\angle B_{n-1}AB_n + \mu\angle AB_nB_{n-1}, \angle B_{n-1}AA_1 = \mu\angle B_{n-1}AB_n + \mu\angle B_nAA_1$, we find that $\mu\angle B_nAA_1 = \mu\angle B_{n-1}AB_n = (1/2^{n+1})\pi^{(abs)}$. We see that with increasing number n the angle $\angle B_nAA_1$ can be made smaller than any given angle. In particular, it can be made smaller than the angle $\angle DAA_1$. Hence the ray A_{B_n} lies inside the angle $\angle DAA_1$ (see C 1.3.16.4). In view of L 1.2.21.27 this amounts to the ray A_D lying inside the angle $\angle BAB_n$. Hence by L 1.2.21.27 the ray A_D meets the open interval (BB_n) and thus the line a containing it. \square

Theorem 1.4.29. *Given an interval EF and a non-acute (that is, either right or obtuse) angle $\angle(h, k)$ with a point $A \in k$, there is a unique point $B \in h$ on its other side, such that $AB \equiv EF$.*

Proof. Of the two possible orders on \bar{h} we take the one in which the vertex O of $\angle(h, k)$ precedes any point of the ray h . It is easy to see that the sets $\mathcal{A} \equiv h^c \cup \{O\} \cup \{P|P \in h \ \& \ (AP < EF \vee AP \equiv EF)\}$ and $\mathcal{B} \equiv \{P|AP > F\}$ define a Dedekind cut in the set of points of the line \bar{h} (use C 1.3.18.4). Denote by B the point which makes this cut (see T 1.3.17). We have either $AB < EF$, or $AB > EF$, or $AB \equiv EF$. Suppose first $AB < EF$. Taking a point C such that $[OBC]$ (or, equivalently, $B \prec C$), $BC \in \mu EF - \mu AB$, and using the triangle inequality (P 1.3.40.9) we can write $\mu AC < \mu AB + \mu BC = \mu AB + (\mu EF - \mu AB) = \mu EF$ (see also P 1.3.40.7), whence $C \in \mathcal{A}$ and $C \preceq B$ (for B makes the cut), in contradiction to our choice of the point C . Suppose now $AB > EF$. Taking a point D such that $[ODB]$ and $BD \in \mu AB - \mu EF$, we can write $\mu AD > \mu AB - \mu BD = \mu AB - (\mu AB - \mu EF) = \mu EF$ (see P 1.3.40.8, P 1.3.40.9), whence $D \in \mathcal{B}$ and $B \preceq D$, in contradiction to our choice of the point D . Thus, the contradictions we have arrived to show that $AB \equiv EF$, as required. \square

⁶⁰⁵In fact, in any triangle at least two angles are acute.

⁶⁰⁶We choose h to be that ray with the initial point A which lies on the same side of a' as the point B (see, in particular, L 1.2.19.8). Then we take a point $A_1 \in a'$ such that this point and the ray h lie on the same side of the line a_{AB} . Evidently, with h and A_1 so chosen, we have $h \subset \text{Int}\angle BAA_1$.

⁶⁰⁷Note that the points A_1, B_1 , and thus the rays A_{A_1}, A_{B_1} lie on the same side of the line a_{AB} by construction. The points B, B_1 , and, consequently, the rays A_B, A_{B_1} lie on the same side of the line a . Hence $A_{B_1} \subset \text{Int}\angle BAA_1$, as stated.

We are now ready to extend our knowledge of continuity properties on a line to sets with generalized betweenness relation.

Consider a class \mathcal{C}^{gbr} of sets \mathfrak{J} with generalized betweenness relation. We assume that the sets \mathfrak{J} , whose elements are pairs $\mathcal{AB} = \{\mathcal{A}, \mathcal{B}\}$ of geometric objects satisfying Pr 1.3.1 – Pr 1.3.5, are equipped with a relation of generalized congruence (see p. 46). We assume further that the generalized abstract intervals involved (elements of the set \mathfrak{J}) have the properties Pr 1.4.1, Pr 1.4.2.

It is also understood that on every set $\mathfrak{J} \in \mathcal{C}^{gbr}$ one of the two possible opposite orders is chosen (see p. 54 ff.). Given such a set \mathfrak{J} with order \prec and a (non-empty) set $\mathfrak{A} \subset \mathfrak{J}$, we call a geometric object $\mathcal{B} \in \mathfrak{J}$ an upper bound (respectively, lower bound) of \mathfrak{A} iff $\mathcal{A} \preceq \mathcal{B}$ ($\mathcal{B} \preceq \mathcal{A}$) for all $\mathcal{A} \in \mathfrak{A}$. An upper bound \mathcal{B}_0 is called a least upper bound, or supremum, written $\sup \mathfrak{A}$ (greatest lower bound, or infimum, written $\inf \mathfrak{A}$) of \mathfrak{A} iff $\mathcal{B}_0 \preceq \mathcal{B}$ for any upper bound \mathcal{B} of \mathfrak{A} . Thus, $\sup \mathfrak{A}$ is the least element in the set of upper bounds of \mathfrak{A} , and $\inf \mathfrak{A}$ is the greatest element in the set of lower bounds of \mathfrak{A} . Obviously, the second requirement in the definition of least upper bound (namely, that $\mathcal{B}_0 \preceq \mathcal{B}$ for any upper bound \mathcal{B} of \mathfrak{A}) can be reformulated as follows: For whatever geometric object $\mathcal{B}' \in \mathfrak{J}$ preceding \mathcal{B}_0 (i.e. such that $\mathcal{B}' \prec \mathcal{B}_0$) there is a geometric object \mathcal{X} succeeding \mathcal{B}' (i.e. with the property that $\mathcal{X} \succ \mathcal{B}'$).

It is also convenient to assume, unless explicitly stated otherwise, that for a generalized interval \mathcal{AB} we have $\mathcal{A} \prec \mathcal{B}$.⁶⁰⁸ With this convention in mind, we can view the open generalized interval (\mathcal{AB}) as the set $\{\mathcal{X} | \mathcal{A} \prec \mathcal{X} \prec \mathcal{B}\}$ (see T 1.2.28). Also, obviously, we have $[\mathcal{AB}] = \{\mathcal{X} | \mathcal{A} \preceq \mathcal{X} \preceq \mathcal{B}\}$, $(\mathcal{AB}) = \{\mathcal{X} | \mathcal{A} \prec \mathcal{X} \prec \mathcal{B}\}$, $[\mathcal{AB}] = \{\mathcal{X} | \mathcal{A} \preceq \mathcal{X} \preceq \mathcal{B}\}$. A generalized ray $\mathcal{O}_{\mathcal{A}}$ may be viewed as the set of all such geometric objects \mathcal{X} that $\mathcal{O} \prec \mathcal{X}$ (or $\mathcal{X} \succ \mathcal{O}$, which is the same) if $\mathcal{O} \prec \mathcal{A}$, and as the set of all such geometric objects \mathcal{X} that $\mathcal{X} \prec \mathcal{O}$ if $\mathcal{A} \prec \mathcal{O}$. Moreover, if $\mathcal{X} \in \mathcal{O}_{\mathcal{A}}$ then either $\mathcal{O} \prec \mathcal{X} \preceq \mathcal{A}$ or $\mathcal{A} \prec \mathcal{X}$.⁶⁰⁹ These facts will be extensively used in the succeeding exposition.⁶¹⁰

Theorem 1.4.30. *If a non-empty set of geometric objects \mathfrak{A} on a set \mathfrak{J} has an upper bound (respectively, a lower bound), it has a least upper bound (greatest lower bound).*⁶¹¹

*Proof.*⁶¹²

By hypothesis, there is a geometric object $\mathcal{B}_1 \in \mathfrak{J}$ such that $\mathcal{A} \preceq \mathcal{B}_1$ for all $\mathcal{A} \in \mathfrak{A}$. Without loss of generality we can assume that $\mathcal{A} \prec \mathcal{B}_1$ for all $\mathcal{A} \in \mathfrak{A}$.⁶¹³

We shall refer to a generalized interval \mathcal{XY} as normal iff:

a) there is $\mathcal{A} \in \mathfrak{A}$ such that $\mathcal{A} \in [\mathcal{XY}]$; and b) for all $\mathcal{B} \in \mathfrak{J}$ the relation $\mathcal{B} \succ \mathcal{Y}$ implies $\mathcal{B} \notin \mathfrak{A}$. Observe that at least one of the halves⁶¹⁴ of a normal generalized interval is normal.⁶¹⁵

Take an arbitrary geometric object $\mathcal{A}_1 \in \mathfrak{A}$. Then, evidently, the generalized interval $\mathit{mathcal{A}}_1\mathcal{B}_1$ is normal. Denote by $\mathcal{A}_2\mathcal{B}_2$ its normal half. Continuing inductively this process of division of generalized intervals into halves, we denote $\mathcal{A}_{n+1}\mathcal{B}_{n+1}$ a normal half of the generalized interval $\mathcal{A}_n\mathcal{B}_n$. With the sequence of generalized intervals thus constructed, there is a unique geometric object \mathcal{C} lying on all the generalized closed intervals $[\mathcal{A}_i\mathcal{B}_i]$, $i \in \mathbb{N}$ (see L 1.4.11.1, T 1.4.11). This can be written as $\{\mathcal{C}\} = \bigcap_{i=0}^{\infty} [\mathcal{A}_i\mathcal{B}_i]$.

We will show that $\mathcal{C} = \sup \mathfrak{A}$. First, we need to show that \mathcal{C} is an upper bound of \mathfrak{A} . If \mathcal{C} were not an upper bound of \mathfrak{A} , there would exist a geometric object $\mathcal{A}_0 \in \mathfrak{A}$ such that $\mathcal{C} < \mathcal{A}_0$. But then $\mathcal{A}_0 \notin \bigcap_{i=0}^{\infty} [\mathcal{A}_i\mathcal{B}_i] = \{\mathcal{C}\}$, whence we would have $\exists n_0 \in \mathbb{N} (\mathcal{A}_{n_0} \leq \mathcal{C} \leq \mathcal{B}_{n_0} < \mathcal{A}_0)$, i.e. the closed generalized interval $[\mathcal{A}_{n_0}\mathcal{B}_{n_0}]$ cannot be normal - a contradiction. Thus, we have $\forall \mathcal{A} \in \mathfrak{A} (\mathcal{A} \preceq \mathcal{C})$. In order to establish that $\mathcal{C} = \sup \mathfrak{A}$, we also need to prove that given any $\mathcal{X}_1 \in \mathfrak{J}$ with the property $\mathcal{X}_1 \prec \mathcal{C}$, there is a geometric object $\mathcal{A} \in \mathfrak{A}$ such that $\mathcal{X}_1 \prec \mathcal{A}$ (see the discussion accompanying the definition of least upper bound).

Observe that for any $\mathcal{X}_1 \in \mathfrak{J}$ with the property $\mathcal{X}_1 \prec \mathcal{C}$ there is a number $n_1 \in \mathbb{N}$ such that $\mathcal{X}_1 \prec \mathcal{A}_{n_1} \preceq \mathcal{C} \preceq \mathcal{B}_{n_1}$. Otherwise (if $\mathcal{A}_n \preceq \mathcal{X}_1$ for all $n \in \mathbb{N}$) we would have $\mathcal{X}_1 \in \bigcap_{i=0}^{\infty} [\mathcal{A}_i\mathcal{B}_i] = \{\mathcal{C}\} \Rightarrow \mathcal{X}_1 = \mathcal{C}$, which contradicts $\mathcal{X}_1 \prec \mathcal{C}$. But then in view of normality of $[\mathcal{A}_{n_1}\mathcal{B}_{n_1}]$ there is $\mathcal{A} \in \mathfrak{A}$ such that $\mathcal{A} \in [\mathcal{A}_{n_1}\mathcal{B}_{n_1}]$, i.e. $\mathcal{A}_{n_1} \preceq \mathcal{A} \preceq \mathcal{B}_{n_1}$. Together with $\mathcal{X}_1 \prec \mathcal{A}_{n_1}$, this gives $\mathcal{X}_1 \prec \mathcal{A}$, whence the result. \square

Theorem 1.4.31 (Dedekind). *Let \mathfrak{A} , \mathfrak{B} be two non-empty subsets of \mathfrak{J} such that $\mathcal{A} \cup \mathcal{B} = \mathfrak{J}$. Suppose, further, that any element of the set \mathfrak{J} (strictly) precedes any element of the set \mathfrak{B} , i.e. $(\forall \mathcal{A} \in \mathfrak{A})(\forall \mathcal{B} \in \mathfrak{B})(\mathcal{A} \prec \mathcal{B})$. Then either*

⁶⁰⁸That is, the geometric object denoted by the letter written first in the notation of the generalized interval precedes in the chosen order the point designated by the letter written in the second position.

⁶⁰⁹This can be shown either referring to L 1.2.29.4, or directly using the facts presented above.

⁶¹⁰Basically, they mean that we can work with order on sets of geometric objects in a set with generalized betweenness relation just like we are accustomed to work with order on sets of "points" (numbers) on the "real line".

⁶¹¹The arguments in the proof of this and the following two theorems are completely similar to those used to establish the corresponding results for real numbers in calculus.

⁶¹²The proof will be done for upper bound. The case of lower bound is completely analogous to the lower bound case.

⁶¹³In fact, in the case where $\mathcal{A} \prec \mathcal{B}_1$ for all $\mathcal{A} \in \mathfrak{A}$ we would immediately have $\mathcal{B}_1 = \sup \mathfrak{A}$, and the proof would be complete.

⁶¹⁴If \mathcal{D} is the midpoint of the generalized interval \mathcal{AB} , the generalized intervals \mathcal{AD} , \mathcal{DB} are (as sometimes are generalized intervals congruent to them) referred to as the halves of \mathcal{AB} .

⁶¹⁵In fact, if $\mathcal{A} \in [\mathit{mathcal{A}}\mathcal{X}\mathcal{Y}]$ and $\mathcal{M} = \text{mid}\mathcal{XY}$, then either $\mathcal{A} \in [\mathcal{X}\mathcal{M}]$ or $\mathcal{A} \in [\mathit{mathcal{A}}\mathcal{M}\mathcal{Y}]$ (see L 1.2.22.8). If $\mathcal{A} \in [\mathcal{M}\mathcal{Y}]$ then the second condition in the definition of normal generalized interval is unchanged, so that it holds for \mathcal{MY} if it does for \mathcal{XY} . If $\mathcal{A} \notin [\mathcal{M}\mathcal{Y}]$ then necessarily $\mathcal{A} \in [\mathcal{X}\mathcal{M}]$. In this case the relation $\mathcal{B} \succ \mathcal{M}$ (together with $\mathcal{X} \prec \mathcal{M} \prec \mathcal{Y}$) implies that either $\mathcal{M} \prec \mathcal{B} \preceq \mathcal{Y}$ (which amounts to $\mathcal{B} \in (\mathcal{M}\mathcal{Y})$), or $\mathcal{B} \succ \mathcal{Y}$.

there is a geometric object \mathcal{C} such that all geometric objects in \mathfrak{A} precede \mathcal{C} , or there is a geometric object \mathcal{C} such that \mathcal{C} precedes all geometric objects in \mathfrak{B} .

In this case we say that the geometric object \mathcal{C} makes a Dedekind cut in \mathfrak{J} . We can also say that \mathfrak{A} , \mathfrak{B} define a Dedekind cut in \mathfrak{J} .

Proof. Since \mathfrak{A} is not empty and has an upper bound, by the preceding theorem (T ??) it has the least upper bound $\mathcal{C} = \sup \mathfrak{A}$.

Observe that $\mathfrak{A} \cap \mathfrak{B} = \emptyset$. Otherwise we would have (by hypothesis) $\mathcal{A}_0 \in \mathfrak{A} \cap \mathfrak{B} \Rightarrow (\mathcal{A}_0 \in \mathfrak{A}) \& \mathfrak{B} \Rightarrow \mathcal{A}_0 \prec \mathcal{A}_0$, which is impossible.

Since $\mathfrak{A} \cap \mathfrak{B} = \emptyset$, we have either $\mathcal{C} \in \mathfrak{A}$, or $\mathcal{C} \in \mathfrak{B}$, but not both. If $\mathcal{C} \in \mathfrak{A}$ then $(\forall \mathcal{A} \in \mathfrak{A})(\mathcal{A} \preceq \mathcal{C})$ because $\mathcal{C} = \sup \mathfrak{A}$. Suppose now $\mathcal{C} \in \mathfrak{B}$. To show that $(\forall \mathcal{B} \in \mathfrak{B})(\mathcal{C} \prec \mathcal{B})$ suppose the contrary, i.e. that there is $\mathcal{B}_0 \in \mathfrak{B}$ such that $\mathcal{B}_0 \prec \mathcal{C}$. Since $\mathcal{C} = \sup \mathfrak{A}$, from the properties of least upper bound (see discussion following its definition) it would then follow that there exists $\mathcal{A}_0 \in \mathfrak{A}$ such that $\mathcal{B}_0 \prec \mathcal{A}_0$. But this would contradict the assumption that any geometric object of \mathfrak{A} precedes any geometric object of \mathfrak{B} (see L 1.2.27.5). Thus, in the case $\mathcal{C} \in \mathfrak{B}$ we have $\mathcal{C} \prec \mathcal{B}$ for all $\mathcal{B} \in \mathfrak{B}$, which completes the proof. \square

Theorem 1.4.32. Let \mathfrak{A} , \mathfrak{B} be two non-empty sets in the set \mathfrak{J} with the property that any element of the set \mathfrak{A} (strictly) precedes any element of the set \mathfrak{B} , i.e. $(\forall \mathcal{A} \in \mathfrak{A})(\forall \mathcal{B} \in \mathfrak{B})(\mathcal{A} \prec \mathcal{B})$. Then there is a geometric object \mathcal{C} such that $\mathcal{A} \preceq \mathcal{C} \preceq \mathcal{B}$ for all $\mathcal{A} \in \mathfrak{A}$, $\mathcal{B} \in \mathfrak{B}$.

Proof. Construct a Dedekind cut in \mathfrak{J} defined by sets \mathfrak{A}_1 , \mathfrak{B}_1 such that $\mathfrak{A}_1 \neq \emptyset$, $\mathfrak{B}_1 \neq \emptyset$, $\mathfrak{A}_1 \cup \mathfrak{B}_1 = \mathfrak{J}$, $\mathfrak{A} \subset \mathfrak{A}_1$, $\mathfrak{B} \subset \mathfrak{B}_1$. To achieve this, we define $\mathfrak{B}_1 = \{\mathcal{B}_1 \in \mathfrak{J} | (\exists \mathcal{B} \in \mathfrak{B})(\mathcal{B} \preceq \mathcal{B}_1)\}$ and $\mathfrak{A}_1 = \mathfrak{J} \setminus \mathfrak{B}_1$. To show that $\mathfrak{B} \subset \mathfrak{B}_1$ observe that for any geometric object $\mathcal{B}_1 \in \mathfrak{B}_1$ there is $\mathcal{B} = \mathcal{B}_1 \in \mathfrak{B}$, i.e. $\mathcal{B}_1 \in \mathfrak{B}$. To show that $\mathfrak{A} \cap \mathfrak{B}_1 = \emptyset$ suppose the contrary, i.e. that there is a geometric object $\mathcal{A}_0 \in \mathfrak{A} \cap \mathfrak{B}_1$. Then from the definition of \mathfrak{B}_1 we would have $(\exists \mathcal{B}_0 \in \mathfrak{B})(\mathcal{B}_0 \preceq \mathcal{A}_0)$. But this contradicts the assumption $(\forall \mathcal{A} \in \mathfrak{A})(\forall \mathcal{B} \in \mathfrak{B})(\mathcal{A} \prec \mathcal{B})$. Thus, we have $\mathfrak{A} \cap \mathfrak{B}_1 = \emptyset$, whence $\mathfrak{A} \subset \mathfrak{J} \setminus \mathfrak{B}_1 = \mathfrak{A}_1$.

To demonstrate that any geometric object of the set \mathfrak{A}_1 precedes any geometric object of the set \mathfrak{B}_1 suppose the contrary, i.e. that there are $\mathcal{A}_0 \in \mathfrak{A}_1$, $\mathcal{B}_0 \in \mathfrak{B}_1$ such that $\mathcal{B}_0 \prec \mathcal{A}_0$. Then using the definition of the set \mathfrak{B}_1 we can write $\mathcal{B} \preceq \mathcal{B}_0 \preceq \mathcal{A}_0$, whence by the same definition $\mathcal{A}_0 \in \mathfrak{B}_1 = \mathfrak{J} \setminus \mathfrak{A}_1$ - a contradiction. Thus, we have $\mathfrak{J} = \mathfrak{A}_1 \cup \mathfrak{B}_1$, where $\mathfrak{A}_1 \supset \mathfrak{A} \neq \emptyset$, $\mathfrak{B}_1 \supset \mathfrak{B} \neq \emptyset$, and $(\forall \mathcal{A}_1 \in \mathfrak{A}_1)(\forall \mathcal{B}_1 \in \mathfrak{B}_1)(\mathcal{A}_1 \prec \mathcal{B}_1)$, which implies that the sets define a Dedekind cut in \mathfrak{J} . Now by the preceding theorem (T 1.4.31) we can find a geometric object $\mathcal{C} \in \mathfrak{J}$ such that $(\forall \mathcal{A}_1 \in \mathfrak{A}_1)(\forall \mathcal{B}_1 \in \mathfrak{B}_1)(\mathcal{A}_1 \preceq \mathcal{C} \preceq \mathcal{B}_1)$. But then from the inclusions $\mathfrak{A} \subset \mathfrak{A}_1$, $\mathfrak{B} \subset \mathfrak{B}_1$ we conclude that $(\forall \mathcal{A} \in \mathfrak{A})(\forall \mathcal{B} \in \mathfrak{B})(\mathcal{A} \preceq \mathcal{C} \preceq \mathcal{B})$, as required. \square

Chapter 2

Elementary Euclidean Geometry

2.1

Axiom 2.1.1. *There is at least one line a and at least one point A such that in the plane α_{aA} defined by a and A , no more than one parallel to a goes through A .*¹

Theorem 2.1.1. *Given a line a and a point A not on it, no more than one parallel to a goes through A .*

Proof. (See Fig. 2.1.) By A 2.1.1 there is a line a and a point A such that in the plane α_{aA} defined by a and A , no more than one parallel to a goes through A . Denote this unique parallel by b (it exists by C ??). Choose points B, C, E, F so that $B, C \in a, E \in b, a_{AB} \perp a$ (L 1.3.8.1), $[BCF]$ (A 1.2.2). With this choice, we can assume without loss of generality that $A_B \subset \text{Int}\angle EAC$. It can be shown that $\angle EAC \equiv \angle ACF, \angle EAB \equiv \angle ABC$.² Observe that the second of these congruences implies that $\angle EAB$ is a right angle because $\angle ABC$ is (see L 1.3.8.2). Now we can write $\mu\angle BAC + \mu\angle ABC + \mu\angle ACB = \mu\angle BAC + \mu\angle EAB + \mu\angle ACB = \mu\angle EAC + \mu\angle ACB = \mu\angle ACF + \mu\angle ACB = \pi^{(abs)}$. Thus, there exists at least one triangle whose abstract sum of angles equals $\pi^{(abs,xt)}$. Therefore, from T 1.4.27 every triangle has abstract sum of angles equal to $\pi^{(abs,xt)}$. Hence by T 1.4.28 follows the present theorem. \square

Proposition 2.1.1.1. *Proof.* In Euclidean geometry every triangle has abstract sum of the angles equal to $\pi^{(abs,xt)}$. Correspondingly, the sum of numerical measures of angles in every triangle in Euclidean geometry equals π . \square

Corollary 2.1.1.2. *In Euclidean geometry the (abstract) sum of the angles of any convex polygon with $n > 3$ sides is $(n - 2)\pi^{(abs,xt)}$. Correspondingly, the sum of numerical measures of the angles of any convex polygon with $n > 3$ sides is $(n - 2)\pi$. In particular, the (abstract) sum of the angles of any convex quadrilateral is $2\pi^{(abs,xt)}$ and the sum of numerical measures of the angles of any convex quadrilateral is $(n - 2)\pi$.*

Proof. \square

Corollary 2.1.1.3. *In Euclidean geometry any Saccheri quadrilateral is a rectangle.*

Proof. \square

Corollary 2.1.1.4. *In Euclidean geometry any Lambert quadrilateral is a rectangle.*

Proof. \square

Theorem 2.1.2. *If $a \parallel b$ and $c \parallel b$, where $b \neq c$ and then $a \parallel c$. Since the relation of parallelism is symmetric, we can immediately reformulate this result as follows: If $a \parallel b, b \parallel c$, and $a \neq c$, then $a \parallel c$.*

Proof. Suppose $\exists C C \in a \cap c$. Then by T 2.1.1 $a = c$, contrary to hypothesis. \square

Theorem 2.1.3. *If points B, D lie on the same side of a line a_{AC} , the point C lies between A and a point E , and the line a_{AB} is parallel to the line a_{CD} , then the angles $\angle BAC, \angle DCE$ are congruent.*

¹Without continuity considerations, we would have to formulate this axiom in the following stronger form: There is at least one plane α containing at least one line a such that if A is any point in α not on a , no more than one parallel to a goes through A .

²This follows from C 1.3.26.3 and the fact that we have chosen the line a and the point A according to A 2.1.1 (so that at most one parallel to a can be drawn through A in α_{aA}). Observe that since the notation for the points B, C was chosen so that the ray A_B lies inside the angle $\angle EAC$, by definition of anterior of angle the rays A_E, A_B lie on the same side of the line a_{AC} . In conjunction with $[BCF]$ this implies that the points E, F lie on opposite sides of the line a_{AC} . Also (in view of C 1.2.21.11), the points E, C lie on opposite sides of the line a_{AB} . Then the remaining arguments needed to establish the congruences $\angle EAC \equiv \angle ACF, \angle EAB \equiv \angle ABC$ essentially replicate those that used to prove C 2.1.4.4.

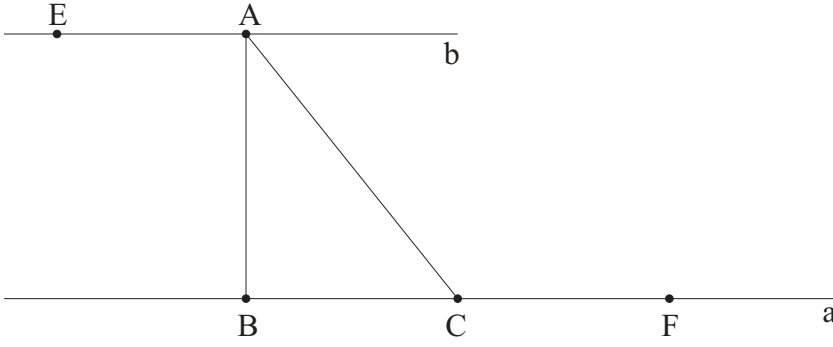

Figure 2.1: If points B, D lie on the same side of a_{AC} , the point C lies between A and E , and a_{AB} is parallel to a_{CD} , then $\angle BAC, \angle DCE$ are congruent.

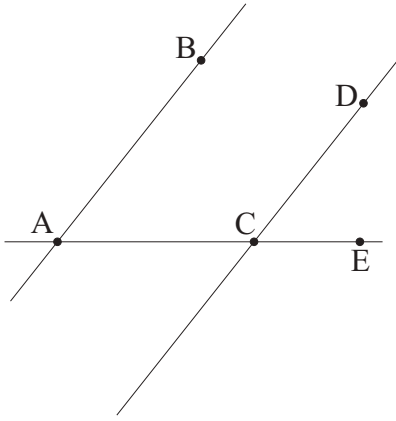

Figure 2.2: If points B, D lie on the same side of a_{AC} , the point C lies between A and E , and a_{AB} is parallel to a_{CD} , then $\angle BAC, \angle DCE$ are congruent.

Proof. (See Fig. 2.2.) Using A 1.3.4, construct C_F such that the rays AB, C_F lie on the same side of the line a_{AC} and $\angle BAC \equiv \angle FCE$. Then by T 1.3.26 we have $a_{AB} \parallel a_{CF}$. But $a_{AB} \parallel a_{CD} \& a_{AB} \parallel a_{CF} \xrightarrow{T2.1.1} a_{CD} = a_{CF}$. Also, using L 1.2.18.2, we can write $A_B C_D a_{AC} \& A_B C_F a_{AC} \Rightarrow C_D C_F a_{AC}$. In view of L 1.2.19.15, L 1.2.11.3 this implies $C_F = C_D$. Thus, we have $\angle BAC \equiv \angle DCE$, as required. \square

Theorem 2.1.4. *If points B, D lie on the same side of a line a_{AC} , the point C lies between A and a point E , and $\angle DCE < \angle BAC$, then the rays B_A, D_C concur.*

Proof. (See Fig. 2.3.) The lines a_{AB}, a_{CD} are not parallel, for otherwise by the preceding theorem (T 2.1.3) we would have $\angle BAC \equiv \angle DCE$, which contradicts $\angle DCE < \angle BAC$ in view of L 1.3.16.11. Thus, $\exists F F \in a_{AB} \cap a_{CD}$. Suppose $F \in A_B$. Then by L 1.2.19.8 B, F lie on one side of a_{AC} . Also, obviously, $B F a_{AC} \& B D a_{AC} \Rightarrow D F a_{AC}$. By L 1.2.19.15 we have $F \in C_D$. Taking into account that $F \in A_B \cap C_D \xrightarrow{T2.1.1} A_F = A_B \& C_F = C_D$ and using T 1.3.17, we can write: $\angle BAC = \angle FAC < \angle FCE = \angle DCE$, which contradicts the inequality $\angle DCE < \angle BAC$ in view of L 1.3.16.10. The contradiction shows that in fact $F \in (A_B)^c$. Then from L 1.2.15.4 we have $(A_B)^c \subset B_A$. Hence $F \in B_A$. \square

Corollary 2.1.4.1. *If a line b is perpendicular to a line a but parallel to a line c , then the lines a, c are perpendicular.*

Proof. (See Fig. 2.4.) Obviously, we can reformulate this corollary as follows: If $a_{AB} \perp a_{AC}$ and $a_{AB} \parallel a_{CD}$ then $a_{CD} \perp a_{AC}$. Choosing appropriate points A, B, C, D, E so that $b = a_{AB} \perp a_{AC} = a$, $a_{AB} \parallel a_{CD}$, and, in addition, $[ACE]$ (A 1.2.2) and B, D lie on the same side of the line a_{AD} . Then from T 2.1.3 have $\angle BAC \equiv \angle DCE$, which implies $a \perp c$. \square

Corollary 2.1.4.2. *Suppose a line c is perpendicular to a line b but parallel to a line a . Suppose further that the line a is also perpendicular to a line d distinct from b , and the lines b, d lie on one plane. Then the lines b, d are parallel.*

Proof. $a \parallel c \& b \perp c \xrightarrow{C2.1.4.1} a \perp b$. $a \perp b \& a \perp d \& b \neq d \& \exists \alpha (b \subset \alpha \& d \subset \alpha) \xrightarrow{C1.3.26.2} b \parallel d$. \square

Corollary 2.1.4.3. *If points B, D lie on the same side of a line a_{AC} and $a_{AB} \parallel a_{CD}$, then the angles $\angle BAC, \angle DCA$ are supplementary.*

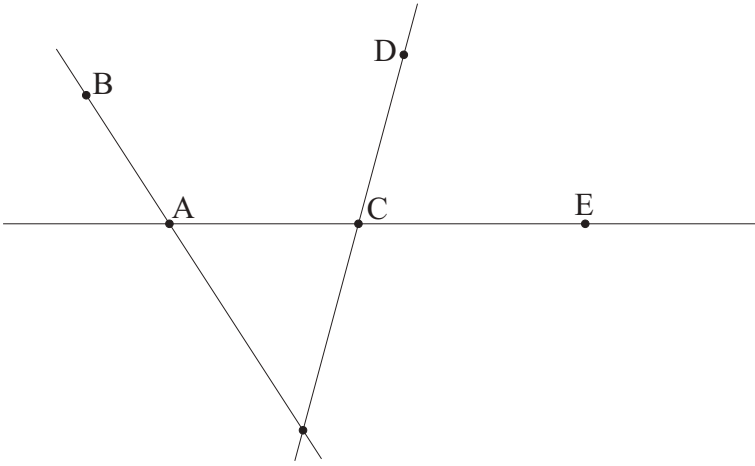

Figure 2.3: If points B, D lie on the same side of a line a_{AC} , the point C lies between A and a point E , and $\angle DCE < \angle BAC$, then the rays B_A, D_C concur.

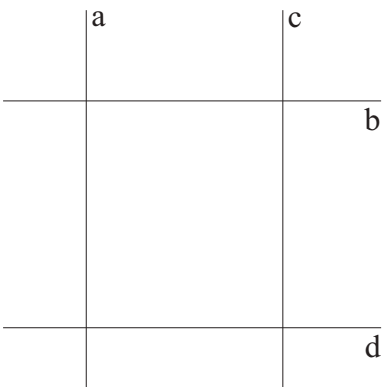

Figure 2.4: Suppose a line c is perpendicular to a line b but parallel to a line a . Suppose further that the line a is also perpendicular to a line d distinct from b , and the lines b, d lie on one plane. Then the lines b, d are parallel.

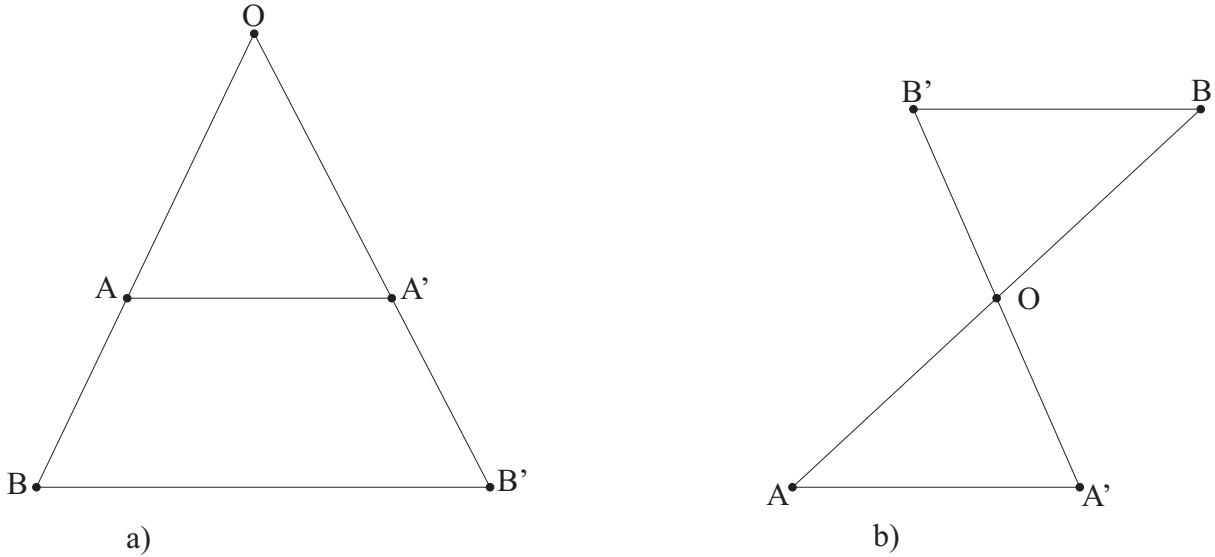

Figure 2.5: Suppose that points O, A, B , as well as O, A', B' colline, and the line $a_{AA'}$ is collinear to the line $a_{BB'}$. Then $\angle OAA' \equiv \angle OBB'$.

Proof. Taking a point E so that $[ACE]$ (A 1.2.2), we have $\angle BAC \equiv \angle DCE$ by T 2.1.3. Since $[ACE]$ implies that the angles $\angle DCA, \angle DCE$ are adjacent supplementary, we conclude that the angles $\angle BAC, \angle DCA$ are supplementary. \square

Corollary 2.1.4.4. *If points B, F lie on opposite sides of a line a_{AC} and $a_{AB} \parallel a_{CD}$, then the angles $\angle BAC, \angle FCA$ are congruent.*

Proof. Taking points E, D such that $[ACE], [FCD]$, we have $\angle BAC \equiv \angle DCE$ by T 2.1.3. ³ But $\angle DCE \equiv \angle ACF$ by T 1.3.7, whence the result. \square

Proposition 2.1.4.5. *Suppose that points O, A, B , as well as O, A', B' colline, and the line $a_{AA'}$ is collinear to the line $a_{BB'}$. Then $\angle OAA' \equiv \angle OBB'$.*

Proof. Obviously, the points O, A, B, A', B' are all distinct. (Note that $a_{AA'} \parallel a_{BB'} \Rightarrow a_{AA'} \cap a_{BB'} = \emptyset$.) By T 1.2.2 we have either $[OAB]$, or $[OBA]$, or $[AOB]$. Suppose $[OAB]$ (see Fig. 2.5, a)). ⁴ Then $[OA'B']$ by T 1.2.44. Hence A', B' are on the same side of the line a_{AB} (see L 1.2.19.9). Then, using T 2.1.4, we conclude that $\angle OAA' \equiv \angle OBB'$. Suppose now that $[AOB]$ (see Fig. 2.5, b)). Then $[A'OB']$ by T 1.2.45. This, in turn, implies that the points A', B' are on opposite sides of the line a_{AB} . Then $\angle BAA' \equiv \angle ABB'$, whence the result. ⁵ \square

Theorem 2.1.5. *In a parallelogram $ABCD$ we have $AB \equiv CD, BC \equiv DA, \angle ABC \equiv \angle ADC, \angle BAD \equiv \angle BCD$.*

Proof. By C 1.2.47.3 the ray AC lies inside the angle $\angle BAD$ and the points B, D lie on opposite sides of the line a_{AC} . Since $a_{AB} \parallel a_{CD}$, C 2.1.4.4 gives $\angle BAC \equiv \angle DCA$. Similarly,⁶ $C_A \subset \text{Int}\angle BCD$ and $\angle BCA \equiv \angle DAC$. Now we can write $\angle BAC \equiv \angle DCA \& \angle DAC \equiv \angle BCA \& A_C \subset \text{Int}\angle BAD \& C_A \subset \text{Int}\angle BCD \xrightarrow{\text{T1.3.9}} \angle BAD \equiv \angle BCD$. Furthermore, since also $\angle ADB \equiv \angle CBD$ ⁷, we have $BD \equiv BD \& \angle ADB \equiv \angle CBD \& \angle DAB \equiv \angle BCD \xrightarrow{\text{T1.3.20}} \triangle DBA \equiv \triangle BDC \Rightarrow AD \equiv BC \& AB \equiv CD$. \square

Theorem 2.1.6. *In a parallelogram $ABCD$ the open intervals $(AC), (BD)$ concur in the common midpoint X of the diagonals AC, BD .*

Proof. The open intervals $(AC), (BD)$ concur by L 1.2.47.2. We also have $\angle BCA \equiv \angle DAC, \angle CBD \equiv \angle ADB$ (see proof of the preceding theorem (T 1.2.5)). But $[AXC] \xrightarrow{\text{L1.2.11.3}} A_X = A_C \& C_X = C_A \Rightarrow \angle DAX = \angle DAC \& \angle BCX = \angle BCA, [BXD] \xrightarrow{\text{L1.2.11.3}} B_X = B_D \& D_X = D_B \Rightarrow \angle CBX = \angle CBD \& \angle ADX = \angle ADB$. Hence $\angle BCX \equiv \angle DAX, \angle CBX \equiv \angle ADX$. Taking into account that $BC \equiv DA$ from the preceding theorem (T 2.1.5), from T 1.3.5 we obtain $\triangle CXB \equiv \triangle AXD$, whence $AX \equiv CX, BX \equiv DX$. ⁸ \square

³Note that $[FCD] \Rightarrow Fa_{AC}D, Ba_{AC}F \& Fa_{AC}D \xrightarrow{\text{L1.2.17.9}} BDa_{AC}$.

⁴Since the pairs of points A, A' and B, B' enter the conditions of the proposition symmetrically, and, as is shown further, $[OAB]$ implies $[OA'B']$, we do not need to consider the case when $[OBA]$ separately. Alternatively, the result for this case can be immediately obtained by substituting A in place of B and B in place of A .

⁵Of course, we also need to make the trivial observation that $\angle BAA' = \angle OAA', \angle ABB' = \angle OBB'$ in view of L 1.2.11.3.

⁶By symmetry. Observe that the assumptions of the theorem remain valid upon the substitution $B \leftrightarrow D$.

⁷Again, this can be established using arguments completely analogous to those employed above to show that $\angle BAC \equiv \angle DCA, \angle BCA \equiv \angle DAC$ (symmetry again!)

⁸Alternatively, we could note that $\angle CXB \equiv \angle AXD$ by T 1.3.7 and use T 1.3.20.

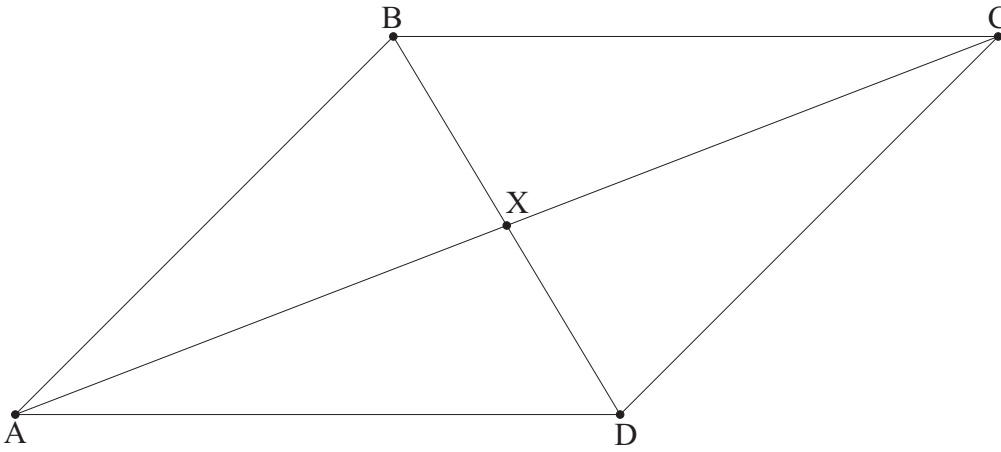

Figure 2.6: In a parallelogram $ABCD$ the open intervals (AC) , (BD) concur in the common midpoint X of the diagonals AC , BD .

Theorem 2.1.7. *Suppose in a trapezoid $ABCD$ with $a_{AB} \parallel a_{CD}$ the vertices B, C lie on the same side of the line a_{AD} . Then $ABCD$ is a parallelogram.*

Proof. By C 1.2.47.4 the open intervals (AC) , (BD) concur and $ABCD$ is a simple quadrilateral. In particular, the points A, C lie on opposite sides of the line a_{BD} , whence in view of $a_{AB} \parallel a_{CD}$ we have $\angle BAD \equiv \angle CDB$ by C 2.1.4.4. Since also $AB \equiv CD$, $BD \equiv DB$, from T 1.3.4 (SAS) we conclude that $\triangle ABD \equiv \triangle CDB$, which implies $AD \equiv BC$. Finally, $AB \equiv CD$, $AD \equiv BC$, and the trapezoid $ABCD$ being simple imply that $ABCD$ is a parallelogram (P 1.3.28.2). \square

Chapter 3

Elementary Hyperbolic (Lobachevskian) Geometry

3.1

Axiom 3.1.1. *There is at least one line a and at least one point A with the following property: if there is a line b containing A and parallel to a , there is another (distinct from b) line c parallel to a .*

Theorem 3.1.1. *Given a point A on a line a in a plane α , there is more than one parallel to a containing A .*

Proof. Suppose the contrary, i.e. that there is a line a and a point A not on it such that no more than one line parallel to a goes through A . But then, according to T 2.1.1 the same would be true about any line and any point not on it. This, however, contradicts A 3.1.1. \square

Proposition 3.1.1.1. *Proof.* In hyperbolic geometry every triangle has abstract sum of the angles less than $\pi^{(abs,xt)}$. Correspondingly, the sum of numerical measures of angles in every triangle in hyperbolic geometry is less than π . \square

Corollary 3.1.1.2. *In hyperbolic geometry the (abstract) sum of the angles of any convex polygon with $n > 3$ sides is less than $(n - 2)\pi^{(abs,xt)}$. Correspondingly, the sum of numerical measures of the angles of any convex polygon with $n > 3$ sides is less than $(n - 2)\pi$. In particular, the (abstract) sum of the angles of any convex quadrilateral is less than $2\pi^{(abs,xt)}$ and the sum of numerical measures of the angles of any convex quadrilateral is less than $(n - 2)\pi$.*

Proof. \square

Corollary 3.1.1.3. *In hyperbolic geometry the (abstract) sum of the summit angles of any birectangle is less than $\pi^{(abs,xt)}$. In particular, both summit angles of any Saccheri quadrilateral are acute. Thus, there are no rectangles in hyperbolic geometry.*

Proof. \square

Corollary 3.1.1.4. *In hyperbolic geometry any Lambert quadrilateral has one acute angle.*

Proof. \square

Lemma 3.1.1.5. *In a birectangle $ABCD$ with right angles $\angle B, \angle C$ we have $\angle A < adjsp\angle D, \angle D < adjsp\angle A$.*

Proof. Using C 3.1.1.3 we can write

$$\mu(\angle A, 0) + \mu(\angle D, 0) < \pi^{(abs,xt)} = \mu(\angle D, 0) + \mu(adjsp\angle D, 0)$$

, whence $\mu(\angle A, 0) < \mu(adjsp\angle D, 0)$ (see P 1.3.66.9). The other inequality is established similarly. \square

Consider a line a and a point A not on it. Using L 1.3.8.1, construct a perpendicular to a through A . Denote by O the foot of this perpendicular. Suppose also one of the two possible orders on a is chosen (see T 1.2.14). We shall say that this choice of order defines a certain *direction* on a . (Thus, there are two opposite directions defined on a .)

Now take a point $P \in a, P \neq O$, such that O precedes P in the chosen order.¹ Let \mathfrak{J} be the set of all rays having initial point A and lying on the same side of a as the point P (and, consequently, as the ray OP) plus the rays A_O, A_O^c . According to P 1.2.21.29 this is a set with generalized angular betweenness relation. This relation is defined in a traditional way: a ray $k \in \mathfrak{J}$ lies between rays $h, l \in \mathfrak{J}$ iff k lies inside the angle $\angle(h, l)$. Let \mathfrak{A} be the set of such rays $k \in \mathfrak{J}$ that the line \bar{k} does not meet a . Now, of the two possible orders on the set \mathfrak{J} (see T 1.2.35) choose the

¹We can also say that the direction on a is dictated by choosing a point P on one of the two rays into which the point O separates the line a . This amounts to choosing one of the rays as the first and another ray as the second in the process of defining the order on a .

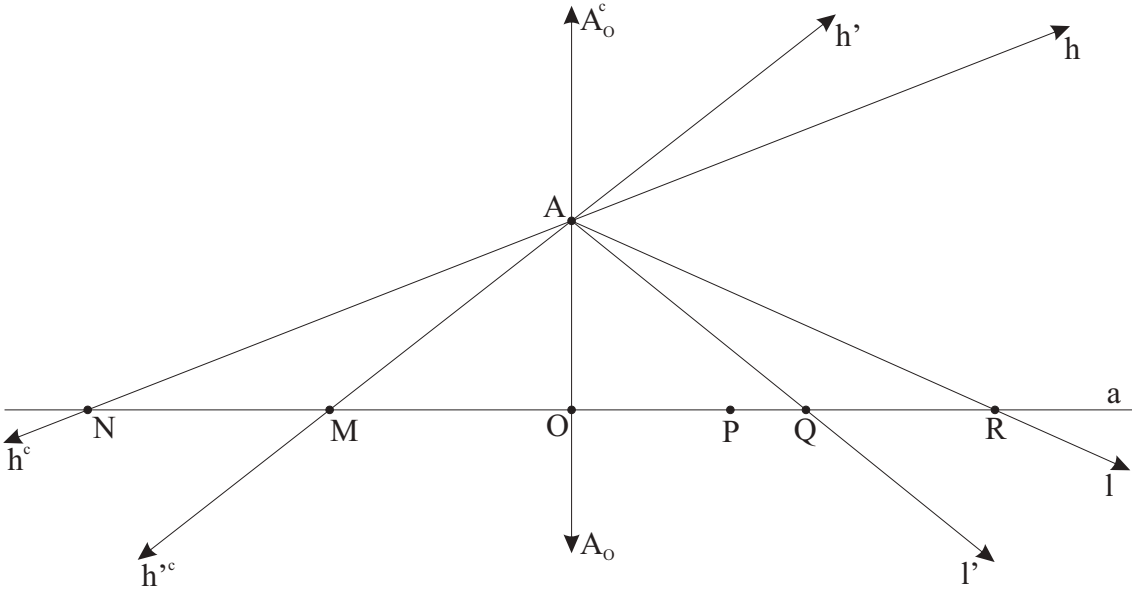

Figure 3.1: If a ray $l \in \mathfrak{J}$ meets O_P , so does any ray l' preceding it. If the ray h^c , complementary to a ray $h \in \mathfrak{J}$, meets the ray O_P^c , so does any ray h'^c , complementary to the ray h' succeeding h .

one in which the ray A_O precedes the ray A_O^c . This implies, in particular, (in view of $[A_O k A_O^c]$ (which follows from definition of interior of straight angle) and T 1.2.35) that $A_O \prec k \prec A_O^c$ for any $k \in \mathfrak{J}$.

Observe that if a ray $l \in \mathfrak{J}$ meets O_P , so does any ray l' preceding l (see Fig. 3.1). In fact, suppose $l' \prec l$ and the ray $l \in \mathfrak{J}$ meets O_P in some point R . $A_O \prec l' \prec l$ ² implies $[A_O l' l]$, i.e. $l' \subset \text{Int}\angle(A_O, l)$. Hence by L 1.2.21.10 the ray l' meets the open interval (OP) , and, consequently, the ray O_P in some point Q .

Thus, any ray $l \in \mathfrak{J}$ which meets O_P , is a lower bound for \mathfrak{A} .³

Similarly, if the ray h^c , complementary to a ray $h \in \mathfrak{J}$, meets the ray O_P^c , so does any ray h'^c , complementary to the ray h' succeeding h (see Fig. 3.1). In fact, suppose $h' \succ h$ and the ray h^c meets O_P^c in some point N . Note that $h \prec h' \prec A_O$ ⁴ implies $[h h' A_O^c]$, i.e. $h' \subset \text{Int}\angle(A_O^c, h)$ and $h'^c \subset \text{Int}\angle(A_O, h^c)$ (see L 1.2.21.16). Hence by L 1.2.21.10 the ray h'^c meets the open interval (ON) , and, consequently, the ray O_P^c , in some point M .

Thus, any ray $h \in \mathfrak{J}$, whose complementary ray h^c meets O_P^c , is an upper bound for \mathfrak{A} .⁵

Let $l_{lim}(a, A) \Rightarrow \inf \mathfrak{A}$, $h_{lim}(a, A) \Rightarrow \sup \mathfrak{A}$. (Since the set \mathfrak{A} , obviously, has both upper and lower bounds, it has the least upper bound and the greatest lower bound by T 1.4.30.) We shall refer to l_{lim} , h_{lim} ⁶ as, respectively, the lower and upper limiting rays for the pair (a, A) with the given direction on a ⁷ (see Fig. 3.2).

Strictly speaking, in place of $l_{lim}(a, A)$ we should write $l_{lim}(h, A)$, where h (and, of course, other letters suitable to denote rays may be used in place of h) is a ray giving the direction (i.e. one of the two possible orders) on a .⁸ Still, (mostly for practical reasons) we prefer to write $l_{lim}(a, A)$ or simply l_{lim} whenever there is no threat of ambiguity. The notation like $l_{lim}(h, A)$ will be reserved for the cases where it is important which of the two possible directions on a is chosen.

Both lower and upper limiting rays lie in \mathfrak{A} .

To demonstrate that $l_{lim} \in \mathfrak{A}$ suppose the contrary, i.e. that $l_{lim} \in \mathfrak{J} \setminus \mathfrak{A}$. Then either l_{lim} meets O_P , or l_{lim}^c meets O_P^c .⁹

²For $l' = A_O$ our claim is vacuously true, so we do not consider this case.

³Since \mathfrak{J} is a chain with respect to the relation \preceq (see T 1.2.34), for any ray $l \in \mathfrak{J}$ which meets O_P and for any ray $k \in \mathfrak{A}$ we have either $l \preceq k$, or $k \preceq l$. Obviously, $k \neq l$, for l meets O_P , but k does not according to the definition of \mathfrak{A} . Also, we have $\neg(k \preceq l)$, for, as shown above, if a ray in $k \in \mathfrak{J}$ precedes a ray $l \in \mathfrak{J}$ that meets O_P , then the ray k also meets O_P , which our ray k does not. Hence $l \prec k \in \mathfrak{A}$ as claimed.

⁴For $h'^c = A_O$ our claim is vacuously true, so we do not consider this case.

⁵Since \mathfrak{J} is a chain with respect to the relation \preceq (see T 1.2.34), for any ray $h \in \mathfrak{J}$ whose complementary ray h^c meets O_P^c and for any ray $k \in \mathfrak{A}$ we have either $h \preceq k$, or $k \preceq h$. Obviously, $k \neq h$, for h^c meets O_P^c , but k^c does not according to the definition of \mathfrak{A} . Also, we have $\neg(k \preceq h)$, for, as shown above, if a ray in $k \in \mathfrak{J}$ succeeds a ray $h \in \mathfrak{J}$ whose complementary ray meets O_P^c , then the ray k^c also meets O_P , which the ray complementary to our ray k does not. Hence $k \prec h \in \mathfrak{A}$, as claimed.

⁶For brevity, we prefer to write simply l_{lim} , h_{lim} instead of $l_{lim}(a, A)$, $h_{lim}(a, A)$, respectively, whenever there is no danger of confusion.

⁷Here, as in quite a few other places, I break up with what appears to be the established terminology.

⁸For example, h can be one of the two rays into which the point O , the foot of the perpendicular lowered from A to a , separates the line a . But, of course, this role (of giving the direction) can be played by any other ray h with the property that its origin precedes (on a) every point of the ray h .

⁹Since l_{lim} and O_P^c lie on opposite sides of a_{AO} (see L 1.2.18.5), they cannot meet. The same is true of l_{lim}^c and O_P . Also, it is absolutely obvious that $O \notin l_{lim}$, $O \notin l_{lim}^c$. (In the case $O \in l_{lim}$ we would have $A_O = l_{lim}$ by L 1.2.11.3. This, in turn, would imply that l_{lim} , the greatest lower bound of \mathfrak{A} , precedes the ray O_P , which is a lower bound of \mathfrak{A} . The contradiction shows that, in fact, we have $O \notin l_{lim}$. The assumption $O \in l_{lim}^c$ would imply (by L 1.2.11.3) that $A_O = l_{lim}^c$, or, equivalently, that $A_O^c = l_{lim}$, which leads us to the absurd conclusion that A_O^c precedes any element of the set \mathfrak{A} . Thus, we have $O \notin l_{lim}^c$.

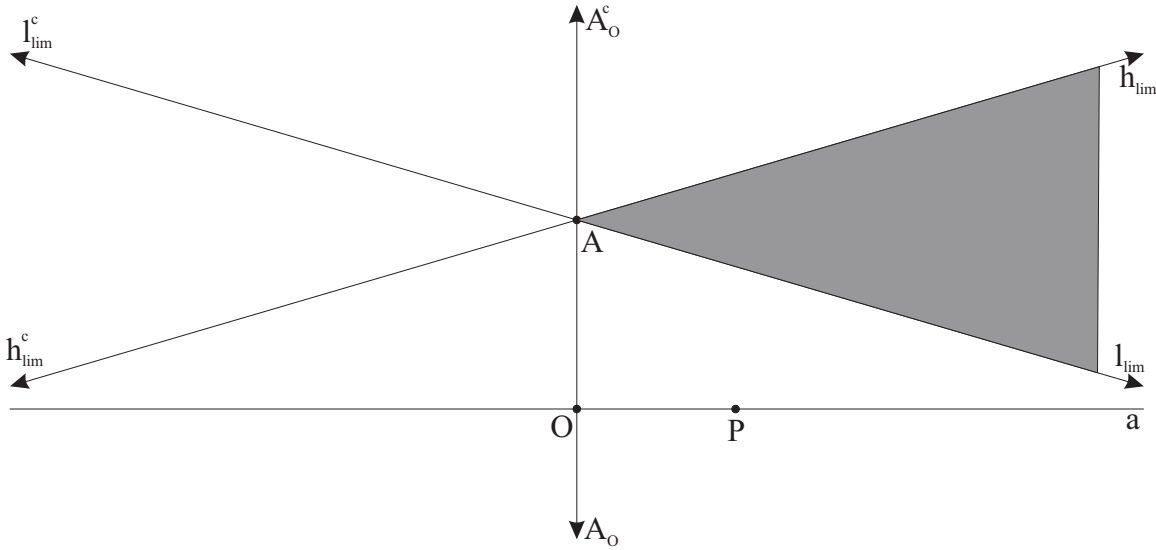

Figure 3.2: All rays l in the set \mathfrak{A} lie between the rays $l_{lim}(a, A)$, $h_{lim}(a, A)$. That is, they traverse the shaded area in the figure.

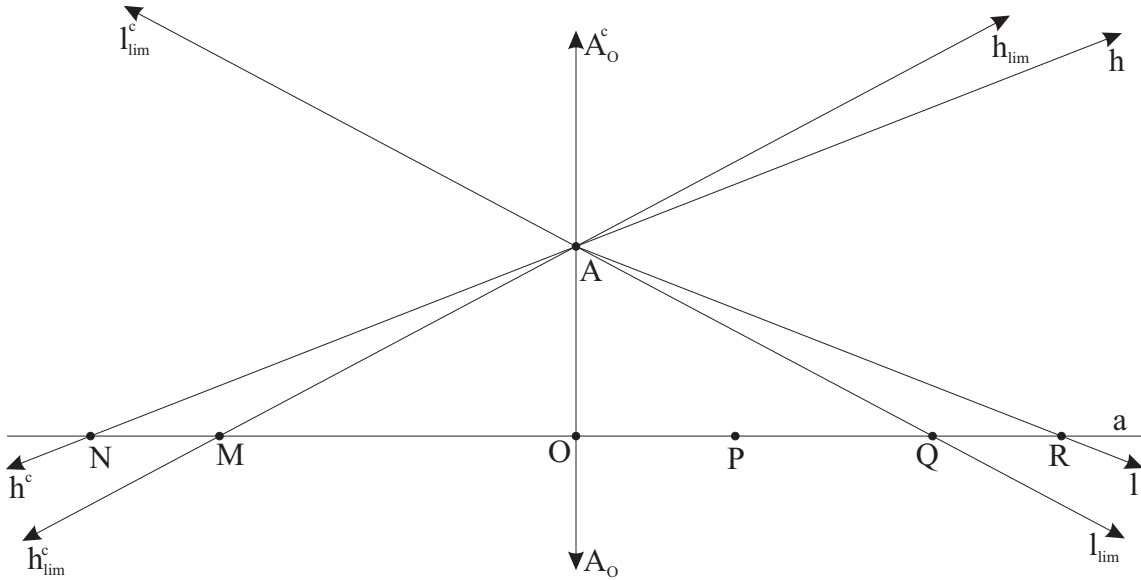

Figure 3.3: Illustration for proof that both lower and upper limiting rays lie in \mathfrak{A} .

But l_{lim}^c cannot meet O_P^c , for that would make l_{lim} an upper bound of \mathfrak{A} , which would contradict the fact that l_{lim} is the greatest lower bound of \mathfrak{A} .

Suppose l_{lim} meets O_P in some point Q (see Fig. 3.3). Taking a point R such that $[OQR]$ (A 1.2.2) and using L 1.2.21.6, L 1.2.21.4, we see that $l_{lim} \subset \text{Int}\angle(A_O, l)$, where $l = OR$. Hence $l_{lim} \prec l$ (see T 1.2.35). Since l meets O_P in R , we see that l is a lower bound of \mathfrak{A} . We arrive at a contradiction with the fact that l_{lim} is the greatest lower bound of \mathfrak{A} . This contradiction shows that in reality l_{lim} does not meet O_P and we have $l_{lim} \in \mathfrak{A}$.

Similarly, we can demonstrate that $h_{lim} \in \mathfrak{A}$.¹⁰

Note that $l_{lim} \neq h_{lim}$, for otherwise we would have exactly one line through A parallel to a , contrary to T 3.1.1. Thus, evidently, for any ray $k \in \mathfrak{A}$ we have $A_O \prec l_{lim} \prec h_{lim} \prec A_O^c$.

If b is any other (i.e. distinct from \bar{l}_{lim} , \bar{h}_{lim}) line through A parallel to a , separated by the point A into rays k , k^c , then one of these rays, say, k , lies inside the angle $\angle(l_{lim}, l_{lim}^c)$, and the complementary ray k^c then lies inside

¹⁰Suppose the contrary, i.e. that $h_{lim} \in \mathfrak{J} \setminus \mathfrak{A}$. Then either h_{lim} meets O_P , or h_{lim}^c meets O_P^c . (Since h_{lim} and O_P^c lie on opposite sides of a_{AO} (see L 1.2.18.5), they cannot meet. The same is true of l_{lim}^c and O_P . Also, it is absolutely obvious that $O \notin h_{lim}$, $O \notin h_{lim}^c$. (In the case $O \in h_{lim}^c$ we would have $A_O = h_{lim}^c$ by L 1.2.11.3. Hence $A_O^c = h_{lim}$. This, in turn, would imply that h_{lim} , the least upper bound of \mathfrak{A} , succeeds a ray h (whose complementary ray h^c meets O_P^c , which is an upper bound of \mathfrak{A}), which is an upper bound of \mathfrak{A} . The contradiction shows that, in fact, we have $O \notin h_{lim}^c$. The assumption $O \in h_{lim}$ would imply (by L 1.2.11.3) that $A_O = h_{lim}$, which leads us to the absurd conclusion that A_O succeeds any element of the set \mathfrak{A} . Thus, we have $O \notin h_{lim}$.) But h_{lim} cannot meet O_P , for that would make h_{lim} a lower bound of \mathfrak{A} , which would contradict the fact that h_{lim} is the least upper bound of \mathfrak{A} . Suppose now h_{lim}^c meets O_P^c in some point N (see Fig. 3.3). Taking a point M such that $[OMN]$ (A 1.2.2) and using L 1.2.21.6, L 1.2.21.4, we see that $h_{lim}^c \subset \text{Int}\angle(A_O, h^c)$, where $h^c = ON$. Hence $h_{lim}^c \subset \text{Int}\angle(A_O^c, h)$ (see L 1.2.21.16) and, consequently, $h_{lim} \prec h$ (see T 1.2.35). Since h^c meets O_P^c in N , we see that h is an upper bound of \mathfrak{A} . We arrive at a contradiction with the fact that h_{lim} is the least upper bound of \mathfrak{A} . This contradiction shows that in reality h_{lim}^c does not meet O_P^c .

the angle $\angle(l_{lim}^c, l_{lim}^c)$.

Hence it follows that $l_{lim}(O_P^c, A) = h_{lim}^c(O_P, A)$, $h_{lim}(O_P^c, A) = l_{lim}^c(O_P, A)$.¹¹

To show that $\angle(A_O, l_{lim}(O_P^c, A)) \equiv \angle(A_O, l_{lim}(O_P, A))$ suppose the contrary. Without any loss of generality we can assume that $\angle(A_O, l_{lim}(O_P^c, A)) < \angle(A_O, l_{lim}(O_P, A))$ (see L 1.3.16.14). Then there is a ray l' with initial point O such that $\angle(A_O, l_{lim}(O_P, A)) \equiv \angle(A_O, l')$, $l' \subset \text{Int}\angle(A_O, l_{lim}(O_P^c, A))$. Since $l' \prec l_{lim}(O_P^c, A)$, we see that l' has to meet the ray O_P^c at some point Q' . Taking a point $Q \in O_P$ such that $OQ' \equiv OQ$, and taking into account that $a_{AO} \perp a \Rightarrow \angle AOQ' \equiv \angle AOQ$, we can write $OQ' \equiv OQ$ & $OA \equiv OA$ & $\angle AOQ' \equiv \angle AOQ \xrightarrow{T1.3.4} \triangle AOQ' \equiv \triangle AOQ \Rightarrow \angle OAQ' \equiv \angle OAQ$. Since $\angle(A_O, l_{lim}(O_P, A)) \equiv \angle(A_O, l') = \angle OAQ' \equiv \angle OAQ$ and the rays $l_{lim}(O_P, A)$, A_Q lie on the same side of the line a_{AO} , from A 1.3.4 we have $l_{lim}(O_P, A) = A_Q$, i.e. the ray $l_{lim}(O_P, A)$ meets the line a at Q - a contradiction which shows that in fact $\angle(A_O, l_{lim}(O_P^c, A)) \equiv \angle(A_O, l_{lim}(O_P, A))$.

We shall call either of the two congruent angles $\angle(A_O, l_{lim}(O_P, A))$, $\angle(A_O, l_{lim}(O_P^c, A))$ the angle of parallelism for the line a and the point A . We see that angles of parallelism are always acute.

We shall refer to \bar{l}_{lim} as the line parallel to a in the given direction (on a). To prove that the concept of the line parallel to a given line in a given direction is well defined, we need to show that in our case l_{lim} is parallel to a in the chosen (on a) direction regardless of the choice of the point A on l_{lim} .

Take $A' \in \bar{l}_{lim}$. Denote by O' the foot of the perpendicular through A' to a . Now take a point $P' \in a$, $P' \neq O'$, such that O' precedes P' in the chosen order.¹²

Let \mathfrak{J}' be the set of all rays having initial point A' and lying on the same side of a as the point P' (and, consequently, as the ray $O'P'$) with initial point A' , plus the rays $A'O'$, $A'^c_{O'}$. According to P 1.2.21.29, this is a set with generalized angular betweenness relation. This relation is defined in a traditional way: a ray $k \in \mathfrak{J}'$ lies between rays $h, l \in \mathfrak{J}'$ iff k lies inside the angle $\angle(h, l)$. Let \mathfrak{A}' be the set of such rays $k \in \mathfrak{J}'$ that the line k does not meet a . Now, of the two possible orders on the set \mathfrak{J}' (see T 1.2.35) choose the one in which the ray $A'O'$ precedes the ray $A'^c_{O'}$.

Let $l'_{lim} \Rightarrow l_{lim}(a, A') \Rightarrow \inf \mathfrak{A}'$, $h'_{lim} \Rightarrow h_{lim}(a, A') \Rightarrow \sup \mathfrak{A}'$.

First, suppose $A' \in l_{lim}(a, A)$ (see Fig. 3.4, a)). We are going to show that $A'^c_A = l_{lim}(a, A')$.

As the lines a_{OA} , $a_{O'A'}$ are distinct and are both perpendicular (by construction) to the line $a_{OO'} = a$, the lines a_{OA} , $a_{O'A'}$ are parallel (see C 1.3.26.2). Therefore, the points A, O lie on the same side of the line $a_{A'O'}$ and the points A', O' lie on the same side of the line a_{AO} . Consequently, $O' \in O_P$.¹³ From the properties of order on a it follows that $O \prec O'$. Hence $O \prec O' \prec P' \xrightarrow{T1.2.35} [OO'P']$. We know that the point A and the ray $A'^c_{O'}$ lie on opposite sides of the line $a_{O'A'}$, as do the point O and the ray $O'P'$. At the same time, the points A, O lie on the same side of $a_{A'O'}$. Therefore, the rays $A'^c_{O'}$ and $O'P'$ lie on the same side of the line a_{OA} (L 1.2.18.5, L 1.2.18.4).

Note that $\bar{A}'_A = \bar{l}_{lim}(a, A)$ and, consequently, $A'^c_A \in \mathfrak{A}'$. Now, to establish that $A'^c_A = l_{lim}(a, A')$, we need to prove only that any ray preceding A'^c_A (in \mathfrak{J}') meets the ray $O'P'$ and thus lies outside the set \mathfrak{A}' . Take a ray l' emanating from A' and distinct from $A'O'$, such that l' precedes A'^c_A in \mathfrak{J}' . Then we have $l' \subset \text{Int}\angle(A'O', A'^c_A)$ (see T 1.2.35). Take a point $Q \in l'$.

Since the lines $l_{lim}(a, A)$ and a do not meet, the points $O, O' \in a$, and, consequently, the rays $A_O, A'O'$ lie on the same side of the line $l_{lim}(a, A')$. Also, from the definition of interior of angle the rays l' and $A'O'$ lie on the same side of the line $l_{lim}(a, A)$. Thus, we see (using L 1.2.18.2) that the rays l' and A_O lie on the same side of the $l_{lim}(a, A)$.

Observe that the ray l' and the line a_{AO} lie on opposite sides of the line $a_{A'O'}$.¹⁴ Therefore, the line l' can have no common points with the ray A_O ,¹⁵ and, in particular, with $(AO]$ (L 1.2.11.1, L 1.2.11.13).

Evidently, we can assume without any loss of generality that the point Q and the line $l_{lim}(a, A)$ lie on the same side of the line a .¹⁶ Since both l' and A'^c_A lie on the same side of the line $a_{A'O'}$ and the rays l' and A_O lie on the same side of the $l_{lim}(a, A)$, the point Q lies inside the angle $\angle OAA'$. But, in view of L 1.2.21.4, so does the whole ray A_Q . Hence $A_Q \prec l_{lim}(a, A)$ in \mathfrak{J} (by T 1.2.35). Therefore, the ray A_Q has to meet the line a in some point M . Since the rays A_Q, O_P lie on the same side of a_{AO} ,¹⁷ the point M lies on O_P .

¹¹Evidently, $l_{lim}(O_P^c, A)$ is the lower limiting ray for the reverse direction on a , and $h_{lim}(O_P^c, A)$ is the upper limiting ray for that direction.

¹²We proceed now to define the set \mathfrak{A}' of rays with initial point A' and the corresponding lower and upper limiting rays $l'_{lim}(a, A')$, $h'_{lim}(a, A')$ in such a way that \mathfrak{A}' and $l'_{lim}(a, A')$, $h'_{lim}(a, A')$ play for the line a and the point A' the role completely analogous to that played by $l_{lim}(a, A)$, $h_{lim}(a, A)$ for \mathfrak{A} .

¹³In fact, we know that the point $A' \in l_{lim}(a, A)$ lies on the same side of the line a_{OA} as the point P . Since $A' \notin a_{OA}$, from L 1.3.8.3 we see that $O' \neq O$. If the point O' were to lie on the ray O_P^c , by L 1.2.17.10 the points A', O' would lie on opposite sides of the line a_{OA} , and the lines A_{OA} , $a_{O'A'}$ would meet - a contradiction. Thus, we see that $O' \in O_P$.

¹⁴In fact, since $l' \subset \text{Int}\angle(A'O', A'^c_A)$, from the definition of interior of angle the rays l' and A'^c_A lie on the same side of the line $a_{A'O'}$. Since the rays l' and A'^c_A lie on the same side of the line $a_{A'O'}$, and the point A and the ray A'^c_A lie on opposite sides of the line $a_{A'O'}$ (recall also that $a_{AO} \parallel a_{A'O'}$), we can conclude (using L 1.2.18.5, T 1.2.20) that the ray l' and the line a_{AO} lie on opposite sides of the line $a_{A'O'}$.

¹⁵In fact, since $A' \notin a_{AO}$ and the rays l'^c, A_O lie on opposite sides of $l_{lim}(a, A)$ (recall that l' and A_O lie on the same side of the $l_{lim}(a, A)$) and thus have no common points, any common points of A_O and l' would have to lie on the ray l' . But we have just shown that the ray l' and the line a_{AO} lie on opposite sides of the line $a_{A'O'}$ and, therefore, cannot meet.

¹⁶We know that the rays l' and A'^c_A lie on the same side of the line $a_{A'O'}$, as do $O'P'$ and A'^c_A . Hence l' and $O'P'$ lie on the same side of $a_{A'O'}$. Obviously, if the ray l' meets the line a at all, it can do so only on the ray $O'P'$ (using L 1.2.18.5, we see that l' and $O'^c_{P'}$ lie on opposite sides of $a_{A'O'}$ and thus have no common points; also, it is obvious that $O' \notin l'$). So, if the point Q and the line $l_{lim}(a, A)$ containing the point A would lie on opposite sides of a , then the open interval (AQ) , and, consequently, the ray l' , would meet $O'P'$ and we would have nothing more to prove.

¹⁷Indeed, $l_{lim}(a, A)$, O_P lie on the same side of a_{AO} by construction, and $l_{lim}(a, A)$, A_Q lie on the same side of a_{AO} by definition of interior of $\angle OAA'$.

Evidently, all common points the line \bar{l}' has with the contour of the triangle $\triangle AOM$ lie on the ray l' .¹⁸ It is also obvious that the line \bar{l}' lies in the plane α_{AOM} and does not contain any of the points A, O, M . Since \bar{l}' meets the open interval (AM) in Q (one can use L 1.2.21.9 to show that $[AQM]$), by A 1.2.4 it meets the open interval (OM) , and thus the ray O_P , in some point N , q.e.d.

Suppose $A' \in l_{lim}^c(a, A)$ (see Fig. 3.4, b)). We are going to show that $A'_A = l_{lim}(a, A')$. Since the point P and the ray $l_{lim}(a, A)$ lie on the same side of the line a_{AO} (by construction), the ray $l_{lim}(a, A)$ and the point A' lie on opposite sides of the line a_{AO} , finally, as shown above, the points A', O' lie on the same side of a_{AO} , using L 1.2.18.5 we conclude that the points O', P lie on opposite sides of the line a_{AO} . Therefore, points O', P lie on the line a on opposite sides of the point O , whence $O' \prec O \prec P$ in view of T 1.2.35 (we take into account that $O \prec P$ by hypothesis). Since also, by construction, $O' \prec P'$, from the properties of precedence on the line a it follows that the points O, P' lie on a on the same side of O' and, consequently, the rays A'_A and the point P' (as well as the whole ray $O'P'$) lie on the same side of the line $a_{A'O'}$ (recall that the points A, O lie on the same side of $a_{A'O'}$). We see that $A'_A \in \mathfrak{A}'$. Now, to complete our proof that $A'_A = l_{lim}(a, A')$, we are left to show only that any ray preceding A'_A (in \mathfrak{J}') meets the ray $O'P'$ and thus lies outside the set \mathfrak{A}' . Take a ray l' emanating from A' and distinct from $A'O'$, such that l' precedes A'_A in \mathfrak{J}' . Then we have $l' \subset \text{Int}\angle A'O'A$ (see T 1.2.35). Take a point $Q \in l'^c$. Evidently, we can assume without any loss of generality that the points A', Q lie on the same side of the line a_{AO} .¹⁹ Since the ray l' and the point Q , as well as the ray A_Q^c and the point Q , lie on opposite sides of the line $\bar{l}_{lim}(a, A)$; the rays $A'O', A_Q^c$ lie on the same side of $\bar{l}_{lim}(a, A)$ (by definition of interior of $\angle A'O'A$), as do the rays $A'O', A_O$, using L 1.2.18.2, L 1.2.18.4 we see that the rays A_O, A_Q^c lie on the same side of $\bar{l}_{lim}(a, A)$. Similarly, since A' and Q lie on the same side of a_{AO} (by our assumption), A' and $l_{lim}(a, A)$, as well as Q and A_Q^c lie on opposite sides of a_{AO} , from L 1.2.18.5, L 1.2.18.4 we see that the rays A_Q^c and $l_{lim}(a, A)$ lie on the same side of a_{AO} . Thus, by definition of interior, the ray A_Q^c lies inside the angle $\angle(A_O, l_{lim}(a, A))$. Consequently, A_Q^c precedes $l_{lim}(a, A)$ in the set \mathfrak{J} (T 1.2.35). Now, from the properties of $l_{lim}(a, A)$ as the greatest lower bound of \mathfrak{A} we see that the ray A_Q^c has to meet the ray O_P in some point M . Since $l' \subset \text{Int}\angle A'O'A$, by L 1.2.21.10 there is a point $R \in l' \cap (A'A)$. Now observe that $[QAM] \& R \in \bar{l}' \cap (A'A) \xrightarrow{C1.2.1.7} \exists N(N \in (O'M) \cap \bar{l}')$. Since the $M \in O'P'$ and the rays $O'P', l'$ lie on the same side of $a_{A'O'}$, we see that the open interval $(O'M)$ and the line \bar{l}' can meet only in a point lying on l' .²⁰ Thus, $\exists N(N \in (O'M) \cap l')$, which completes the proof of the fact that the notion of the line parallel to a given line in a given (on that line) direction is well defined.

Theorem 3.1.2. *Given a line a with direction on it and a point A not on a , there is exactly one line through A parallel to a in the given (on A) direction.*

Proof. \square

Theorem 3.1.3. *If a line b is parallel to a line a in a given on a direction, then the line a is parallel to the line b in the same direction.*

Proof. Take points $A \in a, B \in b$. Denote $D \equiv l \cap a$, where l is the bisector of the angle $\angle(B_A, k)$ (see T 1.3.25) and $k \equiv l_{lim}(a, B)$.²¹ Denote by I the point of intersection of the bisector of the angle $\angle BAD$ with the open interval (BD) (see T 1.3.25, L 1.2.21.10).²² Now choose points J, K, L such that $a_{IJ} \perp b, a_{IK} \perp a_{AB}, a_{IL} \perp a$.²³ Since the rays B_I, A_I are the bisectors of proper (non-straight) angles, the angles $\angle IBA, \angle IAB, \angle(B_I, k), \angle IAD$ are acute. Therefore, $K \in (AB)$ by P 1.3.24.3. Hence $\angle KBI = \angle ABI, \angle KAI = \angle BAI$ (L 1.2.11.3). Also, $J \in k, L \in A_D$ by C 1.3.18.11, whence $\angle IBJ = \angle(B_I, k), \angle IAL = \angle IAD$. Now we can write (taking into account that, by T 1.3.16, all right angles are congruent) $BI \equiv BI \& \angle JBI \equiv \angle KBI \& \angle BJI \equiv \angle BKI \xrightarrow{T1.3.19} \triangle BJI \equiv \triangle BKI \Rightarrow IJ \equiv IK, IA \equiv IA \& \angle KAI \equiv \angle LAI \& \angle IKA \equiv \angle ILA \xrightarrow{T1.3.19} \triangle AKI \equiv \triangle ALI \Rightarrow IK \equiv IL$. Thus, $IJ \equiv IL$. The points I, J, L are not collinear. In fact, the angle, formed by the ray J_L and one of the rays into which the point J separates the line b , is the angle of parallelism corresponding to the line a and the point J . This angle, like any angle of parallelism, is acute (see above) and thus cannot be a right angle. But $I \in J_L$ (we take into account that, since $I \in \text{Int}(ab)$ if the points I, J, L were collinear, we would necessarily have $I \in J_L$ ²⁴) would imply that $J_L \perp b - a$

¹⁸This follows from the even more obvious fact that the ray l' and all points of the contour of $\triangle AOM$ except A lie on the same side of the line $l_{lim}(a, A)$. (Recall that the contour of the triangle $\triangle AOM$ is the union $[AO] \cup [OM] \cup [MA]$). In order to make our exposition at all manageable, in this as well as many other proofs we leave out some easy yet tedious details, leaving it to the reader to fill the gaps.)

¹⁹This follows from the fact that any half-plane is an open plane set.

²⁰Of course, $A' \notin (O'M)$. Also, $[O'OP] \xrightarrow{L1.2.13.2} O_P \subset O'P$ and O, P' lie on a on the same side of O' , whence $M \in O'P'$ and, consequently, $(O'M) \subset O'P'$.

²¹Observe that l definitely meets the line a . A clumsy, but sure way to see this is as follows: Lower a perpendicular from B to a with the foot O . Since, loosely speaking, $\angle(k, l)$ is half $\angle(B_A, k)$ and the latter is not straight, the angle $\angle(k, l)$ is acute. Using L 1.3.16.17, C 1.3.16.4 we see that $l \subset \text{Int}\angle(B_O, k)$. But we have shown above that, in view of definition of k as the lower limiting ray, the ray l is bound to meet the line a .

²²Thus, AI is a bisector of the triangle $\triangle BAD$.

²³In other words, the points J, K, L are the feet of the perpendiculars lowered from I to the lines b, a_{AB}, a , respectively.

²⁴To show that the point I lies inside the strip ab , observe that I , lying on the bisector of the angle $\angle(B_A, k)$, lies on the same side of the line b as the point A , and, consequently, as the whole line a . Similarly, since I lies on the bisector of $\angle BAD$, the point I lies on the same side of a as B , and, consequently, as the whole line b . Thus, by definition of interior of the strip ab , the point I lies inside this strip. If the points I, J, L were collinear, we would have either $I \in J_L$, or $I = J$, or $I \in J_L^c$. Obviously, $I \neq J$. Also, $I \in J_L^c$, equivalent to $[IJL]$, would imply that the points I, L lie on opposite sides of the line $b - a$ - a contradiction with $I \in \text{Int}(ab)$. Thus, we conclude that $I \in J_L$.

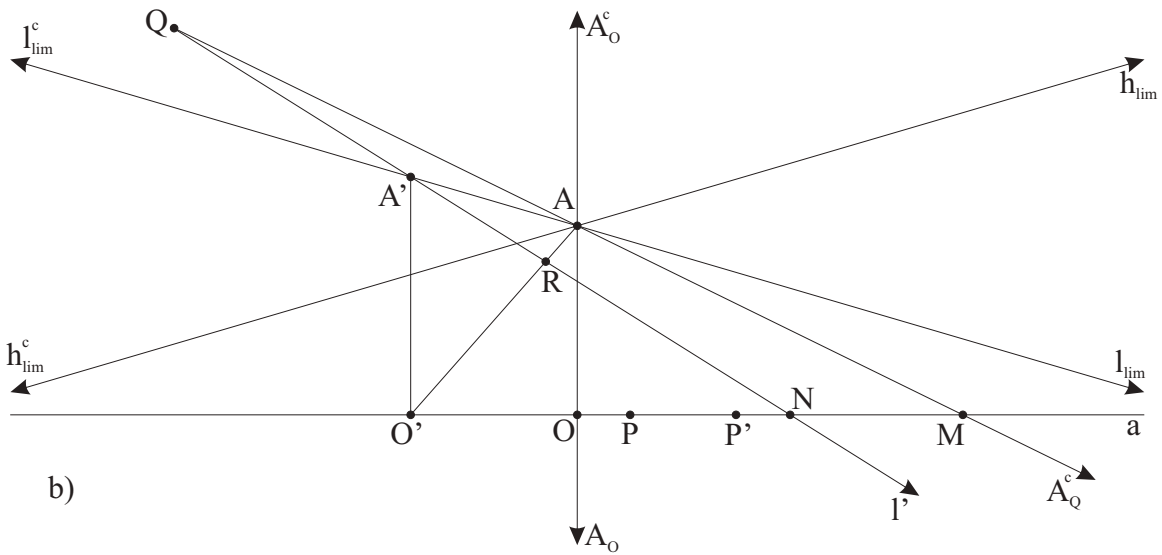
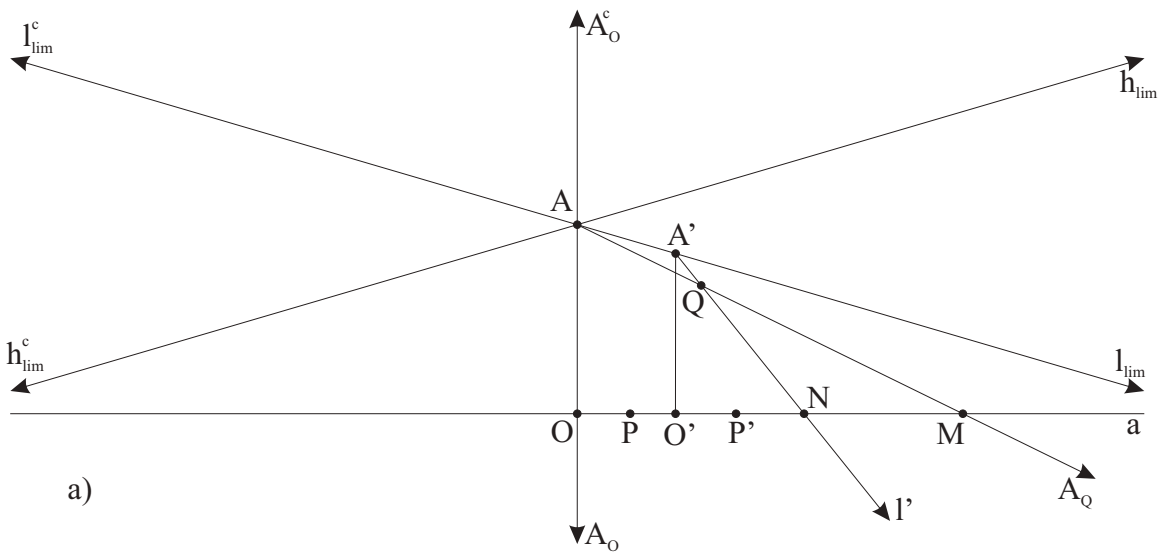

Figure 3.4: Illustration for proof that the notion of the line parallel to a given line in a given (on that line) direction is well defined.

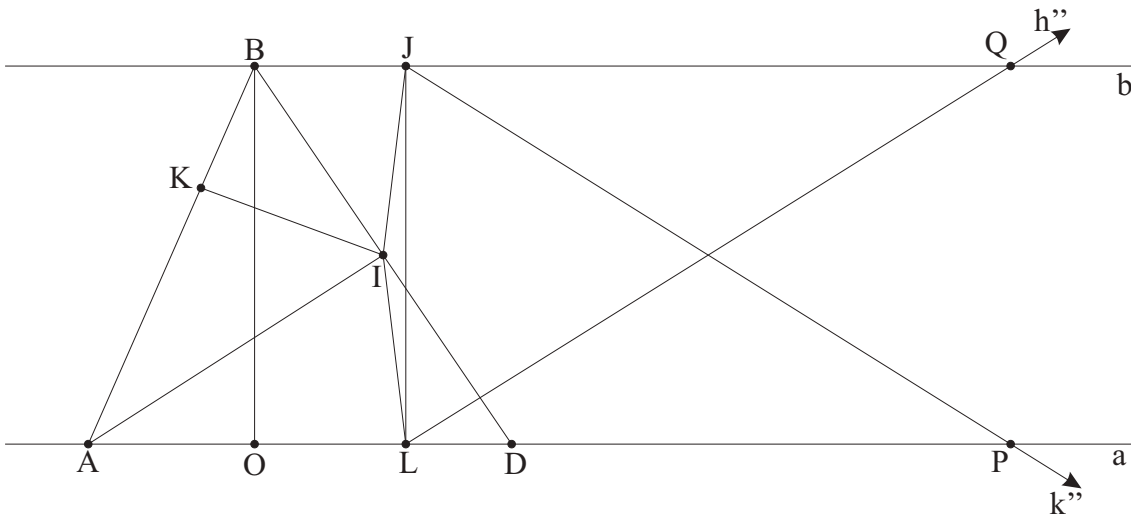

Figure 3.5: If a line b is parallel to a line a in a given on a direction, then a is parallel to b in the same direction.

contradiction. Denote h' the ray with initial point L such that $\angle(L_J, h')$ is acute. Let $k' \equiv l_{lim}(h', J)$.²⁵ We are going to show that $h' = l_{lim}(k', J)$.²⁶ Since we know that $a = \bar{h}' \parallel k' = b$, we need to establish only that any ray h'' lying inside the angle $\angle(L_J, h')$ meets the line b . Evidently, without any loss of generality, it suffices to take an arbitrary ray $h'' \subset \text{Int}\angle(L_J, h')$ and show that it meets b . Observe that the ray J_L lies inside the angle $\angle(J_I, k')$.²⁷ Since $\angle IJL \equiv \angle ILJ$ by T 1.3.3 (recall that $IJ \equiv IL$), the angles $\angle(J_I, k')$, $\angle(L_I, h')$ are congruent (both being right angles), and $J_L \subset \text{Int}\angle(J_I, k')$, $L_J \subset \text{Int}\angle(L_I, h')$, using T 1.3.9 we conclude that $\angle(L_J, k') \equiv \angle(J_L, h')$.

Consider the ray k'' such that k', k'' lie on the same side of a_{JL} and $\angle(L_J, h'') \equiv \angle(J_L, k'')$ (see A 1.3.4). We have $h'' \subset \text{Int}\angle(L_J, h') \& k'k''a_{JL} \& \angle(L_J, h'') \equiv \angle(J_L, k'') \& \angle(L_J, k') \equiv \angle(J_L, h')$ $\xrightarrow{P1.3.9.5} k'' \subset \text{Int}\angle(J_L, k')$. Since $k' = l_{lim}(h', J)$, the ray k'' meets the ray h' in some point P .²⁸ Now take a point $Q \in k'$ such that $JQ \equiv LP$ (see A 1.3.1). Now we can write $LJ \equiv JL \& JQ \equiv LP \& \angle L_JQ \equiv \angle JLP \xrightarrow{T1.3.4} \triangle LJQ \equiv \triangle JLP \Rightarrow \angle JLQ \equiv \angle LJQ$. In conjunction with $\angle(J_L, h'') \equiv \angle(L_J, k'')$, this gives $LQ = h''$, i.e. h'' meets the line b (or, to be more precise, the ray k') in the point Q . \square

Lemma 3.1.4.1. *Suppose that lines a, b are parallel to a line c in the same direction. Suppose, further, that there is a point $B \in b$ lying inside the strip (ac) . Then for any points $A \in a, C \in c$ there is a point $X \in b$ such that $[AXC]$.*

Proof. Evidently, $a \parallel b$, for if they met in some point, we would have two lines through a single point, parallel to c in the same direction - in contradiction with T 1.3.2. Therefore, $b \subset \text{Int}ac$ (from L 1.2.19.20), i.e. the line b lies completely inside the strip ac . Choose a ray l' (with initial point C) such that $l' \subset \text{Int}\angle(C_A, l)$, $l' \subset \text{Int}\angle(C_G, l)$, $l' \subset \text{Int}\angle(C_F, l)$, where $l \equiv l_{lim}(a, C)$, and G, F are the feet of the perpendiculars drawn through C to b and a , respectively. Since a, c are parallel in a given direction, the ray l' is bound to meet the line a in some point P . For the same reason l' meets b in a point Q . From L 1.2.19.16 we see that $[CQP]$. Finally, since the line b lies in the plane α_{ACP} and does not contain any of the points A, C, P , using Pasch's axiom (A 1.2.4) we conclude that b meets the open interval (AC) in some point X , as required.²⁹ \square

Theorem 3.1.4. *Suppose that two lines a, b are both parallel to a line c in the same direction. Then the lines a, b are parallel to each other in that direction.*

Proof. Observe that $a \parallel b$ (see proof of the preceding lemma (L 3.1.4.1)). Obviously (since both a and b do not meet c), either a, b lie on the same side of c , or a, b lie on opposite sides of the line c .

First, suppose that a, b lie on the same side of c . Then either the line b lies inside the strip ac , or the line c lies inside the strip ab (see L 1.2.21.34). Evidently, we can assume without loss of generality (due to symmetry) that

²⁵That is, $l_{lim}(h', J)$ is the lower limiting ray with respect to the order defined on a in such a manner that L precedes any point of h' .

²⁶Consider the set \mathfrak{J}' of such rays l' with initial point L that the rays l', k' lie on the same side of the line a_{LF} , plus the rays L_F, L'_F , where $F \in b$ is the foot of the perpendicular drawn through L to b . Consider also the subset $\mathfrak{Q}' \subset \mathfrak{J}'$ defined by the additional requirement that the line l' does not meet the line b . As explained above, we can define on the set \mathfrak{J}' two opposite orders, linked to the betweenness relation, defined in the usual way as follows: a ray $l'' \in \mathfrak{J}'$ lies between $h'' \in \mathfrak{J}'$ and $k'' \in \mathfrak{J}'$ with the same initial point iff $l'' \subset \text{Int}\angle(h'', k'')$. Of the two orders possible, we choose the one in which L_F precedes L'_F . We then define $l_{lim}(k', J) \equiv \inf \mathfrak{Q}'$.

²⁷Here is a clumsy, but working way to show this: Since the rays L_I, L_J lie on the same side of the line a and the angle $\angle(L_J, h')$, being acute (by our assumption), is less than the right angle $\angle(L_I, h')$ (see L 1.3.16.17), we see (using C 1.2.21.11) that the rays L_I, h' lie on opposite sides of the line a_{LJ} . As the rays h', k' lie on the same side of the line a_{LJ} , the rays L_I, h' lie on opposite sides of the line a_{LJ} . (Of course, we also take into account that the rays L_I, J_I lie on the same side of a_{LJ} .) Finally, since the rays J_I, J_L (because the points $I, L \in a$ lie on the same side of b) lie on the same side of b , from L 1.2.21.32 we find that J_L lies inside the angle $\angle(J_I, k')$.

²⁸As $k'' \subset \angle(J_L, k')$, the rays k'', k' lie on the same side of the line a_{JL} . Since also $h'k'a_{JL}$, we see that $k''a_{JL}h', k''a_{JL}h'^c$, which implies that the ray k'' can meet the line a only in a point lying on the ray h' . (We also take into account that, of course, $L \notin k''$.)

²⁹Obviously, b cannot meet (AP) , for $a \parallel b$.

$b \subset \text{Int}(ac)$. To prove that $h = l_{\text{im}}(b, A)$ consider a ray h' such that $h' \subset \text{Int}\angle(h, A_B)$, $h' \subset \text{Int}\angle(h, A_C)$.³⁰ We need to show that the ray h' chosen in this way meets the line b . Suppose the contrary. But then h' would not meet the line c either. For, if h' met c in some point, in view of the preceding lemma (L 3.1.4.1) it would have to meet the line b as well, which contradicts our assumption. On the other hand, from the fact that the line a is parallel to the line c in the given direction it follows that h' must meet c . From these contradictions we see that h' does not meet b , which means that the line a is parallel to the line b in the given direction.

Now suppose that a, b lie on opposite sides of the line c . Then the lines b, c lie on the same side of the line a (see L 1.2.19.25). Take a point $A \in a$ and a ray h' such that $h' \subset \text{Int}\angle(A_C, h)$, $h' \subset \text{Int}\angle(A_B, h)$, where $h = l_{\text{im}}(c, A)$. Observe that, since the lines a, c are directionally parallel, the ray h lies on the line a . For the same reason, the ray h' meets the line c . Now we see from the preceding lemma (L 3.1.4.1) that the ray h' also meets the line b . Since the choice of h' was arbitrary, we see that a is directionally parallel to b , as required. \square

If a, b are parallel, but not directionally parallel, they are said to be hyperparallel or ultraparallel.

Theorem 3.1.5. *Two (distinct) lines a, b , perpendicular to a line c , are hyperparallel.*

Proof. Follows from the (previously shown) fact that the angles of parallelism are always acute. \square

Theorem 3.1.6. *If $A, B \in a, C, D \in b$, points A, D lie on opposite sides of the line a_{BC} , and $\angle ABC \equiv \angle BCD$, then the lines a, b are hyperparallel.*

Proof. Let O be the midpoint of the interval BC (see T 1.3.22). Taking points $E \in a, F \in b$ such that $a_{OE} \perp a, a_{OF} \perp b$ (see L 1.3.8.3). Since the angles $\angle ABC = \angle ABO$ and $\angle BCD = \angle OCD$, being congruent, are either both acute or both obtuse, from C 1.3.18.11 we see that either $(E \in B_A) \& (F \in C_D)$, or $(E \in B_A^c) \& (F \in C_D^c)$. Hence, using T 1.3.6 if necessary, we conclude that $\angle OBE \equiv \angle OCF$. Evidently, since both $\angle OEB$ and $\angle OFC$ are right angles, they are congruent (T 1.3.16). Therefore, we can write $OB \equiv OC \& \angle OBE \equiv \angle OCF \& \angle OEB \equiv \angle OFC \xrightarrow{\text{T1.3.19}} \triangle OBE \equiv \triangle OCF \Rightarrow \angle BOE \equiv \angle COF$. Observe that the points E, F lie on opposite sides of the line a_{BC} .³¹ Since also $O_C = O_B^c$, using C 1.3.7.1 we conclude that $O_F = O_E^c$ and, consequently, the points E, O, F are collinear. Hence (see L 1.2.11.15) $E_O = E_F, F_E = F_O$. Therefore, the line a_{EF} is perpendicular to both a and b , whence the result follows by the preceding theorem T 3.1.5. \square

Corollary 3.1.6.1. *If $A, B \in a, C, D \in b$, points B, D lie on the same side of the line a_{AC} , and the angles $\angle BAC, \angle ACD$ are supplementary, then the lines a, b are hyperparallel.*

Proof. Take a point E such that $[DCE]$ (see A 1.2.2). Then $[DCE] \Rightarrow \angle ACE = \text{adjsp}\angle ACD$. Furthermore, the points D, E lie on the opposite sides of the line a_{AC} (see L 1.2.17.10). Since (by hypothesis) the angles $\angle BAC, \angle ACD$ are supplementary, we have $\angle BAC \equiv \angle ACE$. Now, using T 3.1.6 we find that the lines a, b are hyperparallel. \square

Theorem 3.1.7. *Given two parallel (in the sense of absolute geometry, i.e. non-intersecting) lines a, b , there is at most one line c , perpendicular to both of them.*

Proof. Otherwise we would get a rectangle, in contradiction with C 3.1.1.2. \square

Theorem 3.1.8. *Given two parallel (in the sense of absolute geometry, i.e. non-intersecting) lines a, b , the set of points on b equidistant from a contains at most two elements.*

Proof. Suppose the contrary, i.e. that there are points $A, B, C \in b$ and $A', B', C' \in a$ such that $AA' \perp a, BB' \perp a, CC' \perp a$, and $AA' \equiv BB' \equiv CC'$. \square

Theorem 3.1.9. *Proof.* \square

Theorem 3.1.10. *Proof.* \square

We shall now construct the configuration we will refer to as the NTD configuration.³²

Take a line b and a point A not on it. Let B be a point $B \in b$ such that $a_{AB} \perp b$ (see L 1.3.8.1). Suppose, further, that Q is a point on a line $a \ni A$ with the additional condition that the angle $\angle BAQ$ is obtuse.

Now we construct an infinite sequence of congruent intervals inductively as follows:

Take a point $A_1 \in a_Q$.³³ Then take a point A_2 such that $[AA_1A_2]$ and $AA_1 \equiv A_1A_2$.³⁴ Now suppose that we already have the first $n - 1$ members of the sequence: A_1, A_2, \dots, A_{n-1} . We define the next member A_n of the sequence by the requirements that $[A_{n-2}A_{n-1}A_n]$ and $AA_1 \equiv A_{n-1}A_n$.

³⁰That such a ray h' actually exists can easily be shown using L 1.2.21.21, L 1.2.21.27. In fact, from L 1.2.21.21 we can assume without loss of generality that $A_B \subset \text{Int}\angle(h, A_C)$. Now choosing $h' \subset \text{Int}\angle(h, A_B)$ (see, for example, C 1.2.31.14 for a much stronger statement concerning the possibility of this choice), we get the required conclusion from L 1.2.21.27.

³¹In fact, we know (see above) that either both A, E lie on a on the same side of B (and thus lie on the same side of a_{BC}) and D, F lie on b on the same side of C , or A, E lie on a on the opposite sides of B (and thus lie on the opposite sides of a_{BC}) and D, F lie on b on the opposite sides of C . Hence from L 1.2.19.8, L 1.2.17.9, L 1.2.17.10 we conclude that E, F lie on opposite sides of the line a_{BC} .

³²Due to the Arab astronomer and mathematician of the 13th century Nasir al-Din al-Tusi.

³³Note that using A 1.3.1 we can choose A_1 so that the interval AA_1 is congruent to any interval given in advance.

³⁴Of course, $[AA_1A_2]$ is equivalent to $A_2 \in A_{1A}$.

It is obvious from construction that all the intervals $AA_1, A_1A_2, \dots, A_{n-1}A_n, \dots$ are congruent. Furthermore, the points of any finite $(n+1)$ -tuple of points AA_1, A_2, \dots, A_n are in order $[AA_1A_2 \dots A_n]$.³⁵ Denote $B_i, i = 1, 2, \dots, n(\dots)$ the feet of the perpendiculars to a drawn through the corresponding points A_i . Observe that, due to C 1.3.26.10, this immediately implies that the points $B, B_1, B_2, \dots, B_{n-1}, B_n(\dots)$ are in order $[BB_1B_2 \dots B_{n-1}B_n(\dots)]$. In particular, the points $B_1, B_2, \dots, B_{n-1}, B_n(\dots)$ all lie on the same side of the point B .

Theorem 3.1.11. *In the NTD configuration defined above we have $AB < A_1B_1 < A_2B_2 \dots A_{n-1}B_{n-1} < A_nB_n < \dots$. What is more, we can claim that $\mu A_1B_1 - \mu AB < \mu A_2B_2 - \mu A_1B_1 < \dots < A_{n-1}B_{n-1} - A_{n-2}B_{n-2} < A_nB_n - A_{n-1}B_{n-1} < \dots$. Also, $\mu BB_1 > B_1B_2 > \dots > B_{n-2}B_{n-1}B_{n-1}B_n > \dots$*

*Proof.*³⁶ Using A 1.3.1, choose points $C_i \in B_iA_i$ so that $B_iA_i \equiv B_{i+1}C_{i+1}$, where $i = 1, 2, \dots, n, \dots$ and we denote $A_0 \equiv A, B_0 \equiv B$. We are going to show that the ray $A_{i-1}C_i$ lies inside the angle $\angle B_{i-1}A_{i-1}A_i$ for all $i = 1, 2, \dots, n, \dots$. First, observe that the angles $\angle B_{i-1}A_{i-1}A_i, i \in \mathbb{N}$ are all obtuse. In fact, the angle $\angle BAA_1 = \angle BAQ$ is obtuse by construction. Using L 3.1.1.5, we can write the following chain of inequalities:

$$\angle BAA_1 < \angle B_1A_1A_2 < \dots < B_{n-1}A_{n-1}A_n < B_nA_nA_{n+1} < \dots,$$

which ensure that the angles $\angle B_1A_1A_2, \angle B_2A_2A_3, \dots, \angle B_{n-1}A_{n-1}A_n, \dots$ are also obtuse.³⁷

On the other hand, the angle $\angle B_{i-1}A_{i-1}C_i, i \in \mathbb{N}$, is acute as being a summit angle in the Saccheri quadrilateral $A_{i-1}B_{i-1}B_iC_i$ with the right angles $\angle A_{i-1}B_{i-1}B_i$ and $\angle B_{i-1}B_iC_i$ (see C 3.1.1.3).

Since $\angle B_{i-1}A_{i-1}C_i < \angle B_{i-1}A_{i-1}A_i$ ³⁸ and the rays $A_{i-1}C_i, A_{i-1}A_i$ lie on the same side of the line $a_{B_{i-1}A_{i-1}}$,³⁹ the ray $A_{i-1}C_i$ lies inside the angle $\angle B_{i-1}A_{i-1}A_i$ for all $i = 1, 2, \dots, n, \dots$

Now we intend to show that $C_i \in (B_iA_i)$ for all $i \in \mathbb{N}$. Since $A_{i-1}B_{i-1}B_iC_i$, being a Saccheri quadrilateral, is convex, the ray $A_{i-1}B_i$ lies inside the angle $\angle B_{i-1}A_{i-1}C_i$ (see L 1.2.62.4). Now we can write $A_{i-1}C_i \subset \text{Int}\angle B_{i-1}A_{i-1}A_i \& A_{i-1}B_i \subset \text{Int}\angle B_{i-1}A_{i-1}C_i \xrightarrow{\text{L1.2.21.27}} A_{i-1}C_i \subset \text{Int}\angle B_iA_{i-1}A_i$. In view of L 1.2.21.6, L 1.2.21.4 the ray $A_{i-1}C_i$ is bound to meet the open interval B_iA_i in some point C'_i . Since the lines $a_{A_{i-1}C_i}, a_{B_iA_i}$ are distinct, we find that $C'_i = C_i$.

Now, using C 1.3.13.4, we see that $B_iC_i < B_iA_i$ for every $i \in \mathbb{N}$.

Now we are going to show that the intervals $C_1A_1, C_2A_2, \dots, C_nA_n, \dots$ form a monotonously increasing sequence, i.e. that $C_iA_i < C_{i+1}A_{i+1}$ for all $i \in \mathbb{N}$. Consider the triangle $A_{i-1}C_iA_i$ for an arbitrary $i \in \mathbb{N}$. Taking a point C'_i such that $[C_iA_iC'_i]$ and $C_iA_i \equiv A_iC'_i$ (see A 1.3.1), we find (taking into account that $[A_{i-1}A_iA_{i+1}]$, $A_{i-1}A_i \equiv A_iA_{i+1}$, and $\angle A_{i-1}A_iC_i \equiv \angle C'_iA_iA_{i+1}$ (as vertical; see T 1.3.7)) that $\triangle A_{i-1}A_iC_i \equiv \triangle C'_iA_iA_{i+1}$ and, consequently, $\angle A_{i-1}C_iA_i \equiv \angle A_iC'_iA_{i+1}$. Observe that the angle $\angle A_{i-1}C_iA_i$, being adjacent complementary to the summit angle $\angle A_{i-1}C_iB_i$ of the Saccheri quadrilateral $A_{i-1}B_{i-1}B_iC_i$, is obtuse. Hence the angle $\angle A_iC'_iA_{i+1}$, congruent to it, is also obtuse. Taking a point C''_{i+1} such that $[B_{i+1}C_{i+1}C''_{i+1}]$ and $A_iC'_i \equiv C_{i+1}C''_{i+1}$, we obtain a Saccheri quadrilateral $C'_iB_iB_{i+1}C''_{i+1}$.⁴⁰ Using arguments very similar to those already employed once in the present proof, it is easy to show that $[C_{i+1}C''_{i+1}A_{i+1}]$ and thus $C_iA_i < C_{i+1}A_{i+1}$.⁴¹

Finally, we are going to show that the intervals $B_0B_1, B_1B_2, \dots, B_{n-1}B_n, B_nB_{n+1}, \dots$ form a monotonously decreasing sequence, i.e. $B_iB_{i+1} < B_{i-1}B_i$ for all $i \in \mathbb{N}$.

For an arbitrary $i \in \mathbb{N}$ choose a (unique) point A'_{i-1} such that the points A'_{i-1}, A_{i+1} lie on the opposite sides of the line $a_{A_iB_i}$, $\angle B_iA_iA'_{i-1} \equiv \angle B_iA_iA_{i+1}$, and $A_iA'_{i-1} \equiv A_iA_{i+1}$ (see A 1.3.1, A 1.3.4). Denote now by B'_{i-1} the foot of the perpendicular to b drawn through A'_{i-1} (see L 1.3.8.1).

Suppose that the ray $A_iA'_{i-1}$ does not meet the ray $B_{i-1}A_{i-1}$. Then it has no common points with the whole line $a_{A_{i-1}B_{i-1}}$.

Since the ray $A_iA'_{i-1}$ lies on the same side of the line $a_{A_iB_i}$ as the line $a_{A_{i-1}B_{i-1}}$ and on the same side of the line $a_{A_{i-1}B_{i-1}}$ as the line $a_{A_iB_i}$, by the definition of strip interior the ray $A_iA'_{i-1}$ lies inside the strip $a_{A_{i-1}B_{i-1}}a_{A_iB_i}$. Consequently, the point A'_{i-1} and with it the whole line $A'_{i-1}B'_{i-1}$ (see L 1.2.19.20) lies inside $a_{A_{i-1}B_{i-1}}a_{A_iB_i}$. But this, in turn, implies that the point B'_{i-1} lies between B_{i-1}, B_i (see L 1.2.19.16), whence $B_iB'_{i-1} < B_iB_{i-1}$ (see C 1.3.13.4). Since, by construction, $A_iA'_{i-1} \equiv A_iA_{i+1}$ and $\angle B_iA_iA'_{i-1} \equiv \angle B_iA_iA_{i+1}$, in view of P ?? we have $B_iB'_{i-1} \equiv B_iB_{i+1}$. Now we see that $B_iB'_{i-1} \equiv B_iB_{i+1} \& B_iB'_{i-1} < B_iB_{i-1} \Rightarrow B_iB_{i+1} < B_{i-1}B_i$.

³⁵Compare with proof of L 1.3.21.11.

³⁶As is customary, in the more lengthy proofs such as this one we omit some (hopefully!) trivial details of argumentation, leaving it to the pedantic reader to fill the gaps.

³⁷Of course, we are using the obvious fact that any angle greater than an obtuse angle is also acute.

³⁸Any acute angle is less than any obtuse angle - see L 1.3.16.19.

³⁹To show that the rays $A_{i-1}C_i, A_{i-1}A_i$ lie on the same side of the line $a_{B_{i-1}A_{i-1}}$ one may observe that all points, including C_i , of the line $a_{B_iA_i}$, which is parallel to the line $a_{B_{i-1}A_{i-1}}$, lie on the same side of the line $a_{B_{i-1}A_{i-1}}$.

⁴⁰Note that $B_iC'_i \equiv B_{i+1}C''_{i+1}$ according to A 1.3.3.

⁴¹In fact, the points C''_{i+1}, A_{i+1} and thus the rays $C'_iC''_{i+1}, C'_iA_{i+1}$ lie on the same side of the line $a_{B_iA_i}$. Since the acute angle $\angle B_iC'_iC''_{i+1}$ (it is acute as being a summit angle of the Saccheri quadrilateral $C'_iB_iB_{i+1}C''_{i+1}$) is less than the obtuse angle $\angle B_iC'_iA_{i+1} = \angle A_iC'_iA_{i+1}$ (see L 1.3.16.19), we find that the ray $C'_iC''_{i+1}$ lies inside the angle $\angle B_iC'_iA_{i+1}$. Since the Saccheri quadrilateral $C'_iB_iB_{i+1}C''_{i+1}$ is convex, the ray C'_iB_{i+1} lies inside the angle $\angle B_iC'_iC''_{i+1}$ (see L 1.2.62.4). Using L 1.2.21.27 we see that the ray $C'_iC''_{i+1}$ lies (completely) inside the angle $\angle B_{i+1}C'_iC''_{i+1}$. By L 1.2.21.6, L 1.2.21.4 there is then a point $C'''_{i+1} \in C'_iC''_{i+1}$ such that $[B_{i+1}C'''_{i+1}A_{i+1}]$. Since the lines $a_{C'_iC''_{i+1}}$ are evidently distinct, we find that $C'''_{i+1} = C''_{i+1}$. Now we can write $[B_{i+1}C_{i+1}C''_{i+1}] \& [B_{i+1}C''_{i+1}A_{i+1}] \xrightarrow{\text{L1.2.3.2}} [C_{i+1}C''_{i+1}A_{i+1}]$.

Now suppose that the ray $A_i A'_{i-1}$ does meet the ray $B_{i-1} A_{i-1}$ in some point A''_{i-1} . We are going to show that $[B_{i-1} A_{i-1} A'_{i-1}]$. First, we will demonstrate that the ray $A_i A_{i-1}$ lies inside the angle $\angle B_i A_i A'_{i-1}$. In fact, since the angle $\angle B_i A_i A_{i-1}$ is acute (as being adjacent supplementary to the angle $\angle B_i A_i A_{i+1}$ we have shown to be acute) and the angle $\angle B_i A_i A'_{i-1}$ is obtuse (as being congruent by construction to the obtuse angle $\angle B_i A_i A_{i+1}$), we find that $\angle B_i A_i A_{i-1} < \angle B_i A_i A'_{i-1}$. But since $A_{i-1} A'_{i-1} a_{B_i A_i}$, this inequality implies that the ray $A_i A_{i-1}$ lies inside the angle $\angle B_i A_i A''_{i-1} = \angle B_i A_i A'_{i-1}$. But the ray $A_i B_{i-1}$, in turn, lies inside the angle $\angle B_{i-1} B_i A_i$, as can be seen, for example, observing the ray the convexity of the birectangle $A_{i-1} B_{i-1} B_i A_i$ (see L 1.2.62.4). Hence in view of L 1.2.21.27 we find that the ray $A_i A_{i-1}$ lies inside the angle $\angle B_i A_i A''_{i-1}$. By L 1.2.21.10 this means that the ray $A_i A_{i-1}$ and the open interval $(B_{i-1} A''_{i-1})$ meet in some point, which, in view of the distinctness of the lines $a_{A_{i-1} A_i}$, $a_{B_{i-1} A_{i-1}}$, coincides with the point A_{i-1} . Thus, we see that the point A_{i-1} lies between points B_{i-1} and A''_{i-1} . Therefore, we can write $[B_{i-1} A_{i-1} A''_{i-1}] \Rightarrow \angle A''_{i-1} A_{i-1} A_i = \text{adjsp} \angle B_{i-1} A_{i-1} A_i \Rightarrow \mu \angle A''_{i-1} A_{i-1} A_i + \mu \angle B_{i-1} A_{i-1} A_i = \pi^{(abs)}$. On the other hand, from C 3.1.1.3 we have $\mu \angle B_{i-1} A''_{i-1} A_i + \mu \angle B_i A_i A''_{i-1} < \pi^{(abs)}$, since $\angle B_{i-1} A''_{i-1} A_i$ and $\angle B_i A_i A''_{i-1}$ are the summit angles of the birectangle $A''_{i-1} B_{i-1} B_i A_i$. Therefore, we have $\mu \angle B_{i-1} A''_{i-1} A_i + \mu \angle B_i A_i A''_{i-1} < \mu \angle A''_{i-1} A_{i-1} A_i + \mu \angle B_{i-1} A_{i-1} A_i$. Taking into account that (by construction) $\angle B_i A_i A''_{i-1} \equiv \angle B_i A_i A_{i+1}$, $B_{i-1} A_{i-1} A_i < B_i A_i A_{i+1}$, and $\angle A_{i-1} A''_{i-1} A_i = \angle B_{i-1} A''_{i-1} A_i$ (see L 1.2.11.15) using P 1.3.63.8 we can write $\angle A_{i-1} A''_{i-1} A_i < \angle A''_{i-1} A_{i-1} A_i$, which, in view of T 1.3.18, implies that $A_{i-1} A_i < A''_{i-1} A_i$. Since, by construction, $A_{i-1} A_i \equiv A_i A_{i-1}$, $A_i A_{i+1} \equiv A_i A'_{i-1}$ and the points A'_{i-1} , A''_{i-1} lie on the same side of the point A_i ,⁴² we conclude using C 1.3.13.4 that $[A_i A'_{i-1} A''_{i-1}]$. Proceeding as above, we find again that $B_i B_{i+1} < B_{i-1} B_i$. \square

Corollary 3.1.11.1. *Suppose we are given lines a , b and points A , B such that $a_{AB} \perp a$, $a_{AB} \perp b$. Suppose further that we are given an arbitrary interval CD . Then on any ray into which the point A separates the line a there is a point E such that $EF > CD$, where F is the foot of the perpendicular to b drawn through E .*

Proof. Follows from the preceding theorem (T 3.1.11) and Archimedes' axiom (A 1.4.1). \square

Theorem 3.1.12. *Given a line a , a point $D \notin a$ not on it, an angle $\angle(h, k)$, and an interval EF , there are points $B \in a$ and $C \in A_D$ such that $\angle ABC \equiv \angle(h, k)$, $BC \equiv EF$.*

Proof. \square

Corollary 3.1.12.1. *Given a line a , a point $D \notin a$ not on it, and an interval EF , there is a point $C \in A_D$ such that $BC \equiv EF$, where the point $B \in a$ is such that $a_{BC} \perp a$.⁴³*

Proof. \square

Theorem 3.1.13. *Proof.* \square

Theorem 3.1.14. *Any two hyperparallel lines have a common perpendicular.*

Proof. \square

Theorem 3.1.15. *Suppose that the angles $\angle A$, $\angle B$, $\angle C$, of the triangle $\triangle ABC$ are congruent, respectively, to the angles $\angle A'$, $\angle B'$, $\angle C'$, of the triangle $\triangle A'B'C'$. Then the triangles $\triangle ABC$, $\triangle A'B'C'$ are congruent.*

Proof. Suppose the contrary, i.e. that the triangles $\triangle ABC$, $\triangle A'B'C'$ are not congruent. Then we can assume without loss of generality that the side AB of $\triangle ABC$ is not congruent to the side $A'B'$ of $A'B'C'$ and, furthermore, that $AB < A'B'$.⁴⁴ By L 1.3.13.3 there is a point $B'' \in (A'B')$ such that $AB \equiv A'B''$. Using A 1.3.1, we also take a point $C'' \in A'C'$ such that $AC \equiv A'C''$. Then, evidently, $\angle B''A'C'' = \angle B'A'C'$, $\angle BAC \equiv \angle B'A'C' & \angle B''A'C'' = \angle B'A'C' \Rightarrow \angle BAC = \angle B''A'C''$, $AB \equiv A'B'' & AC \equiv A'C'' & \angle BAC \equiv \angle B''A'C'' \xrightarrow{T1.3.4} \triangle ABC \equiv \triangle A'B''C'' \Rightarrow \angle ABC \equiv \angle A''B''C'' & \angle BCA \equiv \angle B''C''A'$. Since $C'' \in A'C'$, we see that either $C'' = C'$, or $[A'C''C']$, or $[A'C'C'']$. We are going to show that each of these options is contradictory. First, suppose $C'' = C'$. Then $\angle ABC \equiv \angle A'B'C' & \angle ABC \equiv \angle A'B''C'' \xrightarrow{L1.3.11.1} \angle A'B'C' \equiv \angle A'B''C''$. Since also $[A'B''B'] \xrightarrow{L1.2.11.15} \angle B''B'C' = \angle A'B'C'$, we obtain $\angle B''B'C' \equiv \angle A'B'C'$, in contradiction with T 1.3.17.⁴⁵ Suppose now that the point C'' lies between A' , C' . Since all angles of the triangle $\triangle A'B'C'$ are congruent to the corresponding angles of the triangle $\triangle A'B''C''$, their (abstract) angle sums are equal, which again leads to contradiction in view of C 1.3.67.16. Finally, suppose that $[A'C'C'']$. In view of C 1.2.1.7 the open intervals $(B'C')$, $(B''C'')$ meet in some point D . Obviously, $[B'DC'] & [B''DC''] & [A'B'B''] \xrightarrow{L1.2.11.15} \angle B''B'D' = \angle A'B'C' & \angle A'B''D' = \angle A'B''C''$, whence $\angle B''B'D' \equiv \angle A'B''D'$, and we arrive once more to a contradiction with T 1.3.17. The contradictions obtained establish that $\triangle ABC \equiv \triangle A'B'C'$, q.e.d. \square

⁴²Note that, by construction, both A'_{i-1} , A_{i+1} and A''_{i-1} , A_{i+1} lie on the opposite sides of A_i , whence we conclude using L 1.2.11.10 that the points A'_{i-1} , A''_{i-1} lie on the same side of A_i .

⁴³In other words, B is the foot of the perpendicular to a drawn through C .

⁴⁴This is due to symmetry of congruence relation and to the fact that cyclic rearrangements of sides do not affect in any way the congruence properties of polygons (see P 1.3.1.4).

⁴⁵Alternatively, this case can be brought to contradiction using the angle sum argument (see the analysis of the next case later in this proof) and C 1.3.67.15.

Theorem 3.1.16. *Proof.* \square

Theorem 3.1.17. *Consider two simple quadrilaterals, $ABCD$ and $A'B'C'D'$ with $AB \equiv A'B'$, $\angle ABC \equiv \angle A'B'C'$, $\angle BCD \equiv \angle B'C'D'$, $\angle BAD \equiv \angle B'A'D'$, $\angle CDA \equiv \angle C'D'A'$. Suppose further that if A, D lie on the same side of the line a_{BC} then A', D' lie on the same side of the line $a_{B'C'}$, and if A, D lie on the opposite sides of the line a_{BC} then A', D' lie on the opposite sides of the line $a_{B'C'}$. Then the quadrilaterals are congruent, $ABCD \equiv A'B'C'D'$.*

Proof. Using A 1.3.1, we take points $A'' \in B'A'$, $D'' \in C'D'$ such that $BA \equiv B'A''$, $CD \equiv C'D''$. We start with the case where the points A, D lie on the opposite sides of the line a_{BC} . Then, by hypothesis, A', D' lie on the opposite sides of the line $a_{B'C'}$. Since, by construction, $A'' \in B'A'$, $D'' \in C'D'$, it is easy to see using T 1.2.20 that the points A'', D'' lie on the opposite sides of the line $a_{B'C'}$. Therefore, we can write $AB \equiv A''B' \& BC \equiv B'C' \& CD \equiv C'D'' \& \angle ABC \equiv \angle A''B'C' \& \angle BCD \equiv \angle B'C'D'' \& (Aa_{BC}D \& A''a_{B'C'}D'') \stackrel{P1.3.19.3}{\implies} ABCD \equiv A''B'C'D'' \Rightarrow \angle DAB \equiv \angle D''A''B' \& \angle CDA \equiv \angle C'D''A''$, $\angle DAB \equiv \angle D'A'B' \& \angle DAB \equiv \angle D''A''B' \stackrel{L1.3.11.1}{\implies} \angle D'A'B' \equiv \angle D''A''B'$, $\angle CDA \equiv \angle C'D'A' \& \angle CDA \equiv \angle C'D''A'' \stackrel{L1.3.11.1}{\implies} \angle C'D'A' \equiv \angle C'D''A''$.

Denote $E \equiv (AD) \cap a_{BC}$, $E' \equiv (A'D') \cap a_{B'C'}$, $E'' \equiv (A''D'') \cap a_{B'C'}$. In view of T 1.2.2 we have either $[EBC]$ or $[BCE]$ and, similarly, either $[E'B'C']$ or $[B'C'E']$ and either $[E''B'C']$ or $[B'C'E'']$. (Evidently, due to simplicity of $ABCD$, $A'B'C'D'$, $A''B'C'D''$ we can immediately discard from our consideration the cases $E = B$, $[BEC]$, $E = C$, $E' = B'$, $[B'E'C']$, $E' = C'$, $E'' = B'$, $[B'E''C']$, $E'' = C'$. We are going to show that if $[EBC]$ then also $[E'B'C']$. To establish this suppose the contrary, i.e. that both $[EBC]$ and $[B'C'E']$. Then, using T 1.3.17 we would have $\angle BCD = \angle ECD < \angle AEC = \angle AEB < \angle ABC \equiv \angle A'B'C' = \angle A'B'E' < \angle B'E'D' = \angle C'E'D' < \angle B'C'D'$ (see also L 1.2.11.15), whence $\angle BCD < \angle B'C'D'$ (see L 1.3.16.6 – L 1.3.16.8), which contradicts $\angle BCD \equiv \angle B'C'D'$ in view of L 1.3.16.11. Thus, we see that $[EBC]$ implies $[E'B'C']$. Similar arguments show that $[BCE]$ implies $[B'C'E']$.⁴⁷ Since, obviously, $\angle A'B'C' = \angle A'B'C'$, $\angle B'C'D'' = \angle B'C'D'$ (see L 1.2.11.15), and, consequently, $\angle ABC \equiv \angle A'B'C''$, $\angle BCD \equiv \angle B'C'D''$, it is easy to see that also $[EBC]$ implies $[E''B'C']$ and $[BCE'']$ implies $[B'C'E'']$.

Consider first the case where $[EBC]$, $[E'B'C']$, $[E''B'C']$. We then have $[A'E'D'] \& B' \in (E'C') \stackrel{C1.2.1.7}{\implies} \exists F'([C'F'D'] \& [A'B'F'])$. Similarly, $[A''E''D''] \& B' \in (E''C'') \stackrel{C1.2.1.7}{\implies} \exists F''([C'F''D''] \& [A''B'F''])$. Evidently, $F'' = F'$. In fact, as the points A'', A', B' colline even if the points A'', A' were distinct (which, as we are about to show, they are not), the lines $a_{A''B'} = a_{A'B'}$ and $a_{C'D'} = a_{C'D''}$ (distinct due to simplicity of $A'B'C'D'$) can meet in at most one point (see T 1.1.1), which happens to be $F'' = F'$. Since both C', D' and C'', D'' lie on the opposite sides of $F'' = F'$, by L 1.2.11.10 the points D'', D' lie on the same side of F' even if $D'' \neq D'$. (Which again, as we are about to prove, they are not.) Using L 1.2.11.16 we can also see that the points A', A'' lie on the same side of the point F' .⁴⁸

Observe that $[C'F'D'] \stackrel{L1.2.11.15}{\implies} \angle C'D'A' = \angle F'D'A'$, $[C'F'D''] \stackrel{L1.2.11.15}{\implies} \angle C'D''A'' = \angle F'D''A''$, $[F'B'A'] \stackrel{L1.2.11.15}{\implies} \angle D'A'B' = \angle D'A'F'$, $[F'B'A''] \stackrel{L1.2.11.15}{\implies} \angle D''A''B' = \angle D''A''F'$. Furthermore, since, as we have seen, the points D'', D' lie on the same side of F' as do the points A', A'' , the angles $\angle D'F'A'$, $\angle D''F'A''$ are equal and thus are congruent. Therefore, we can write $\angle D'F'A' \equiv \angle D''F'A'' \& \angle F'D'A' \equiv \angle F'D''A'' \& \angle D'A'F' \equiv \angle D''A''F' \stackrel{T3.1.15}{\implies} \triangle F'D'A' \equiv \triangle F'D''A'' \Rightarrow F'D' \equiv F'D'' \& F'A' \equiv F'A''$, whence in view of T 1.3.2 (taking into account that the points D'', D' , as well as the points A', A'' , lie on the same side of F') we are forced to conclude that $D' = D''$ and $A' = A''$.

Consider now the case where $[BCE]$ and, consequently, $[B'C'E']$, $[B'C'E'']$ (see above), while the points A, D still lie on the opposite sides of the line a_{BC} (and, consequently, (by hypothesis) the points A', D' , as well as the points A'', D'' , lie on the opposite sides of $a_{B'C'}$). We then have⁴⁹ $[A'E'D'] \& C' \in (B'E') \stackrel{C1.2.1.7}{\implies} \exists F'([D'C'F'] \& [B'F'A'])$. Similarly, $[A''E''D''] \& C' \in (B'E'') \stackrel{C1.2.1.7}{\implies} \exists F''([D''C''F''] \& [B''F''A''])$. Evidently, $F'' = F'$ (shown as above)⁵⁰

⁴⁶Obviously, E exists by definition of "points A, D lie on the opposite sides of a_{BC} "

⁴⁷Observe that the quadrilaterals $ABCD$, $A'B'C'D'$ enter the conditions of the theorem symmetrically.

⁴⁸We could do the rest of the proof in this case without using T 1.3.15 (which is used in the main body of the text), but this would take much more work and proceed something like as follows: Note that the points D'', D' lie on the same side of the line $a_{A''B'} = a_{A'B'}$ (see L 1.2.11.10). (Otherwise, we would also have $D'' = D'$ and the proof would be complete. In fact, suppose the contrary, i.e. that $A'' = A'$ but $D'' \neq D'$. Then, taking into account that $D'' \in C'D'$, in view of L 1.2.11.8 we have either $[C'D'D'']$ or $[C'D'D']$. Assuming that $[C'D'D'']$ (evidently, we can do this without any loss in generality) and using T 1.3.17, we find that the angle $\angle C'D'D''$, being the exterior angle of the triangle $\triangle D'A'D''$, is greater than the interior angle $\angle D'D''A = \angle C'D''A'$ (see L 1.2.11.15). This contradicts the congruence $\angle C'D'A' \equiv \angle C'D''A''$ established above (L 1.3.16.11). The contradiction shows that $A'' = A'$ necessarily implies $D'' = D'$.) Suppose $A'' \neq A'$. As $A'' \in B'A'$, in view of L 1.2.11.8 we have either $[B'A'A'']$ or $[B'A'A']$. We can assume without any loss in generality that $[B'A'A'']$. (The other case is then immediately taken care of by the simultaneous substitutions $A' \leftrightarrow A''$, $D' \leftrightarrow D''$.) Since $[B'A'A'']$, the points D'', D' lie on the same side of the line $a_{A''B'} = a_{A'B'}$, and $D'A'B' \equiv \angle D''A''B'$, the lines $a_{A'D'}$, $a_{A''D''}$ are parallel (T 1.3.26). Hence using T 1.2.44 we find that $[F'D'D'']$. Thus, not only is the angle $\angle D'A'A''$ adjacent supplementary to the angle $\angle D'A'B' = \angle D'A'F'$, but also the angle $\angle A'D'D''$ is adjacent supplementary to the angle $\angle A'D'F' = \angle A'D'C'$. Since, as we have seen, $\angle B'A'D' \equiv \angle B'A'D''$ and $\angle C'D'A' \equiv \angle C'D''A''$, we find that the angles $\angle D'A'A''$, $\angle D''A''A' = \angle D''A''B'$ are supplementary, as are the angles $\angle A'D'D''$, $\angle A''D''D' = \angle A''D''C'$ (note that $[C'F'D'] \& [F'D'D''] \stackrel{L1.2.3.1}{\implies} [C'D'D'']$). Hence we find that $\Sigma_{A'D'D''A''}^{(abs)\angle} = 2\pi^{(abs,xt)}$, in contradiction with C 3.1.1.2. This contradiction shows that in reality in the given case we have $A' = A''$ and, as a consequence, $D' = D''$.

⁴⁹Observe that the following argument is similar to that employed previously in this proof in our treatment of the preceding case.

⁵⁰Since the points A'', A', B' colline even if the points A'', A' were distinct (which, as we are about to show, they are not), the lines $a_{A''B'} = a_{A'B'}$ and $a_{C'D'} = a_{C'D''}$ (distinct due to simplicity of $A'B'C'D'$) can meet in at most one point (see T 1.1.1), which happens

Again,⁵¹ the points D'' , D' lie on the same side of F' even if $D'' \neq D'$. Note that $[D'C'F'] \stackrel{L1.2.11.15}{\implies} \angle C'D'A' = \angle F'D'A'$, $[D''C'F'] \stackrel{L1.2.11.15}{\implies} \angle C'D''A'' = \angle F'D''A''$, $[B'F'A'] \stackrel{L1.2.11.15}{\implies} \angle D'A'B' = \angle D'A'F'$, $[B'F'A''] \stackrel{L1.2.11.15}{\implies} \angle D''A''B'' = \angle D''A''F''$. As before, we see that the angles $\angle D'F'A'$, $\angle D''F'A''$ are equal and thus are congruent.⁵² And, observing that the points A' , A'' lie on the same side of the point F' ,⁵³ we can bring this case to contradiction exactly as above.⁵⁴

Suppose now that the points A , D lie on the same side of the line a_{BC} , and, consequently (by hypothesis) the points A' , D' lie on the same side of the line $a_{B'C'}$. Since, by construction, the points A' , A'' lie on the same side of the point of B' , we have either $[B'A'A'']$, or $[B'A''A']$, or $A'' = A'$ (see L 1.2.11.8). Similarly, the points D' , D'' lie on the same side of the point of C' , we have either $[C'D'D'']$, or $[D'D''C']$, or $D'' = D'$ (see L 1.2.11.8). To show that $A'' = A'$, $D'' = D'$ we are going to bring to contradiction the other options. Suppose $[B'A'A'']$. Then $\angle A'A''D'' = \angle B'A''D'$ (see L 1.2.11.15), $\angle A''A'D' = \text{adjsp} \angle B'A'D'$. Taking into account that, as shown above, $\angle B'A'D' \equiv \angle B'A''D''$, we see that $\mu \angle A'A''D'' + \mu \angle A''A'D' = \pi^{(abs)}$. Similarly, the assumption that $[B'A'A'']$ also gives the equality $\mu \angle A'A''D'' + \mu \angle A''A'D' = \pi^{(abs)}$.⁵⁵ Employing similar arguments, it is easy to show that if $[C'D'D'']$ or $[D'D''C']$ then $\mu \angle A'D'D'' + \mu \angle A'D''D' = \pi^{(abs)}$.⁵⁶ Finally, it is easy to see that the equalities $\mu \angle A'A''D'' + \mu \angle A''A'D' = \pi^{(abs)}$, $\mu \angle A'D'D'' + \mu \angle A'D''D' = \pi^{(abs)}$ lead us to contradiction with P 3.1.1.1, C 3.1.1.2 for all cases except $A'' = A'$, $D'' = D'$, which completes the proof. \square

Consider the class of intervals μAB congruent to some given interval AB . In hyperbolic geometry we can put into correspondence with this class a unique class of congruent acute angles using the following construction:

Draw a line $a \ni A$ such that $a \perp a_{AB}$. Choosing one of the two possible directions on a , draw through B the line b parallel to a in that direction. By definition, the Lobachevsky function Π puts into correspondence with the class μAB the class of angles congruent to the angle $\angle(B_A, l_{lim}(a, B))$. We shall refer to $\angle(B_A, l_{lim}(a, B))$, as well as any angle congruent to it, as a Lobachevsky angle. In other words, a Lobachevsky angle is a representative $\angle(h, k) \in \Pi(\mu AB)$ of the class $\Pi(\mu AB)$. To show that the Lobachevsky function is well defined, we need to take another interval $CD \in \mu AB$, choose one of the two possible directions on a line $c \in C$, $c \perp a_{CD}$, draw through D the line d parallel to c in that direction, and show that $\angle(B_A, l_{lim}(a, B)) \equiv \angle(D_C, l_{lim}(c, D))$. To achieve this suppose the contrary, i.e. that either $\angle(B_A, l_{lim}(a, B)) < \angle(D_C, l_{lim}(c, D))$ or $\angle(B_A, l_{lim}(a, B)) > \angle(D_C, l_{lim}(c, D))$ (see L 1.3.16.14). Obviously, without loss of generality we can assume that $\angle(B_A, l_{lim}(a, B)) < \angle(D_C, l_{lim}(c, D))$.⁵⁷ Using A 1.3.4 draw a ray h emanating from D , lying with $l_{lim}(c, D)$ on the same side of a_{CD} and such that $\angle(B_A, l_{lim}(a, B)) \equiv \angle(D_C, h)$. In view of $\angle(B_A, l_{lim}(a, B)) < \angle(D_C, l_{lim}(c, D))$ the ray h lies inside the angle $\angle(D_C, l_{lim}(c, D))$. Hence in view of the definition of $l_{lim}(c, D)$ (as the lower limiting ray) the ray h meets the positive ray of the line c (that is, the ray whose points succeed the point C on the line c) in some point F . Now take a point E on the positive ray of a (that is, the point of this ray succeed A on a) with the additional condition that $AE \equiv CF$ (see A 1.3.1). Observe also that $\angle BAE$, $\angle DCF$ both being right angles, are congruent. Then we can write $AB \equiv CD \& \angle BAE \equiv \angle DCF \& AE \equiv CF \stackrel{T1.3.4}{\implies} \triangle ABE \equiv \triangle CDF \Rightarrow \angle ABE \equiv \angle CDF$. But since $\angle(B_A, l_{lim}(a, B)) \equiv \angle(D_C, h) = \angle CDF$ and the rays B_E , $l_{lim}(a, B)$ lie on the same side of the line a_{AB} , using A 1.3.4 we find that $B_E = l_{lim}(a, B)$, which implies that $l_{lim}(a, B)$ meets the line a , which is absurd in view of $l_{lim}(a, B)$ being the lower limiting ray. This contradiction shows that in fact $\angle(B_A, l_{lim}(a, B)) \equiv \angle(D_C, l_{lim}(c, D))$, as required.

Theorem 3.1.18. *If for some (abstract) intervals AB , CD we have $AB < CD$ (and then, of course, $\mu AB < \mu CD$) then $\Pi(\mu AB) < \Pi(\mu CD)$.*

Proof. Consider the standard construction (see above), namely, a line $a \ni A$ such that $a \perp a_{AB}$, a direction on a , and draw through B the line b parallel to a in that direction. Take (using A 1.3.1) a point $E \in A_B$ such that $CD \equiv AE$. Draw through E the line c parallel to a in the same direction that b is parallel to a . By T 3.1.4 then c is also parallel to b in that direction. To prove the theorem, we need to show that $\angle(B_A, l_{lim}(a, B)) < \angle(E_A, l_{lim}(a, E))$. Using A 1.3.4 draw the ray k emanating from E , lying on the same side of the line a_{AB} and such that $\angle(B_A, l_{lim}(a, B)) \equiv \angle(E_A, k)$. The lines b , \bar{k} are hyperparallel. Now it is easy to see that the ray $l_{lim}(a, E)$ lies inside the angle $\angle(E_A, k)$.⁵⁸ Thus,

to be $F'' = F'$.

⁵¹As both C' , D' and C' , D'' lie on the opposite sides of $F'' = F'$.

⁵²We take into account that the points D'' , D' lie on the same side of F' as do the points A' , A'' .

⁵³This is easily seen using L 1.2.11.16.

⁵⁴We write $\angle D'F'A' \equiv \angle D''F'A'' \& \angle F'D'A' \equiv \angle F'D''A'' \& \angle D'A'F' \equiv \angle D''A''F'' \stackrel{T3.1.15}{\implies} \triangle F'D'A' \equiv \triangle F'D''A'' \Rightarrow F'D' \equiv F'D'' \& F'A' \equiv F'A''$, whence in view of T 1.3.2 (taking into account that the points D'' , D' , as well as the points A' , A'' , lie on the same side of F') we are forced to conclude that $D' = D''$ and $A' = A''$.

⁵⁵This can be seen immediately from symmetry considerations by observing that the properties established up to this point of the points involved are invariant with respect to the simultaneous substitutions $A' \leftrightarrow A''$, $D' \leftrightarrow D''$.

⁵⁶This can be done at once by symmetry using the simultaneous substitutions $B' \leftrightarrow C'$, $A' \leftrightarrow D'$, $A'' \leftrightarrow D''$ (it is easy to see that these substitutions preserve the validity of the facts established so far in this proof) or drawing an easy analogy with our preceding arguments.

⁵⁷This is due to symmetry of the conditions of the theorem. Thus, if CD lies in the class μAB (of intervals congruent to the interval CD) then AB lies in the class μCD (of intervals congruent to the interval AB).

⁵⁸By construction, the rays $l_{lim}(a, E)$, k lie on the same side of the line. Then either the ray k lies inside the angle $\angle(E_A, l_{lim}(a, E))$ or the ray $l_{lim}(a, E)$ lies inside the angle $\angle(E_A, k)$. But the first option would imply that the ray k meets the line a . On the other hand, since $CD \equiv AE$ and $AB < CD$ we have $[ABE]$. As $a \parallel b$ (they are directionally parallel) and $b \parallel \bar{k}$ (they are hyperparallel), the lines a , \bar{k} are parallel in the usual sense, that is, they coplane and do not meet. The contradiction shows that in fact $l_{lim}(a, E)$ lies inside the angle $\angle(E_A, k)$.

we have $\angle(B_A, l_{lim}(a, B)) < \angle(E_A, l_{lim}(a, E))$ which obviously implies that $\Pi(\mu AB) < \Pi(\mu CD)$. \square

Lemma 3.1.18.1. *For any acute angle $\angle(h, k)$ there is a ray l emanating from a point $B \in h$ such that $l \perp h$, the rays k, l lie on the same side of the line h , and the rays k, l do not meet.*

Proof. Suppose the contrary, i.e. that there is an angle $\angle(h, k)$ such that for any point $B \in h$ the ray $l \perp h$ emanating from it into the half-plane containing k meets the ray k . Construct two sequences of points $A_1, A_2, \dots, A_n, \dots$ and $B_1, B_2, \dots, B_n, \dots$ as follows:

Take an arbitrary point $B_1 \in h$. Draw the ray l_1 emanating from B_1 such that $l_1 \perp h$ and the rays k, l_1 lie on the same side of the line \bar{h} . Denote by A_1 the point where l_1 meets k (it does meet k according to our assumption). Now choose B_2 so that $[OB_1B_2]$ and $OB_1 \equiv B_1B_2$ where O is the vertex of $\angle(h, k)$. Draw the ray l_2 emanating from B_2 such that $l_2 \perp h$ and $kl_2\bar{h}$. Denote $A_2 \equiv k \cap l_2$. Continuing this process inductively, we choose the point B_{n+1} so that $[OB_nB_{n+1}]$ and $OB_n \equiv B_nB_{n+1}$. The ray $l_i, i \in \mathbb{N}$ emanating from the point B_i is orthogonal to h , lies on the same side of \bar{h} as k , and concurs with k in A_i (this constitutes the definition of the points A_i). Denote $\delta_i \equiv \delta_{\triangle OB_iA_i}^{(abs)\angle}$ for all $i \in \mathbb{N}$. We also let (for convenience) $B_0 \equiv O$. Since $B_{i-1}B_i \equiv B_iB_{i+1}$ (by construction) and $\angle B_{i-1}B_iA_i \equiv \angle B_{i+1}B_iA_i$ (the ray B_iA_i being orthogonal to the line $a_{B_{i-1}B_i} = B_iB_{i+1} = \bar{h}$), we have $\triangle B_{i-1}B_iA_i \equiv \triangle B_{i+1}B_iA_i$ for all $i \in \mathbb{N}$, which implies $\delta_{\triangle OB_iA_i}^{(abs)\angle} = \delta_{\triangle B_{i+1}B_iA_i}^{(abs)\angle}$. In view of $\delta_{i+1} = \delta_{\triangle B_{i+1}A_iB_{i+1}}^{(abs)\angle} = \delta_{\triangle OA_iB_{i+1}}^{(abs)\angle} + \delta_{\triangle A_{i+1}A_iB_{i+1}}^{(abs)\angle}$, $\delta_{\triangle OA_iB_{i+1}}^{(abs)\angle} = \delta_{\triangle OB_iA_i}^{(abs)\angle} + \delta_{\triangle B_{i+1}B_iA_i}^{(abs)\angle}$ (see P 1.3.67.12), whence $\delta_{i+1} > 2\delta_i$ for all $i \in \mathbb{N}$. Using these inequalities for $i = 1, 2, \dots, n$ we find that $\delta_{n+1} > 2^n\delta_1$, which implies (in view of C 1.4.18.3) that by appropriate choice of n the angular defect of the triangle $\triangle OB_iA_i$ (viewed as an overextended angle) can be made greater than any given (in advance) overextended angle, in particular straight angle, which is absurd. This contradiction shows that in reality there is a point B on the ray h such that the ray $l \perp h$ emanating from B into the half-plane containing k does not meet k . \square

Lemma 3.1.18.2. *Consider an acute angle $\angle(h, k)$ and the set \mathcal{B} of points $B \in h$ such that the ray $l \perp h$ emanating from B into the half-plane containing k does not meet k . Choosing (of the two orders possible on the line \bar{h}) the order in which the origin (which we will denote O) of the ray h precedes the points of that ray h , the set \mathcal{B} has a minimal element B_0 . Furthermore, the line \bar{l}_0 containing the ray l_0 , emanating from B_0 into the half-plane containing k and such that $l_0 \perp h$, corresponding to B_0 , is directionally parallel to \bar{k} .*

Proof. Consider, in addition to \mathcal{B} , the set $\mathcal{A} \equiv h^c \cup \{O\} \cup (h \setminus \mathcal{B})$. Obviously, $\mathcal{A} \cup \mathcal{B} = \mathcal{P}_{\bar{h}}$. Furthermore, we have $A \prec B$ for all points $A \in \mathcal{A}, B \in \mathcal{B}$. For $A \in h \setminus \mathcal{B}$ this follows from P 1.2.44.1, C 1.3.26.2. According to Dedekind's theorem (T 1.4.17), either the set \mathcal{A} has the maximal element, or the set \mathcal{B} has the minimal element. Denote this element B_0 (the one that performs the Dedekind section). To show that the first option is not the case, suppose the contrary. Then the ray $l_0 \perp h$ emanating from B into the half-plane containing k , meets k in some point A_0 . Taking a point A' such that $[AA_0A']$ (see A 1.2.2) and lowering the perpendicular from A' to \bar{h} (see L 1.3.8.1) which meets \bar{h} in B' , we find that $[OB_0B']$ (using C 1.3.26.2, T 1.3.44), which means that $B_0 \prec B'$ and $B' \in \mathcal{A}$ in contradiction with our assumption that B_0 is the maximal element of \mathcal{A} . This contradiction shows that in fact the set \mathcal{B} has B_0 as its minimal element. To prove that the lines \bar{k}, \bar{l}_0 are directionally parallel, lower from B_0 the perpendicular to \bar{k} . Since the angle $\angle(h, k)$ is acute (by hypothesis), by C 1.3.18.11 $P \in k$. We need to show that an arbitrary ray l' emanating from B_0 into the interior of the angle $\angle(B_0P, l_0)$ meets the ray P_O^c . (We have seen above that the line \bar{l}_0 is parallel to (in the sense of absolute geometry, i.e. does not meet) the line \bar{k} .) Suppose the contrary, i.e. that there is a ray l' emanating from B_0 into the interior of the angle $\angle(B_0P, l_0)$ and such that $l' \cap P_O^c = \emptyset$. Since the angle $\angle OPB_0$ is right by construction, the angle $\angle OB_0P$ is necessarily acute (see C 1.3.17.4) and thus is less than the right angle $\angle(B_0, l_0)$ (see L 1.3.16.17). Hence $B_0P \subset \text{Int}\angle(B_0O, l_0)$ (see C 1.3.16.4), and we can write $B_0P \subset \text{Int}\angle(B_0O, l_0) \& l' \subset \text{Int}\angle(B_0P, l_0) \xrightarrow{L1.2.21.27} l' \subset \text{Int}\angle(B_0O, l_0) \& B_0P \subset \text{Int}\angle(B_0O, l')$. Then it is easy to see that the ray l' does not meet the line \bar{k} altogether.⁵⁹ Thus, by definition of interior the rays l', l_0 lie on the same side of the line \bar{h} and the rays l', B_0O lie on the same side of the line \bar{h}_0 . Furthermore, using L 1.2.19.4 we see that the ray l' lies on the same side of \bar{k} as the ray h (under the assumption, of course, that h' does not meet \bar{k}). On the other hand, since the rays k, l_0 lie on the same side of the line \bar{h} and the rays l', l_0 lie on the same side of \bar{h} , we see that the rays k, l' lie on the same side of \bar{h} and thus the ray l' lies completely inside the angle $\angle(h, k)$ (by definition of the interior of $\angle(h, k)$). Take a point $E \in l'$. Denote by F the foot of the perpendicular lowered from E to \bar{h} . It is easy to see that $[OFB]$.⁶⁰ Consider the ray F_E . Since $F \in (OB)$ (and, consequently, $F \prec B$), the ray F_E necessarily meets the ray k in some point M . Recalling that $E \in \text{Int}\angle(h, k)$, using L 1.2.21.9 we find that $[FEM]$. Then taking into account that $E \in l'$, from C 1.2.1.7 we see that l' has to meet the open interval (OM) and thus the ray k in some point. This contradiction (with the assumption made above that $l' \cap \bar{k} = \emptyset$) shows that in fact the

⁵⁹To show this, albeit in a clumsy way, observe that the rays l', B_0O lie on the opposite sides of the line a_{B_0P} (because, as we just saw, $B_0P \subset \text{Int}\angle(B_0O, l')$; see C 1.2.21.11) and the rays B_0O, P_O lie on the same side of the line \bar{k} (they share the point O). Hence using L 1.2.18.5 we see that the rays l', P_O lie on the opposite sides of the line a_{B_0P} and thus they cannot meet. And, of course, $l' \subset \text{Int}\angle(B_0P, l_0)$ implies that $P \notin l'$.

⁶⁰A workable but certainly not very graceful way to show this is as follows: Since, as we saw above, the angle $\angle OB_0P$ is acute, using C 1.3.18.11 we find that $F \in B_0O$. Since, as we just saw $l' \subset \text{Int}\angle(h, k)$ and, in particular, $E \in \text{Int}\angle(h, k)$, using L 1.3.26.15 we find that $F \in h = O_{B_0}$. Thus, we see that $F \in h \cap B_0O = (OB_0)$.

line \bar{l}_0 is directionally parallel to the line \bar{k} . Then in view of T 3.1.3 the line \bar{k} is directionally parallel to the line \bar{l}_0 . Now it is evident that $\angle(h, k)$ is a Lobachevsky angle corresponding to the interval OB_0 .⁶¹ \square

Theorem 3.1.19. *For any acute angle $\angle(h, k)$ (and, for that matter, for the class of angles $\mu\angle(h, k)$) congruent to that angle) there is an (abstract) interval AB (and, for that matter, the class μAB of intervals congruent to that interval) such that $\Pi(\mu AB) = \mu\angle(h, k)$.*

Proof. See proof of the preceding lemma (L 3.1.18.2). \square

Theorem 3.1.20. *Consider two lines a, b , parallel in some direction. Consider further two (distinct) planes $\alpha \supset a$, $\beta \supset b$ drawn through the lines a, b , respectively. If c is the line of intersection of α, β (i.e. the line containing all common points of the planes α, β), then c is parallel to both a and b in the same direction as they are parallel to each other.*

Proof. \square

⁶¹In other words, $\mu\angle(h, k) = \Pi(\mu OB_0)$.