

[The Mechanics of Mechanical Watches and Clocks](#)

Bearbeitet von
Ruxu Du, Longhan Xie

1. Auflage 2012. Buch. xi, 179 S. Hardcover
ISBN 978 3 642 29307 8
Format (B x L): 15,5 x 23,5 cm
Gewicht: 456 g

[Weitere Fachgebiete > Technik > Technologien diverser Werkstoffe > Fertigungsverfahren der Präzisionsgeräte, Uhren](#)

Zu [Inhaltsverzeichnis](#)

schnell und portofrei erhältlich bei

DIE FACHBUCHHANDLUNG

Die Online-Fachbuchhandlung [beck-shop.de](#) ist spezialisiert auf Fachbücher, insbesondere Recht, Steuern und Wirtschaft. Im Sortiment finden Sie alle Medien (Bücher, Zeitschriften, CDs, eBooks, etc.) aller Verlage. Ergänzt wird das Programm durch Services wie Neuerscheinungsdienst oder Zusammenstellungen von Büchern zu Sonderpreisen. Der Shop führt mehr als 8 Millionen Produkte.

Chapter 2

A Brief Review of the Mechanics of Watch and Clock

According to literature, the first mechanical clock appeared in the middle of the fourteenth century. For more than 600 years, it had been worked on by many people, including Galileo, Hooke and Huygens. Needless to say, there have been many ingenious inventions that transcend time. Even with the dominance of the quartz watch today, the mechanical watch and clock still fascinates millions of people around the world and its production continues to grow. It is estimated that the world annual production of the mechanical watch and clock is at least 10 billion USD per year and growing. Therefore, studying the mechanical watch and clock is not only of scientific value but also has an economic incentive. Nevertheless, this book is not about the design and manufacturing of the mechanical watch and clock. Instead, it concerns only the mechanics of the mechanical watch and clock.

Generally speaking, a mechanical watch is made of five parts as shown in Fig. 2.1. They are the winding mechanism, the power storage, the gear train, the display and the escapement.

There are two kinds of winding mechanisms: manual winding and automatic winding. The latter is usually applied to watches and will be discussed in Chap. 5. The winding mechanism provides kinetic energy to drive the watch and clock. This energy is stored in the power storage (the mainspring). The energy from wound mainspring drives a gear train, which usually consists of three sets of gears: the second pinion and wheel, the third pinion and wheel as well as the escape pinion and wheel. For timekeeping though, the brain is the escapement. It is the most important and most distinctive part of the mechanical watch and clock.

Why the escapement? It is well known that a watch and clock must have a precise and reliable means for timekeeping. One way is using a pendulum. It is said that pendulum theory was inspired by the swinging motion of a chandelier in the Pisa Cathedral, as shown in Fig. 2.2 (Wikipedia 2004a). Galileo Galilei (Wikipedia 2001a), Fig. 2.3, discovered the crucial property of the pendulum in 1606, which led to his decision to build a functioning pendulum clock.

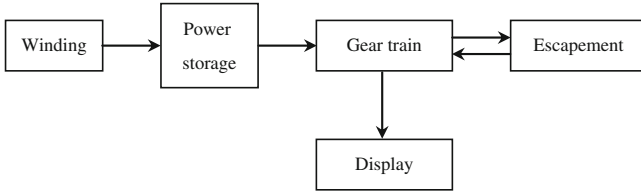

Fig. 2.1 The basic structure of mechanical watch and clock



Fig. 2.2 The chandelier in the Pisa Cathedral (Wikipedia 2004a)

Despite the fact that the swinging of the pendulum is independent of the amplitude of the swing as well as the weight of the bob, and hence, is a good means for timekeeping, it will inevitably slow down because of air resistance and mechanical friction. As a result, energy must be added, which can be done by the lift weight and/or the wound spring. However, one may imagine that as energy is gradually being used up, the driving force is gradually reducing and hence, the clock will slow down. On the other hand, when energy is being added, the clock will move faster. To solve this problem, the concept of escapement was invented. The idea is to release energy by intermittent pulses. Note that it is the impulse that drives the clock and hence, the amount of energy input does not matter. This makes the

Fig. 2.3 Portrait of Galileo Galilei (1564–1642) (Wikipedia [2001a](#))



clock less dependent on the stored energy and hence, much more accurate. Because such an impulsive motion is to allow the stored energy to “escape” pulse by pulse, it is, therefore, called the “escapement.”

According to literature, since the time of Galileo more than one hundred different types of escapements had been created. In the subsequent sections, we discuss a number of representative escapements chronologically.

2.1 The Verge Escapement

Appearing as early as the fourteenth century, the Verge escapement is perhaps the oldest escapement (Wikipedia [2004b](#)). It is not clear who invented this escapement, but it was certainly inspired by the alarum tower. By the sixteenth century, the working principle of the Verge escapement was well documented by the Muslim scientist Taqi al-Din Ibn Maruf (1550).

The Verge escapement is also called as the Crown-wheel-and-verge escapement. As shown in Fig. 2.4, it consists of a crown-shaped escape wheel rotating about the horizontal axis and a vertical verge. The escape wheel is driven by a lifted weight or a mainspring. Note that there are two pallets on the vertical verge shaft that are arranged at an angle. As the escape wheel rotates, one of its saw-tooth-shaped teeth turns a pallet and drives the vertical shaft in one direction (Fig. 2.4a). This also puts the other pallet in position to catch the tooth of the escape wheel on the other side. As the escape wheel continues to rotate, it drives

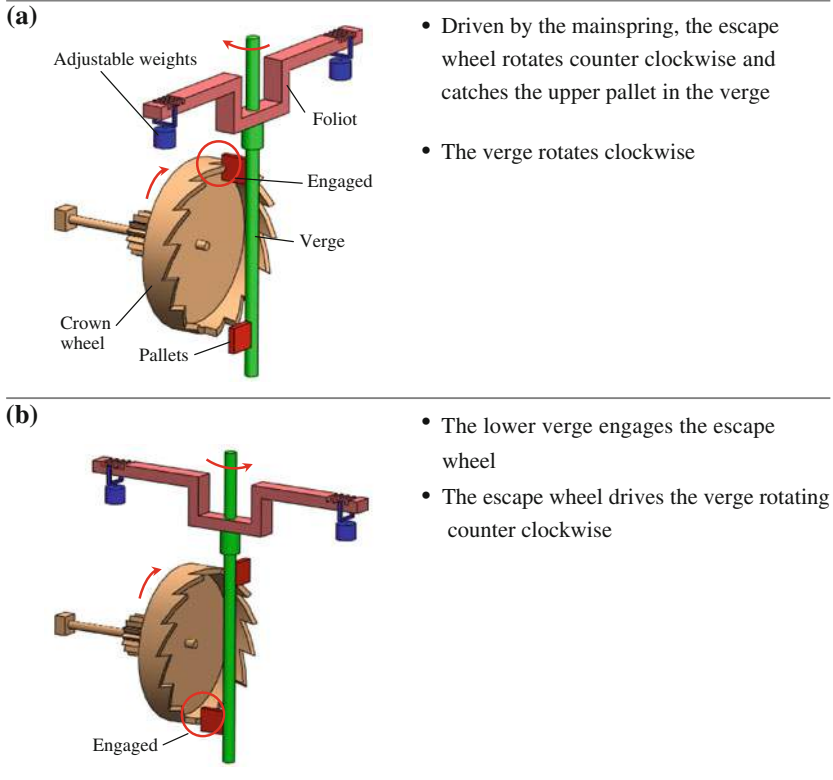

Fig. 2.4 The operation of the Verge Escapement

the vertical shaft to rotate in the opposite direction, completing a cycle (Fig. 2.4b). The cycle then repeats converting the rotary motion of the escape wheel to the oscillating motion of the verge. Each cycle advances the wheel train of the clock moving the hands forward at a constant rate.

The Verge escapement was first used as a clock escapement and then modified into a watch escapement. Figure 2.5 shows the Verge watch escapement. From the figure, it can be seen that the crown-shaped escape wheel and the vertical shaft are the same; but the horizontal bar is replaced by a balance wheel with a hairspring. In this case, the timekeeping is regulated in part by the hairspring as it controls the engagement of the second pallet. A computer animation is shown on the Springer Website <http://extra.springer.com/2012/978-3-642-29307-8>.

Figure 2.6 shows a Verge escapement clock made in late 1700s (Institute of Precision Engineering 2008). The Verge escapement is usually not very accurate. This is due mainly to the fact that the driving power dominates the swinging of the verge wheel. As the driving power is consumed over time, the escapement slows down. Therefore, as new and better designs emerged, the verge escapement gradually disappeared in 1800s.

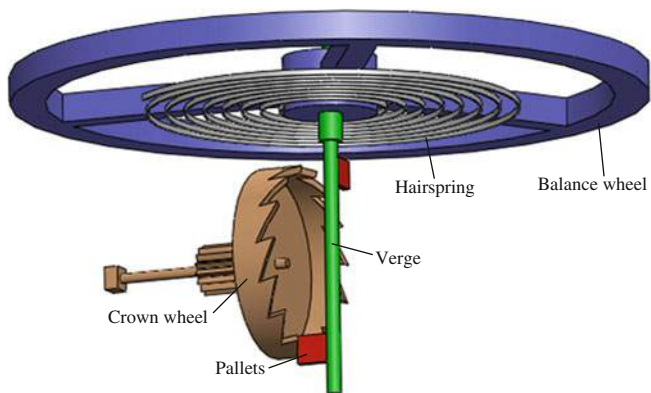

Fig. 2.5 The model of the Verge escapement watch

Fig. 2.6 A Verge escapement clock made in late 1700s (Institute of Precision Engineering 2008)



Fig. 2.7 Portrait of Robert Hooke (1635–1703) (Wikipedia [2002a](#))



2.2 The Anchor Escapement

The Anchor escapement is another milestone invention. It was perhaps invented by the famous British scientist Robert Hooke (1635–1703) around 1657, as shown in Fig. 2.7 (Wikipedia [2002a](#)), and first made by the British clock master Thomas Tompion (1639–1713). However, like many of his other works, his ownership is disputed (Wikipedia [2004c](#)). In any case, Hooke’s milestone contribution to mechanical watch and clock making is indisputable.

Figure 2.8 shows the model of the Anchor escapement. It consists of an escape wheel, an anchor and a pendulum. The exact shapes of both the escape tooth and the anchor pallet are not crucial. The escape wheel is driven by a lifted weight or a wound mainspring rotating clockwise. As a tooth of the escape wheel slides on the surface of the left pallet of the anchor, the anchor moves away releasing the tooth and allowing the escape wheel to advance. Next, the pendulum reaches its highest position and swings back. It carries the right pallet towards the escape wheel, pushing the escape wheel backwards for a small distance. This locks the escape wheel until the pendulum reverses direction and the pallet begins to move away from the escape wheel, with the tooth sliding off along its surface. Then, the escape

Fig. 2.8 The model of an Anchor escapement

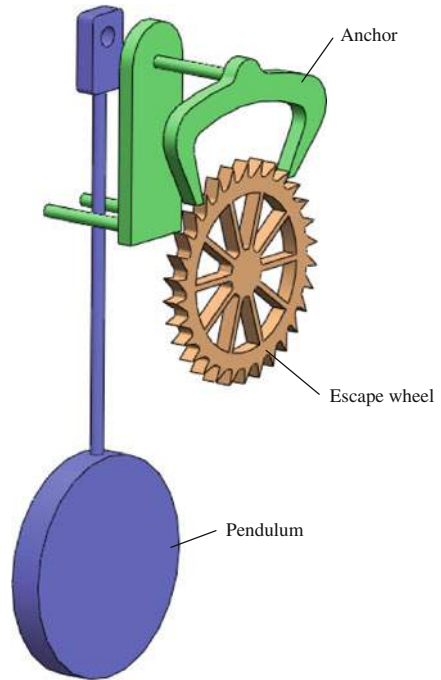

wheel catches the left pallet again, starting a new cycle. This operation is rather similar to the Graham escapement detailed in the subsequent section.

In comparison to the Verge escapement, the Anchor escapement has two significant advantages. First, all the motions are in the same plane making the motion more stable and the manufacturing easier. Second, the pendulum needs to swing only a small angle. As discovered by Christiaan Huygens (1629–1695) (Wikipedia 2002b), this is very important because it avoids the nonlinearity present when the pendulum swings in large angles. By the early 1800s, the Anchor escapement had replaced the Verge escapement as the choice for time keeping (Fig. 2.9).

It should be mentioned that the anchor escapement had one major problem: as the escape wheel is pushed backwards, the entire gear train must move backwards and suffer from backlash. This problem is referred to as recoil and motivated many subsequent improvements, some of which will be discussed in the subsequent sections.

As for Robert Hooke, his most significant contribution to the mechanical watch and clock was not the anchor escapement but the introduction of the balance spring, also called the hairspring. Together with the clock master Thomas Tompion, who was considered the father of British clock making, the hairspring makes the mechanical watch possible. Furthermore, it gave birth to the Hooke's Law that we all learn in elementary school.

Fig. 2.9 Portrait of Christiaan Huygens (1629–1695) (Wikipedia 2002b)



2.3 Graham Escapement

In 1715, English watchmaker George Graham (1673–1751) invented the Graham escapement (Wikipedia 2004d). Born in Hethersgill, England, Graham was one of the most well-known horologists of the eighteenth century. He started his apprenticeship to an English clockmaker named Henry Aske at a young age. Later, he became the protégé of Thomas Tompion (and married his niece) and partner for life. He brought the watch and clock technology to new heights. Besides the Graham escapement, he was also the inventor of the mercury compensation pendulum, the Cylinder escapement for watches and the first chronograph. The mercury pendulum can achieve an accuracy of within a few seconds per day, a monumental achievement for the time. Graham refused to patent these inventions because he felt that they should be used by other watchmakers as well. He was a truly talented and generous inventor (Fig. 2.10).



Fig. 2.10 Portrait of George Graham (1673–1751) (Wikipedia [2004d](#))

The Graham escapement is also called the Deadbeat escapement. It is a modified version of the Anchor escapement and mostly eliminates the aforementioned coil problem. Figure 2.11 shows the model of the Graham escapement. Similar to the Anchor escapement, it mainly consists of an escape wheel, a pallet fork and a pendulum. During the operation, the escape wheel is driven by the power train and moves clockwise. On the other hand, the pallet fork and the pendulum are joined together and swung. Graham made a number of delicate modifications. First, the anchor pallet is concentric to its center. Second, the tip of each limb of the pallet has a specific shape designed to provide an impulse as the escape wheel tooth slides across the surface. The surface that the escape tooth strikes is called the

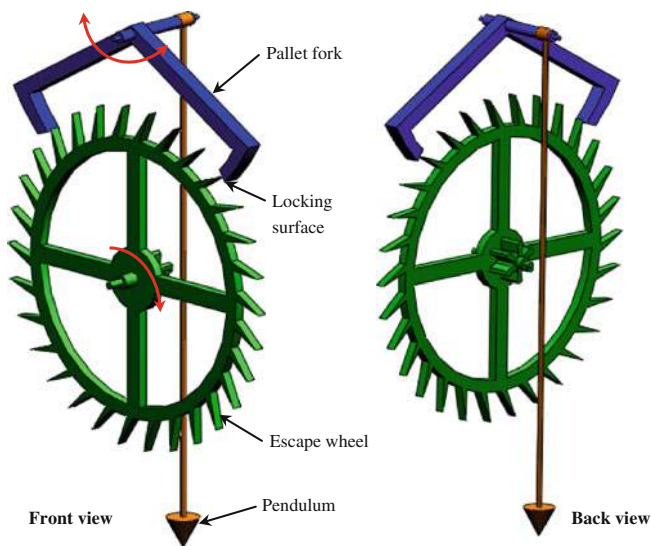

Fig. 2.11 The model of the Graham escapement

locking face, because it prevents the escape wheel from rotating farther. The design of the escape wheel, on the other hand, is relatively simple. It is made of a number of straight teeth leaning towards the direction of rotation.

The working principle of the Graham escapement is similar to that of the Anchor escapement. Figure 2.12 shows the five steps that the Graham escapement goes through in a complete cycle. Note that the circle in the figure indicates the contacting point. Figure 2.12a shows the first step, in which a tooth of the escape wheel pushes the entry pallet (the left pallet). Note that the strike point is at the locking face above the tip surface of the pallet to ensure proper contact. Both the escape wheel and the pendulum are moving forward. Figure 2.12b shows the second step, where the pendulum reaches its farthest point and begins to swing backwards. Figure 2.12c shows the third step where the exit pallet (the right pallet) of the pallet fork locks another tooth of the escape wheel and stops its motion. Its position is just right so that it does not push the escape wheel backwards, which is why it is called the Deadbeat escapement. Figure 2.12d shows the fourth step when the pendulum reaches the opposing farthest point and starts to swing forward. This unlocks the escape wheel and thus, the escape wheel can move forward again. Finally, Fig. 2.12e shows the fifth step where the pallet fork and pendulum return to their original position completing a cycle. A computer animation is shown on the Springer Website <http://extra.springer.com/2012/978-3-642-29307-8>.

After nearly 300 years, the Graham escapement is still used today. Figure 2.13 shows a Graham escapement clock. This kind of clock is often called the grandfather clock and has become a symbol of accuracy and reliability.

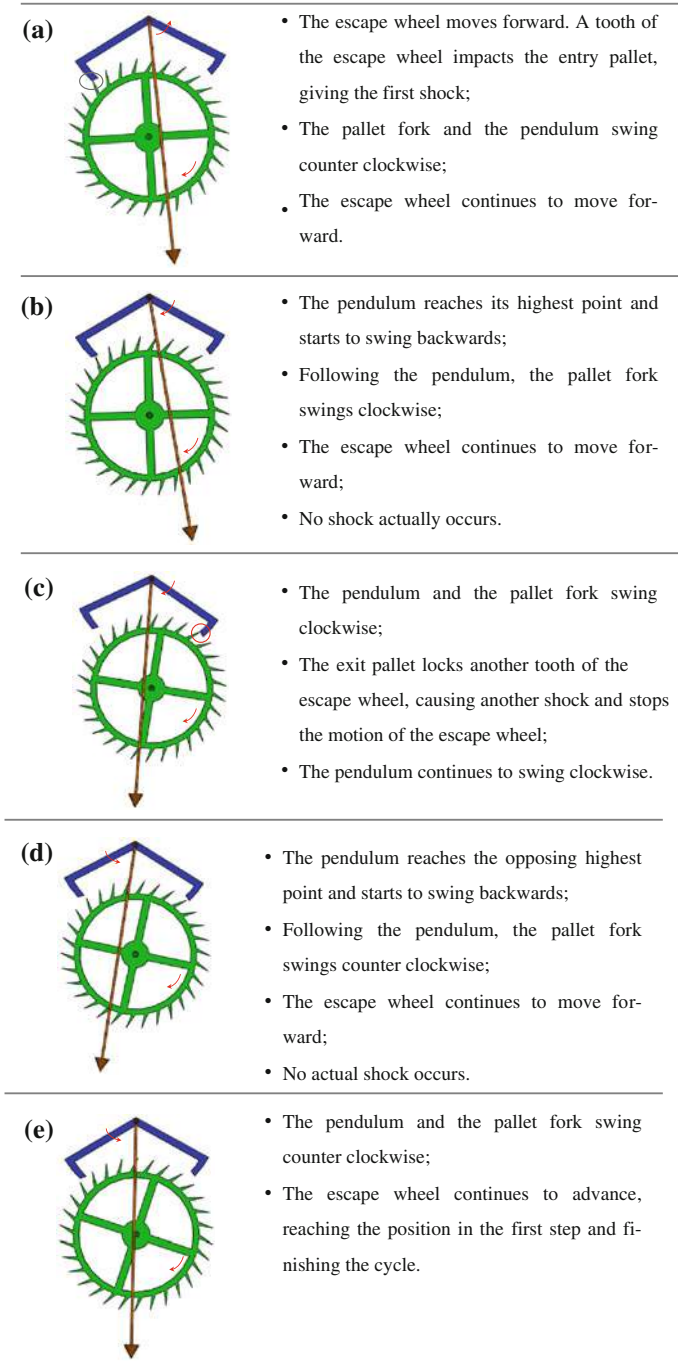
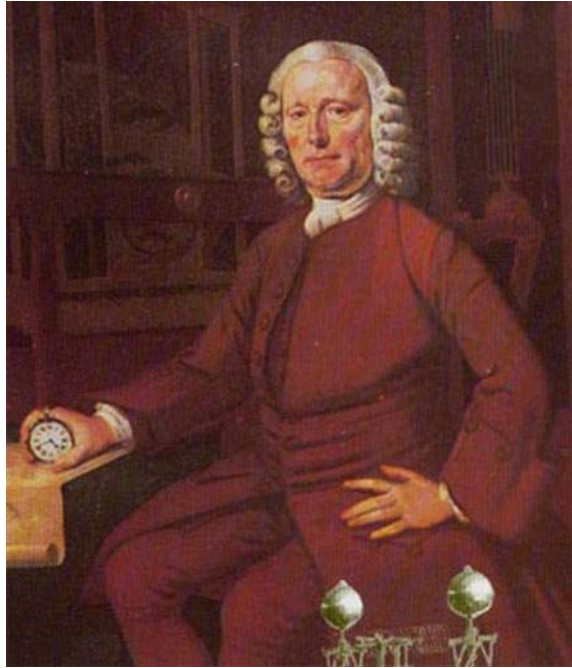

Fig. 2.12 The operation of the Graham escapement

Fig. 2.13 A modern clock based on Graham escapement



Fig. 2.14 Portrait of John Harrison (1693–1776) holding his trophy H4 watch (Wikipedia [2001b](#))



2.4 The Grasshopper Escapement

The Grasshopper escapement was invented by another famous English clockmaker, John Harrison (1693–1776) around the year 1722 (Wikipedia [2001b](#), [2004e](#)). During this time, England was gaining power at sea. Evidently, estimating the position on the sea was extremely important. It was known that latitudinal position could be estimated based on astronomical charts; but longitudinal position was a challenge for maritime navigation. Isaac Newton (1643–1727) argued that astronomical positioning could also be used, but an easier method for accurate timekeeping was based on reference to the home base. The solution for establishing the longitude of a ship at sea was considered so intractable that the British Parliament offered a prize of £20,000 (about 4.6 million USD today), called the Longitude Prize, for an accurate clock. John Harrison devoted his life's work to building such a clock.

As mentioned in the previous sections, by then a number of different types of escapements had been invented. Modified from the Anchor escapement, the Grasshopper escapement was used in his first three maritime time keepers: Harrison Number One (H1) through Harrison Number Three (H3). He then spent another 29 years on the project and finally won the Longitude Prize. Although the grasshopper escapement was not used in his final Harrison Number 4 (H4), which was a watch, it left a mark in history (Fig. [2.14](#)).

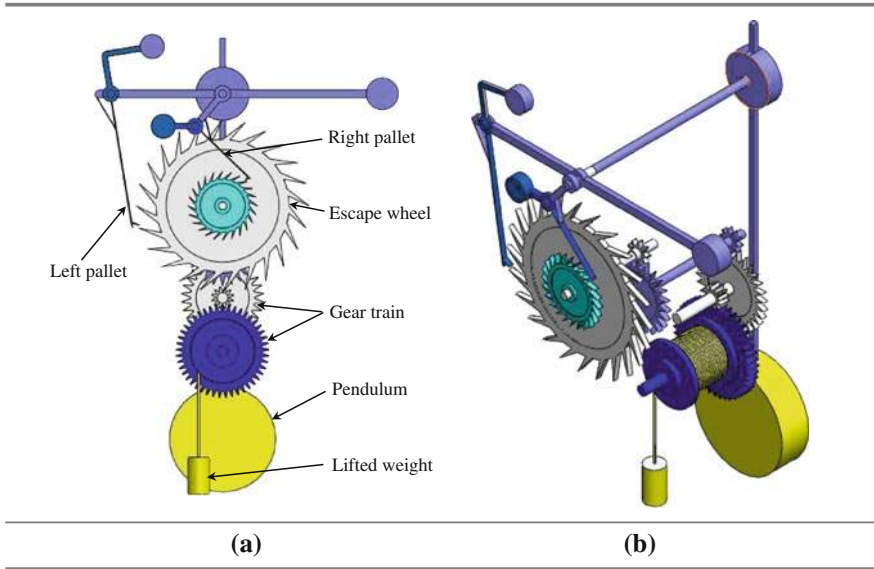

Fig. 2.15 Illustration of the Grasshopper escapement. **a** Front view **b** Back view

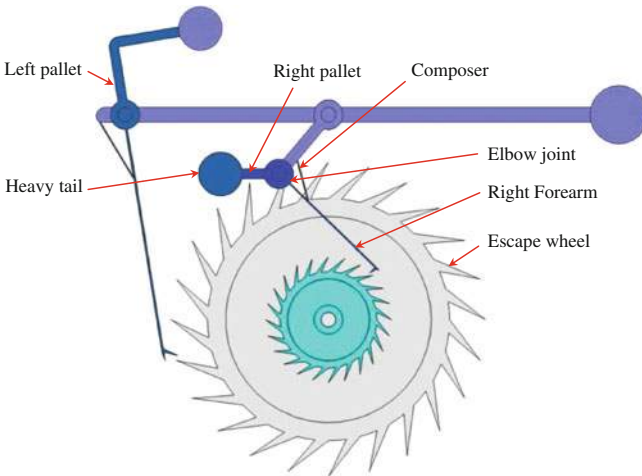

Fig. 2.16 The two pallets and the escape wheel in the Grasshopper escapement

The Grasshopper escapement was also evolved from the anchor escapement. It has been suggested that the name of this escapement comes from the resemblance of the pallet arms to the legs of a grasshopper. As shown in Fig. 2.15, the escapement consists of an escape wheel, a pendulum, a driving mechanism (the lifted weight) and two pallets shaped like a grasshopper.

Figure 2.16 gives the details of the escapement: The right pallet has an elbow joint connected to a heavy tail and a forearm, as well as a composer. The tail is

slightly heavier so that the forearm tends to move away from the escape wheel. The composer prevents the forearm from rising further. As the upper arm rotates clockwise, the tip of the pallet at the forearm is pushed downwards. When lifted by the escape wheel, the pallet will take the composer with it, and when released, it will return to the resting position. The left pallet has a similar structure. The two pallets are joined with the pendulum on the upper arm.

The operation of the Grasshopper escapement is shown in Fig. 2.17. In Fig. 2.17a, the gear train is turning the escape wheel clockwise and the pendulum is swinging to the left. This will lift the left pallet. The impulse comes to an end when the right pallet, which is moving down towards the escape wheel, catches a tooth of the escape wheel by its notch. In Fig. 2.17b, the right pallet tries to reverse the clockwise motion of the escape wheel. However, the pendulum is still swinging to the left and the upper arms must always move with it. Thus, the right elbow recoils, crumpling a little in the process. As soon as this happens, the right pallet becomes separated from its tooth and hops away, finding itself free to revert to its natural angle. It might have also been this “hop” that gave the escapement its nickname. In Fig. 2.17c, as the pendulum returns from its left extreme, the escape wheel continues its clockwise motion and its impulse through the right pallet. In Fig. 2.17d, the escape wheel is recoiled by the arrival of the left pallet, causing the right pallet to hop away. A computer animation is shown on the Springer Website <http://extra.springer.com/2012/978-3-642-29307-8>.

The Grasshopper escapement has two advantages: its regularity of operation and its absence of sliding friction. It does not recoil like the Anchor escapement. Rather, one pallet is released only by the engagement of the other, as shown in Fig. 2.17b and d. The impulse given to the pendulum is thus uniform in both its amount and timing. In addition, it does not have much friction. This is because the forearm helps the pallets to jump in and out of the escape wheel teeth. Also, there is little sliding friction. Although there remains friction on the pivots, it is minor in comparison to that of the sliding in the anchor escapement.

There are, however, several limitations that made the Grasshopper escapement uncompetitive. First, when the pallets are in contact with the escape wheel, the drive to the escape wheel is interrupted, and when the drive is restored, the escape wheel may accelerate rapidly and uncontrollably. Second, when the power runs down, the pallets have a tendency to be unable to return to their proper stop positions. Third, and most importantly, even more than other clock escapements, the Grasshopper escapement pushes the pendulum back and forth throughout its cycle. The pendulum is never allowed to swing freely. This disturbs the pendulum’s natural motion as a harmonic oscillator and causes a lack of isochronism.

Although the Grasshopper escapement was never popular, it was used by several famous clocks. The most famous one is John Harrison’s H1 (Wikipedia 2001c) built between 1730 and 1735, as shown in Fig. 2.18. Two hundred and seventy years later, in 2008, as a tribute to the Grasshopper escapement, the Corpus Clock was built at Corpus Christi College, Cambridge University, in Cambridge, England. It is shown in Fig. 2.19 (Wikipedia 2008). The ever moving grasshopper exemplifies that the time is another dimension of the universe.

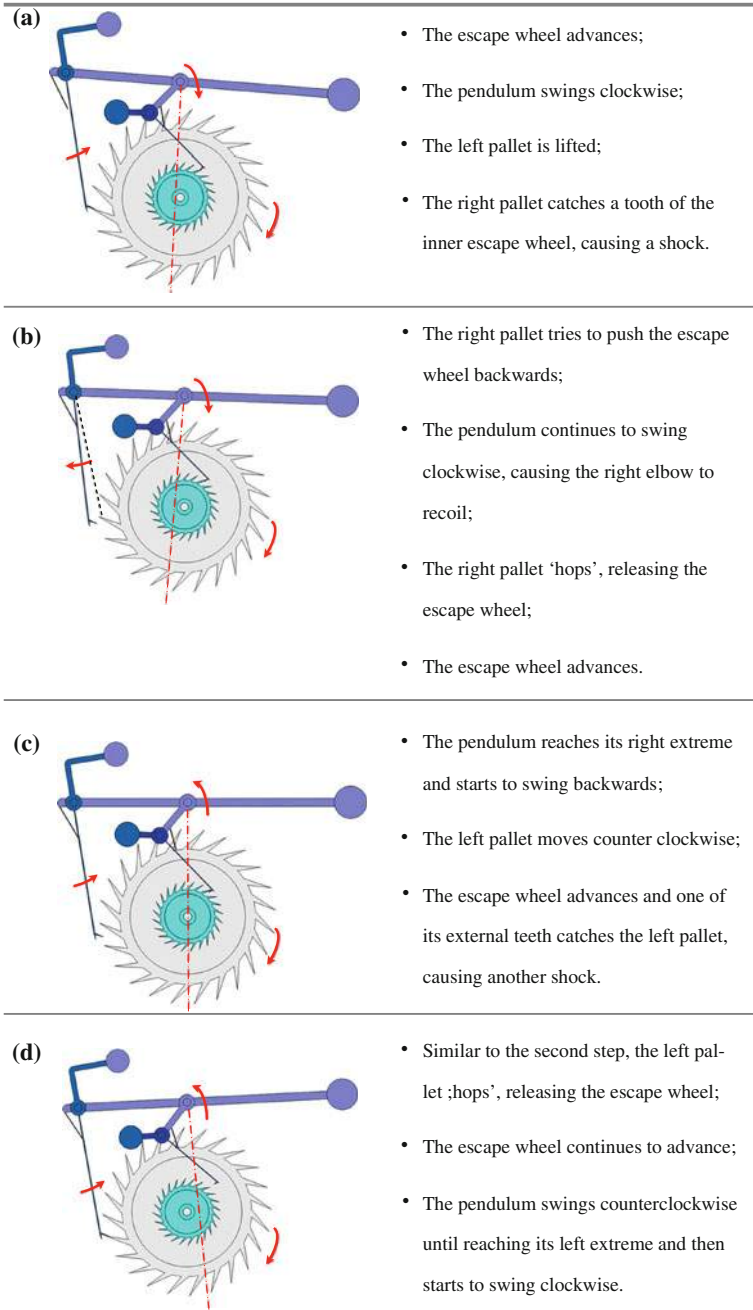
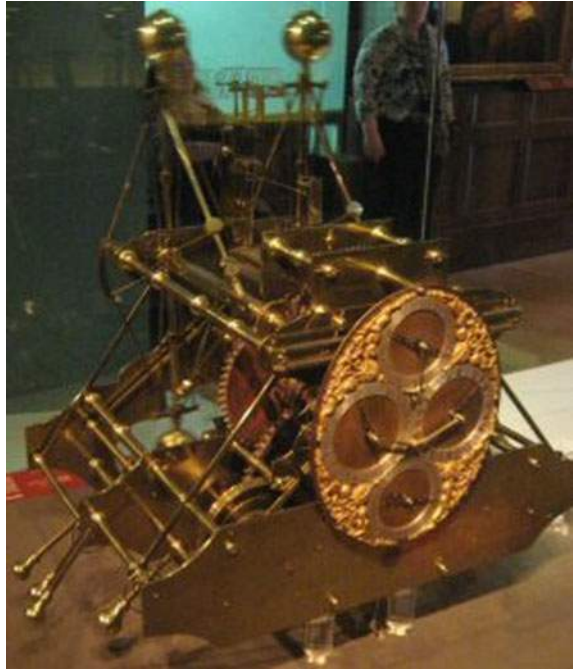

Fig. 2.17 The operation of the Grasshopper escapement

Fig. 2.18 John Harrison's H1 built between 1730 and 1735 (Wikipedia [2001c](#))



2.5 The Spring Detent Escapement

The spring detent escapement, most commonly used on some nineteenth century's precision watches, is a type of detached escapement. The early form was invented by the French watchmaker Pierre Le Roy (1717–1785) in 1748 (Fig. [2.20](#)), who created a pivoted detent type of escapement (Wikipedia [2004f](#)). It was then generalized in 1783 by the English watchmaker Thomas Earnshaw (1749–1829) (Wikipedia [2005](#)) with his standard spring detent escapement and used until mechanical chronometers became antediluvian (Fig. [2.21](#)). Although John Arnold (1736–1799) and Swiss watchmaker Ferdinand Berthoud (1727–1807) both had their own design in 1779, neither of their designs could match Earnshaw's design in popularity. Due to the virtual absence of sliding friction between the escape tooth and the pallet during impulse, the spring detent escapement could be made more accurate than lever escapements. Unfortunately, the spring detent escape was rather fragile, not self-starting and harder to manufacture in volume. In 1805, Earnshaw and Arnold's son (by then John Arnold was deceased) were awarded by the Board of Longitude for their contributions to chronometers. Earnshaw was also known for his bimetallic temperature compensator, and Arnold simplified the complicated structure of the chronometer by applying a helical balance spring.

Fig. 2.19 The Corpus Clock at Corpus Christi College, Cambridge. (Wikipedia 2008)



The spring detent escapement is shown in Fig. 2.22. It consists of an escape wheel, a roller with an impulse pallet and a locking pallet, as well as a detent made of a blade, a horn and a spring.

The operation of the spring detent escapement is shown in Fig. 2.23. In Fig. 2.23a, before the first shock, the impulse roller rotates counter clockwise and the horn of the detent locks the escape wheel. Figure 2.23b shows the first shock. The impulse roller contacts the detent causing the first shock and pressing it down allowing the escape wheel to move forward. Figure 2.23c shows the second shock; it occurs when the escape wheel catches the impulse pallet. After the second shock in Fig. 2.23d, the impulse roller swings backwards locking the escape wheel. In Fig. 2.23e, the impulse roller reaches the spring and has the momentum to lift it up, causing the third shock, while the escape wheel continues its clockwise swinging. After the third shock in Fig. 2.23f, lifted by the discharging roller, the spring reaches its highest position. A computer animation is shown on the Springer Website <http://extra.springer.com/2012/978-3-642-29307-8>.

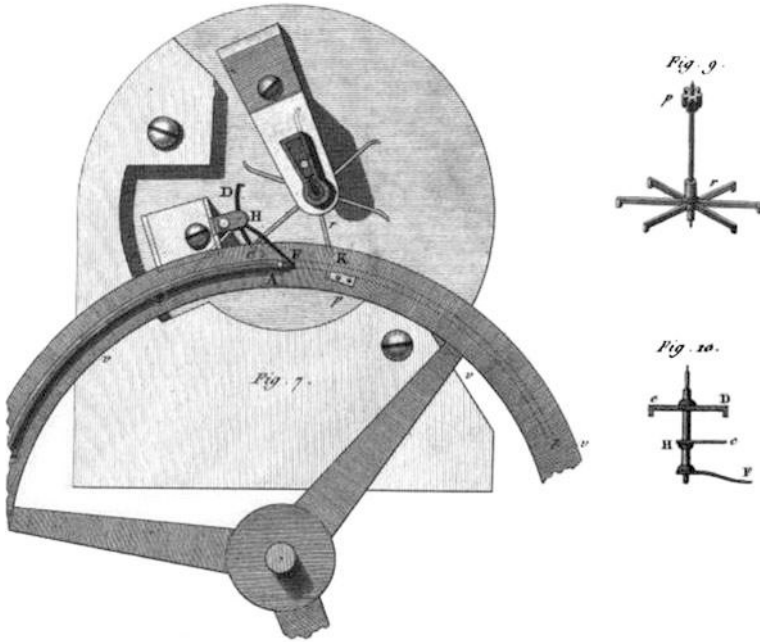
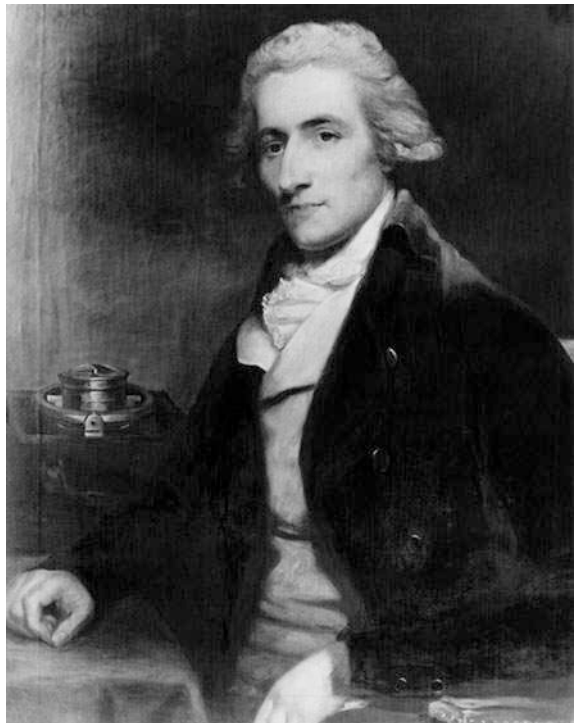

Fig. 2.20 Pierre Le Roy's detent escapement (Wikipedia 2004f)

Fig. 2.21 Portrait of Thomas Earnshaw with his chronometer (Wikipedia 2005)



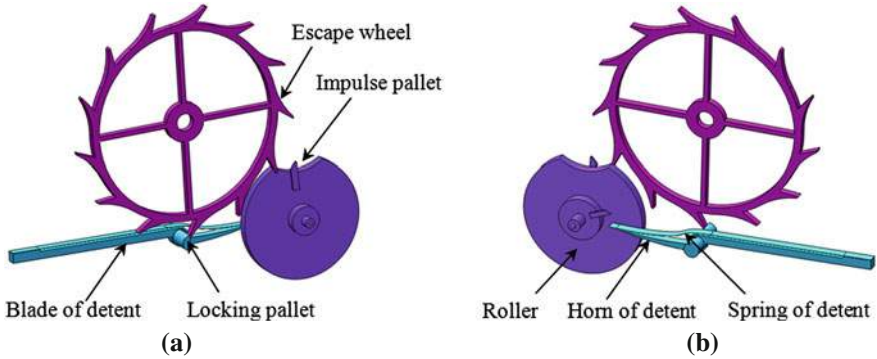

Fig. 2.22 The model of the spring detent escapement. **a** Front view **b** Back view

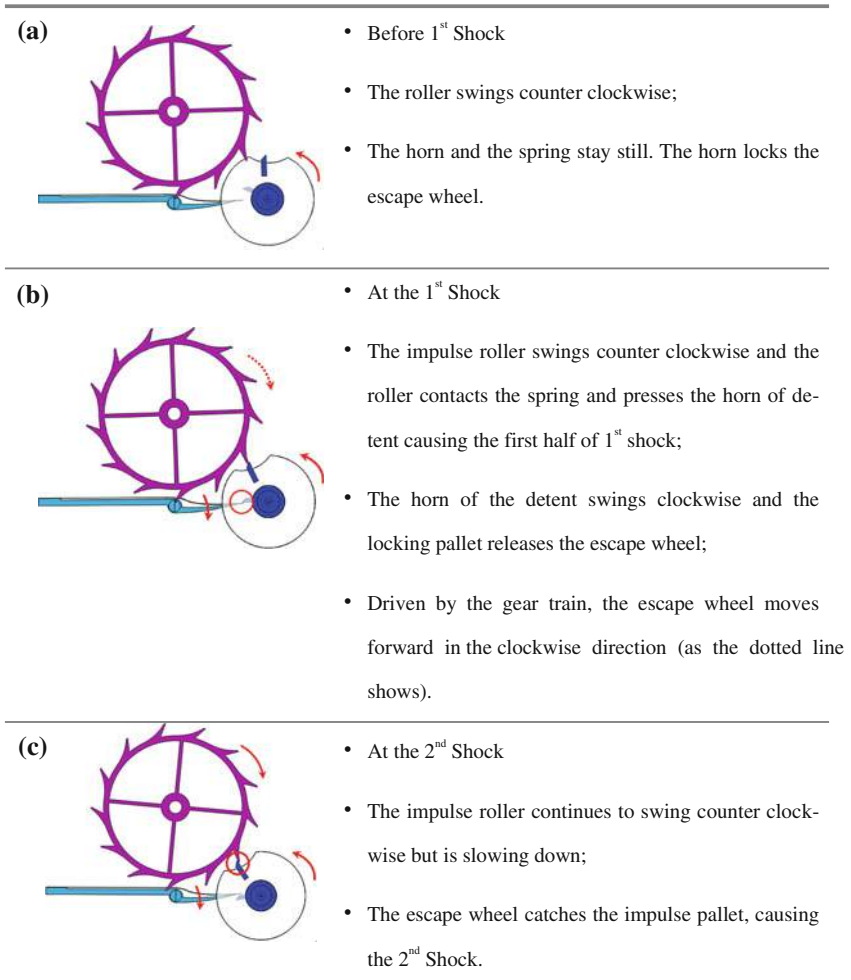

Fig. 2.23 The operation of the spring detent escapement

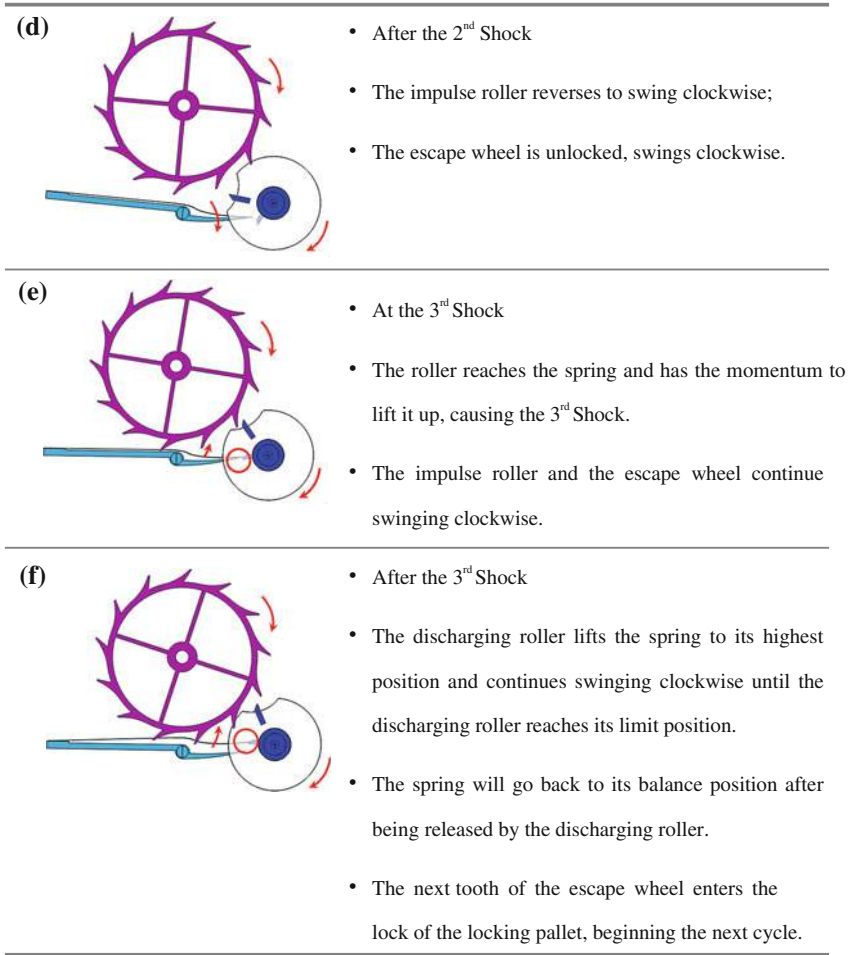

Fig. 2.23 continued

The spring detent escapement uses a spring strip to regulate the timekeeping. While it is simple, its accuracy and reliability are limited. Thus, the spring detent escapement was gradually being phased out in late 1800s. Today, one may still be able to find the spring detent escapement watches in antique stores. Figure 2.24 shows a chronometer with spring detent escapement made by J. Calame Robert, in which a spiral hairspring had been added.

Fig. 2.24 A chronometer with spring detent escapement made by J. Calame Robert



2.6 The Cylinder Escapement

The cylinder escapement got its name from its cylinder-shaped balance wheel. Different from other escapements, the cylinder escapement does not have a pallet fork. It only consists of an escapement wheel and a balance wheel. From a historical point of view, the cylinder escapement was an improvement over the verge escapement. It was first used for clocks, as shown in Fig. 2.25.

Figure 2.26 shows the model of the cylinder escapement in watch. Note that the escape wheel teeth of this escapement lie in a horizontal plane, so this escapement is also known as the “horizontal escapement” (introduced by George Graham in 1726). The escape wheel usually has thirteen to fifteen wedge-shaped teeth, standing above the rim of the wheel with the pointed end of the “wedge” leading. Mounted on the balance staff is a polished steel tube or hollow cylinder. Nearly one half of which is cut away, allowing the escape wheel teeth to enter as the balance wheel swings back and forth. As each tooth enters the cylinder, it impulses the balance wheel on the entry lip of the cylinder wall. The tooth rests within the cylinder while the balance wheel completes its oscillation and begins its return journey. In due course, the tooth escapes from within the cylinder, again giving impulse as it leaves. The succeeding tooth, which has been held against the outside wall of the cylinder while the first tooth is within, then enters the cylinder and the process is repeated. Later, the cylinder shell was made out of ruby, which was

Fig. 2.25 A cylinder escapement clock



Fig. 2.26 The CAD model of the cylinder escapement

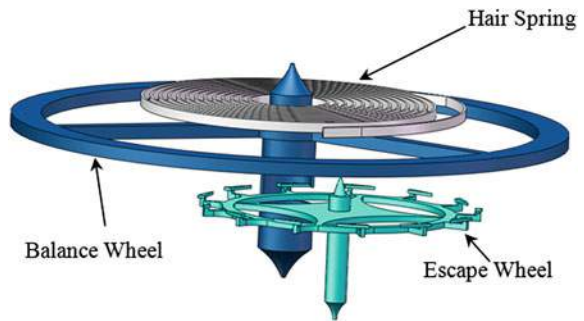

probably introduced by John Arnold in 1764, though not used to large extent. John Ellicott also used it in his later watches, and it became popular with Breguet for a period of time.

The operation of the cylinder escapement is shown in Fig. 2.27. Figure 2.27a shows that the escape wheel is about to be released. Figure 2.27b shows the first shock. It happens between the escape wheel and the outer wall of the cylinder, and the escape wheel is locked after then. After the first shock, as shown in Fig. 2.27c, the escape wheel is locked and the balance wheel swings to its limit position and about to

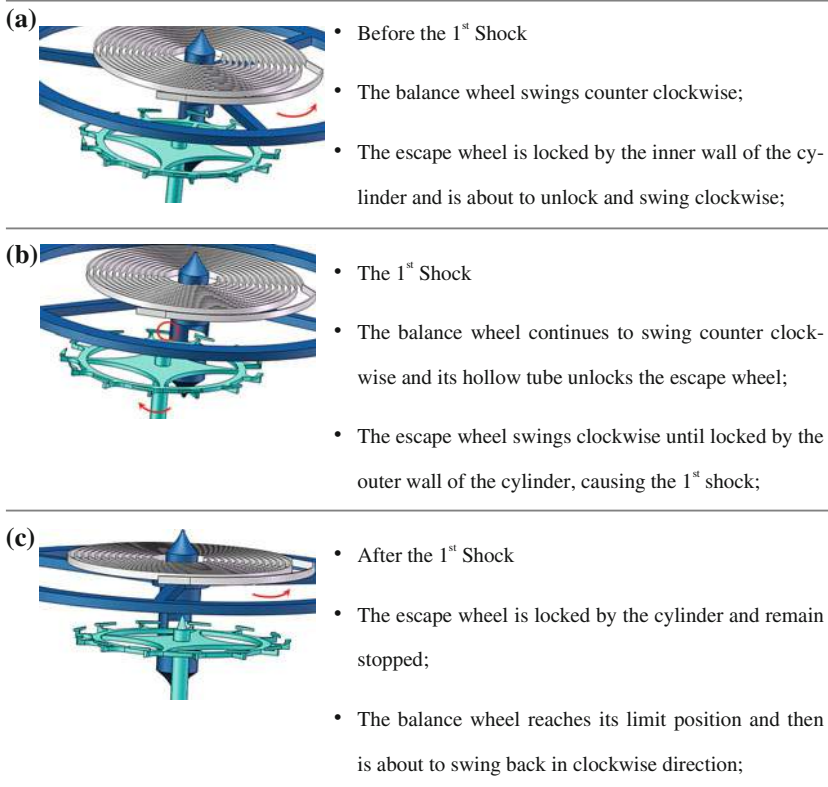

Fig. 2.27 The operation of the cylinder escapement

swing backwards. Before the second shock in Fig. 2.27d, the balance wheel swings clockwise and unlocks the escape wheel. The second shock occurs in Fig. 2.27e when the escape wheel contacts the inner wall of the cylinder, while the balance wheel continues swinging clockwise. Figure 2.27f shows movements after the second shock before the beginning of the next cycle. A computer animation is shown on the Springer Website <http://extra.springer.com/2012/978-3-642-29307-8>.

The constant contact between the balance wheel and the escape wheel makes the cylinder escapement prone to wear and sensitive to dirt and hence, needs regular cleaning. Besides, it is hard to manufacture and maintain. Therefore, it was gradually being replaced in late 1800s. Today, one may still be able to find watches made of cylinder escapement in antique stores, like the one shown in Fig. 2.28.

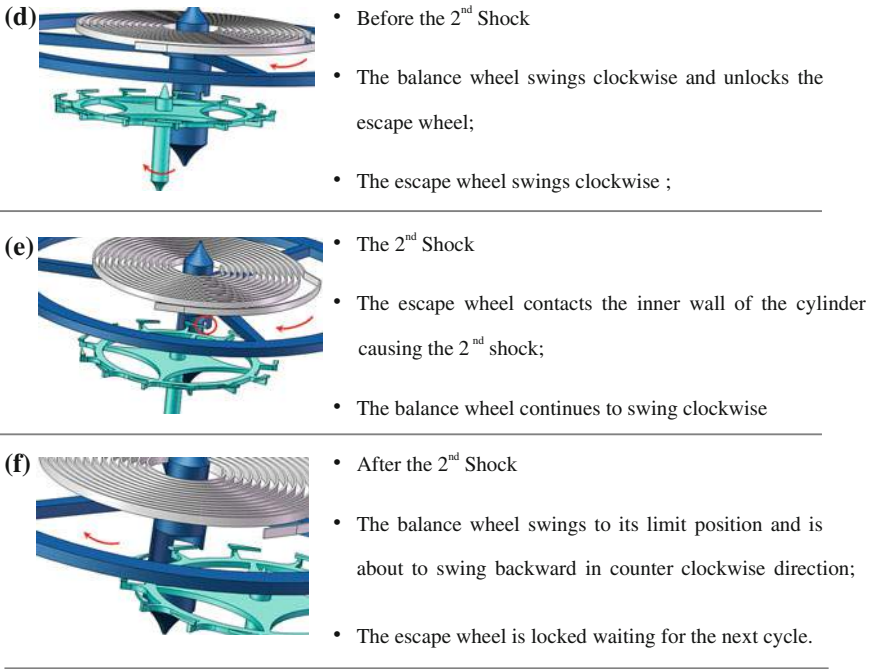

Fig. 2.27 continued

Fig. 2.28 Zylinderwerk 2 using cylinder escapement



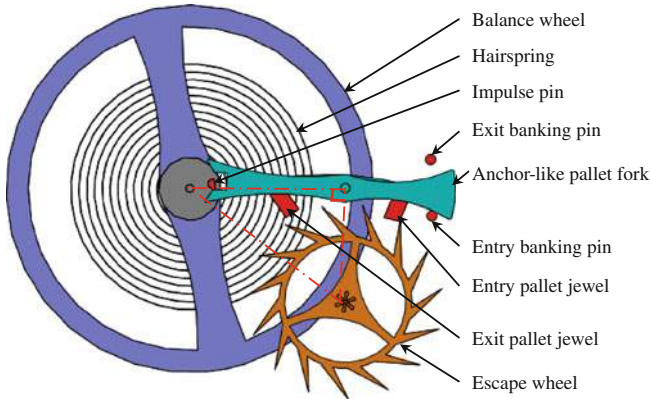

Fig. 2.29 The model of the English lever escapement

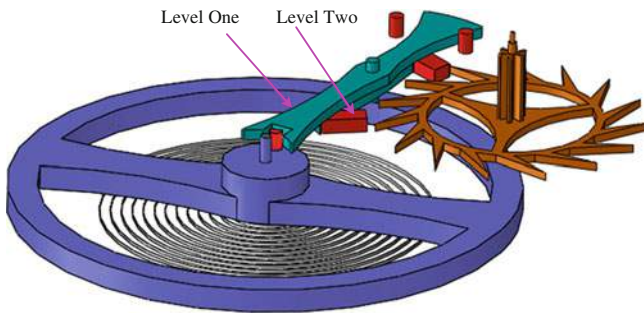

Fig. 2.30 The two levels of pallet fork in the English lever escapement

2.7 The English Lever Escapement

This escapement was invented by English clockmaker Thomas Mudge (1715–1794) in 1754 and hence, was referred to as the English escapement. Mudge was apprenticed to George Graham. It is one of the earliest escapements that does not require a pendulum and hence, is regarded as a milestone in the history of watch and clock.

As shown in Fig. 2.29, the English lever escapement is composed of four parts: the escape wheel, the anchor-like pallet fork, the balance wheel and the hairspring. The axes of the balance wheel, the pallet fork and the escape wheel form a right-angled triangle (as shown by the dot-dash line).

Note that the pallet fork has two levels as shown in Fig. 2.30: Level 1 is the balance wheel level, on which the balance wheel has a half-cycle shaped ruby, called the impulse pin, to turn the pallet fork. Level 2 is the escape wheel level, on which the escape wheel turns the two rubies on the pallet fork, called the entry pallet jewel and the exit pallet jewel. There are also two position pins that limit the

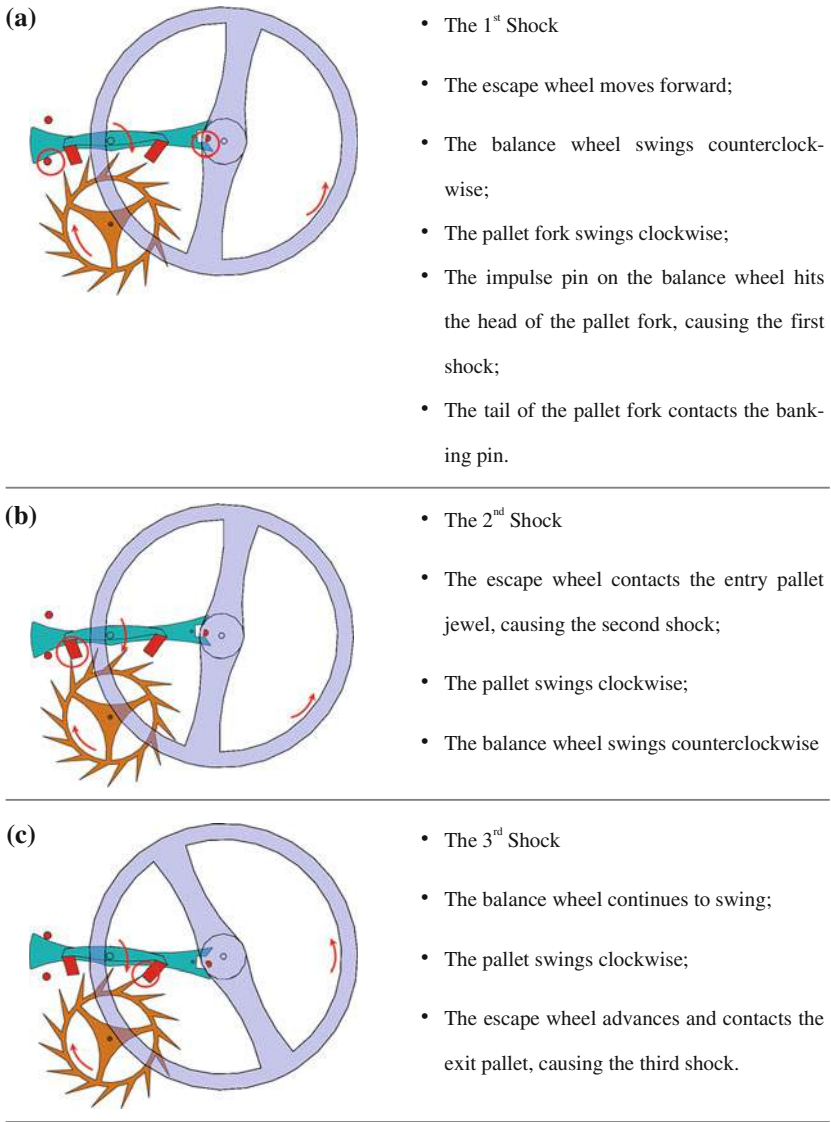

Fig. 2.31 The operation of the English lever escapement

swing of the pallet fork. The big innovation of the English lever escapement is the use of the hairspring. It allows the balance wheel swinging in a large angle and hence, is much more reliable.

Figure 2.31 shows the operation of the English lever escapement in a cycle. It is made of five shocks. The first shock is the contact of the impulse pin on the balance wheel with the head of the pallet fork. At the meantime, the tail of the

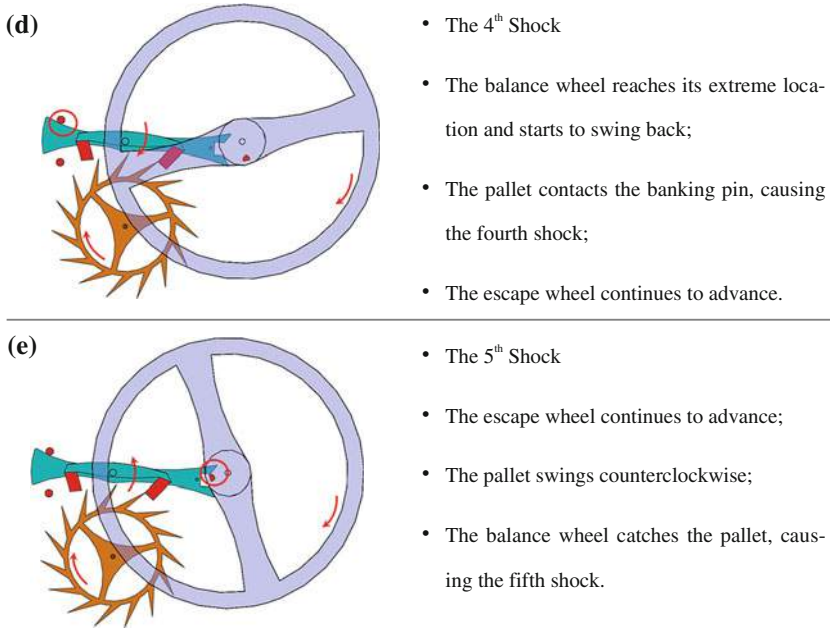

Fig. 2.31 continued

pallet fork touches the entry banking pin as shown in Fig. 2.31a. Then, the escape wheel is stopped by the entry pallet jewel causing the locking of the escape wheel. This is the second shock, which is seen in Fig. 2.31b. Figure 2.31c shows the third shock. At this time, the tooth of escape wheel contacts the exit pallet jewel. The escape wheel is stopped until the impulse pin on the balance wheel collides with the entry of the pallet fork again. As shown in Fig. 2.31d, the fourth shock occurs when the other side of the tail of the pallet fork touches the exit banking pin. At the same time, the balance wheel pauses and then starts rotating in the opposite direction. The fifth shock occurs when the impulse pin hits the other side of the entry of the pallet fork as shown in Fig. 2.31e. A computer animation is shown on the Springer Website <http://extra.springer.com/2012/978-3-642-29307-8>.

The English lever escapement was used for many years in the nineteenth century. One may still find them in antiques today, such as the one shown in Fig. 2.32.

2.8 The Swiss Lever Escapement

Appearing in the middle of the nineteenth century in Switzerland, the Swiss lever escapement is a modification of the English lever escapement. It is not clear who invented the Swiss lever escapement, though it was probably a team effort. It has



Fig. 2.32 An antique pocket watch with the English lever escapement

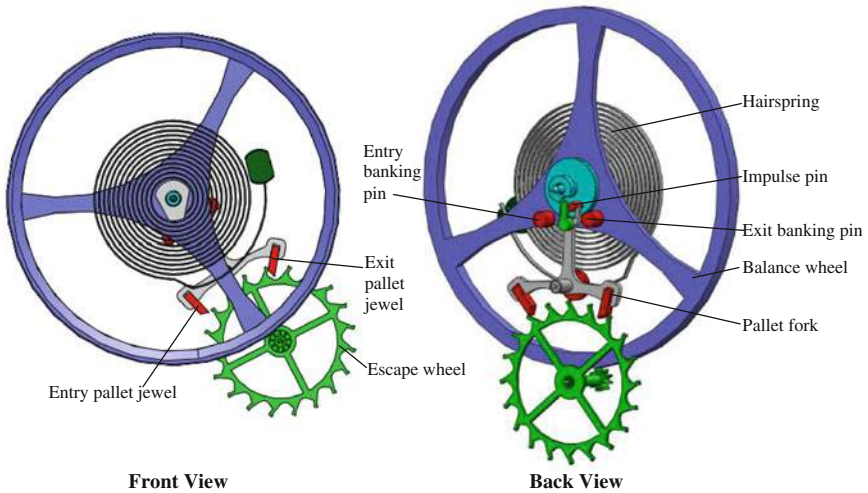
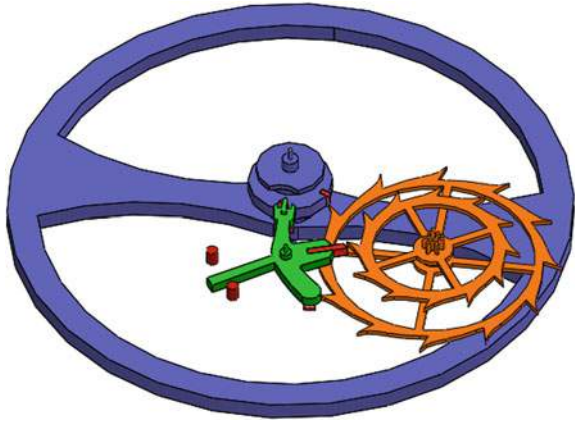

Fig. 2.33 The CAD model of the Swiss lever escapement

been the most commonly used escapement in the world ever since. In fact, at least 98% of the existing mechanical movements use this escapement because of its high degree of accuracy and reliability.

A model of the Swiss lever escapement is shown in Fig. 2.33. Similar to the English escapement, it consists of a balance wheel, hairspring, pallet fork and escape wheel. The pallet is shaped like a fork, giving it the name “pallet fork.” The pallet fork results in two significant improvements over the English lever escapement. First, the centers of the balance wheel, the pallet fork and the escape wheel are aligned in one line, making the power transmission more efficient and

Fig. 2.34 The model of the Daniels Co-Axial Escapement



stable. Second, the pallet fork needs only to swing a small degree (around 50° and 25° on each side) and hence, does not get much nonlinearity. Consequently, the accuracy of the timekeeping is being improved.

The Swiss lever escapement has had a number of different versions. For the model in Fig. 2.33, the escape wheel has 15 club teeth; therefore, the angle for each impulsive movement is $360/(2 \times 15) = 12$. Here, the factor 2 is resulted from the swinging of the balance wheel.

The operation of the Swiss lever escapement is somewhat similar to the English lever escapement. Because of its significance, we developed its mathematical model step by step, as detailed in Chap. 3. For the purpose of demonstration, a computer animation is shown on the Springer Website <http://extra.springer.com/2012/978-3-642-29307-8>.

2.9 The Daniel Co-Axial Escapement

In the past century, the design of the escapement has continued to evolve. The most significant invention is perhaps the Daniels co-axial double-wheel escapement. It is the masterpiece of Dr. George Daniels (1926–) (Wikipedia 2009). Dr. Daniels is a professional horologist with many achievements. Besides inventing the co-axial escapement, he is also the author of several books on mechanical watch movement (Cecil Cluttoh and George Daniels 1979; George Daniels 1981; George Daniels 2011) and the former president of the Horological Institute.

Figure 2.34 shows the model of the Daniels co-axial escapement. It is more complicated than the Swiss lever escapement and has three levels. Figure 2.35 shows the three levels of the escapement. On Level 1, the balance wheel contacts the pallet fork. The guard pins are also on this level. The escape wheel has two levels, one for the inner escape wheel and the other for the outer escape wheel,

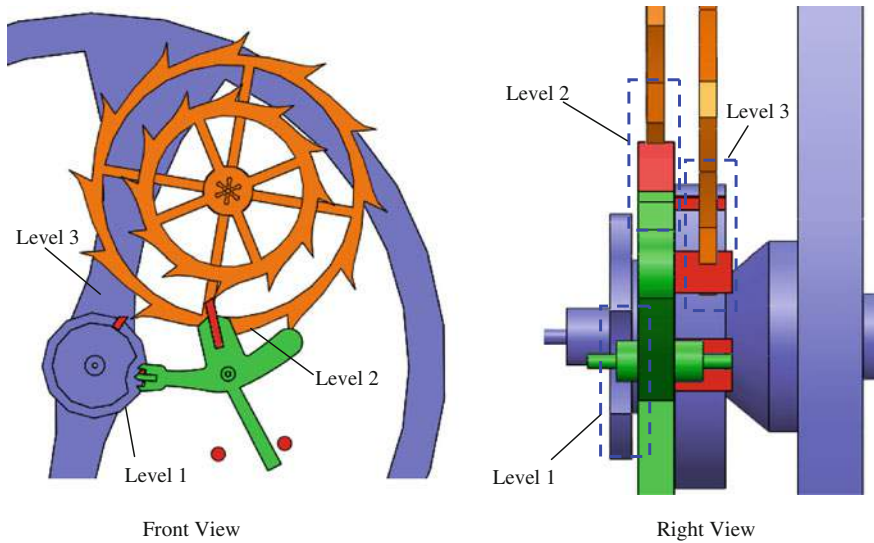

Fig. 2.35 The three levels of the Daniels co-axial escapement

with 12 teeth on each level. On Levels 2 and 3, the two levels of the pallet fork contact the two levels of the escape wheel.

As shown in Fig. 2.36, the Daniels co-axial escapement has six shocks in a cycle. Figure 2.36a shows the first shock. It occurs when the semi-circular impulse-pin on the balance contacts the entry pallet of the pallet fork to unlock the escape wheel. The escape wheel advances and the pallet fork swings clockwise. Figure 2.36b shows the second shock. It happens when the outer escape wheel shocks the impulse stone at the balance wheel. Then, the balance wheel continues to swing counter-clockwise until the escape wheel contacts the pallet fork to cause the third shocks, as shown in Fig. 2.36c. Next, the inner escape wheel touches the trapezium-shaped impulse stone of fourth shock and is shown in Fig. 2.36d. Here, the other side of the entry pallet of the pallet fork contacts the semi-circle shaped impulse-pin on the balance wheel. This impulse unlocks the pallet and escape wheel, causing them to rotate clockwise. Figure 2.36e shows the fifth shock when the inner escape wheel is stopped by the locking-stone on the pallet fork. The sixth shock, as shown in Fig. 2.36f, occurs when the pallet fork contacts the other guard pin. The cycle of the escapement is then completed. A computer animation is shown on the Springer Website <http://extra.springer.com/2012/978-3-642-29307-8>.

In comparison to the Swiss level escapement, the Daniels co-axial escapement has the same balance wheel and hairspring, but different escape wheel and pallet fork. These changes result in several advantages. First, within a cycle, the pallet fork only contacts the escape wheel once and hence, is more efficient. Second, the pallet fork swings only a small angle (30° and 15° on each side), thereby reducing the effect of nonlinearity. Finally, it minimizes the sliding between the escape

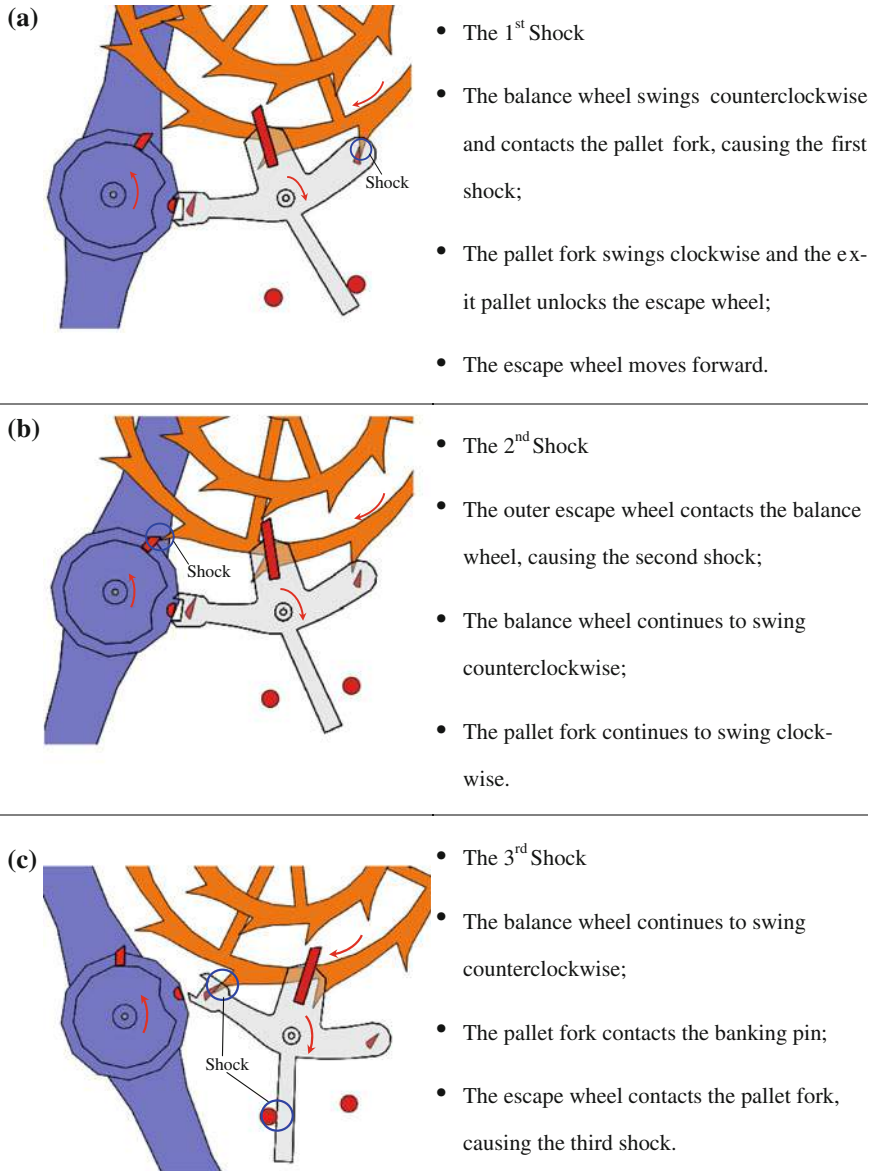
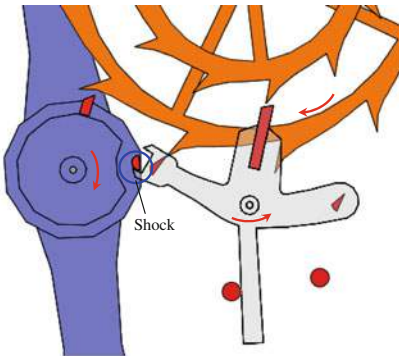

Fig. 2.36 The operation of the Daniels' co-axial escapement

(d)



- The 4th Shock
- The balance wheel reverses to swing clockwise;
- The pallet fork contacts the balance wheel, causing the fourth shock;
- The escape wheel is unlocked.

(e)

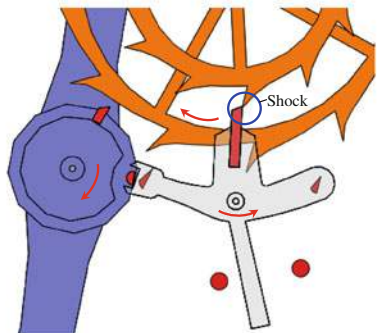

- The 5th Shock
- The pallet fork swings counterclockwise;
- The escape wheel contacts the pallet fork, causing the fifth shock;
- The balance wheel continues to swing clockwise and contacts the pallet fork, unlocking the escape wheel

(f)

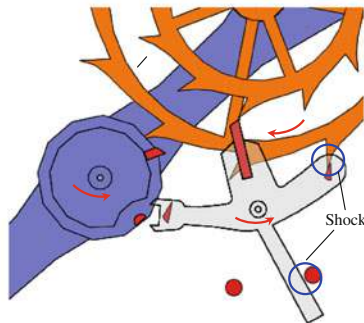

- The 6th Shock
- The pallet fork contacts the banking pin, causing the sixth shock;
- The escape wheel continues to move forward and catches the pallet fork;
- The balance wheel reaches its extreme and starts to swing counterclockwise.

Fig. 2.36 continued

Fig. 2.37 Omega movement based on Daniels's Co-Axial Escapement

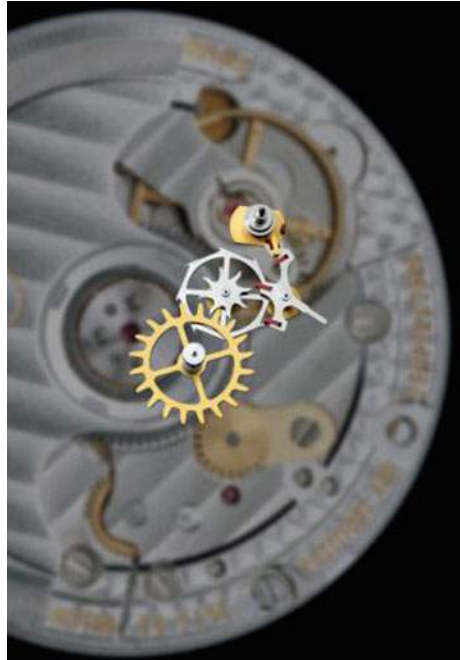

wheel and the pallet fork and hence, little lubrication is needed. All these improve the isochronisms. However, the trade-off is a more difficult manufacturing process. This escapement was adopted by Omega Co. for production since 1980s till the present day. A sample is shown in Fig. 2.37.

2.10 The Dual Ulysse Escapement

The newest escapement is the dual Ulysse escapement invented by Dr. Ludwig Oechslin in 2004 (Ludwig Oechslin 2004; Timebooth 2011). Dr. Oechslin received his Ph.D. in 1983 and his master watchmaker title in the subsequent year. Presently, he is the curator of the Musée International d'Horlogerie, in La Chaux-de-Fonds, Switzerland.

The dual Ulysse escapement is perhaps inspired by the independent double wheel escapement invented in 1800s. Figure 2.38 shows the model of the double wheel escapement. Like many old designs, the independent double wheel escapement was abandoned because of its complexity and lack of reliability.

As shown in Fig. 2.39, the dual Ulysse escapement consists of a balance wheel with a plate and a hairspring, a triangle-shape lever with two horns and two recesses and two escape wheels. There are also two pins used to limit the swing of the lever. Its most notable feature is the two escape wheels with specially designed tooth profile. Escape wheel 1 is driven by the gear train and meshes with Escape

Fig. 2.38 The independent double wheel escapement

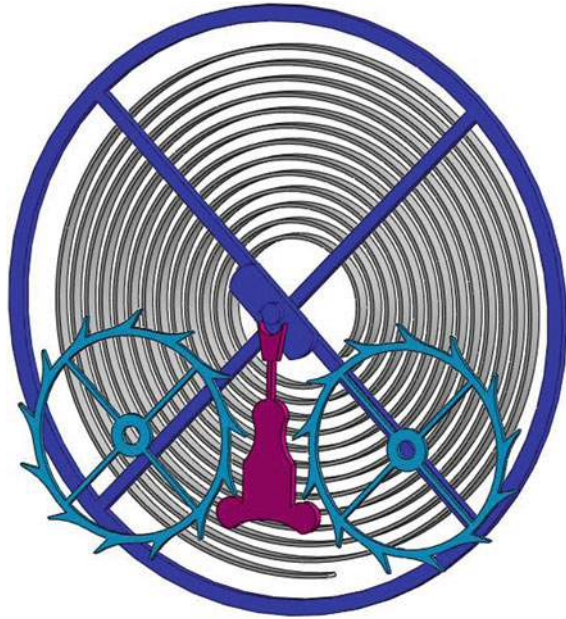

wheel 2. The two escape wheels also interlock with each other under the control of the lever. The lever receives pulses generated alternately by the first and the second escape wheels and transmits these pulses to the plate on the balance wheel, driving the balance wheel to swing. It also locks the first and the second escape wheels alternately. Thus, the lever fulfills a dual function: transmits the force to the balance wheel and locks the escape wheels alternately.

The operation of the dual Ulysse escapement is illustrated in Fig. 2.40. Figure 2.40a shows the safety phase that occurs before the first shock. Note that the lever is in contact to both escape wheels creating the lock. At the same time, the balance wheel is reaching its limit position and is about to swing clockwise. Figure 2.40b shows the unlocking phase, at which the first shock occurs when the plate on the balance wheel contacts the upper left horn of the lever causing it pivoting counter clockwise. This releases the two escape wheels. The locking phase is shown in Fig. 2.40c, in which the second and the third shocks occur almost at the same time. First, Escape wheel 1 contacts the first recess of the lever causing the second shock. Then, the upper right horn of the lever catches the plate of the balance wheel causing the third shock. At this time, the lever is in contact to both escape wheels creating the lock. Figure 2.40d is another safety phase, in which the balance wheel continues to swing, while the lever and the two escape wheels remain locked. Figure 2.40e shows the other safety phase. It is symmetric to Fig. 2.40b. Figure 2.40f shows the other unlocking phase, which is symmetric to Fig. 2.40c. Finally, Fig. 2.40g shows the other locking phase, which is symmetric to Fig. 2.40d. After that a new cycle will start.

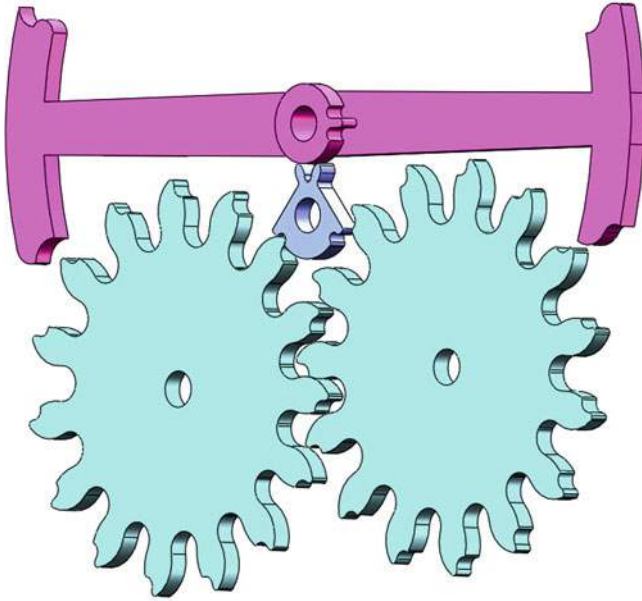

Fig. 2.39 The model of the Dual Ulysse escapement

The dual Ulysse escapement has several advantages; the symmetric escape wheel design makes the power transportation more effective. However, it also demands for higher manufacturing and assembly accuracy, as small errors may cause problems such as recoil. At present, Ulysse Nardin uses this escapement in its product line as shown in Fig. 2.41.

2.11 Concluding Remarks

According to the literature survey, there have been a number of monographs on the mechanical watch and clock. For example, George Daniels wrote two books: *Watchmaking* (George Daniels 1981) and *The Practical Watch Escapement* (George Daniels 2011). In particular, the first one covers all the fundamentals of watch making. He also co-authored a book on the history of the watch and clock (Cecil Cluttoh and George Daniels 1979). Donald de Carle wrote a handbook, but is relatively brief (Donald de Carle 1984). The recent book by Eric Bruton is also interesting (Eric Bruton 2004).

In recent years, with the development of the Internet, many Websites were developed to demonstrate the mechanical watch and clock online. Although these Websites are usually less organized, frequently changed and often inaccurate, they outperform books in terms of accessibility, readability (videos and animations make the contents easier to understand) and popularity. Some useful Websites include

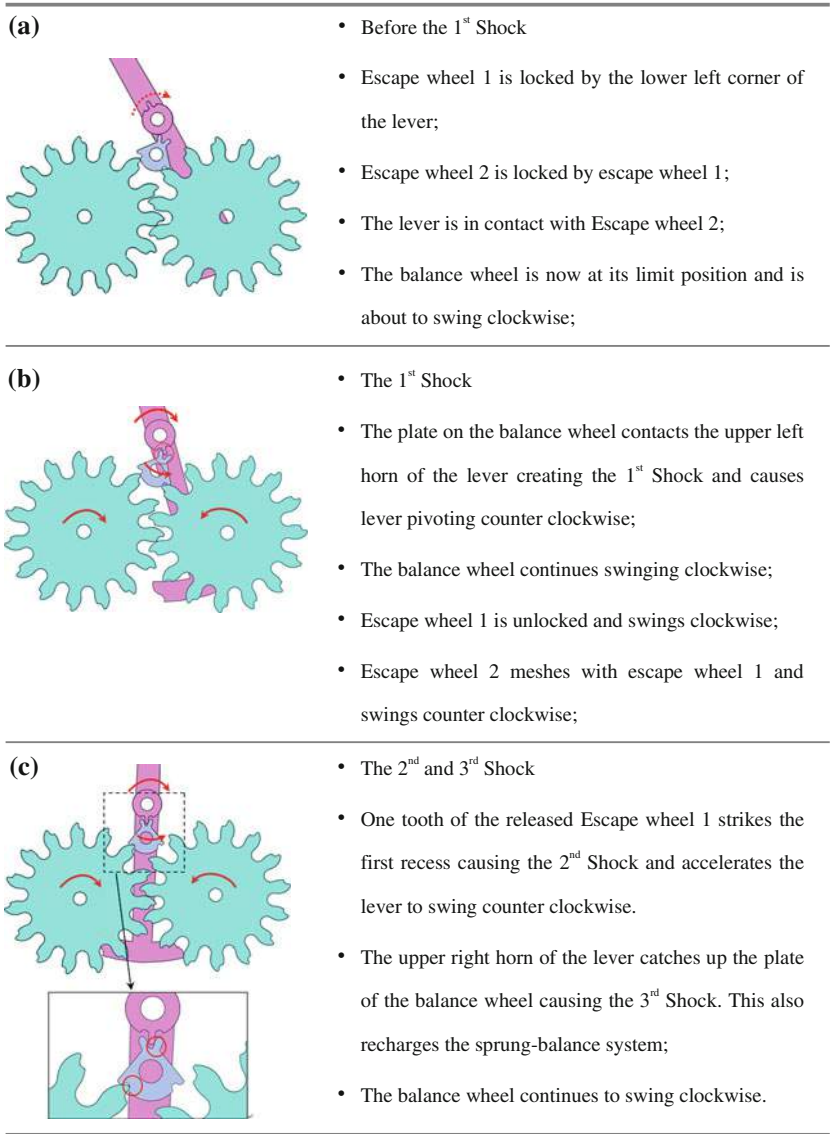

Fig. 2.40 The operation of the Dual Ulysse escapement

Clock Watch (Volker Vyskocil 2012), *Clock and Watch Escapement Mechanics* (Mark Headrick) and *A Brief History of Precision Timekeeping* (Ozdoba). In particularly, we recommend our website *Virtual Library of Mechanical Watch and Clock* (Institute of Precision Engineering, the Chinese University of Hong Kong 2011).

However, few studies have been carried out on the mechanics of the mechanical watch and clock, especially in the context of modern physics and mathematics.

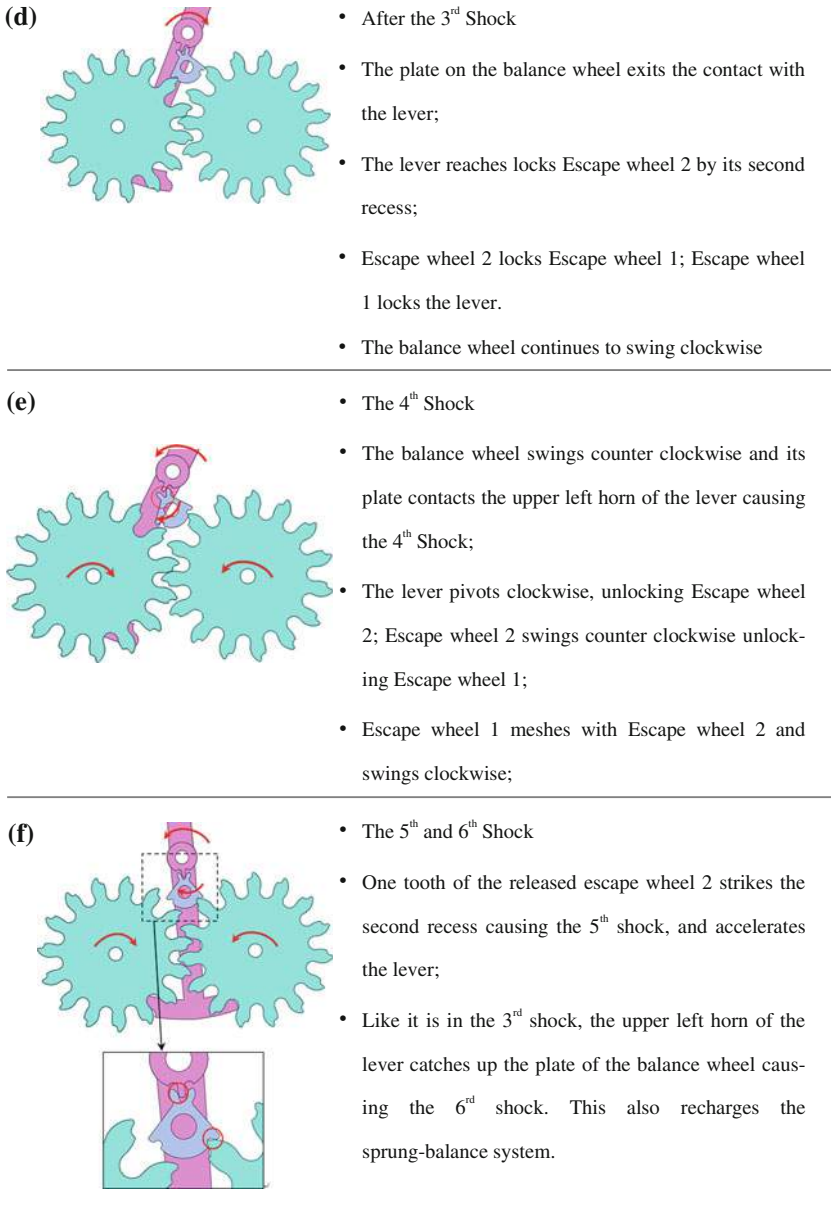
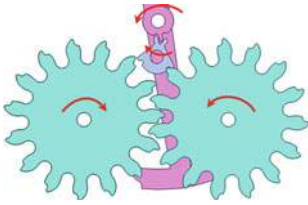

Fig. 2.40 continued

(g)



- After the 6th Shock
- The plate is about to quit the contact to the lever and continues swinging counter clockwise;
- Escape wheel 1 swings clockwise and then is locked by the lever; Escape wheel 2 swings counter clockwise and then is locked by Escape wheel 1;
- The lever is about to reach its limit position, after which the next cycle begins.

Fig. 2.40 continued

Fig. 2.41 Ulysse Nardin's "Freak Blue Phantom" with dual Ulysse Escapement



This is due in part to the fact that after the 1900s, watch making was considered a solved problem, to which scientists and engineers are less devoted. After the introduction of the quartz watch in the 1970s, modern electronics have taken the center stage. Scientists and engineers consider the mechanical watch and clock interesting, but not important. Furthermore, the mechanics of the mechanical watch and clock is rather complex. It takes a large amount of effort to simply understand its operation, not to mention its mechanics.

We had the opportunity to work on a project aimed at designing and manufacturing mechanical watch movements in 2005–2009. As a result, much information was collected and knowledge was gained. This monograph is not aimed at design and manufacture, but towards presenting a systematic study on the mechanics of the mechanical watch and clock. The readers may need solid background in engineering mathematics to fully understand the material.

It is crucial to note that the mechanics of mechanical watch and clock is unique, as is this book. Therefore, we hope that this book would serve as a valuable document for those both already in the business and interested in it. After all, the technology that has existed for more than six centuries is worth to be commended. As Elbert Einstein said, “the only reason for time is so that everything does not happen at once.” To note when events occur, we need to keep time. To keep time using a machine, we need to know its mechanics.

References

- Cecil Cluttoh and George Daniels (1979) *Watches: a complete history of the technology and development of the watch*, 3rd edition, Sotheby Parke Bernet Publishers Limited, London
- Donald de Carle (1984) *Watch & Clock Encyclopedia*. Random House Value Publishing, New York
- Eric Bruton (2004) *The History of Clocks & Watches*. Chartwell Books
- George Daniels (1981) *Watchmaking*, Philip Wilson Publishers Limited, New York
- George Daniels (2011) *The Practical Watch Escapement*, Philip Wilson Publishers Limited, New York
- Institute of Precision Engineering, the Chinese University of Hong Kong (2008) *Verge Escapement*. http://www.ipe.cuhk.edu.hk/projects10_vl=7English.html. Accessed 12 Dec 2011
- Institute of Precision Engineering, the Chinese University of Hong Kong (2011) *Virtual library of mechanical watch and clock*. Available at http://www.ipe.cuhk.edu.hk/projects10_library.html. Accessed 12 Dec 2011
- Ludwig Oechslin (2004) *Escapement for a Timekeeper*. US Patent 6,708,576 B2, March 2004
- Mark V. Headrick. *Clock and watch escapement mechanics*, Abbey Clock Clinic, Available at <http://www.abbeyclock.com/tframed.html>.
- Ozdoba C (2011) *A brief history of precision timekeeping—Part2: the 18th century*. Available at: http://www.ozdoba.net/swisswatch/history_part2.html. Accessed 12 Dec 2011
- Tam LC, Fu Y, Du R (2007) *Virtual library of mechanical watch movements*. CAD Solutions, Honolulu, 25–29
- Taqi al-Din Ibn Maruf (1550) *The Brightest Stars for the Construction of Mechanical Clocks, about 1550*. Available at http://www.enotes.com/topic/Taqi_al-Din_Muhammad_ibn_Ma`ruf
- Timebooth (2011) *Ludwig Oechslin*. <http://www.timebooth.com/watchmakers/38/>. Accessed 12 Dec 2011
- Volker Vyskocil (2012) <http://www.clockwatch.de/>
- Wikipedia (2001a) *Galileo Galilei*. http://en.wikipedia.org/wiki/Galileo_Galilei. Accessed 12 Dec 2011
- Wikipedia (2001b) *John Harrison*. http://en.wikipedia.org/wiki/John_Harrison. Accessed 12 Dec 2011
- Wikipedia (2001c) *John Harrison*. http://en.wikipedia.org/wiki/John_Harrison#The_first_three_marine_timekeepers. Accessed 12 Dec 2011

- Wikipedia (2002a) Robert Hooke. http://en.wikipedia.org/wiki/Robert_Hooke. Accessed 12 Dec 2011
- Wikipedia (2002b) Christiaan Huygens. http://en.wikipedia.org/wiki/Christiaan_Huygens. Accessed 12 Dec 2011
- Wikipedia (2004a) Piazza dei Miracoli. http://en.wikipedia.org/wiki/Pisa_Cathedral#Duomo. Accessed 12 Dec 2011
- Wikipedia (2004b) Verge escapement. http://en.wikipedia.org/wiki/Verge_escapement. Accessed 12 Dec 2011
- Wikipedia (2004c) Anchor escapement. http://en.wikipedia.org/wiki/Anchor_escapement. Accessed 12 Dec 2011
- Wikipedia (2004d) George Graham. [http://en.wikipedia.org/wiki/George_Graham_\(clockmaker\)](http://en.wikipedia.org/wiki/George_Graham_(clockmaker)). Accessed 12 Dec 2011
- Wikipedia (2004e) Grasshopper Escapement. http://en.wikipedia.org/wiki/Grasshopper_escapement. Accessed 12 Dec 2011
- Wikipedia (2004f) Escapement. http://en.wikipedia.org/wiki/Escapement#Detent_escapement. Accessed 12 Dec 2011
- Wikipedia (2005) Thomas Earnshaw. http://en.wikipedia.org/wiki/Thomas_Earnshaw. Accessed 12 Dec 2011
- Wikipedia (2006) George Daniels. [http://en.wikipedia.org/wiki/George_Daniels_\(watchmaker\)](http://en.wikipedia.org/wiki/George_Daniels_(watchmaker)). Accessed 12 Dec 2011
- Wikipedia (2008) Corpus Clock. http://en.wikipedia.org/wiki/Corpus_Clock. Accessed 12 Dec 2011
- Wikipedia (2009) Pierre Le Roy. http://en.wikipedia.org/wiki/Pierre_Le_Roy. Accessed 12 Dec 2011