

Natural Sciences and Technology

Grade 5-A
(CAPS)

sasol
reaching new frontiers



basic education
Department:
Basic Education
REPUBLIC OF SOUTH AFRICA

SIYAVULA
TECHNOLOGY-POWERED LEARNING

sasol
inzalo
foundation

Natural Sciences and Technology

Grade 5-A

CAPS

Revised for 2014

Developed and funded as an ongoing project
by the Sasol Inzalo Foundation in partnership
with Siyavula and volunteers.

Distributed by the Department of Basic Education.

COPYRIGHT NOTICE

Your freedom to legally copy this book

You are allowed and encouraged to freely copy this book. You can photocopy, print and distribute it as often as you like. You can download it onto your mobile phone, iPad, PC or flashdrive. You can burn it to CD, email it around or upload it to your website.

The only restriction is that you cannot change this book, its cover or content in any way.

For more information, about the Creative Commons Attribution-NoDerivs 3.0 Unported (CC-BY-ND 3.0) license, see <http://creativecommons.org/licenses/by-nd/3.0/>

The Thunderbolt Kids characters were originally created as part of the Kusasa project (www.kusasa.org), a Shuttleworth Foundation initiative. The Shuttleworth Foundation granted permission for the use of these characters and related artwork.

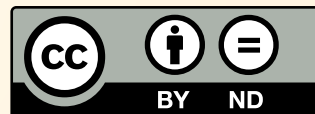

AUTHORS LIST

This book was written by Siyavula and volunteer educators, academics and students. Siyavula believes in the power of community and collaboration. By training volunteers, helping them network across the country, encouraging them to work together and using the technology available, the vision is to create and use open educational resources to transform the way we teach and learn, especially in South Africa. For more information on how to get involved in the community and volunteer, visit www.siyavula.com

Siyavula Core Team

Megan Beckett, Ewald Zietsman

Siyavula Extended Team

Neels van der Westhuizen, René Toerien, Bridget Nash, Heather Williams, Dr Mark Horner, Delita Otto, Marthélize Tredoux, Luke Kannemeyer

Contributors

Ronald Arendse, Prof Ilsa Basson, Rudolph Basson, Mariaan Bester, Darryl Bimray, Brandt Botes, Novosti Buta, Michaela Carr, Kade Cloete, Julian Cowper, Dawn Crawford, Zorina Dharsey, Octave Dilles, Shamin Garib, Sanette Gildenhuys, Nicole Gillanders, Celestè Greyling, Martli Greyvenstein, Lee-Ann Harding, Dr Colleen Henning, Anna Herrington, Ruth-Anne Holm, Adam Hyde, Karishma Jagesar, Wayne Jones, Kristi Jooste, Louise King, Paul van Koersveld, Dr Erica Makings, Dhevan Marimandi, Dowelani Mashuvhamele, Glen Morris, Busisiwe Mosiuoa, Andrea Motto, Gladys Munyorovi, Johann Myburgh, Mervin Naik, Alouise Neveling, Owen Newton-Hill, Mthuthuzeli Ngqongqo, Godwell Nhema, Brett Nicolson, Mawethu Nocanda, Seth Phatoli, Swasthi Pillay, Karen du Plessis, Jennifer Poole, Brice Reignier, Irakli Rekhviashvili, Jacques van Rhyn, Kyle Robertson, Ivan Sadler, Thaneshree Singh, Hélène Smit, Karen Stewart, James Surgey, Isabel Tarling, Rose Thomas, Dr Francois Toerien, Antonette Tonkie, Wetsie Visser, Vicci Vivier, Karen Wallace, Dawid Weideman, Dr Rufus Wesi, Matthew Wolfe

A special thank you goes to St John's College in Johannesburg for hosting the authoring events which led to the first version of these workbooks.

THIS IS MORE THAN JUST A WORKBOOK!

In many places you will see there are “Visit” boxes in the margins. These boxes contain links to videos online, interesting websites which pertain to the content, or else games or activities for you to complete.

To access these websites or videos, simply type the link provided into your address bar in your internet browser. The links look like this for example, *goo.gl/vWKnF*

You can watch these links in your lessons, at home on a PC, laptop or on mobile phones.

To download these workbooks or learn more about the project, visit the Sasol Inzalo Foundation website at *http://sasolinzalofoundation.org.za*

Welcome to Grade 5 and
to Natural Sciences and
Technology!

Join the
Thunderbolt Kids
on an adventure to explore the
world around us.





Hi there! My name is **Farrah**.

My favourite subjects at school are where I get to be creative and imaginative. But, did you know, this is not only in the art or drama classroom?! We can also be creative in the ways we do Science and Technology. This is especially true when thinking about new ways to answer a question with a Science investigation or drawing a design to solve a problem.

I also really love being outdoors in the natural world around me. This is why I am going to go through **Life and Living and Structures** with you. I think we are very lucky to live in such a beautiful place as South Africa, with so many colours and plants and animals. I am really excited to start learning more about the living world around us.

Sophie is my best friend and she teaches me how to think carefully and solve problems using logic, which is a very good skill to have in Science. Although we can get on each other's nerves, just like best friends do, we have so much fun together and learn a lot from each other.

Hey! My name is **Tom**.

I have two places where I am most happy! The first is in the Science lab because this is where we get to be inventive and tinker away with projects and experiments! My second favourite place is the junk yard! Do you know how many interesting objects you can find there?! I use these objects in my latest inventions.

This is why I am really excited to be going through **Matter and Materials and Processing** with you. This year we are going to learn more about materials, especially metals. And we will get to see how to make new materials. I find this really interesting, especially to see how these methods have evolved over time.

I also really enjoy maths and thinking about how we can solve problems logically. Jojo is one of my best mates, although he can be very messy at times! But, Jojo helps me get involved with my whole body when trying to solve problems in our daily lives, and not just use my mind.





What's up! My name is **Jojo**.

I just want to dive straight into this year, and especially Natural Sciences and Technology. Sometimes though, I find it hard to sit still in class as I just want to get up and do things! My teacher often says I have too much energy and I battle to sit still in class. Maybe that's why I am going through **Energy and Change and Systems and Control** with you this year.

I am really looking forward to understanding more about what "energy" really is! And, this year we start to learn about electricity. The best part about Natural Sciences and Technology for me is that we get to learn actively. We have goals and questions which we want to answer and I am always the first to leap into action!

Tom and I make a very good team because he is very good at thinking and planning and then following a method. But, I think I can also help as sometimes Tom wants to think too much, whereas in Science and Technology you also have to get involved in the subject and start experimenting.

Hello! My name is **Sophie**.

One of my favourite places to be is in the school library. I love reading a new book - there is just so much to learn and discover about our world!

I am always asking questions and often these questions do not yet have answers to them. To me, this is fascinating as we then get to make a theory about what we think the answer might be. This is why I really enjoy learning about outer Space as there is so much that we do not know. Throughout history people have been asking questions about Space and our place in the universe. This is why I am going to go through **Earth and Beyond and Systems and Control** with you. This year we will look more at our planet Earth and I am really interested to find out more about fossils.

I also like expressing my opinion and debating about a topic. You have to give me a very good argument to convince me of your opinion! I love exploring with Farrah as she helps me to be more creative and imaginative in the way that I think. I can also be quite sceptical and do not believe everything I read. But, this is very important in Science as we must not always accept everything as fact.



Join the
Thunderbolt Kids
by adding your details here!

My name is:

My favourite subject is:

On the weekends, I love to:

My friends' names are:

One day, I want to:

STICK OR DRAW
A PICTURE
OF YOURSELF
HERE!



Contents

Life and Living	2
1 Plants and animals on Earth	4
1.1 Many different plants and animals	5
1.2 Interdependence in an ecosystem	18
1.3 Animal types	28
2 Animal skeletons	44
2.1 Skeletons of vertebrates	44
2.2 Movement in Vertebrates	54
3 Skeletons as structures	62
3.1 Structures	62
4 Food chains	78
4.1 Food and feeding in plants and animals	78
4.2 Food chains	86
5 Life cycles	98
5.1 Growth and development	98
5.2 Plant life cycles	99
5.3 Animal life cycles	105
Matter and Materials	120
1 Metals and non-metals	122
1.1 Properties of metals	124
1.2 Properties of non-metals	133
2 Uses of metals	140
2.1 Special properties of metals	140
2.2 Uses of metals	155
3 Processing materials	162
3.1 Combining materials	163
4 Processed materials	188
4.1 Properties and uses	188
4.2 Traditional processing	196
5 Notes	218





**Life and Living
and Structures**

**DID YOU KNOW?**

Plants and animals need water to live. Scientists search for water on other planets because they hope that if they find water they might find life forms there as well!

**KEY QUESTIONS**

- What's the coldest place where animals live?
- How deep is the sea and are there animals and plants down there?
- Where is the highest mountain on earth? Do you get plants and animals that live up there?
- Do you get living things in a desert?
- What are vertebrates and invertebrates?

You might have heard that people say our planet Earth is the Blue Planet. When astronauts in space look down on Earth, the water that covers more than two thirds of the planet makes it look as if the planet is blue. Thousands of plants and animals can live on Earth because there is water.

The many plants and animals that live on earth choose special places to live. The place where a plant or animal lives is called its **habitat**.

There is a special word we use when talking about all the animals and plants and their different habitat. We call it 'biodiversity' When you look at the biodiversity of a certain area you look at all the different kinds of habitats in that area including all the animals and plants in that area.

QUESTIONS

Discuss this in class: Why is it important to study the biodiversity of our planet? Write down some of the main points from your class discussion below.

1.1 Many different plants and animals

The Earth is home to the most amazing diversity of animals and plants. Each animal and plant naturally chooses where it wants to live: its habitat.

We can identify different types of habitats on earth, such as:

- Aquatic (water)
- Desert
- Grassland
- Forest

Within each habitat there are animals and plants that have adapted to live specifically in that environment. Let's take a look at some of the most common plants and animals that live in each of these different kinds of habitats.

Let's now take a closer look at the different habitats in South Africa and some of the plants and animals that we find there.

Aquatic habitats

Thousands of different animals and plants live in or near water in aquatic habitats. There are two main kinds of aquatic habitats - marine (saltwater) habitats and freshwater habitats. The plants and animals that live in these habitats are adapted to either live in salt water or in fresh water.

In South Africa there are examples of both types of aquatic habitats.

Our country has a very long coastline with many different types of habitats. For example, many animals live in and around the rock pools. They have to withstand the harsh sun and the constant pounding of the waves.

New Words

- adapted
- extinct
- classify
- indigenous
- biome



DID YOU KNOW?

"Aqua" means "water" in Latin. A word with "aqua" in it normally has something to do with water - like aquatic or aquarium.



DID YOU KNOW?

South Africa is the only place on earth where the great white sharks have learnt to jump out of the water when they catch seals (off Seal Island in False Bay).



Starfish are found in rock pools along the coast



Seagulls resting on a shore

DID YOU KNOW?

Female dolphins are called cows, males are called bulls and young dolphins are called calves.



A rocky coastline with rock pools

Our seas are also filled with animals of all shapes and sizes. Large mammals like whales and dolphins swim in our seas.



Dolphins playing in the waves ¹



A Southern Right whale with her calf off the coast of Hermanus, a popular breeding ground for whales in September. ²

The sea is also home to many species of fish. A group of fish is called a school of fish. The coral reefs off the South African coast, especially on the East coast such as Sodwana Bay, are very rich in fish and animal species.

Where a river runs into the sea, a special area called an estuary develops. The fresh water from the river mixes with the salty sea water. You can often find mudskippers here (fish that can hop onto land and into trees!)



Mudskippers live in estuaries, but they can hop onto land and into low branches! ³

DID YOU KNOW?

The waters off South Africa's coast is home to a rare fish - the coelacanth! Scientists thought this prehistoric fish was extinct until they found living coelacanths in South Africa's waters!



ACTIVITY: Identifying marine animals and plants

INSTRUCTIONS:

1. Carefully study the pictures of different marine animals and plants off South Africa's coast.
2. Answer the questions about these pictures.





A crab ⁴



A school of fish ⁵



A crayfish in the shallow water ⁶



A penguin diving down under the water ⁷



Green seaweed flowing in the water ⁸



Mussels growing on the rocks ⁹



*Sharks*¹⁰



*Jellyfish*¹¹



*Kelp seaweed*¹²



*Turtles*¹³

QUESTIONS:

1. Can you imagine how difficult it must be to live on rocks being pounded by waves all day and all night long? Which animals in this picture live on or near the rocks?

2. Carefully study all the animals in the pictures and find things that some animals have in common. Classify the animals into groups based on these similarities.

3. Many eco-tourists like to visit our country and see the natural sights and attractions. Some tourists like to go on tours where they enter into a cage which is lowered into the water. The tour operators often chuck small pieces of meat into the water to attract sharks which then swim around the cage. This is called shark cage diving. Do you think shark cage diving is appropriate? Explain why you think so.

DID YOU KNOW?

Sharks have amazing hearing. They can hear a fish moving in the water from as far as 500 metres away!



Now let's look at the plants and animals that live in freshwater, such as dams, ponds, stream and rivers.

Many animals live in or near freshwater ponds, dams and lakes, rivers and streams. These include small insects, snails, clams, crabs, frogs and fish. Larger animals like turtles, snakes, ducks and large fish, as well as hippos and crocodiles also live in or near water.



Ducks raise their ducklings near plants where there is enough food for their young in between the reeds and water plants.



Hippopotamuses live in and around freshwater.



Can you see how this frog is resting on the lily pad?



A crocodile lies by the side of a river.

Some water plants have roots, for example water lilies and reeds. Water plants make oxygen for the animals to breathe and provide food for many of the animals to eat.



Water lilies floating on the water. ¹⁴

DID YOU KNOW?

Waterblommetjie bredie (stew) is made from a type of water lily! Have you ever eaten it?!



In South Africa we also have large wetlands where rivers slow down and the water stands still or flows very slowly. Wetlands provide food and shelter and a natural habitat for an incredible amount of animals: frogs, reptiles, birds (like ducks and waders) and fish, to name a few!



ACTIVITY: Studying an aquatic habitat

Work in groups of 3 or 4

MATERIALS:

- pencil
- paper
- clipboard
- sunblock and a hat

INSTRUCTIONS:

1. Visit an aquatic habitat near your school; a stream or river, pond or dam, or perhaps a rockpool if you are near the sea.
2. Find examples of 3 different animals and 3 different plants that live in that environment.
3. Carefully study where they live and how you think the animals and plants are suited to their habitat. Answer questions such as:
 - a) Are the stems of the plants rigid or flexible?
 - b) Do the plants grow inside the water or just outside?
 - c) What do the animals eat?
 - d) How do the animals breathe?
4. If possible, take some pictures of the plants and animals you observe.
5. Report this information back to your class.

Deserts and semi-desert habitat

Deserts are areas that have a very low rainfall each year - in some deserts it only rains once every 10 years!



The Namibian desert.

The desert may look dry, but there are many different plants and animals which are suited to living in these areas. Plants that can survive without much water in the desert include grasses, acacias, aloes, cactii and other succulents. Succulents are plants that can store their water in their leaves and stems and survive well in dry climates.



Can you see how thick the leaves of this succulent plant are? The leaves are where the plant stores water.

Many animals live in the desert (for example, the Kalahari), including:

- Predators (eg. lions, cheetahs and leopards, hyenas, jackals)
- Large and small mammals (eg. meerkats, giraffes, warthogs, porcupines)
- Antelope (eg. eland, gemsbok, springbok and hartebeest, steenbok, kudu, duiker)

- Many species of birds (eg. falcons, ravens, eagles, buzzards, hawks, turtle doves). The social weavers are small weaver birds that build family nests where hundreds of weaver families can live!
- Many different reptiles (eg. puffadders, cobras, lizards, geckos iguanas)
- A great many insects also live in the desert, such as bees and butterflies, grasshoppers and many more!



An alert meerkat



A huge nest made by social weaver birds¹⁵



An eland



A jackal

DID YOU KNOW?

Elephants can change a forest area into a grassland in a matter of months! They break off tree branches, smash tree trunks and eat the bark, leaves and twigs.



A puff adder



Warthogs

Grassland habitat

Grasslands are covered in grasses with very few trees. As soon as the first rains fall the grasses grow incredibly fast and new plants sprout all over the bare earth. This is also the time when many animal babies are born as the new grass can feed the mothers to provide plenty of milk for the young.

QUESTIONS

List some of the animals which you think live in grasslands.



Forest habitat

A forest is a large area that is mostly covered in trees. Forests are extremely important to life on earth. The many trees clean the air and provide oxygen for the animals on earth to breathe. They also provide people with fuel, food and shelter, medicine and employment (through all the industries that are built around forestry). Many animals live in forests, from large elephants and bears to smaller monkeys, squirrels, owls and woodpeckers.

We need to conserve (look after) our forests and stop people who want to chop down naturally growing trees. It is very important to also conserve the many animals that help pollinate trees and spread their seeds over large areas. Without these animals the trees would not be able to reproduce and would become extinct.



Inside the Knysna forest, one of South Africa's few indigenous forests.



An elephant in the Knysna Forest elephant park.



ACTIVITY: Counting plants and animals

MATERIALS:

- Something to mark out an area such as stones or sticks to make the corners and string to tie in between
- scrap paper
- pencil
- clipboard
- sunblock and hat
- measuring tape/ruler

INSTRUCTIONS:

1. Work in pairs
2. Take a walk with your class to a park or nature area outside your school.
3. Choose an area where the two of you would like to work.
4. Carefully place the string around a section of your area.
5. Study the animals and plants in that area.
6. Make a drawing of the habitat inside your marked out area showing all the plants and animals that you see there. Use scrap paper for this.
7. Do you know the names of these plants and animals? Perhaps an adult can help you name the animals or plants you don't know? Write the names of each of these animals and plants next to each drawing.
8. Make sure that you have examples of at least 5 different plants and 5 different animals in your picture.
9. Measure the height of each plant and record them all in the table below.

New Words

- herbivores
- carnivores
- omnivores
- scavengers
- decomposers
- depend
- ecosystem
- pollinator
- water vapour
- atmosphere



1.2 Interdependence in an ecosystem

Plants and animals, humans, rivers, mountains - everything is connected in one way or another. All living and non-living things depend on each other.

We can group interdependence into two main groups:

1. The interdependence in an ecosystem between living things (how animals and plants are interdependent).
2. The interdependence in an ecosystem between living and non-living things.

Interdependence between living things

Many plants and animals depend on each other for different things. Let's have a look at some of these:

1) Interdependence and feeding

Animals depend on plants and other animals for food. Animals can be divided into the following groups, according to what they eat:

- Herbivores eat plants.
- Carnivores eat the animals that eat the plants.
- Omnivores eat plants and animals.
- Scavengers feed off plants and dead animals.
- Decomposers are animals that assist the natural process of decomposition. They eat and break down the remains of dead animals. The elements that are released during this process (carbon, phosphorus and nitrogen) are put back in the soil and become food for plants.

2) Interdependence and pollination

Plants depend on animals for pollination.

Animals that pollinate flowers are called **pollinators**. Plants use different methods to attract pollinators. This includes producing nectar, special smells or having brightly coloured flowers. Some plants even make their flowers look like female wasps to attract male wasps!

DID YOU KNOW?

An ecosystem is a community of living things that depend on, and interact with, each other and the non-living things (water, air and soil) in their different habitats.





Bees about to collect nectar and, at the same time, pollinate the flowers.
16

Plants and animals depend on each other. Many flowering plants depend on bees to pollinate them. Bees depend on flowers to provide them with nectar. Without nectar, bees cannot make honey. Without bees, most flowers cannot be fertilised. If flowers are not fertilised, they cannot produce seeds and will not be able to reproduce.



Bird feeding off the nectar and pollinating the flower 17



A wasp feeding off the nectar and pollinating the flowers 18

DID YOU KNOW?

Pollinate means the pollen from one flower needs to get to the pollen from another flower to pollinate it.



DID YOU KNOW?

Sometimes farmers don't have enough bees on their farms to pollinate their crops. They "rent a hive" from travelling bee hive managers who bring their hives to pollinate the farmer's crops.





QUESTIONS

Bees are not the only animals that can pollinate flowering plants. What animals do you think can pollinate a tree's flowers? Look at the pictures below.

VISIT

Video on pollinators
goo.gl/y7kAh



DID YOU KNOW?

1/3 of everything we eat is there thanks to pollinators! We really depend on pollinators for our food!



A beetle feeding off a flower. As it moves around the flower, it also pollinates the flower. ¹⁹

A world without pollinators would not be very sweet. Look at the following things we eat and drink that all depend on pollinators.



Without pollinators, we would not have blackberries and raspberries to eat. ²⁰



Strawberries are delicious! The fruits are produced once the flowers on the strawberry plants have been pollinated. ²¹



²²Different types of nuts form after pollination.



Red and green apples are the fruits produced on apple trees after pollinators have pollinated the flowers. ²³

3) Interdependence and seed dispersal

Plants need to have their seeds spread over a wide area. If all the seeds fall in one spot, the plants that grow will not have enough water, soil or sunlight to grow properly! That is why plants make their fruit sweet and tasty. In this way they attract animals who will eat the fruit, walk a long way off and excrete the seeds. Where the seeds fall they will then have a rich, fertile soil (from the animal excretion) to grow in! Other seeds stick to an animal's fur - they might not even know it's there! When they brush against a tree for example, the seed will just fall off. Plants depend on animals for seed dispersal.



ACTIVITY: The honey badger and the honey guide

This is an example of interdependence between three different animals.

INSTRUCTIONS:

1. Read the story about the honey badger and the honey guide below
2. Answer the questions which follow.

The honey badger loves to eat honey! The honeyguide bird loves to eat the bee larvae, but cannot get into the beehive without being stung to death. The bird also cannot break the hive open. So when the honeyguide finds a beehive, it goes in search of a honey badger. The honey badger has a thick skin that is resistant to bee stings.

VISIT

The honey badger and honey guide (video)
goo.gl/G10qG



The honey guide convinces the honey badger to follow it to the bee hive. The honey badger is able to use its strong legs and claws and teeth to break open the hive while its thick coat protects it from being stung. After the badger has finished eating the delicious golden honey, the honeyguide can enjoy all the bee larvae!



The honey badger follows the honey guide bird.

QUESTIONS:

1. Why can't the honey guide bird just eat some of the larvae without waiting for the honey badger?

2. How does the honey badger break open the hive?

3. Why does the honey badger not get stung by the bees?

4. Explain in your own words how this is an example of interdependence between three animals.

Interdependence between living and non-living things

Living things are also depend on non-living things in an ecosystem. Living things depend on their environment for:

- Air (oxygen and carbon dioxide)
- Water
- Soil
- Food
- Shelter and a place to safely have their young.
- Places to hide from danger.

Water and oxygen are extremely important for all living things.



QUESTIONS

Have you ever wondered how the water "gets" into the clouds if it runs in rivers and streams? Remember when you learnt about the Water Cycle in Grade 4?

Water that we drink from a tap or from a river, is all part of a very big system called the Water Cycle. The Water Cycle is a very good example of how all living things are interdependent.



ACTIVITY: The water cycle

INSTRUCTIONS:

1. This image of the Water Cycle shows all the processes which take place.
2. Revise these with your partner next to you.
3. Write a paragraph below where you explain the cycle

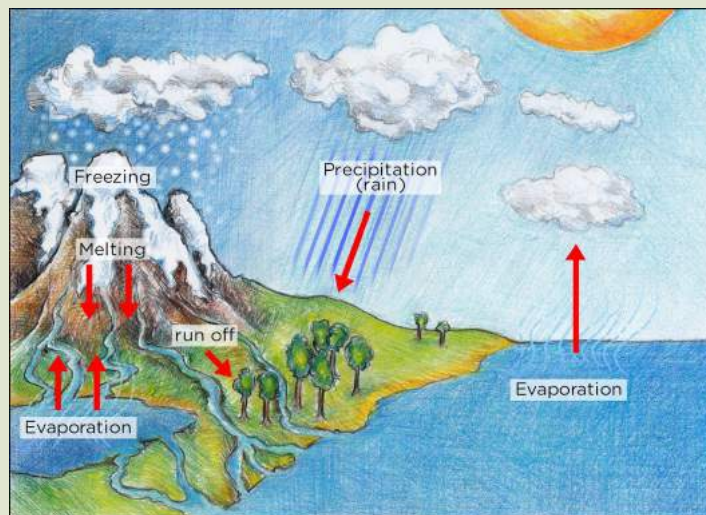

The Water cycle.

QUESTION:

1. You can change the water vapour you breathe out into water drops again! Find a mirror or window. Breathe on it. What do you see on the window?



Trees and other plants depend on the water in the soil. Other animals and plants depend on the water that runs down from the mountains in rivers and streams and collects in lakes. Plants and animals in the sea depend on this water as it forms the environment that they live in.

ACTIVITY: Describing Interdependence

INSTRUCTIONS:

1. Work in groups of 3.
2. Carefully study these animals and see if you can identify the interdependence between the animals and/or plants and the non-living things in their environment.
3. Discuss the interdependence with your group and make some notes on scrap paper.
4. Descriptions of each picture have been provided. You need to match the picture with the description by writing the correct letter next to each picture.



Picture	Answer	Description of interdependence
		<p>A: Clownfish and anemones. Clownfish are not hurt by the poison from the anemone. The clownfish feed on small creatures living in the anemone. These creatures can harm the anemone. Not only does the clownfish remove these creatures, but the anemone uses its waste for nourishment. The anemone's poisonous stings protects the clown fish from predators.</p>
		<p>B: Earthworms in soil. Earthworms are dependent on the soil for a place to live. If the earthworm is exposed to air for too long, its skin will dry out. That is why they need rich, moist soil to live in. As earthworms dig through the soil they also excrete droppings back into the soil which makes it more fertile for other plants and animals. Their digging helps to aerate the soil by creating tunnels.</p>
		<p>C: Weaver bird building its nest. Many birds need trees and plants to build their nests in so they can raise their young. The weaver uses young, green reeds to build its nest. These reeds are flexible and bend easily. When they dry out, they become harder and make a stable, stronger nest.</p>



D: Rhino and oxpecker. The oxpecker eats the ticks that are on the rhino's skin. The oxpecker feeds on these ticks and the rhino is freed from the pests. Oxpeckers have the same relationship with zebra, giraffe, buffalo, etc.



E: Anatolian Shepherds and the herd of sheep they are protecting from predators. Anatolian puppies are placed with a flock of sheep at an early age. They become attached to the flock. When a predator (like a cheetah) comes near the flock, the Anatolian Shepherd dogs will chase the predator off. When a flock is protected by an Anatolian Shepherd, the predators (for example, cheetahs) are also indirectly protected, because the farmers will not need to kill them in order to protect their sheep.

QUESTIONS:

VISIT

Website about the
Cheetah conservation
project
goo.gl/Roayb



1. In the pictures above, which interdependent relationship is between an animal and a plant?

2. In the pictures above, which interdependent relationship described is between an animal and the non-living things in its environment.

3. Which example in the pictures involves the interdependence between three animals, and what are they?

New Words

- vertebrates
- invertebrates
- exoskeleton
- endoskeleton
- hydroskeleton
- observation
- terrarium
- molluscs
- classify



1.3 Animal types

Now we know more about the different habitats on Earth and in South Africa. We also know that animals and plants depend on each other and on their habitat. Let's look at the different types of animals that live on planet Earth.

Grouping animals

When we group similar things together, it is called classifying. When classifying animals, there are generally two main groups of animals - those who have bones **inside** their bodies with a backbone, and those who do not have bones inside their bodies.

- Animals with a backbone are classified as **vertebrates**.
- Animals without a backbone are classified as **invertebrate**.

ACTIVITY: Classifying animals

INSTRUCTIONS:

1. A radiographer takes X-rays of people and animals to see the bones inside their bodies. Tracey, a radiographer, took some interesting X-rays of 5 animals. Carefully look at these X-rays and decide which animals are vertebrates.

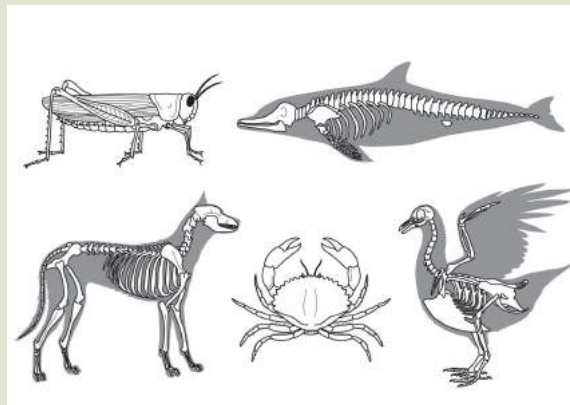

Examples of vertebrates and invertebrates

Animals that are vertebrates:

2. Look at the X-rays of the crab and the grasshopper. Can you see a backbone in their bodies? Why do you think this is?
-

3. What do we call animals like the grasshopper and the crab?
-

4. Study the animals from the previous activity on interdependence. Decide if they are vertebrates with bones INSIDE their bodies, or invertebrates without bones INSIDE their bodies.



5. Write the name of each animal in the correct column below.

Vertebrates with bones	Invertebrates without bones

When people realised that they could group the animals into two main groups, they went even further and started grouping them into smaller groups within the two main groups. Look at this next illustration which shows some of these groups.

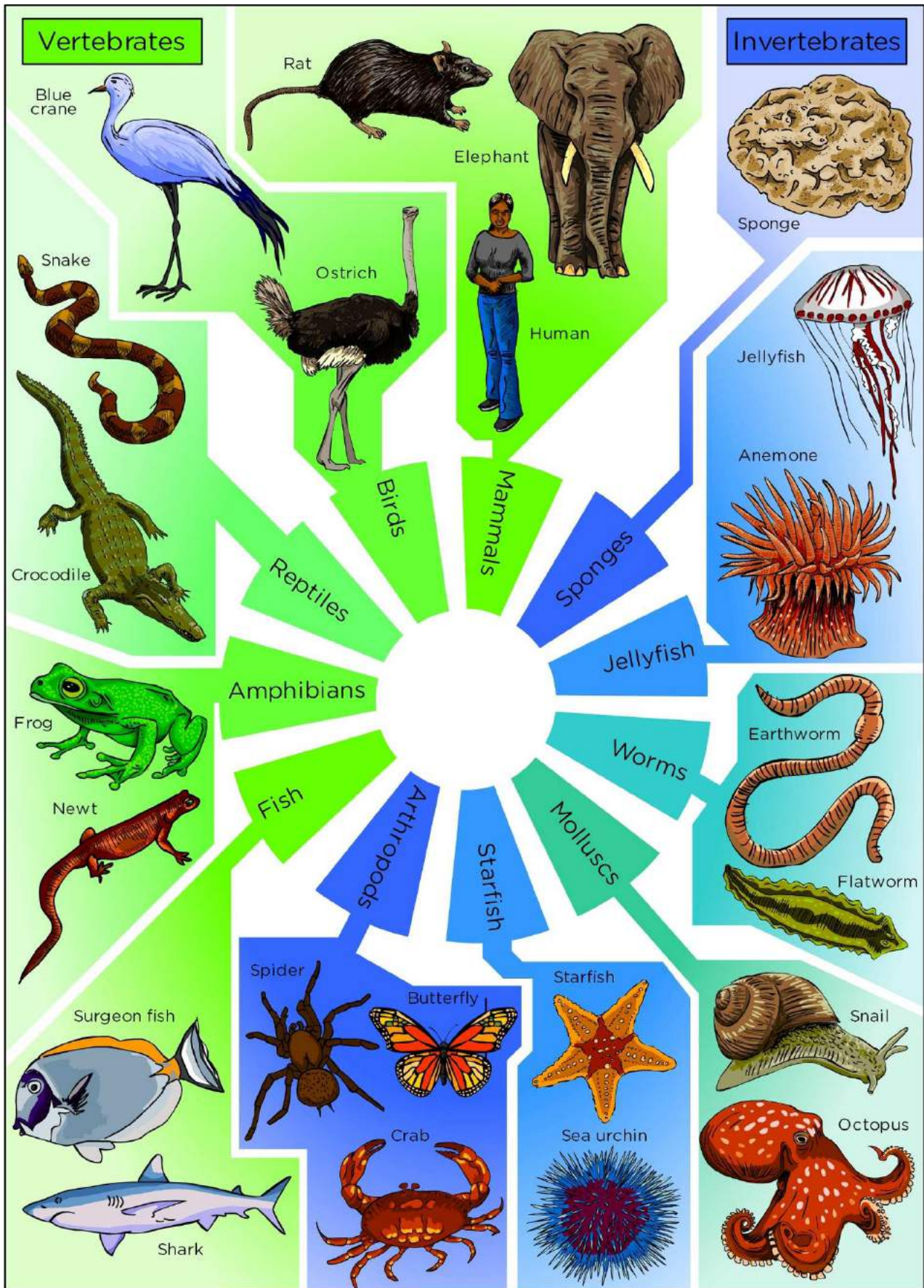

Classification of animals



QUESTIONS

1. Have a look at the illustration of all these different groups. Why do you think the animals were put into a left group and a right groups?

2. Vertebrates are divided into 5 groups, what are these groups?

3. One of the birds in the illustration is our National Bird, which one is it?

DID YOU KNOW?

If "hydro" is in a word, that word generally has something to do with water!



Let's take a closer look at invertebrates and vertebrates.

Invertebrates

Invertebrates are animals that do not develop a backbone (spinal column). They also do not have an endoskeleton (a bony skeleton inside their bodies). They do develop a different types of skeletons, like hydroskeletons and exoskeletons.

QUESTIONS

Look at the illustration of all the classes of animals again. Can you find other examples of animals with no bones inside their bodies (endoskeleton) and with no hard outer skeleton (exoskeleton)?



These soft-bodied animals mostly have what we call a hydroskeleton. Examples of animals with a hydroskeleton are:

- sea anemones
- earthworms
- jellyfish
- some starfish and sea urchins

Animals with such a body often need to live in or near water or damp soil. Their skins are often thin and moist because they breathe through their skin.



An earthworm needs to live in damp soil.²⁴



A jellyfish has a hydroskeleton.²⁵

Many invertebrates have a shell or hard covering protecting their bodies. This external skeleton is called an exoskeleton.

DID YOU KNOW?

Hermit crabs have very soft bodies, not like their other crab and crayfish family. The hermit crab finds an empty shell and settles down inside it. When the crab grows too big for the shell, it moves out and finds a bigger shell!





QUESTIONS

Can you think of any invertebrates that have exoskeletons? Have a look at the previous illustration again if you need some ideas.

DID YOU KNOW?

97% of animals alive today are invertebrates! (That means almost all animals are invertebrates!)

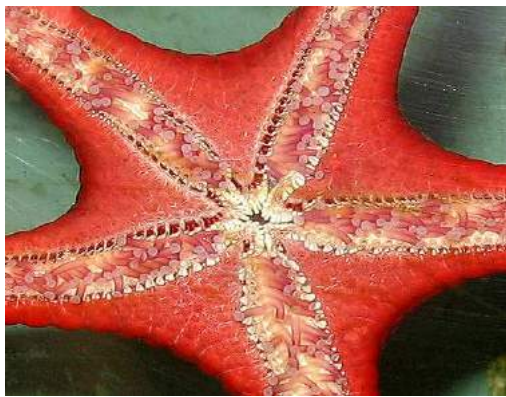

Underneath a starfish. Can you see the little "legs" sticking out of the exoskeleton?²⁶



Sea shells protect the soft bodies of invertebrates.²⁷



A hermit crab hiding safely in a hard shell.²⁸



The hermit crab now decides it is safe to walk around.²⁹

Insects are in an interesting group of invertebrates.



- All insects have exoskeletons.
- They all have segmented bodies and legs. That means their bodies and legs are made up of different sections.
- Insects have six legs and three main body parts - a head, a chest (thorax) and a tail (abdomen).

ACTIVITY: 1, 2, 3, 4, 5 ...once I caught a bug alive!

INSTRUCTIONS:

1. Study the invertebrates in these photos.
2. Can you see if they have a head, chest and tail?
3. Carefully count their pairs of legs (if you can't see all their legs!)
4. Do they have any wings?
5. Write the number of legs and/or wings each invertebrate has in the space below it.
6. Describe how each animal's body is covered.



			
	30	31	32
Legs			
Wings			
Coverings			

Vertebrates

VISIT

A video about
endoskeletons video:
goo.gl/I51sz



Vertebrates are animals that have a skeleton inside their bodies (an endoskeleton). Part of their skeleton is a backbone. The word 'vertebrate' is closely related to the word 'vertebrae' which is what we call the individual bones that form the backbone (so vertebrates have a backbone made up of vertebrae). Vertebrates are broken down into 5 smaller groups:

- Fish
- Amphibians (including frogs)
- Reptiles
- Birds
- Mammals

Vertebrates grow much larger than invertebrates because their bones grow with them and can support their muscles.



ACTIVITY: Identifying common characteristics

INSTRUCTIONS:

1. Work in pairs and study these pictures of animals that all have an endoskeleton.
2. Identify characteristics that are similar in all these animals.
3. Write down your observations on scrap paper.
4. Report back to the class and compare your ideas with those of your friends. Add or change your observations on the scrap paper.



*A dog*³³



*An elephant*³⁴



A frog ³⁵



A human ³⁶



A seagull ³⁷



A shark ³⁸



A crocodile ³⁹

QUESTIONS:

1. Complete the sentence below by writing down all the characteristics which are common to animals with endoskeletons.

Animals with endoskeletons all...

2. Write down two examples of mammals from the above pictures.

3. What type of bird is shown in the picture?

4. Give an example of a reptile.

Let's take a look at the differences and similarities between exoskeletons and endoskeletons.



ACTIVITY: Extension: Comparing endoskeletons and exoskeletons

INSTRUCTIONS:

1. Divide into groups of 5 - 7.
2. Carefully study the above section on Animal types and

especially focus on the differences between exoskeletons and endoskeletons.

3. Brainstorm as many differences between exoskeletons and endoskeletons in your group as you can think of.
4. Once you have brainstormed in your group, share your ideas with the class and discuss these.
5. Record this comparison in the table below.

	Exoskeleton	Endoskeleton
Examples of animals		
Position of the skeleton		
Functions of the skeleton		
Muscle attachment		
Joints		
Mode of movement		



KEY CONCEPTS

- There are many different plants and animals.
- They live in different habitats on Earth.
- All the plants and animals and their habitats make up the total biodiversity of the Earth.
- South Africa has a rich variety of indigenous plants and animals and their habitats.





REVISION:



- Match the type of habitat in the left column to the appropriate description in the right column by drawing a line between the correct pairs.
Next to each habitat write an example of an animal and plant that live specifically in that kind of environment. Choose animals that live specifically in that habitat.

Example of a plant and animal that lives in this habitat	Habitat	Description
	Forest	Even though the animals in this habitat can be the biggest on the planet, some of these giants only eat tiny plants!
	Desert	Many large mammals and other animals and a range of plants and big trees live here.
	Aquatic	Very few trees grow here even though the soil is fertile.
	Grassland	Very few plants grow here because water is not readily available.

2. Write a short description of the interdependence of the honey badger, the honey guide bird and the bees. Which animals benefit from this relationship and which do not?

3. Name the different types of skeletons.

4. In the table below write which kind of skeleton the animal has then in the next column write whether the animal is an invertebrate or a vertebrate.

Animal	Type of skeleton	Vertebrate or Invertebrate?
 <p>A grasshopper ⁴⁰</p>		
 <p>A bluebottle ⁴¹</p>		

 <p>Cape sparrow</p>		
 <p>Tortoise 42</p>		
 <p>Frog 43</p>		
 <p>Crab 44</p>		



I loved learning about some of the plants and animals that live on our planet Earth.

Let's now take a closer look at animal skeletons, including our own!



KEY QUESTIONS

- What does my skeleton look like?
- Why do I have bones in my body?
- Do all skeletons look like mine?
- Can you tell if a skeleton belongs to an animal or a human?

2.1 Skeletons of vertebrates

New Words

- backbone
- skull
- spinal column
- ribs
- shoulder blades

You now know that all vertebrates have bones inside their bodies, while invertebrates do not.

Every time a vertebrate animal moves, it uses its bones, joints and muscles. In this section we are going to study the bones, joints and muscles that help vertebrates to move.

Bones

Bones are hard and form a very strong frame structure to support and protect a vertebrate animal's body.

Vertebrates all have similar kinds of bones - some are much bigger than others, but the basic structure of the bones are very similar.

VISIT

The skeleton song
goo.gl/SPfw1

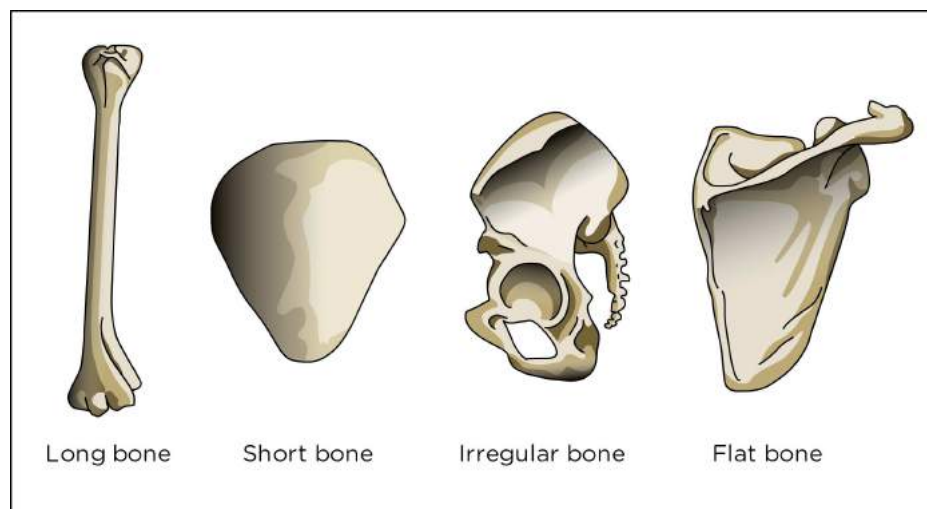

Different kinds of bones.

ACTIVITY: Identifying bones in your body

MATERIALS

- Photocopied bones puzzle picture of the human skeleton
- Photocopied labels that go with the picture of the human skeleton
- Scissors
- Glue
- Recycled thin cardboard such as a cereal box
- Pencils and ruler
- Colouring pencils if you want to decorate your skeleton



INSTRUCTIONS:

1. How many functions of the bones in the skeleton can you remember?

2. Your teacher will hand out a jumbled puzzle of the human skeleton. Carefully cut out each piece along the dotted line.
3. Build your human skeleton on the back of your recycled cardboard - do not stick it on yet as you might need to move it slightly if it does not fit properly onto the cardboard.
4. When you have it in place correctly, use glue to stick it to the cardboard.
5. Cut out the labels from the table.
6. Carefully pack the labels in the correct places - do not stick these down until you have done all of them as you might need to reposition them to fit it all in.

DID YOU KNOW?

An adult human has an average of 206 bones in their body!



Here are the words of a song that teaches you about bones. The chorus lines has been left out each time.

1. Work in groups of 5 - 7.

2. Compose a rap rhythm and beat, compose your own tune or use an existing song to accompany these lyrics. Feel free to make or use instruments to accompany your singing.
3. Present your song to the class.

The Bone Song

Your head bone's connected from your neck bone,
Your neck bone's connected from your shoulder bone,
Your shoulder bone's connected from your back bone,

So...

Your back bone's connected from your hip bone,
Your hip bone's connected from your thigh bone,
Your thigh bone's connected from your knee bone,

So...

Your knee bone's connected from your leg bone,
Your leg bone's connected from your ankle bone,
Your ankle bone's connected from your foot bone,
Your foot bone's connected from your toe bone!

So...



Now that you know where all the bones in the body are, you are probably wondering what exactly each bone's job is. Let's find out.



ACTIVITY: The bones in the human skeleton

INSTRUCTIONS:

1. Examine your skeleton puzzle. This illustration of the human skeleton might also help. Pay special attention to the shapes of different kinds of bones.
2. Can you identify examples of the four different kinds of bones? Write the examples of each kind of bone that you can find in this table.

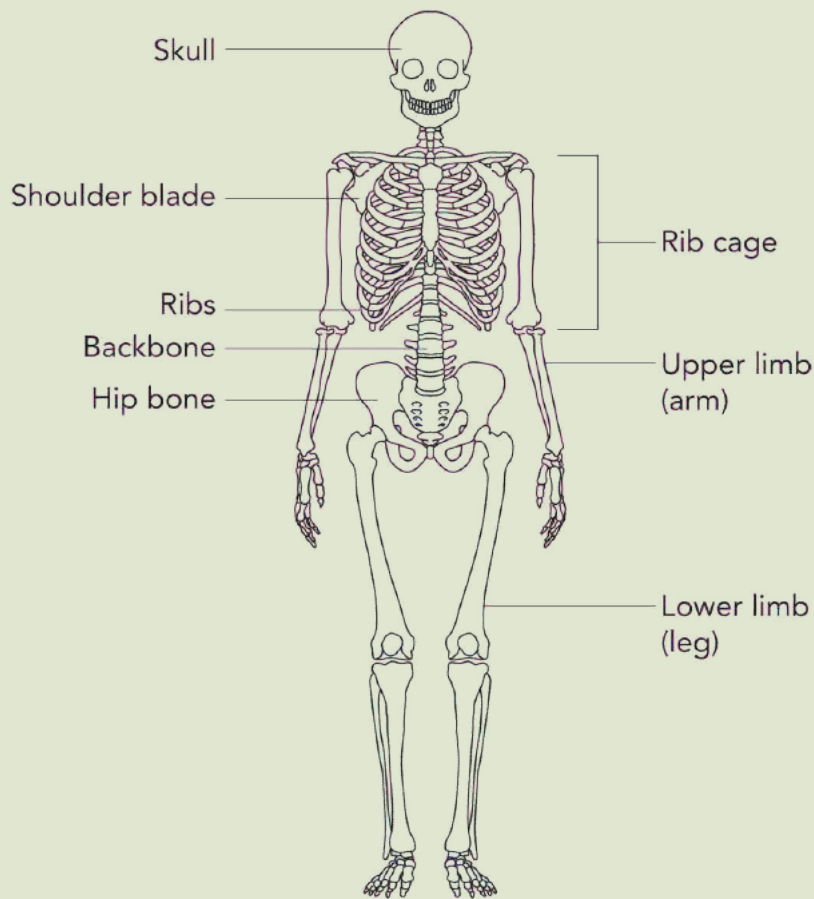

The human skeleton.

Type of Bone	Where in the vertebrate body can you find it?
Long bones	
Short bones	
Flat bones	
Irregular bones	

3. Now see if you can identify these bones in some other vertebrate skeletons! Use this key to show on the picture of the skeleton where the different bones are :

- L = Long bone
- S = Short bone
- F = Flat bone
- I = Irregular bone

Cat skeleton

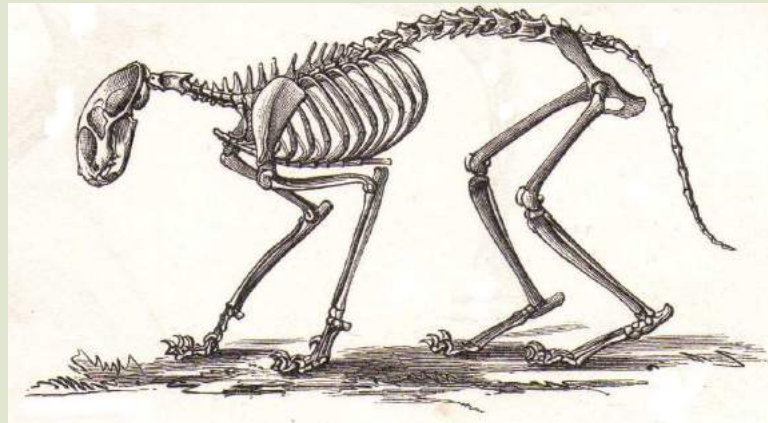

Fish skeleton

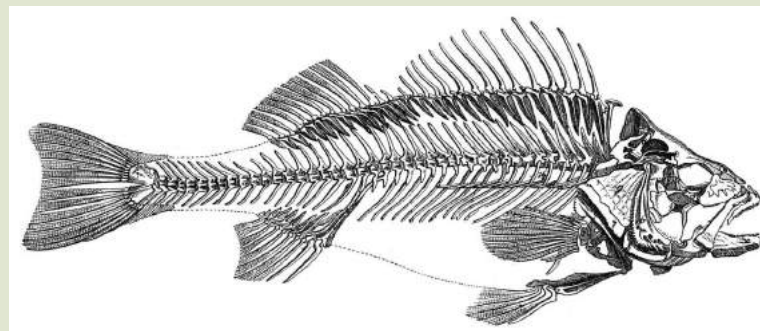

Frog skeleton

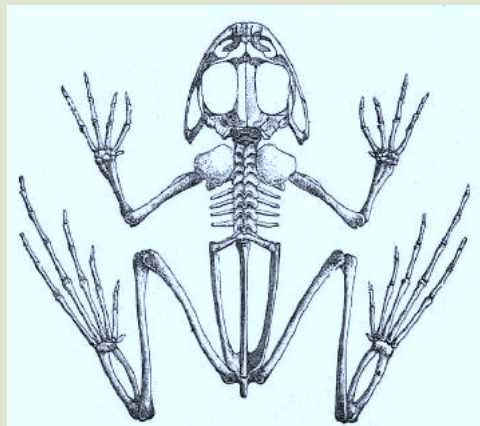

QUESTIONS:

1. Which of the animals is a mammal?

2. Which is an amphibian?

Now that you know how to identify the different kinds of bones in vertebrates, let's take a closer look at the functions of some of these bones.

Functions of the bones in a vertebrate skeleton:

1. The skull

The vertebrate skull is made up of different bones that grow together to form a protective "box" or "shell" structure.

- The skull protects the eyes and ears, nose and mouth.
- It protects the brain.
- The teeth and the lower jaw is also attached to the skull.

2. The backbone

- The backbone is made up of vertebrae.
- A hole runs through the middle of each vertebrae. When the vertebrae are connected, the holes all line up to form a tube. This is where you find the spinal cord. The spinal cord is a bundle of nerves that is connected to the brain. It is surrounded by blood vessels.
- The backbone has two functions (jobs):
 - It protects the spinal cord that runs inside it.
 - It supports the upper body.



QUESTIONS

Can you identify the animals that each of these skulls belong to? Write the name in the space below each skull.

DID YOU KNOW?

A baby and an adult do not have the same amount of bones. When a baby is born, their skull bones are not joined. The bones can move over each other to allow the baby to go through the birth canal! After birth the skull bones start to grow together!



The human backbone and vertebrae.

QUESTIONS

Compare the bones in the backbone of the giraffe below with that of the human above. What do you notice about the shape of the vertebrae in the neck and in the back of the giraffe and those of the human's neck and bones?



Giraffe skeleton.



DID YOU KNOW?

Giraffe only have 7 vertebrae in their necks - go ahead and count them. That is exactly the same as in a human neck - and almost all other mammals.



3. The ribs

Vertebrates have long curved bones around their chest. We call these bones ribs. These ribs are joined to the backbone and often to the front to form the rib cage.

- In most vertebrates, the ribcage is around the chest area of the animal to protect the lungs, heart and other important organs.
- In animals like snakes, the ribcage can protect and support the the whole body.
- The breast bone in birds is much longer. The flight muscles attach to this.

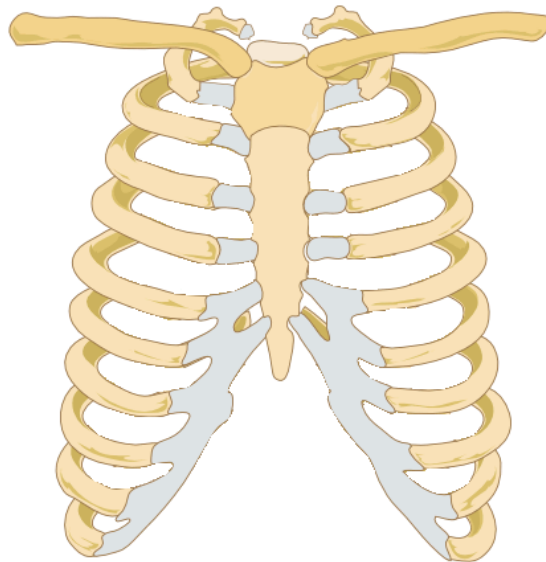

This is a human rib cage.

Many mammals have a similar shape rib cage. Compare the rib cages of these animals to your own.

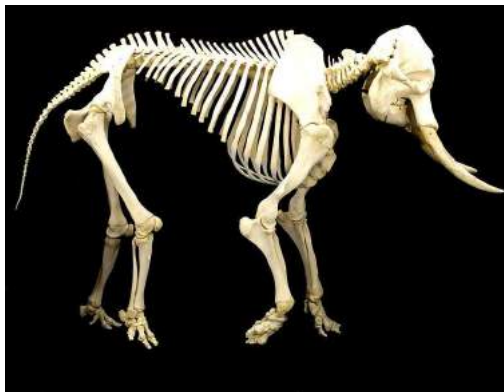

An elephant skeleton - do you see the rib cage and backbone?

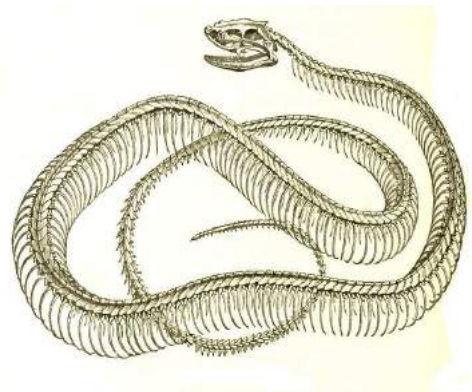

A snake's rib cage protects and supports almost the whole body.



A dolphin - do you see the front limbs look just like the other mammals' limbs?

4. Shoulder blades, arms, legs and hip bones

Vertebrates use their fore and hind limbs for movement.



The human arm. Can you see the flat shoulder bone, and the long bones making up the arm?

Many animals' limbs are attached to their bodies at the shoulder or hip joints. However not all animals have hip or shoulder girdles - like fish and snakes.

- Muscles attach to the shoulder blades and they control the movement of the forelimb or arm.
- The lower or back limbs (legs) attach to the body at the hips.

VISIT

Videos about the skeletal system

[goo.gl/D5wuL](https://www.youtube.com/watch?v=D5wuL)

[goo.gl/TMRRy](https://www.youtube.com/watch?v=TMRRy)



The bones in different vertebrate limbs look very similar. Look at the picture which, shows the limbs of different animals.

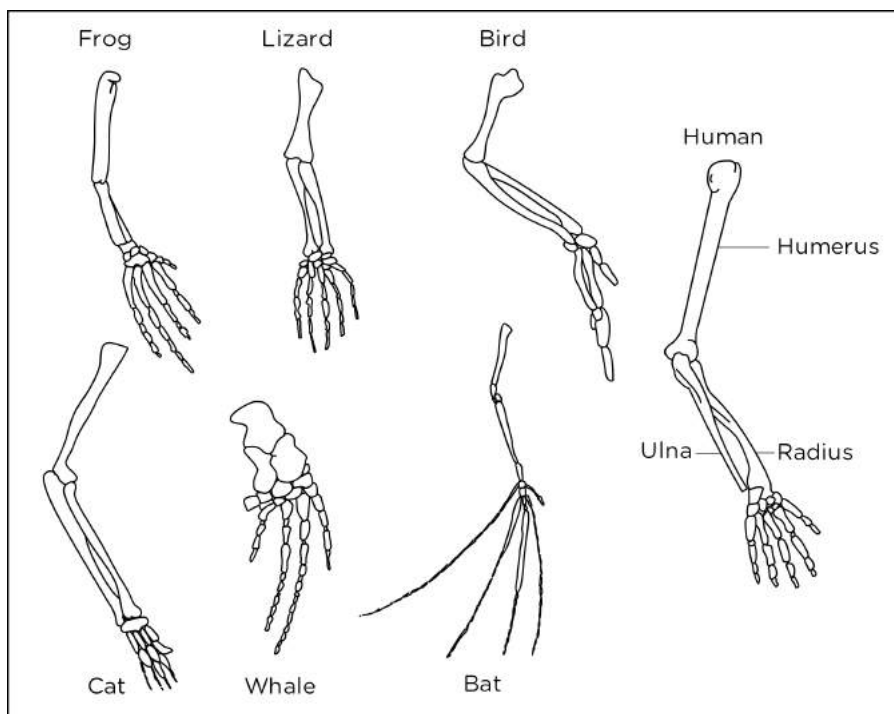

Different forelimbs of vertebrate animals.

New Words

- ligament
- tendon
- joint

2.2 Movement in Vertebrates

Now that you know a little more about a bones, let's see how animals use their bones, joints and muscles to help them move.

QUESTIONS

Do you remember what a skeleton's function is? List as many of the functions of the skeleton as you can think of below.

Vertebrate animals can move because of two really important things:

1. They have **joints** between their bones that can let their bones move.
2. Their **muscles** are attached to their skeletons.

If you want to know how an animal moves you need to know how their joints and their muscles work.

Joints

Joints are the places where bones come together. They come together in a special way to allow the animal or human to move - like at your elbow or wrist. There are different kinds of joints.

VISIT

Video: Types of joints
goo.gl/5BhaI



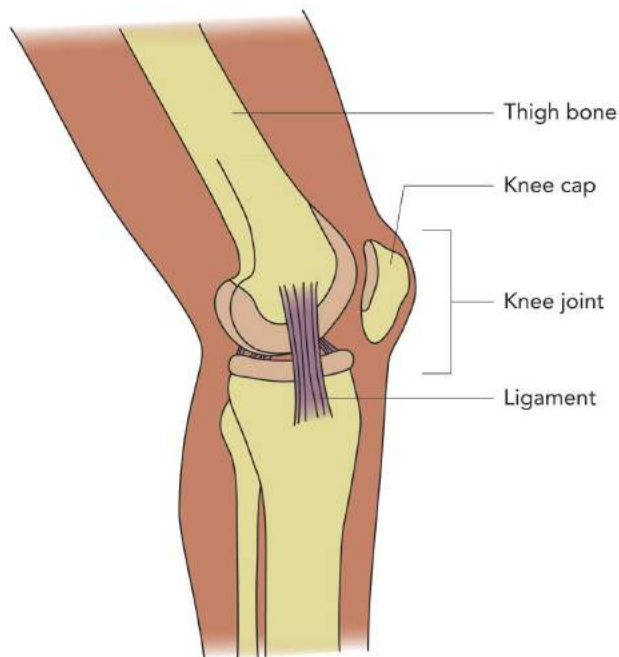

This is a knee joint. Can you see that it is where the bones of the leg come together?

QUESTIONS

List four other joints in your skeleton.



How do the bones and the joints move?

Look at the example of the moving arm. Look at the picture. There are two muscles which enable your arm to move - your tricep and bicep. They work as a pair. When the one muscle contracts, the opposite muscle relaxes.

To bend your arm, the bicep muscle "contracts" and pulls on the radius bone. The tricep muscle relaxes, allowing your arm to bend at the elbow joint.

To straighten your arm, the tricep muscle contracts and pulls on the ulna bone while your bicep muscle relaxes and your arm straightens.

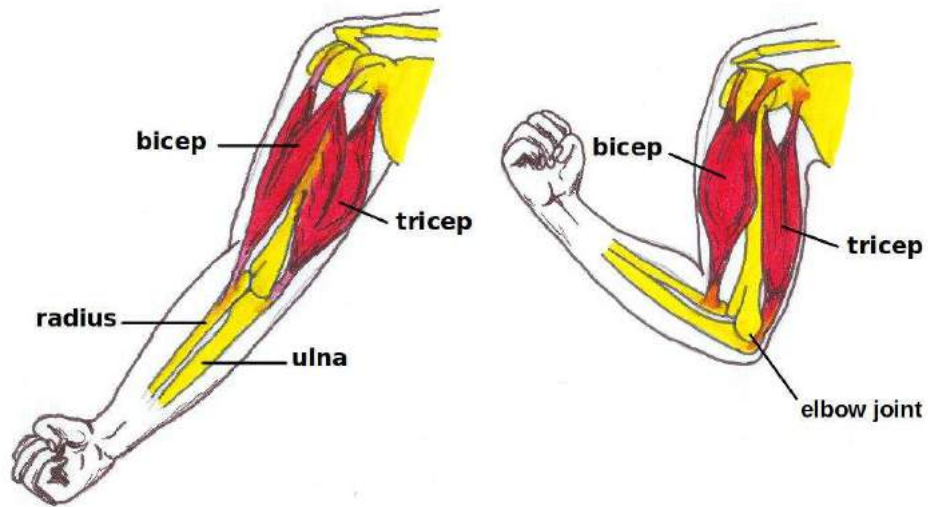

The arm moves using muscles, joints and bones.



ACTIVITY: Describing movement in vertebrates

INSTRUCTIONS:

Now that you know that bones and joints are controlled by muscles, let's look at the ways that muscles and bones make you (and other vertebrates) move!

1. Divide your class into two or four teams and play CHARADES.
 - Your teachers will put the names of different animals in a hat.
 - A person from one team pulls an animal's name from the hat.
 - They may not make ANY NOISE or make any signals that will give the animal away!
 - They need to mime the movement of this animal to their group.
 - Three people in their group may have a turn to guess which animal they are miming. If all three get it wrong then the other team can guess what the animal is. If they cannot get it right then the "mime-artist" must reveal their animal.



KEY CONCEPTS

- A vertebrate skeleton (inside the body) has bones and joints.
- Bones are strong and form a strong frame structure.
- A skeleton protects part of the body.
- A skeleton supports the body.
- Vertebrate animals can move because they have muscles attached to the skeleton.

REVISION:

1. What type of skeleton do you have?

2. What do all vertebrate animals have that makes them vertebrates?

3. What is a major difference between the skeletons of a mouse, a crab and an earthworm?

4. Below is a diagram of the human skeleton. Label the following on the diagram of the skeleton:

- skull
- backbone
- ribs
- rib cage
- shoulder blade
- hip bone
- upper limb
- lower limb
- Think of at least two other bones in the skeleton that we did not include in this list. Label them on the skeleton.



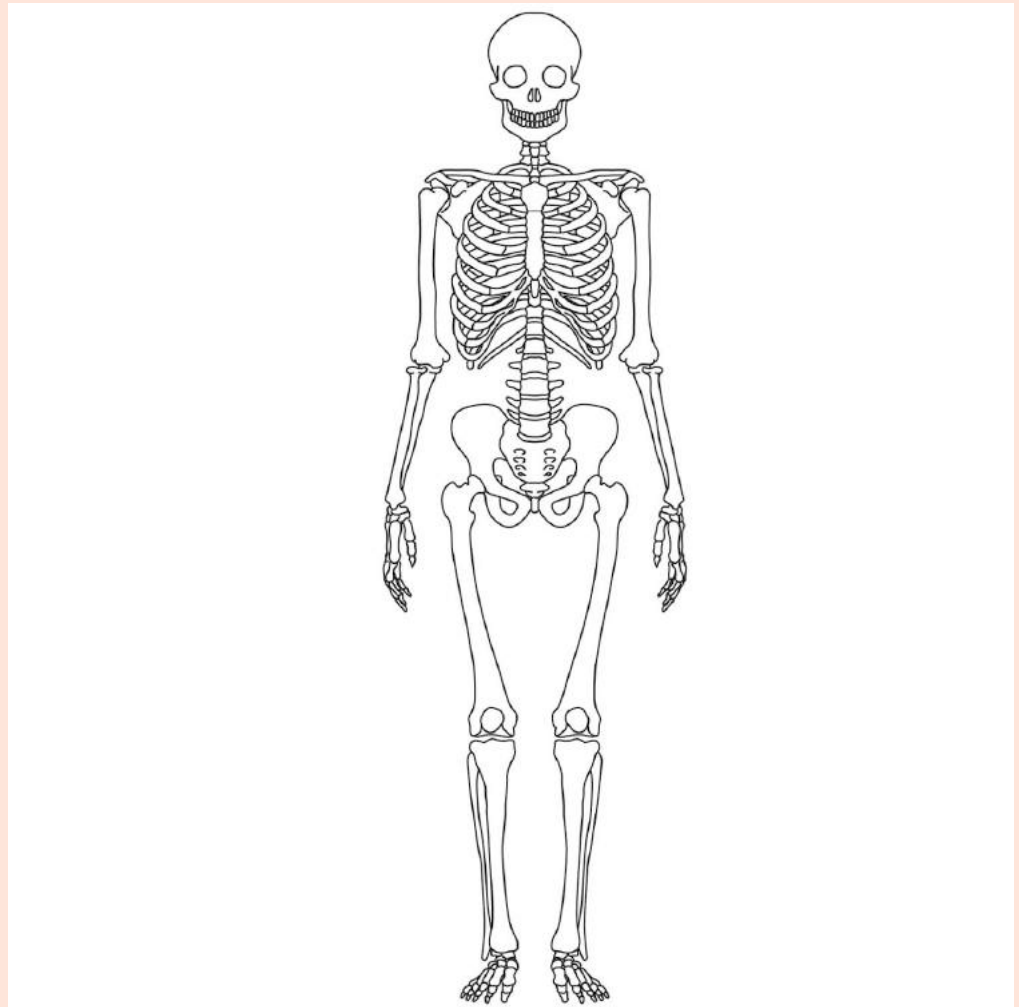

5. Joints help us to move. Look at the diagram of the human body. Add in labels to show where you can find an example of the following:
- elbow joint
 - knee joint
 - shoulder joint
6. Name the three things that all vertebrates need to be able to move.

7. What is the difference between the way a human moves, the way a dolphin moves and the way a dog moves? Describe the movement of each animal, the limbs that are used and the position of the body.



KEY QUESTIONS

- How does a skeleton or shell keep things safe inside?
- Do humans have shell or frame structures?
- How do you make a structure really strong?

In this chapter we will investigate two kinds of structures, frame and shell structures.

3.1 Structures

New Words

- frame structure
- shell structure
- support
- weight
- enclose
- resist
- load



A structure is something that is arranged or put together in a specific way and is made up of different parts. A jungle gym is an example of a structure. It has many different parts like beams, ropes, and bars, that are put together in a special way.



A jungle gym is a type of structure.^{1,2}

Most structures are designed to remain stable and rigid which means they should not break and crumble or topple and fall over if something heavy is placed on top of or against them.

Structures have different jobs or functions. They:

- support
- protect

- enclose - that means they keep something in or they keep things from getting in (like a tin of juice or a fence around a building).
- help with movement

We get three kinds of structures:

- frame structures
- shell structures
- solid structures

In all structures, the shape of the structure is very important. A structure will be able to resist or hold a certain weight depending on its shape.

In Gr. 4 in Matter and Materials, we looked at strong frame structures and also how to make structures stronger using struts and braces. In this chapter in Life and Living, we are going to focus on two kinds of structures: frame structures and shell structures. This is because they relate to the skeletons of animals.

QUESTIONS

Turn to a friend and think about the words "Shell Structure" and "Frame Structure" and think what these could mean. Then think of examples of frame structures and of shell structures that you can see in buildings or perhaps on your walk or ride to school. Report back and discuss these with your class.



Frame structures

Frame structures are easy to identify because they have a frame or a skeleton. These structures are built or put together by attaching pieces of material together to make a frame. Look at these photos of frame structures.

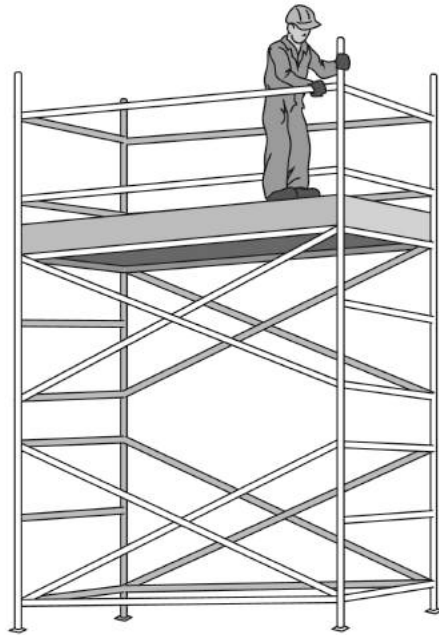

Construction workers use scaffolding. The scaffolding forms a frame.

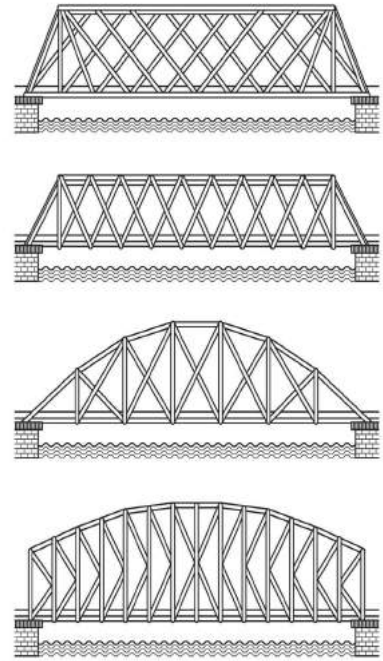

All of the triangles in these bridges make them strong frame structures.



A pylon is a frame structure that supports electricity lines.³



The veins in a leaf form a frame structure.⁴



A spider's web is a frame structure. ⁵

QUESTIONS

Turn to a friend and discuss what you think all these structures have in common - what is the same? Report back to your class.



One of the most important frame structures for all vertebrate animals is their skeleton. The material used to make this frame is bone that is attached to the muscles that move the skeleton. The skeleton supports the muscles and protects the organs.

Here is a picture of a human rib cage. Can you see how it makes a frame structure?

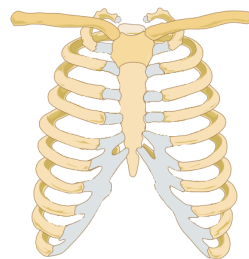

The rib cage is a frame structure.



QUESTIONS

Which organs does the rib cage protect?

In general, we can say that all vertebrates have a frame structure as a skeleton. This is because vertebrates have an endoskeleton which supports makes a frame to support the body.

Shell structures

Shell structures generally hold or protect things inside the structure. Humans make shell structures to protect and hold things, like a dish, a tin, a car or house.



A car has shell structure which protects the passengers inside. ⁶

DID YOU KNOW?

It is almost impossible to crush an eggshell if you hold it vertically between your thumb and index finger!



These guavas are contained in a basket which is a shell structure. ⁷

In nature, eggshells and the exoskeletons of invertebrates, like crab and crayfish shells, are examples of shell structures. Shell structures are made to resist a very heavy load.

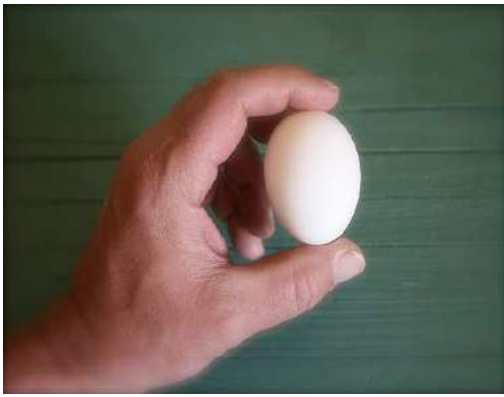

An eggshell is an example of a strong shell structure. ⁸



A crab has an exoskeleton which is a shell structure. ⁹

Strengthening Structures

Structures that protect something or hold a weight without breaking or falling, need to be really strong. Let's investigate the different ways we can use to strengthen a structure.

Do you remember in Gr. 4 Matter and Materials when we looked at whether a triangle or a square was stronger? Look at the picture to remind yourself.

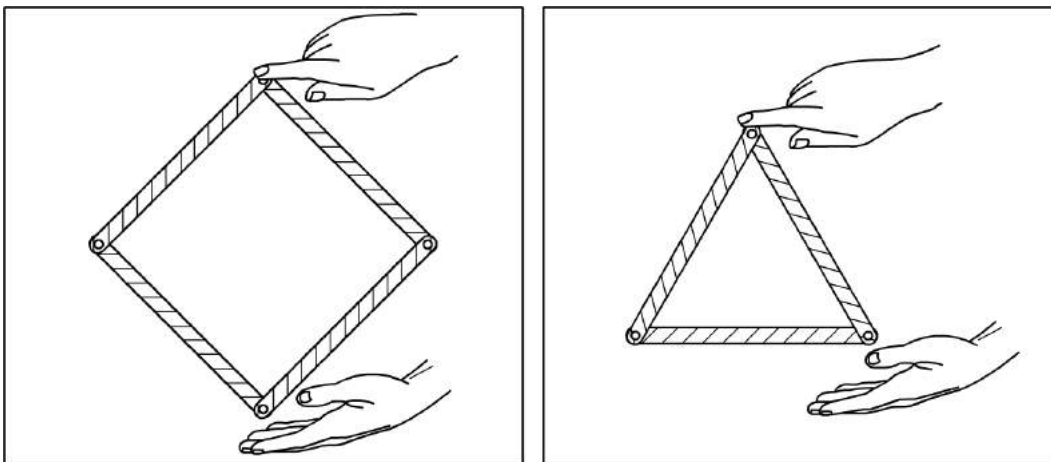

Creating a square and a triangle shape.



QUESTIONS

When you press on the shapes as in the picture, which shape is the most stable and rigid? Explain how you could make the other shape stronger and more stable.

Corners in structures are very important because it is often the weakest point of a structure. To strengthen corners you can:

- Put another support (called a brace) across a rectangle's corner to make a triangle. This makes the corner much stronger.

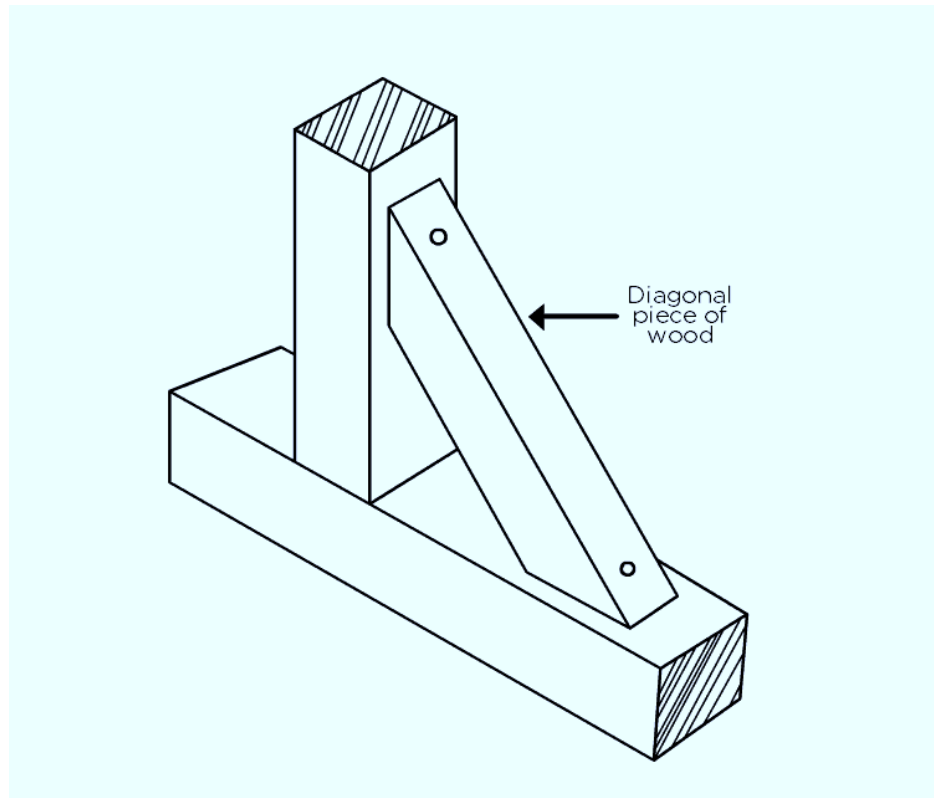

A diagonal brace on a corner where two pieces of wood meet

- Place a triangular patch over the corner. This is called a gusset.

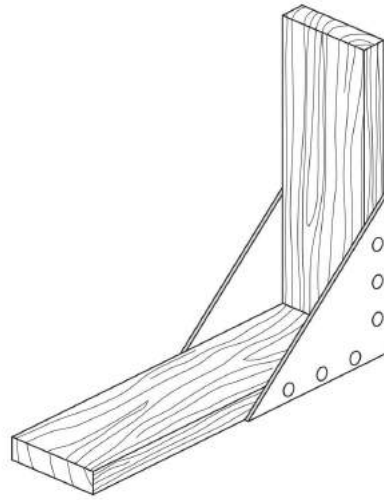

*Another way of strengthening a corner so it can't collapse, called a **gusset**.*

ACTIVITY: Making and designing a skeleton

The local museum has asked your school if they have any models of vertebrate skeletons for a display. Farrah has an idea. She loves making things and she also loves animals. So, Farrah has suggested making our own animal skeleton models. We can then better understand the idea of skeletons as structures and use these models to put on display.



Can we make our own animal skeletons?

As a project, you need to design and make a skeleton for a vertebrate. This will be a frame structure.

You may use the following materials:

- Drinking straws
- Rolled up paper for members and struts.
- Wooden dowels or sticks (30cm x 10 mm)
- Cellotape
- Metal paper fasteners

INVESTIGATE:

Let's investigate and do some research around how to build a shell or frame structure. We looked at different ways to strengthen structures using special shapes and struts. Remember this when you are investigating and designing your skeleton.

VISIT

Need ideas on how to build a skeleton from rolled-up newspaper?

goo.gl/5BhaI



DESIGN:

Now you need to use the information we found out to come up with a design for your skeleton. Your skeleton should have the following specifications:

- It must be 3-dimensional
- It must look realistic
- It must have/show the basic parts, i.e. skull, backbone, ribs
- It must be strong and rigid and so it can stand on its own

Your design has the following constraints:

- You cannot make your skeleton at home - you must make it at school.
- You are confined to using some of the following tools and materials: waste paper (A4 and A3), card, brass paper fasteners, glue, scissors, sositie sticks and nails (to make holes).

Once you have thought about these specifications, you need to answer these questions:

1. What do you need to design?
-

2. What will the size and shape of your skeleton be? Remember that your skeleton must stand up straight for at least 3 minutes.

3. What materials are you going to use to build your skeleton. Make a list of all the materials you will need.

4. What tools are you going to need to make your skeleton?

5. Are there any other specifications and constraints that you can think of for your skeleton?

Now you need to draw some designs for your skeleton. Use scrap pieces of paper to do your first designs. Once you are happy with your design, use the space below to draw your final design. Label your drawing showing what materials you are going to use for the different parts.



MAKE:

Now comes the fun part! You have to make your skeleton according to your sketch and using the materials you identified. Do this in class.

Once you have all finished making your skeletons, you need to show your classmates what you made and tell you what you did to make your skeleton. This is called presenting your design.

DID YOU KNOW?

When making your skeleton, you may come up with a better design! So, leave some space for a second drawing at the bottom.



EVALUATE:

Answer the following questions about your skeleton.

1. Did your skeleton stand up for 3 minutes without your support?

2. What could you change in your skeleton to make it work better?

3. Did your skeleton fulfill all the requirements in the specifications given to you?

4. If you ever had to build this skeleton again, what would you do differently?

COMMUNICATE:

An important part of the Design Process is to communicate what you found to others so they can learn from what you did.

Write a paragraph below where you tell Farrah about the skeleton that you built, what worked and what did not work, so that she can also learn from what you did and also build a model skeleton to put on display at the museum.



KEY CONCEPTS

- Structures can be shaped as a shell or frame.
- Structures have specific functions - to protect, support, enclose or help to move.
- Shell and frame structures in nature.
- Structures can be strengthened.
- Struts can strengthen structures.





REVISION:

1. Complete the following table by stating whether the structures are frame or shell structures.

Structure	Shell or frame structure?
Jungle gym	
Eggshell	
Dog skeleton	
A cellphone tower	
A crab skeleton	
Scaffolding	
A car	
A basket holding fruit	

2. How would you strengthen a square shape? Give two different ways.

3. Give two examples of animals with skeletons that are frame structures. What is the name given to this type of skeleton?

4. Give two examples of animals with skeletons that are shell structures. What is the name given to this type of skeleton?

5. What are the advantages to humans for having a frame structure as a skeleton? Explain your answer.



KEY QUESTIONS

- Why do I get hungry?
- Do plants get hungry?
- What are food chains?
- What would happen if all the plants on the planet died?
- Why does a predator have to hunt and kill - can't it just eat grass?

New Words

- photosynthesis
- carbon dioxide gas
- oxygen gas
- producer
- consumer
- herbivore
- carnivore
- omnivore
- scavenger
- decomposer



4.1 Food and feeding in plants and animals

Let's read the following story together.

Who is the most important?

Some animals stood on the soft green grass around the waterhole one day, admiring the fine job that the maker had done!

The tortoise, slowly and carefully said: "Of all creation I think I like the flamingos the best! Their beautiful pink and white feathers, their graceful necks and long legs - they're just amazing! They are so beautiful maybe they're the most important."

Warthog just *harrumphed* and rolled in the squishy brown mud munching on some roots.

"Those flamingos are far too delicate!" said the springbok "Look at that strong, fearsome buffalo - no one ever messes with him! His horns are so sharp he can pierce a rock! I think he is the most important in all creation!"

Warthog just *harrumphed* and sat on the cool green grass taking a huge tasty mouthful.

The baboon jumped from his perch in a nearby tree "Hahaha-ing" and "KwahKwahKwah-ing" as he went. "You are all so wrong! Look at the eagle - she soars over everyone and can see everything. She is always safe high in the cliffs and never has to come to this messy old waterhole. She doesn't need us - she is the most important of everyone!"

Warthog just *harrumphed* and scratched his back against the rough hard bark of a baobab.

The dungbeetle clambered on top of his ball, rested his head on his hand and said: "You have no idea - the ants, now they're an important bunch! Without those little fellows the entire world would be covered in dead stuff! The smell would be un-be-lie-va-ble! They are the most important by far!"

Warthog *harrumphed*, really loudly this time. "Without plants we'd all be gone!" and with that he shoved a clump of reeds and munched at the little insects escaping.

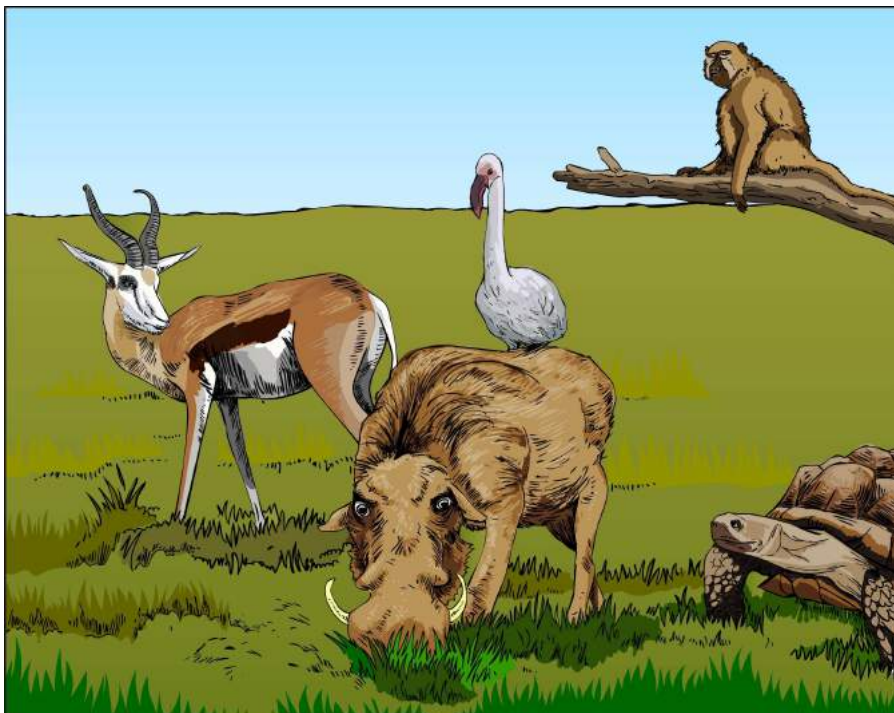

Do you think plants get hungry? If they do not have mouths, how do they eat?

PLants do not EAT in the same way humans do. They make their own food inside their little "factories". They do this through a process called photosynthesis:

- They absorb water and nutrients through their roots.
- The water travels to the leaf or stem where the plants make the food
- The plants also carbon dioxide (a gas) from the air.
- They also use energy from the sun (which they get from the sunlight) for this process
- The plants use the water and carbon dioxide gas with the sunlight energy to make food in the form of sugars.

VISIT
Plants make their own
food (video)
goo.gl/OzLs5



- Oxygen (a gas) is given off as a by-product of this process.
- The plant can then use the food (sugars) that it produced to carry out its own life processes.
- Plants generally make much more food than they need to live. They store the extra food that they make in different parts of the plant.
- Animals then eat these parts of the plant (or the whole plant).

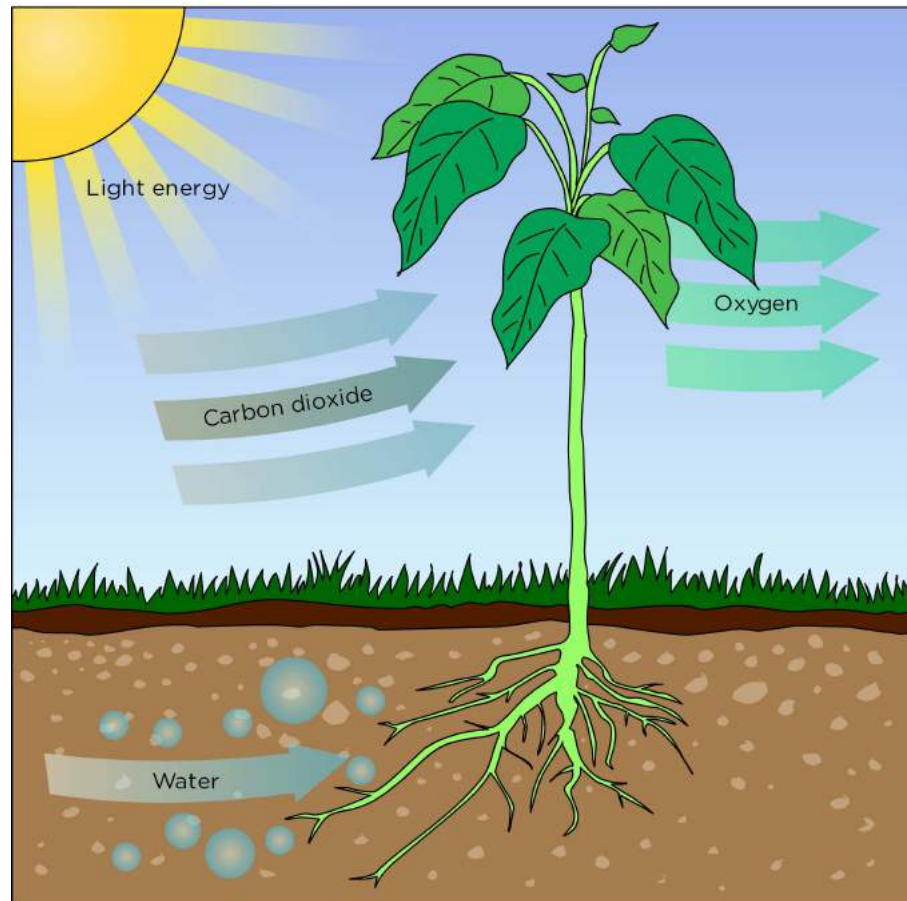

Plants make their own food through the process of photosynthesis.



QUESTIONS

Why do animals need the food that plants make? Discuss this with a friend and report back to the class.

Now we know that the warthog was right: "Without plants we would all be gone!" We would not have food to eat and we would not have oxygen to breathe.

QUESTIONS

What would you be prepared to pay for a day's worth of oxygen? Plants make this all for free for us!



The sun is a source of energy for all living things on earth. ¹

At the beginning of this term you learnt that animals and plants are interdependent - that means they depend on each other to survive. All living plants and animals need food to give them energy in order to survive.

Plants make their own food through photosynthesis. Living things that can make their own food are called producers because they produce their own food.



QUESTIONS

Turn to a friend. Take turns to explain what "ingredients" a plant uses during the process of photosynthesis and what the plants make or produce from this. Write your answer below.

Animals can't use sunlight, water and carbon dioxide to make food like plants do. Animals need to eat plants (or other animals) for energy to carry out their life processes. Living things that get their energy by eating either a plant or an animals are called consumers.

- Many animals get their energy from eating plants. We call these animals herbivores.
- Some animals eat other animals to get energy. We call these animals carnivores.
- Other animals can eat plants and animals, like baboons or people. We call these animals omnivores.
- We get special animals called scavengers and decomposers. They eat dead animals and break their bodies into tiny tiny pieces that can go into the soil as compost. These pieces must be small enough for plants to absorb.



A cow is a herbivore.²



A baboon is an omnivore.³



Lions are carnivores. ⁴⁵

ACTIVITY: Identifying herbivores, omnivores, carnivores, scavengers and decomposers

MATERIALS:

- Books and reading material on all sorts of animals displayed in class.
- Do research in your local library or on the Internet and bring information on one of the animals in the picture below to class.

INSTRUCTIONS:

1. Identify the different animals in the picture below. Sit with a friend in class and see if you can name as many of the animals as possible.
2. Identify what the animals eat.
3. Classify the animals as a herbivore, omnivore, carnivore, scavenger or decomposer.
4. Select three of each and record them in the table below.





Name of animal	Food that it eats
3 carnivores are:	
3 herbivores are:	
3 omnivores are:	
3 scavengers are:	
3 decomposers are:	

4.2 Food chains



QUESTIONS

Where do lions or sharks get their energy from? They do not eat plants.

New Words

- food chain
- energy flow
- ecosystem



There is a feeding relationship between producers and consumers. We call this relationship a food chain.

- Plants are the producers.
- Animals are the consumers.

A food chain describes how each living thing gets food and **how energy is passed from one organism to the next.**

- When we draw a food chain we use an arrow (\rightarrow) between organisms to show that one eats the other and that energy is transferred from the one organism to the next.
- A simple food chain is: grass \rightarrow cow \rightarrow human \rightarrow worms.
- Many food chains that are interdependent and linked are called a food web.

VISIT

The Food Chain song
goo.gl/ZMv1B

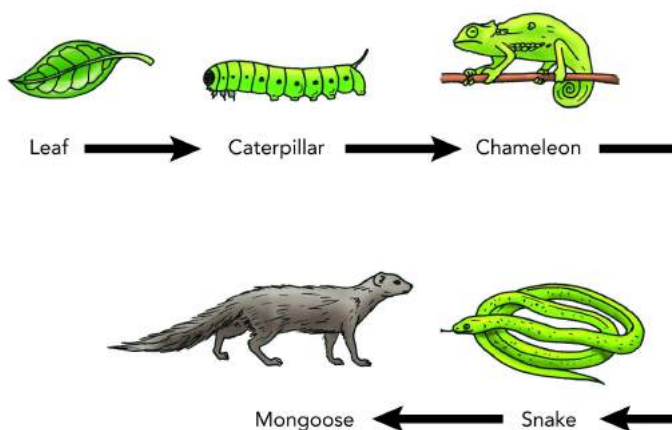

A simple food chain. Can you name the herbivores, omnivores, carnivores and decomposers?

ACTIVITY: Making food chains



MATERIALS:

- Your teacher will make a big yellow sun and pin it to the centre of your class' ceiling.
- 3 different coloured pieces of paper or thin cardboard (Green for plants and two other colours, NOT yellow as the sun is already yellow).
- Stapler and staples or cellotape or pins. If you have to use glue, hold the ends together with washing pegs until the glue has dried.
- Scrap paper, colouring pencils and/or kokis or cut out pictures of animals and insects
- Scissors
- Glue
- Thumbtacks and/or Prestik

INSTRUCTIONS:

1. Cut the paper into long strips, 3 cm wide.
2. Use the colours as follows:
 - a) GREEN strips for the producers - the plants.
 - b) One colour for the consumers - the animals eating the plants. (You could even have two colours here - one for herbivores and one for carnivores/omnivores)
3. Design your own food chain in the space below. Remember to start with the producers then add in consumers. To show the flow of energy you must use an arrow (\rightarrow).

4. Collect cut out pictures of the animals in your food chain or draw your own pictures on scrap paper and cut these out carefully.
5. Put your chain together as follows:
 - Start with the green strip for the plants - staple the two ends together to form a link on a chain. Stick your picture of the plant in your food chain on here.

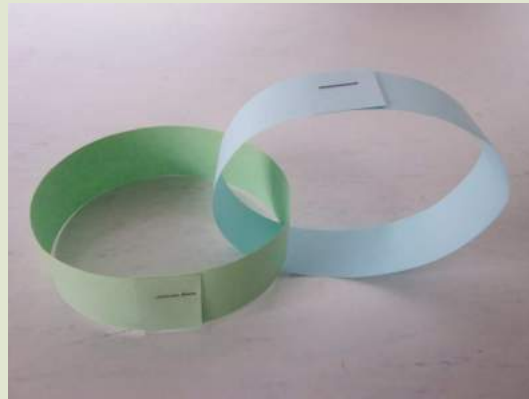

Two links in the chain so far - a green plant and the first consumer (a herbivore).

- Use the same amount of "consumer coloured" strips as the amount of consumers in your food chain. Stick the pictures of your consumers in order onto these strips.



A longer chain - remember your chain will have pictures of the plants and animals on each link!

Pin your food chain to the ceiling. It should look like a large spider's web when everyone's chains are up.

Use string / wool to show this interdependency and lead learners to conclude that food webs show the way that food chains are linked.

The organisms that make up a food chain cannot be in any random order. They have to be in the specific order in which the energy is transferred between them in an ecosystem. Let's have a look at re-ordering food chains which are broken.

ACTIVITY: Sequencing plants and animals in food chains.

INSTRUCTIONS:

1. The following lists of animals and plants are in the wrong order.
2. You must sequence them so that they make up a proper food chain in which the energy is transferred from one organism to the next.
3. Make sure to draw an arrow from one organism to the next to show the direction.
4. You can even draw some pictures of the animals if you want to.



grasshopper, hawk, snake, grass

shrimp, seal, fish, algae

bee, flower, butcher bird, spider.



mouse, jackal, leopard, grass.

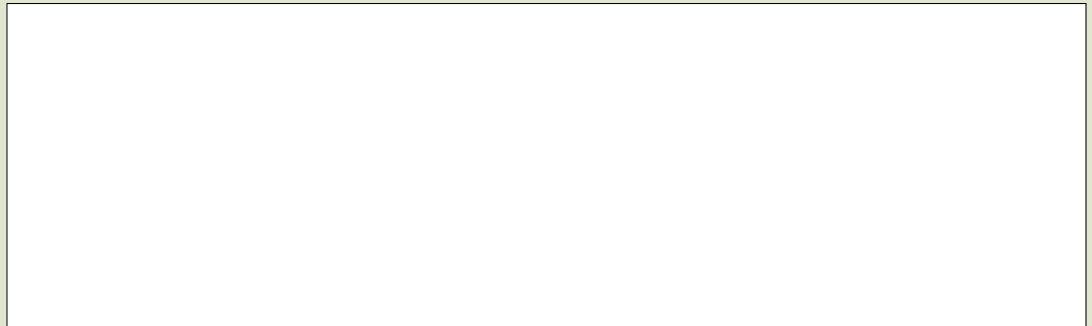

Are humans also part of a food chain?

Most humans are omnivores and like to eat plant and animal products.



QUESTIONS

What do you call a human herbivore?

Let's look where humans fit into food chains.

ACTIVITY: Discovering your place in different food chains

MATERIALS:

- A list of all you ate and drank from when you woke up yesterday morning to when you went to sleep last night.

INSTRUCTIONS:

1. Order everything you ate and drank in a day into the following categories



Plants I ate were:	
I drank the juice of plants when I drank:	
I ate animal products when I ate:	
I drank animal products when I drank:	
I ate a combination of animal and plant products when I ate:	

QUESTIONS:

1. Now design a food chain of some of the plant and animal food products that you ate.

2. Why do you think people say that human beings are "at the top of the food chain"?



Wow, I feel really humbled by our place in the food chain. Although we are "at the top" it also means we have a lot of responsibility to be conscious of what we eat.

ACTIVITY: Write a Food Chain poem

MATERIALS:

- The habitat and animal books on display in your class.
- Scrap paper for planning and drafting.

INSTRUCTIONS:

1. Write a food chain poem.
2. The heading of your poem must describe or label the type of habitat in which the food chain is located.
3. The body must explain the flow of energy in the food chain.
4. The ending must repeat the heading and your name.
5. Use a thesaurus to get ideas for different verbs instead of only using "EAT"..



Here is an example of a food chain poem written by Farrah:

The Savannah

These are the lion cubs
that were fed by the graceful lioness
that caught the zebra
that munched the grass
that grows on the savannah where Tumi Nxoko lives!



KEY CONCEPTS

- Green plants make their own food to build their branches and stems.
- Green plants use water, carbon dioxide and sunlight energy to make food.
- Plants are called producers.
- Animals need food to grow and carry out the life processes.
- Animals cannot make their own food and have to eat plants or other animals for food. Animals are called consumers.
- Food chains describe the feeding relationships between plants and animals.
- Energy is transferred from the sun to green plants and then to the animals in the food chain.

REVISION:

Read the information and look at the pictures below. Then answer the questions that follow.



The rodent is not in his shelter
The bird of prey sees the rodent, dives from above and catches the rodent. The bird of prey is at the top of the food chain.



The rodent eats the beetle
- energy passes from the lettuce through the snail and then the beetle to the rodent.



Lettuce grows by extracting water from the soil, as well as energy from the sun that shines on the leaves where nutritious matter is manufactured. It helps the plant to grow.

If one of these are removed from the food chain permanently, the food chain is broken, and the others in the food chain are affected.

The snail eats a lettuce leaf to survive.

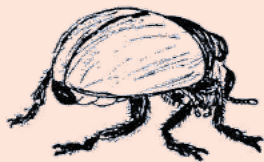

The beetle devours the snail, and then has enough energy to hunt for the next snail.

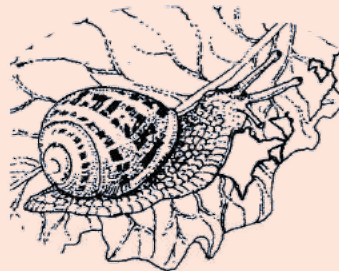

1. Write a five link food chain using the information and pictures above.

2. Which organisms are herbivores?

3. Which organisms are carnivores?

4. The energy flow in this food chain started with a main source of energy. What source of energy provided this source of energy?

5. Explain the interdependence in this food chain?

6. What would happen if the eagle was removed from this food chain?

7. The eagle grew old and died. Explain how the eagle's body was broken down and became part of the soil. Give examples of animals that helped this process.

-
-
8. Look at the following picture of a food chain. Name the producer, the herbivore and the carnivores.

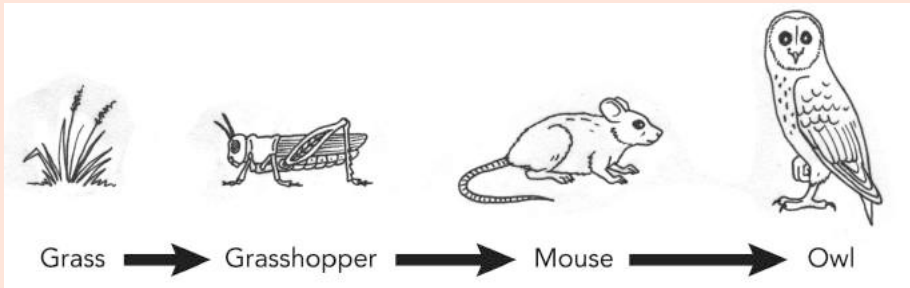

-
-
9. The mouse also eats other plants, such as seeds and nuts. So the mouse is not only a carnivore. What is it?
-



KEY QUESTIONS

- Why do chickens lay eggs but dogs do not?
- When we were at the pond, I found some frogspawn. Why are the frog eggs soft but the chicken eggs are hard? I thought eggs had hard shells that can crack and break?
- Our puppies looked similar to the mother dog but the tadpoles I found in the pond did not look like frogs at all. I wonder why?
- Our puppies are a year old now and look very similar to the adult dogs - will they still change a lot? When will I know that they are adult dogs?

This term, we studied many of the different plants and animals on Earth and their interdependence in different habitats. In this section we are going to finish our study of plants and animals, and look specifically at their life cycles.

New Words

- generation
- reproduction
- gestation
- growth
- maturation
- reproduction



5.1 Growth and development

Plants and animals grow and develop throughout their lives

All plants and animals need to make new plants or they will become extinct (no longer exist on Earth). The adult plant or animal needs to reproduce offspring that will grow over time into a new adult that will reproduce offspring of its own. We call this a life cycle. It is a cycle because when a new plant or animal is made the cycle begins again.

A plant or animal can die anywhere in its life cycle - at birth, as a young or old plant or animal. Let's take a closer look at the life cycle of flowering plants.

QUESTIONS

When will you stop growing? Discuss this with a friend and then share your ideas with the class.



5.2 Plant life cycles

In flowering plants, the life cycle begins when a seed germinates. Look at the diagram showing the seed after it has germinated.

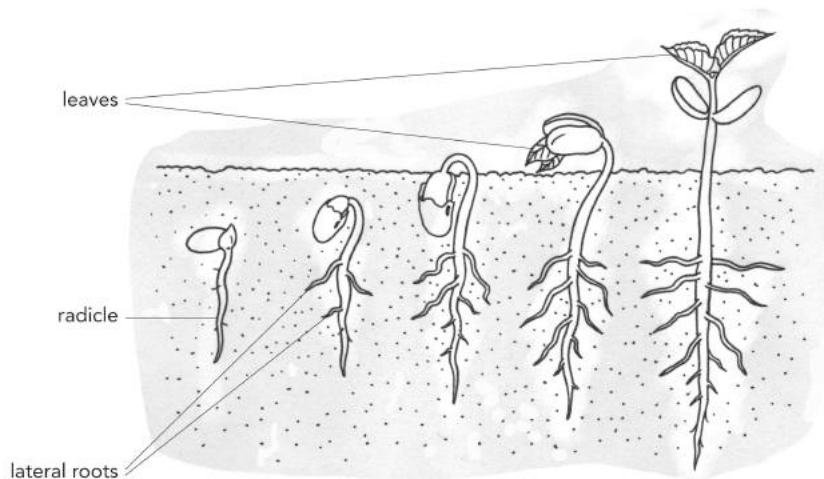

The stages of plant germination and growth.

The seed germinates when a small root (radicle) and stem start to grow out of the seed. This grows into a young plant.

New Words

- germinate
- seedling
- pollination
- disperse
- fertilisation



VISIT

Growth of a seed
(video)

goo.gl/qj4M4



A very young plant just after it has germinated and begun to grow.¹

The germinates, grows and develops into a seedling. In time the seedling grows and matures into a young adult plant that is bigger. The young adult plant continues to grow until it becomes a mature adult plant. The adult plant can reproduce using flowers that produce seeds. The plant reaches maturity when it makes flowers.



QUESTIONS

Look at the three different pictures below. What do you think the insects in these pictures are doing?



A fly. ²



A bee. ³



A butterfly. ⁴



VISIT

A video on pollination
goo.gl/GWtMi



The flowers produce pollen. Insects carry the pollen from one flower to the next. This is called pollination.

- The pollen fertilises the ovules in the flower.
- The fertilised ovules now develop into seeds.
- The seeds are then dispersed and start to grow in a new place.
- Seeds can be dispersed in different ways.

When a seed lands in soil it can start to germinate. The cycle begins again.

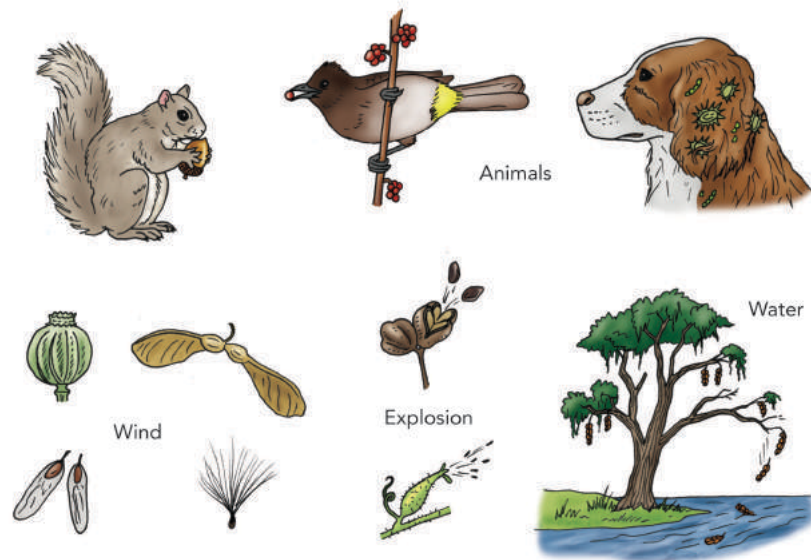

Different methods for seed dispersal.



QUESTIONS

1. Why does a plant need to disperse its seeds?

2. Look at the pictures showing ways in which seeds are dispersed. Discuss these four ways and explain how you think the seeds are adapted in each method to be the most efficient.

VISIT

Video on seed dispersal
[goo.gl/YOoQ0](https://www.youtube.com/watch?v=YOoQ0)



ACTIVITY: The life cycle of a tomato plant

MATERIALS:

- Tomato plants in your classroom or in the garden
- The seeds of these tomato plants
- Some ripe tomatoes similar to the ones growing in your class.
- Picture below of the life cycle of tomato plants

INSTRUCTIONS:

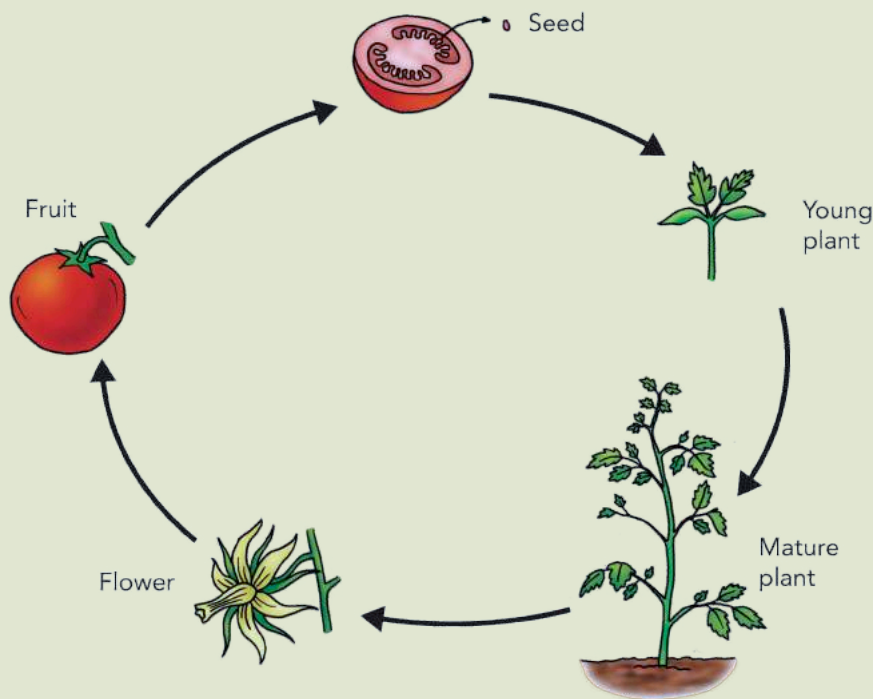

The life cycle of a tomato plant.

1. Study the life cycle of a tomato plant. List the developmental stages of a tomato plant starting at the seeds - you can use the illustration above to help you.

2. Carefully study the tomato fruit that is on display in your class. Do you see where the little stem is connected? Can you see any leaves around it?
3. Draw the tomato fruit in the space below. Remember to make a scientific drawing using the correct way of labelling that you learnt in Gr. 4.



4. Carefully examine the tomato seeds from the seed packet. Your teacher will cut open the tomato fruit. Compare the seeds from the fresh fruit with those from the seed packet. Write this comparison in the space below.

The fresh tomato seeds looked:	
The seeds from the seed packet looked:	

5. Look at the tomato plant in your class. Find the following plant structures on the plant and describe each of these in the space next to it. Then make a sketch in the space provided of each plant structure:

	Describe the plant structure	Sketch the plant structure.
Stem		
Leaves		
Flowers		

5.3 Animal life cycles

All animals need to reproduce or they will become extinct. In this section we will learn more about the life cycles of animals.



ACTIVITY: Life cycle of a frog

MATERIALS:

- a glass aquarium, a large glass or plastic container, or a 5 litre ice-cream tub
- chlorine free water
- water plants (if available)
- some large rocks that will stick out the surface of the water
- fish flakes

INSTRUCTIONS:

1. Prepare the habitat for the tadpoles using the materials above.
2. Collect a few tadpoles from a local stream in a sealable container and bring them to school.
3. Carefully place the tadpoles in the water habitat you prepared for them.
4. Change the water at least every second day.
5. Feed the tadpoles with fish flakes.
6. As a class, keep a diary of the tadpoles' growth and development over the next few weeks on large pieces of paper or something similar.

VISIT

A very young plant just after it has germinated and begun to grow⁵
goo.gl/qj4M4



Date	Description of your observations	Sketch of your observations

Stages in an animal life cycle

Most animals like fish, reptiles, birds and mammals have a simple life cycle. We can identify different stages in such a simple life cycle:

- Gestation - before birth
- Growth and development
- Maturation
- Reproduction

The gestation stage in an animal's life is the time before the embryo (young animal) is born. Animals produce young in different ways:

- **Born alive:** some animals grow inside the womb of the mother animal and are then born alive.
- **Hatched from eggs:** the mother animal lays eggs and the embryo develops inside the egg before it hatches.
- **Hatched from eggs inside the mother animal's body and are then born alive:** the embryo develops within an egg inside the mother animal's body. The eggs can hatch just before or just after birth.

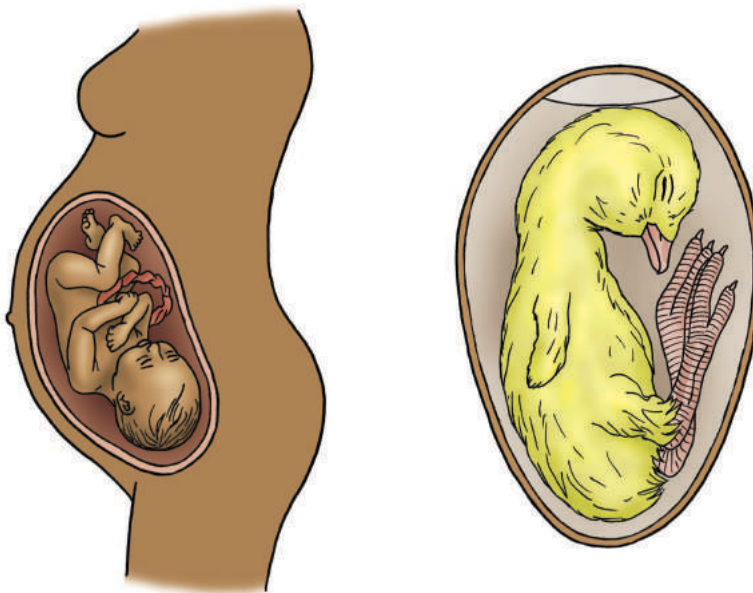

Gestation - in a human the baby grows in the mother's womb and is then born. In a chicken, the mother lays an egg and the embryo develops in the egg before hatching.

New Words

- embryo
- gestation
- pregnancy



VISIT

Frog life cycle (video)
goo.gl/zUiJP



After the animal is born or hatched, they grow and change.

Some animals undergo a simple change. Puppies, for example, look similar to adult dogs.







In dogs, the puppy looks similar to the adult dog.

VISIT

Videos on metamorphosis ([goo.gl/uYjt4](https://www.youtube.com/watch?v=uYjt4)) and the life cycle of a monarch butterfly ([goo.gl/5SVbi](https://www.youtube.com/watch?v=5SVbi))



Other animals (mostly amphibians and insects) look very different to the adult animal when they hatch. They go through very big changes in their life cycles. This change is called a metamorphosis. Look at the stages of metamorphosis of a monarch butterfly below.

A Monarch caterpillar eats and grows.	The caterpillar gets ready to make a pupa.	Inside the pupa the caterpillar is changing into a butterfly.	The adult butterfly emerges from the pupa.
			

ACTIVITY: Observing fruit flies reproduce

MATERIALS:

- clear plastic bottle
- sharp knife
- ripe fruit

INSTRUCTIONS:

1. Cut the top part off a clear plastic bottle.
2. Put ripe fruit in the bottle. (Be careful - if the fruit is too watery, the flies will die.)
3. Put the top upside down in the bottle as if this is a funnel. look at the picture below

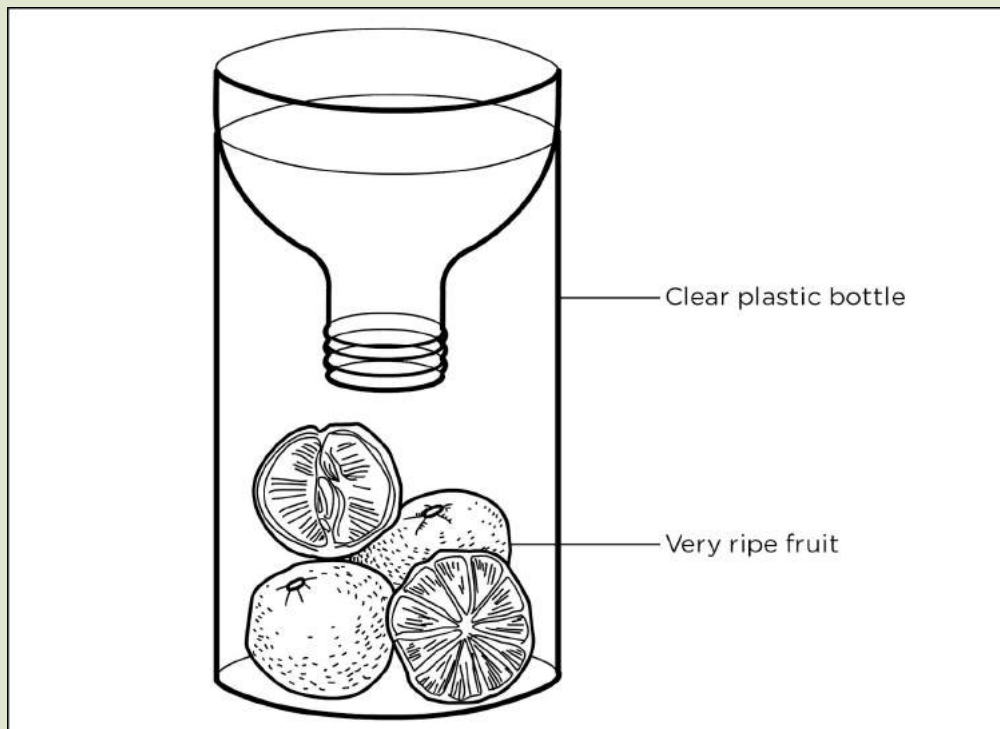

Setup for this activity.

4. Keep a diary of all that you see happening inside the bottle over the next 2 - 3 weeks. Provide a short description and a neat sketch (not a scientific drawing). Keep your daily diary in the space provided below:

Date	Description of your observations	Sketch of your observations

After keeping the fruit fly diary, carefully study the following diagram of the fruit fly's life cycle. Write a sentence or two explaining what is happening at each stage of the fruit fly's life cycle.

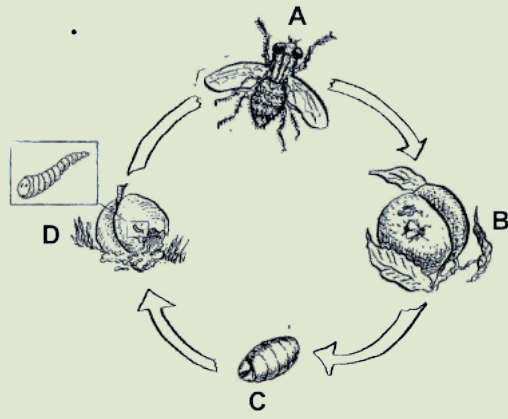

The fruit fly life cycle.

	Label the stage:	Describe the stage:
A		
B		
C		
D		

Once a young animal matures into an adult, it is ready to produce its own offspring. Mature females produce egg cells and mature males produce sperm cells. When they mate, the male sperm cells fertilise the female egg cells. This produces an embryo and the life cycle begins all over again.

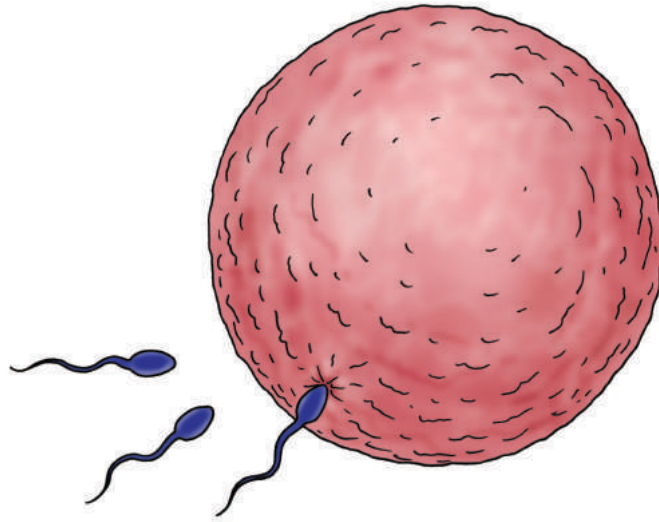

Fertilisation is when a male sperm cell enters the female egg cell.

An animal can die at any stage in its life cycle. Various things can cause death to the animal.



QUESTIONS

In your group, discuss a number of possible causes of death of animals and write them below.

ACTIVITY: The Frog Life Cycle

INSTRUCTIONS:

1. Hopefully you were able to see some tadpoles develop into frogs.
2. Let's revise the stages of a frog's life cycle.
3. Look at the life cycle of the frog in the illustration below.
4. Describe the various stages in the life cycle of this frog in the table below.

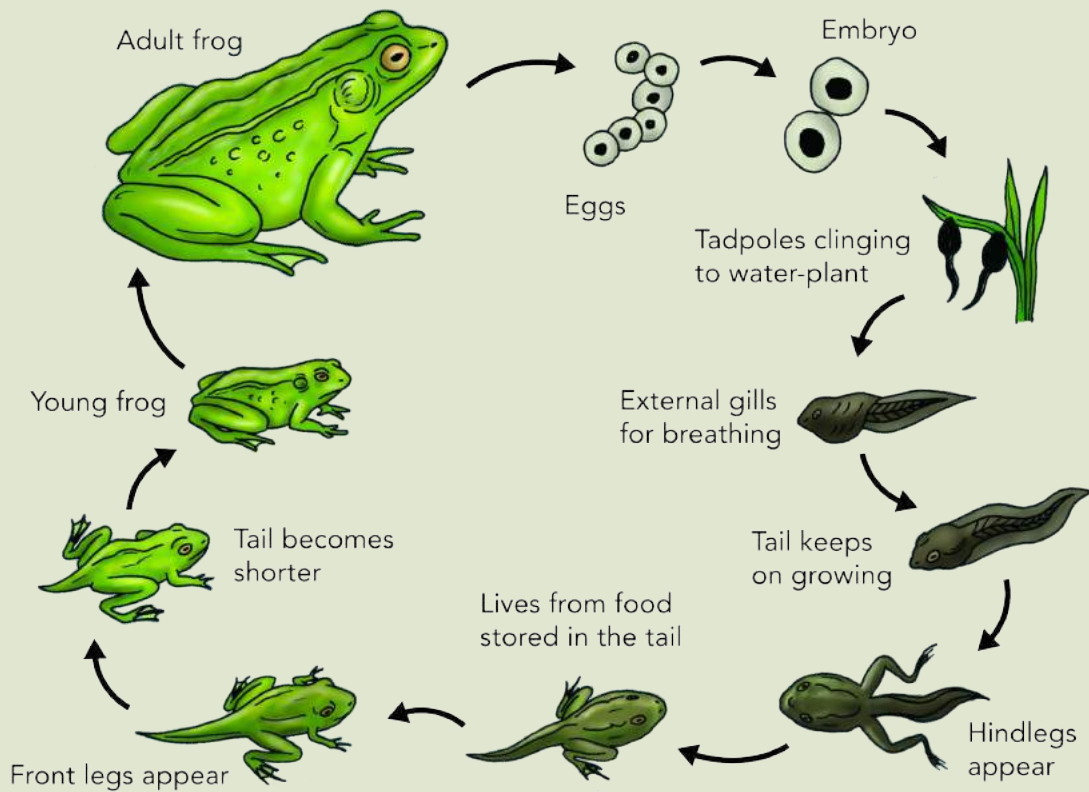

The frog life cycle.

	Description of this stage:
Gestation stage	
Larva stage	
Young adult stage	
Adult stage	



KEY CONCEPTS

- All living things carry out the life process of growth and development. This is part of their life cycle.
- A life cycle describes the stages and processes that take place as a plant or animals grows and develops.
- A life cycle also describes how one generation of a plant or animal reproduces to make new plants or animals that will make many more generations.
- Death can occur at any stage in the life cycle.





REVISION:

1. Explain what it means when we say that a plant or animal has a life cycle.

2. Explain the 4 stages in the life cycle of a flowering plant - think for example of a tomato or bean plant.

3. Plants use their brightly coloured petals and their scent to attract animals. Why do they need to attract animals?

4. Plants pollinated by the wind are much less attractive than plants that have to attract birds and insects. Why do you think this is?

5. When plants disperse their seeds by means of water, what important features do these seeds need to have?

6. Why do animals and plants reproduce?

7. Use the following words in the to complete these sentences.
Write the sentences out in full:

- egg-laying
 - umbilical cord
 - born alive
 - external
 - life cycle
- A _____ describes how reproduction takes place and shows the way in which a plant or animal changes as it grows.

- A chicken and snake embryo has an _____ type of gestation.

- A puppy or kitten are _____ from the wombs of the female animal.

- While in the womb the embryo of a cow or horse receives nourishment through the _____ that is attached to the mother's body.

8. Order the pictures below into the correct order that it takes place in. Write numbers 1 - 4 in the order that the pictures should be.

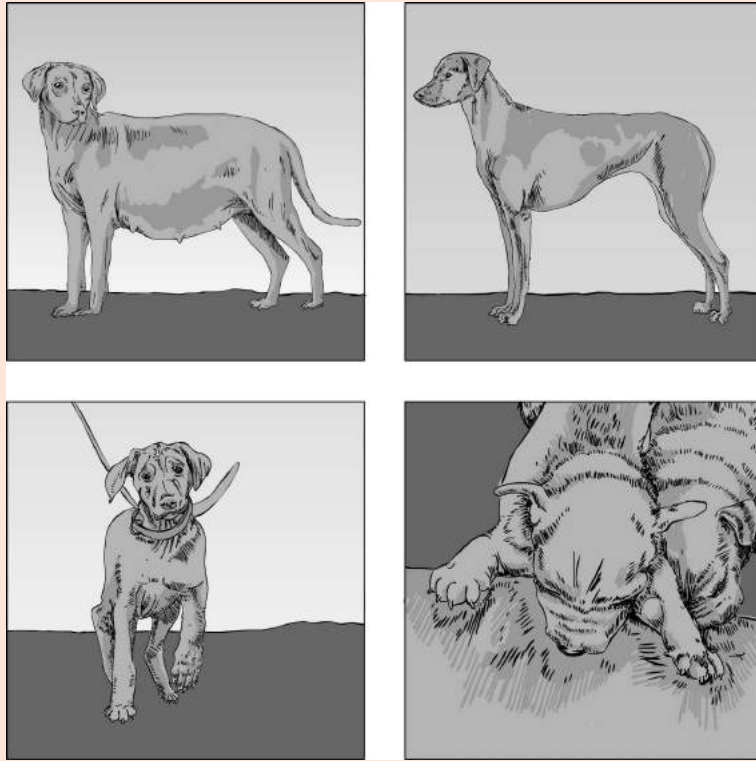

The life cycle of a dog

9. Describe the different stages in the life cycle of a cat and the processes that take place in the space below. You may use illustrations to enhance your work but these will not be assessed.

10. When does an animal die?

11. Why do you think certain plant species declined in areas where specific animals have been poached, like chimpanzees, orangutans or hornbills, parrots and other exotic birds?

12. What possible dangers do crop sprays, pesticides and pollution hold for plants and animals?





Matter and Materials and Structures

1 Metals and non-metals



KEY QUESTIONS

- How can we tell if something is made of a metal or a non-metal?
- How do we decide what material to use when we want to make or build something?

In this chapter we will learn about metals and non-metals. Do you remember learning about materials in Grade 4. Metals and non-metals are two different classes of materials. Each class has its own unique properties. *Properties* are the things that are special or unique about an object or a material. We can use the properties of a material to describe what it is like. For example, we could say that a property of a gas is that it can be compressed.

When we want to make a new product (a building or a tool or any kind of object) we first have to decide what the purpose of that product will be. Perhaps we want to make a tool for digging in the garden, or a kennel (dog house) for our new puppy. The purpose of the product will help us decide which would be the best material with which to make the object.

What would be the best material for a digging tool? Surely we would need a tool that is strong and durable; with a sharp edge that will allow us to cut through the soil when we dig into it.



QUESTIONS

1. What material would allow us to make a dog house that is cool in summer and warm in winter?

2. What material would you choose to make a spade for digging in the garden?

The next activity is about the things we think about when we choose materials for a specific purpose. In this case the purpose is building a house.

ACTIVITY: Choosing a material to build a house

INSTRUCTIONS:

1. When we choose a material for a certain purpose, we look for a material with the right properties for the job. Look at the two pictures of houses below.
2. Can you see that house A and house B are made of different materials?
3. Answer the questions that follow.

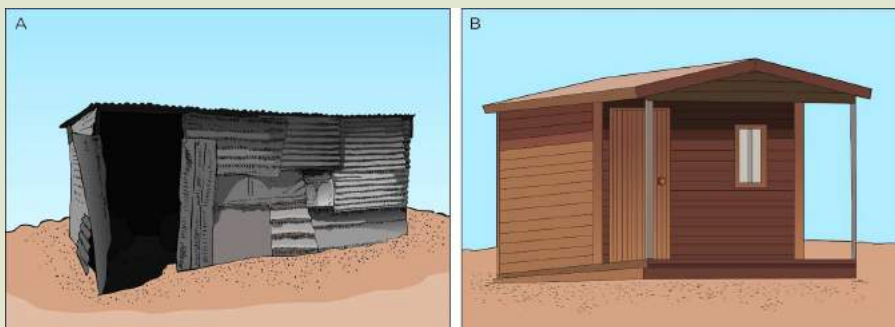

QUESTIONS:

1. What material was used to build house A?

2. What material was used to build house B?

3. If you had to build a house next to the ocean, which one would you choose, house A or house B?

4. Write down a reason why you would build this house next to the ocean rather than the other one.

5. Write down at least three other materials that could be used for building a house.

Now that we have looked at the different types of materials that you could use to build a house and seen that there are different cases when you would use one material or another, let's look at the actual properties of metals and non-metals.

New Words

- property
- metal
- lustre/lustrous
- dense
- malleable
- ductile



1.1 Properties of metals



So how can we tell if something is made of metal?

Good question Tom! Let's look at the properties of metals. A property is a word used to describe a material or object and tells us something about it.

- Metals are usually shiny. The shine that we see when light reflects off the surface of a metal is called the lustre of the metal.
- Most metals are hard and they feel heavy.
- We say metals are dense as their particles are packed close together.
- Metals conduct electricity and heat well. (You will learn more about electricity next term. In Grade 6, you will learn about metals as conductors of electricity.)
- Metals are malleable (they can be shaped into flat sheets) and they are ductile (this means they can be made into thin wire)
- Most metals can be heated to high temperatures without melting or changing their shape, which is one of the reasons why pots and pans are made of metal. Can you think of any other reasons why pots and pans are made of metal?
- Metals are mined from the Earth. You will learn more about this in another subject, Social Sciences.



Aaah! All these new words about metals! I still do not really know what they all mean!

Do not worry Tom! These are new, big words, but here is an activity in which we can investigate some of the properties of metals. We will use our skills of observation (looking, listening and touching) during the investigation.



INVESTIGATION: What are the properties of metals?

Tom identified a problem and a question - he wants to experience the properties of metals. In a science investigation we want to answer a question or find something out.

What would you like to find out in this investigation? (We call this the aim of the investigation.)

MATERIALS:

- coins
- metal spoon
- metal pencil sharpener
- metal nail or screw
- paper clip or thumb tack
- pin
- steel wool
- metal bottle top

METHOD:

1. A few metal objects have been placed in front of you. Notice all the different shapes. Write the name of each object in the table below.
2. Hold each object in your hand. Does it feel hot or cold? Rough or smooth?
3. Look at each object carefully. Is it shiny or dull? Can you describe its colour?
4. Drop each object on the floor, or tap it. What sound does it make?
5. Write your observations in the table below (you may use words from the box below or you may use your own words).

shiny, dull, rough, hard, smooth, makes a ringing sound, cold, warm, heavy, rigid, sharp, flexible, soft, light
--

OBSERVATIONS:

Name of the object	How the object feels when I touch it	What the object looks like	The sound that is made when the object is tapped or dropped

CONCLUSION:

What have you learned from investigating the properties of metals?

Remember when we looked at the two different houses made from tin and wood? Metals are used to make objects because of the properties that they have.



ACTIVITY: The properties of metals make them useful to make things

INSTRUCTIONS:

1. Now that you have investigated the properties of metals, look at the following photos of different objects made from metal.
2. Answer the questions about each object.



A metal pot. ¹

1. Describe the properties of the metal that this pot is made from.

2. Why are some of the properties useful to the function of the pot.

DID YOU KNOW?

Mercury is the only metal that is in liquid form at room temperature.





A barbed wire fence.

3. This fence in the next photo is made from metal wire. What property of metal allows us to make this barbed wire fence from metal?



A spanner made from metal.

4. What properties does a spanner need to have in order to be used to tighten bolts?

5. How do the properties of metal help the functioning of a spanner?

6. If the spanner was made from plastic, do you think it would work as well? Why?



Coins are made from different metals.

7. Why do you think coins are made from metals?



A tank made from corrugated iron. ²

8. This structure is made from sheets of corrugated iron metal. What property of metal allows people to make sheets of metal like this?

DID YOU KNOW?

Gold is malleable enough for just 1 gram to be hammered into a sheet that is 1 square meter in size. Gold can also be made so thin that it appears transparent!



We have said that metals are shiny (they have lustre). But sometimes, when metal gets old it becomes dull. If something is dull, it has lost its shine. There are ways to make metals shiny again.

ACTIVITY: How can dirty copper coins be cleaned?

INSTRUCTIONS:

1. In this activity, you will not be given the list of materials and a method to follow.
2. Rather, you have to come up with your own steps in this activity to answer the question.
3. Your teacher will place various objects in front of you or the class.
4. Experiment with the objects and see how you can best answer the question for this investigation.



QUESTIONS:

1. What question were you trying to answer in this investigation?

2. Write the list of materials that you needed for this activity. Write it in a bulleted list.

1.2 Properties of non-metals



How can we tell if something is made of a non-metal?

New Words

- non-metal
- dull
- brittle
- insulator



Non-metals are materials that do not have the same properties as metals.

- Non-metals are not shiny, but tend to be dull.
- Many non-metals are not bendy (flexible) but brittle. This means that they will break when we try to bend them with enough force.
- Non-metals do not conduct electricity or heat well. We call them insulators. Can you think of a reason why pots and pans often have plastic or wooden handles?



This kettle is made from metal and has a plastic handle.

In the next activity we will investigate some of the properties of non-metals. We will test and observe the non-metals in the same way that we tested the metals in the previous activity. This is so that we can compare metals and non-metals later on.



INVESTIGATION: The properties of non-metals

AIM: What do you want to find out by doing this investigation.

MATERIALS:

- paper or cardboard
- cotton wool
- fabric
- plastic spoon
- cork
- sponge
- piece of chalk
- small, strong glass (learners should not drop this on the floor)

METHOD:

1. A few non-metal objects have been placed in front of you. Write the name of each object in the table below.
2. Hold each object in your hand. Does it feel hot or cold? Rough or smooth?
3. Look at each object carefully. Is it shiny or dull? Can you describe its colour?
4. Drop each object on the floor, or tap it. What sound does it make?
5. Write your observations in the table below (you may use words from the box below or you may use your own words).

shiny, dull, rough, hard, smooth, makes a ringing sound, cold, warm, heavy, rigid, sharp, flexible, soft, light

OBSERVATIONS:

Fill in the observations from your investigation of different non-metals below.

Name of the object	How the object feels when I touch it	What the object looks like	The sound that is made when the object is tapped or dropped

CONCLUSION:

What have you learned from investigating the properties of metals?

Comparing metals and non-metals

What have we learnt about the properties of metals and non-metals? Now we are ready to compare the properties of metals and non-metals. Read through the two lists below. Do you agree with the properties that have been listed? Are there other properties that you would like to add?

Metals are (mostly):

- solid and strong;
- malleable and ductile (this means they can be hammered or bent into different shapes);
- shiny or silvery (lustrous), especially when they are new; and
- cold to touch.

Non-metals:

- can be soft or flexible, like rubber;
- can be hard and brittle, like glass;
- do not have a silvery (lustrous) appearance, but tend to be dull;
- can be grouped into different categories (ceramics, wood, rubber, plastic, glass etc.); and
- usually feels neither cold nor hot.



KEY CONCEPTS

- Every type of matter has its own set of properties.
- "Shiny", "brittle", "malleable", "dense" are all examples of properties of materials. There are many more examples.
- Metals and non-metals have different properties.
- Materials are useful because of their properties.
- Metals are mined from the Earth.

REVISION:

1. What does the word "property" mean?

2. How can we tell if something is made of metal?

3. What does it mean to 'use our skills of observation'?

4. Design an investigation in which you are trying to work out whether an object is made of metal or a non-metal. You do not need to write out the materials and apparatus required. Rather, explain in a paragraph about the different types of tests you would do to determine if something is made of a metal or a non-metal.



5. Sometimes just using one property to classify an object or material as a metal or non-metal might not be enough. For example, plastic is flexible but strong, so does this make it a metal? The answer is no. Another example is glass. Glass is also hard, but is it strong? What other properties does glass have which make it a non-metal and not a metal?



Now that we have learnt about metals and non-metals, let's see how we use metals in the world around us.



KEY QUESTIONS

- How can we use the special properties of metals (magnetism, electrical conductivity and thermal conductivity) to our advantage?
- Which additional properties of metals make them so suitable for use in items such as jewelry, coins, buildings, vehicles, furniture and utensils?

New Words

- conduct
- magnetic
- rust
- corrosion
- tarnish



We have learnt that whenever we wish to make something new, we first have to decide what the purpose of that product will be. Since we are learning about *Matter and Materials*, let us assume that the product will be a tool or any other kind of object that will be doing a job for us. Once we have decided what the purpose of the object will be, we can choose a material with the right properties for the job.

2.1 Special properties of metals

In this chapter we will learn about some of the uses of metals. The properties of metals make them suitable materials for many different objects. We will soon investigate some special properties of metals that we have not thought about yet.

Metals and magnets

Have you ever played with magnets? Did you notice how magnets attract other magnets, and also certain metal objects?



ACTIVITY: Learning about magnetism

MATERIALS:

- Metal objects: coins, spoon, metal pencil sharpener, nail or screw, paper clip, thumb tack, pin, steel wool etc.
- Non-metal objects: paper or cardboard, cotton wool, fabric, plastic spoon, cork, sponge, piece of chalk, small glass
- Magnet

INSTRUCTIONS:

1. Sort the objects in front of you into two groups: metals on one side and non-metals on the other.
2. Write the names of all the metal objects in the column named "Metal objects" in the table below.
3. Write the names of all the non-metal objects in the column named "Non-metal objects" in the table below.
4. Hold each object close to the magnet to see if it is attracted to the magnet or not?
5. Write your observations in the table below.

Metal objects	Is the object attracted to the magnet? Answer YES or NO	Non-metal objects	Is the object attracted to the magnet? Answer YES or NO

QUESTIONS:

1. Use the information in your table to say decide whether the following statements are True or False. If the statement is true, you should draw a cross (X) in the 'TRUE' column; if the statement is false, you should draw a cross (X) in the 'FALSE' column.

Statement	TRUE	FALSE
All the metal objects are attracted to the magnet.		
Some of the metal objects are attracted to the magnet.		
Some of the metal objects are not attracted to the magnet.		
Some of the non-metal objects are attracted to the magnet.		
None of the non-metal objects are attracted to the magnet.		

1. One of the Thunderbolt Kids on the front cover for Matter and Materials for this term is holding a magnet. Who is it and what is stuck on the magnet? What must these objects be made from to be attracted to the magnet?

2. Complete the following sentence by filling in words from the box below:

_____ of the metal objects are attracted to the magnet, but _____ of the non-metal objects are attracted to the magnet.

Word box

- all
- some
- none

Magnetism is a very interesting property and playing with magnets and materials is fun! Were all the metals that you tested attracted to the magnet?

In the next activity we are going to test the magnetic properties of different metals. There is also a problem that Tom needs to help solve. After you have completed the activity you may be able to give him some advice on how to use magnetism to solve the problem!

ACTIVITY: Using magnetism to solve a problem

MATERIALS:

- Metal pieces: iron, aluminium, and copper
- Magnet

The problem:



Tom likes to visit the junkyard to look for bits and pieces of rubbish to use in his inventions. Uncle owns the junkyard. He buys all kinds of scrap metal, which he then sells to a recycling company. The recycling company pays more if the metal is sorted by type. Uncle has a problem. He does not know how to sort the metal. One day, he is talking to Tom about his problem.

Uncle: "Tom, I need your advice. I know you are clever with inventions, and that you like a challenge."

Tom: "That is true, Uncle. I love a challenge! What is your problem? Maybe I can help you solve it with science!"

Uncle: "I have a huge pile of metal scrap that I need to sort. I know there is iron, aluminium and copper in the pile of metal scrap. But I have no idea how to do this! Iron and aluminium are both metals, and look very similar. Can you think of a way to help me sort them?"

What do you think Tom's advice to Uncle will be?

INSTRUCTIONS:

1. A few metal pieces have been placed in front of you. Find the label on each piece and read the name out loud. Give everyone in your group a chance to say the names of the metals.
2. Write the name of each metal in the table below.
3. Look at each metal carefully. Do they look the same, or are they different? Can you describe the colour of each metal? Write the colour of each metal in the table below.
4. Hold each metal near the magnet. If the metal is attracted to the magnet, draw a cross (X) in the column "Magnetic". If the metal is not attracted to the magnet, draw a cross (X) in the column "Not magnetic".

Metal	Colour of the metal	Magnetic	Not magnetic

Write what Uncle should do in the space below. (It would help Uncle if you gave him step by step instructions on how to sort the metals.)

Not all metals are magnetic. We've seen how metals can be sorted according to their magnetic properties.

Metals and heat

We will now investigate another special property of metals. But first, a question: How do we cook food on the stove? We put the food inside a metal pot, and then we heat the outside of the pot. This makes the food cook on the inside! How does the heat get inside the pot? The next activity will help us answer this question.

ACTIVITY: Learning about heat flow (thermal conductivity)

MATERIALS:

- Container (1 liter yoghurt tub, bottle or a 2 liter ice cream container)
- Warm water (not boiling)
- Ice cold water
- Metal spoon
- Plastic spoon
- Wooden spoon (a pencil or a stick will also do)

INSTRUCTIONS:

1. Fill the container with the warm water.
2. Place the spoons in the hot water so that their handles are above the surface of the water as in the image.

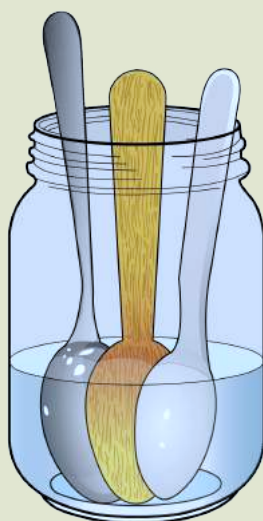

The three spoons in a container with warm water.



3. Leave them in the water for about 15 counts.
4. a) Feel the handles of each of the spoons in turn. Which spoon feels the warmest? Write your answer below.

5. Empty the container and rinse the spoons under the cold tap.
6. Fill the container with the ice cold water.
7. Place the spoons in the ice cold water so that their handles are above the surface of the water.
8. Leave them in the water for about 15 counts.
9. Feel the handles of each of the spoons in turn. Which spoon feels the coldest? Write your answer below.

QUESTIONS:

1. Did the metal spoon feel warm after it had been standing in the warm water?

2. Where did the heat (that you felt with your fingers) come from?

3. How did the heat reach your fingers?

4. Complete the sentence. Write the sentence out in full.
The spoon feels hot because heat flows from _____ to _____.

5. Did the metal spoon feel cold after it had been standing in the ice cold water?

6. Where did the cold (that you felt with your fingers) come from?

7. How did the cold reach your fingers?

8. Complete the sentence. Write the sentence out in full.
The spoon feels cold because heat flows from _____ to _____.

9. Which material (metal, plastic or wood) is the best conductor of heat?

Metals and corrosion

Have you ever noticed how some metal objects are shiny when they are new, but over time the shine disappears and they become dull and blotchy? The car in the picture was once shiny and new, but look at it now! It is covered in rust from standing out in the rain for so long.



An old car covered in rust. ¹

Rust has a reddish-brown colour and a rough texture. Rust is very common; it is the product that forms when iron corrodes. During corrosion, iron reacts with oxygen in the air or in water to form iron oxide (the chemical name for rust). Rust is a type of corrosion, but it is not the only type.

Other types of corrosion include:

- Tarnish (found on silver teapots, trays, trophies and jewellery)
- Patina (the green coating that we sometimes see on copper objects)
- Black spots that appear on brass.
- Aluminium oxide (grey-white coating that forms on aluminium)



Can you see how this old cutlery is dull and tarnished?



Can you see the green coating forming on this copper statue?

INVESTIGATION: INVESTIGATION: Learning about corrosion (rust)



AIM: To find out how rust occurs

MATERIALS:

- 30 identical iron nails
- 3 small clean, dry containers (yogurt tubs or polystyrene cups)
- tap water
- salt water (made by dissolving 10 teaspoons of salt in a liter of tap water)
- plastic wrap to cover the containers

METHOD:

1. Mark the containers by writing A on one of them, B on the second one and C on the last one.
2. Place 10 iron nails in each of the containers.
3. Pour enough tap water on the nails in container A to cover completely.
4. Pour enough salt water on the nails in container B to cover them completely.
5. Do not pour anything on the nails in container C.
6. Cover containers A and B with plastic wrap.
7. Place the containers next to each other in a safe spot where they can be left undisturbed for a few days.
8. Check the nails in the containers every day. Every day (preferably at the same time each day) count the number of nails that have rust on them. Make sure to return the same nails to the same container after you have examined them. Continue to do this over a period of 10 days.
9. Write your results in the table below.

RESULTS:

Day	Number of rusty nails in the cup containing water only (A)	Number of rusty nails in the cup containing salt water (B)	Number of rusty nails in the cup containing no water (C)
1			
2			
3			
4			
5			
6			
7			
8			
9			
10			

Use the space below to draw a line graph of how many nails had rust on them after each day.

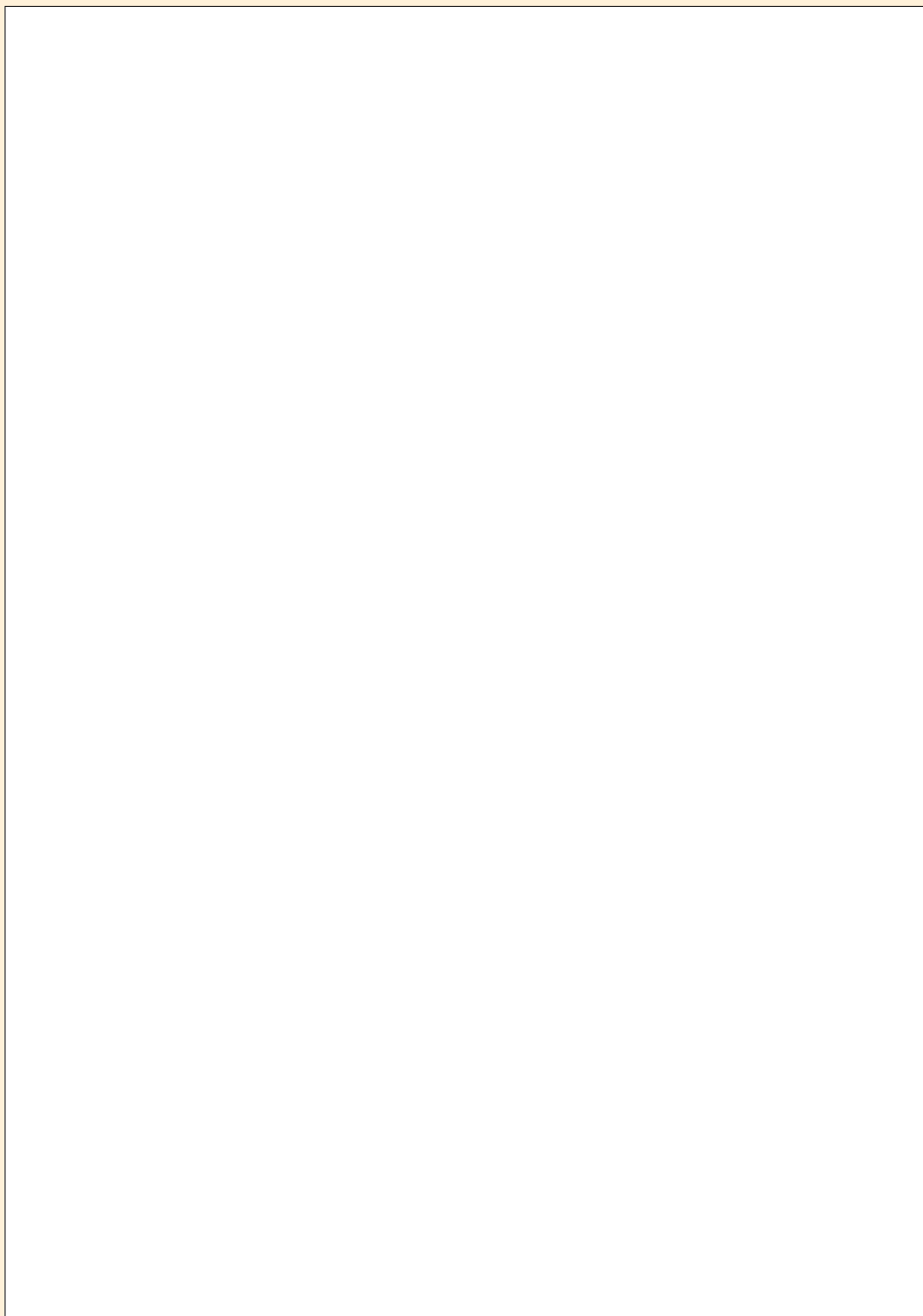

QUESTIONS:

1. In which cup did the nails start rusting first?

1. Complete the following sentences. You may use the words in the box below, or any other words that will make the statement true for you.

a) Iron rusts when it comes into contact with _____.

b) Iron will rust more quickly in _____ than in _____.

Word box:

- air
- water
- salt water

1. Can you think of ways to protect iron against rust? (Hint: Look at the following picture for a clue.)



These people are painting the iron poles and fences. ²

We have seen that iron rusts. Other metals also change when they are not protected. Have you noticed what coins look like when they are new? New coins are bright and shiny. Old coins are dull and they look dirty. That is because they have a dark layer of tarnish on them. In the next activity we will see how the layer of tarnish can be removed to make coins bright and shiny again.

ACTIVITY: How can dirty copper coins be cleaned?

MATERIALS:

- 20 dull, dirty copper coins
- 1/4 cup white vinegar
- 1 teaspoon salt
- A clear, shallow bowl (not metal)
- Paper towels, tissues or sheets of paper

INSTRUCTIONS:

1. Put the salt and vinegar in the bowl. Stir until the salt dissolves.
2. Dip one coin halfway into the liquid. Hold it there for about 10 seconds, then pull it out. What do you see?
3. Place all the coins into the liquid. You can watch them change for the first few seconds. After that you won't see anything happen.
4. After 5 minutes, take half of the coins out of the liquid. Put them on a paper towel but do not rinse them or dry them.
5. Take the rest of the coins out of the liquid. Rinse them really well under running water, and put them on a paper towel to dry. Write "rinsed" on the second paper towel.
6. After about an hour, look at the coins on the paper towels. Write your observations in the table below.



DID YOU KNOW?

Many plastics can be made strong enough to replace metals, glass and other materials. Some cars can be made from these plastics! The plastic weighs much less than metal, and this means the car needs less energy to move around.



Item	What does it look like?
Coins before you put them in the vinegar-and-salt mixture	
Unrinsed coins after one hour	
Rinsed coins after one hour	
Paper under the unrinsed coins	
Paper under the rinsed coins	

QUESTIONS:

1. Why did the coins look dirty before you put them in the vinegar-and-salt mixture?

2. What happened to the coins in the vinegar-and-salt mixture? Why do you think this happened?

3. Taste a few drops of the clean vinegar. What does it taste like?

4. Can you think of another liquid that could be used instead of the vinegar? (Hint: What other liquids taste sour?)

5. What happened to the unrinsed coins? Did they also become clean and shiny?

Next, we are going to learn more interesting things about metals and what they are used for.

2.2 Uses of metals

Metals have thousands of uses. We use metals every day, sometimes even without knowing!

Metals are ductile and good conductors of electricity. This is why metal is used to make the wire inside electrical cables. Without electrical cables we would not have electricity in our homes or schools; we would not have lights or television, or telephones. (Next term we will look more at electricity!)

Metals are extremely strong and can be turned into thin sheets. These sheets can be used to make the bodies of the cars, trucks, trains and aeroplanes that are used to transport people and goods from one place to another.

New Words

- goods
- durable
- support



DID YOU KNOW?

South Africa has one of the biggest deposits of platinum in the world. Platinum is a very valuable and expensive metal.



Aeroplanes are made from strong, durable sheets of metal.



A bridge made of metal.

The strength and durability of metals make them very important as building materials, not only in visible ways (such as metal roofs and window frames), but also in invisible ways (such as metal supports inside the concrete that bridges and tall buildings are made of). Even furniture is sometimes made of metal!



ACTIVITY: The uses of metals in your home

INSTRUCTIONS:

1. Choose 8 metal objects from home (you could also choose your classroom).
2. Next to each metal object on your list, write why you think metal was used to make this object. You should write what property of metals makes it the best material for that particular job.
3. If you think the object could also have been made from another material, say which material. You may want to look at the example below for ideas.

Metal object	Reason for using metal in this object	Other material(s) that could be used instead of metal
Broom handle	Metal is strong and durable	Wood, strong plastic

4. Present your findings on a poster with a table where you record your observations (it could be similar to the one above).
5. Include some pictures or photographs of the objects and do not forget to give your poster a heading.

QUESTIONS

Turn back to the front cover for Matter and Materials where you can see the Thunderbolt Kids are at a construction site for a stadium. Identify the objects that are made of metal and write them down below.



KEY CONCEPTS

- Metals have some special properties.
- Metals can conduct heat and some metals are magnetic.
- Metals have many uses.
- When we choose a material for a certain purpose, we look for a material with the right properties for the job.





REVISION:

1. List as many properties of metals as you can think of.

2. Are non-metals magnetic?

3. Tom used magnetism to help his uncle. Which metal in the junkyard was attracted to the magnet?

4. Are all metals magnetic?

5. Why are most pots and pans made of metal?

6. Why do some pots and pans have handles made of plastic or wood?

7. Why does iron that is shiny when it is new become dull and blotchy when it stands outside for a long time?

8. What does rust look like? (Describe what it looks and feels like.)

9. What is another name for rust?

10. Do all metals rust?

11. Your dad is putting up a new iron fence in front of your house. What would you tell him to do to make the fence last long?

12. Look at the picture below of a hammer. What is the head of each hammer made from and why do you think this material was used?



Different sized hammers. ³

13. If you had to advise your parents or a family friend who wants to buy a set of chairs and tables for their garden to replace the plastic ones which have broken, what would you advise them are the best types of furniture for outside in the garden? Explain your answer.

14. Some jewellery is made from metal. What types of metal is jewellery made from and why do you think some of these metals are so expensive.

15. Why do you think your kitchen utensils (such as knives, forks and spoons) are normally made from metal and not plastic and wood? Why then do fast food restaurants give you plastic utensils with your take aways?

16. Below is a picture of a fire engine truck. Can you imagine a fire engine made from plastic or wood?! What properties of metal make it suitable for the fire engine?



A fire engine made of metal.



KEY QUESTIONS

- How can we make new materials?
- How does the amount of material we start with affect the amount of new material we can make?

When we combine materials, new materials are made. The properties of the new materials are often different from the properties of the materials we started with.

There are many ways to process existing materials into new materials. There are also many reasons why we would need to process materials into new materials.

When we bake a cake, we are processing flour, eggs and other ingredients (that may not taste very nice on their own) into cake which tastes really good!

New Words

- mixture
- dissolve
- solution
- raw material
- process
- concrete
- cement

We process materials to make them stronger, or more durable, or waterproof, or even just to make them look more beautiful or interesting. New materials that form after mixing different materials are sometimes called *mixtures*.



Mmmm. yum! I think I am going to enjoy this chapter if we are going to be making cakes!

We are going to have some fun Tom! And at the same time learn about different ways to combine materials.

3.1 Combining materials

We have learnt that iron rusts over time, and that this process speeds up when the iron is in contact with water. Have you ever noticed rust on the knives and forks in your home? Probably not! That is because they are not made of iron but of stainless steel. But what is stainless steel?

ACTIVITY: A research project to learn about stainless steel

Stainless steel is made by combining iron with other metals to make it stronger and to prevent rust. Processing iron with other metals to turn it into stainless steel means we can use it even in wet environments. Water taps and pipes are sometimes made of steel. Some of the instruments that doctors use to operate on sick people are made of steel, and so are the pots and pans that we use when we prepare food.



Stainless steel taps in the bath.



Look at this shiny pot made of stainless steel. ¹

INSTRUCTIONS:

1. Your task is to find out as much as possible about stainless steel.
2. You may use books or the internet, or you may ask people in your family or your community what they know about stainless steel.
3. This process of finding out things about a topic is called *research*.

4. You can use the following questions to guide your research:
 - a) What is stainless steel?
 - b) What is the main component of stainless steel?
 - c) What other metals are in stainless steel?
 - d) Why are other metals added to make stainless steel?
 - e) Are there different types of stainless steel?
 - f) What is stainless steel used for?
5. When you have gathered all your information, write a short story with the title: *Stainless Steel*.
6. You may use pictures to make it more interesting and present it either as a pamphlet or a poster.

Let's look at more ways to combine and process materials.

Mixing

Often, when we mix materials together, the properties of the new material or product is different from the properties of the materials we started with. Do you remember what the word "property" means from the previous chapter when we looked at the properties of metals and non-metals? Let's make some sticky glue to find out about this!



ACTIVITY: Making glue

MATERIALS:

- flour
- water
- 2 bowls for the flour and water
- a bowl for mixing
- pieces of paper

INSTRUCTIONS

1. We are going to make a sticky glue paste using flour and water.
2. First you need to look at the individual properties of the flour and water before we mix them together. Describe the properties of the flour and water.
3. Now experiment with mixing different quantities of water and flour together to make a sticky paste.
4. See if you can stick pieces of paper together using the glue that you have made!
5. Describe the properties of the paste you have made.

QUESTIONS:

1. What did the flour feel like before it was mixed with the water?

2. How would you describe the properties of plain water?

3. After mixing the flour and water together, what are the properties of the paste that you end up with?

4. Do you remember learning about the states of matter? What state of matter is the flour and what state of matter is the water before mixing?

5. What state of matter would you say the paste is?

Did you get any of the paste you made in this activity on your fingers?! Perhaps it started to dry and become hard? Often when we combine materials together we have to let them set.

Mixing and setting

Have you ever tasted jelly? Jelly comes in many different colours and flavours. Which is your favourite?

To make jelly, we must dissolve jelly powder in hot water. When the solution of jelly powder in water cools down, something very special happens: The solution sets, and turns into a delightfully wobbly, sweet treat! The jelly powder has been processed into something new! That is what the next activity is all about.



ACTIVITY: Making Jelly

MATERIALS:

- a packet of jelly powder
- a bowl
- a cup for measuring
- hot and cold water
- spoon for mixing

INSTRUCTIONS:

1. Read the instructions on the packet of jelly.
2. Pour the jelly powder onto the bowl.
3. Look carefully at the dry jelly powder. What does it look like?
4. Touch the jelly powder with your finger. What does it feel like?
5. Place a few grains of the jelly powder on your tongue. What does it taste like?
6. Write your findings in the table below.
7. Follow the instructions on the packet to make the jelly.
8. Cool the jelly until it sets.
9. Describe the properties of the prepared jelly in the same way that you did for the starting materials.

Here are some words that you may find useful. You may also use your own words.

liquid, clear, powdery, sweet, sticky, transparent,
wobbly, solid, gelatinous (jelly-like), slippery

Table of observations:

Properties	Dry jelly powder (before mixing)	Water (before mixing)	Prepared jelly (after it has set)
What does it look like?			
What does it feel like?			
What does it taste like?			

QUESTIONS:

1. What materials did you start with? (These are called the *starting materials*.)

2. What happened to the jelly powder when you mixed it with the water?

3. Why is the water a different colour?

4. How did the jelly mixture change when it cooled down?

5. Write a short paragraph to describe how the process has changed the properties of the jelly.
Try to use as many of the following words as possible in your paragraph:

investigation, powder, powdery, sand, water, disappear,
colour, change, mixture, stiff



Strawberry jelly. ²

In the picture above, some strawberries have been added to the jelly after it was mixed with the water, but before it was cooled to set. It looks delicious! We could say the strawberries are embedded in the jelly.

In the previous activity we saw that jelly sets. Jelly is not the only material that sets. We are going to investigate another material that sets shortly.

Have you ever watched builders mix *concrete* when they want to build a wall or a house? Look at the people in the pictures below. What are they doing?

The people in the pictures are mixing sand and water with building *cement*. The mixture of sand, water and cement is called *concrete*. Concrete is like mud when it is wet, but when it dries out it sets into a hard, strong material. Concrete can be used to make bricks and pavements and to plaster walls.

In the first picture people are using spades to mix the concrete. They are using the spades like we would use a spoon to stir sugar into a cup of tea. The people are using their muscles to do the work required for mixing the concrete.



Mixing cement using spades.

In the second picture the machine on the right is called a cement mixer. This machine mixes all the ingredients by turning mechanically, like an electric food mixer. Electrical energy does the work required for mixing the concrete.





Mixing cement using a mixer.



A cement mixer.

In the next activity we are going to make some bricks, using sand and water and some *plaster of Paris* (a material that is very similar to cement).



ACTIVITY: Making Bricks

MATERIALS:

- plaster of Paris powder
- water
- clean sand (or sandy soil) (beach sand or builder's sand would work well)
- an empty ice cube tray
- ice cream sticks or plastic tea spoons for mixing and scooping
- 2 empty 1 liter yoghurt tubs: one for measuring and one for mixing

INSTRUCTIONS:

Look at all the starting materials and feel them with your fingers. Write their properties in the table below. Do NOT taste any of them! (Tasting is ONLY for food.)

Properties	Plaster of Paris	Sand	Water
What does it look like?			
What does it feel like?			

Making sand bricks:

1. Mix some of the sand with water to make some stiff mud. Fill three or four of the hollows in the ice cube tray with the mud.
 2. When these bricks are dry, they will be sand bricks.
 3. Do you think they will be strong and durable?
-

Making 'concrete' bricks:

1. Pour all the plaster of Paris powder into the measuring tub. Measure the amount of powder in the tub by making a mark on the outside of the tub with a pen. Pour the plaster of Paris into the mixing tub.
2. Pour sand into the measuring tub, up to the mark that you made in step 1.
3. Add the sand to the plaster of Paris in the mixing tub.
4. Repeat steps 2 and 3 once more.
5. Pour water into the measuring tub, up to the mark that you made in step 1.
6. Add the water to the sand and plaster of Paris and mix well with the stick. Now you have made wet 'concrete'. You will have to work fast because it will set quickly.
7. Scoop the wet 'concrete' into the empty hollows of the ice tray. Fill them all to the same height so that your finished bricks all have the same size. Make the top surface of each brick flat so that they will be easy to stack later.

- a) When these bricks are dry, they will be 'concrete' bricks. Do you think they will be strong and durable?
-

8. Wash your hands very thoroughly.
9. Leave all the bricks overnight to set. When the bricks have set they can be removed from the tray and placed in a sunny spot to dry out for a few days.
10. When the bricks are dry you can use them to build something interesting.
11. Examine both types of bricks and write your observations in the table below.

Properties	Wet sand	Sand brick	Wet 'concrete'	'Concrete' brick
What does it look like?				
What does it feel like?				
Is it strong and durable? (Yes or No)				

QUESTIONS:

1. What materials did you start with?
-

2. How did the 'concrete' mixture feel after you mixed it? Did it get warmer or colder?

3. Where do you think the heat came from?

4. Do you think that sand and water alone would be good material for making bricks? Say why (or why not).

5. Did adding plaster of Paris to the sand make the bricks better? In what way?

6. Can you think of other materials that we could add to the mixture of sand and plaster of Paris to make the bricks even stronger and tougher?

Real bricks are actually made by firing the bricks in a special oven called a kiln to bake them and make them hard. A potter is someone who makes objects such as pots out of wet clay. Once they have dried and have been fired, the clay becomes hard.



*These clay pots have been dried and have been loaded into a kiln to be fired.*³

We have learnt that we can make materials stronger if we add other materials to them. When we make certain materials stronger by adding other materials, we say we are *reinforcing* it. In the activity you have just completed the bricks made of 'concrete' (sand and plaster of Paris mixture) was stronger than the bricks made of sand only. The plaster of Paris acted as *binder* to glue the sand grains together.

In the next activity we will be looking at pictures showing examples of how concrete can be reinforced. There will be some questions to help you think about each process.



ACTIVITY: Reinforcing concrete

INSTRUCTIONS:

Look at the picture of a piece of concrete wall below. The concrete looks as if there are pebbles (small stones) embedded in it.



*A close up photo of a slab of concrete.*⁴

1. Can you see that there are things *embedded* in the concrete?
What do you think they are?

2. How did the stones get inside the concrete?

3. Why do you think the concrete was mixed with stones? (Hint:
Is stone a strong material?)

4. What is the process called when we make a material stronger
by mixing it with another material?

Look at the picture below. It shows how a floor is being prepared
for reinforcement with steel bars.



A piece of floor being prepared. ⁵

5. The floor in the picture is inside a garage. Why do you think the concrete needs to be reinforced with steel bars? (Hint: Why would the garage floor need to be extra strong?)
-
-

The next picture shows a new building that is being constructed.



A new building. ⁶

6. Can you see the steel bars that are sticking up into the sky? What do you think would be their purpose?
-
-

7. Why does the building need a structure that is extra strong?
-
-

Mixing and cooking

Cooking food is also a form of processing. Have you ever seen what a raw egg looks like? The same egg looks quite different when it is cooked. Notice how the egg white is transparent when it is raw, and white when it is cooked. When it is raw, the egg is runny, like liquid. When it is cooked, the egg is solid but soft like rubber or soft plastic. Look at the pictures below.

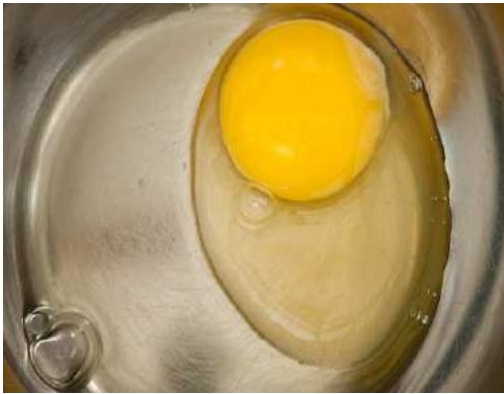

A raw egg ⁷



A fried (cooked) egg

In the next activity we will be cooking some flapjacks. They are like pancakes but smaller and thicker. We will be comparing how the raw ingredients change when they are first mixed, and then cooked.



Choose me to be the taster!!



ACTIVITY: Let's have fun making flapjacks!

MATERIALS (In this case, ingredients and cooking apparatus!):

- 2 cups flour
- 2 1/2 teaspoons baking powder
- 3 tablespoons sugar
- 1/2 teaspoon salt
- 2 large eggs
- 1 1/2 to 1 3/4 cups milk
- 2 tablespoons melted butter
- cooking oil
- 2 mixing bowls
- frying pan
- spatula
- hot plate for cooking

INSTRUCTIONS:

1. Look carefully at each of the ingredients in turn. What do they look like?
2. Touch each ingredient with your finger. What do they feel like?
3. Place a little bit of each ingredient on your tongue. What do they taste like?

Do not use words like good, bad, tasty, funny or weird! The block below contains some descriptive words that you could use:

powdery, fizzy, sweet, salty, tasteless, sandy, crunchy,
oily, smooth, liquid, milky, slippery, dry, grainy, bitter,
frothy, runny

4. Sift together the dry ingredients. The dry ingredients are the flour, baking powder, sugar, and salt.
5. In a separate bowl, whisk together the eggs. Add 1 1/2 cups of milk to the eggs and mix well.
6. Add the milk mixture to the dry ingredients. Stir until the batter is smooth.
7. Add the melted butter to the batter and mix.
8. If the batter seems too thick to pour, add a little more milk.
9. The batter is now ready to be processed into flapjacks.
10. Look carefully at the batter. Scoop some of it out of the mixing bowl and touch it. Now lick your finger. Write the properties of the batter in the table below. (Remember to look at the block above for some descriptive words.)
11. Heat the pan on the hot plate and add a little bit of oil.
12. When the pan is hot, place scoops of the batter in the pan with a large spoon. You should space the scoops of batter so they don't touch each other.
13. When the flapjacks are bubbly and a little dry around the edges, flip them with the spatula.
14. Describe the properties of the prepared flapjacks in the table below.
15. Now you can enjoy them, sprinkled with sugar or drizzled with syrup! Yum yum!

Properties	Uncooked batter	Cooked flapjack
What does it look like?		
What does it feel like?		
What does it taste like?		



A stack of flapjacks!

QUESTIONS:

1. What were the starting materials of this activity? Write them in the table below:

Starting materials

2. Write a short paragraph to describe how the process changed the properties of the batter. How did the batter change when it was cooked? (Say what the batter looked, tasted, and felt like **before** and **after** it was cooked.)

3. Draw a flow diagram to explain how you made the flapjacks from the starting materials. You must include labels to explain the process. Look at the following flow diagram about how to make a cup of tea for inspiration.

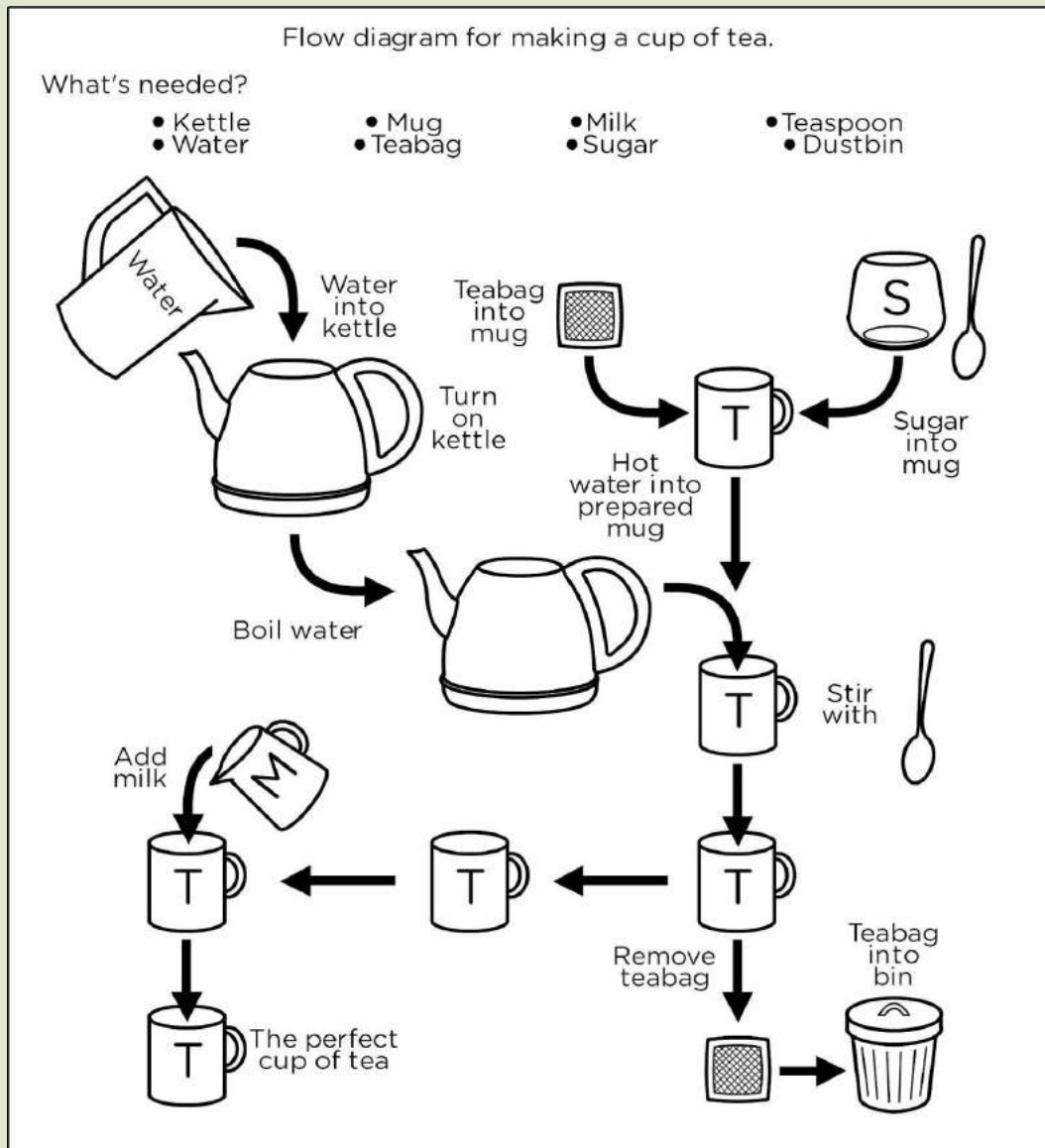

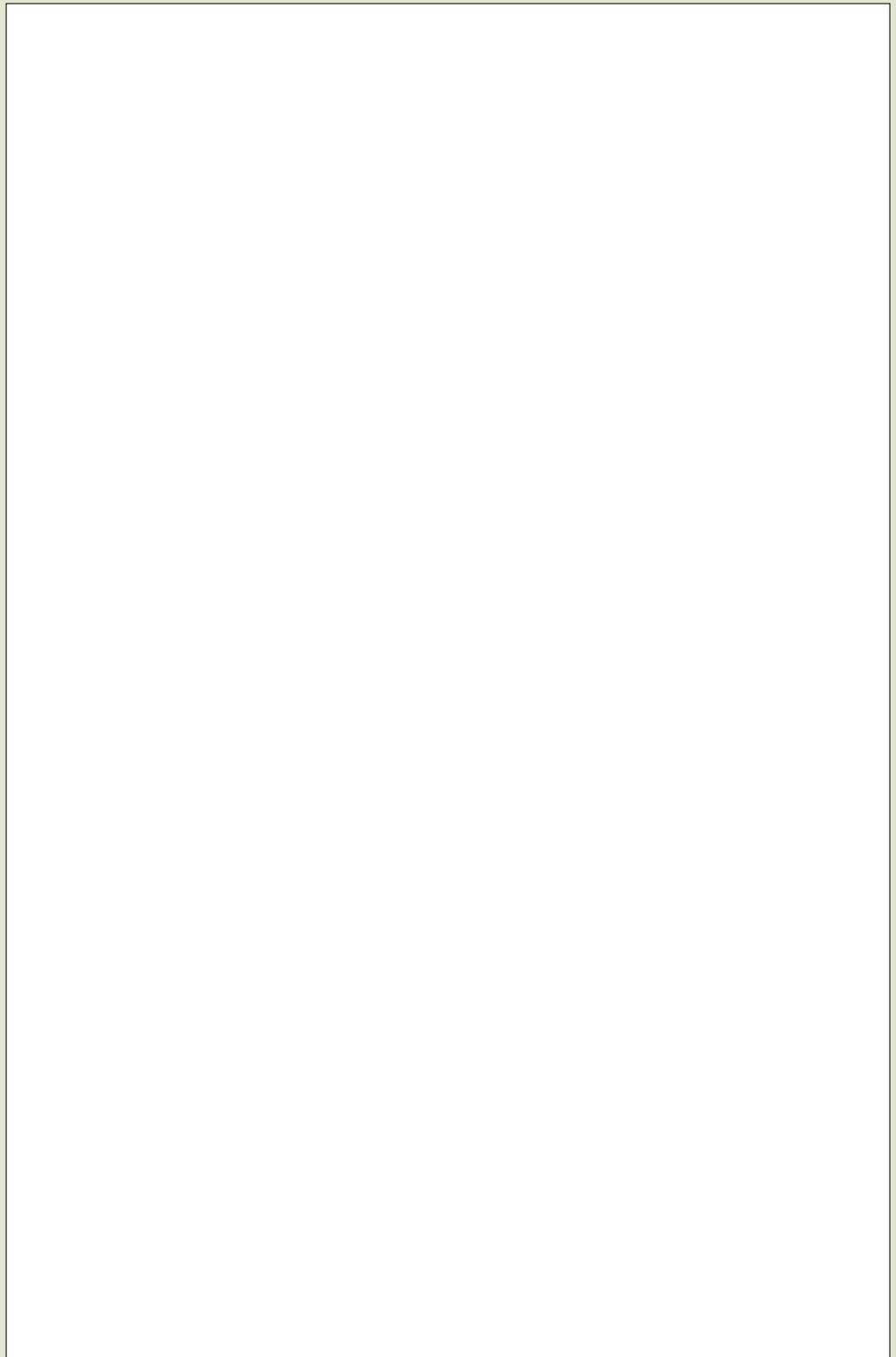



That was so good! I want to invite the other Thunderbolt Kids over to my house on the weekend and make us flapjacks!

Great idea Tom, your friends will love that! But do you know how much batter you will need to make?

ACTIVITY: How does the amount of material we start with affect the amount of new material we can make?

Tom is making flapjacks for his friends, Sophie, Farrah and Jojo. He uses the recipe in the previous activity. He is very careful not to waste any of the batter. When all the batter is finished, he counts the number of flapjacks he has made. There are 12 large flapjacks. He is very pleased with himself because it means each one of them can have 3 large flapjacks.



QUESTIONS:

1. How many flapjacks could Tom make if he used only half of the batter?

2. Tom decides to invite 4 more friends to eat flapjacks. That means there will be 8 people in total. How many flapjacks would he need to make if each person eats 3 flapjacks?

3. Tom needs to make enough batter for 24 flapjacks. Help him to work out how much of each ingredient to use. Write the amounts in the table below:

Ingredients	Amount needed for 12 flapjacks	Amount needed for 24 flapjacks
Flour	2 cups	
Baking powder	2 1/2 teaspoons	
Sugar	3 tablespoons	
Salt	1/2 teaspoon	
Eggs	2	
Milk	1 1/2 cups	
Melted butter	2 tablespoons	



KEY CONCEPTS

- Materials can be processed in many different ways to make new materials or products.
- When we process materials, the new materials may have different properties.
- The purpose of most processing methods is to make materials more useful.

REVISION:

1. List three reasons why we process materials.

2. Give an example of a *solution* from everyday life.

3. What is stainless steel?

4. Below are two pictures. Describe the properties of the materials in both pictures and what processes took place to get from Picture 1 to Picture 2.

Picture 1	Picture 2
	



-
-
-
5. This boy in the picture below has broken his arm and has a cast on. Why do you think a cast for a broken arm is made from plaster of Paris? (Hint: Think of the properties before and after mixing and setting).



A cast made from plaster of Paris. ⁸

-
-
-
6. Bricks are made by shaping the clay into rectangle shapes and then firing them in a kiln. What are the properties of bricks after firing? Name a few places where bricks are used.



Those flapjacks were delicious! Now I'm ready to learn more about processed materials.



KEY QUESTIONS

- What are raw materials, natural materials and processed materials?
- Which traditional processing methods have humans been using to give materials more desirable properties?

4.1 Properties and uses

New Words

- natural
- raw
- durable
- waterproof
- fire resistant
- texture



We call materials that have not yet been processed *raw materials*. Raw materials are made into other things. When raw materials are in the form in which they are found in nature, we can call them natural materials. A *natural material* is any material that comes from plants, animals, or the ground.

We have learnt that there are many different ways in which materials can be processed to give them new properties. After processing they may look, smell, feel or taste different. They will probably also be used for a totally different purpose from before.

Processed materials are materials which have been refined or built by humans from raw materials. Some examples include paper, steel and glass.



ACTIVITY: Raw or processed material?

Teacher's note: In this activity the learners must study a list of materials and then decide which represent raw materials and which represent processed materials. It is recommended that this should be a small group activity, since discussion and joint decision making is required.

INSTRUCTIONS:

1. Below is a list of different materials.
2. In your group, you need to sort the materials into two categories: Raw materials and Processed materials.

3. In your group, discuss all the materials listed before deciding in which category each one belongs.

Bread	Minerals from a mine	Sausage
Rice	Metal furniture	Wheat
Maize meal	Wooden furniture	Animal skin
Toothpaste	Leather shoes	Honey
Vegetables	Petrol	Crude oil
Meat	Necklace made of shells	Mealies
Wood	Metal from a mine	Vegetable soup

All the materials in the list above have been placed into a table (below). Discuss each material in your group and decide how to classify it. Is it a raw material or a processed material? Does it come from plants, animals or the ground? You can look at the table to guide you.

Categories of materials:

Material	Is type of material is it? (raw or processed)	What is the origin of the material? (plant, animal or Earth)
Bread		
Rice		
Maize meal		
Toothpaste		
Vegetables		

Meat		
Wood		
Honey		
Sausage		
Metal furniture		
Wooden furniture		
Leather shoes		
Petrol		
Necklace made of shells		
Minerals from a mine		
Crude oil		
Mealies		
Wheat		
Animal skin		
Vegetable soup		
Metal from a mine		

QUESTIONS:

1. Draw a new table in which you place each processed material next to the Raw material that it may have been made from. For instance, in the table below, bread and wheat have been placed next to each other, because bread can be made from wheat.
2. In your table, try to match up as many Raw materials with Processed materials as you can.
3. Which of the materials do not match any other materials? Can you think of a match for each one that does not have a match?

Processed Material	Raw Material
Bread	Wheat

Materials that have been processed are very useful to us because they have special properties. We already know that processed materials can be strong and durable. But what other properties do they have? Let's look at some example.

What do you put on when it is raining outside? Some processed materials are useful to use because they are waterproof. A rain jacket is made of a material which is waterproof, and so is an umbrella. Maybe you might wear gum boots or wellingtons? These shoes are very waterproof and made from specially processed plastic and rubber.



This man is wearing a rain jacket and has an umbrella made from waterproof materials.



These pink gumboots are very waterproof!

Paint is a processed material. The pigments used to make paint are natural materials, but the final product is a processed material.



QUESTIONS

Do you remember we mentioned pigments last term in Life and Living? What was the green pigment used in photosynthesis to make food for plants?



Paint is a processed material.

QUESTIONS

1. What special properties of paint make it useful to us?

2. Think of all the cases where people use paint and write them down.



We have just seen that processed materials can be used because they have special properties (such as paint having the ability to change an object's colour). In the last chapter we looked at concrete. We learned how to make concrete by combining different materials. But concrete can also be used decoratively as it has many different textures. Look at the pictures below which give some idea of the different textures of concrete and how it is used to make surfaces look interesting!

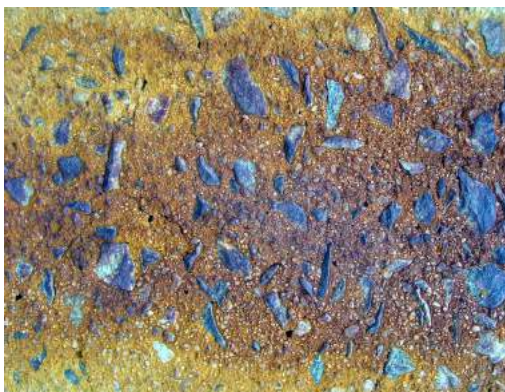
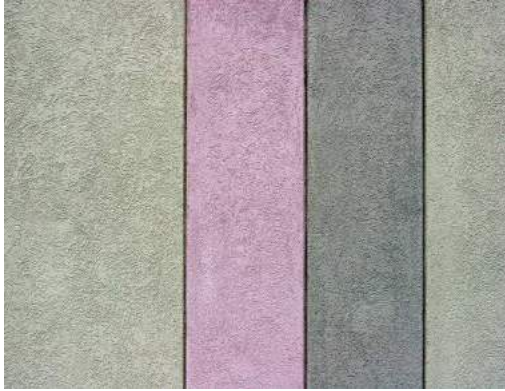



Wow, I always thought concrete was so boring! Farrah would love this!

That is right Tom! And there are so many more properties that we could discuss, such as being fire resistant! But the best would be for you to go out and experience it for yourself and look at the materials around you with new eyes!

ACTIVITY: Investigating processed materials in the world around us

INSTRUCTIONS:

1. Your task is to find examples of processed materials in the world around you, particularly non-metals.
2. You must look at why that material has been used and how its properties make it useful to us.
3. You must select two different locations to look for materials. One location can be the school or classroom, and another location could be your home or your community.
4. In Chapter 2, you did an activity looking at the uses of metals, but now you must focus on the uses of non-metals which are processed materials. Wood, for example does not fall into this category. It is a non-metal but it has not been processed.
5. Ask your teacher how you must present your findings. You could present it as a poster, or using a flipfile.
6. Include some pictures of the materials or drawings. You could even make rubbings of the different textures!



7. Try to find at least 4 different processed materials in each location. The materials must be used for different purposes and have different properties.

New Words

- traditional
- descendants
- pastoral
- expedition



In the next section we will learn about some of the ways in which people processed materials in early times. Some of these traditional methods of processing materials are still used today!

4.2 Traditional processing

People have been processing materials from the earliest times. In the old days only natural materials were available and people found many clever ways to make these materials more useful.

The first people who lived in our land had ways to harden wood and bone for making tools and hunting weapons. They also had ways of reinforcing the mud used for making traditional huts. They knew which materials made the best clothes and blankets, and which grass made the softest beds. They also knew exactly which reeds would make the best mats to cover their walls, and how to build houses best suited for their climate and lifestyle.

Some of these traditional ways of processing materials are still used today. In this section we will learn more about them.



ACTIVITY: Traditional materials and processing

Before South Africa was a country, several interesting groups of people lived in our land. The Khoikhoi people were one of the first nations to live in Southern Africa and many modern day South-Africans are descendants of the Khoikhoi. The Khoikhoi were pastoral people who kept goats, but also hunted animals for their meat and skins.

INSTRUCTIONS:

1. The following story tells us about the young Khoikhoi hunter, Heitsi, who prepares to go on an expedition to hunt a springbok.
2. Read the story carefully, and look out for clues about the ways in which Heitsi's people used and processed materials.

3. When you have read the story, answer the questions that follow.

Heitsi prepares for the hunt

Heitsi is getting his hunting kit ready for the hunt. He is not a man yet, but already a good hunter. When he was born, 11 summers ago, his mother named him after Heitsi-eibib, who was a mythical hunter, sorcerer and warrior in the stories of his people. His father and uncles have taught him how to use the traditional hunting weapons of the Khoikhoi: the bow and arrow and the "kierie" (throwing stick).

Heitsi is very excited about the hunt. Today he is hoping to kill a springbok, because he wants to cut a head dress for himself from the skin of the springbok. He can already imagine how envious his friends will be when he wears it proudly around his head.

He will give the rest of the springbok skin to his mother to turn into a blanket (*karos*) or a piece of clothing for his new baby sister. His mother will scrape the skin with a sharp stone or metal blade to remove the hair and rub it with animal fat for a long time to make it soft.

Heitsi slings the quiver in which he keeps his arrows over his shoulder. The quiver is made from tree bark. It is a good quiver, but he really wants one made of animal skin like the one his father carries. The arrows inside the quiver have wooden shafts and sharp tips made of metal. His younger cousins have arrows with tips made of hardwood. In the old days all the arrow tips were made of wood or bone, but Heitsi's people have been making contact with other peoples who have introduced them to metal.



He also keeps some tinder in his quiver. Tinder is the name for the soft, dry plant materials his people use when starting a fire. Another item he keeps in the quiver is a hollow reed that can be used like a straw to suck up water that has collected on the leaves of plants.

He knows that he has to handle the arrow tips very carefully because they are very sharp. He keeps them sharp by rubbing them on a special stone.

Another reason why Heitsi handles the arrows very carefully is because their tips have been covered with a layer of poison. His cousins sometimes use the sap from poisonous plants to treat their arrow tips, but he prefers to use snake poison because it is more potent.

He picks up his bow, and admires it for a moment. He made it himself from the flexible wood of a wild olive tree. The bow string is made from the gut of a small wild cat that he hunted last summer. His uncle's bow has a string made of twisted palm leaves, and it makes a beautiful sound when Uncle holds the end of the bow in his mouth and taps against the string with a stick. Tonight, when they return from the hunt, the men will dance around the fire while the women sing and clap their hands. There will be stories told about the hunt, and Heitsi will honour the soul of the springbok that he has killed.

The last weapon he picks up is his *kierie*. It has a long handle and a knob at the top end. The *kierie* was a gift from his favourite uncle. Uncle made it himself from strong wood. To make the *kierie* even stronger, Uncle placed it close to the fire for a long time. The heat from the fire dried out the wood and made it tough and strong.

At last Heitsi is ready for the hunt...

QUESTIONS:

1. In the story, many different traditional materials used by the Khoikhoi people are mentioned. In the table below, you must fill in what material was used for each purpose in the middle column. In the column on the right you must fill in what other material could be used for the same purpose.

Purpose	What material was used?	What other material could be used?
Making a quiver for arrows		
Making the arrow shaft		
Making the arrow tip		
Making poison for the arrow tip		

DID YOU KNOW?

Fire-hardening is the process of removing moisture from wood (or bone) by slowly and lightly roasting it over a fire. This process makes a point (like that of a spear) or an edge (like that of a knife) stronger and more durable.



1. What processing method was used to turn animal skin into soft leather?

2. What processing method was used to make wood harder so that it could be used to make an arrow tip or *kierie*?

3. What processing method was used to make bone harder so that it could be used to make arrow tips?

4. How did Heitsi keep his arrow tips sharp?

Later, we will read about the traditional Khoikhoi house that Heitsi and his family lived in. First, we will learn about a different kind of traditional home, that is still seen today.

Some of the traditional homes in Africa are made of clay or mud. In the activity *Making Bricks*, we saw that mud (a mixture of soil and water) is not a very strong material. When it is dry, it can crumble and collapse. When it is reinforced, it can make a strong and durable building material that can be used to build a house. If it is built well, the house will last for many years.



ACTIVITY: Making a mud house stronger

In this activity we are going to look at some videos and pictures for ideas on how to process mud into a strong and durable building material. If you are not able to watch the videos, then look at the pictures. Many of these traditional building methods have become very popular amongst modern-day people who want to live in a sustainable way.

INSTRUCTIONS AND QUESTIONS:

Follow the link to the first video ¹. Watch the video and then answer the questions. Alternately, you could study the picture of the boy learning how to build a mud wall below.



A boy helping to build a mud wall.



The wall of a mud house with a stick frame. ²

1. What material is the house in the video and in the pictures made of?
-

2. The man in the video used two methods to strengthen the walls of his house. What are they? Or else, look at the second picture above of a close up photo of a wall to see how they strengthened the wall.
-
-

Follow the link to the second video goo.gl/IUVXh. Watch the video and then answer the questions or look at the pictures below.



A close up photograph of a mud used to make the wall.



The mud mixture.

1. What materials are recommended to reinforce the mud?

2. Why do you think the wall should be built thicker at the bottom than at the top?

3. Write a step-wise procedure for building a mud shelter.

Follow the link to the third video that shows how to build a mud wall goo.gl/ybtMK. Alternatively you could look carefully at the pictures below.

The mixture of clay and straw the man is using to build the wall is sometimes called *cob*. Another way of building a cob wall is to use bricks made of cob.

The woman in the picture below is making bricks for a new house. Look carefully at the picture of the bricks she has made, then answer the questions.



A woman making bricks.

1. What material has the woman added to the mud to reinforce the bricks?

2. What is this mixture called?

3. Would it be possible to add the straw or grass after the bricks have been made? When should the straw be added to the clay?

Finally, the fourth video shows a different way to reinforce clay bricks. goo.gl/EhT83. Watch the video to the end and then answer the questions. Or look at the pictures below.

<p>Pouring water in to mix with the mud and straw.</p>	
<p>Putting the mixture into a mould.</p>	
<p>Packing the mud mixture into the mould.</p>	
<p>Removing the mould.</p>	
<p>Leaving the bricks to dry.</p>	

1. Do the bricks contain straw or stones?

2. How does the man get all the bricks to look the same?

3. After making the bricks they are stacked in a large pile and then a fire is made underneath the pile. What do you think is the purpose of this procedure?

4. Make a list of all the different ways in which mud or clay can be made stronger when we want to use it to build a house.

You may remember from the story *Heitsi prepares for the hunt*, that Heitsi belongs to the Khoikhoi people from the days before South Africa was a country. In those days there were no borders, no provinces, no towns or cities, and no roads. No-one 'owned' land; the land belonged to everyone who lived on it. Imagine that!

Like all the early people, the Khoikhoi had to make everything they needed, because there were no shops then! They had to use whatever materials were freely available.

The Khoikhoi people were *nomads*. That means they did not live in one place for long. They moved their homes and their belongings every few months, when the seasons changed. By moving around, they could always live near good grazing. Fresh green grass and trees meant there would be leaf-eating animals around to hunt. I

also meant there would be good food around for themselves, and for their goats to eat.

Read the story carefully for clues on which materials were used to make a traditional Khoikhoi house.

Heitsi moves house

Heitsi's clan is on the move again. A few days ago, the clan packed up all their belongings and started their long trek to the place that will be their home for the summer months. The place where they lived had become dry and dusty and it was becoming more and more difficult to find good things to eat. They took apart their hut, which they will rebuild when they reach their destination.

During the long trek, everyone has to help carry things. Heitsi is carrying his own sleeping mat and *karos*, and his hunting weapons. He also has to keep an eye on the goats in case they wander too far from the clan.

After many days of walking, they arrived at the place that would be their new home. Now they can rebuild their house.

The framework of the house must be strong so that the house will stand firm. Heitsi's mother and aunties have found some young trees nearby and are cutting long, thin branches that will be perfect for making a frame for the house. Once they have cut the branches, they strip off the leaves.

The men bend the flexible branches into crescent (half-moon) shapes and tie them together with flexible strips of tree bark. This is how they build a dome-shaped framework for the house.

Can you see the framework of tree branches? Can you see what the house is made of?



Women attaching the reed mats to the framework.

Once the framework is built, it is ready to be covered with reed mats. For this reason the house is called a *matjieshuis* (mat-house). Heitsi's mother and aunties made the mats by threading reeds together with string that she made from the long thin leaves of palm trees.

The whole family has to help with the floor of the house. They bring clay from a nearby river and Heitsi's mother makes the floor by stomping down the wet clay with her feet. Once the clay has dried, the floor will be smeared with animal manure. This is not as disgusting as it sounds - the manure seals the clay to prevent it from becoming sandy and dusty.

A fire-hole will be dug in the middle of the floor, with sleeping hollows (about 15 cm deep) around it. Soft plant material will be placed in the sleeping hollows, and this will be covered with mats and *karosses* to make comfortable beds for Heitsi and his family.

Heitsi loves his portable home. It is the perfect shelter. In hot, dry weather, the openings between the reeds allow air to circulate inside the house to keep it cool. It also lets in light. He knows that when the rains come and the reed mats get wet, the reeds will absorb water and swell out. Then they will seal tight and protect the inside of the house against leaks. During the cold months, the inside of the house will also be lined with animal skins to make it extra warm and comfortable..



A matjieshuis covered with material.

ACTIVITY: Thinking about Hetsie's *matjieshuis*

QUESTIONS:

1. In the story we learnt how many different traditional materials were used by the Khoikhoi when they built their portable homes. Make a list of all the materials you can find in the story, and say how they were used. Use the table below for your list.



Type of traditional material	How was the material used?

2. What does it mean when we say Heitsi's house is *portable*?

3. Write a paragraph to describe the materials and methods used by Heitsi's family to keep their home warm and dry during winter.

4. How does Heitsi's mother strengthen the floor of the *matjieshuis*?

5. Look at all the pictures of modern 'houses' below. Which one is the most like Heitsi's house? Why do you say so?



A brick house.



A caravan.



A tent.

6. Draw a picture of the floor plan of Heitsi's house.

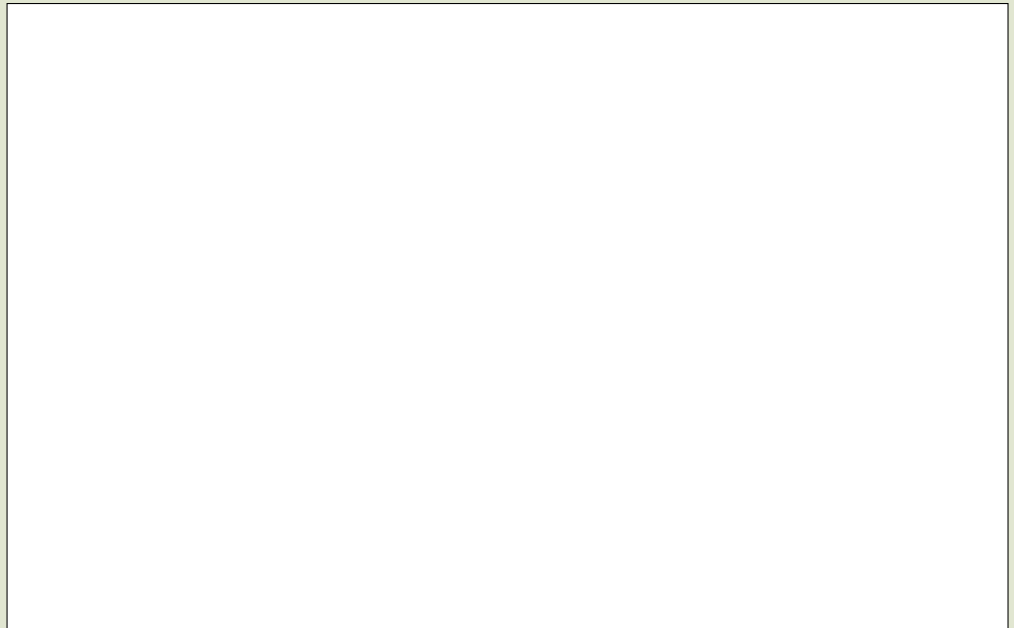

7. If you have time in class, build a model of Heitsi's house, using any suitable building materials.

We saw that Hetsie's family used grass to make the reed mats for their *matjieshuis*. In Africa, many people make objects by using plant products, called plant fibres. The people weave and stitch the plant fibres together to make different objects, such as reed mats, baskets, or even thatch to make a roof for a house. This is also a type of traditional processing.



A woman weaving a grass basket.



*A man weaving a reed mat.*³

ACTIVITY: Identifying objects made from plant fibre

INSTRUCTIONS:

Each of the following pictures shows an object made from plant fibre.

Identify what it is and how the people are using these objects



Object made from plant fibre	Description
 <p data-bbox="392 667 405 689">4</p>	<p data-bbox="866 398 1278 589">A Zulu "Ukhamba" beer basket for holding and storing Zulu beer. It is made by weaving grasses together.</p>
	
 <p data-bbox="392 1420 405 1442">5</p>	
 <p data-bbox="392 1796 405 1818">6</p>	



KEY CONCEPTS

- Natural materials come from plants, animals or the Earth
- Raw materials are materials that have not been processed.
- Processed materials are raw materials that have been changed or refined by humans.
- Humans have been processing materials from the earliest times.
- In Africa, people have processed materials for hundreds of years, for example to make clay pots and woven products.





REVISION:

1. What are raw materials?

2. What are natural materials?

3. What are processed materials?

4. Which processing method did the Khoikhoi people use to make wood and bone hard and strong?

5. Where did the Khoikhoi people find the material that they used to make their homes?



6. How can sand and clay be made stronger if we want to use it to build a house?

7. Look at the picture of a *matjieshuis* below. It is an old one and it was made differently to the one Hetsie's family made as this one does not use reed mats, but rather bushes that have been tied onto the frame. Which method do you think is better and why?



An old matjieshuis. 7

8. Making objects out of plants is a traditional African process. There are different ways of doing it and different parts of the plants which can be used. The three pictures below all show photos of woven products, but they have been made using different plants parts. Write a description of each and say what kind of object you think it might be used for.

Woven product	Description
 <p data-bbox="467 992 480 1016">8</p>	
	
	

9. How is this woman using a woven product? Think about if you, or anyone in your family, uses any woven products in your daily life and write them down too.



*A woman from Uganda.*⁹

Chapter 1 Plants and animals on Earth

1. <http://www.flickr.com/photos/8047705@N02/5563610502/>
2. <http://www.flickr.com/photos/scornish/1764354868/>
3. <http://www.flickr.com/photos/jdlrobson/3308174037/>
4. <http://www.flickr.com/photos/andreagp/5350324509/>
5. <http://www.flickr.com/photos/laszlo-photo/2062181707/>
6. <http://www.flickr.com/photos/greencolander/497200604/>
7. <http://www.flickr.com/photos/duckydebs/4993491739/>
8. <http://www.flickr.com/photos/tensafefrogs/3774252528/>
9. <http://www.flickr.com/photos/bexymitten/2316726560/>
10. <http://www.flickr.com/photos/usfwspacific/4967557703/>
11. <http://www.flickr.com/photos/2009seasons/4912107616/>
12. <http://www.flickr.com/photos/reurinkjan/3068136309/>
13. <http://www.flickr.com/photos/38485387@N02/3580781379/>
14. <http://www.flickr.com/photos/49937157@N03/4583150426/>
15. <http://www.flickr.com/photos/namibnat/4949237492/>
16. <http://www.flickr.com/photos/nakrnsm/3510513285/>
17. <http://www.flickr.com/photos/fpat/3801642722/>
18. <http://www.flickr.com/photos/47108884@N07/4435268109/p/2491117296/>
19. <http://www.flickr.com/photos/selago/3342254879>
20. http://www.flickr.com/photos/calliope/1223972901/*http://www.flickr.com/photos/marik0/2793709707/*http://www.flickr.com/photos/aloshbennett/419049451/*http://www.flickr.com/photos/yuko_okuy/5660087225/*http://www.flickr.com/photos/s58y/4415406430/
21. <http://www.flickr.com/photos/aloshbennett/419049451/>
22. <http://www.flickr.com/photos/s58y/4415406430/>
23. <http://www.flickr.com/photos/ngader/246601266/>

24. <http://www.flickr.com/photos/wheatfields/3409167144/>
25. <http://www.flickr.com/photos/aaronpk/5031972797/>
26. <http://www.flickr.com/photos/crabchick/2548879995/>
27. <http://www.flickr.com/photos/thomasguest/6646160791/>
28. <http://www.flickr.com/photos/44603071@N00/3538530801/>
29. <http://www.flickr.com/photos/44603071@N00/3538531523/>
30. <http://www.flickr.com/photos/nagaon/3264833217/>
31. http://www.flickr.com/photos/dad_and_clint/6122947684/
32. <http://www.flickr.com/photos/pictographic/4783445162/>
33. <http://www.flickr.com/photos/mcpig/2203669161/>
34. <http://www.flickr.com/photos/http2007/1149137981/>
35. <http://www.flickr.com/photos/21923568@N00/234866027/>
36. <http://www.flickr.com/photos/mikebaird/4677151352/>
37. <http://www.flickr.com/photos/bobistraveling/3238994233/>
38. <http://www.flickr.com/photos/usfwspacific/4967557703/>
39. <http://www.flickr.com/photos/mikebaird/377965007/>
40. <http://www.flickr.com/photos/tristrambrelstaff/231188253/>
41. <http://www.flickr.com/photos/8116305@N04/5395457446/>
42. <http://www.flickr.com/photos/50562790@N00/2110796622/>
43. <http://www.flickr.com/photos/nuskyn/4145250156/>
44. <http://www.flickr.com/photos/haengine/3982256034/>

Chapter 3 Skeletons as structures

1. <http://www.flickr.com/photos/laffy4k/93484023/>
2. <http://www.flickr.com/photos/laffy4k/93484023/>
3. <http://www.flickr.com/photos/kingdavera/2269448455/>
4. <http://www.flickr.com/photos/36319440@N05/3564169533/>
5. <http://www.flickr.com/photos/francehousehunt/4202164809/>
6. <http://www.flickr.com/photos/nrmadriiversseat/6937142471/>

7. <http://www.flickr.com/photos/mckaysavage/3984059889/>
8. <http://www.flickr.com/photos/artotemsco/5884762761/>
9. <http://www.flickr.com/photos/wwarby/4859127169/>

Chapter 4 Food chains

1. <http://www.flickr.com/photos/naturegeak/618885203/>
2. <http://www.flickr.com/photos/magnusbrath/5395960611/>
3. <http://www.flickr.com/photos/flowcomm/2768960890/>
4. <http://www.flickr.com/photos/amanderson/4686372028/>
5. <http://www.flickr.com/photos/flowcomm/2768960890/>

Chapter 5 Life cycles

1. <http://www.flickr.com/photos/26942787@N03/2527325203/>
2. <http://www.flickr.com/photos/snapr/468246966/>
3. <http://www.flickr.com/photos/scottzona/5672890582/>
4. <http://www.flickr.com/photos/richardsphotogallery/6913278810/>
5. <http://www.flickr.com/photos/26942787@N03/2527325203/>

Chapter 1 Metals and non-metals

1. <http://www.flickr.com/photos/txberiu/2608488360/>
2. <http://www.flickr.com/photos/bazzadarambler/4691025268/>

Chapter 2 Uses of metals

1. <http://www.flickr.com/photos/kb35/2289942750/>
2. <http://www.flickr.com/photos/julied/5843340917/>
3. <http://www.flickr.com/photos/mauroescritor/6342745960/>

Chapter 3 Processing materials

1. <http://www.flickr.com/photos/dinnerseries/5884182567/>
2. <http://www.flickr.com/photos/kfoodaddict/6119407106/>
3. <http://www.flickr.com/photos/bptakoma/3402706921/>
4. <http://www.flickr.com/photos/mrfussyfont/4858831798/>
5. <http://www.flickr.com/photos/98675081@N00/2840478281/>
6. <http://www.flickr.com/photos/acwa/4604675692/>
7. <http://www.flickr.com/photos/artbystevejohnson/5513243322/>
8. <http://www.flickr.com/photos/daquellamanera/2709815541/>

Chapter 4 Processed materials

1. <http://www.youtube.com/watch?v=-NlhtLDR-3s&feature=related>
2. <http://www.flickr.com/photos/69103026@N00/2060032435/>
3. <http://www.flickr.com/photos/miusam/428068620/>
4. <http://www.flickr.com/photos/37743612@N05/4685092625/>
5. <http://www.flickr.com/photos/cameronparkins/210589508/>
6. <http://www.flickr.com/photos/christianhaugen/3657221524/>
7. <http://www.flickr.com/photos/9511023@N03/4279851038/>
8. <http://www.flickr.com/photos/rvoegtli/5404885227/>
9. <http://www.flickr.com/photos/amslerpix/6637298391/>