

A vegetable garden for all

Manual "A Vegetable
Garden for All" 5th Edition

FOOD AND AGRICULTURE
ORGANIZATION OF THE
UNITED NATIONS



A vegetable garden for all

Manual "A Vegetable
Garden for All"
5th Edition



FOOD AND AGRICULTURE
ORGANIZATION OF THE
UNITED NATIONS

MANUAL

Manual "A Vegetable Garden for All" 5th Edition.
Zero Hunger Challenge- Antigua and Barbuda

J.R. Deep Ford

FAO Coordinator- Sub-Regional Coordinator for the Caribbean

Deanne Ramroop

FAO Consultant

Vera Boerger

Land and Water Officer

FAO Subregional Office for Mesoamerica

Vyjayanthi Lopez

Plant Production and Protection Officer

Subregional Office for the Caribbean

Alberto Pantoja

Plant Production and Protection Officer

Regional Office for Latin America and the Caribbean

Juanita James

National Coordinator

Zero Hunger Challenge, Antigua and Barbuda

Owolabi Elabanjo

Backyard Gardens Coordinator

Zero Hunger Challenge, Antigua and Barbuda

The designations employed and the presentation of material in this information product do not imply the expression of any opinion whatsoever on the part of the Food and Agriculture Organization of the United Nations (FAO) concerning the legal or development status of any country, territory, city or area or of its authorities, or concerning the delimitation of its frontiers or boundaries. The mention of specific companies or products of manufacturers, whether or not these have been patented, does not imply that these have been endorsed or recommended by FAO in preference to others of a similar nature that are not mentioned.

The views expressed in this information product are those of the author(s) and do not necessarily reflect the views or policies of FAO.

ISBN 978-92-5-108105-1 (print)
E-ISBN 978-92-5-108106-8 (PDF)

© FAO, 2014

FAO encourages the use, reproduction and dissemination of material in this information product. Except where otherwise indicated, material may be copied, downloaded and printed for private study, research and teaching purposes, or for use in non-commercial products or services, provided that appropriate acknowledgement of FAO as the source and copyright holder is given and that FAO's endorsement of users' views, products or services is not implied in any way.

All requests for translation and adaptation rights, and for resale and other commercial use rights should be made via www.fao.org/contact-us/licence-request or addressed to copyright@fao.org.

FAO information products are available on the FAO website (www.fao.org/publications) and can be purchased through publications-sales@fao.org.

Background

A Vegetable Garden for All is a self-instruction manual in family horticultural production, prepared originally by the Food and Agriculture Organization of the United Nations Regional Office for Latin America and the Caribbean, in support of the Technical Cooperation Network for Food Production.

The objective of this manual is to present a technology suitable for family horticultural production and consumption. It is a manual for small-scale farmers, school teachers, children, and urban and peri-urban families with access to small plots of land. Better nutrition and better incomes can be achieved through families working in horticultural production.

The Manual was first issued in 1990, and was used by several programmes, institutions and farmers' groups. The second edition (2002) was focused on increasing food security and providing a balanced diet to disadvantaged farmers and peri-urban populations in Central America, within the framework of the Special Programme for Food Security (SPFS/PESA).

This expanded, third edition (2009) has been developed within the framework FAO/MANA as an activity of project UTF/COL/027/COL. It provides a practical, methodological guide for setting up family gardens for the production of nutritious, safe food crops, that crops that would contribute fibres, minerals and vitamins to the diets of populations affected by food insecurity. It is a useful tool for all projects that work to improve the food security of rural, urban and peri-urban families.

This 5th edition (2013) has been developed within the framework of the Zero-Hunger Challenge (ZHC) in the Caribbean. It is adapted to Caribbean conditions, using experiences from the ZHC pilot in Antigua and Barbuda during 2013.

Authors

The following FAO consultants were involved in the compilation and preparation of the technical material in the 1st Edition of the Manual: Rubén Oliva and Marina Gambardella. The authors would like to express their thanks for collaboration of the participants in the Course/Workshop: “Technological reproduction of horticultural seeds for small farmers” organized by INTA Argentina and FAO, as well as various technical and communication Specialists, consultants and graphic designers (Maria Beatriz Peñafort, Virginia Lattes, Cecilio Moron and Gonzalo Ibañez, Arturo Fernandez and Francisca Rodriguez) who contributed to the first edition.

The 2nd Edition (2002) formed part of the activities of several Special Food Security Programmes for Central America, while the third edition (2009) was prepared from the component Market Gardens and Food and Nutritional Security of the project UTF/COL/027/COL on Food Security and Good Agricultural Practices for the Rural Sector in Antioquia. Contributions from various consultants and programme staff that collaborated on the 3rd Edition (Sara Granados, Miguel Gomez, Mónica Duque, Diego Giraldo, Arturo Andrés Alarcón, and Soledad Lama) and the technical supervision and editing of Juan Izquierdo (Plant Production and Protection Officer for Latin America and the Caribbean) are gratefully acknowledged.

The fifth edition (2013), has been adapted for the Caribbean Sub-region, with key inputs being provided by Ms. Deanne Ramroop, FAO Consultant, Ms. Vera Boerger, Land and Water Officer (FAO-SLM, Panama) and Ms. Vyjayanthi Lopez, Plant Production and Protection Officer (FAO-SLC, Barbados). Contributions from Ms. Juanita James (National Coordinator, Zero-Hunger Challenge, Antigua and Barbuda) and Mr. Owolabi Elabanjo (Backyard Gardens Coordinator, ZHC, Antigua and Barbuda) are acknowledged. The drawings and layout for the third and fourth editions were the responsibility of the Graphic Designer, Marcia Miranda. The assistance provided by Mr. Alberto Pantoja, Plant Production and Protection Officer (FAO-RLC) is greatly appreciated.

Contents

Chapter1 : Why do we need a vegetable garden?	1
Chapter 2 : What is needed to plant a vegetable garden?	17
Chapter 3 : Why is it important to take care of the soil in the vegetable garden?	41
Chapter 4 : How do you start a vegetable garden?	75
Chapter 5 : Vegetable propagation and sowing	93
Chapter 6 : What is hydroponics?	133
Chapter 7 : How do we look after the garden??	147
Chapter 8 : Harvesting, storing and processing of the vegetables	187
Chapter 9 : Breeding poultry and rabbits and feeding them from your home garden (growing their food using hydroponics)	209
Information Chart	247

Chapter 1

Why do we need a vegetable garden?

We don't have much money and our family needs food to eat. Why don't we grow our own vegetables?

Great idea!! Besides, I heard that vegetables are good for children.

Grow our own vegetables? how?



Read this manual to learn how to grow the food your family needs for food security.

Having a home garden means having:

1. A low-cost, healthy diet
2. Food all year long
3. A chance to make some money



If we start a vegetable garden, we can grow, prepare and eat our own fruits and vegetables



The vegetable garden will help your family to be better nourished and healthier.

A truck needs energy to work.
This energy is provided through fuel.

Children need energy to grow strong and healthy.
They get this energy from food.

In order to be well-nourished and healthy, the entire family needs energy and nutrients that food provides.



The food groups

Foods can be grouped into seven major groups according to their nutritional characteristics. The seven varieties of food are shown below.



1- STARCHY FOODS

Starchy foods are our main source of carbohydrate and includes the cereals (rice, wheat, and maize/corn) and the root vegetables (potatoes and cassava). Grains supply us with large amounts of nutrients and provide the energy we need through starch. As grains are the food base, wholegrain flour and root crops that are richer in fibre are the best choice.

2- VEGETABLES

This group includes: carrots, lettuce, tomatoes, cabbage, pumpkin, broccoli, cauliflower, etc. Vegetables contribute an important amount of water to the body, as well as vitamins and minerals that help to digest nutrients and ensure healthy skin and body weight. Vegetables, prevent heart diseases and cancer, and contribute to good health in general.

3- FRUITS

Fruits help children to grow, have a healthy skin and avoid infections. It is better to eat nutritious fruits, such as guava, pawpaw, mango and oranges. Fruit should be eaten freshly harvested and neither too ripe nor too green. Fruits contain fibre, which is important for good digestion. They help to prevent constipation and diseases like cancer.

Fruits and vegetables are regulating foods, because they provide large doses of vitamins and minerals not found in other foods, and they also help other nutritious, energy-rich foods to carry out their functions properly.

4- FOOD FROM ANIMALS

Meat provides one third of the proteins needed for the growth of children and for building the body's defence system. Adults need meat for healthy brain, skin, muscles, nails and hair. Beef, pork, poultry and fish belong to this group. Other sources of protein are eggs, dried legumes and fruits, and vegetable mixes. Milk products are the main source of calcium, minerals and proteins that contribute to the development of teeth, bones and muscles...

Milk and meat are building foods because they provide proteins that help to build the body's tissues, for example, muscles.

5- PEAS, BEANS AND NUTS

Dried peas, beans, and nuts are good sources of protein, starch, fiber, iron, calcium and minerals.

6 -FATS AND OILS

Fats are the main source of energy and energy storage in the body. They make up the structure of some tissues. Fat makes food taste good and help develop the sense of “taste” through the pleasing sensation they produce on the palate. Some fats are: avocado, oil, butter, pork crackling, lard and sauces. If consumed in excess, they can contribute to heart disease.

7- SUGARS AND SWEETENERS

Sugar is a good source of quick energy, i.e. it starts providing energy from the moment it is consumed. It gives colour to the meals and enhances their flavours, making food tastier. This group includes white and brown sugar, honey and molasses.

Too much sugar can result in diseases like obesity and diabetes.

Starch, fat and sugar groups are calorific foods, that is foods which provide energy needed for growth and for the formation and nourishment of tissues.



Five servings a day of different kinds of fruit and vegetables will help the physical and mental development of children, and prevent diseases in both, children and adults.

Let's find out if you remember what you've learned.

Test 1

Fill in the following table showing to what group these foods belong:
Bread, potatoes, fish, milk, lettuce, carrots, sugar, oil, oranges, eggs and onions.

You will find several tests like this one! Find the answers in the text.

Building foods	Regulating foods	Energy foods
_____	_____	_____
_____	_____	_____
_____	_____	_____
_____	_____	_____



For a good nutrition you should always eat one or two foods from each group every day.

Building foods: Build the tissues of the body as muscles, bones and teeth.

Energy foods: Provide the energy needed to work.

Regulating foods: provide vitamins, such as vitamin "A" , which is essential for good eyesight, vitamin "C", which keeps gums and blood vessels healthy. They contribute minerals like iron, which is part of the red blood cells. They also contain fibers, which improve digestion.



The answers to Test 1

Building foods	Regulating foods	Energy foods
Fish	Lettuce	Bread
Milk	Carrots	Potatoes
Meat	Oranges	Sugar
Eggs	onions	oil

Your vegetable garden will give you mainly regulating foods, some building foods and energy foods

The vegetables that you grow in your garden will be:

- fresher
- healthier
- more nutritious
- less expensive



Test 2

Write the most suitable word on the dotted line. Choose one of the words in brackets()

1- Good health means a..... diet. (varied - plentiful)

2- My vegetable garden provides..... that are fresher.(proteins - vegetables)

3-..... foods supply vitamins, minerals and fibres. (building -regulating)

What do vegetables and fruits provide?

Carbohydrates
For example: potatoes, sweet potatoes, cassava, bananas and corn.

Proteins
For example: kidney beans, peas, lima beans, papaya, tree tomatoes.

vegetables and fruits

Vitamins and minerals
Many vegetables are very rich in Vitamins A and C, folic acid and iron.
For example: blackberries, cucumbers, broccoli, and green beans.



Fibres
improve the functioning of the digestive system and prevent colon cancer. For example: Swiss chard, passion fruit.





The answers to Test 2 are:

1. varied
2. vegetables
3. regulating

Vegetables can also be grouped by colour:

	COLOUR	CONTENT	HEALTH IMPACT
	PURPLE	Antioxidants and phytochemicals	Slow the ageing process. Prevent the formation of cancerous cells. Help prevent memory loss
	RED	Lycopenes, anthocyanins and phytochemicals	Help prevent memory loss Prevent cancer Prevent urinary tract infections

	<p>ORANGE AND YELLOW</p>	<p>Beta-carotene or Pro-vitamin A, Vitamin C, Potassium</p>	<p>Keeps eyesight good Maintains skin healthy Strengthens the immune system Helps skin healing and regeneration processes</p>
	<p>GREEN</p>	<p>Folic acid, Lutein, Vitamin C, Potassium.</p>	<p>Helps the foetus to develop normally. Helps keep eye sight good. Helps skin healing and regeneration processes.</p>
	<p>WHITE</p>	<p>Allicin, Potassium</p>	<p>Help prevent high cholesterol. Lower blood pressure.</p>

Always eat a combination of two or more vegetables of different colours.

Planting vegetables means eating better and saving money

Home-grown vegetables are:

- fresher
- healthier
- more nutritious
- less expensive

A vegetable garden has many benefits:

- a) It provides a variety of food sufficient for the whole family all year round or for several months.
- b) It improves income over the long term through the sale of vegetables.
- c) It improves or maintains the whole family well nourished.
- d) It strengthens family bonds.
- e) It enables food to be grown safely and healthily.
- f) It promotes diversity of cultivation, in vegetables, fruit trees, legumes and poultry.



The whole family can help in the vegetable garden



The younger children:

- Remove stones
- Weed
- Catch worms and bugs
- Help with the harvesting

The older children:

- Weed and plough the soil
- Plant
- Water
- Harvest

The parents:

- Teach their children how to perform the tasks and work together to produce a fine vegetable garden

Make the vegetable garden of benefit to the whole family:

- Making the basic needs of food, home and clothing a priority
- Learning to assign tasks to each member of the family
- Teaching values such as discipline, use of free time, responsibility and patience
- Planning the family budget

You already know a lot about vegetable gardens. Let's see how much you have learned and remembered



- 1- The relationship between food and good health
- 2- The nutritional qualities of vegetables
- 3- The importance of a vegetable garden

Test 3

In the circle next to each sentence, place a "T" if the statement is true, and an "F" if the statement is false, as given in the example

Example

Food provides the energy for strong, healthy growth

Exercises

- 1- Energy is needed perform any activity
- 2- It isn't necessary to eat food from every group
- 3- Many nutritius food can be grown in the vegetable garden
- 4- Vegetables grown at home cannot be preserved
- 5- potatoes and bred contain carbohydrates
- 6- Keeping a vegetable plot helps to save money
- 7- Parents must teach their children how to work in the vegetable garden
- 8- Small children can help in the vegetable garden

If all your answers were correct, you can step up the first rung of the ladder. Congratulations!

Answers to test 3

- 1- T
- 2- F
- 3- T
- 4- F
- 5- T
- 6- T
- 7- T
- 8- T

If two or more of your answers were incorrect, please review the topics in Chapter 1

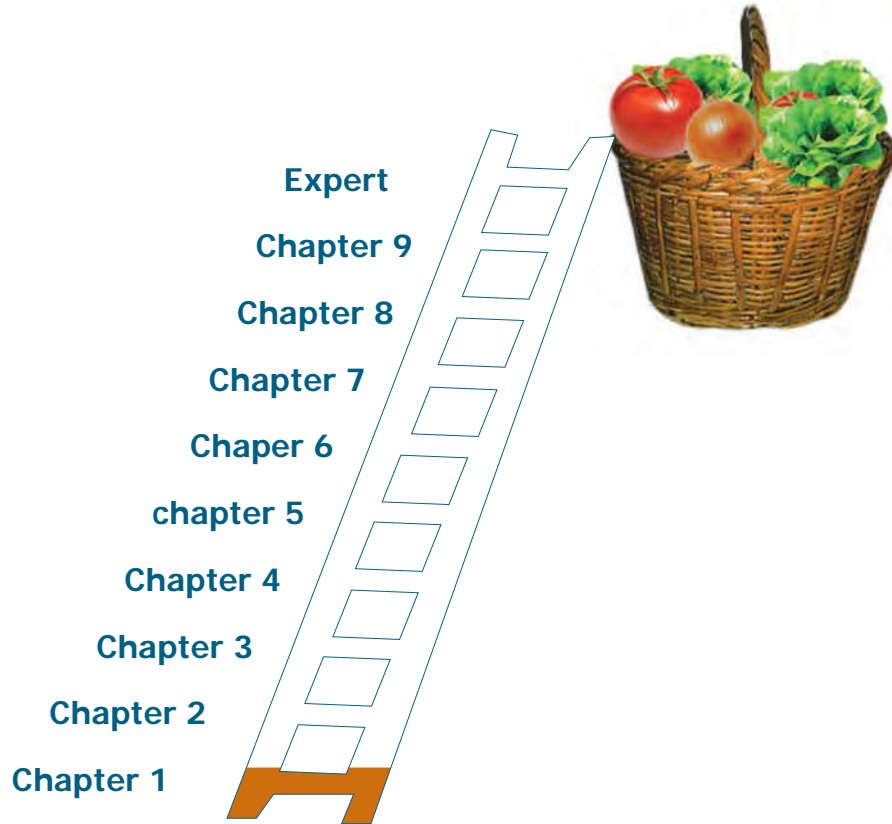

Chapter 2

What is needed to plant a garden?

Do you want to plant a garden?

Yes.

Then let's see how to plant one.



Enthusiasm and willingness are the most important things, and you will also need other elements.

In order to plant a garden you need:

- 1- A garden plan.
- 2- Available land.
- 3- Some garden tools.



... and the knowledge you will find in this manual!!!

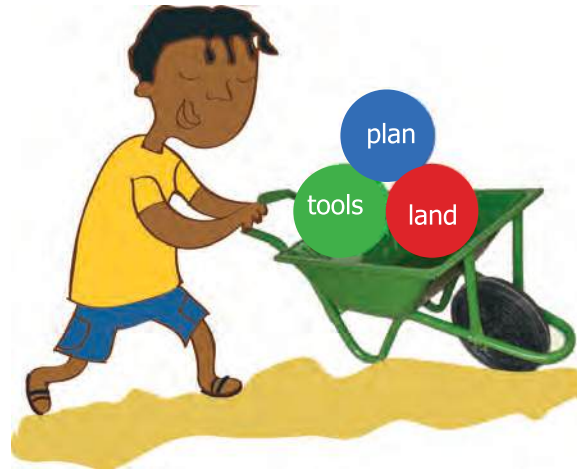

It is important to know what we are eating and to use the garden for improving our nutrition

Before planning the garden let's find out what the family needs.

In order to know what we need per month we prepare a shopping list:
Let's find out how much vegetables our family and the community eat (how much do they consume approximately)

Knowing the demand makes it easier to plan our garden, planting those vegetables we already know and adding new ones, which will improve our nutrition



Species	Quantity
Carrot	
Lettuce	
Beetroot	
Onion	
Green beans	
Cauliflower	
Coriander	
Parsley	
Other	

After doing some research with our family and the community, let us find out the real demand by asking the health service or a doctor

1- What is a garden plan?

In order to make a garden plan, you will have to answer the following questions:

Which are the vegetables that grow best in the area?
What is the sowing and harvesting time of each one?

Which are the vegetables that you would like to plant?

How much do you want to produce of each vegetable?
Only enough for family use?
Enough to sell?



If there are any doubts, ask the local technician.



You will find a lot of help in this Manual.



There is information at the end of this manual on how much each kind of vegetable produces in 10 m. furrows so you will be able to calculate how much land is needed for each vegetable.

.. As you already know, not all vegetables grow in the same season.

It is necessary to know the local climate.
Talk with your neighbours.
Write the dates here

In tropical countries write down:
Rainy season _____
Dry season _____



Some vegetables need to be planted in warmer seasons and others are more resistant to cold weather. Look at the chart at the end of this manual to find out which they are.



As you know, not all vegetables can be planted at any altitude.

When planning our vegetable garden we should know at which altitude above sea level we are located and know what is possible to plant.

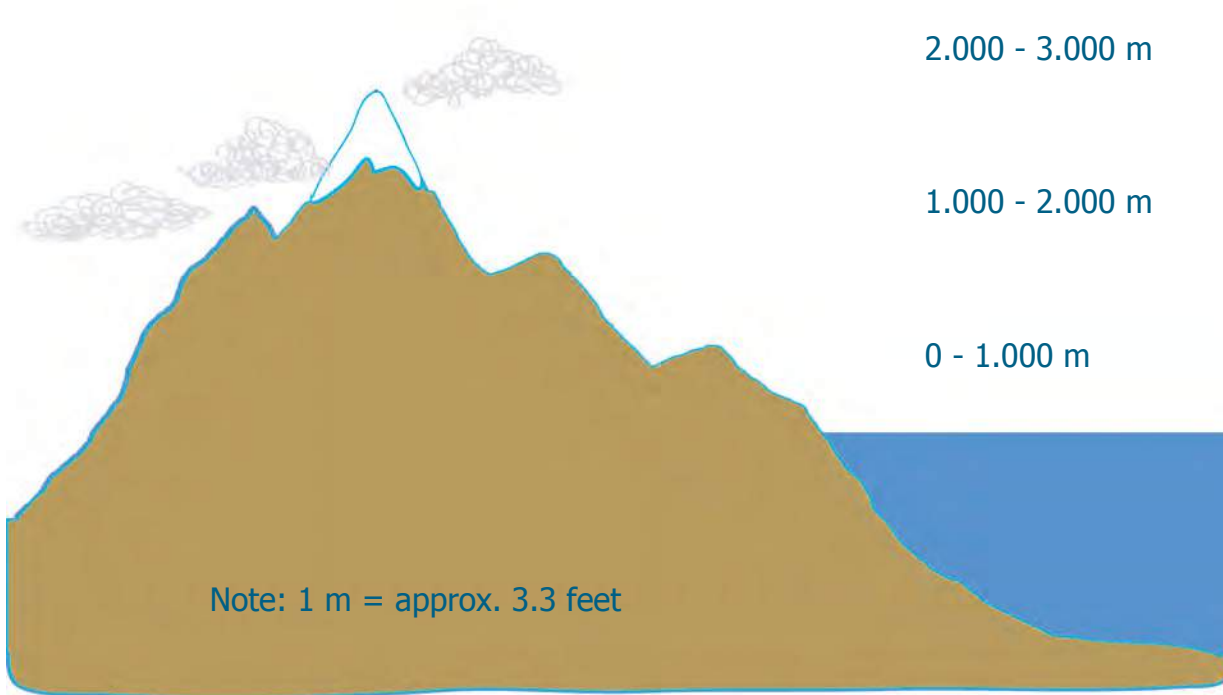

To start, it is better to choose well-known vegetables

You have probably already planted vegetables and know which grow best in your area. There are vegetables that are easier to grow than others and these are better to start with:

Easy vegetables:

- Swiss chard
- Lettuce
- Carrots
- Zucchini
- Pakchoi
- Cucumber
- Squash
- Cabbage
- Beans

You should try new plants little by little and in a short time you will be:
Expert horticulturists!



There are vegetables that occupy more space.

If the surface is limited, it is better to plant vegetables that occupy less space..

Large Surface	Small Surface
pumpkin potatoes beans	Leafy vegetables carrots

Test 4

- 1- Potatoes and beans occupy.....space. (a lot of - less)
- 2- If the land is small, it is preferable to plant.....
(carrots-pumpkin)
- 3- It is necessary to know the of the area, in order to know when to plant.
(climate-space)



We will continue with the garden plan. The following information is useful in planning your garden.

Garden plan:

- 1- Crop rotation
- 2- Inter-planting
- 3- Relay planting
- 4- Intercropping

Answers
to test 4



- 1- a lot of
- 2- carrot
- 3- climate

What is crop plant rotation?

It is not a good idea to always plant the same vegetables in the same place in the garden.

You should rotate your plants; this means to change the type of vegetables planted each season.

This way you will avoid:

- The depletion of the same nutrients in the soil.
- The appearance of many weeds, pests and diseases.

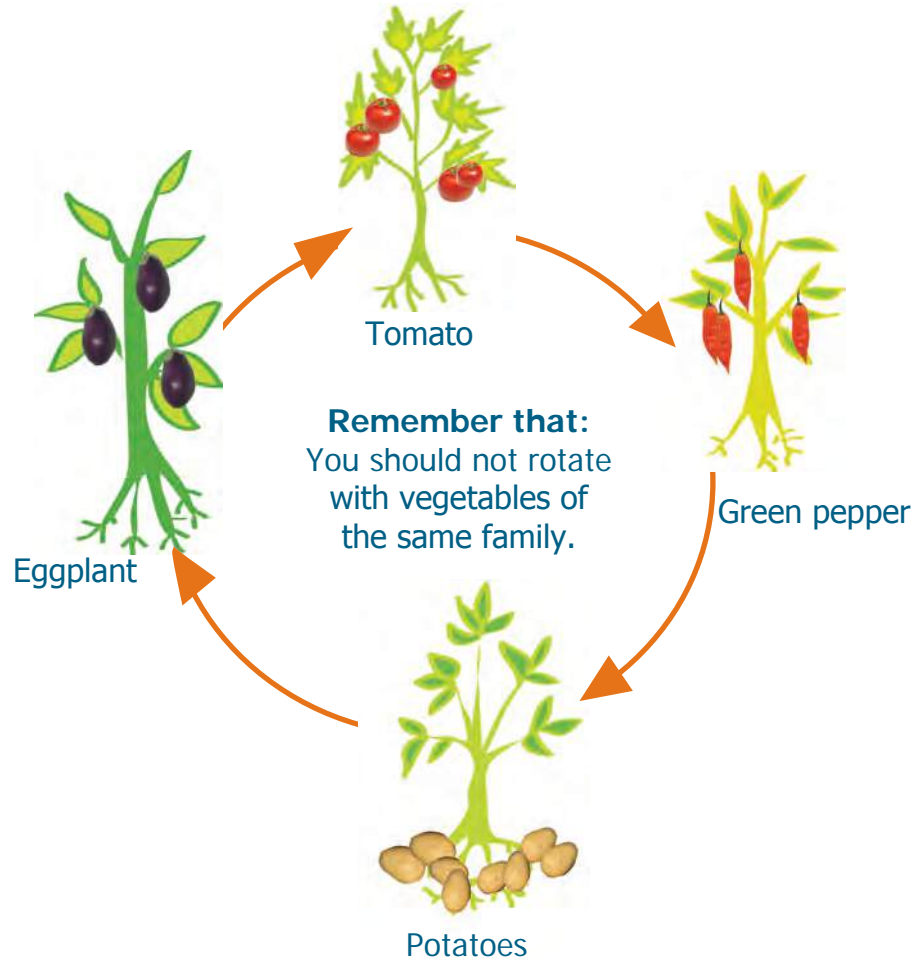

Vegetables are grouped into different families

Solanaceous Family:	Tomatoes Eggplant Green pepper Potatoes
Leguminous Family:	Peas Beans
Cucurbitaceous Family:	Pumpkin Melon Watermelon

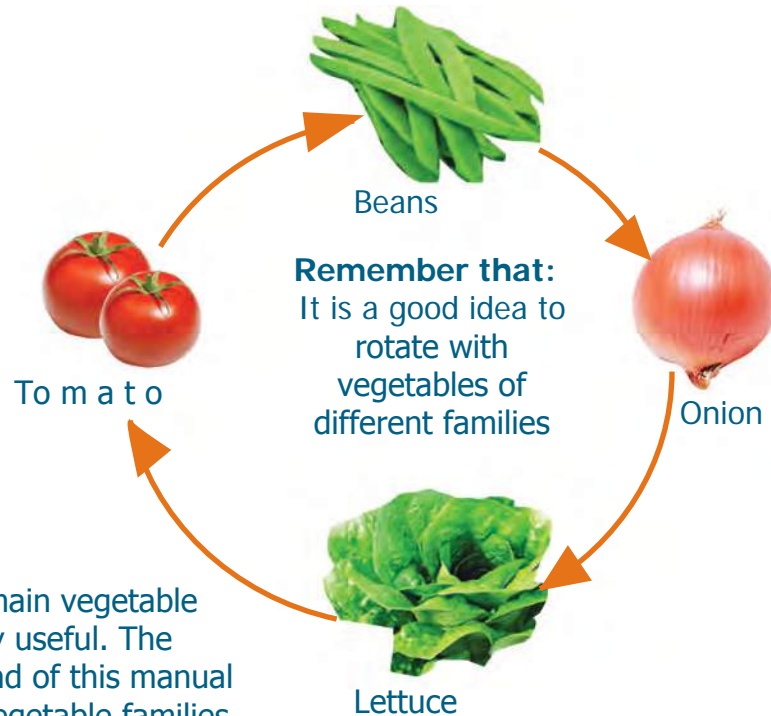

Knowing the main vegetable families is very useful. The chart at the end of this manual explains the vegetable families of all the vegetables you may wish to plant.

What is interplanting?

For example: it is possible to plant climbing vegetables on poles with low height vegetables.

It's planting two or more species in alternating rows.

By doing this you:

- Take better advantage of the land and minerals
- Have better weed control

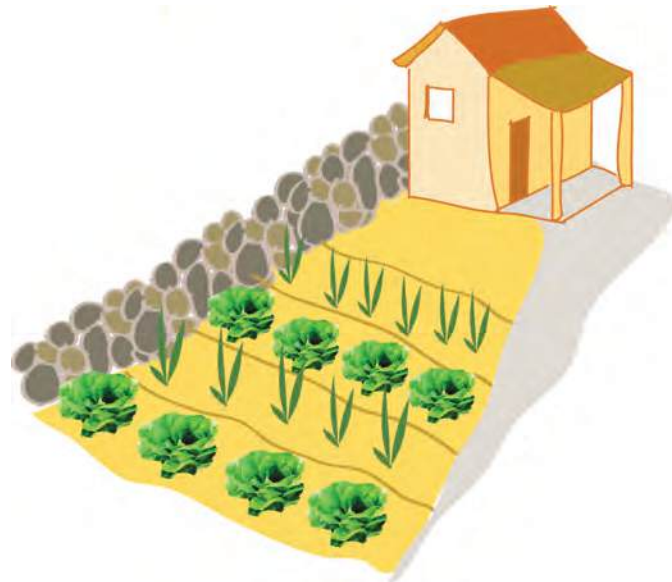

How do you relay plant?

Remember that there are vegetables that can be sown several times a year. With these it is possible to plant on different dates.

This is relay planting. This method lets you have continuous vegetable production. For example: you can sow seeds at 30 day intervals for the following vegetables: lettuce, swiss chard, and radish. So you will always have fresh vegetables!



Write down the sowing dates in the calendar.

It is not necessary to apply this for vegetables that store well for long periods, like pumpkin, onion, potato and garlic.



It is important to plan the sowing.

...It is important to keep in mind that for a productive garden you should at all times have seedlings.



Fill the bottle with substrate made of 1/2 of soil, 1/4 of sharp sand and 1/4 of compost.

Cover the seeds and water every 3 days.

In order to keep an active garden it is necessary to keep track of:

- Planting
- Transplanting
- Harvesting

That's why I always keep bottles with seedlings. So that my garden lasts!

Species	Days in seedbed	Seeds per bottle	Sowing frequency	Days to harvest
Lettuce	30-35	30	Weekly	30
Spinach	35	12	monthly	60
Tomato	45	9	fortnightly	100
Broccoli	30	30		45
Cauliflower	30	30	monthly	45
Cabbage	30	30	monthly	45
Celery	45	30		60



Early season crops:	Late season crops:
Radish Lettuce	Carrot Onion

It is possible to sow early season crop seeds and late season crop seeds.

This is intercrop planting and with this method you:

- Can take better advantage of space.
- Leave less room for weeds.

Test 5

Complete each sentence using one of the following words: **deep-same-fresh**

- 1- The same vegetable shouldn't always be planted in the.....place.
- 2- It is a good idea to rotate arooted vegetable by one with shallow roots.
- 3- Intensive planting lets you always have.....vegetables.



2- Available land

Size of the garden:

The ideal size of the garden depends upon the size of the land that you have, and how well you use it. If the space is very small, you won't be able to produce all the vegetables your family needs, but it will let you save money and always have fresh and nutritious vegetables.



Hydroponic container

Boxes

If you use your backyard garden properly you can increase the planting space

Green living walls

Answers for Test 5

- 1- same
- 2- deep
- 3- fresh

At the end of this manual you will find more useful information for a planting system for very small spaces



The garden should be well located, this is very important.

Look for the best location of the garden taking into account the following:

- As close to the house as possible, in order to avoid theft.
- Near a non- contaminated water source, for watering.
- With lots of sun!
- Away from high trees.
- Clean drainage or channels so that excess rainwater does not flood the garden or your neighbor's yard.
- Footpaths to walk on without stepping on the crops.



... protection is needed against wind, excess sun and high temperatures.

In windy areas, look for a place protected by trees or build some sort of protection.

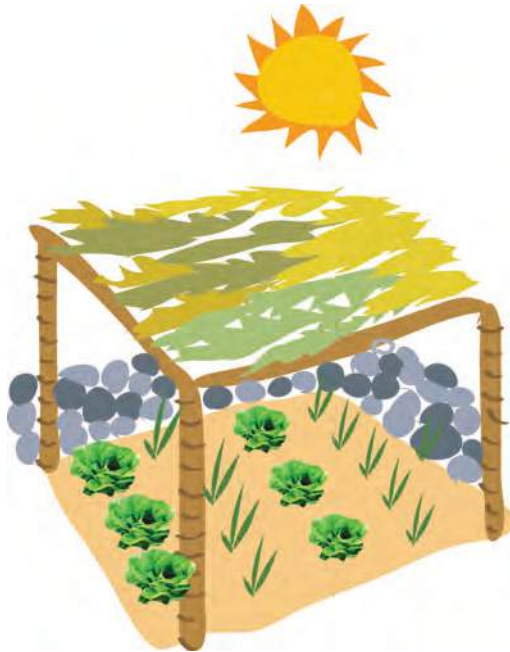

Shelters can be constructed with branches to obtain a semi shade.

3 - Some tools

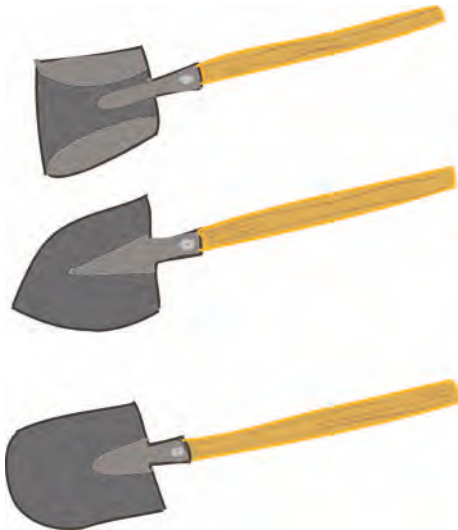

Spade - flat, to mark and to cut the soil when it is soft.

Spade - pointed, when the ground is hard.

Shovel - wide, for loading and unloading earth, compost, etc.

Keep all your tools clean and well sharpened. Wash them after every use then rub them with an oiled rag.



Garden - fork, to turn the soil and remove stones.

Hoe - to break up the soil, to break the crust, to remove weeds and to draw up furrows. The narrower the blade, the better it adapts to hard earth.

Rake - to break the soil crust, to remove lumps, to prepare the sowing bed and to cover the seeds.

Weeding hoe - to break the soil crust and to weed near the plant.





Dibbers or Transplanters - made from tree branches. Are useful for making holes where the seedlings will go and to hold the soil.

Trowel - to help move seedlings to their planting spot.

Watering can – to water seedlings and new plants with a light sprinkle. (A perforated can or a hose with sprinkler nozzle can also be used).



- 1- What are the necessary elements to plant a garden?
- 2- What is a garden plan?
- 3- What are the characteristics and location of the land?
- 4- Which tools are necessary?

Test 6

Place a "T" if the sentence is true and an "F" if it is false.

- 1- It is important to prepare a good garden plan before starting.
- 2- It is necessary to find out through the local technician which vegetables grow better in the area.
- 3- All vegetables must be cultivated when there is no danger of frost.
- 4- Rotating crops means to always plant them in the same place in the garden.
- 5- Rotating crops avoids the same nutrients being exhausted from the soil.
- 6- The tomato, potato, red pepper and eggplant are from the Solanaceous family.
- 7- Vegetables from different families cannot be planted together.

If the answers were all correct, you can go up another step. Congratulations!

Answers for test 6

- 1- T
- 2- T
- 3- F
- 4- F
- 5- T
- 6- T
- 7- F

If two or more answers were not correct, you should review the material in Chapter 2

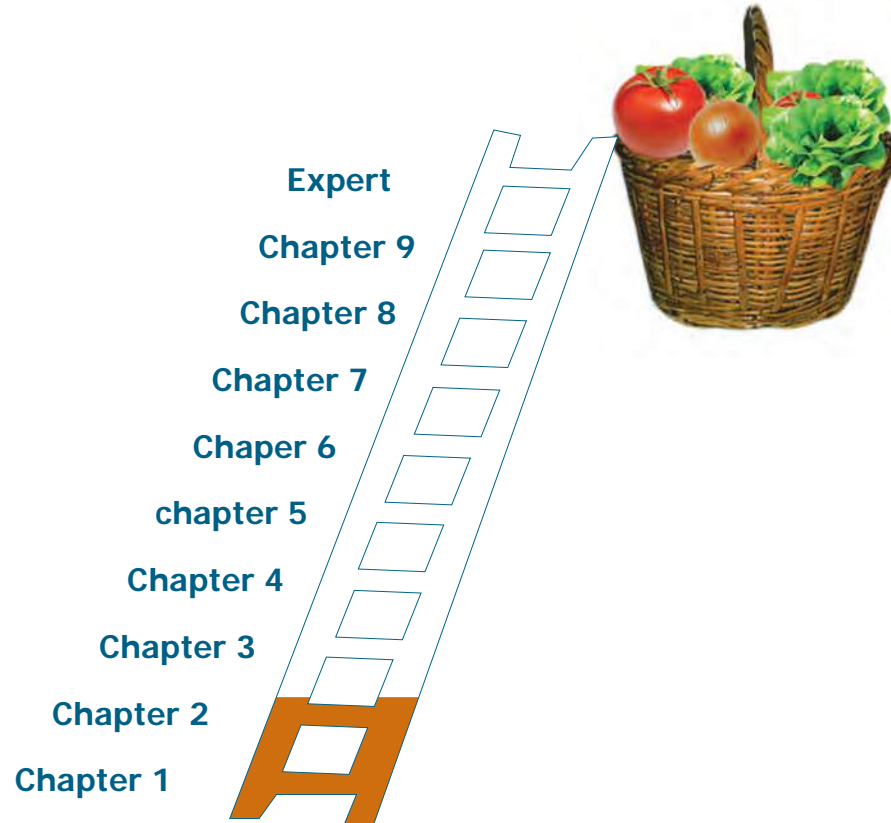

Chapter 3

Why is it important to take care of the soil in the garden?

If the carpenter does not take care of his hand saw.... it will break... and the carpenter will be left without work.

If the dairy farmer does not take care of his cows.... they will die... and he will be left without his dairy.

If the gardener does not take care of his soil.... the ground will die.... and he will be left without his crop.



The soil is a living thing that can also die if we don't take care of it.

The soil is alive



Although we do not see them because they are very small, the soil is inhabited by millions of insects and plants that are beneficial to your vegetables. These are microorganisms. If the microorganisms die, the soil also “dies” and will not be able to nourish plant growth. We must not destroy so quickly what took nature millions of years to create. It is important to take care of the soil and give it back the nutrients that were used to produce the harvest.



But first, let's see what goes on in the soil.

The microorganisms in the soil are almost always very busy decomposing plant and mineral waste.

They prepare the soil nutrients that serve as plant food.

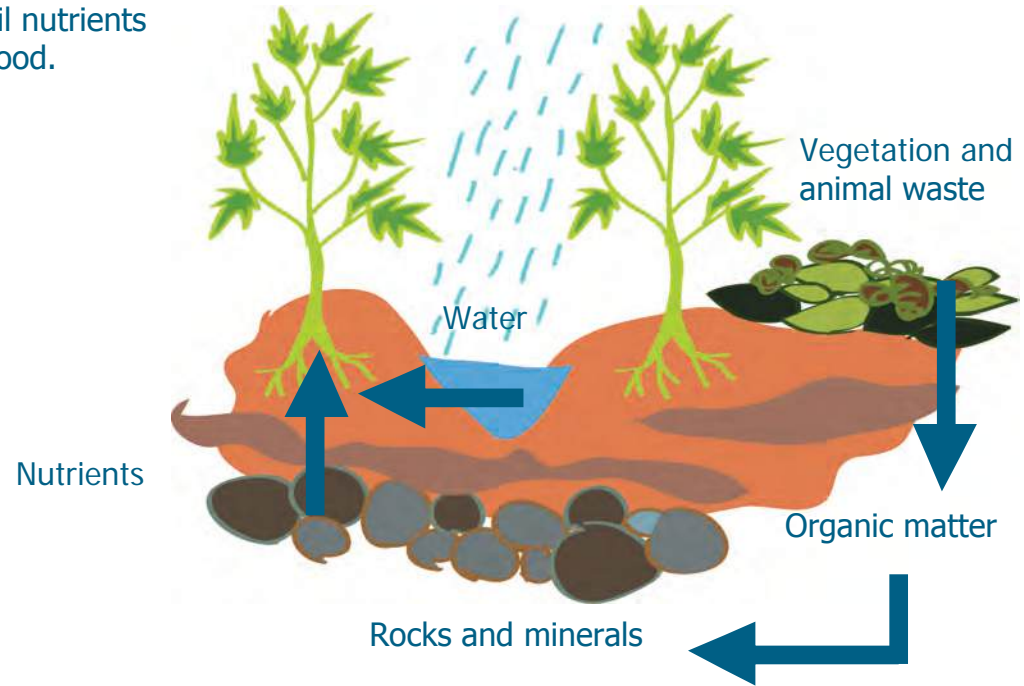

What is humus?

Humus is organic matter in its final state of decomposition. Decomposition is caused by microorganisms in the soil.

Soils rich in humus have many nutrients and are more porous.

Porous soils retain more water and are more fertile.



Important! One of the most essential jobs in your home garden is to add organic matter to the soil.

Why?
Organic matter:

- increases the capacity of sandy soils to retain water.
- softens heavy soils (clay), increasing aeration and improving root growth.
- serves as food for the soil organisms.

Where can organic matter for the home garden be obtained?



Sandy soils

The water drains very fast and dries more easily



Clayey soils



Soils with organic matter

There are many types of organic matter

- 1- Organic fertilizer or “compost”.
- 2- Worm humus.
- 3- Farm-animal manure.

All of these improve the soil but some have more advantages than others! We will look only at the most beneficial.

Test 7

Complete the following sentences:

- 1- Soil organisms are.....
(alive-dead)
- 2- Plants absorb useful.....from the soil. **(food-nutrients)**
- 3- Soils rich in humus are.....
..... **(poor-productive).**
- 4- If you add organic matter to clayey soil it..... **(hardens-softens)**



1. Compost or organic fertilizer

Organic fertilizers can be prepared in the home garden.

The materials you need are easy to get: kitchen leftovers, vegetable scraps and animal manure.

Let's find out how to prepare compost!

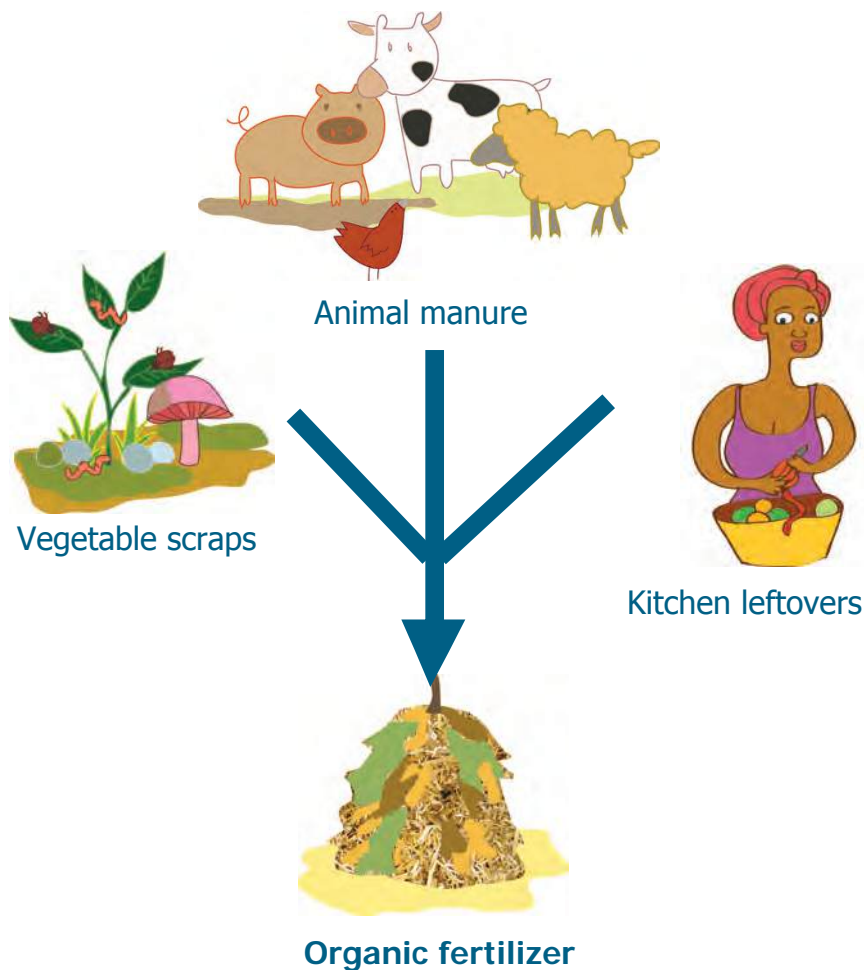

Answers to test 7

- 1- alive
- 2- nutrients
- 3- productive
- 4- softens

Important!

Never prepare organic compost with:

Cat or dog excrement which can carry diseases and make people sick.

Weeds with seeds that contaminate the ground.

Toxic plants (like eucalyptus leaves, walnut leaves) which prevent the growth of other plants.

Plants treated with herbicides.

Scraps of infected plants.

Poisonous plants.

Glass, metal and plastic, materials that do not decompose.

Leftover fats and meats that decompose very slowly and produce a stench.



One way is to make a compost heap ...

Once you have enough manure, vegetable scraps and kitchen leftovers, you can start an organic compost heap Note: (1 inch = 2.5 cm & 100 cm = 1 m)



Choose a place that stays dry and sunny ; loosen the soil 30 cm to 60 cm deep, without tilling.



Bury a two-metre-high pole in the centre. Place the first layer of straw or dry stems on the loose soil.

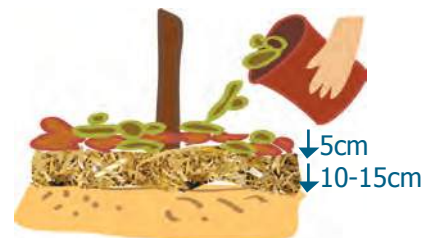

Without flattening the under layer, add a layer of kitchen and vegetable scraps.



Sprinkle a small amount of ash or lime to avoid bad odours when the decomposition starts.



Make the next layer with manure.

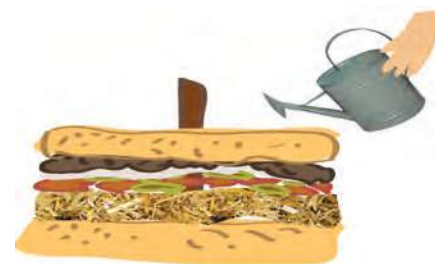

Then add another layer of soil. The heap has to be watered daily.

Keep placing more layers in the same way

“Remember that the compost heap shouldn’t be more than 1.50 m. or less than 75 cm. high.”



When the heap has quite a lot of layers and has reached a height of approximately 1.50 m (4-5 feet):

- The compost heap should be covered with 3 cm (>1 inch) of soil or sand and then covered completely with a layer of straw (mulch).
- Finally, water the heap and remove the pole, which will leave a vent for aeration. Although you may have more material, do not continue adding it to the heap. Prepare another compost heap instead.

You should take care of your compost! The moisture and ventilation have to be maintained

Within a few days, there will be a great deal of activity in the heap you have prepared.

The microorganisms are transforming the scraps into fertilizer.

Don't forget to make sure that the microorganisms have plenty of air and moisture to do their work!



Some suggestions for taking care of the compost



- 1- Two or three days after having prepared the compost heap, you should stick your hand into it to make sure it is hot.
If the mixture is just lukewarm, you have to add water.
- 2- If, when squeezing a handful of the mixture:
 - drops of water are released, it means that there is enough moisture.
 - water runs out, it means that there is too much moisture.
 - nothing comes out, it means that it lacks moisture.
- 3- In hot weather, the compost heap needs to be watered every day so that it does not dry out.

Compost needs special care

- 4- If the heap is in direct sunlight, it has to be protected with branches.
- 5- In case of too much rain, cover the heap with plastic or old sheeting.
- 6- After three weeks, turn the compost over with a rake or shovel. Repeat this procedure every 10 days to aerate better.



After three months, the compost will be ready!



The finished compost:

- has a pleasant odour of soil and leaves.
- is very dark in colour.
- is unrecognizable from the materials that had been placed in the heap.

Test 8

Match the phrases that correspond to each other.

Cat and dog excrement...

The compost pile must be watered...

The compost must be kept...

In order to maintain suitable moisture.

Must not be used to prepare compost.

With adequate moisture and ventilation.

How is compost used?

You need about 30 kg of organic compost for every 10 square metres of garden. A 1-metre-high compost heap provides approximately 70 to 90 kg of compost.

Note: 10 m² = approx. 108 ft²

1 kg = 2.2 pounds



Answers to test 8

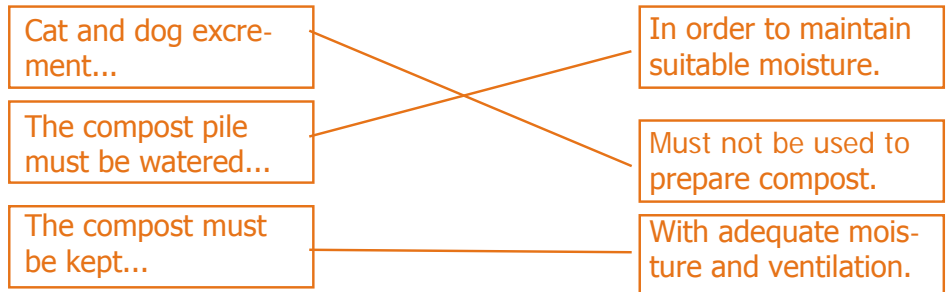

... in addition to the compost heap, you can make a set of boxes for the chicken manure

The first thing to do is build four boxes



Chicken manure, straw, kitchen waste, dry grass

... and every 30 days after that

Mix and move to the adjoining box

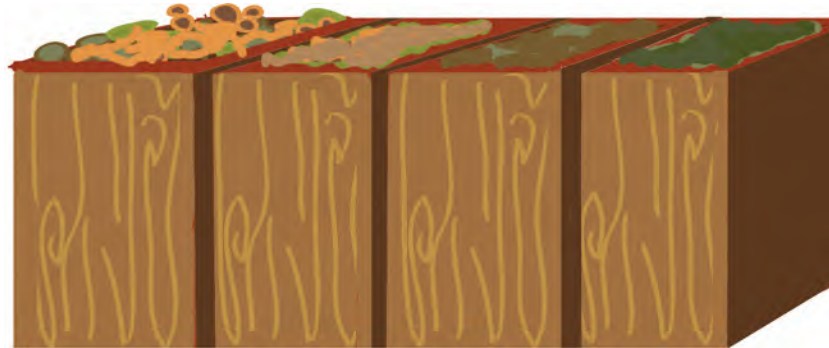

until the compost is ready 120 days later

... there are other ways of making compost or organic manure

You can make family-sized compost in a 200-litre plastic barrel or metal drum.

Preparing the family-sized compost barrel



The cover must be securely fastened

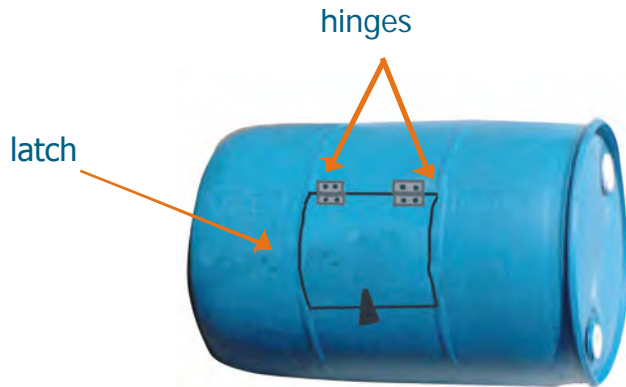

The barrel must be turned on its side before you start to fill it"



Cut a small opening in the side and hold it in place with two hinges and a latch.

Place three square tubes from side to side inside the barrel and fix them in place with mounting pins

Open three apertures of 6 cm (2.5 inch) in diameter and insert three 5 cm (2 inch) square rods, fixing them in place with mounting pins

Puncture several air vents at both ends

View from the inside

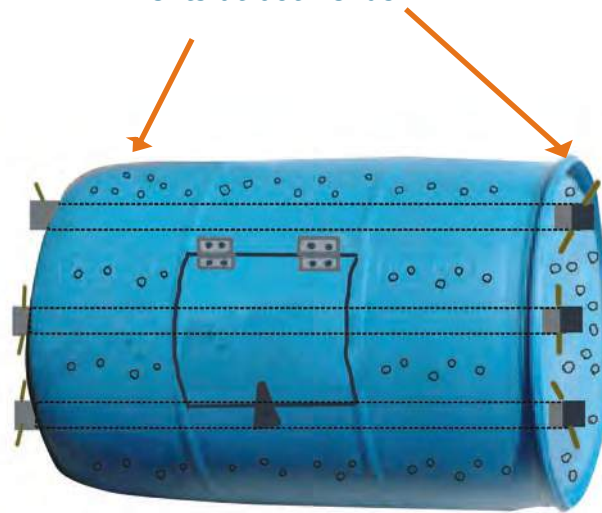

What is inside the barrel?



Cut grass
Leaves
fruit peel
straw



Sun-dried
manure



Rice husks or
soil



Water + 100
grams (quarter
pound) of
urea



... and when the barrel is full ...

Roll it around every day!

Put it in the sun for 5 to 6 hours
and roll it every day

This is so that the
contents get mixed
evenly



After 30 days of rolling the barrel ... you've got compost!

The fertilizer or compost is ready to be used in the home garden, or to make worm humus



Fine, dark-brown mixture with an earthy odour

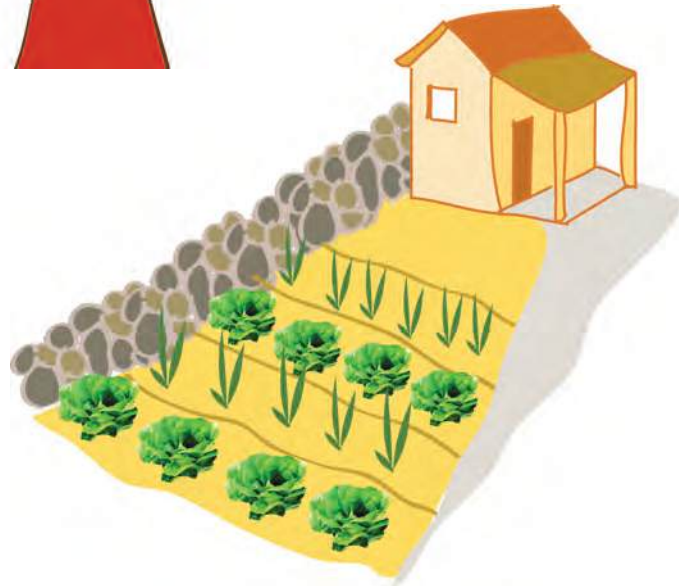

The fertilizer can also be liquid

By using a different process, you can make slurry, a liquid bio-preparation with which to water the home garden



"Ask the technical expert which you should use"

Worm humus

The “**California red worm**” produces a very useful excrement for the garden soil which is called worm humus.

I am the “California red worm”

I live in groups.

I live in a damp environment and I do not like light.

I feed on animals and vegetation in decomposition.



The garden soil can improve greatly if worm humus is added to the soil.

Why?...

Worm humus

- Makes the ground more porous and therefore more permeable for water and air.
- It has substances that help plants grow.
- It has many microorganisms that make the soil nutrients more accessible to the plants.

"How do you prepare worm humus?"



Worm humus: preparation method



You can feed the worms with the compost that you prepared but only after 40 to 50 days of having made the heap.

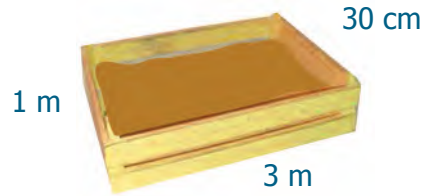

First, prepare a breeding farm. Use wood planks to build a bed 1m by 3m long by 30 cm. high.



Buy or obtain California red worms. Buy a minimum of 9,000 worms for a 3 m² bed.



Place 25 to 30 cm (10-12 inch) of unfinished compost (40 to 45 days old) in the bed.



Distribute the worms on the surface of the worm farm, on the compost.



Water periodically to maintain adequate humidity, (in hot weather it should be watered daily).

Some care guidelines for worm humus:

1- Once a month, turn the worm farm with a spade and add a layer of unfinished compost. Repeat this procedure every month.

2- Keep the worm farm moist, just like the compost pile.

3- After six months your worm humus will be finished and ready for use!

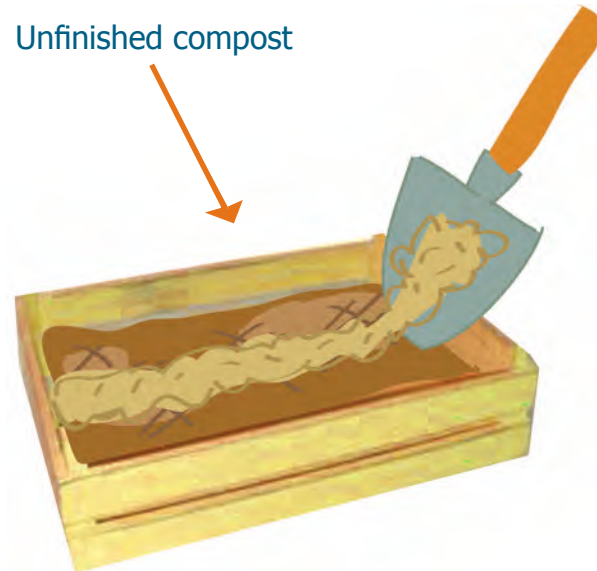

How is worm humus harvested?



Do not water for three to four days.



Add a strip of unfinished compost to the bed; water only the new strip for three to four days.

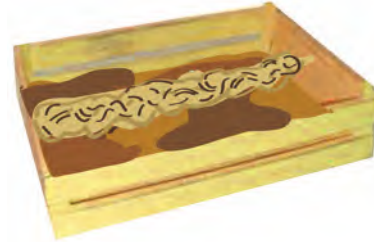

The worms will move quickly to the layer where there is food and humidity.



After two days, remove only the new compost strip (this is where the worms have moved). The finished humus is left on the bed.

After removing the compost with the worms, sift the finished humus.



What should finished worm humus look like?

- uniformly dark in colour
- odourless
- very loose and spongy
- sufficiently moist

If the bed is 1 m. (3 ft) wide by 3 m. (9 ft) long, 400 kg (1000 lb) of humus can be extracted every six months. With this amount, you can fertilize 300 m² to 400 m² of garden.



Test 9

Choose a suitable word to complete each sentence and write it in the squares of the "crossword puzzle" (**layer, humus, duplicates, permeable, sift, useful, watered**)

1- Every three months the worm population.....

2- Unfinished compost that is added to the worm farm is placed in a.....

3- Worm excrement is called worm

4- Worm humus makes the soil more.....

5- The worm farm must be.....

6- Worm humus is very.....

7- Before using humus.....it.

If you had 3,000 worms, after 6 months you would have 12,000 worms.

With the newly produced worms, you could:

- Prepare more humus.
- Feed birds or fish.
- Sell them as fishing bait.
- Make worm meal to feed the animals on the farm.

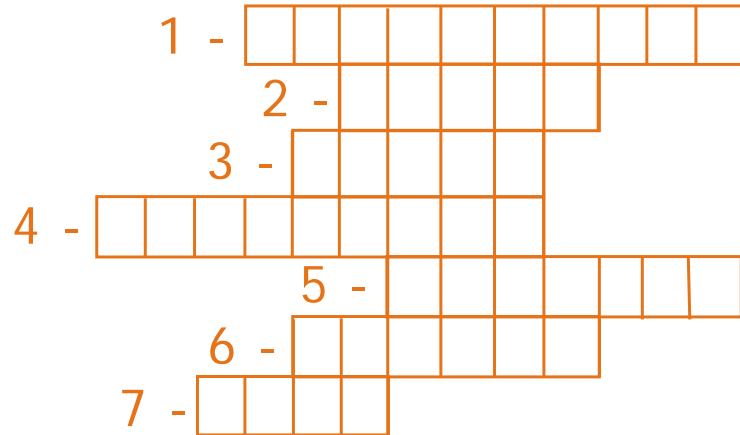

3- Farm animal manure

If you want to start your home garden right away, don't worry if you do not have organic compost or worm humus. Animal manure is a good alternative, provided it is well prepared.

In the meantime, you can put together the materials to make compost or humus.

Manure provides:

- organic matter
- nutrients

Manure from these animals can be used:

- birds and poultry
- horses
- cows
- pigs
- goats
- sheep
- rabbits

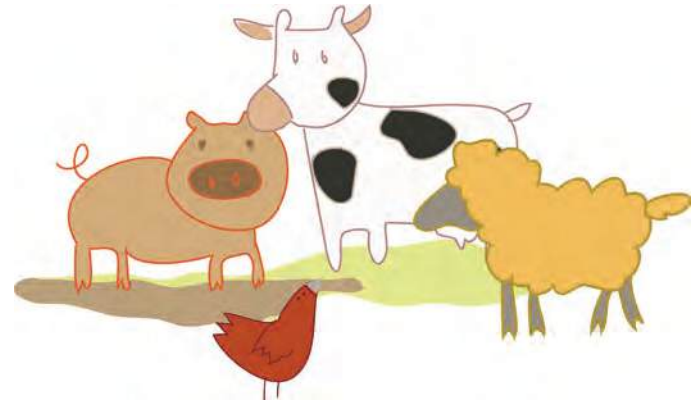

Answers for test 9

- 1 - D U P L I C A T E S
- 2 - L A Y E R
- 3 - H U M U S
- 4 - P E R M E A B L E
- 5 - W A T E R E D
- 6 - U S E F U L
- 7 - S I F T

It is important to prepare farm animal manure by decomposing it before use



Fresh manure:

- can burn seedlings if it is placed too close to them.
- may contain many weed seeds.

Decomposed manure:

- is safer for the plants.
- many weed seeds have been destroyed during the decomposition process.

To decompose the manure:

- make a compost heap and let the microorganisms act for 10 days

To control the temperature: If you put your hand in the compost heap and it feels too hot, you should add water to slow down the decomposition process.

In this chapter we have seen:



- 1- The importance of soil in the garden.
- 2- Organic matter, soil microorganisms and nutrients.
- 3- Preparation of organic fertilizer.
- 4- Preparation of worm humus.

Test 10

Insert a "T" if the sentence is true and an "F" if it is false.

- 1- Soil with little organic matter is rich in nutrients.
- 2- Plants need nutrients from the soil to grow.
- 3- Microorganisms improve the movement of the air in the ground.
- 4- Water drainage takes place in porous soils.
- 5- When preparing organic compost, it is important to maintain good ventilation.
- 6- In the finished compost, the materials placed in the heap are recognizable.
- 7- Worm humus has many microorganisms that improve the soil.
- 8- Animal manure gives organic matter and nutrients to the soil.

If your answers were all correct, you can move another step up the ladder. Congratulations!

Answers to test 10

- 1- F
- 2- T
- 3- T
- 4- T
- 5- T
- 6- F
- 7- T
- 8- T

If two or more of your answers were incorrect, you should re-view the material in Chapter 3

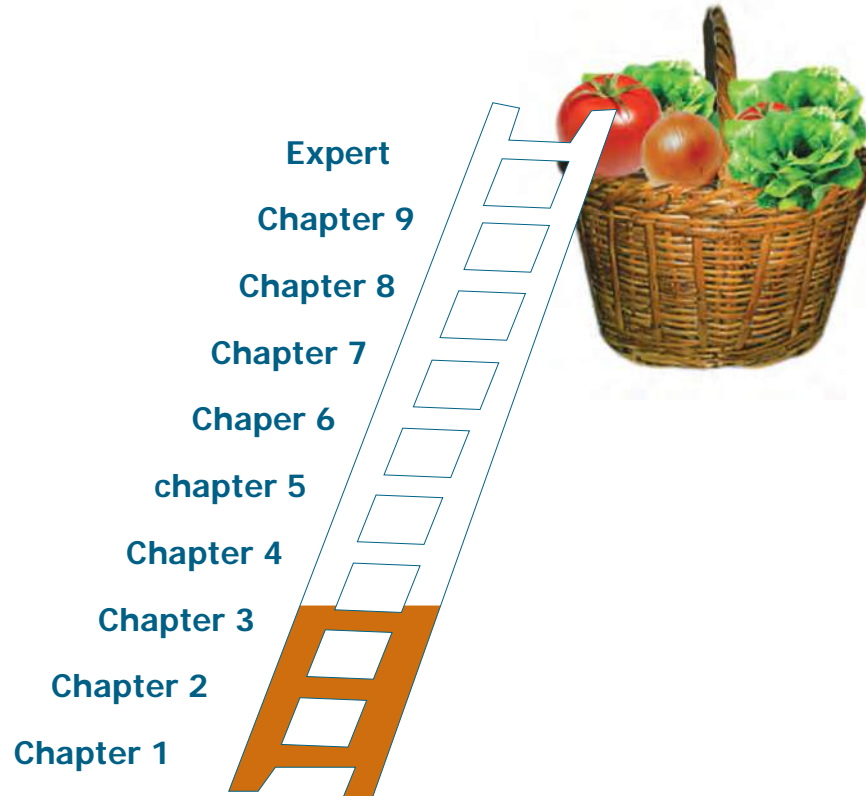

Chapter 4

How do you start a vegetable garden?



First of all, you have some jobs to do

- 1- Put a fence around the garden
- 2- Clear the soil surface
- 3- Level the ground
- 4- Prepare the soil

It is important to do these tasks properly before you start to plant



1- Putting a fence around the garden.

If you have already chosen the best place to plant your vegetables, the next thing to do is to put a fence to protect them from animals and from thieves.

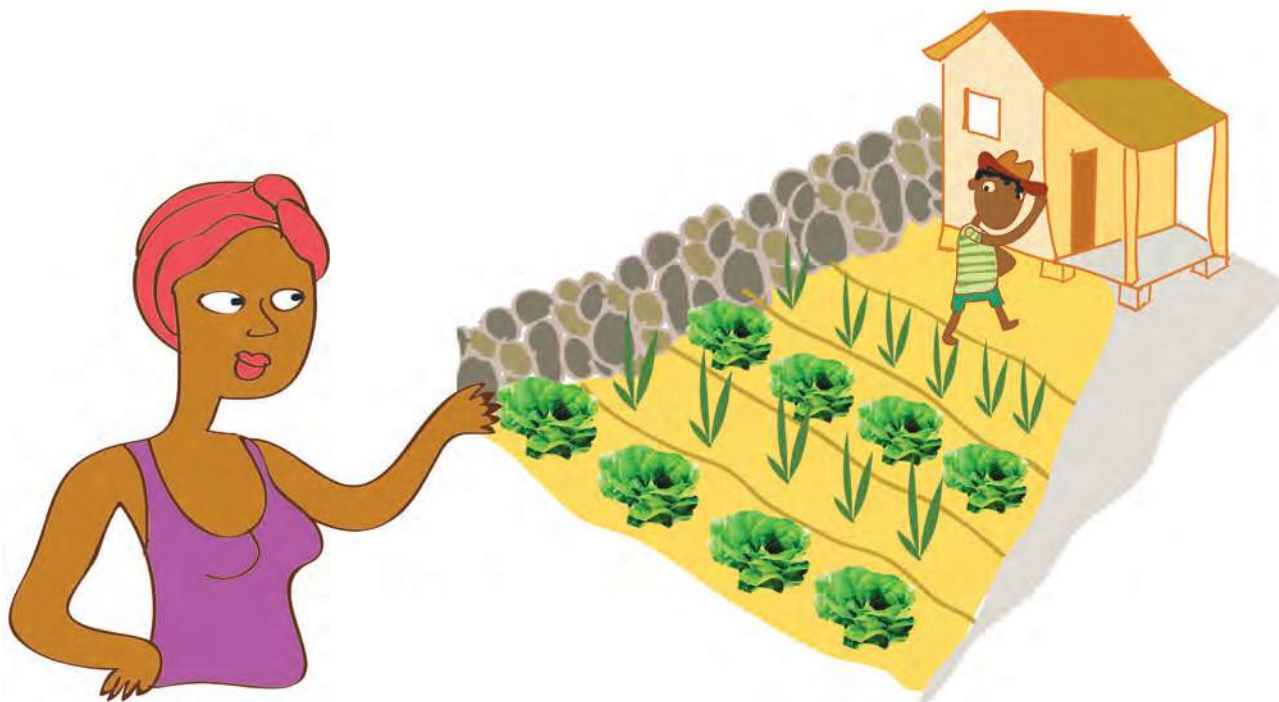

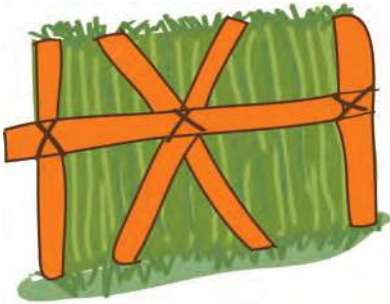

You can make the fence out of many different kinds of material.

If the garden is in a windy place, the fence must be higher and stronger on the windy side.

It is not a good idea to make fences out of large plants that may take away water, sun and nutrients from the garden.

A good idea is to take use your fences as support for climbing vegetables like tomatoes, green beans, cucumbers, melons, small fruit trees, raspberries and grapevines on trellises

2- Clearing the land.

The land has to be cleared properly!

You need to remove:

- Trees and shrubs. You can use them for firewood.
- Small brushwood. You can use the branches and the leaves to prepare organic compost.
- Tins, glass, bones, bottles and stones must be placed in a separate part of the yard.



3- Levelling

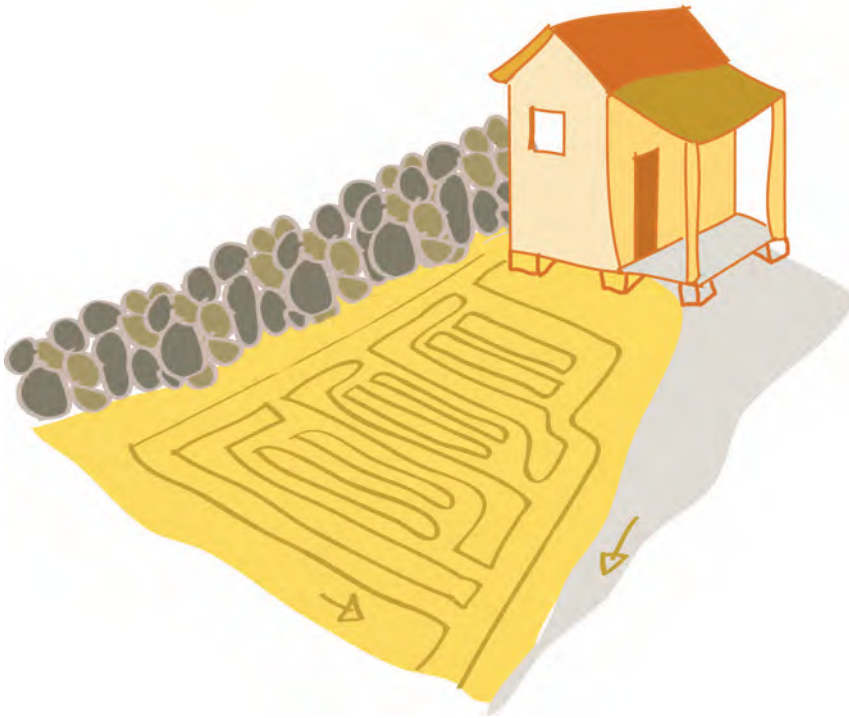

It is highly preferable to plant your vegetables on a slight slope, so that rain, or irrigation water that is not used by the plants, can run off easily.

You should dig a ditch in the upper part of the vegetable garden that can be used for watering. Then dig a ditch in lower end to serve as an exit channel.

That way, you can avoid flooding your house or your neighbour's!

If the slope is very steep, you can make “terraces or steps”. This prevents the rainwater from washing away the soil and vegetables. It also keeps the soil from becoming less fertile.



Test 11

Circle the correct word.

1- Fences made of large plants – **are not** – **are** – a good idea because they use up the water, sun and nutrients in the garden.

2- The ditch for watering the vegetables is dug at the - **low-er** – **upper** – end of the plot.

3- Glasses and stones that are cleared from the land should be placed in the – **garbage** – **compost**.

4- Preparing the soil

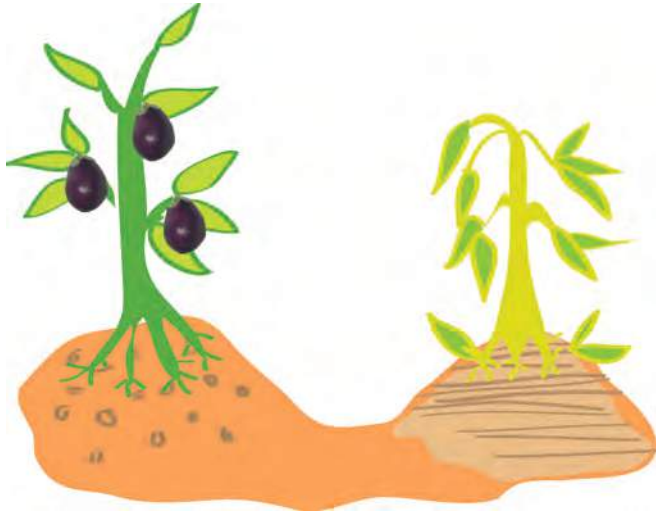

Well prepared soil

Badly prepared soil

Good work!

The area for your vegetable garden is already

- fenced
- cleared
- levelled

Next you have to prepare the soil:

Soil preparation consists of tilling the ground and loosening it to make it spongy. Thus, the roots will develop well and the plant will be better off.



Answers to test 11

- 1- are not
- 2- upper
- 3- garbage

When should the soil be prepared?

Prepare the soil one month before planting.

Before you start, make sure that there is enough moisture in the soil!

Squeeze together a handful of soil:



If a ball forms, but falls apart easily, the moisture is adequate.



If the ball is very moist and it does not fall apart, you must wait for it to be a little drier.



If you cannot form a ball and it falls apart, the soil needs to be watered a little more.

How should the soil be prepared?



1 Scatter a layer of 2 to 5 kilograms (4-10 lbs) of organic fertilizer or manure for each square meter (3ft x 3ft) of land. Mix it into the top 10 centimeters (4 in.) of the soil.



2 Push the point of the spade 30 centimetres (1 ft) into the ground, then lift the soil and let it fall upside down.

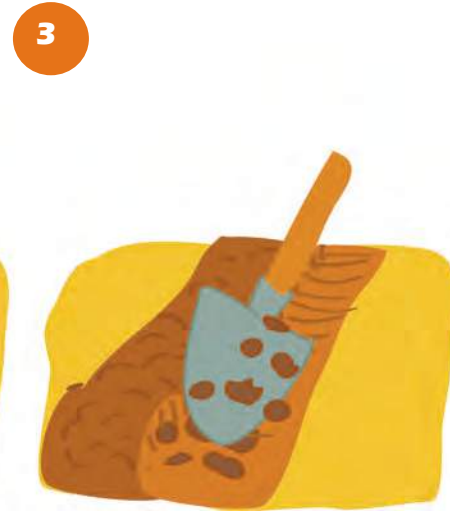

3 Continue turning the soil in for the length of the garden and then turn back at the end of the row and do the same on the other side.

4



Remove large stones and garbage.

5



When all the earth has been turned, go over it with the rake to flatten and break up any lumps.

6



If the region where you live is very rainy or very dry, the soil can be covered with mulch so that crusts do not form or it doesn't get baked by the sun.

Test 12

Complete each sentence using the following words:

large - protect - one month - organic compost.

- 1- It is important to fence the vegetable garden toit from animals.
- 2- It's not a good idea to fence withplants that will use up water, sun and nutrients from the soil.
- 3- Small branches, grass and leaves can be used to prepare.....
- 4- The soil should be preparedbefore planting.

Answers to test 12

- 1- protect
- 2- large
- 3- organic compost
- 4- one month



In well prepared soils!

- There is good ventilation.
- Microorganisms develop well.
- Rain and irrigation water can enter easily.
- Plants take full advantage of the nutrients.
- Roots grow better.

And now, to prepare the raised beds!

Raised beds are ideal when there is little land available; they allow you to take full advantage of the space

How are raised beds made?

Begin by marking rows 1 m (3ft) wide by 15 m (45 ft) long or less, leaving a corridor of 50 cm (20 inches) between rows. If the slope allows it, orient the rows from North to South.

Attention!

If there isn't much water for watering, the beds must be made narrower.

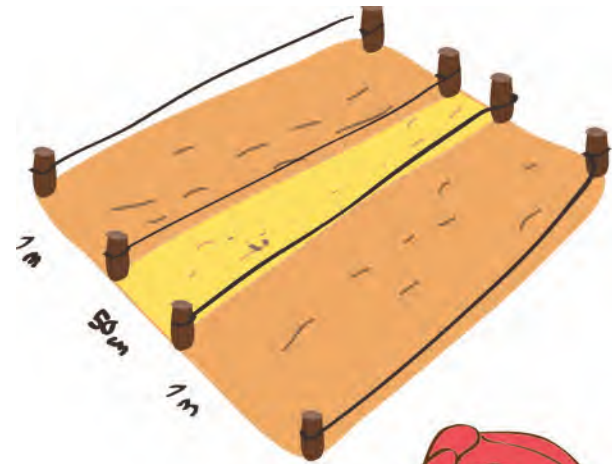

The rows can be marked off using string tied to wooden stakes.



Making a raised bed is very easy. Just follow these instructions:



Take a shovel and make a furrow 15 cm deep between each row and move the topsoil onto the row.



Add organic compost or manure on top of the row and mix it with the first 10 cm of soil.



Deepen the furrows another 10 cm. and place the soil on the top of the row.



Take the back of the shovel and flatten the edges and the surface of the bed so that it doesn't fall apart.



Pick the soil on the surface with a hoe to break up lumps.

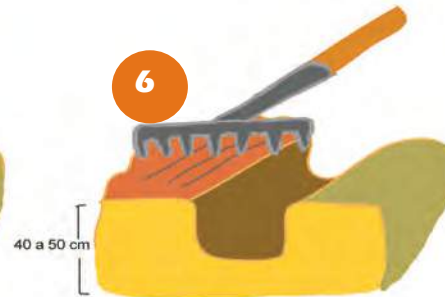

Smooth with a rake. Finally, the bed will be approximately 50 cm. high, measured from the base of the furrow.

Make the rest of the raised beds using the same procedure.

It doesn't matter if space is limited!
Two to three raised beds with the length of the yard are enough to produce a lot of vegetables.

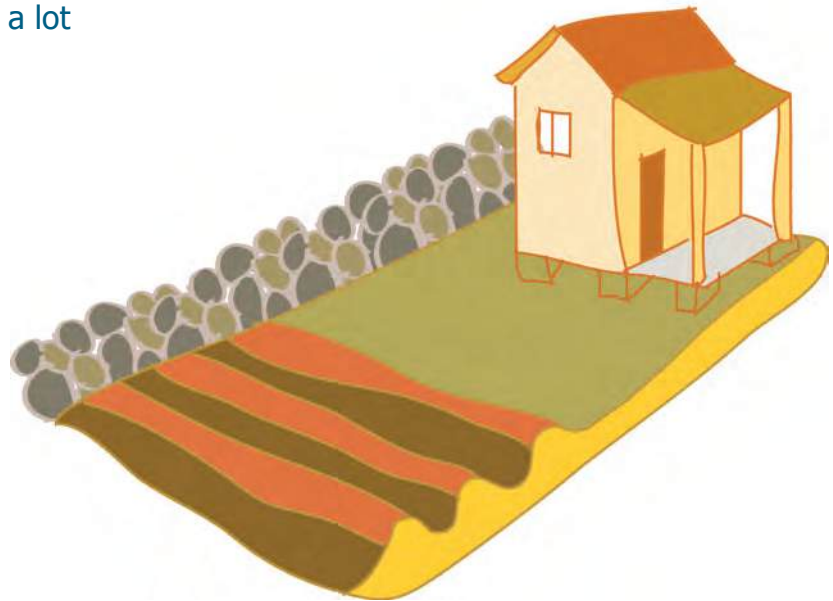

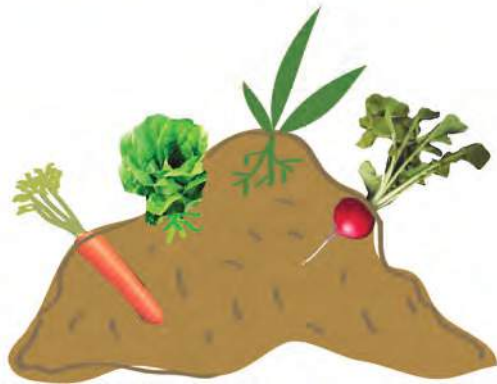
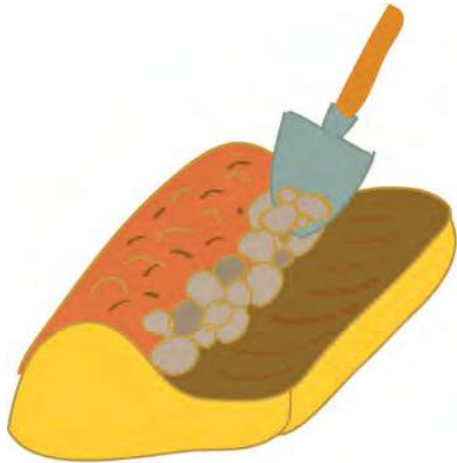

Remember:

- If you are in a very rainy area, you must lay planks or stones on the edges of the beds so that they do not fall apart.
- You can combine plants of different sizes in raised beds.
- Raised beds can last for many years, as long as you add compost every season and make sure the soil does not become compacted.





In this chapter we learned:

Preparing the garden:

- 1- Fencing
- 2- Clearing.
- 3- Levelling.
- 4- Soil preparation.

Test 13

Place a "T" if the sentence is true and an "F" if it is false.

- 1- A high and sturdy wall should be built to protect the garden from the cold and wind.
- 2- You should dig a ditch in the lower end that provides an exit channel for water so that the garden is not flooded.
- 3- The soil has to be prepared well so that it has good aeration.
- 4- Roots need air to breathe.
- 5- The moisture in the soil is not important in preparing the ground.
- 6- You cannot grow plants if the soil is poor in organic matter.
- 7- In drier areas it is preferable to make raised beds narrower.
- 8- The soil is only useful for holding the plants.

If the answers were all correct, you can go up another step. Congratulations!

Answers to test 13

- 1- T
- 2- T
- 3- T
- 4- T
- 5- F
- 6- F
- 7- T
- 8- F

If two or more answers were incorrect, you should review the material in Chapter 4

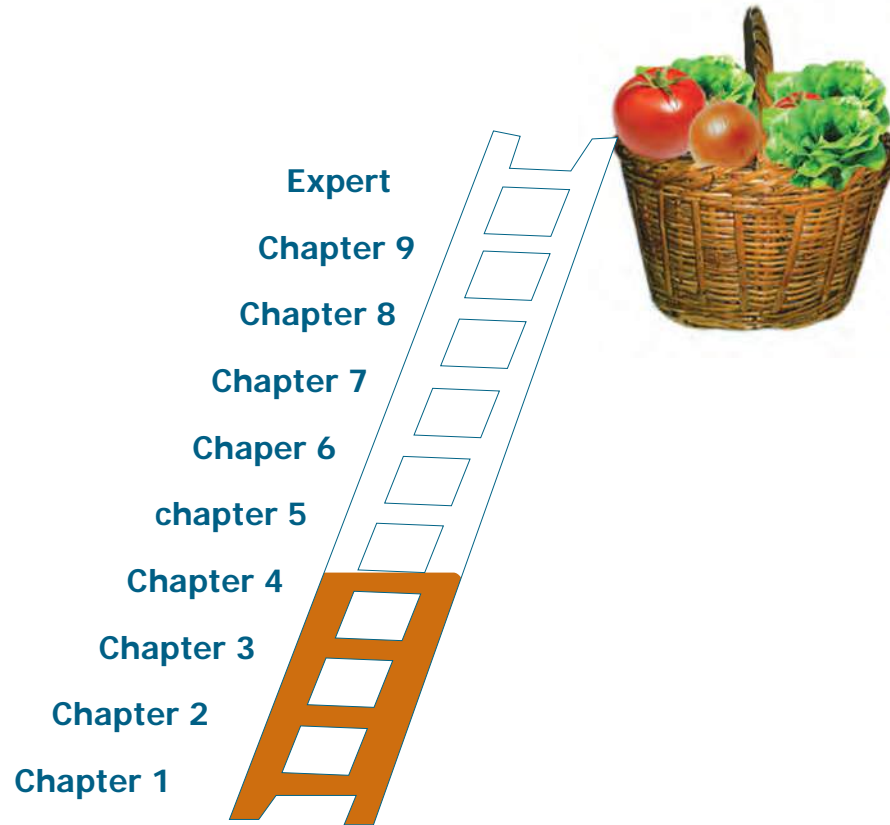

Chapter 5

Vegetable propagation and sowing



How do you propagate vegetables?

Some vegetables are reproduced by seeds and others through vegetative reproduction.

1- Seeds: Most vegetables are reproduced by seeds. That is why it is very important to use only good seeds.

2- Vegetative propagation:

Some vegetables, although they can be reproduced by seeds, reproduce more easily through grafts, bulbs, tubers, stems or other parts of the plant.

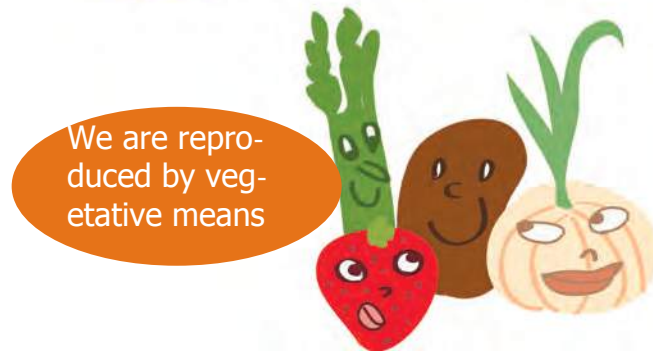

1- Seed:



A seed is like a small plant that.....



Germinates to produce an adult plant like the one from which it came..



When it receives suitable conditions of moisture and temperature

If the seeds have come from an infected or defective plant.....



They will produce infected or defective plants, and you will not get healthy vegetables.

If the seeds come from healthy, vigorous plants



They will produce healthy, vigorous and productive plants.



What are good quality seeds?

All seeds must be of the same type.



Varietal purity

They must be clean, and free of foreign particles, dirt or weeds.



Physical purity

Free of contamination, pests and diseases.



Health

Most seeds should be able to germinate under suitable conditions of temperature and moisture.



Germination ability

The seeds must germinate quickly and the plants should be vigorous.



Vigour

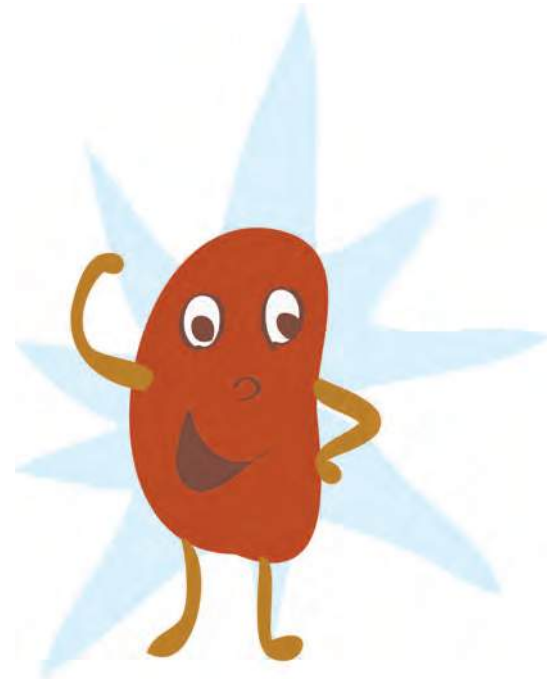

How do you obtain good seeds for the garden?

You can ask the technical staff (**extension officers**) in your area: they can usually provide small quantities of vegetable seeds.

You could also exchange seeds with your neighbors.

If there is a vegetable research station in your area, visit it! The people who work there will help you get the seeds that you need.



You can also produce your own seeds, but you need to take special precautions!

Can vegetable gardens produce seeds?



Yes, but you need to know the plants very well - when they bloom, how and when the seeds are to be harvested.

It is easier to obtain seeds from some vegetables, such as pumpkin, zucchini, watermelon and beans.

You should always keep the seeds of the best plants! These should be large, vigorous and free from disease.

Producing seeds in your vegetable garden!



Prepare a separate area specifically for seed production. This should be a space next to the vegetable garden, but not in the garden itself.

The plants should be isolated, and you need to sow at least 4 plants per species, so that the process of flowering and reproduction is more likely to take place.

Selecting seeds from flowers or plants



Select the best plant, the best flower or the best fruit.

Extract the seeds from the centre, if it is a fruit.



Take the seeds out carefully and wash them with clean water to remove residues of fruit or soil.

Place the seeds on newspaper and dry them for 2-3 days in the shade.



Finally, sow them, or keep them in paper bags, if they are to be stored for a short time; or in glass containers, if it is for a longer period.

If you are going to buy seeds, choose those that come in labeled, sealed packages; these are almost always of better quality.

The package label should specify:

- Species
- Variety name
- Production year: the seeds should not be more than one year old.
- Germination ability: % probability of germination.
- Date of the germination analysis.
- Brand name or company

Warning! If you have any doubts about the quality of the seeds you are using, you can run some tests.

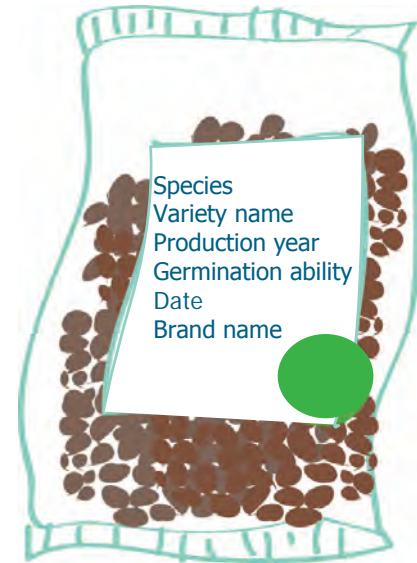

Next we will perform some germination tests.



Germination tests

Materials:

- 50 seeds
- Cotton wool
- Paper towels or newspaper

Method



Place a tight layer of cotton wool on a plate and cover it with toilet paper. Add water to dampen it and remove any excess water.



Place the seeds on the wet paper in an orderly fashion. Moisten the paper every day. Keep the plate inside the house in a warm place.

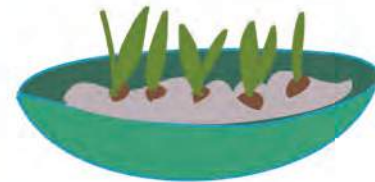

After six or seven days count the number of seeds that have germinated.

Germination test results

If 40 or more of the 50 seeds that were planted, have germinated, it means that they have very good germinating power (higher than 80 %).

If less than half have germinated and the plants are weak and growing unevenly, the seeds are weak and should not be used.

Test 14

Match the phrases that go together using lines:

In order to germinate, seeds need. ...

A seed is.....

A good-quality seed.....



germinates quickly.

moisture and the right temperature.

the smallest plant..

How do you sow seeds?



There are two ways to sow vegetable seeds:

Direct sowing: The seeds are placed directly in the soil in which they will grow. This method is used for vegetables with large seeds that are resistant to changes in weather conditions.

Seedlings and transplants: This method is used when the seeds are very small and need special care to germinate.

Answers for test 14

In order to germinate, seeds need. ...

A seed is.....

A good-quality seed.....

germinates quickly.

moisture and the right temperature.

the smallest plant..

Direct sowing

Direct sowing can be done in several ways:

- **Broadcast:** the seeds are scattered over the surface of the bed.
- **In line:** the seeds are placed in rows at regular distances apart.
- **Drilling:** 2 to 3 seeds are placed in small separate holes.



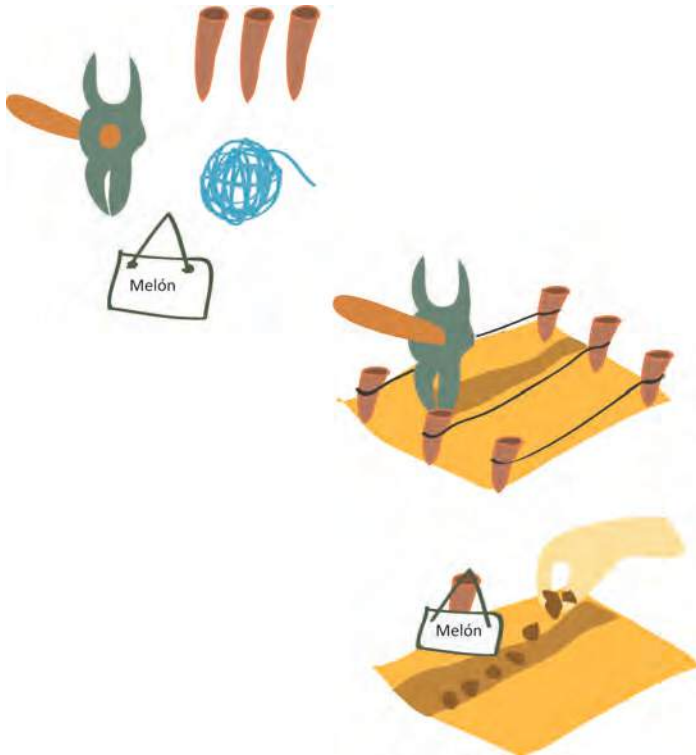

Sowing directly in line!

Materials:

stakes
string
weeding hoe
labels

Method:

- 1- Mark the sowing lines with a line of string. Attach a stake at each end to stretch the string across the bed.
- 2- Trace the furrows using the string line as a guide. The depth of the furrow depends on the size of the seeds (see the chart that follows)
- 3- Find out how many seeds you need to sow for each vegetable.
- 4- Distribute the seeds neatly in the furrow by hand.
- 5- Place a stake with the name of the each vegetable sown on the furrow.

How deep should you sow?

Larger seeds are buried deeper, and smaller seeds are sown nearer the surface (1 cm = half-inch (approximately)).

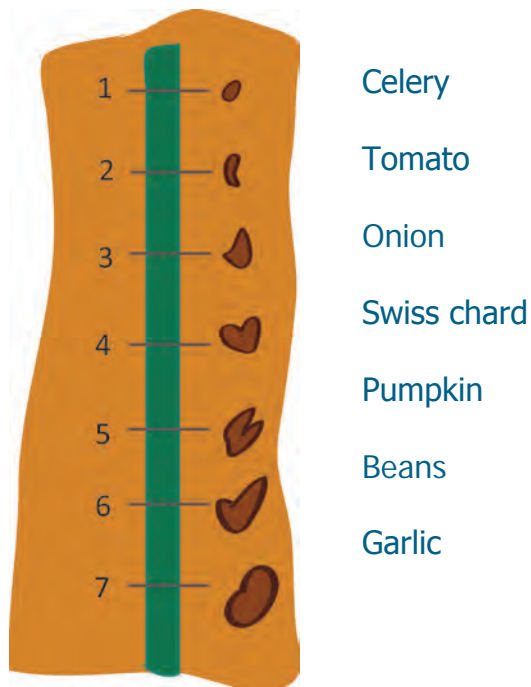

You can find out the sowing depth and the amount of seeds to sow for each vegetable in the chart at the back of the manual.



Direct sowing in line is complete



Now the seeds have to be covered with mulch!

Mulch is made with organic compost, or decomposed manure, combined with an equal amount of sand or soil.

Once the sowed furrow has been covered with mulch, compress it gently with the back of the hoe.

Finally, the bed has to be watered. The soil must be kept moist and therefore, it must be watered regularly, without overwatering

How should the seed be watered after sowing?

At first, the seeds can be watered with a spray hose, or a watering can, to make sure that the water reaches the seeds.

Later, when the plants start to grow, they can be watered by irrigation channel, sprinklers, or with a drip system, as shown in chapter 6.



The plants begin growing within 5 to 10 days



Great! The first plants have already appeared.

You have to pay attention to when the plants have 3 or 4 leaves, because then, you have to thin them.

Thinning means eliminating surplus plants, leaving only those at fixed distances.

To see how to thin the seedlings, turn to the next page.

Thinning

1- Loosen the soil between the furrows with the hoe.

2- Use the weeding hoe to eliminate plants growing between the different groups, leaving only those at the desired distance.

3- Manually remove small or weak plants, leaving only a single healthy plant



Test 15

Complete each sentence, using the following words: **depth, mulch, beans.**

- 1- are direct sowing vegetables.
- 2- Sowing depends on the size of the seed.
- 3- is used to cover newly-sowed seeds.

2-Seedlings and transplants.

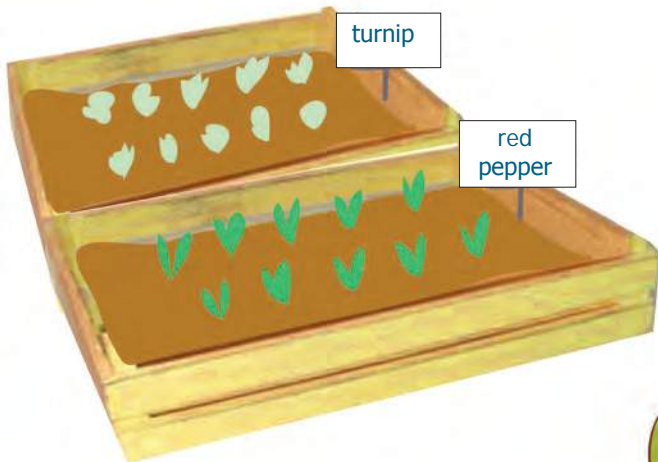

If the seeds that you want to sow are very small, or if they take a long time to germinate, or need special care, it is preferable to sow them in seedling beds, or seed trays.



Answers to Test 15

- 1- Beans
- 2- Depth
- 3- Mulch

Seedbeds have many advantages

Planting in seedbeds

- uses the land better, because the plants spend part of their life in a small space.
- makes it easier to take care of small plants. (weeding, fertilizing, watering).
- protects the plants from the cold, the sun and the rain.

There are fewer losses in seedbeds and less seeds are needed than with direct sowing.



Not all vegetables can be transplanted

Check the chart at the back of this manual to see if the vegetables that you are planting are better suited to direct sowing or to transplanting.



For example, the following vegetables should be planted first in a seedbed and then later transplanted:

- Cabbage
- Broccoli
- Cauliflower
- Tomato
- Green Pepper
- Onion
- Celery
- Lettuce

Seedlings can be started in fruit boxes, plastic containers, used tins, flowerpots, etc.

You can also have seedbeds in the soil if you have a lot of land and when you need many plants.

It is much easier to sow seeds in containers or seed trays!

Let us see how to make them!

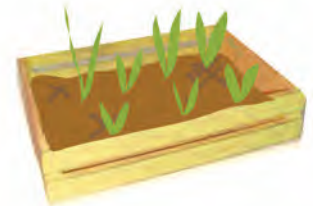

Preparing the seedbed

Step by step:

1- Sift the substrate (the mixture of soil, sand and organic compost)



2 - Crush the bigger lumps



3- Fill the seedbed with substrate



4- Remove any large particles



5- Moisten the substrate

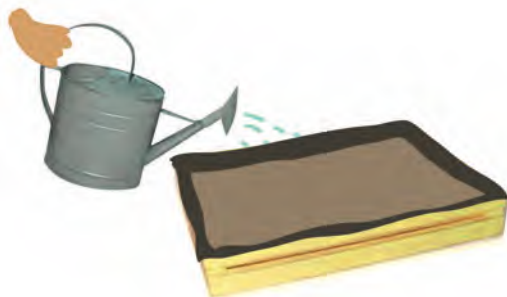

6- Mix and level



7- Draw the furrows at the recommended depth and distance



8- Sow the seeds in the furrows at the recommended distance apart. Sow one seed per space



9- Cover the furrows



10- Cover with newspaper, moisten and cover with more paper or dry grass without seeds



Care and management of seedlings

After you have finished preparing and sowing the seedbed, you need to:

- 1- Check the seedbed twice a day.
- 2- Remove the paper and dried grass as soon as the first seed germinates.
- 3-Water daily with water and nutrient solution.
- 4- Loosen the soil twice a week to avoid the formation of hard layers and the development of algae.
- 5- Earth up (mold) or put the substrate around the bottom of the plants to strengthen the development of the roots.

Remember:

Prepare new seedlings every two weeks. In this way, you will always have seedlings to transplant.



Important:

You should have a separate seedbed for each species. Don't mix the seeds of different vegetables.

Water the plants carefully, so that the seedlings are not damaged.

Important

Is the planting finished?

You should water immediately. Water with a very fine sprinkle so as not to damage the seeds or the new shoots. The seedbed should always be kept damp.

Water the seedbed daily. It is best to water it early in the morning so that the excess moisture evaporates during the day.



Don't forget to remove the newspaper as soon as the first seeds germinate. Otherwise you will have weak plants, which develop a long stalk and yellow leaves.

- 1- Before the seeds germinate, the seedbed should be covered with newspaper and dry grass.
- 2- After germination, the cover should be removed.
- 3- The seedlings have to be watered daily with a fine sprinkler.

Weeding



After a few days, the seeds will start to germinate.

Watch out! Weeds will also start to grow.

The weeds need to be removed because they compete with the seedlings for nutrients and water.

Test 16

Complete the sentences using the following words: **label, transplanted the land, holes.**

- 1- With seedbeds you take better advantage of.....
- 2- Not all vegetables can be.....
- 3- It is important to.....the seeds you have planted.
- 4- The bottoms of the containers must have

Run a weeding tool between the furrows, about two centimeters into the soil. The soil loosens and then you can remove new weeds.



It is better to weed when the surface is dry because the crust breaks more easily.

If the seedlings are too close, you can thin them out.

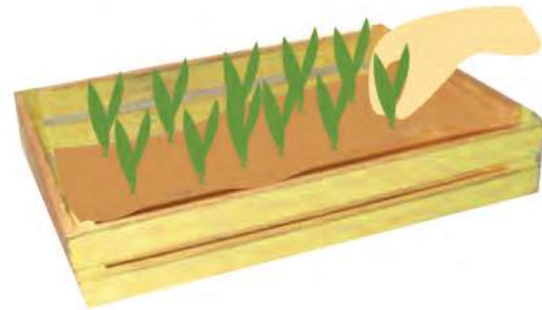

Answers to Test 16

- 1- The land
- 2- Transplanted
- 3- Label
- 4- Holes

Protecting the seedlings

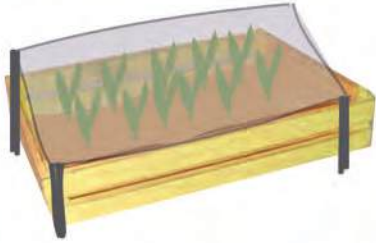

Seedlings must be protected from:

- Heavy rain
- Frost
- Strong sunshine
- Heat

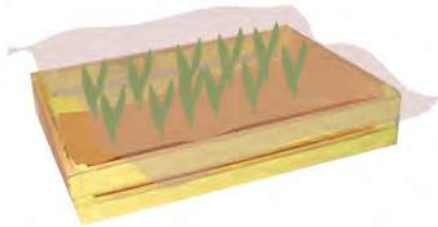

You can protect the seedlings by placing glass or transparent plastic over the containers, taking care that they are not in direct sunlight. You can also protect them by placing them indoors

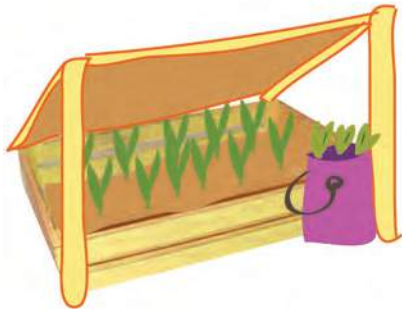

Remember that seedlings need air!

Transplanting

If, 30 to 40 days after sowing, the seedlings have 4 to 5 leaves and are firm, they are ready to be transplanted.

Transplanting means removing the seedlings from the containers and planting them in the spot where they will continue to grow until harvest.

Before transplanting, you need to prepare the seedlings!

When you transplant, the soil should be damp but not too wet.



Do not water the seedlings for 2 to 3 days before transplanting.



Water on the day you transplant

How do you transplant seedlings?

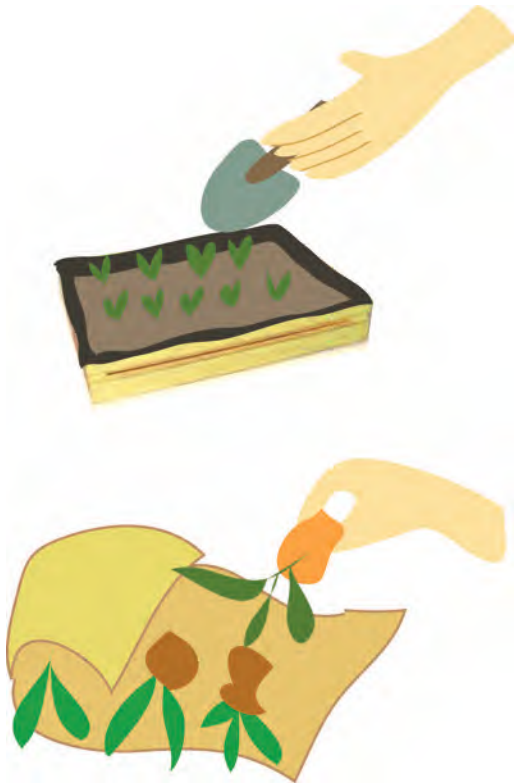

- 1- Remove the seedlings with a small trowel, taking up as much soil as possible.
- 2- Separate them carefully, one by one, onto a wet cloth or paper. Now is a good time to remove any plants that are small or weak.
- 3- Do not take out more seedlings than you plan to plant on that day. Keep the seedlings in the shade and under a wet cloth while you transplant.

You should transplant early in the morning or on a cloudy day.

If the seedlings are very close together in the seed bed, you can take several clusters out at the same time.

Shake them lightly to separate the soil from the roots. The roots are then bare.





Remember!

You should prepare the soil before transplanting, as shown in Chapter 4.

And now, it's time to plant!

If the seedlings come in soil plugs...



Make a line of holes in the raised beds. The distances between the holes depend on the vegetable to be planted. Check the chart at the back of the manual.



Place the seedling with the whole plug into the hole.



Press the soil with your hands so that the roots make contact with the earth below.

If the roots are bare



Make holes along the furrows with a dibber (made with a stick).



Holding the outer leaves place the seedling in the hole. The roots should be spread out.



The seedling should be planted a little bit deeper than it was in the container.



Press the soil around the seedling without damaging the roots.

The seedlings have to be watered immediately after transplanting



You can water by furrows.



You can also use a watering can, but avoid wetting the leaves.
Watering is shown in Chapter 6



Check every planting hole, cover any seedlings that might have become uncovered and, after a few days, replace any seedlings that might have died with new ones.

Vegetative propagation

Some vegetables can be reproduced by planting living parts of the same plant:

Asparagus:

Is reproduced by roots or crowns.

Garlic/Onion:

Is reproduced by cloves or bulbs

**Artichoke/
Banana:**

Is reproduced by suckers.

Strawberry:

By runners.

Sweet potato:

By stem cuttings and tuber pieces.

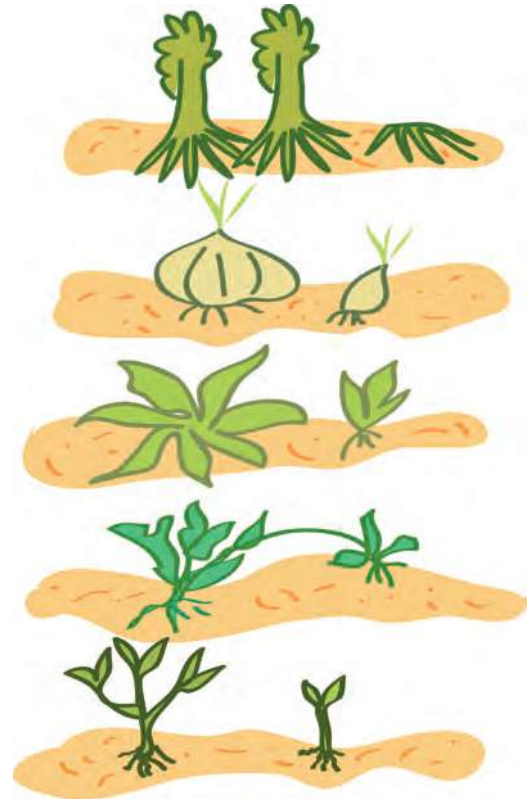



When the garden has begun to produce vegetable, check them and select the best plants.

The mother plants will be the largest and strongest. From them you will obtain propagation material.

If you notice that the plants are weak or yellow it is better to renew your vegetable plants. Get the top quality material.



In this chapter we have seen:

Propagation and vegetable planting.

1-Seed:

Seed quality
Direct sowing
Seedlings
Transplanting

2-Vegetative propagation



Test 17

Place a "T" in the circle if the sentence is true and an "F" if it is false.

- 1- You should use good quality seed, if you want to grow healthy plants.
- 2- Direct sowing is used for plants that do not tolerate transplanting.
- 3- Soil moisture is not important at planting time.
- 4- If the seed is slow to germinate, you should start it as a seedling
- 5- It is important to air the seedbeds to avoid disease
- 6- You need more seeds to produce seedlings than for direct sowing.
- 7- You should water seedlings two days before transplanting.
- 8- Choose the healthiest and strongest mother plants for vegetative propagation.

**If all your answers were correct,
you can go up another step.
Congratulations!**

**Answers
for test 17**

- 1- T
- 2- T
- 3- F
- 4- T
- 5- T
- 6- F
- 7- F
- 8- T

If two or more answers were incorrect, you should review the material in Chapter 5.

Expert
Chapter 9
Chapter 8
Chapter 7
Chaper 6
chapter 5
Chapter 4
Chapter 3
Chapter 2
Chapter 1

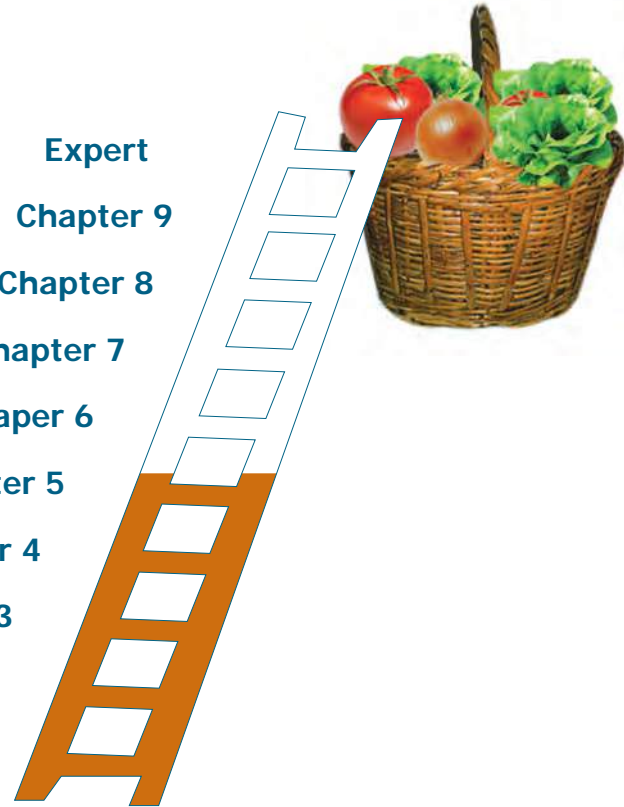

Chapter 6

What is hydroponics?

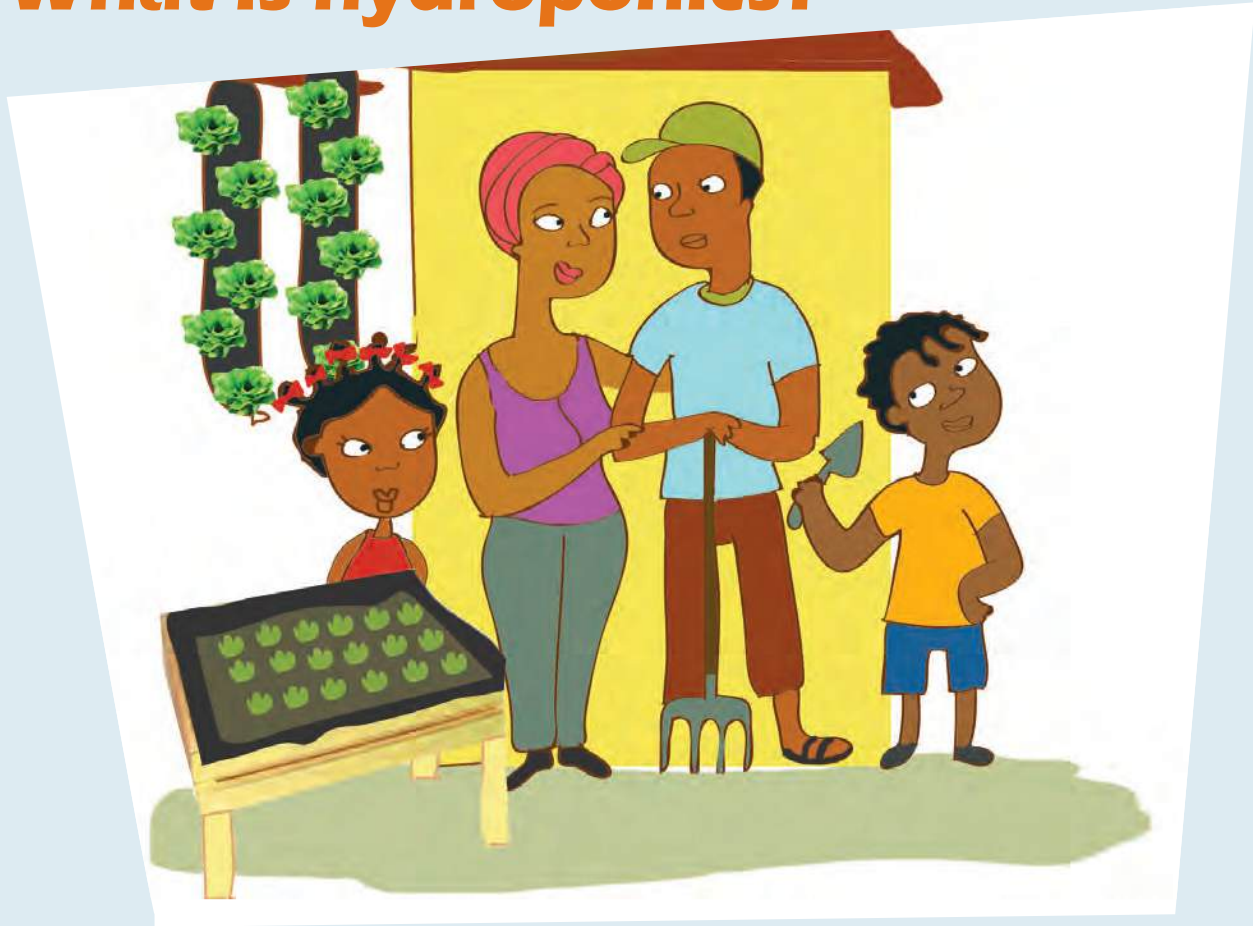

What is Hydroponics?



Hydroponics is a technique used for growing vegetables without soil, whereby nutrients are provided to the plants in liquid form.

The advantages of Hydroponics

- Hydroponic plants are safe to eat, because they are watered with drinking water and sowed in clean substrate which is free of contamination.
- They occupy small spaces, on roofs, walls and terraces.
- The yield is high. For example, 1 square metre of soil yields 9 lettuces, while 1 square metre of hydroponics yields 25 lettuces.
- It is a low-cost technique that is easy to learn.



Where should you grow hydroponic plants?

- Near a source of clean water.
- Somewhere with at least six hours of sunlight per day.
- Out of reach of house pets.
- Away from the shade of trees.
- Under cover to shelter from frost, excessive rain or sun.

How you tend your plants is very important!



If you grow your plants near water, you will save time and energy. You won't get tired of fetching water.

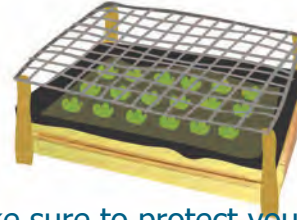

Make sure to protect your plants from rain, hail, frost or too much sun; that way, they won't get damaged.



Don't put your plants in the shade of trees.

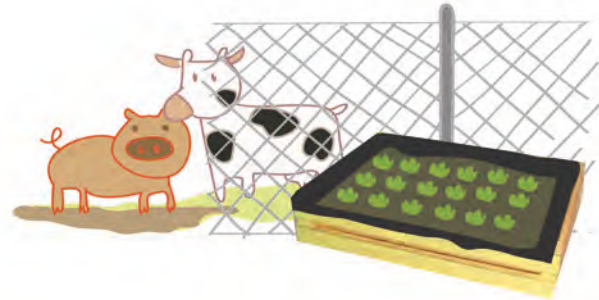

If you protect your plants from domestic animals, you won't have to worry about them getting damaged.

How to build a container for the hydroponic garden



We're going to build the containers now. The materials we're going to use are for building a one-metre square container for water or substrate.

- Containers are used in hydroponics because they are "closed systems" that control the amount of plant nutrition better by means of watering.
- The size of the container depends on the space available and the budget of the individual or group.



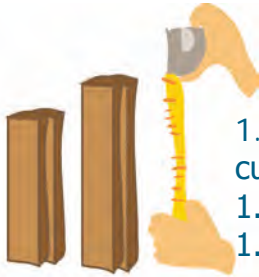

1. Measure and cut two boards of 1.04 m and two of 1.00 m.



2. Nail the four boards together to form a frame. Put the 1.04 metre boards on the outside and the 1.00 m boards on the inside.



3. Make the bed of the box by nailing boards of 1.04 m in length on the underside. First, fit boards near the edges of the frame.



4. Fasten the other boards that make up the base, leaving a 3cm to 4cm space between each board.



5. Then, nail the legs to the four corners.

6. Cut the black plastic sheet, calibre 6:

A one-metre square (1m x 1m) container 12 cm high would require:

Plastic cut to this length:

Length of container + 3 times the height
 $= 1 \text{ m} + (3 \times 0.12) \text{ m}$
 $= 1 \text{ m} + 0.36 \text{ m}$
 $= 1.36 \text{ m}.$

Plastic cut to this width:

Width of container + 3 times the height
 $= 1 \text{ m} + (3 \times 0.12) \text{ m}$
 $= 1 + 0.36 \text{ m}$
 $= 1.36 \text{ m}$



7. Cover the boards with newspaper to avoid damaging the plastic sheet with splints and nails. Place the plastic sheet in the container on top of the newspaper.



8. The plastic sheet must fit tightly at the corners and to the base.



9. Insert the drain: All containers that are used for growing plants in substrate must have a drainage outlet. Make a hole 1 cm in diameter in one end of the container 2 cm above the base.



10. Place the substrate: Place the substrate starting from the drain end and extending over the rest of the container. Fill up to 1 cm below the edge of the container.

What is the substrate?

Test 18

Place a "T" in the circle if the statement is true, and an "F" if it is false:

1. Hydroponics allows us to grow fresh, safe, clean vegetables without using soil.
2. Hydroponics does not use a nutritive solution.
3. There must be at least six hours of sunlight to get good results.
4. We must have containers to grow plants hydroponically.



The substrate or cultivation medium is the material used in hydroponics for growing plants. It replaces the function of soil in sustaining plant life.

What are the characteristics of a good substrate?

- It must be clean
- It must hold moisture.
- It must have good drainage
- It must be light
- It must be abundant, easy to obtain and transport.
- It must be inexpensive
- It must allow the roots to get air.



The technician will show you how to choose and use the substrate.

You can make mixtures that combine the best characteristics of each substrate

The answers to Test 18 are:

1. T
2. F
3. T
4. T



The most commonly used mixtures are:

60% rice husks + 40% river sand.

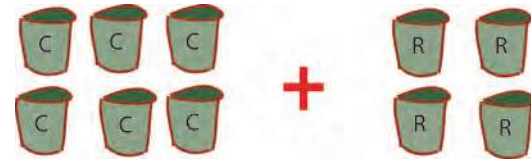

80% clay bricks + 20% sawdust.

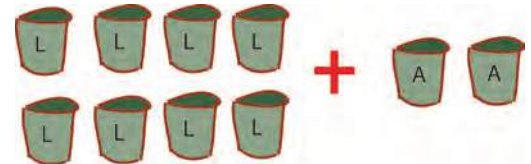

50% rice husks + 50% clinker bricks

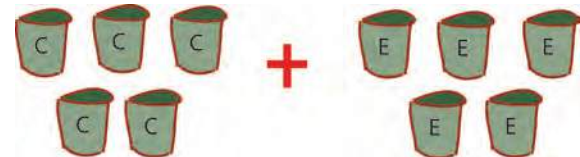

What is the nutritive solution?

In hydroponics, the plants either grow in water or in an inert substrate which does not provide any type of nutrient. That is why their food has to be supplied in the form of a nutritive solution, or nutrient.



The nutrient solution is a product that contains all the elements that plants need to grow and develop. Some of these nutrients are:

Nitrogen, Phosphorus Potassium, Sulphur Calcium, Magnesium, Iron, Manganese, Copper, Molybdenum, Boron and Zinc

The preparation of the nutrient should be carried out by an agricultural field officer. Farmers who decide to start hydroponic plant culture must have access to the nutrient and be trained in simplified hydroponics.

Hydroponics in substrate



1. In sowing directly or transplanting, start by placing the container at an slope that will make drainage easier.

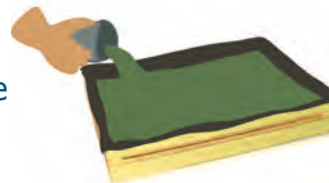

2. Fill the container with the substrate to a height of 2 centimetres below the rim of the frame.

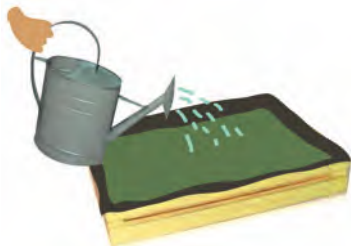

3. Sprinkle evenly with clean water and turn the substrate over.



4. Remove the plants from the sowing bed and transplant, keeping the recommended distance apart. Make a hole and insert each plant, ensuring that its roots remain vertical.

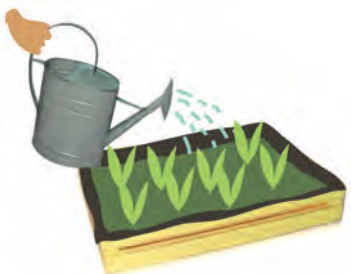

5. Sprinkle with nutrient solution six days a week. On Sundays, irrigate with water only, using twice the usual amount.

REMEMBER:

Apply the water with nutrient only at the base of the plant and in the early morning.

Floating and tubular hydroponic gardens



Floating root system:

This system of cultivation uses a liquid medium made up of water and mineral salts. It is called the floating root system because the roots of the plants float in the nutrient solution.

Tubular growing systems or vertical sleeves:

Hydroponic gardens can also be grown vertically. To do this, use tubular plastic to plant, either in bags or tubes.

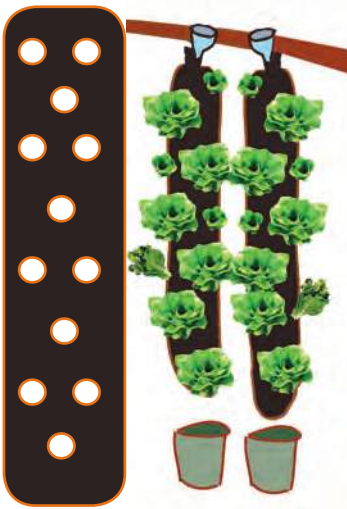

Place a strip of tubular black plastic, calibre 6, on a hard surface. Make holes in the plastic with a hot tube:

Method:

1. Introduce a plastic tube 1.2 metres in length into the tubular plastic.
2. Tie the plastic to the tube at one end with plastic tape or strong wire
3. Fill the bag with soil and humus, making sure that the tube stays in the centre.
4. When filled, tie with a strong string or tape.
5. You can place a bottle at the top end for easy watering.
6. Remove 10 cm high seedlings from the seedbed and plant them in the holes made in the plastic.

In this chapter, we have found out about:

1. Simple hydroponics.
2. How to build a container.
3. Substrate mixes.
4. Nutritive solution.
5. Hydroponic substrate.



Ask the technician about training in methods of hydroponic culture.

Test 19

Place a "T" in the circle if the statement is true, and an "F" if it is false:

1. One of the most commonly-used mixes of substrate is 60% rice husk and 40% river sand.
2. The "nutrient" is a pesticide.
3. The "nutrient" is made up of simple mineral elements.
4. Without the "nutrient", the plant can grow well using hydroponics.
5. You can transplant into a dry substrate.
6. You must water twice every day with nutritive solution.

**If all your answers were correct,
you can climb the next rung of
the ladder. Congratulations!**

Answers to Test 19

- 1. T
- 2. F
- 3. T
- 4. F
- 5. F
- 6. F

If two or more of your answers were incorrect, please review the topics in Chapter 6.

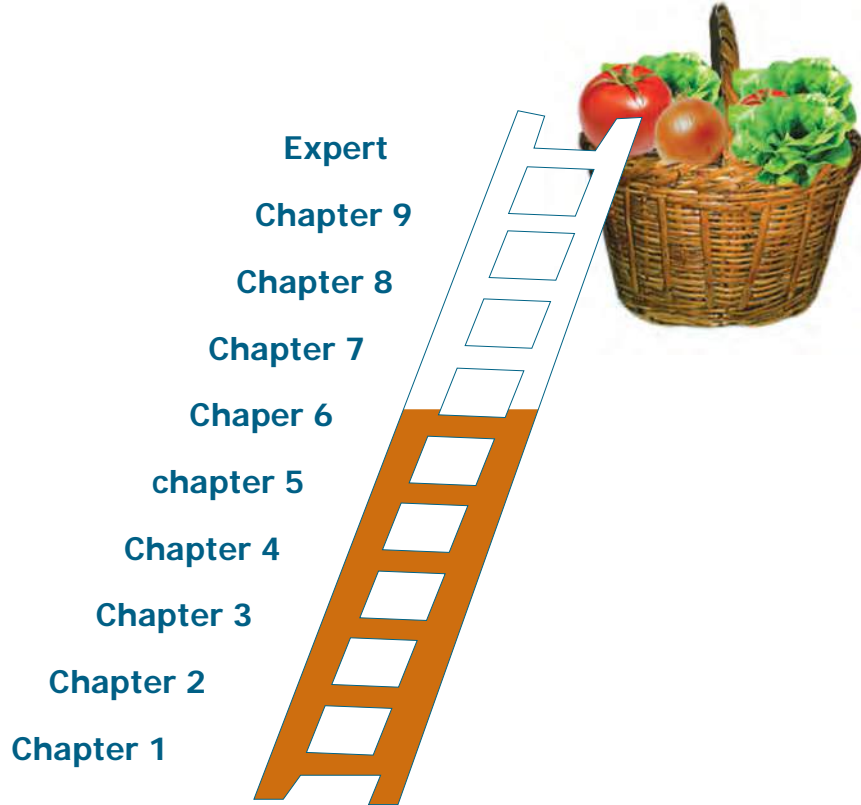

Chapter 7

How do you look after the garden?

Your vegetable garden has friends and enemies. A good horticulturist needs to learn about them in order to take proper care of his vegetables.



Taking care of your vegetable garden



1- Watering.

2- Weed control.

3- Cultivating.

4- Pest control.

5- Disease control.

1. Watering

- For seeds to germinate....
- For plants to grow and produce well....

You need

Well-watered soil.

In rainy areas you only need to water when the weather is dry.

In dry areas (arid or semi-arid) you should water frequently throughout the year.

It is important to water only as much as necessary, neither more nor less.

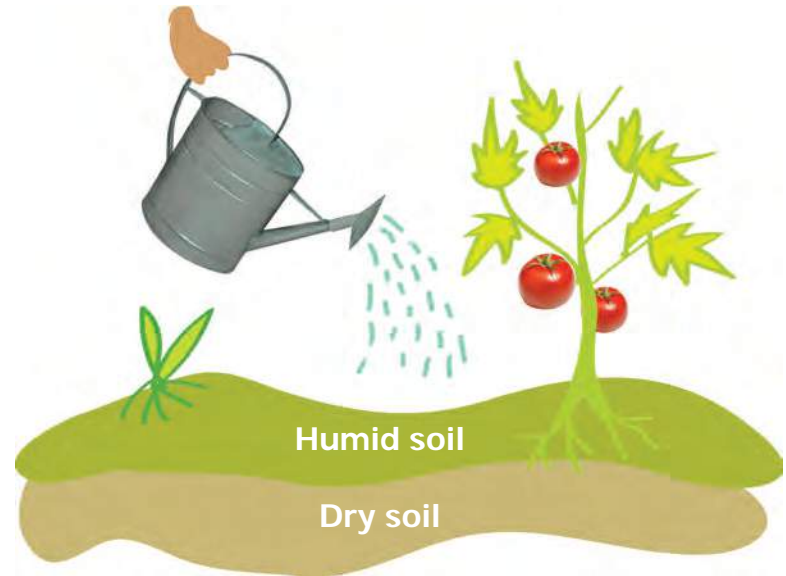

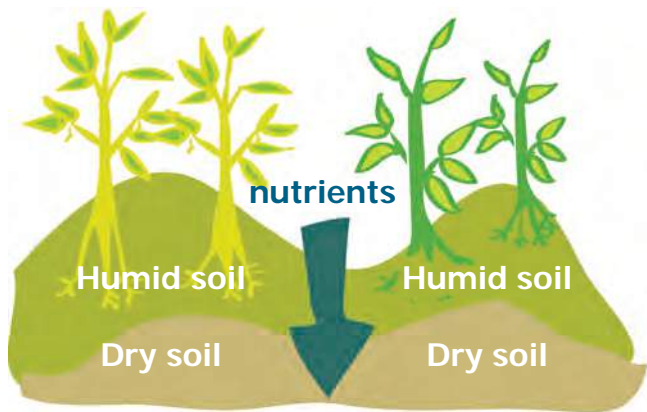

Caution!

If you water too much: The excess water will take nutrients deeper and out of reach of the roots. Also, too much water makes it easier for diseases to develop.

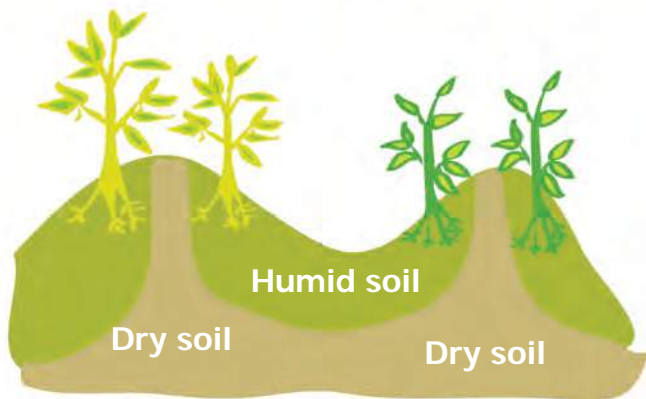

If you do not water enough: The roots will grow closer to the surface and will be unable to take advantage of the soil nutrients. The plants will be smaller and produce less.

How much water should I use and when should I water?

How much and when to water depends on:

1- The weather: If it is hot and dry, you need to water more often.

2- The type of soil: If the soil is sandy and loose you need to water more often, but with less water.

3- The type of vegetable to be watered: Some vegetables have deep roots and others shallow roots. The deeper the roots, the less often you need to water, but with more water.

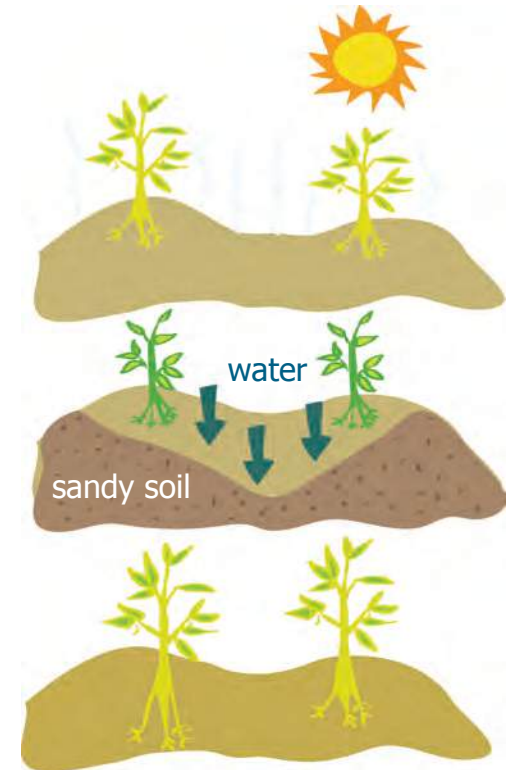

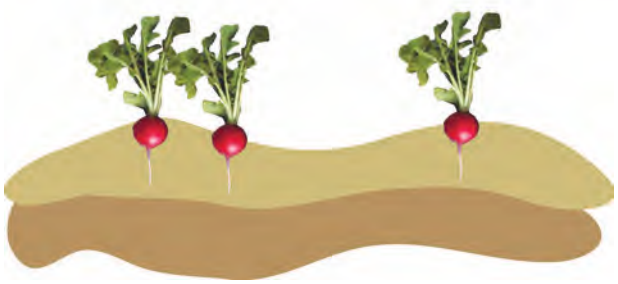
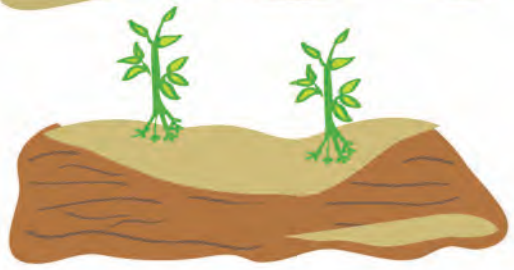

Test 20

Without looking at the previous page, circle the correct word.

1- If the weather is cool and wet, you need to water – **more** – **less** – often.

2- If the soil is heavy (clayey), you need to water – **more** – **less** – and with – **more** – **less** – water each time.

3- Vegetables with short roots need – **more** – **less** – water and more often.

You should observe the vegetable garden carefully to judge when and how much to water

You can do the following test:

Two days after watering, make a hole near the plant.

The moisture should be below the plant's roots.

Water should not be accumulated at that depth.

Important!

If the plant's leaves look droopy and lifeless, you should water them immediately, but it is better to prevent this from happening. The plants should always look firm.

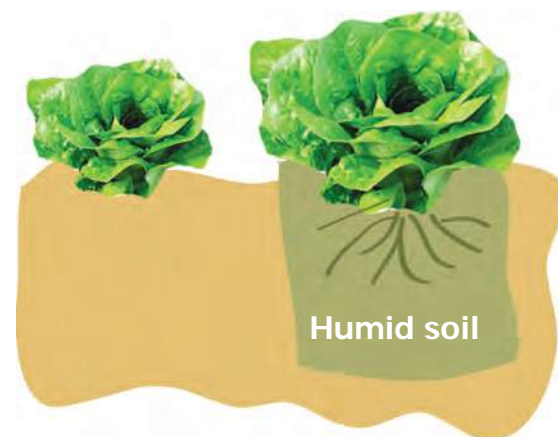

Answers to test 20

- 1- less
- 2- less - more
- 3- more - less

Furrow irrigation



Irrigation is easy but you need to take the following precautions:

- The furrows should have very little slope, so that the water does not carry away the soil and seeds.
- The water should run slowly, without becoming stagnant or breaking up the furrows.
- The water should not touch the plant directly.
- It is better to water in the mornings.
- While watering, watch the water's pathway and guide it with a shovel.

Sprinkler watering

You can water your seedlings and small garden with sprinklers. This is the most effective method when the slope is steep and water is scarce.

What should I use for watering?

You can use:

- A watering can
- A hose
- Perforated cans

How do I water?

Water plants with a fine mist.

When the seeds are just planted, you should avoid heavy gushes of water, because they can damage the seedlings by uncovering the seed.



Drinking water, as well as the water for producing vegetables has to be safe water!

There are different ways of water storage and disinfection.

Many people consider that storing water at home is essential in case of emergency, when no other source of water is available, or if the water source gets contaminated.

Why should we store water?

In many parts of the world, storing water is a daily practice, especially in households that are not connected to a safe source of clean water.

There are several ways that stored water can become contaminated:

- Contamination by hand on collecting water
- Contaminated collection containers (reused containers)
- Growth of bacteria (pathogenic proliferation)
- Potential presence of organisms resistant to disinfectants



Fortunately, there are ways of improving the quality of stored water

- Use new, or sterilized plastic containers, made for keeping food.
- Wash your hands before collecting the water, and avoid touching the opening or the inside of the top of the container, in which you are going to store the water.
- Fill the recipient container carefully, using the best water source available.
- Boil or treat the drinking water, which could have been contaminated, or treat with chemicals.
- Store the water containers in a cool, dark place.
- Consume or replace the stored water at least every six months.



Boiling—boiling the water for three minutes will kill any pathogen which is propagated through water.

Treatment with iodine—common domestic iodine (2 per cent U.S.P.) can be added using 5 drops per litre in clear water or 10 drops per litre if the water is not clear. Mix and wait for 30 minutes.

Treatment with chlorine—read the label of the domestic chlorine bottle, or add 10 drops of a solution of one percent of chlorine per litre of clear water. Double this quantity if the water is not clear. Mix and wait for 30 minutes.

You can also find commercial iodine or chlorine tablets in pharmacies and camping stores.



It is often difficult to access safe water, but there are several methods for having safe water at home:

Rainwater collection:



Solar disinfection

Heat, combined with the sun's ultraviolet radiation can inactivate pathogens found in water.

Fill transparent, recycled plastic bottles with untreated water, which shouldn't be too turbid, and expose to sunlight for six hours on sunny days (or two days during cloudy days), for example on the roof of your house.



The water should be used straight from the bottle, or poured into a clean container. You can drink the water as it is, or use it to prepare juice, cook, or water your vegetables.

Drip irrigation

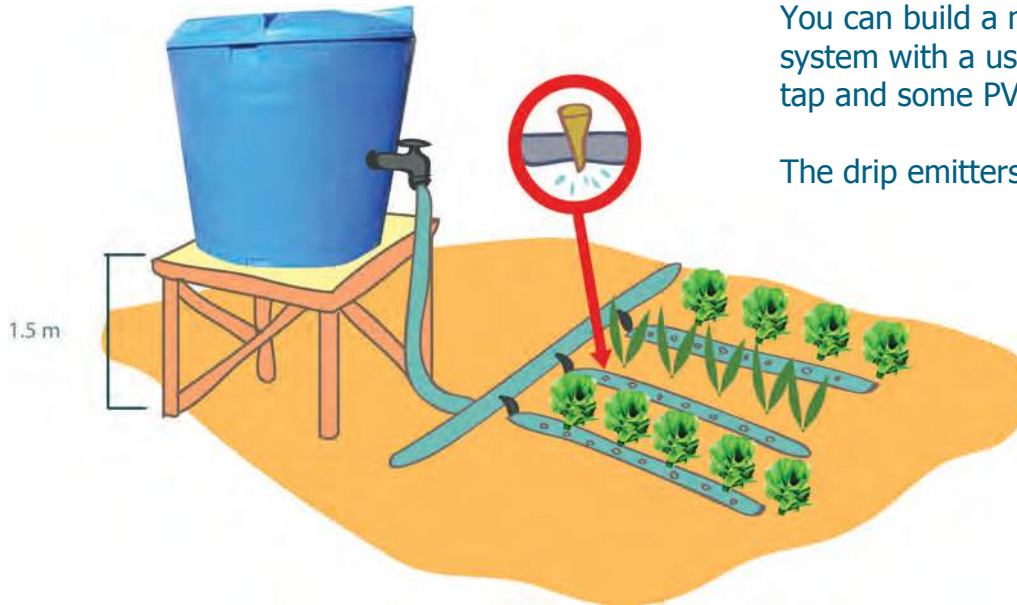

You can build a mini-drip watering system with a used 200-litre tank, a tap and some PVC pipes.

The drip emitters can be wooden screws.

Caution!

When you water with sprinklers, you wet all of the foliage, which may cause diseases to appear.

This is why it is best to water in the morning, so that the air and sun can evaporate excess water during the day.



Test 21

Connect the following by lines to make sentences:

If you water less...

you have to water more often.

If the plants are limp and wilted...

it is more effective to water with sprinklers....

If the weather is hot and dry...

the roots grow on the surface.

If the garden has a steep slope....

you have to water immediately.

2- Weed control

When plants that you have not planted - and do not want - grow in your garden, they are: weeds.

Weeds take away light, nutrients and water from the plants in your vegetable garden.

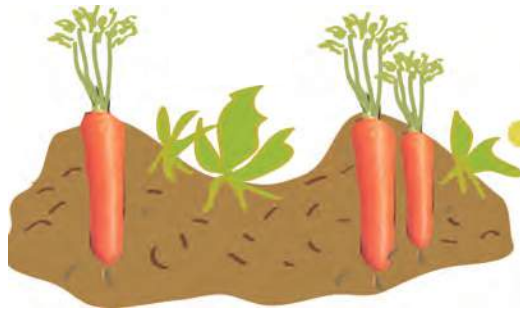

Answers to test 21

If you water less...

you have to water more often.

If the plants are limp and wilted...

it is more effective to water with sprinklers....

If the weather is hot and dry...

the roots grow on the surface.

If the garden has a steep slope....

you have to water immediately.

Weeds cause more damage when the vegetables are small and unable to compete for water and light.

You need to control weeds from the very beginning, by doing the following:

- Tilling the soil.
- Covering the soil with mulch.
- Being careful not to infect the garden with seeds of weeds, either during the watering or from weeds near the garden.
- Preventive control.



Soil tillage to control weeds

Tilling the soil to remove weeds consists of:

- 1- Stirring up the soil between the furrows with a rake.
- 2- Cleaning near the plants with a weeding hoe.

This should be done only on the surface to avoid damaging the roots.

This job has to be done when the plants are still small.



Mulch cover as weed control

You can cover the soil between the furrows with any of these materials:

- Organic compost
- Black plastic
- Dried grass
- Newspaper
- Dry leaves

What are the advantages?

- Weeds cannot grow because of the lack of light.
- The soil remains moist.
- The soil does not over heat during the day, nor get too cool during the night.
- The plant's leaves and fruit stay cleaner since mud does not splash. .
- Avoids erosion.



The best cover is organic fertilizer or compost. Apply a layer 5 to 10 cm thick between the furrows and around the plants.

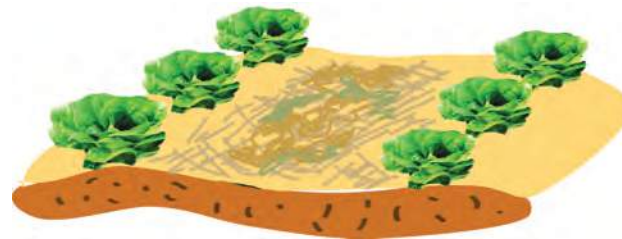

Preventive weed control



Mulch is another good way of controlling weeds

One way is using recycled plastic plates to make a crown around each plant, with the plate facing down. This impedes unwanted plants from growing around your crop, helps keep soil moisture in and avoids soil erosion.

What is preventive weed control?

It is the measures that should be taken to prevent an excessive increase in the growth of weeds on the soil.

What are those measures?

- Using good quality seeds that are not mixed with weed seeds.
- Using organic compost.
- Planting crops in rotation.
- If necessary, using something like nylon stockings to filter out weed seeds from water that is used for watering.
- Keeping the garden clean of weeds.
- Not using weeds with seeds in making organic compost.

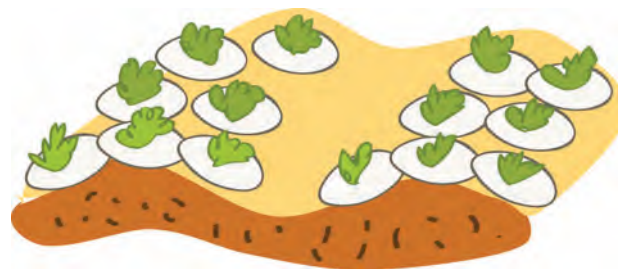

3- Cultivating

What is cultivating?

Cultivating is piling up the soil close to the base of the plant.

What tool is used?

The hoe.

When do you cultivate?

Cultivating on most plants it is done only once in the season, when the plants are fully grown and strong.





The advantages of cultivating:

- It helps control weeds
- It improves soil aeration.
- It preserves moisture.
- It helps to uphold the plants, making them more resistant to the wind and their own weight.
- It minimizes the attack of diseases.



4 - Pest control

Pests are small insects that reproduce quickly, causing serious damage to crops because they feed off the plants.

In many cases, the plants cannot resist pest attacks, and die.

Would it be worthwhile, having taken such good care of your vegetable garden, if you did not control the pests that could destroy it as well?

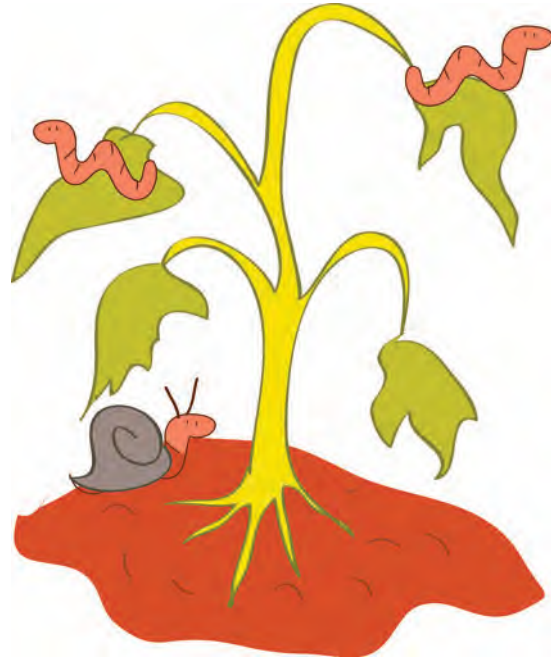



“Do not just follow the advice of friends or neighbors. Remember that chemical products are dangerous”.

Eliminating all the pests totally is not recommended.

You need to achieve a “balance”. The number of insects that remains in the garden after control should be low enough not to cause damage to the plants.

Preventive control:

There are some things you can do to control pests before they become a problem.

- Avoid the use of chemical insecticides which are very dangerous to your own health.
- Consult your local technician (Extension Officer) if the use of chemical products is inevitable, and select non-toxic products.

There are some pests which are more frequent in a vegetable garden

Worms or larvae.

Some worms are offspring of butterflies and emerge from the eggs 4 to 5 days after the butterfly has deposited its eggs on the backs of the leaves.



Aphids

Aphids are small flying insects of different colours, mainly black or green. They suck the sap of the plants and in consequence, young leaves and flowers, especially, become yellow, turn, and dry.



Slugs

Slugs appear in large quantities during the rainy season, when there is high humidity. They are active during the night and hide in dark places during the day. They eat the leaves of most of the vegetables.



Beneficial insects:

Not all insects feed off plants: some feed off other insects so they help control pest infestations.

Ladybirds or Ladybird beetles:

Ladybirds eat aphids, so therefore, help to control pests in a natural way. Ladybirds are colourful insects. They can be red, green, yellow and orange with black spots. They are 8 mm to 10 mm in size.



Recognize some beneficial insects.

Preventive pest control

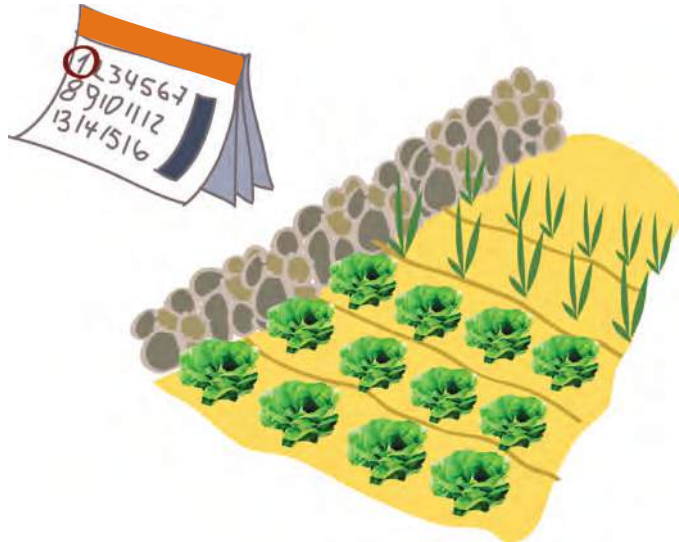

There are many things that can be done to “**avoid or prevent**” the destruction of plants by pests:

- **Crop rotation planting:**
Remember that you should change the kind of vegetables you plant every year, as we saw in chapter 2.

- **Remove all vegetable scraps:**
Insects may stay on the scraps in the field multiplying. Use vegetable scraps to make organic compost.



- **Use Inter-planting:** it will be more difficult for insects to spread if the plants are separated by other vegetables..



Some plants are beneficial to others when they are planted next to them. (See the table at the back of the Manual for information on which species to combine)

- **Choose vegetables that are more resistant:** some insects do not cause too much damage to some vegetables.
For example: Swiss chard, leeks, lettuce, onion, parsley, peas, spinach and others.

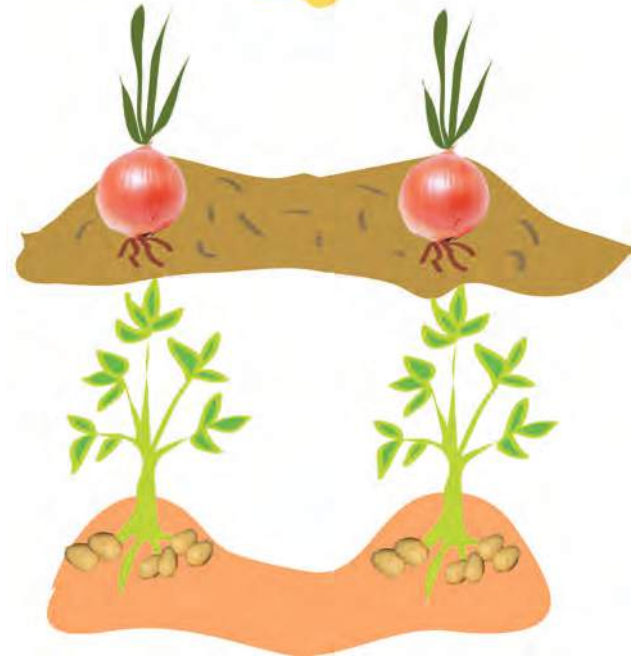

- **Take good care of the vegetable garden:**
If the plants are big and strong the insects will not cause as much damage.

Pest control methods



Traps: Traps are better for catching some pests.

- **Slugs:** Place boards on the soil between garden plants. During the day the slugs will hide under them where you can trap them easily.



- **White flies, aphids and thrips:** Paint the inside of a not too deep can a bright yellow. Half-fill the can with water then hang it on a pole. The insects will be attracted by the colour and will drown upon falling in the water.

Use concentrated soap solution. Apply with a sprayer to control aphids and small larvae.

- **Barriers:** You can prevent grubs from damaging small plants by placing rings made of cardboard around them.

When the plants grow and bypass the ring they are strong enough to resist the grub attacks.

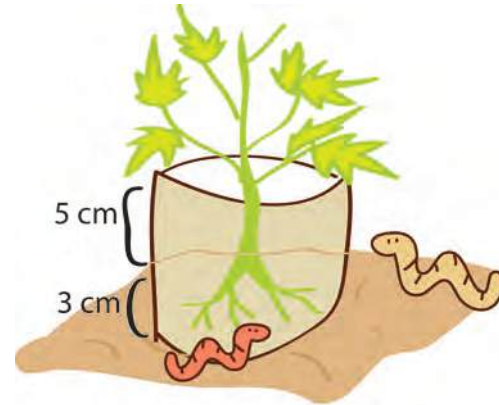

- **Sprays:** There are some substances that do not damage plants or people yet help control infestations.

Example: Soap solution, to control aphids, spider mites and white flies. Mix 2 teaspoonful of detergent or liquid soap in 4 litres of water.

Use this liquid to spray plants completely. Wash off the soap with clean water.





- **Collection:** The whole family can trap insects by hand. Cutworms, weevils, chinch bugs, beetles and many others are easy to trap because they are large.

- **Colour traps:** Use blue, yellow or White plastic flags covered with used engine oil to capture insects in the garden.

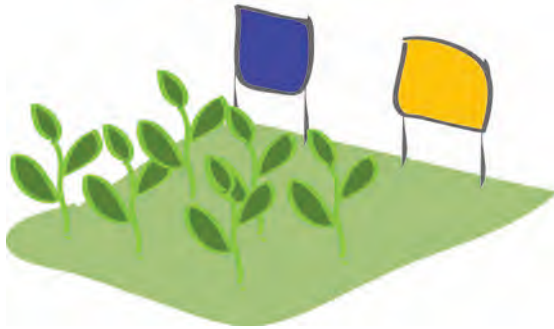

Test 22

Circle the correct word:

- 1- It is better to plant vegetables that are more – **resistant** – **common** – to pests.
- 2- If you use chemical products you have to – **consult** – **avoid** – the local technician.
- 3- There are insects that help – **increase** – **control** – pests.



5 - Disease control

There are many diseases that affect plants, damaging crops and stored vegetables.

When is a plant sick?

Sick plants look:

- Yellow or another unnatural colour.
- Faded or wilted.
- Weak
- With rotten fruit.

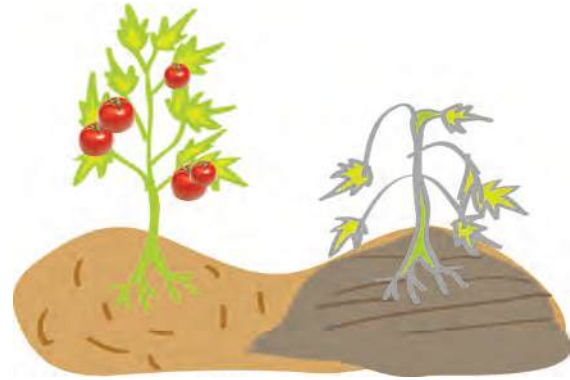

Healthy plants

Sick plants

Answers for test 22

- 1- resistant
- 2- consult
- 3- control



Warning!

When the disease has reached an advanced stage, the plant cannot be saved.

You must prevent the disease from spreading and affecting other, healthy plants in the garden.

Preventive control is very important. You need to take the necessary precautions. The conditions in the garden should not be favourable for disease.

Preventive control will not let diseases be a problem



Some measures are:

Crop rotation: Do not plant vegetables from the same family in the same spot. Diseases can remain in the soil from one year to the next. (see Chapter 2)

Resistant varieties: There are many varieties of vegetable resistant to one disease or another.

If necessary, consult your local technician (Extension Officer) to find out if the vegetable varieties you want to use are pest-resistant or not.

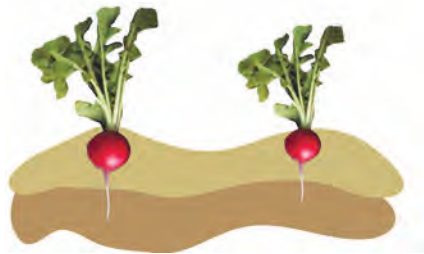



Do not leave vegetable scraps lying around: Always use vegetable scraps to prepare organic compost. If you leave them on the ground, they can contaminate the next season's crops.



Insect control: Some insects can also transmit diseases like viruses.



Weed control: Weeds help to create a humid environment that encourages the development of diseases. Remove weeds promptly.

Be careful that water does not stagnate: Water must not stagnate in the furrows. If this happens you should make exit channels.

Do not plant too densely: Plants should not be too close to one other (planted too densely). This encourages humidity and disease development.

Protect the fruit: You can protect fruits that have bent towards the ground because of their weight with guide stakes or trellises. For example: tomatoes, melons, pumpkin and watermelon.



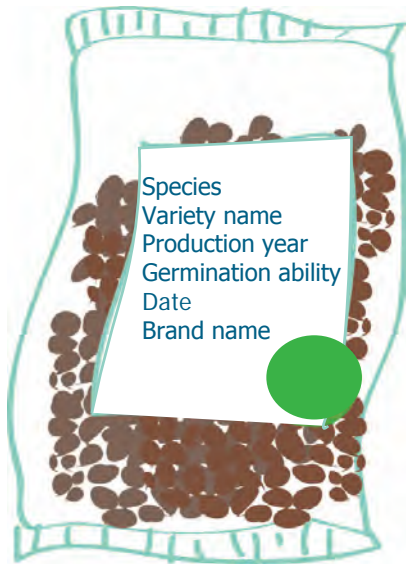

Use good quality seeds: Seeds can also contain diseases that appear afterwards in the vegetable garden.

Plant in the right season: Each vegetable should be grown at the correct time. Consult the chart at the back of the Manual.

Warning!

There are chemical products that prevent disease, but it is better not to use them because the majority are also dangerous to your own health. Consult your local technician (Extension), if absolutely necessary, about non-toxic products.





In this chapter we have seen:

- 1- Watering.
- 2- Weed control.
- 3- Cultivating.
- 4- Pest control.
- 5- Disease control.

Test 23

Place a "T" in the circle if the sentence is true and an "F" if it is false.

- 1- It is important to add the necessary water to the soil.
- 2- Sandy and loose soils need to be watered less frequently.
- 3- Deep rooted vegetables need more water at every watering.
- 4- If you use an irrigation watering system, the furrows should have a slight slope.
- 5- Decomposed manure has more weed seeds.
- 6- Weeds take away nutrients, water and light from garden vegetables.
- 7- Sick plants can be healed.
- 8- Yellowing and wilting may be the symptoms of a disease.

○
○
○
○
○
○
○
○

If all your answers were correct you can go up another step. Congratulations!

Answers to Test 23

- 1- T
- 2- F
- 3- T
- 4- T
- 5- F
- 6- T
- 7- F
- 8- T

If two or more of your answers were incorrect you should review the material in Chapter 7.

Expert
Chapter 9
Chapter 8
Chapter 7
Chaper 6
chapter 5
Chapter 4
Chapter 3
Chapter 2
Chapter 1

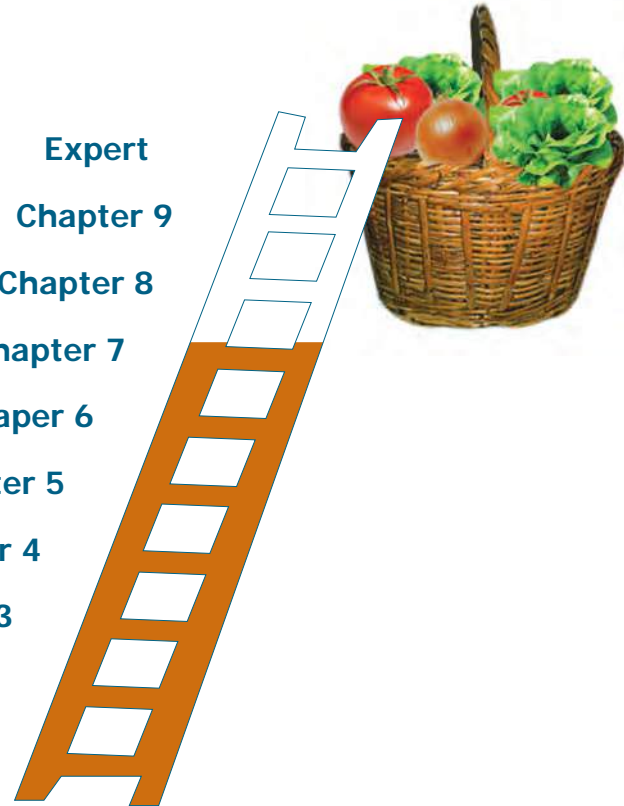

Chapter 8

Harvesting, storing and processing the vegetables.

The whole family's efforts have been fruitful. Now it is time to reap.





Just a few more steps and you will be, Expert Horticulturists!

Now we will see:

- 1- Harvesting
- 2- Storing
- 3- Processing vegetables

1- Harvesting

Vegetables have to be harvested at their exact point of ripening.

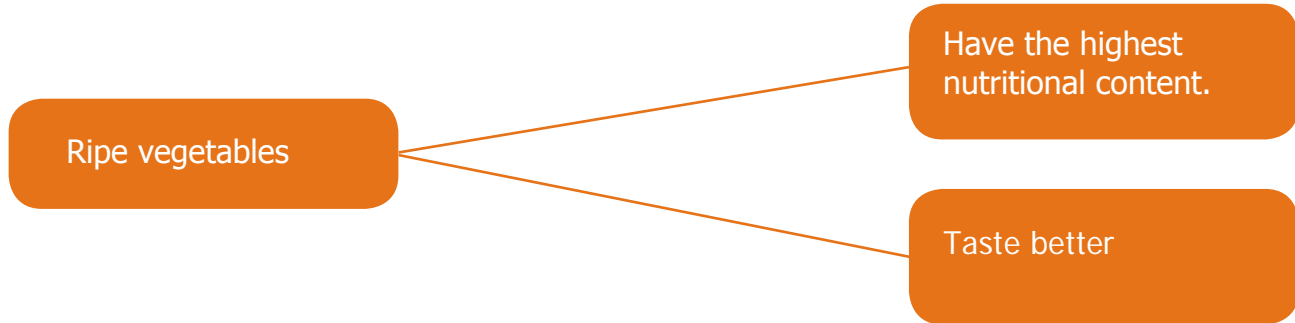

Remember...

Most vegetables shrivel easily when they are harvested green. The quality of vegetables is highest when they are ripe and ready to be harvested.





are very small

Some produce that is harvested too early will never have the flavour or nutritional value that ripe vegetables have.

You should start getting to know every vegetable. With practice you will get to know the exact moment to harvest each one.

Vegetables that are harvested too late (overripe) will rot and are unsafe and unpleasant to eat.

In the chart at the back of this Manual you will also find information on harvesting vegetables.



- Harvest during the coolest hours of the day, early in the morning or late in the afternoon, when it has cooled down.
- Place everything you harvest in the shade as you go.
- Handle the produce carefully. It should not be bruised or torn with your nails.
- Harvest when the leaves have dried. In the case of onions, garlic, pumpkins and potatoes, you should harvest when the plant is dry. This means that the edible part is ready.

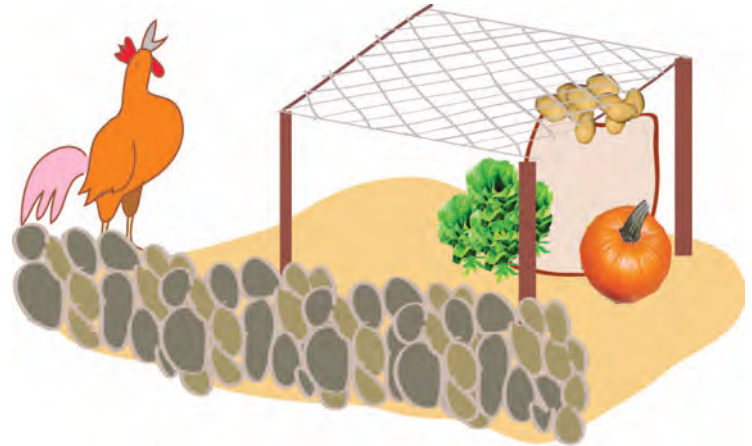



- Use a very sharp knife to cut leafy vegetables and to separate the edible part from the plant.

- Before harvesting root and bulb vegetables, loosen the soil with a strong garden fork to avoid having to pull at the plant, which may damage it.

- Leave a bit of stem (the peduncle) attached to the fruit. A piece of stem is left on many fruits like melons, pumpkin and peppers, so that diseases do not enter through the incision made when removing the stem.

2- Storage

If you want to always have fresh vegetables on the table you should harvest them only as needed.

Your garden is the best place to keep vegetables fresh!

If you want always to have vegetables ready to harvest plant them in relays (appropriate interval). (See Chapter 2)





There are some vegetables that must be harvested all at once and, therefore these need to be stored.

Some of these are: onions, garlic and pumpkins.

These kinds of vegetables are easy to store, but they need some special attention, as we will see further on. Nevertheless, most vegetables spoil quickly. You need to keep them in a cool place and only for a short period only.

How do you store vegetables?

Most vegetables are easy to store. Some precautions are:

- Eliminate vegetables that are soft, damaged, and sick or infected with pests, as they will affect the healthy vegetables.
- When you cut the leaves on root vegetables like carrots, beets and radishes, trim tops to 1 cm.

Leaves of beets and radish can also be consumed.

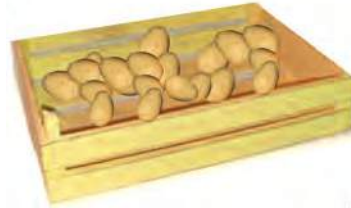

Every vegetable is stored differently, according to its characteristics



You can store vegetables in any room, which is neither too cool, nor too hot. Also, vegetables always should be stored in a shady place.

Some fruits, such as tomatoes and melons, can be harvested before reaching maturity and kept until they can be eaten.

Others, like onions and garlic, have to be cured/dried after harvested or harvested when they are dry, and kept in bags or nets.

Most vegetables need to be stored in a very cool place (10-15 °C).

- In the coolest room in the house. The basement is the best place.
- There always should be room for air to circulate.
- You can store vegetables better and for longer periods if you have a refrigerator.

You can use paper or cloth bags to protect the vegetables. Do not store in black plastic bags.



3- Processing the vegetables



You can take advantage of the produce of your vegetable garden and make preserves. In this way, you will be able to consume vegetables throughout the year. Home recipes will help you preserve vegetables for longer periods.

If the preserves are not prepared correctly, they may get contaminated with organisms that are dangerous to your health. It is always better to consult an expert.

Knowing how to store and process your vegetables properly will help improve conserve their nutrients.

Cooking the vegetables

A simple, cheap way of preparing vegetables is by cooking them. This will preserve their nutritional properties.

There are different ways of doing this:

1. Boiling: Wash the vegetables, cut them into small pieces and put them in boiling water until they are soft. Don't overboil.
2. Steam: Avoiding water getting in contact with the vegetables. Wash the vegetables, cut them into small pieces and put them in a small container or stainless-steel sieve. Put the sieve on top of a pot of boiling water, and cook the vegetables in the steam. Steam preserves the nutrients better.



Vegetable	Cut the vegetable	Boiling time
Green peas	Take seeds out of pod	7 minutes
Cabbage, spinach	Use the leaves	1 - 2 minutes.
Carrots	Cut in slices, small pieces	1 minute
Beans	Cut ends and into small pieces	7 minutes
Green pepper	Cut into stripes	2 minutes
Onion	Cut into slices	3 minutes
Cauliflower, broccoli	Remove leaves and cut smaller pieces	3 minutes
Cucumber, zucchini	Cut into slices	Do not boil

What preserves can be prepared?

Whole tomatoes.
Tomato sauce.
Jams: tomato-strawberry or
strawberry-melon.

Dehydrated vegetables: You can sun-
dry green peppers and hot peppers.

Pickling: cucumbers – hot
peppers – cauliflower –
eggplants – carrots – cabbage – small
onions

Sweet and sour cucumber, carrot or
zucchini.



For pickling, you need to get home recipes from the local expert or your neighbours.

Making jams and jellies is very easy. Start preparing preserves by trying this simple recipe.

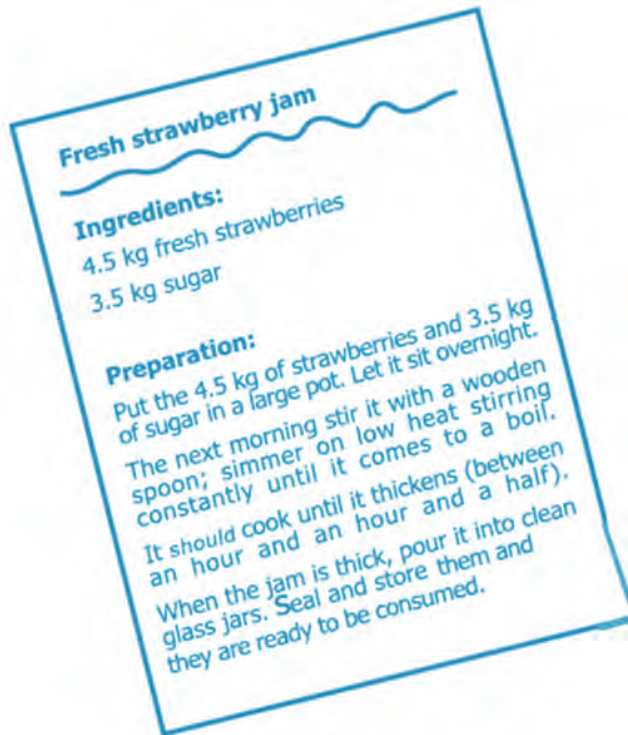

Garden recipes

RUSTIC SALAD

Portions: 5

Portion size: 1 cup

INGREDIENTS

Cucumber	1 unit
Celery 3	stems
Tomato	4 medium-sized units
Radish	6 small units
Lettuce	½ unit
Carrot	2 medium-size units
Coriander	chopped
Lemon juice	¼ small cup
Salt	1 pinch

PREPARATION

1. Wash and disinfect the vegetables properly.
2. Cut the celery stems in small cubes.
3. Cut the tomato, radish and cucumber (peeled).
4. Peel and grate the carrot.
5. Tear the lettuce leaves into small pieces using your hands.
6. Put all ingredients into a bowl.
7. Add the lemon juice, salt and coriander.
8. Serve



SPINACH OMELETTE

Portions: 10 -12

Portion size: 60 gram

Ingredients

Spinach leaves	2 cups
Vegetable oil	½ cup Chopped
tomato	3 units Chopped
onion	2 units
Eggs	5 units
Salt	1 teaspoon ful



Preparation

1. Wash and disinfect the vegetables.
2. Select green leaves which are in good condition. Cut them into small strips.
3. Stir-fry the tomato and onion for 5 minutes in a pan, and add the chopped spinach for 2 minutes.
4. Mix the eggs with salt in a separate container.
5. Add the stir-fried vegetables to the eggs.
6. Heat a little vegetable oil in a pan and add the mixture little by little. Cover it.
7. Cook until some bubbles appear and turn the omelet over.
9. Remove from the pan and serve hot.

NOTE: In case you don't have a non-sticking pan, you can also use an ordinary pan, adding oil and flour, and covering after adding the omelet mixture. Cook on a low heat and don't turn over.

BEETROOT LEAF STEAK

Ingredients :

- 6 beetroot leaves
- 1 egg
- 100 grams of flour
- ¼ cup of oil
- 1 cup clear chicken broth
- Salt and pepper



Preparation

Wash beetroot leaves and strain. Mix two eggs with flour and chicken broth in a small bowl until obtaining a uniform paste. Add salt and pepper. Soak beetroot leaves in this mixture. Heat oil in a frying pan and fry soaked leaves on both sides until they are crisp.



VEGETABLE PIE:

Ingredients:
8 portions

4 leaves of Swiss chard
1 medium cauliflower
1 medium broccoli
1 small zucchini
½ kg green beans
½ kg wheat flour
2 medium cups of milk
100 g grated cheese
50 g butter
1 egg
Salt



Preparation:

Wash the Swiss chard, cauliflower, broccoli and green beans and cut them into small pieces. Add salt. Boil vegetables in a medium pot for 3 minutes.

Cut zucchini, into cubes and add to the boiled vegetables and mix with the egg. Mix butter and wheat flour in a separate bowl until you obtain a solid dough. Grease and spread the dough in a baking pan. Add the vegetable mix and cover with cheese. Bake in the oven for 30 minutes. Cool the pie a bit before serving.



In this chapter
we have seen:

Harvesting and storing
of the produce.

- 1- Harvest
- 2- Storing
- 3- Processing

Test 24

Place a "T" in the circle if the sentence is true and an "F" if it is false.

1- Ripe vegetables have the highest nutritional value.

2- Most vegetables shrivel more easily if they are harvested while still green.

3- Air circulation is not important for stored vegetables.

4- You should harvest in the coolest hours of the day.

5- Unripe tomatoes and melons are stored at low temperatures.

6- You can make "preserves" with leftover produce and store for use throughout the year.

7- It is a good idea to get organized with friends and neighbours to sell the produce.

8- To make preserves you need to follow recipes properly and to take care that they do not get contaminated.

**If all your answers were correct
you can go up another step.
Congratulations!**

Answers to Test 24

- 1- T
- 2- T
- 3- F
- 4- T
- 5- F
- 6- T
- 7- T
- 8- T

If two or more of your answers were incorrect, you should review the material in Chapter 8

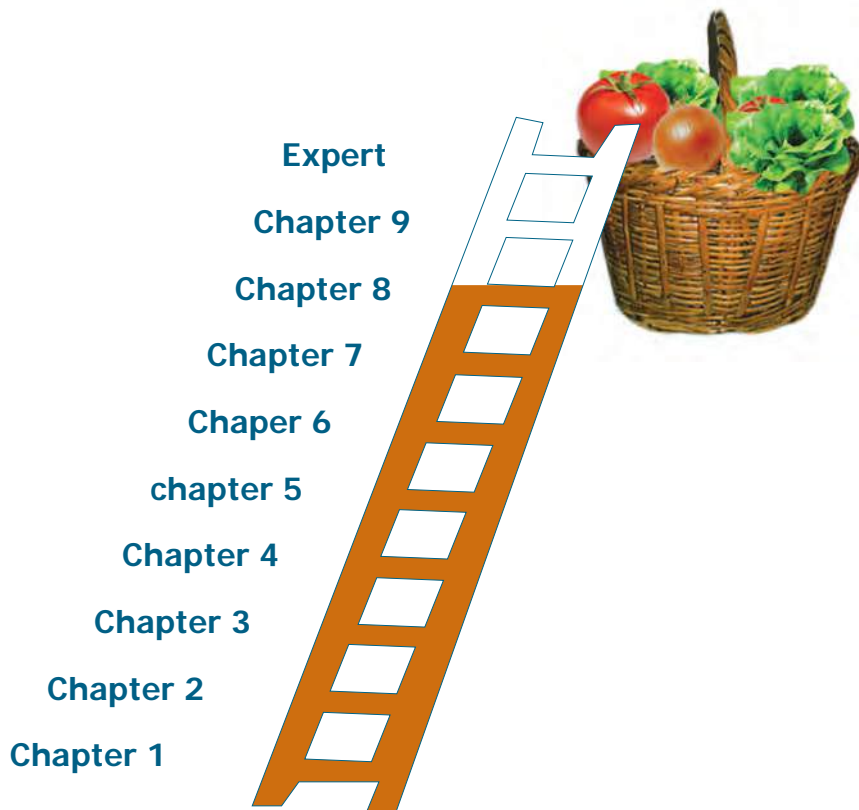



Chapter 9

Breeding poultry and rabbits and feeding them from your home garden



Why breed yard fowl?



Yard fowl are sturdy birds that are resistant to disease and pests. They feed on seeds and indigenous plants, insects and kitchen waste.

So, why is it good to breed poultry? You could say that the benefits are threefold, because yard hens provide:

- a. Eggs
- b. Meat
- c. Chicks



In order to get good results from breeding creole fowl, you must make sure three things:

Well- developed crest and comb

Plumage clean and groomed



breast fleshy

- 1- Have proper facilities.
- 2- Breed the best birds
- 3- Feed them well

In choosing good Creole fowl, look for:

Birds from your own area about five-to-six months old that look big and healthy.



Whith at three fingers between pelvic bones

How to choose a good yard rooster

The yard rooster should be from a good laying hen and his siblings should be early layers. He should be big and healthy, and his crest, beak and talons should be well developed. He should display early sexual demeanour and have good mating habits that do not injure the hens. A rooster is capable of mounting hens by the age of 8 months.

A rooster is not good for breeding if he only mounts a few hens or if no chicks result after the eggs have been incubated.



How to build the fowl coop

Build the fowl coop on hard, dry, level ground that does not flood when it rains.

Use materials that are around the yard, such as wood, zinc, wire, mesh, bamboo or any robust, durable material.

The fowl coop could be two metres long and one-and-a-half metres wide by one-and-a-half metres tall. The hens will roost in the coop, and lay their eggs there.

The floor must be covered with a layer of material that does not get wet easily, and that is easy to find in the surroundings at no cost.

What kind of material could this be? Wood chips, rice husks, sugarcane bagasse, dried banana leaves, straw or chopped dried grass.



Building materials needed for the fowl coop

You need feeding and drinking troughs, nest boxes and perches.

Make the drinking troughs by hanging plastic bottles horizontally at breast height to the fowl, and fasten them with a strong strap so that the birds can drink from both sides.

Make the feeding troughs likewise.

The perches are the bars on which the fowl roost. Place them high up in the coop, 60 cm above the ground.

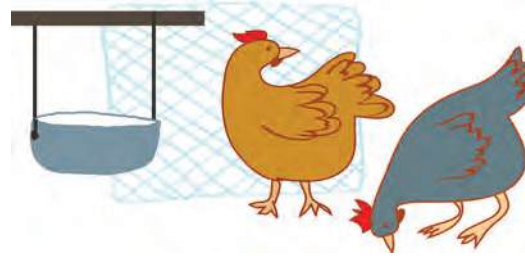

The nest boxes can be built of wood or bamboo. Place a bed of leaves, dried grass or wood chips in the nest box. Place the nest box up high so that the birds have to jump.

The nests must be in darkness so that the hens can rest peacefully. One nest box is large enough for three yard hens.



What is a semi-grazing system?

A semi-grazing system is a technique used for raising fowl free range in the day and sheltered at night. The coop where the hens roost must be inside a bigger yard that is divided into two areas, side by side, that are to be used alternately. The reason for this is that, if there were only one big yard, the grass and herbs would be eaten in next to no time and the ground would be stripped bare.

In the yard, the fowl scratch for beetles, maggots, earthworms and insects that are high in protein and a delicacy to them.

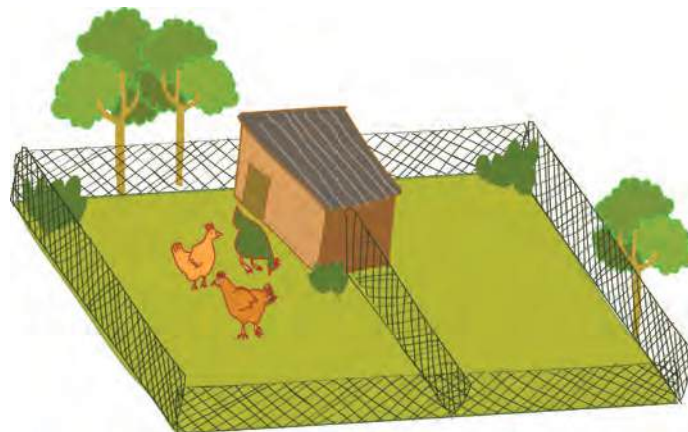

This keeps the hens happy and productive. They don't damage any crops growing in the garden. Keep ten hens and one rooster in a 12 m² yard, that is, 4 metres long by 3 metres wide (12 feet x 9 feet).

Surround the yard with stands of Gliricidia or Mexican Lilac, Trichanthera, or with fodder plants such as hibiscus, ramie, mulberry, pigeon peas, tree marigold (*Tithonia diversifolia*) or others that grow in the area. These will provide food for your hens.

The nutrients that hens need

The hens need a balanced diet, one that contains all the nutrients they need for fast, healthy growth and development and for producing meat and eggs.

Proteins

Proteins help the development of muscles (meat), internal organs, skin and feathers. They enable growth and increase egg-laying.

Vitamins

Vitamins are needed for producing eggs, and for growth and the formation of bones and feathers. They help to coordinate movement.

Minerals

Minerals such as calcium and phosphorus are important for bones, the formation of eggs, and for blood circulation.



flour of Gliricidia sepium



Eggshells



Tree marigold flour



Salt



Bones

Carbohydrates and fats

Carbohydrates and fats provide the poultry with energy for digestion, movement, growth and reproduction.

Maize



Plantain flour



Cassava flour



Water

Both, the body of the fowl and the egg are made of water. Water helps the digestion and transport of nutrients. It also controls body temperature.



So, how do we feed the hens?

Grains are very important in the hens' diet. Maize is especially important because not only is it very nutritious but it also provides carbohydrates and makes the yolk of the egg more yellow.

The protein bank is a plot of land planted with fodder bushes of high protein content, such as pigeon peas, soya, Gliricidia, or Mexican lilac, trichanthera, tree marigold, mulberry, hibiscus, ramie, and so on.

Where can you find a source of animal protein for the hens?

The main sources of protein are insects, earthworms and grubs. In order to have them at hand, you need to raise them in larval hatcheries.

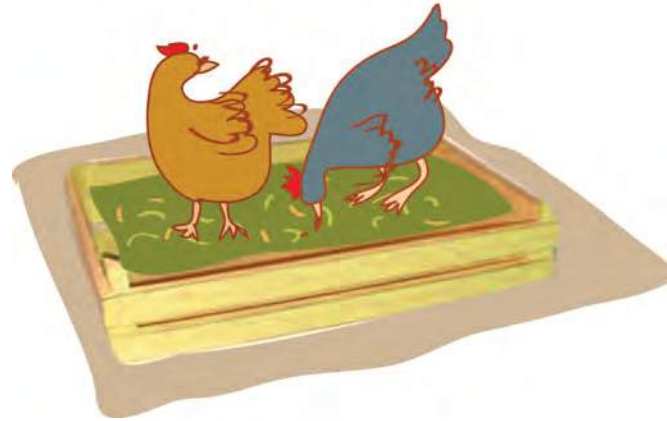

Building a larval hatchery

- Dig a hole 10 cm deep and 1 1/2 m wide by 2 m long.
- Fill with agricultural waste, stubble and animal manure.
- Water and cover with branches or plastic.
- Water twice a day.
- Uncover the hatchery after four days so that the fowl can eat the worms.
- Remove the soil after the hens have picked at it for one day.
- Fill again with agricultural waste and animal manure.
- Water and cover once again.

The hens need minerals to help them grind their food and they need calcium for the formation of the eggshells.

Collect the eggshells, dry them by the fire or in the sun, and mash them before feeding them to the hens. This will help them to lay eggs with stronger shells.

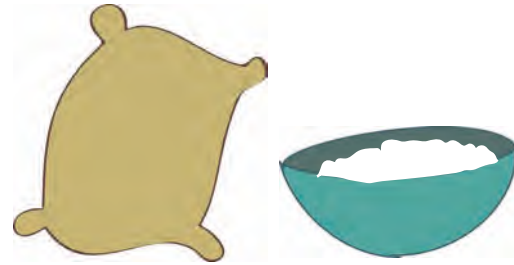

GROUND EGGSHELL

The hens get 80% of the calcium they need from the eggshells.

They can get vitamins from leaves of Swiss chard, lettuce, carrot or any other vegetable you have in your home garden.

They like kitchen waste very much, especially vegetables, fruit, cooked rice, banana, and so on. They also like crop residues such as rice and corn husks, and guava, banana and other fruit.

Don't give the hens salty or fatty foods because this makes them fat and they stop laying eggs.

A properly-fed bird stays healthy, is more productive and is worth much more!



Why is it so important to produce your own food for your poultry?

- It is cheaper
- It doesn't need to be transported
- The raw materials are on the land
- and you will always have food for your poultry.



Standards of hygiene

- Do not mix ducks, turkeys, geese or guinea fowls with the yard fowl because your poultry can be infected with the diseases carried by these birds.
- Remember to wash the feed and water troughs daily, and to pick up the broken eggs because they can contaminate the nests.
- Clean and disinfect the bedding and mesh of the coop.
- Remove sick birds from the coop so that they don't infect the other fowl, and treat them in an area far away from the coop.
- Dead fowl should not be eaten because of the health risk and they must be buried covered with quicklime.
- The poultry manure can be spread over the empty half of the enclosure in the yard
- De-worm the hens every four months to keep them free of worms.



In this chapter, we have looked at:

- Raising Yard fowl
- Buildings and equipment
- Types of feed
- Standards of hygiene

Test 25

Insert a "T" if the statement is true, and an "F" if it is false.

- a. All you need to get good results with Creole Yard hens is a suitable place to raise them ().
- b. A Creole Yard rooster is ready for reproduction at eight months of age ().
- c. The floor of the fowl coop can be left without bedding and it doesn't matter if it gets wet ().
- d. The drinking troughs are best placed at breast height to the bird to improve drinking habits ().
- e. The semi-grazing system is a technique that keeps the hens shut in permanently ().
- f. Fodder plants are not a source of food for Creole yard hens ().
- g. Proteins, fats, carbohydrates, vitamins, minerals and water are necessary nutrients for poultry ().
- h. The pigeon pea, ramie and hibiscus are plants that supply poultry with calcium ().
- i. Creole Yard hens can share the coop with other birds like ducks, turkeys, or guinea fowls, because one species cannot infect another ().
- j. It is necessary to clean and disinfect the feeding and drinking troughs and sleeping areas constantly ().

Test 25

Correct answers:

- a. F
- b. T
- c. F
- d. T
- e. F
- f. F
- g. T
- h. F
- i. F
- j. T



If two or more of your answers were incorrect, please revise the topics in this chapter.

The breeding and care of rabbits

Breeding rabbits is advantageous, because:

- Their meat is high in protein
- Rabbits feed on products and by-products of the home garden
- They breed easily
- They are not noisy or smelly
- They occupy little space
- Their skins can also be used



Breeding rabbits successfully requires:

- Good quality animals
- Good management
- Suitable food
- Strict sanitation

A healthy rabbit has immaculate, lustrous fur, sparkling eyes, and straight, clean ears. It does not have a runny nose or excess fat.

Choosing males and females

- In breeding rabbits at home, you can start off with three females (does) and one male (buck).
- The varieties that are bred for meat that you can choose from are New Zealand, Californian and Butterfly.

Installations

- The hutch should be located in a cool place, without moisture or draughts but with good ventilation, not too much light and protected from other animals.
- You can use materials that you can find around the yard, like bamboo, wood, zinc, wire, mesh, or any robust, durable material.



You will need a hutch with six chambers distributed as follows:

3 for the does, 1 for the buck, 1 for breeding and 1 for fattening.

- The hutch must be easy to clean, manage and disinfect.
- The measurements for the hutch can be 50 cm deep and 60 cm wide by 30 cm high.

The floor should be of bamboo.

The manger should be made from metal, so that the rabbits do not destroy it with their teeth.

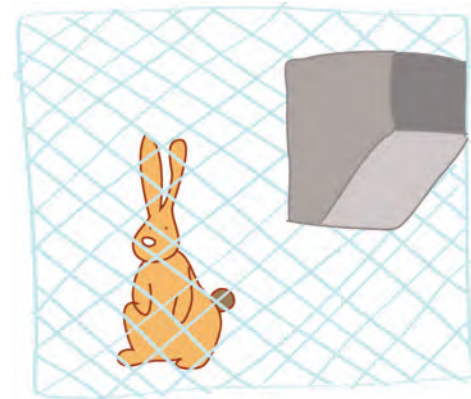
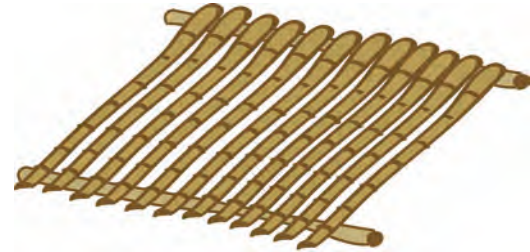

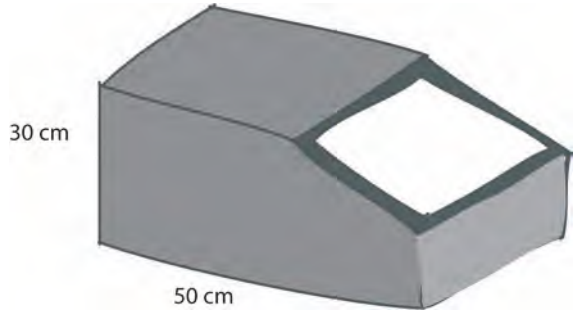

Build the nest box of wood, 50 cm long by 30 cm wide and 30 cm high.

Make the water trough by using a recycled plastic bottle: pierce a hole in the cover and insert a marble before inverting the bottle.

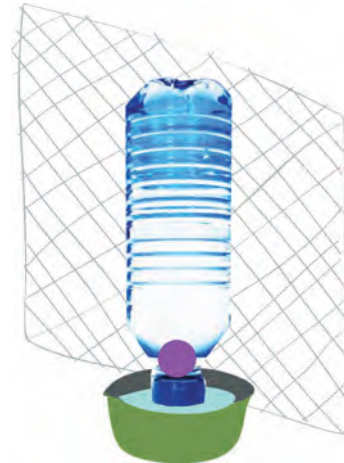

Breeding, gestation and rearing

Handling

Rabbits are not grasped by their ears, but rather by the skin on their shoulders.

Mating

The best time for mating is when the vulva of the doe turns red. Mating must not occur until the doe is at least 4 months old and weighs more than 3 kg (6.5 lbs), and the buck is at least 6 months old and weighs more than 4 kg (9 lbs). Remember that the doe must be taken to the hutch of the buck.



Gestation

During gestation, the foetuses grow within the womb of the doe. The doe now needs dietary supplements. The gestation period is 30-32 days, averaging about 31 days. The doe should be palpated around 10 to 15 days after mating to find out whether she has been impregnated and, if not, she should be taken to the buck again.

Placement of the nest box

A nest box with dry grass bedding must be introduced three days before the birth, that is, 28 days after mating.

Delivery

Delivery generally occurs at night and the doe drinks a great deal of water. It is recommended not to intervene until after the doe has drunk water.

Post-partum handling

It is advisable to wait three hours before examining the rabbit kittens. After three hours, check the nest to remove dead kits and make a note of the number of young rabbits born dead and alive. Change the dry grass if it is dirty and see if the doe has removed enough fur to line the nest. If not, you can add some more fur to the nest.

Lactation

The doe nurses the kits for 20 days, after which they begin to eat fodder. After 25 days, remove the kits from the doe's nest box. Weigh the whole litter of young rabbits at 21 days to assess their rate of development. The litter should weigh between 1.8 kg and 2 kg (3.5 - 4 lbs).



Weaning

Weaning is the separation of the young rabbits from their mother. This takes place 25 to 30 days after they are born. The kittens are removed from the doe. On weaning, the kittens are weighed (the weight of each kit ranges between 500 and 600 grams (1 lb)). The weight is written down in the doe's file along with the number of young rabbits weaned.

Fattening

Fattening refers to the period between weaning and slaughter.

At three months of age, the males and females that are going to be kept for breeding are selected.

The reasons for not enough weight gain are:

- Too many rabbits in the hutch
- Not enough food or poor quality food
- Not enough water (barren does and bucks drink $\frac{1}{4}$ litre per day, gestating does $\frac{1}{2}$ litre per day, and nursing does 2 litres per day)

Replacement

Each doe has a serviceable productive life of nine to twelve months, equivalent to six or seven deliveries.



Sexing: Determining gender



Buck (male)



Doe (female)

Food

A balanced ration of fodder plants should be used, such as mulberry, tree marigold, imperial and, most importantly, pre-germinated maize.

The rations recommended according to the stage of production are, as follows:

Days of age	Grams per day
30 to 40	30 to 40
40 to 50	50 to 70
50 to 70	80 to 90
Gestating females	100 to 120
Lactating females	300
Males	150



Legumes – fresh maize – young grass – flour granules



The advantages of using fresh fodder are:

- Savings in the amount of rations used
- The fodder is well accepted by the rabbit
- Home garden produce such as lettuce, Swiss chard, spinach, carrots, celery, peas, beetroot and willow leaves, clover and grass, can be used.

Feeding rabbits with raw potato peel is not recommended.



Sanitation



Observe the following basic recommendations to keep the rabbits free of disease.

- (a) Avoid an accumulation of dung on the floor of the hutch
- (b) Clean the floor daily
- (c) Bleach and disinfect the floor at least once a month
- (d) Wash the water troughs at least once a week and refill with clean, fresh water
- (e) Purge the animals every six months.

Slaughter

After being left to fast for 12 hours on water only, remove the animal from the hutch, grasping it by the ears so that the flesh does not bruise.

Hold the animal by the hind legs and strike on the nape with a club. Slash the blood vessels in the throat so as to drain as much blood as possible. Remove the entrails and hang the carcass to aerate before refrigeration. If the skin is to be used, it must be stretched on a wire extensor with the fur on the inside and left in a cool place.

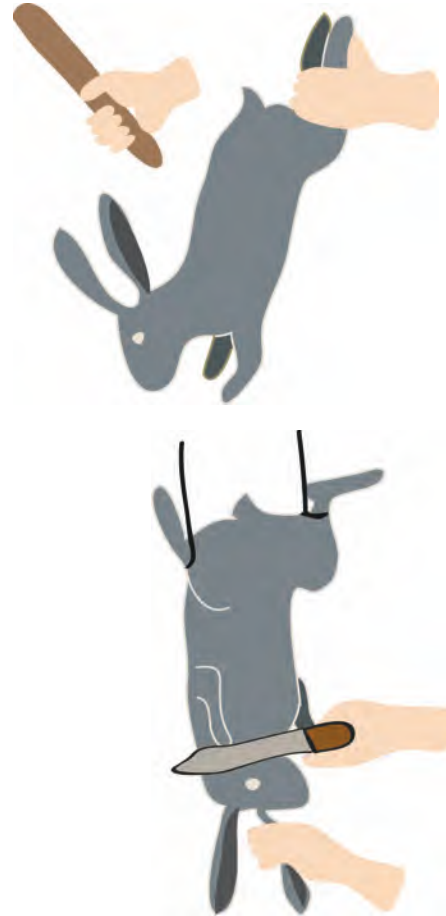



- Slice the skin between the thighs

- Release the hindquarters.

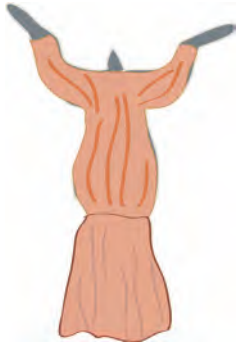

- Tug the skin to strip the trunk and forequarters.

- Carcass totally skinned but un-eviscerated.

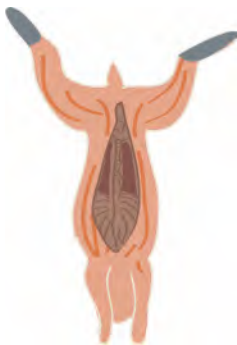

- Eviscerated (disemboweled), splayed carcass.

Test 26

Insert a "T" if the statement is true, and an "F" if it is false.

- Rabbits have difficulty in breeding. ().
- A suitable diet and strict sanitation are necessary for a successful litter. ().
- The hutch should be located in a cool, well-ventilated place. ()
- Any kind of material can be used to build the feeding trough. ().
- The doe can breed before she is four months old. ().
- It is not necessary to use pre-germinated grain in the ration. ().
- In order to avoid sickness, the floors of the hutch must be cleaned daily. ().

In this section we have looked at:

- How to raise rabbits
- Constructions and equipment
- Breeding
- Feeding
- Sanitation



If all your answers were correct, you have reached the top of the ladder. Congratulations!

Correct answers:

- a. F
- b. T
- c. T
- d. F
- e. F
- f. T
- g. F
- h. T

If two or more of your answers were incorrect, please revise the topics in this chapter.

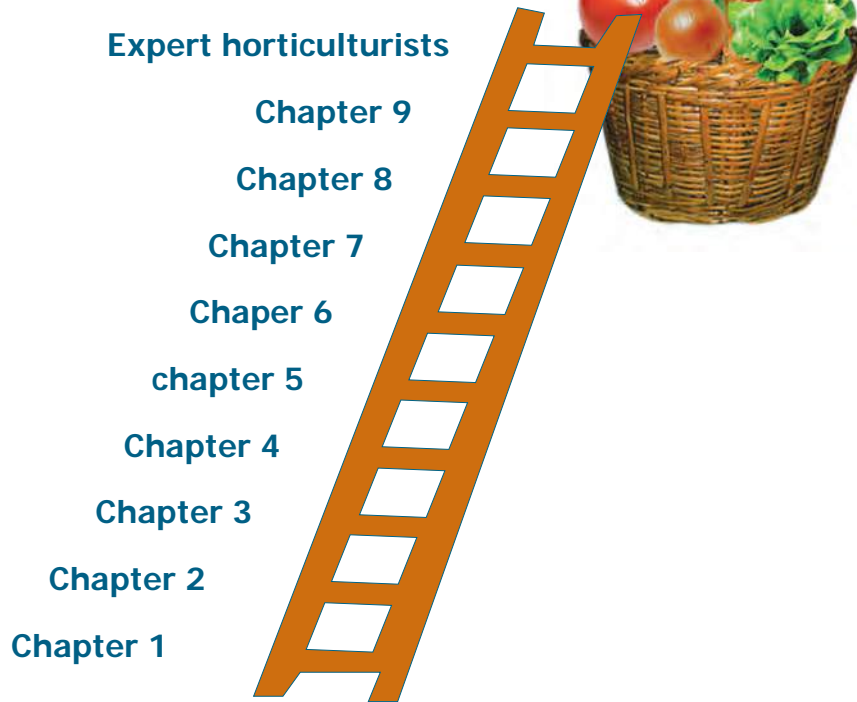

How to feed your animals and how to grow green fodder hydroponically

Green fodder can be used to complement the animals' food rations.

The following are grown from seed:

- Maize
- Rice
- Oats
- Barley
- Wheat

... It is a very efficient way of feeding rabbits and chickens



... and it is very easy to do.



Containers and seeds

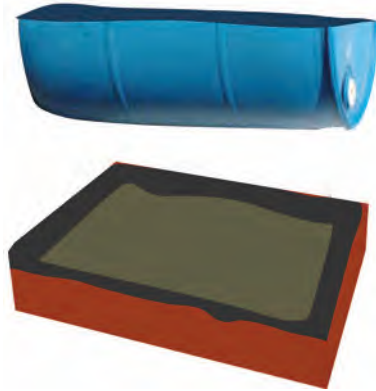

Choose the containers

- Plastic trays
- Plastic cans split down the middle
- Fibreglass trays.
- Wooden boxes or trays painted black or lined with plastic.

Choose the seeds

Wholesome - good quality rice
– barley – maize –oats – wheat
– sorghum



Cleaning



Clean the seeds

Remove stones, straw, soil, broken seeds or seeds of other plants.

Remember that this fodder is for your animals, so you must try to remove all strange objects.

Washing

Disinfect the seeds in



10 ml
hypochlorite



1 litre
water

Leave the seeds in the solution for one minute.

... then

Rinse well

Use clean water to rinse

Soaking and germination

Seeds clean and washed

Cloth bag



The cloth bag containing the seeds must be soaked in clean water as follows:

Leave for 12 hours in a container with clean water



Remove the bag and drain for 1 hour



Leave for 12 hours in another container with clean water



The seeds are now ready to be sowed



Sowing density
Maximum 1.5 cm (0.75 in).

4 kg seeds



1 m²
(3ft x 3 ft)

Sowing in seed trays

Cover the seeds with damp newspaper. Then, cover completely with black plastic. Leave the tray in the shade for 3 days.

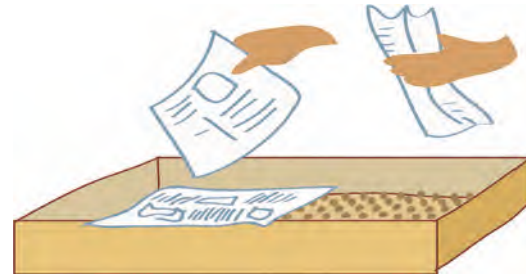

Watering the seed trays

Use a watering can.

For the first four days = only ½ litre of water.



After that, increase the amount of water by 100 cc each day, up to a maximum of 1.5 litres of water per square metre after 12 days. The watering should be spread out over 6 to 8 applications throughout the day.



Watering with nutritive solution

After the 4th or 5th day, the first leaves will appear. As soon as this occurs, begin to water with the nutritive solution.

1 Litre
Water



+

1.25 cc
Solution A



+

0.5 cc
Solution B



per seed tray

a

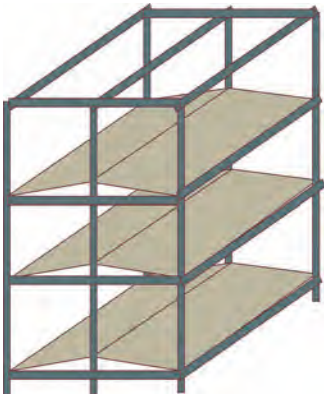

... The seed trays can be placed on shelving in the following way:

a. A module or shelving on three levels holding 18 individual seed trays.

b



b & c. Longitudinal cross-section of seed trays showing supports providing different degrees of slope.

c



The shelving can be made of branches, metal, tubes, or whatever material is at hand.

After the plants have been left to grow for 10 to 15 days and are about 20 to 25 cm tall, the REAPING begins.

The whole plant is eaten, including the roots.

To harvest, roll up the bed of plants like this:



The fodder produced should be eaten by the animals the same day it is harvested, although it can be stored for longer once it is watered adequately with the nutritive solution, which can help it last for two to three days more.

Each household can organize to make the best of the produce of the home garden.

For example:

- You can exchange produce with your neighbours.
- You can get together with friends and neighbours to sell the vegetables.



We have reached the end of the Manual. Now you know how to start a home garden.

The experience you gain each year will teach you more, and your produce will grow better and better!

We have a surprise for you at the back of the Manual



Information Chart

A vegetable garden for all

Vegetable	Type	Nutritional value (vitamins)	Root depth	planting system and depth in cm.
Vine tomatoes	Vegetable	A and C	deep	1,5 - 2,0 seedling
Bush tomatoes	Vegetable	A and C	deep	1,5 - 2,0 broadcast with thinning seedling
cassava	3 year Perennial	C Carbohydrates	medium	stake transplant
Carrot	Root	A mineral	medium	1,5 - 2,0 broadcast with thinning
Zucchini, Squash,	Vegetable	C	medium	3,0 - 5,0 drilling*
Squash, Pumpkin	Vegetable	A and C Carbohydrates	deep	3,0 - 5,0 drilling*
				*In each hole: place 2 to 3 seeds

Spacing (cm.) after thinning or transplanting		Seeds in 10 m furrows	Days to maturity	When to harvest	Approx. yield in 10 m furrows
Between plants	Between furrows				
30 - 60	90 - 100	15 - 35 Plants	60 - 100	Firm nicely colored produce	40 - 50 kg.
10 - 20	120 - 150	1 - 2 Broadcast 50 - 100 plants	70 - 100	Firm nicely colored produce	30 - 40 kg.
90	120	10 - 15 stakes	250 - 300	well developed roots	25 kg.
3 - 6	30 - 60	4 - 5	65 - 85	Formed roots and colored	25 - 30 kg
70 - 100	100 - 150	6 - 7	80 - 120	Tender vegetables, soft when pressed with fingernail	70 - 100
100 - 150	250 - 300	7 - 8	100 - 120	Firm vegetables, firm when pressed with fingernail	25 - 30
					*In each hole: place 2 to 3 seeds

Vegetable	Type	Nutritional value (vitamins)	Root depth	planting system and depth in cm.
Green Peppers	Vegetable	A and C	Medium	1,5 - 2,0 seedling
Green beans, string beans, kidney beans	Leguminous vegetable	A and C proteins	Medium	3,0 - 5,0 drilling
Leeks	Bulb	C	shallow	1,5 - 2,0 broadcast thinning seedling
Radishes	Root	C minerals	shallow	1,0 - 1,5 broadcast thinning
Beetroot, Beets	Root	minerals	Medium	2,0 - 3,0 broadcast thinning
Lima Beans	Leguminous vegetable	A and C proteins	deep	3,0 - 5,0 drilling
Cabbage	Leaf	C - minerals	shallow	seedling
Watermelon	Fruit	A	Deep	3,0 - 4,0 drilling

Spacing (cm.) after thinning or transplanting		Seeds in 10 m furrows	Days to maturity	When to harvest	Approx. yield in 10 m furrows
Between plants	Between furrows				
30 - 45	50 - 80	35 - 40 plants	70 - 110	firm well developed fruit	8 - 10 kg.
5- 10 (shrubby) 15 - 40 branch	50 - 70 70 - 90	80 60	55- 80	when the seed is one fourth of its ripened size	5 - 7 kg 7 - 10 kg
10- 15	30 - 70	70 - 100 plants 2 - 3 broadcast	130 - 150	5 cm. width at the base of the plant	10 - 12 kg.
2,5 - 5	25 - 45	3 - 4	20 - 40	2 cm. wide roots	5 - 8 kg.
5 - 8	45 - 70	6 - 8	65 - 100	6 cm. wide roots colored	15 - 20 kg.
15 - 20	60 - 90	60	60 - 80	full pods - seed somewhat immature	10 - 15 kg green
40 - 45	50 - 80	20 - 25 plants	70 - 120	well packed heads	20 - 25 heads
100 - 150	175 - 300	5 - 6	90 - 100	the part touching the soil turns from white to yellow	20 - 30 watermelon

Vegetable	Type	Nutritional value (vitamins)	Root depth	planting system and depth in cm.
Sweet corn	Vegetable	A (yellow) carbohydrates	shallow	4,0 drilling*
Melon	Fruit	A and C	medium	3,0 - 4,0 drilling*
Turnip	Root	C	medium	1,0 - 1,5 broadcast thinning
Oregano	Leaf perennial 5-6 years	herb	shallow	stem cutting transplant
Potato	Stem tuber	C-carbohydrates minerals	shallow	8,0 - 10,0 drilling, seed pieces
Cucumber	vegetable	C	medium	3,0 drilling
Parsley	Leaf	herb	shallow	1,5 -2,0 broadcast thinning

Spacing (cm.) after thinning or transplanting		Seeds in 10 m furrows	Days to maturity	When to harvest	Approx. yield in 10 m furrows
Between plants	Between furrows				
20 - 30	60 - 70	15 - 20	60 - 90	Full tender kernels - cobs	40 - 50
50 - 120	120 - 200	5	80 - 100	When they are separated from the stalk - or turn yellow in color	15 - 50 melons
10- 15	30 - 60	2 - 3	60 - 75	2.5 cm. wide roots	50 - 100 roots
20 - 30	40 - 80	30 - 40 Plants	90 - 180	harvest well developed leaves	2 to 3 leaves are enough per family
15 - 30	60 - 80	1.5 to 2.0 kg of seed tuber	90 - 120	drying yellow plants	15 - 25 kg
80 - 100	100 - 150	3 - 4	50 - 70	when the seeds are half the size of ripe ones	8 - 10 kg.
10 - 20	40 - 60	3 - 4	100	as needed cut larger leaves	50 - 100 plants

Vegetable	Type	Nutritional value (vitamins)	Root depth	planting system and depth in cm.
Hot peppers	Vegetable	A and C	medium	1,5 - 2,0 seedling
Garlic	Bulb	carbohydrates	shallow	bulbs drilling
Celery	Leaf (petioles)	minerals	shallow	0,5-1,0 seedling
Peas	Leguminous vegetable	A and C proteins	medium	3,0 broadcast with or without thinning
Eggplant	Seedling vegetable	A	medium	1,5 - 2,0 seedlings
Broccoli	Flowering vegetable	A and C minerals	shallow	1,0 - 1,5 seedling
Sweet potato, yams	Root	A carbohydrates	deep	15,0 - buried or cuttings or tuber sprouts

Spacing (cm.) after thinning or transplanting		Seeds in 10 m furrows	Days to maturity	When to harvest	Approx. yield in 10 m furrows
Between plants	Between furrows				
25 - 30	80 - 90 Plants	35 - 40	90 - 100	mature plants sun dried fruits	3 - 5 kilos
5 - 10	45 - 60	140 - 200 bulbs	135 - 210	plants turn yellow and dry	4 - 6 kilos
25 - 30	45 - 80	35 - 40 Plants	110 - 150	well developed petioles	30 - 40 plants
3 - 10	45 - 60	100 - 200	60 - 70	Full pods somewhat immature seeds	4 - 7 kilo green
30 - 60	70 - 90	17 - 35 Plants	80 - 120	well developed vegetable before it turns dull	10 - 12 kilos
40 - 50	45 - 80	20 - 25 Plants	80 - 150	first harvest green firm heads	20 - 25 plants
30	90	300 g. of cuttings or 30 to 35 plants	130 - 150	in fall before frosts starts	15 - 20 plants

Vegetable	Type	Nutritional value (vitamins)	Root depth	planting system and depth in cm.
Onion	Bulb leaves (green)	green: A and C and minerals bulb: carbohydrates	shallow	1,5 - 2,0 seedling
Cauliflower	Flowering vegetable	C minerals	shallow	1,0 - 1,5 seedling
Spinach	Leaf	A and C minerals	shallow	2,0 - 3,0 broadcast with thinning or seedling
Snap Beans, French Beans	Leguminous vegetable	A and C proteins	medium	5, 0 a drilling
Lettuce	Leaf	A and C minerals	shallow	1,0 - 1,5 broadcast relay or thinning

Spacing (cm.) after thinning or transplanting		Seeds in 10 m furrows	Days to maturity	When to harvest	Approx. yield in 10 m furrows
Between plants	Between furrows				
5 - 10	45 - 70	100 - 200 Plants	135- 180 bulbs 80 - 60 turn green	bulb: plants turn yellow and dry - turn green; well developed leaves	15 - 20 bulbs (Kg.)
40 - 50	45 - 80	20 - 25 plants	80 - 150	very firm and white heads	20 - 25 heads
20 - 25	45 - 60	4 - 6 a Broadcast 40 - 50 plants	60 - 90	fully grown leaves - harvest outer leaves or the whole plant	40 - 50 plants
15 - 30	45 - 70	100 - 200	70 - 120	Full pods - seeds somewhat immature grain	18 - 20 kilos green
25 - 30	45 - 60	3 - 5 Broadcast 40 - 50 plants	60 - 100	fully grown leaves - harvest the whole plan	30 - 40 plants



**The Food and Agriculture
Organization of the
United Nations,**
Subregional Office for this
Caribbean

Certifies that:

.....
has satisfactorily participated in the Self tutorial
course **“A VEGETABLE GARDEN FOR ALL”**



FOOD AND AGRICULTURE ORGANIZATION
OF THE UNITED NATIONS,
Subregional Office for the Caribbean

Fifth Edition 2013



ISBN 978-92-5-108105-1



97 8 9251 081051

I3556E/1/12.13