

SOBHA
ORBIS



The Sobha Way

**SOBHA REALTY
REDEFINES THE
CONCEPT OF LUXURY
RESIDENTIAL LIVING
WITH A REPERTOIRE
OF REAL ESTATE
PROJECTS ACROSS
DUBAI.**

Pioneering the 'Backward Integration' model in real estate, Sobha Realty employs in-house mastery to create a unique offering of fine living that extends beyond customer's expectations.

Backward Integration

The foremost backward
integrated company known
in the world with all the key
competencies and in-house
resources to deliver a project
from conceptualization to
completion ensuring:

TIMELY DELIVERY
UNMATCHED QUALITY



ART *of* THE DETAIL

At SOBHA, the 'Art of the Detail' is more than just a philosophy that permeates every aspect of their projects. Its meticulous attention to detail defines every project, crafting luxury living experiences that go beyond the ordinary. From architectural precision to premium materials and innovative technologies, SOBHA's commitment to perfection ensures each property is a masterpiece of fine living.



A VIBRANT CITY WITHIN *a* CITY

Nestled in Dubai's vibrant tapestry, Motor City offers a coveted blend of cobblestone lanes and spacious homes, creating refined charm. This enclave near Al Barari and Al Barsha features residential buildings, office towers, and motorsport facilities.

DISCOVER *the* CHARMED LIFESTYLE

DUBAI'S OASIS OF ELEGANCE,
WHERE EVERY CORNER BECKONS
WITH THRILLING ADVENTURES
AND TRANQUIL RETREATS!

Dubai Motor City boasts amenities like the Adrenaline-pumping Dubai Autodrome and First Avenue Mall. Every corner offers a unique mix of leisure and excitement.



THE CIRCLE OF LIFE



The choice of concentric circles for our logo symbolizes the seamless integration and unity within our luxury-focused community living property. Just as the circles radiate outward from a central point, our amenities and services are interconnected, forming a harmonious environment where residents can experience a world of luxury without ever having to leave the community. The concentric circles also evoke a sense of exclusivity and sophistication, reflecting the premium lifestyle that our residents can expect. With our tagline, "A world in its own," we encapsulate the idea that within our community, residents can find everything they desire, creating a self-contained world of elegance and convenience.

INTRODUCING

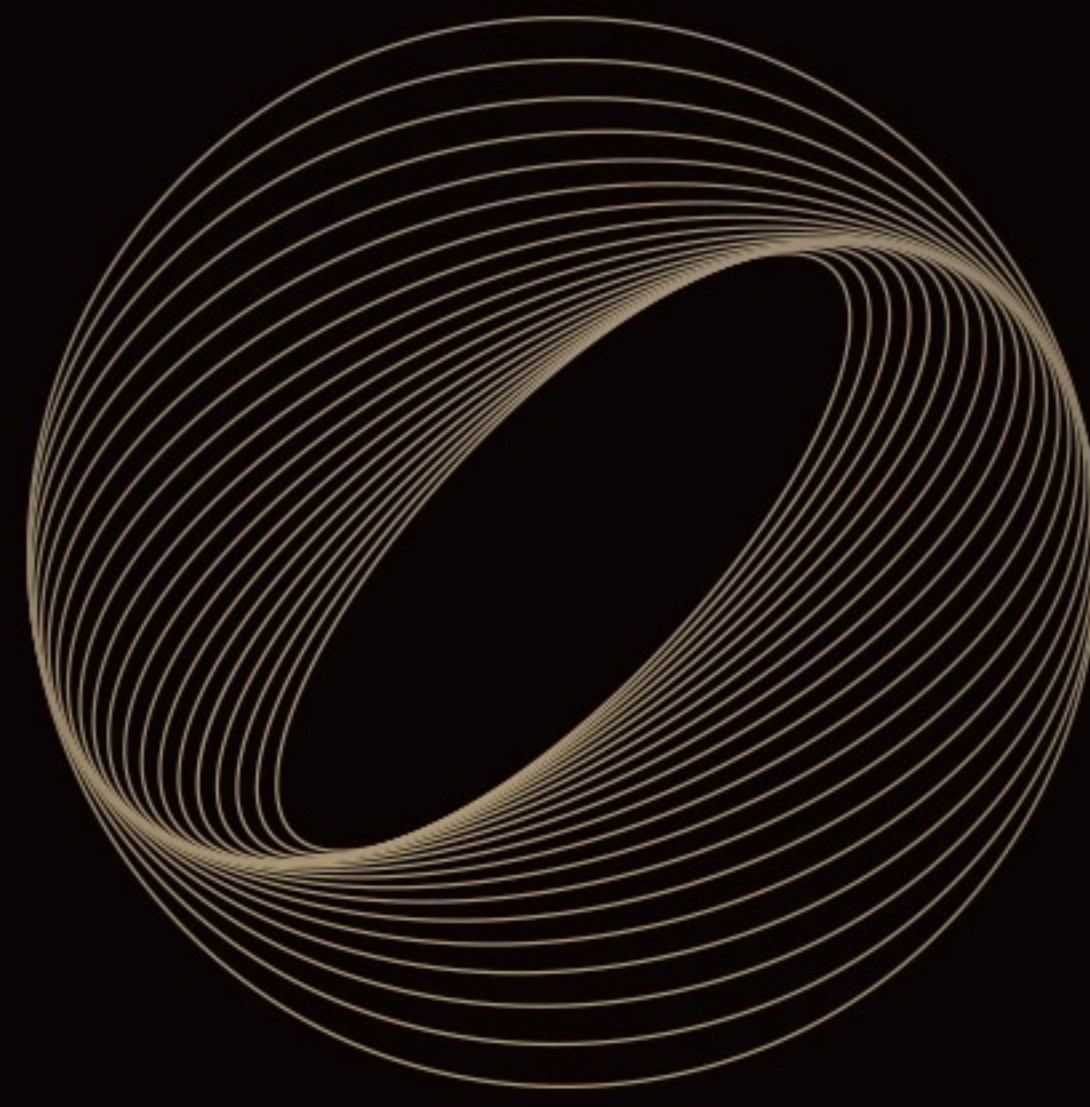

SOBHA ORBIS

A WORLD IN ITS OWN

Break free from the mundane and embrace a realm where luxury, convenience, and connectivity intertwine seamlessly. Our community embodies the essence of

"A World in Its Own," providing a haven where you can escape the chaos of urban living and immerse yourself in an unparalleled lifestyle of opulence and sophistication.



A WORLD IN ITS OWN.





THE PINNACLE *of* SOPHISTICATED

Step into the world of SOBHA ORBIS. Nestled amidst the dynamic cityscape, SOBHA ORBIS emerges as an emblem of refined living, beckoning those who crave the pinnacle of sophistication.

From its sleek architectural design to its sumptuous interior finishes, every facet of SOBHA ORBIS is meticulously curated to evoke a timeless aura of luxury. Here, indulge in a realm where extravagance knows no limits, where each amenity is tailored to fulfill your every desire, and where every moment exudes a palpable sense of grandeur.

Welcome to SOBHA ORBIS, where luxury finds its truest expression.

LUXURY BUILT AROUND YOU

Welcome to the epitome of urban living in Motor City, Dubai – where luxury meets convenience at every turn. Our premium 3 tower luxury apartments stand as a jewel in the crown of this vibrant new community.

1, 1.5 AND 2 BED HOMES
WITH AREA RANGE OF
545 SQ. FT. - 988 SQ. FT.





INDULGE *in a*
LIFESTYLE THAT
TRANSCENDS
THE ORDINARY

Our meticulously crafted apartments exude sophistication and elegance, offering a lifestyle that transcends the ordinary. From sleek contemporary design to lavish finishes, every detail has been curated to indulge your senses and elevate your living experience.

PREMIER AMENITIES *at* YOUR FINGERTIPS

Experience unparalleled convenience with access to the latest amenities right at your doorstep. Whether you crave rejuvenation or recreation, our community offers a wealth of options to cater to your every need. Dive into the refreshing waters of our resort-style pool, unwind in the serene ambiance of our landscaped gardens, or stay active in our state-of-the-art fitness center – all within walking distance from your home.



THE GRANDEUR OF TIMELESS ELEGANCE





AN IMPRESSIVE SUITE OF
INDOOR AND OUTDOOR AMENITIES



SEAMLESS CONNECTIVITY

Lies at the heart of our community. With a proposed metro station adjacent to the tower, exploring the vibrant city of Dubai has never been easier. Sobha Orbis conveniently located just minutes away from both Mohammed bin Zayed Road and Al Qudra Road, ensuring easy accessibility to key destinations. Whether you're commuting to work or exploring the city's countless attractions, enjoy effortless access to everything Dubai has to offer, right from your doorstep.

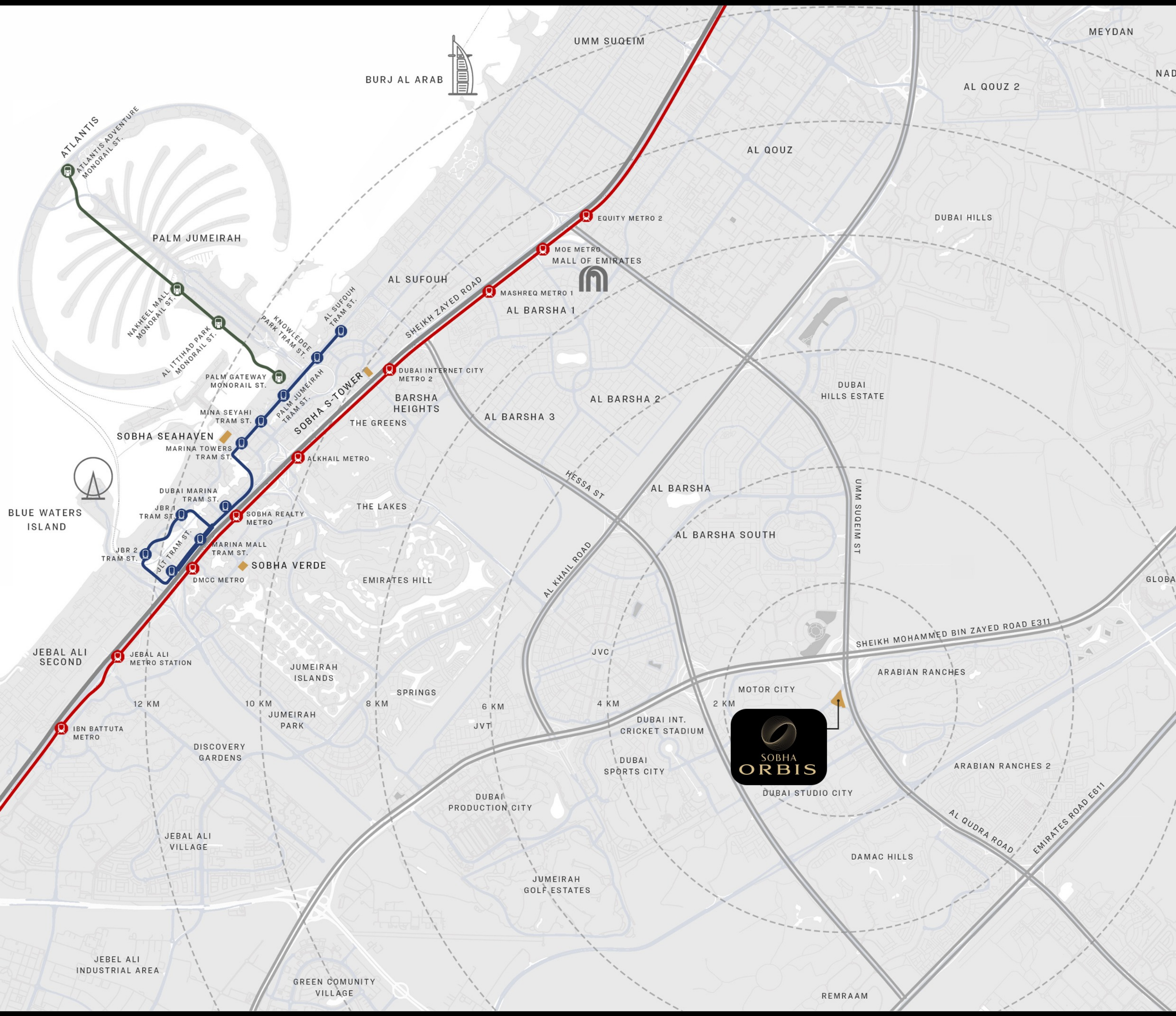



SITE PLAN

FLOOR PLAN LAYOUT

TOWER A - SOBHA ORBIS

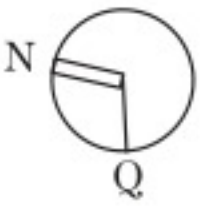

VILLA COMMUNITY, GOLF COURSE

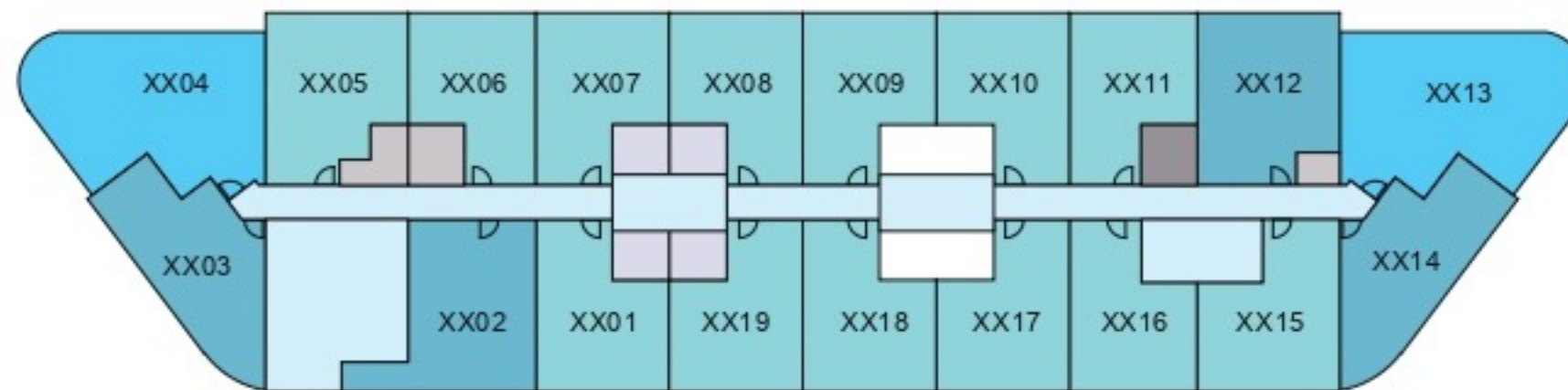

COMMUNITY AND CITY VIEWS

LEVEL - 03 - 21



VILLA COMMUNITY, GOLF COURSE

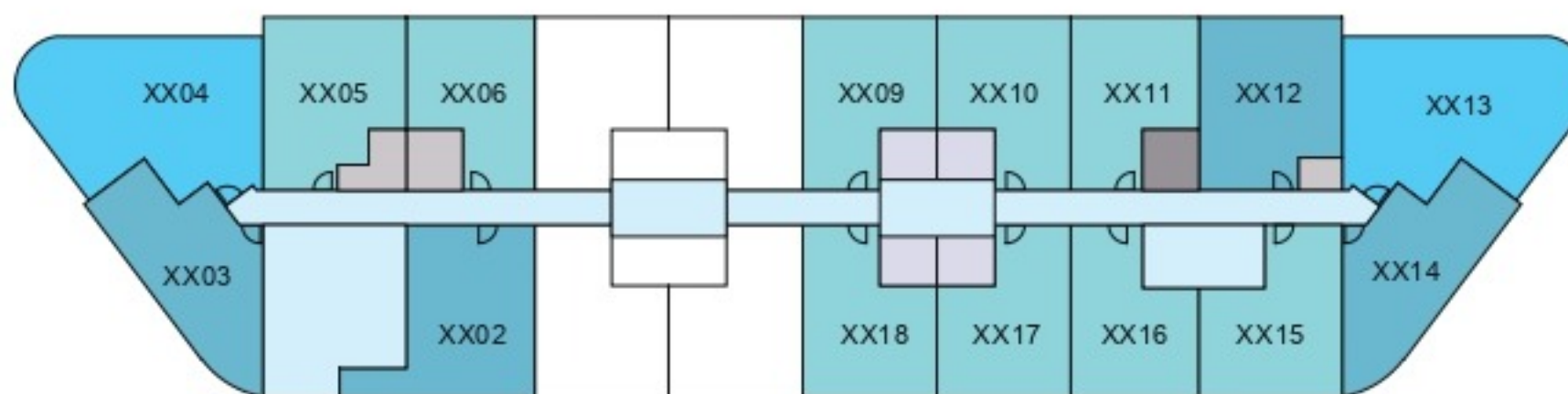

COMMUNITY AND CITY VIEWS

LEVEL - 22 - 32



VILLA COMMUNITY, GOLF COURSE

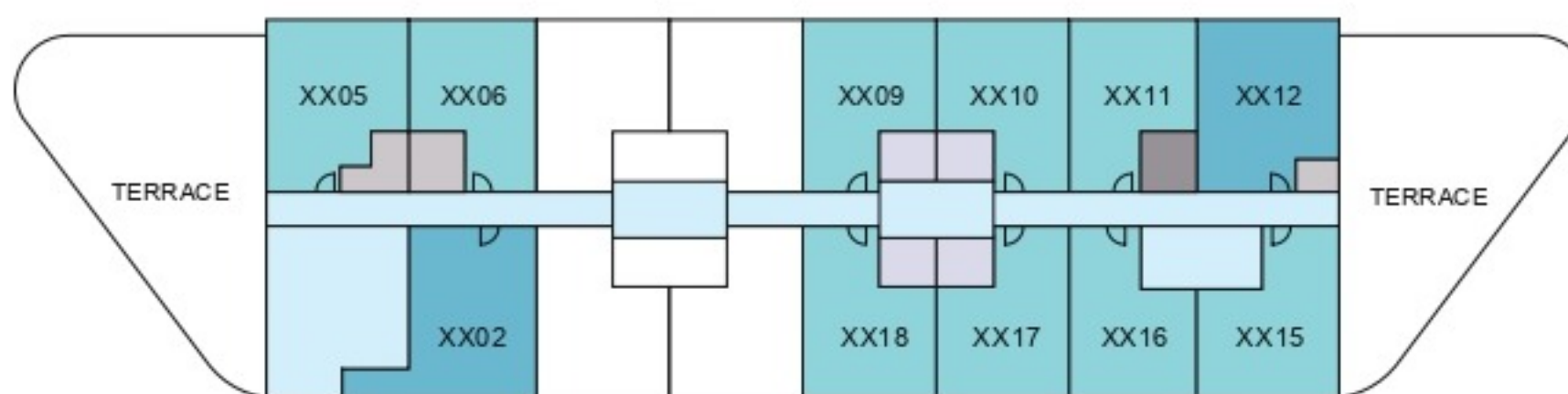

COMMUNITY AND CITY VIEWS

LEVEL - 33, 34

- 1 BED UNIT
- 2 BED UNIT
- CIRCULATION
- LIFTS
- 1.5 BED UNIT
- SERVICES
- GARBAGE ROOM

Disclaimer: 1. All dimensions are in metric, measured to wall finishes. 2. All materials, dimensions & drawings are approximate. 3. Information is subject to change without notice, at developer's absolute discretion. 4. Actual area may vary from the stated area. 5. Drawing are not to scale. 6. All images used are for illustrative purpose only and do not represent the actual size, features, specifications, fittings and furnishings. 7. The developer reserves the right to make revisions/ alterations, at its absolute discretion, without any liability whatsoever.

1 BEDROOM APARTMENT

TYPE A (with balcony)

TOTAL SALEABLE AREA

SUITE RANGE = 490.94 SQ.FT. - 493.09 SQ.FT.

BALCONY = 54.14 SQ.FT.

TOTAL RANGE = 545.08 SQ.FT. - 547.23 SQ.FT.

 UNIT

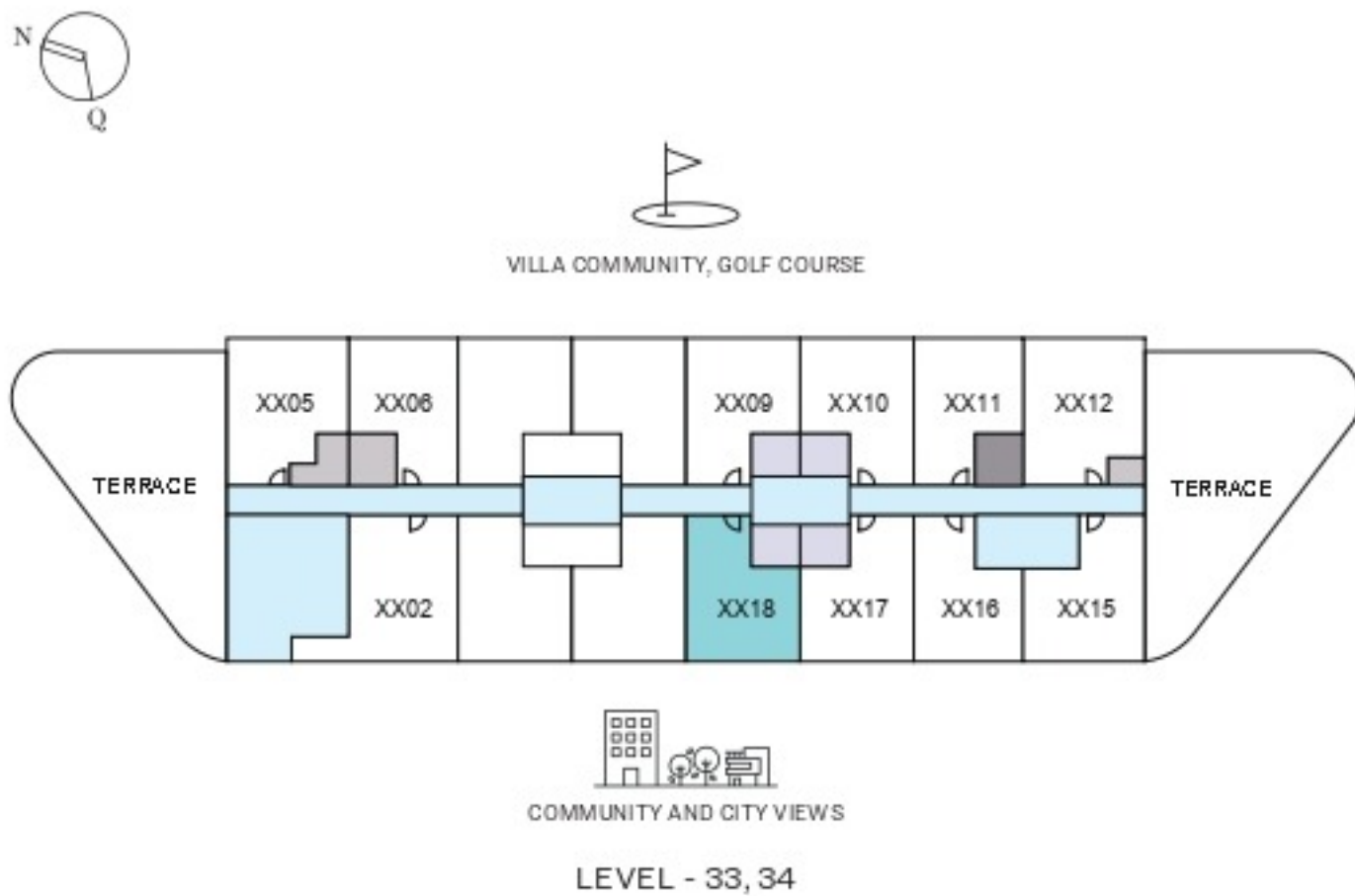
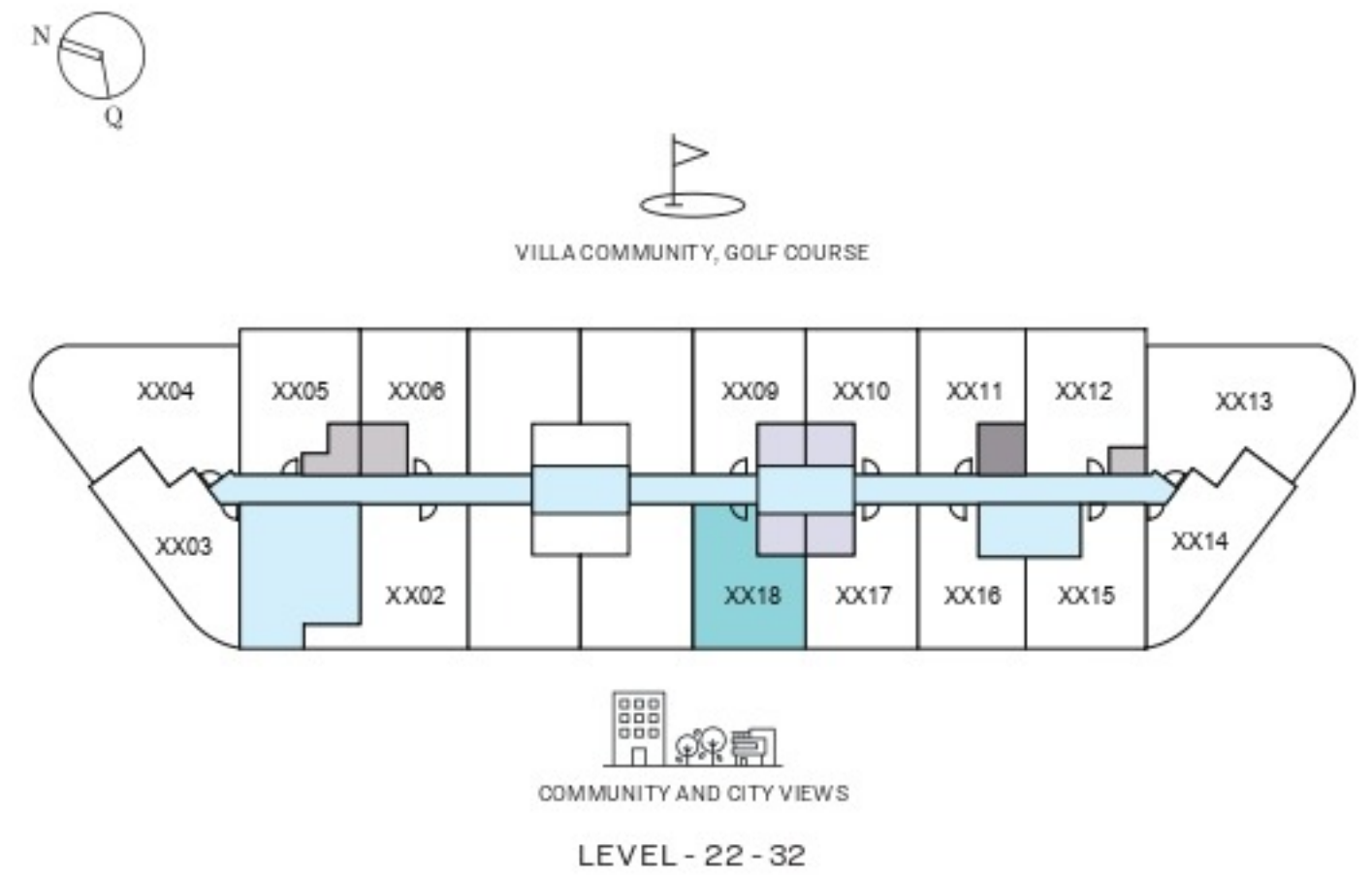
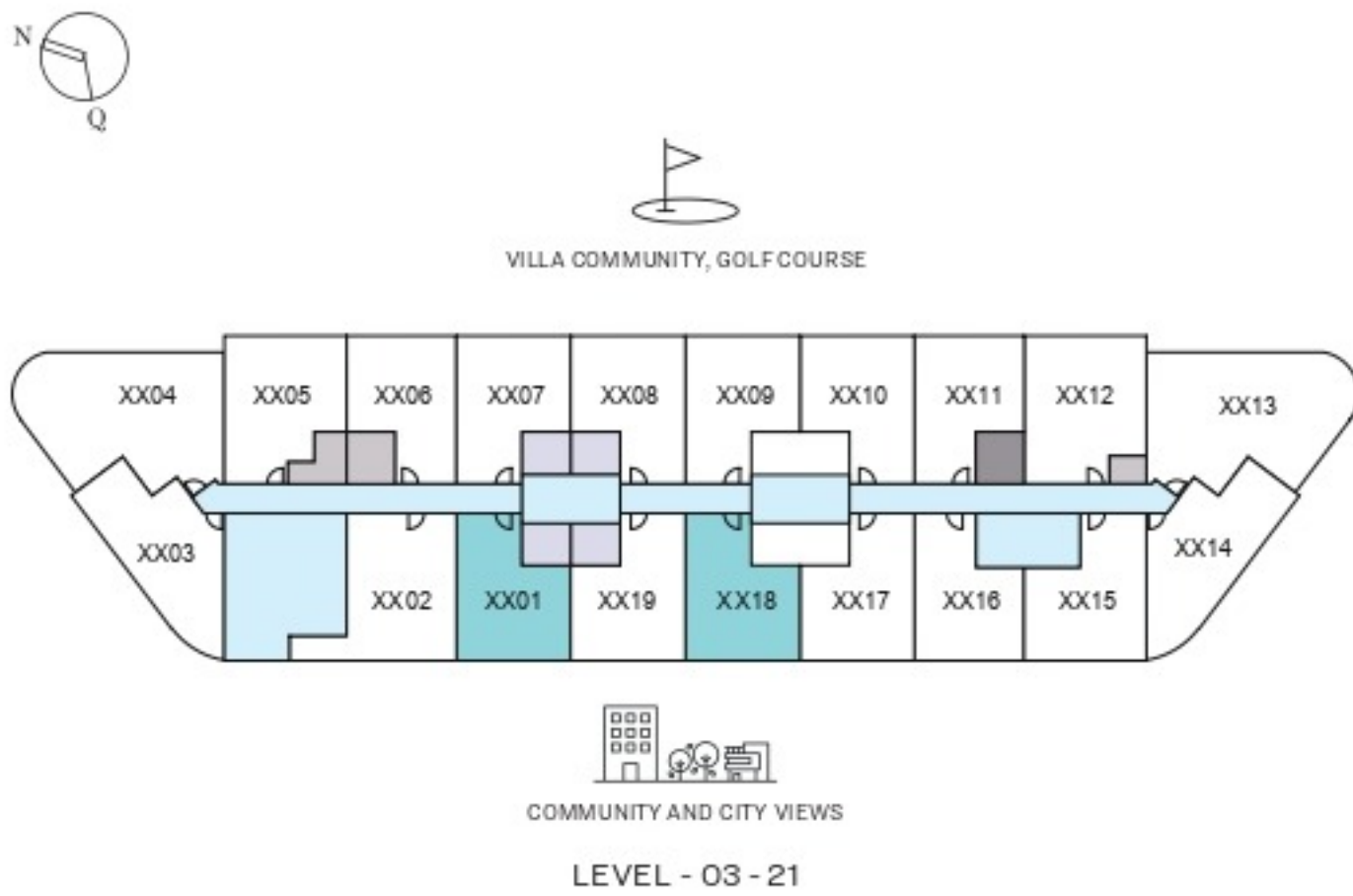

List of unit numbers with this unit plan:

VIEWS

Amenities

A318, A418, A518, A618, A718, A818, A918, A1018, A1118, A1218, A1318, A1418, A1518, A1618, A1718, A1818, A1918, A2018

Community, City View

A501, A601, A701, A801, A901, A1001, A1101, A1201, A1301, A1401, A1501, A1601, A1701, A1801, A2118, A2218, A2318, A2418, A2518, A2618, A2718, A2818, A2918, A3018, A3118, A3218, A3318, A3418

Street View

A301, A401

Disclaimer: 1. All dimensions are in metric, measured to wall finishes. 2. All materials, dimensions & drawings are approximate. 3. Information is subject to change without notice, at developer's absolute discretion. 4. Actual area may vary from the stated area. 5. Drawing are not to scale. 6. All images used are for illustrative purpose only and do not represent the actual size, features, specifications, fittings and furnishings. 7. The developer reserves the right to make revisions/ alterations, at its absolute discretion, without any liability whatsoever.

1 BEDROOM APARTMENT

TYPE A (with balcony)

TOTAL SALEABLE AREA

SUITE RANGE = 490.94 SQ.FT. - 493.09 SQ.FT.

BALCONY = 54.14 SQ.FT.

TOTAL RANGE = 545.08 SQ.FT. - 547.23 SQ.FT.

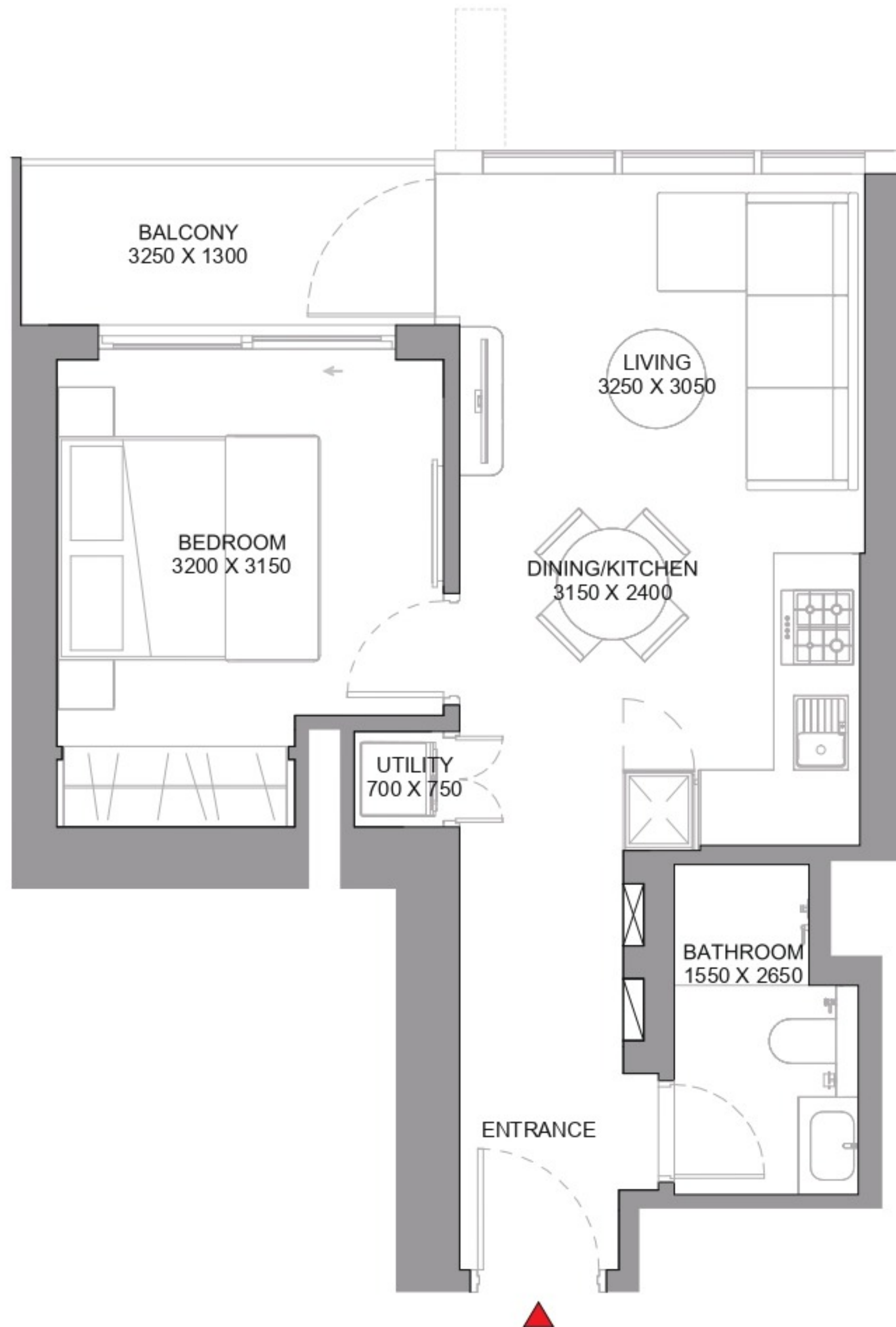

List of unit numbers with this unit plan:

VIEWS

Amenities

A318, A418, A518, A618, A718, A818, A918, A1018, A1118, A1218, A1318, A1418, A1518, A1618, A1718, A1818, A1918, A2018

Community, City View

A501, A601, A701, A801, A901, A1001, A1101, A1201, A1301, A1401, A1501, A1601, A1701, A1801, A2118, A2218, A2318, A2418, A2518, A2618, A2718, A2818, A2918, A3018, A3118, A3218, A3318, A3418

Street View

A301, A401

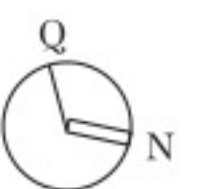

Disclaimer: 1. All dimensions are in metric, measured to wall finishes. 2. All materials, dimensions & drawings are approximate. 3. Information is subject to change without notice, at developer's absolute discretion. 4. Actual area may vary from the stated area. 5. Drawing are not to scale. 6. All images used are for illustrative purpose only and do not represent the actual size, features, specifications, fittings and furnishings. 7. The developer reserves the right to make revisions/ alterations, at its absolute discretion, without any liability whatsoever.

1 BEDROOM APARTMENT

TYPE A (with balcony) VARIANT 1

TOTAL SALEABLE AREA

SUITE RANGE = 486.96 SQ.FT. - 490.40 SQ.FT.

BALCONY = 56.51 SQ.FT.

TOTAL RANGE = 543.47 SQ.FT. - 546.91 SQ.FT.

 UNIT

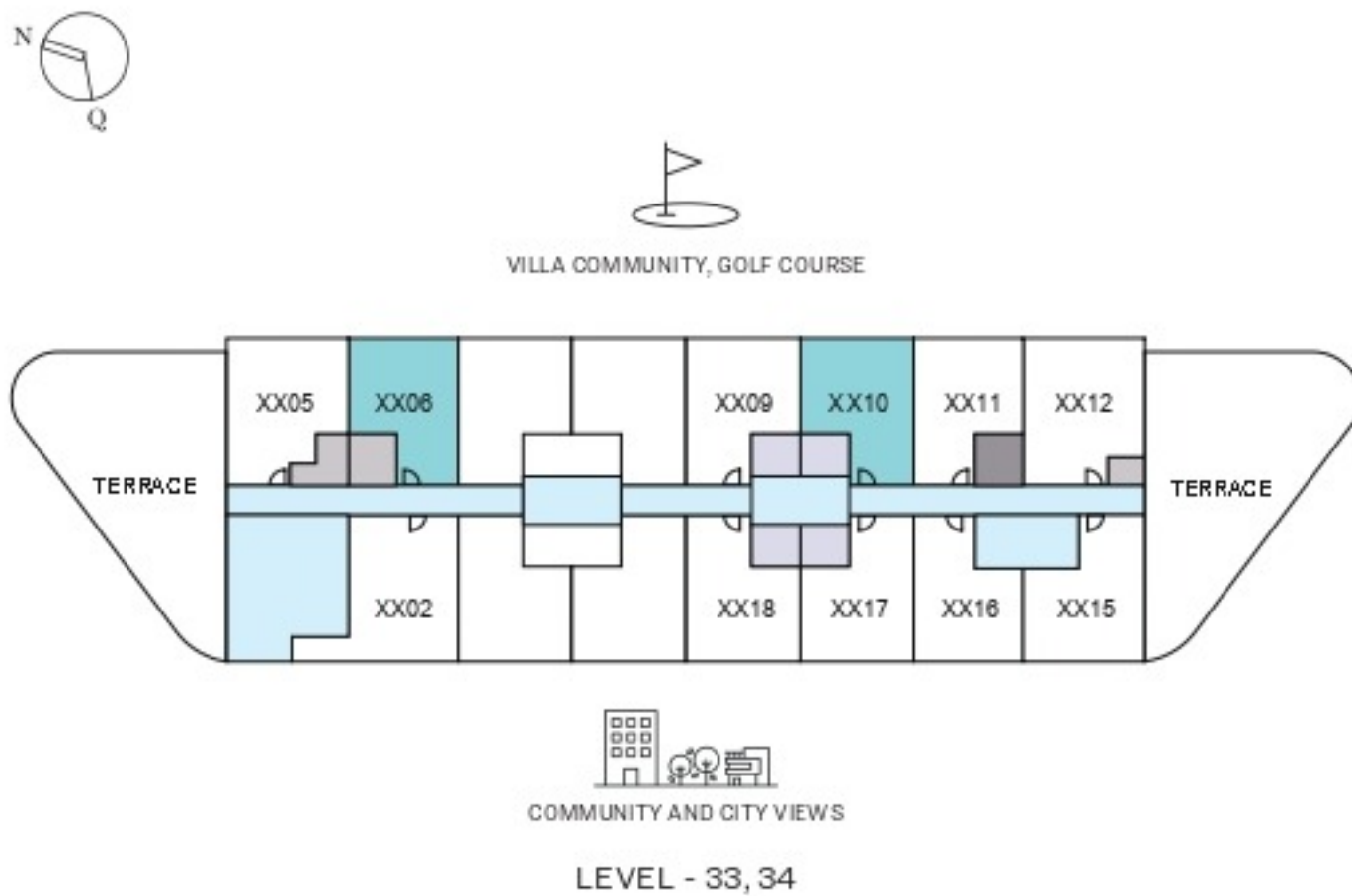
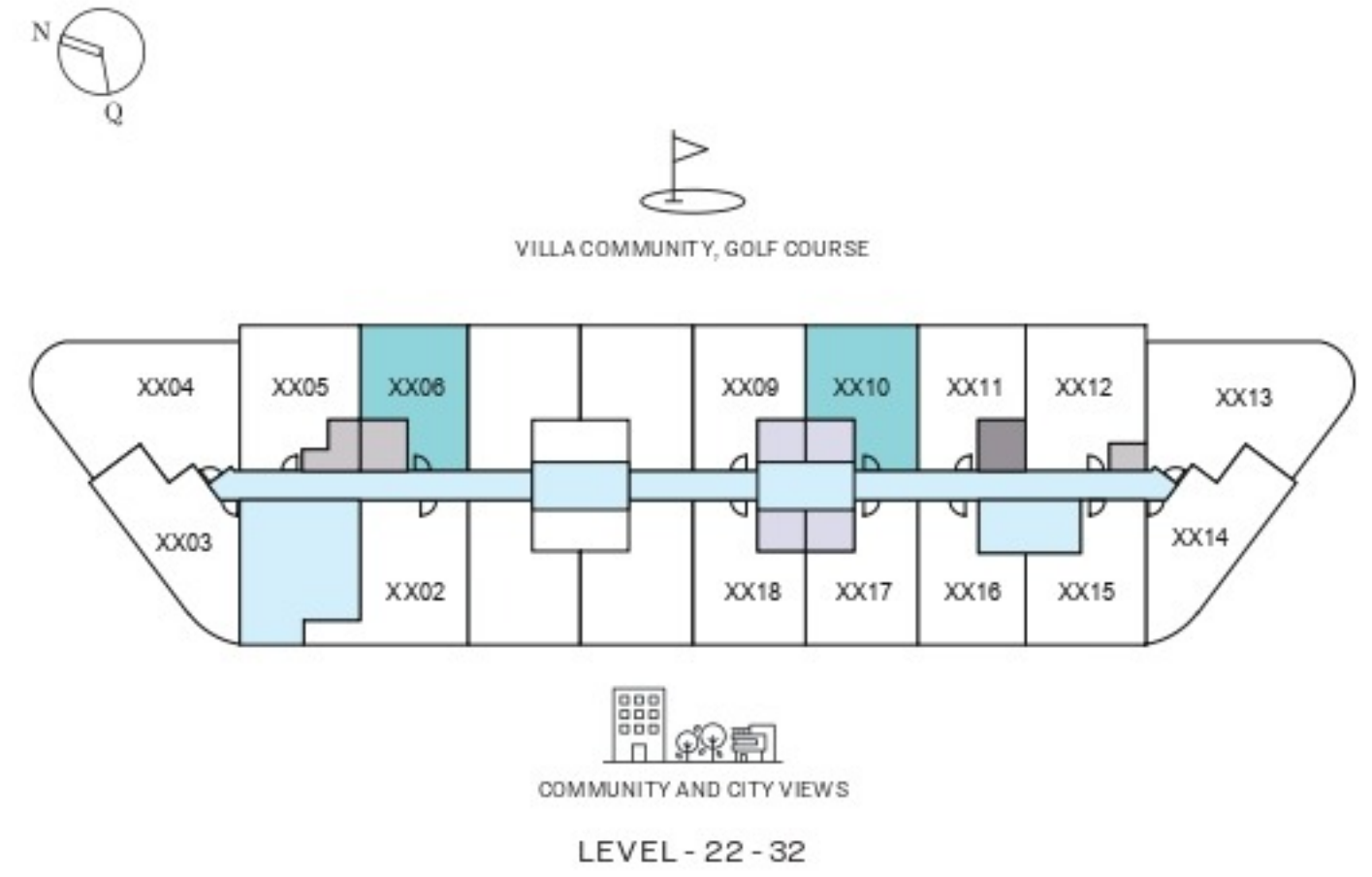
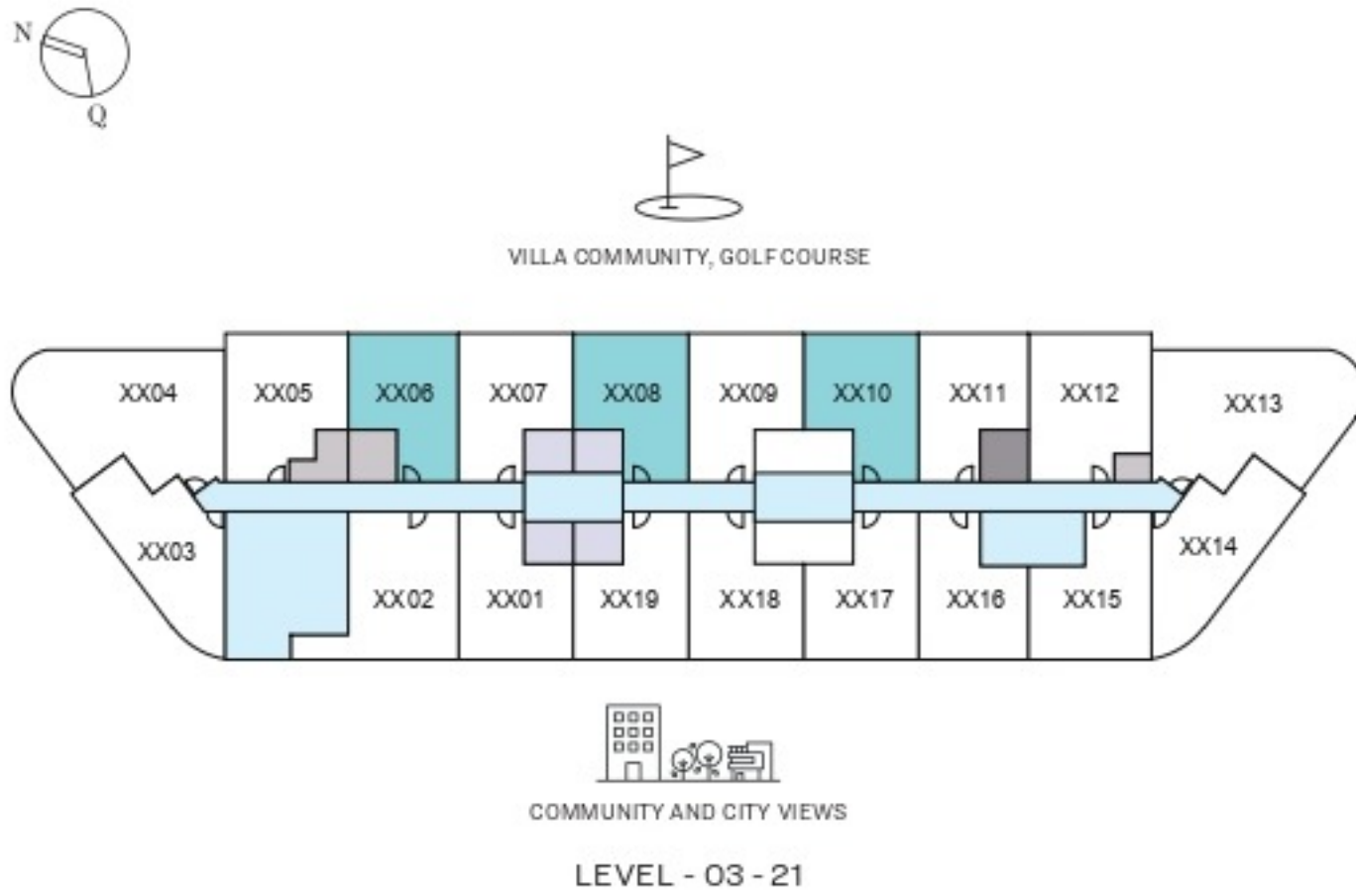

List of unit numbers with this unit plan:

VIEWS

Street View

A306, A308, A310, A406, A408, A410

Villa Community, Golf Course

A506, A508, A510, A606, A608, A610, A706, A708, A710, A806, A808, A810, A906, A908, A910, A1006, A1008, A1010, A1106, A1108, A1110, A1206, A1208, A1210, A1306, A1308, A1310, A1406, A1408, A1410, A1506, A1508, A1510, A1606, A1608, A1610, A1706, A1708, A1710, A1806, A1808, A1810, A1906, A1910, A2006, A2010, A2106, A2110, A2206, A2210, A2306, A2310, A2406, A2410, A2506, A2510, A2606, A2610, A2706, A2710, A2806, A2810, A2906, A2910, A3006, A3010, A3106, A3110, A3206, A3210, A3306, A3310, A3406, A3410

Disclaimer: 1. All dimensions are in metric, measured to wall finishes. 2. All materials, dimensions & drawings are approximate. 3. Information is subject to change without notice, at developer's absolute discretion. 4. Actual area may vary from the stated area. 5. Drawing are not to scale. 6. All images used are for illustrative purpose only and do not represent the actual size, features, specifications, fittings and furnishings. 7. The developer reserves the right to make revisions/ alterations, at its absolute discretion, without any liability whatsoever.

1 BEDROOM APARTMENT

TYPE A (with balcony) VARIANT 1

TOTAL SALEABLE AREA

SUITE RANGE = 486.96 SQ.FT. - 490.40 SQ.FT.

BALCONY = 56.51 SQ.FT.

TOTAL RANGE = 543.47 SQ.FT. - 546.91 SQ.FT.

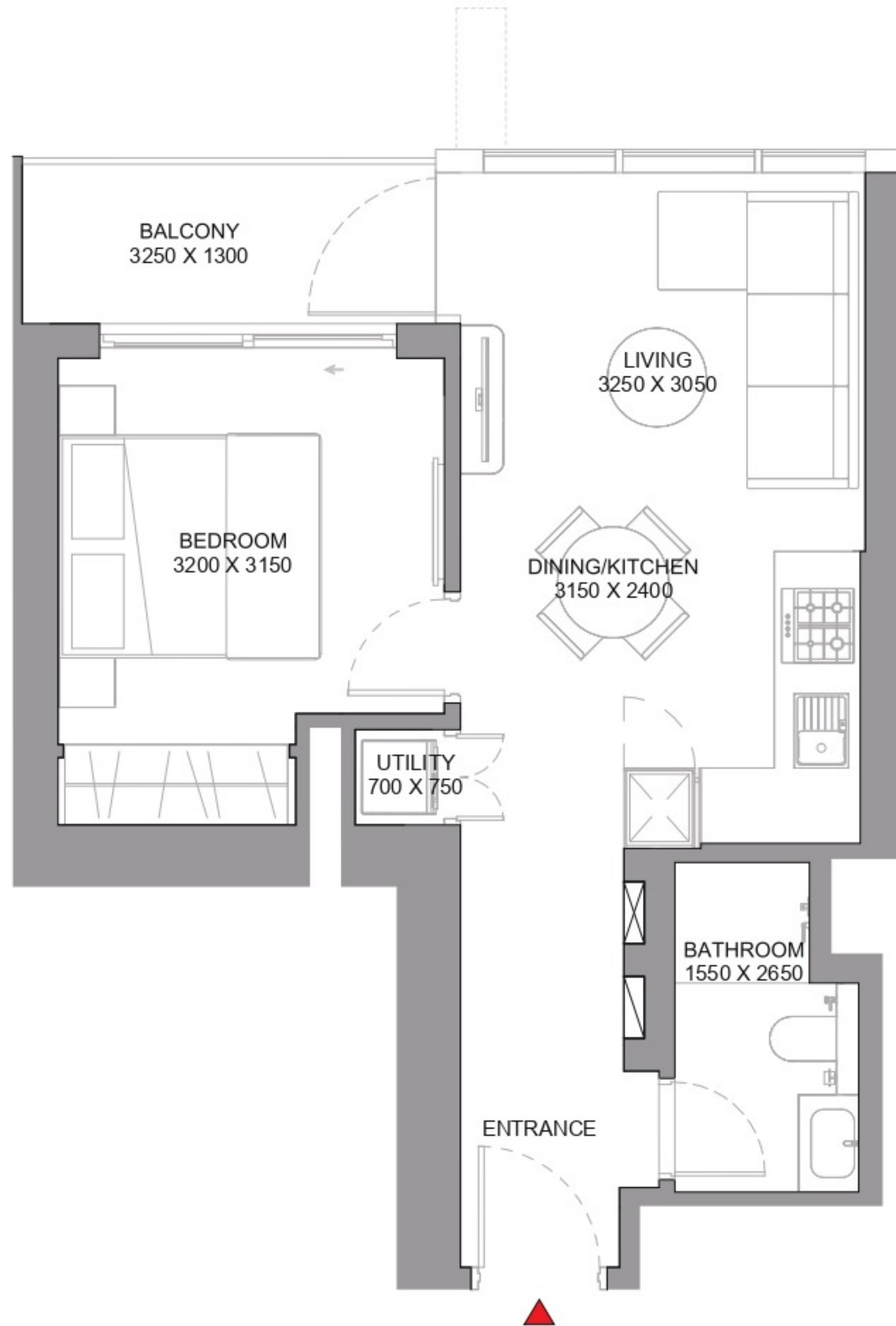

List of unit numbers with this unit plan:

VIEWS

Street View

A306, A308, A310, A406, A408, A410

Villa Community, Golf Course

A506, A508, A510, A606, A608, A610, A706, A708, A710, A806, A808, A810, A906, A908, A910, A1006, A1008, A1010, A1106, A1108, A1110, A1206, A1208, A1210, A1306, A1308, A1310, A1406, A1408, A1410, A1506, A1508, A1510, A1606, A1608, A1610, A1706, A1708, A1710, A1806, A1808, A1810, A1906, A1910, A2006, A2010, A2106, A2110, A2206, A2210, A2306, A2310, A2406, A2410, A2506, A2510, A2606, A2610, A2706, A2710, A2806, A2810, A2906, A2910, A3006, A3010, A3106, A3110, A3206, A3210, A3306, A3310, A3406, A3410

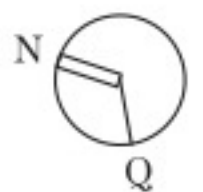

Disclaimer: 1. All dimensions are in metric, measured to wall finishes. 2. All materials, dimensions & drawings are approximate. 3. Information is subject to change without notice, at developer's absolute discretion. 4. Actual area may vary from the stated area. 5. Drawing are not to scale. 6. All images used are for illustrative purpose only and do not represent the actual size, features, specifications, fittings and furnishings. 7. The developer reserves the right to make revisions/ alterations, at its absolute discretion, without any liability whatsoever.

1 BEDROOM APARTMENT

TYPE B (with balcony)

TOTAL SALEABLE AREA

SUITE = 491.16 SQ.FT.
BALCONY = 54.14 SQ.FT.
TOTAL = 545.30 SQ.FT.

UNIT

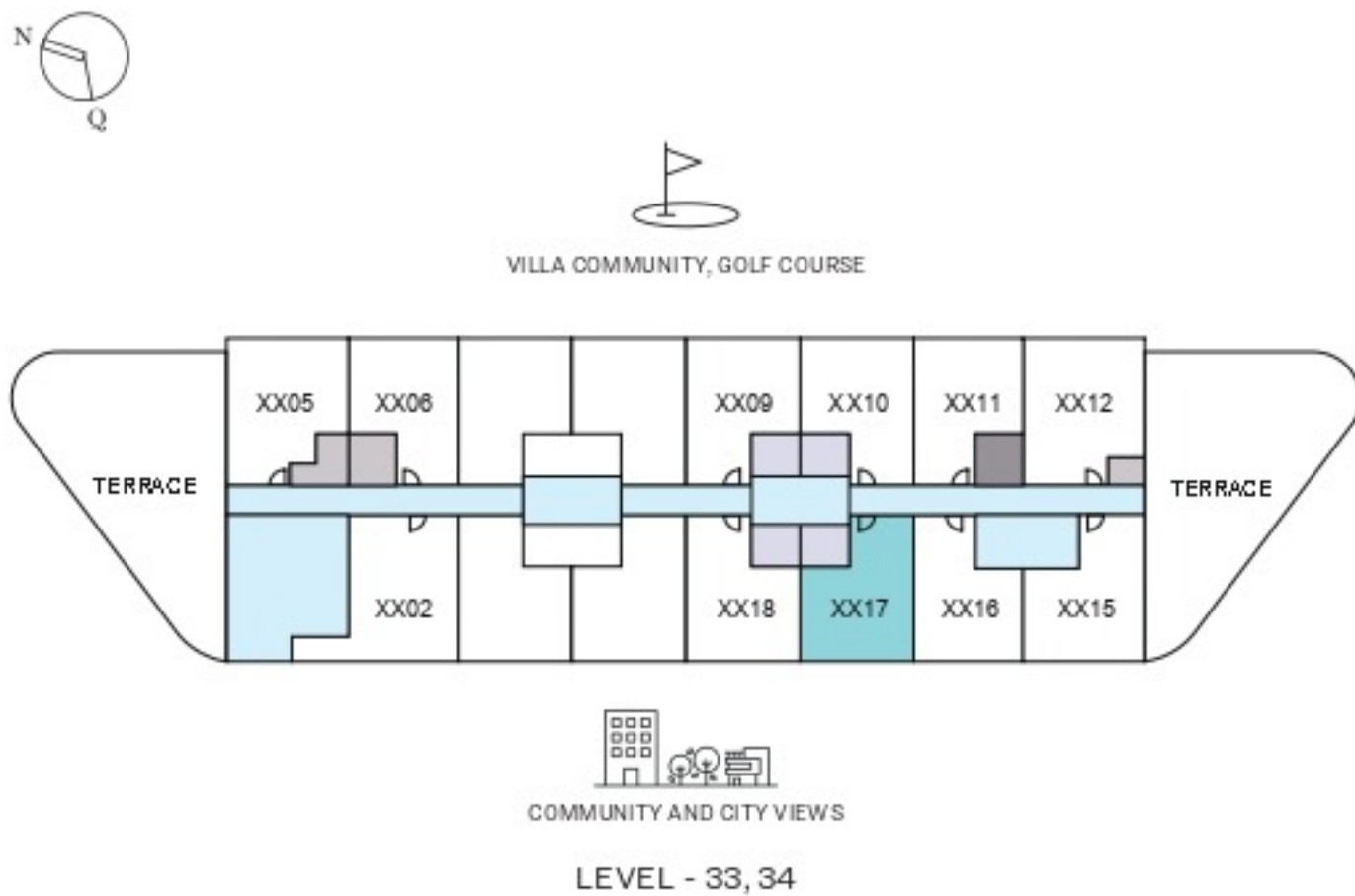
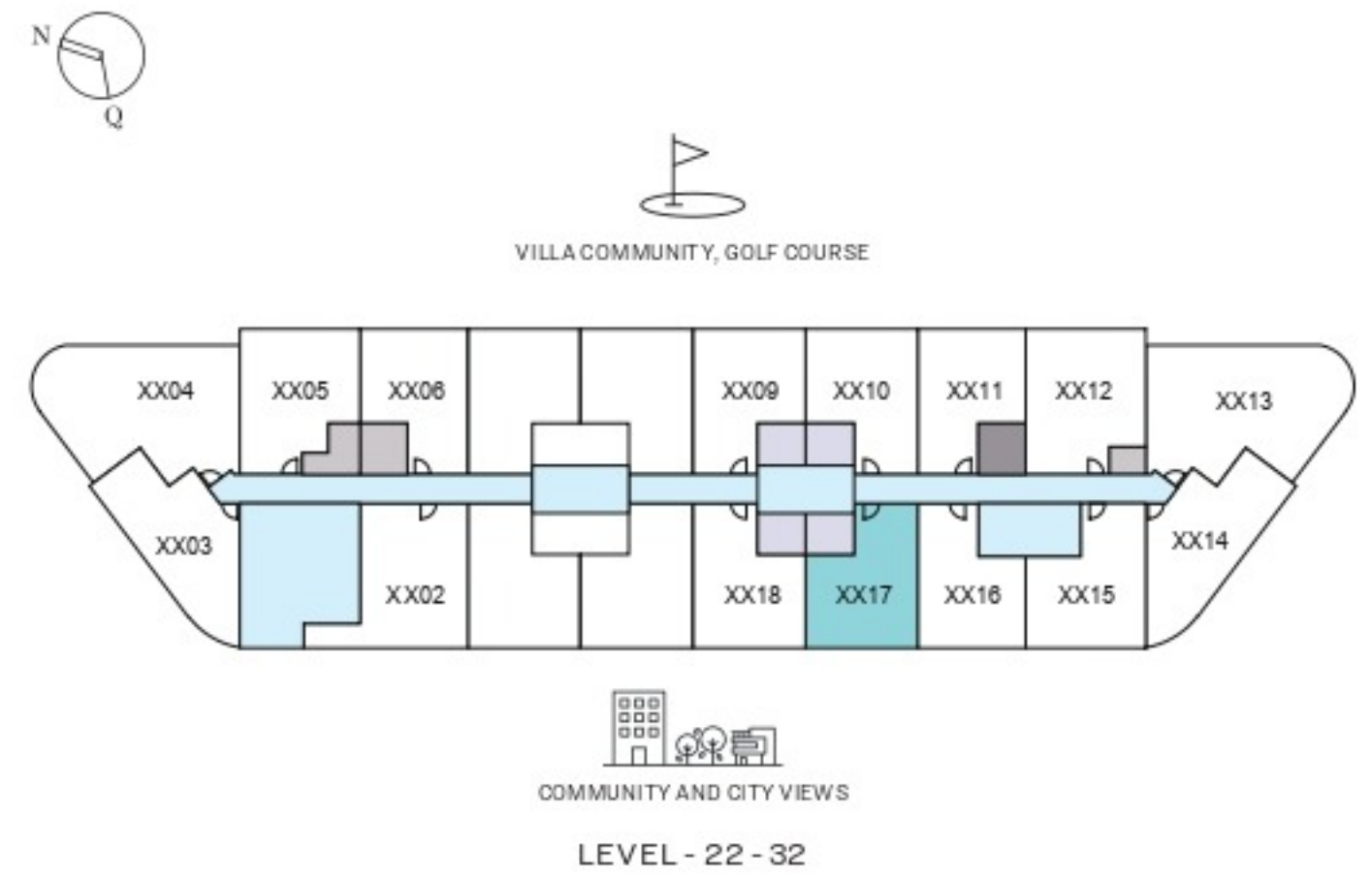
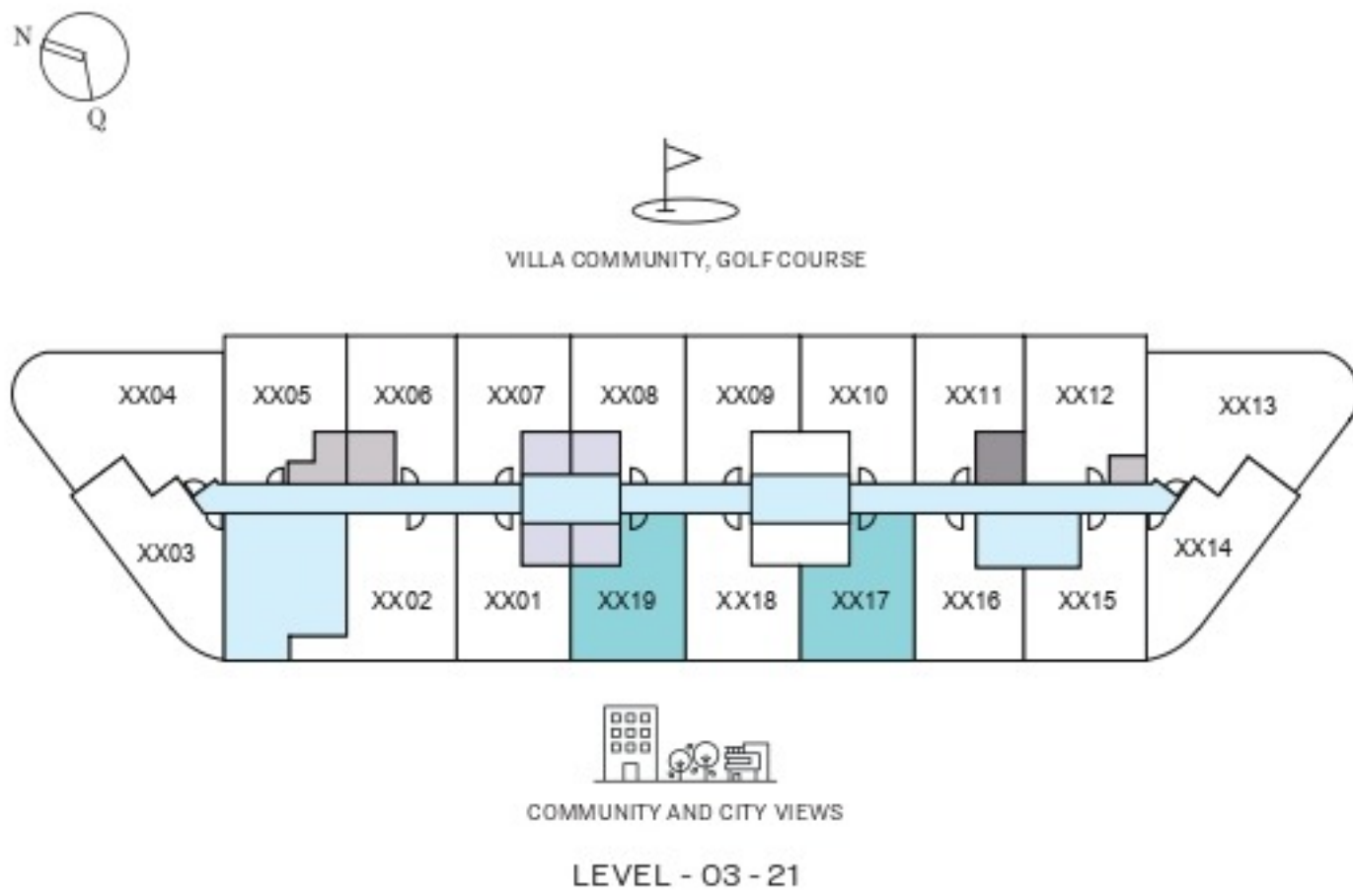

List of unit numbers with this unit plan:

VIEWS

Amenities

A317, A319, A417, A419, A517, A519, A617, A619, A717, A719, A817, A819, A917, A919, A1017, A1019, A1117, A1119, A1217, A1219, A1317, A1319, A1417, A1419, A1517, A1519, A1617, A1619, A1717, A1719, A1817, A1819, A1917, A2017

Community, City View

A2117, A2217, A2317, A2417, A2517, A2617, A2717, A2817, A2917, A3017, A3117, A3217, A3317, A3417

Disclaimer: 1. All dimensions are in metric, measured to wall finishes. 2. All materials, dimensions & drawings are approximate. 3. Information is subject to change without notice, at developer's absolute discretion. 4. Actual area may vary from the stated area. 5. Drawing are not to scale. 6. All images used are for illustrative purpose only and do not represent the actual size, features, specifications, fittings and furnishings. 7. The developer reserves the right to make revisions/ alterations, at its absolute discretion, without any liability whatsoever.

1 BEDROOM APARTMENT

TYPE B (with balcony)

TOTAL SALEABLE AREA

SUITE = 491.16 SQ.FT.
BALCONY = 54.14 SQ.FT.
TOTAL = 545.30 SQ.FT.

■ UNIT

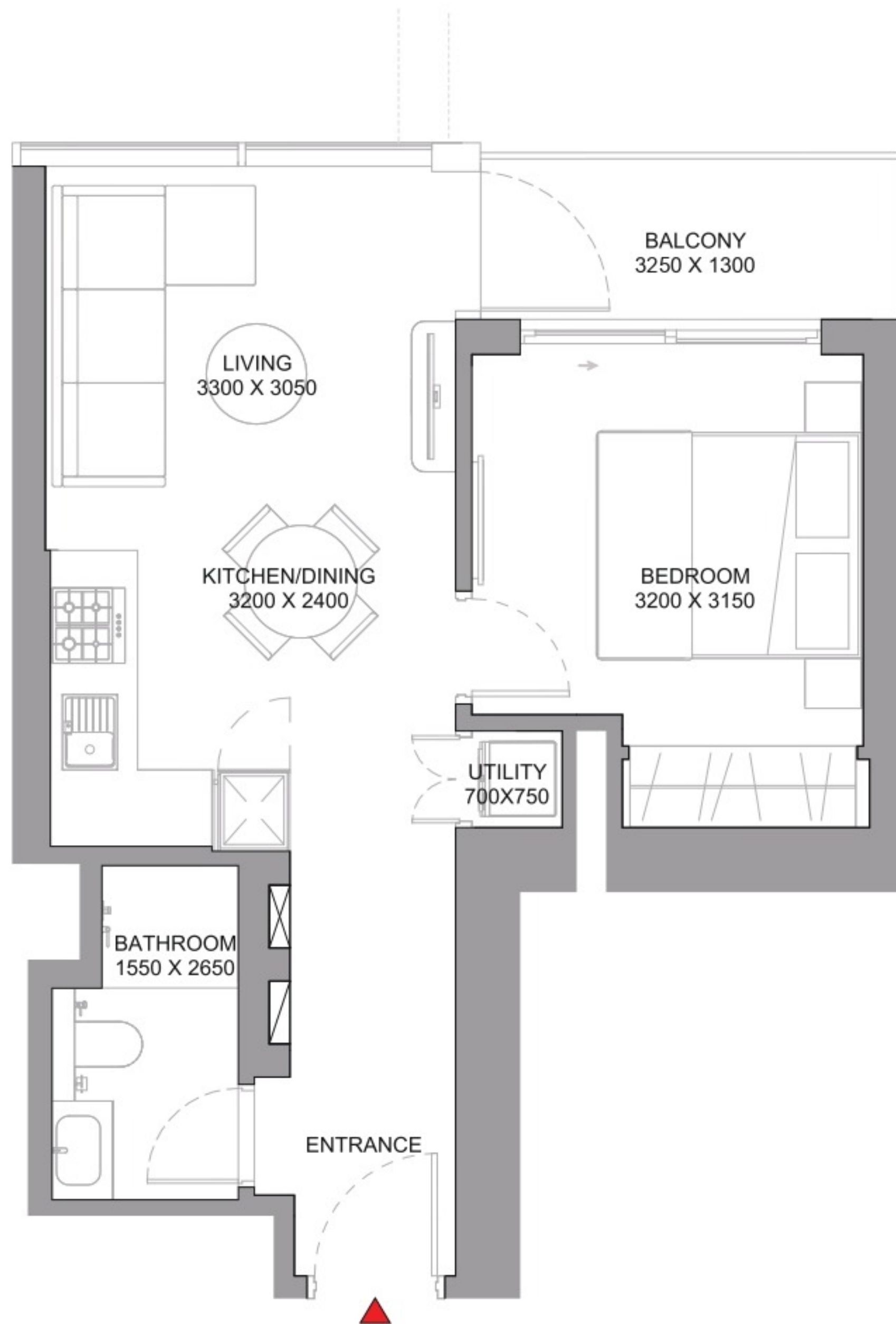

List of unit numbers with this unit plan:

VIEWS

Amenities

A317, A319, A417, A419, A517, A519, A617, A619, A717, A719, A817, A819, A917, A919, A1017, A1019, A1117, A1119, A1217, A1219, A1317, A1319, A1417, A1419, A1517, A1519, A1617, A1619, A1717, A1719, A1817, A1819, A1917, A2017

Community, City View

A2117, A2217, A2317, A2417, A2517, A2617, A2717, A2817, A2917, A3017, A3117, A3217, A3317, A3417

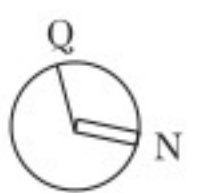

Disclaimer: 1. All dimensions are in metric, measured to wall finishes. 2. All materials, dimensions & drawings are approximate. 3. Information is subject to change without notice, at developer's absolute discretion. 4. Actual area may vary from the stated area. 5. Drawing are not to scale. 6. All images used are for illustrative purpose only and do not represent the actual size, features, specifications, fittings and furnishings. 7. The developer reserves the right to make revisions/ alterations, at its absolute discretion, without any liability whatsoever.

1 BEDROOM APARTMENT

TYPE B (with balcony) VARIANT 1

TOTAL SALEABLE AREA

SUITE RANGE = 490.40 SQ.FT. - 490.62 SQ.FT.

BALCONY = 56.51 SQ.FT.

TOTAL RANGE = 546.91 SQ.FT. - 547.13 SQ.FT.

 UNIT

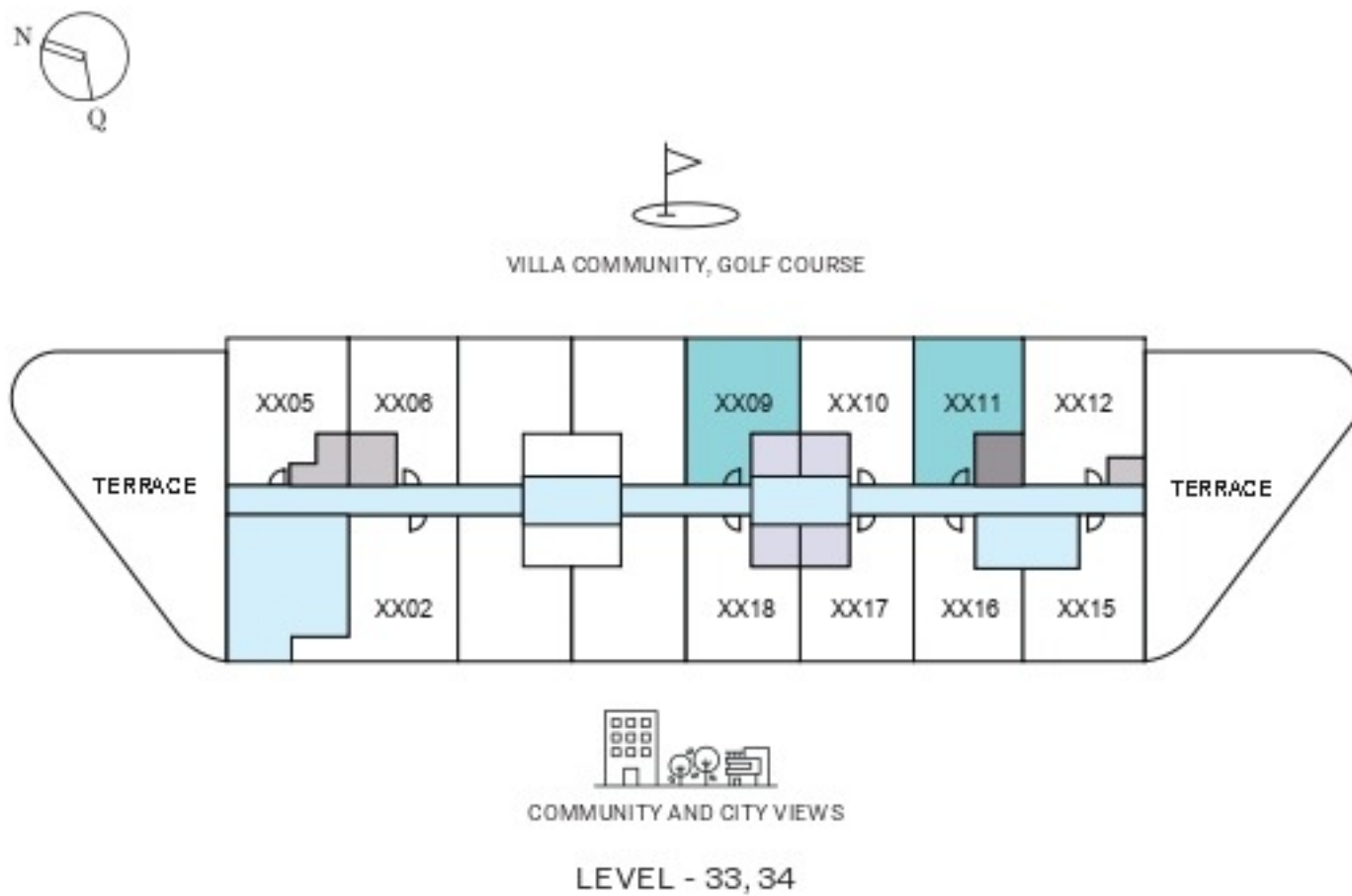
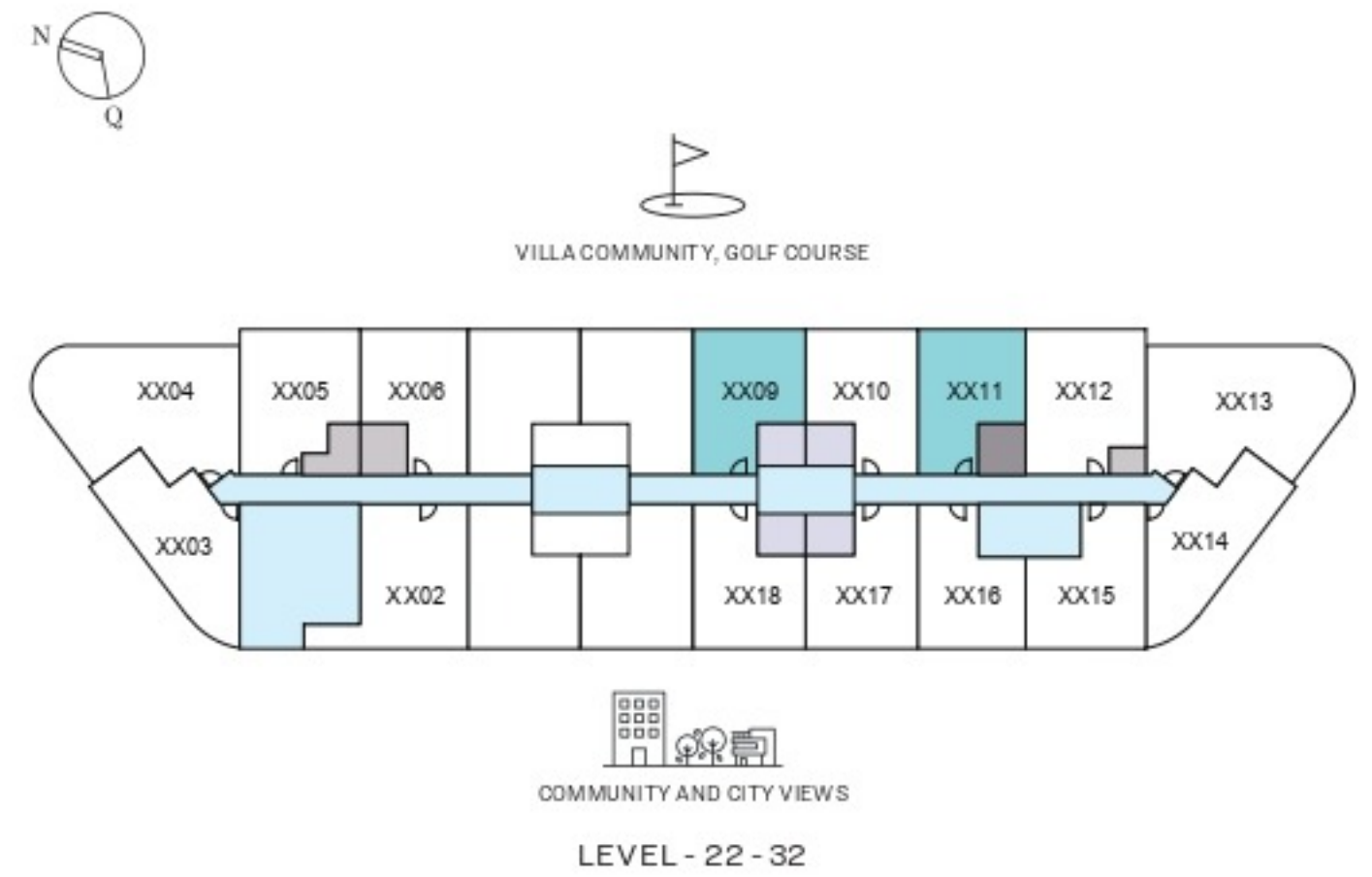
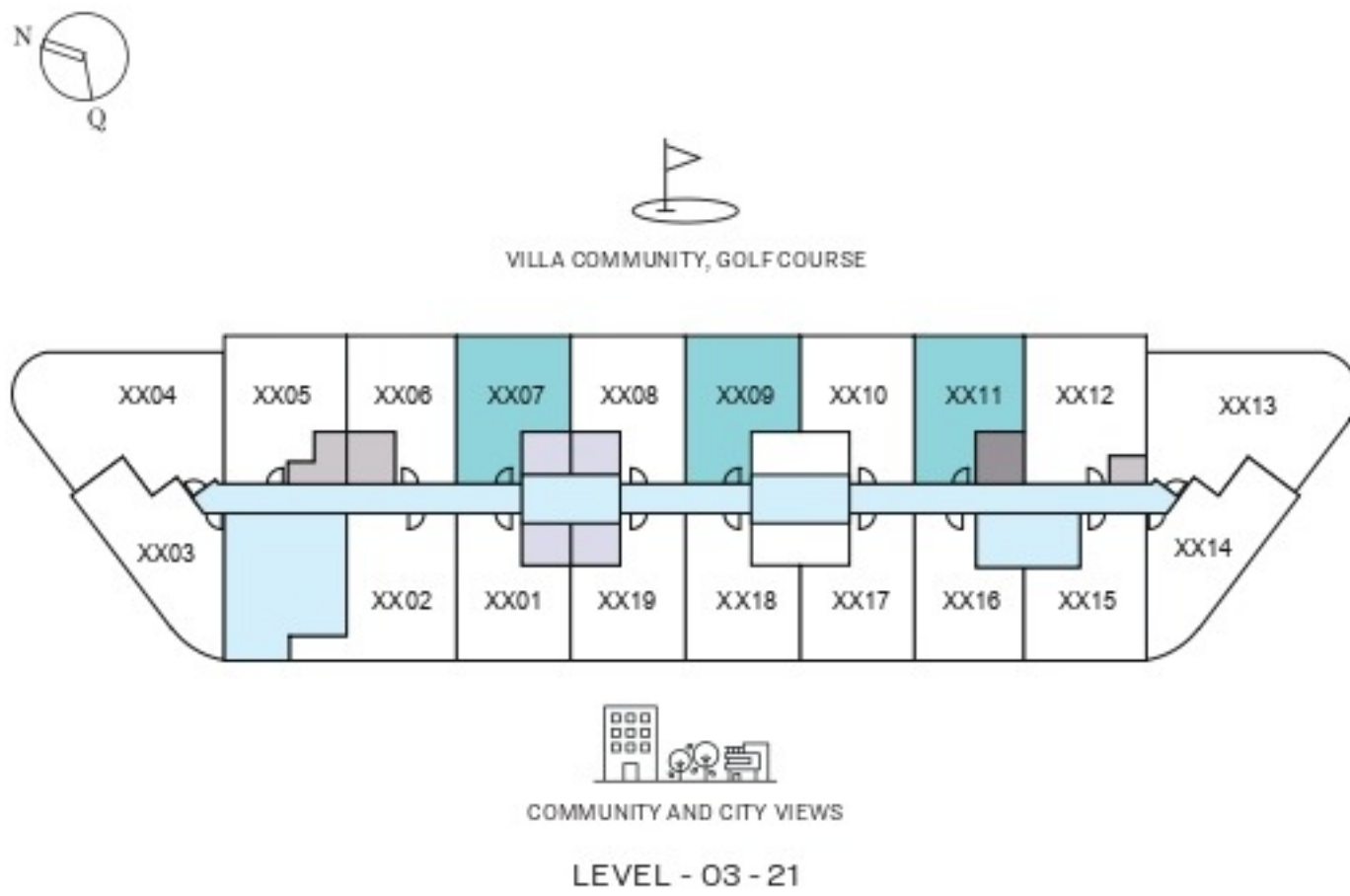

List of unit numbers with this unit plan:

VIEWS

Street View

A307, A309, A311, A407, A409, A411

Villa Community, Golf Course

A507, A509, A511, A607, A609, A611, A707, A709, A711, A807, A809, A811, A907, A909, A911, A1007, A1009, A1011, A1107, A1109, A1111, A1207, A1209, A1211, A1307, A1309, A1311, A1407, A1409, A1411, A1507, A1509, A1511, A1607, A1609, A1611, A1707, A1709, A1711, A1807, A1809, A1811, A1909, A1911, A2009, A2011, A2109, A2111, A2209, A2211, A2309, A2311, A2409, A2411, A2509, A2511, A2609, A2611, A2709, A2711, A2809, A2811, A2909, A2911, A3009, A3011, A3109, A3111, A3209, A3211, A3309, A3311, A3409, A3411

Disclaimer: 1. All dimensions are in metric, measured to wall finishes. 2. All materials, dimensions & drawings are approximate. 3. Information is subject to change without notice, at developer's absolute discretion. 4. Actual area may vary from the stated area. 5. Drawing are not to scale. 6. All images used are for illustrative purpose only and do not represent the actual size, features, specifications, fittings and furnishings. 7. The developer reserves the right to make revisions/ alterations, at its absolute discretion, without any liability whatsoever.

1 BEDROOM APARTMENT

TYPE B (with balcony) VARIANT 1

TOTAL SALEABLE AREA

SUITE RANGE = 490.40 SQ.FT. - 490.62 SQ.FT.

BALCONY = 56.51 SQ.FT.

TOTAL RANGE = 546.91 SQ.FT. - 547.13 SQ.FT.

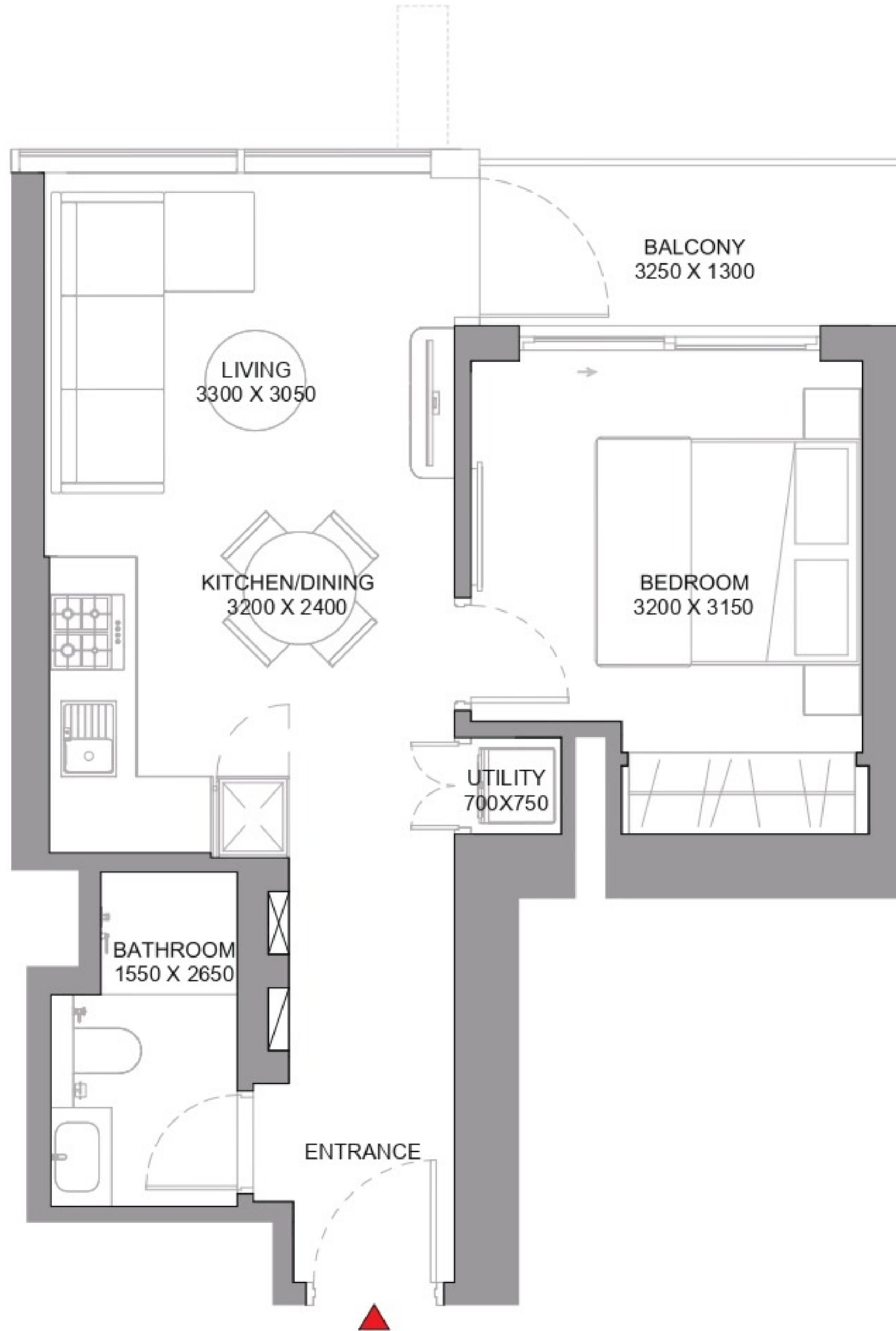

List of unit numbers with this unit plan:

VIEWS

Street View

A307, A309, A311, A407, A409, A411

Villa Community, Golf Course

A507, A509, A511, A607, A609, A611, A707, A709, A711, A807, A809, A811, A907, A909, A911, A1007, A1009, A1011, A1107, A1109, A1111, A1207, A1209, A1211, A1307, A1309, A1311, A1407, A1409, A1411, A1507, A1509, A1511, A1607, A1609, A1611, A1707, A1709, A1711, A1807, A1809, A1811, A1909, A1911, A2009, A2011, A2109, A2111, A2209, A2211, A2309, A2311, A2409, A2411, A2509, A2511, A2609, A2611, A2709, A2711, A2809, A2811, A2909, A2911, A3009, A3011, A3109, A3111, A3209, A3211, A3309, A3311, A3409, A3411

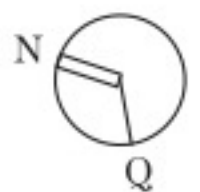

Disclaimer: 1. All dimensions are in metric, measured to wall finishes. 2. All materials, dimensions & drawings are approximate. 3. Information is subject to change without notice, at developer's absolute discretion. 4. Actual area may vary from the stated area. 5. Drawing are not to scale. 6. All images used are for illustrative purpose only and do not represent the actual size, features, specifications, fittings and furnishings. 7. The developer reserves the right to make revisions/ alterations, at its absolute discretion, without any liability whatsoever.

1 BEDROOM APARTMENT

TYPE C (with store room + balcony)

TOTAL SALEABLE AREA

SUITE = 524.31 SQ.FT.
BALCONY = 56.51 SQ.FT.
TOTAL = 580.82 SQ.FT.

 UNIT

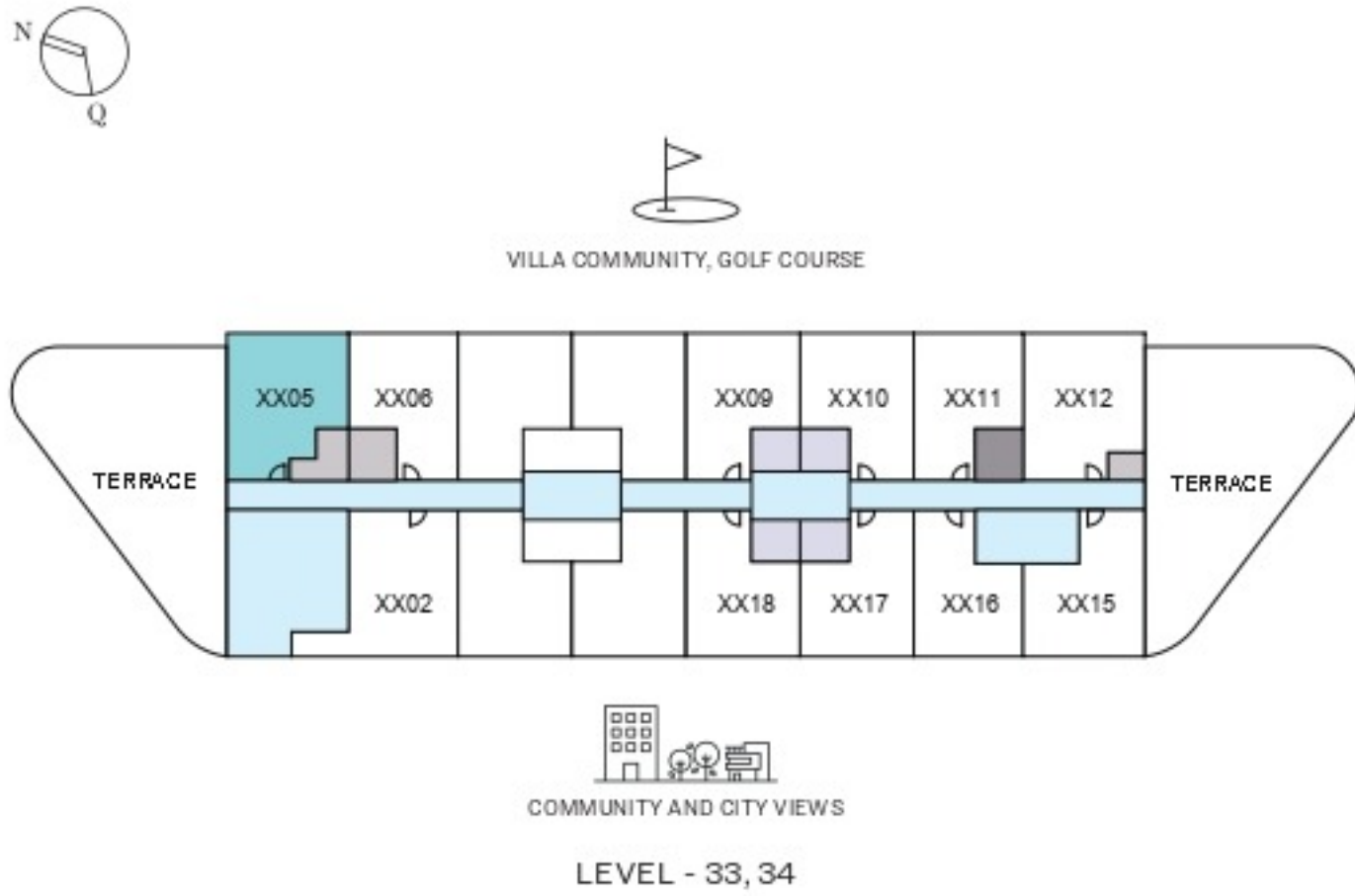
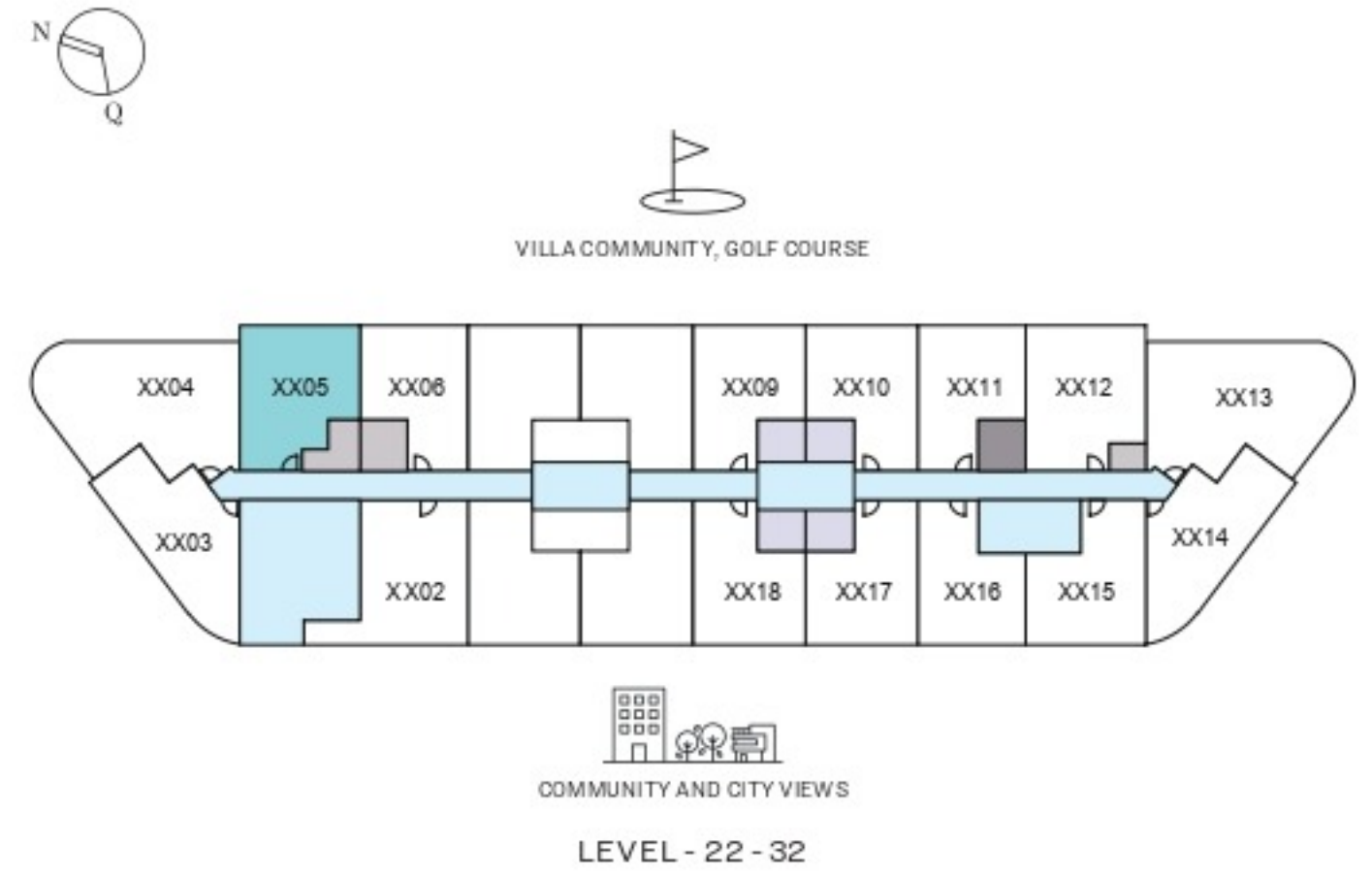

List of unit numbers with this unit plan:

VIEWS

Street View

A305, A405

Villa Community, Golf Course

A505, A605, A705, A805, A1305, A1405, A1505, A1605, A1705, A1805, A2105, A2205, A2505, A2605, A2705, A2805, A3105, A3205, A3305, A3405

Disclaimer: 1. All dimensions are in metric, measured to wall finishes. 2. All materials, dimensions & drawings are approximate. 3. Information is subject to change without notice, at developer's absolute discretion. 4. Actual area may vary from the stated area. 5. Drawing are not to scale. 6. All images used are for illustrative purpose only and do not represent the actual size, features, specifications, fittings and furnishings. 7. The developer reserves the right to make revisions/ alterations, at its absolute discretion, without any liability whatsoever.

1 BEDROOM APARTMENT

TYPE C (with store room + balcony)

TOTAL SALEABLE AREA

SUITE = 524.31 SQ.FT.
BALCONY = 56.51 SQ.FT.
TOTAL = 580.82 SQ.FT.

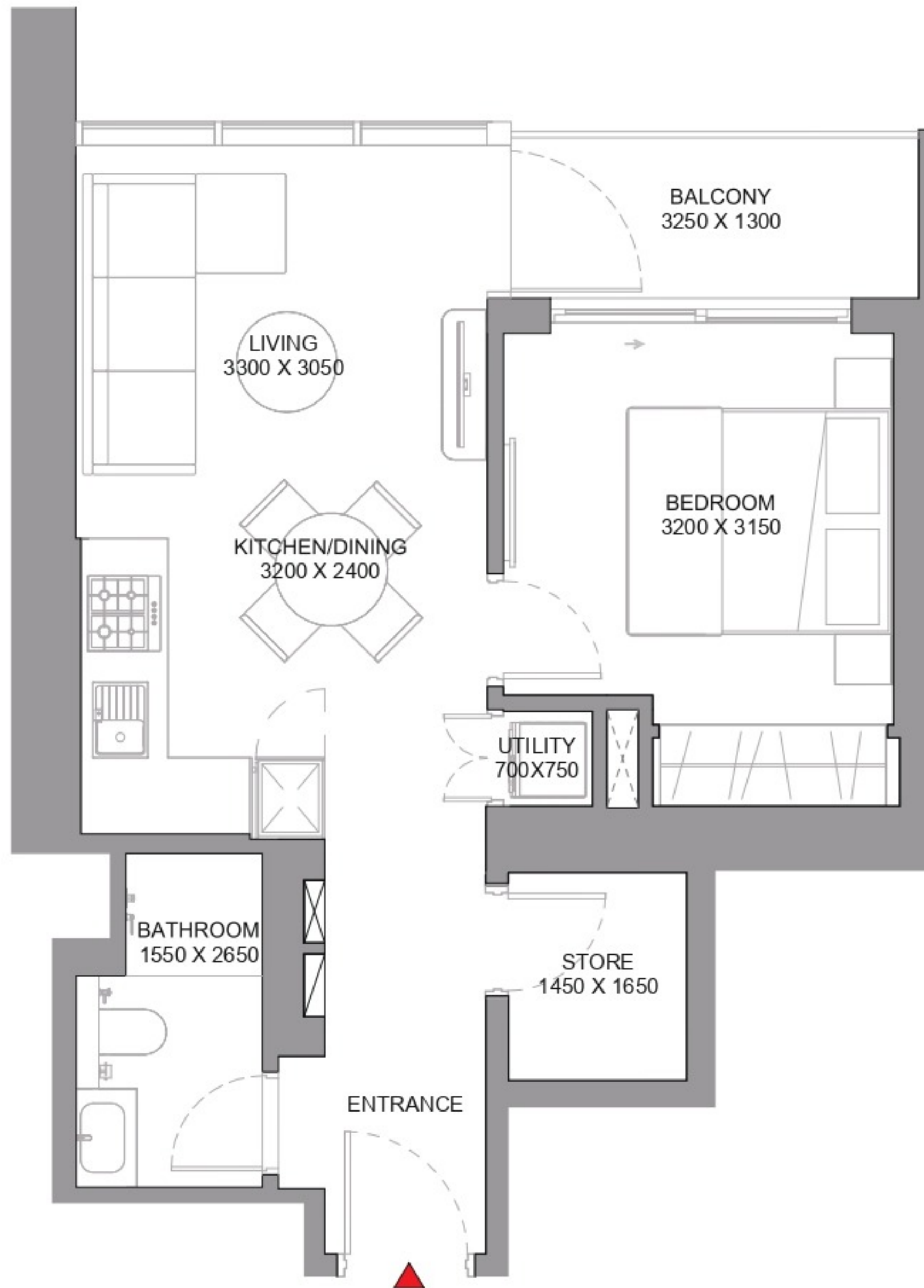

List of unit numbers with this unit plan:

VIEWS

Street View

A305, A405

Villa Community, Golf Course

A505, A605, A705, A805, A1305, A1405, A1505, A1605, A1705, A1805, A2105, A2205, A2505, A2605, A2705, A2805, A3105, A3205, A3305, A3405

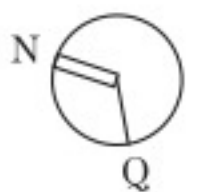

1 BEDROOM APARTMENT

TYPE D (with balcony)

TOTAL SALEABLE AREA

SUITE = 484.27 SQ.FT.

BALCONY = 54.14 SQ.FT.

TOTAL = 538.41 SQ.FT.

 UNIT

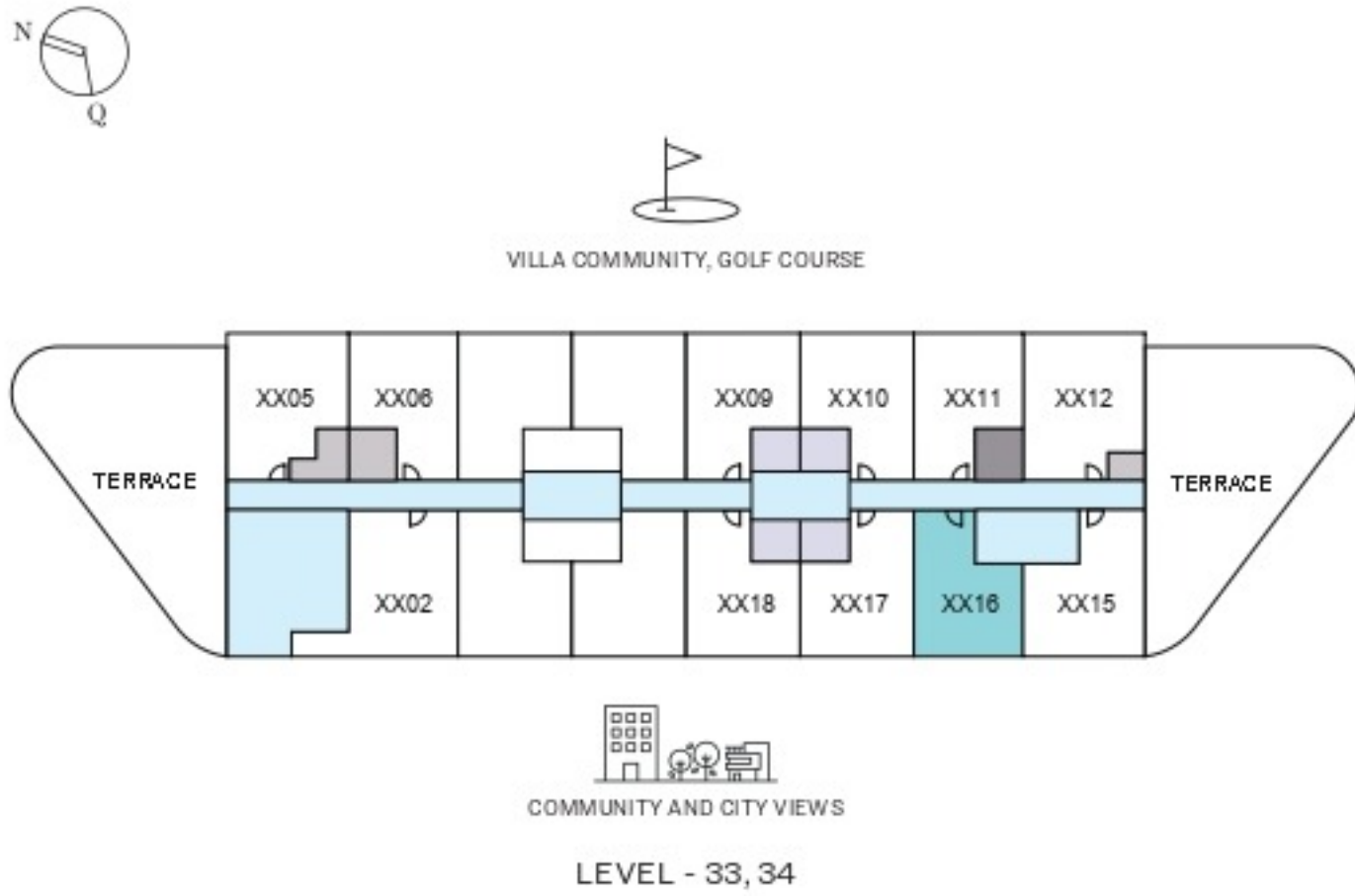
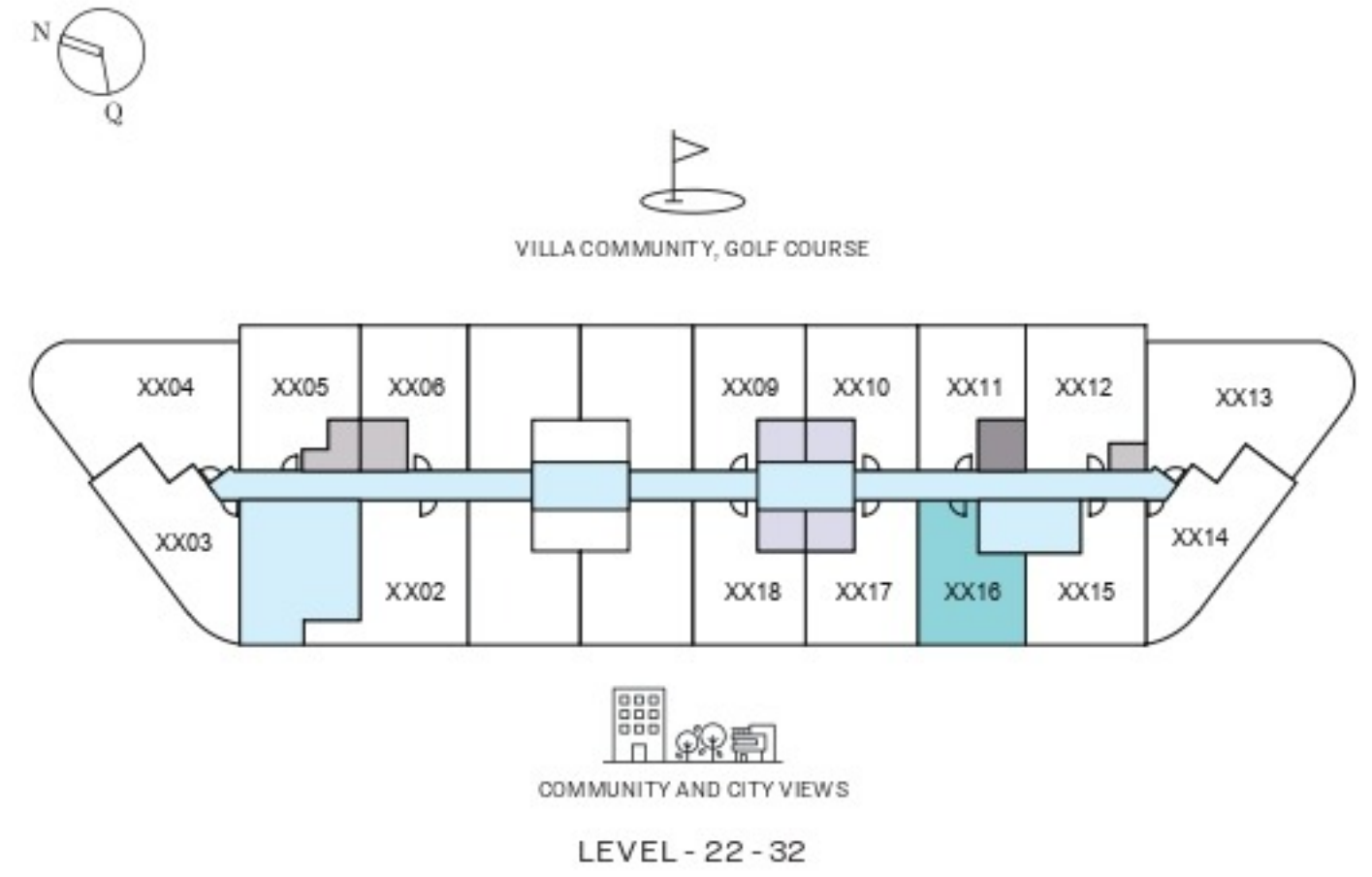
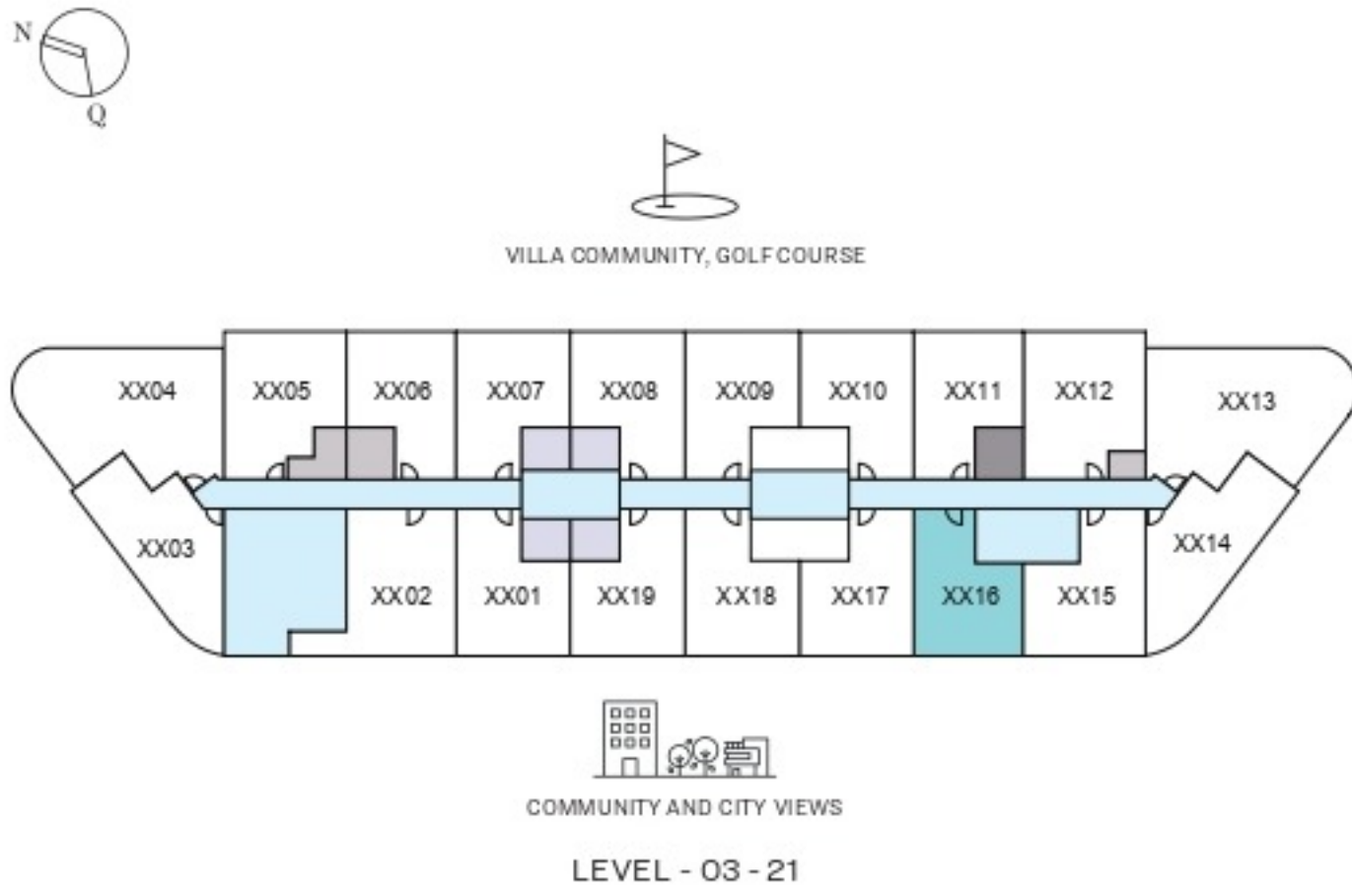

List of unit numbers with this unit plan:

VIEWS

Amenities

A316, A416, A516, A616, A716, A816, A916, A1016, A1116, A1216, A1316, A1416, A1516, A1616, A1716, A1816, A1916, A2016

Community, City View

A2116, A2216, A2316, A2416, A2516, A2616, A2716, A2816, A2916, A3016, A3116, A3216, A3316, A3416

Disclaimer: 1. All dimensions are in metric, measured to wall finishes. 2. All materials, dimensions & drawings are approximate. 3. Information is subject to change without notice, at developer's absolute discretion. 4. Actual area may vary from the stated area. 5. Drawing are not to scale. 6. All images used are for illustrative purpose only and do not represent the actual size, features, specifications, fittings and furnishings. 7. The developer reserves the right to make revisions/ alterations, at its absolute discretion, without any liability whatsoever.

1 BEDROOM APARTMENT

TYPE D (with balcony)

TOTAL SALEABLE AREA

SUITE = 484.27 SQ.FT.

BALCONY = 54.14 SQ.FT.

TOTAL = 538.41 SQ.FT.

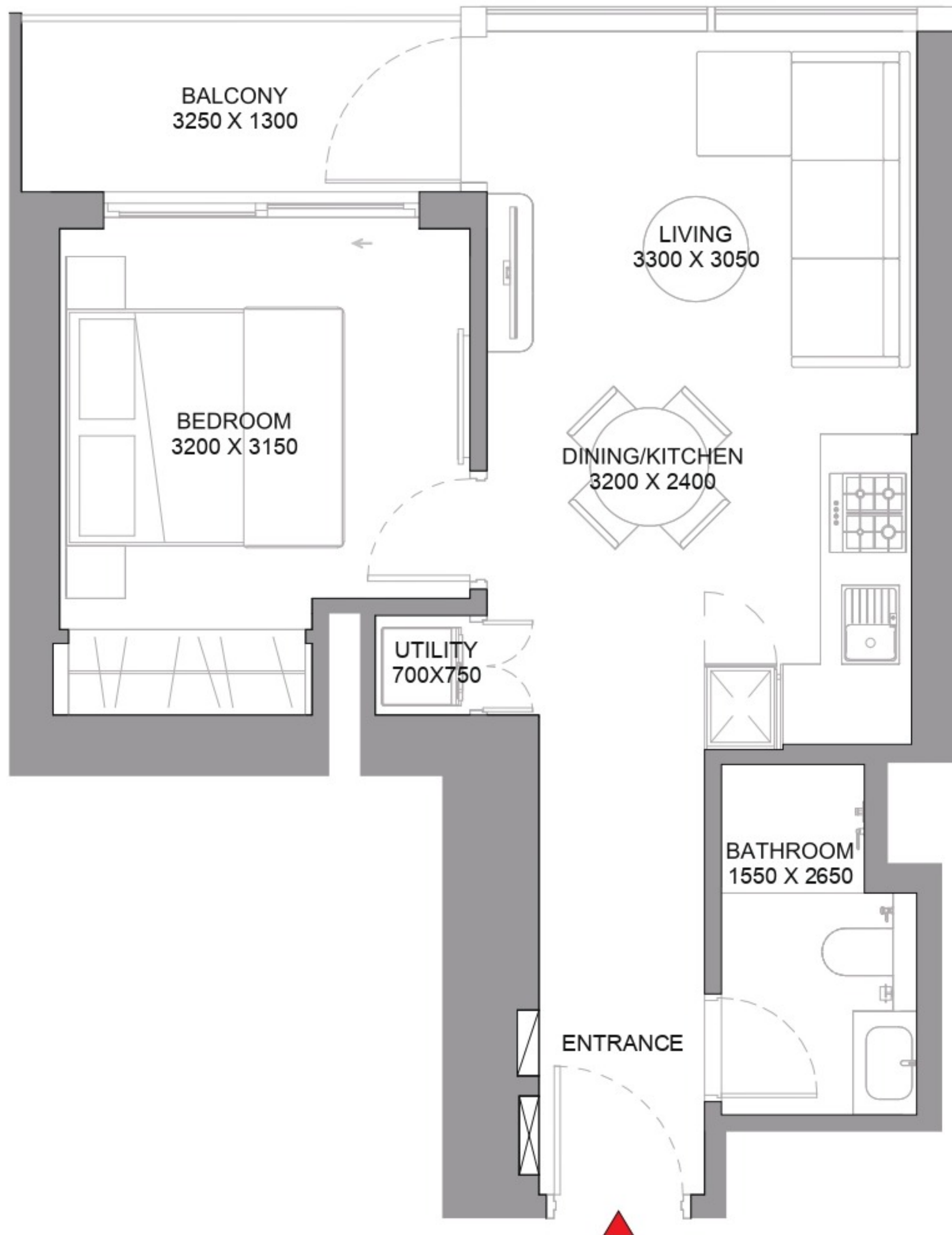

List of unit numbers with this unit plan:

VIEWS

Amenities

A316, A416, A516, A616, A716, A816, A916, A1016, A1116, A1216, A1316, A1416, A1516, A1616, A1716, A1816, A1916, A2016

Community, City View

A2116, A2216, A2316, A2416, A2516, A2616, A2716, A2816, A2916, A3016, A3116, A3216, A3316, A3416

Disclaimer: 1. All dimensions are in metric, measured to wall finishes. 2. All materials, dimensions & drawings are approximate. 3. Information is subject to change without notice, at developer's absolute discretion. 4. Actual area may vary from the stated area. 5. Drawing are not to scale. 6. All images used are for illustrative purpose only and do not represent the actual size, features, specifications, fittings and furnishings. 7. The developer reserves the right to make revisions/ alterations, at its absolute discretion, without any liability whatsoever.



1 BEDROOM APARTMENT

TYPE E (with balcony)

TOTAL SALEABLE AREA

SUITE = 485.56 SQ.FT.

BALCONY = 54.14 SQ.FT.

TOTAL = 539.70 SQ.FT.

 UNIT

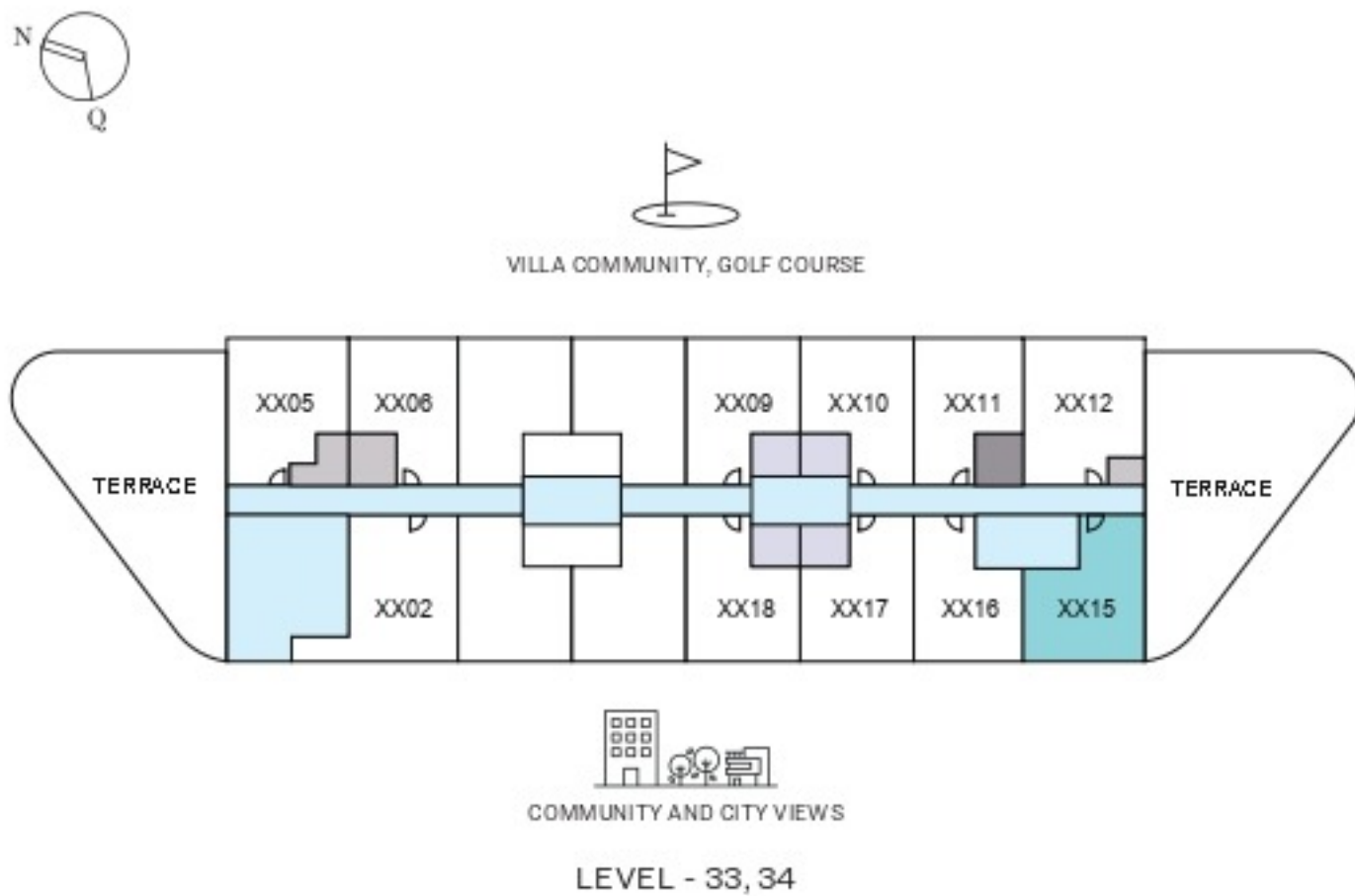
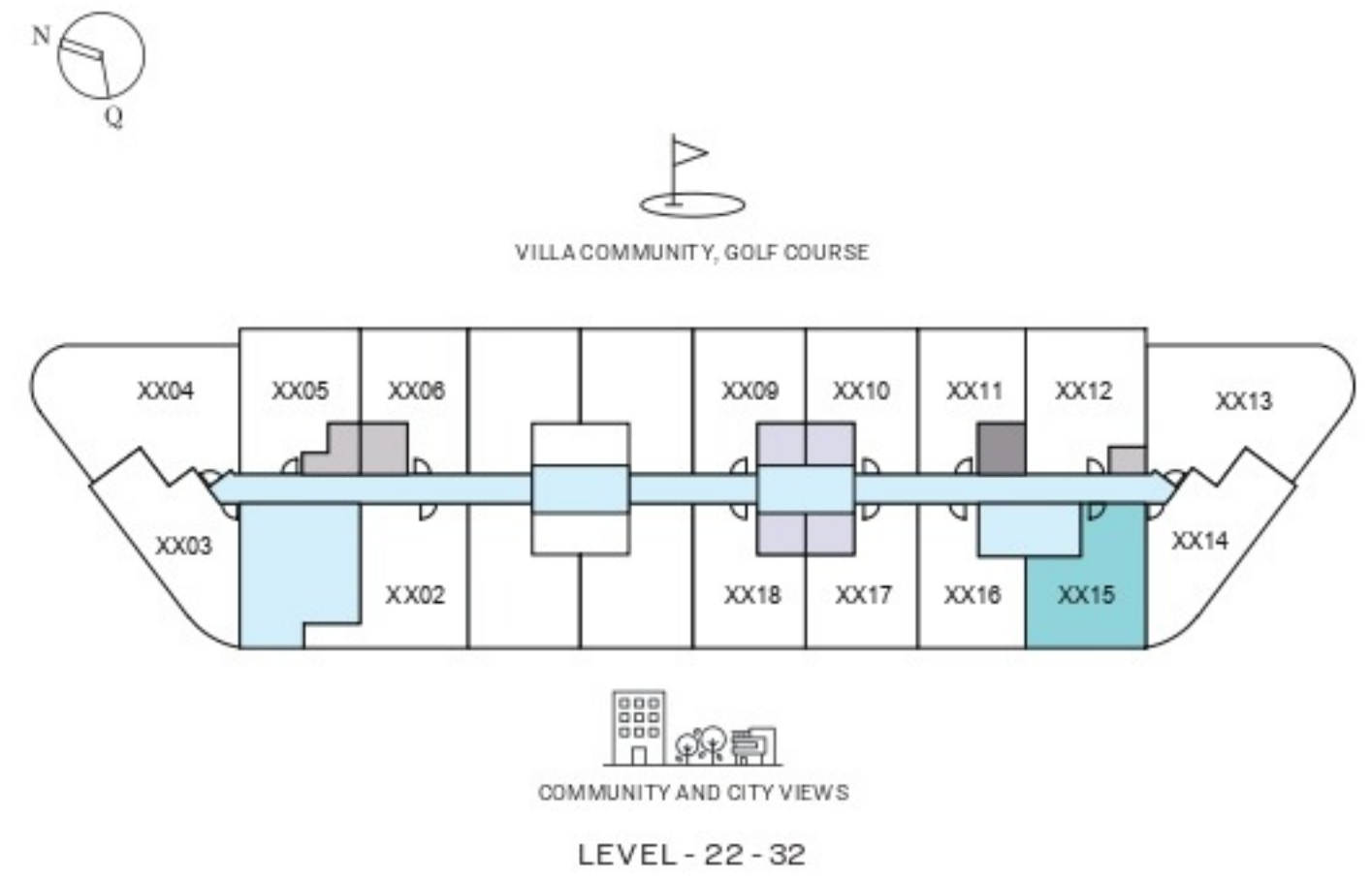
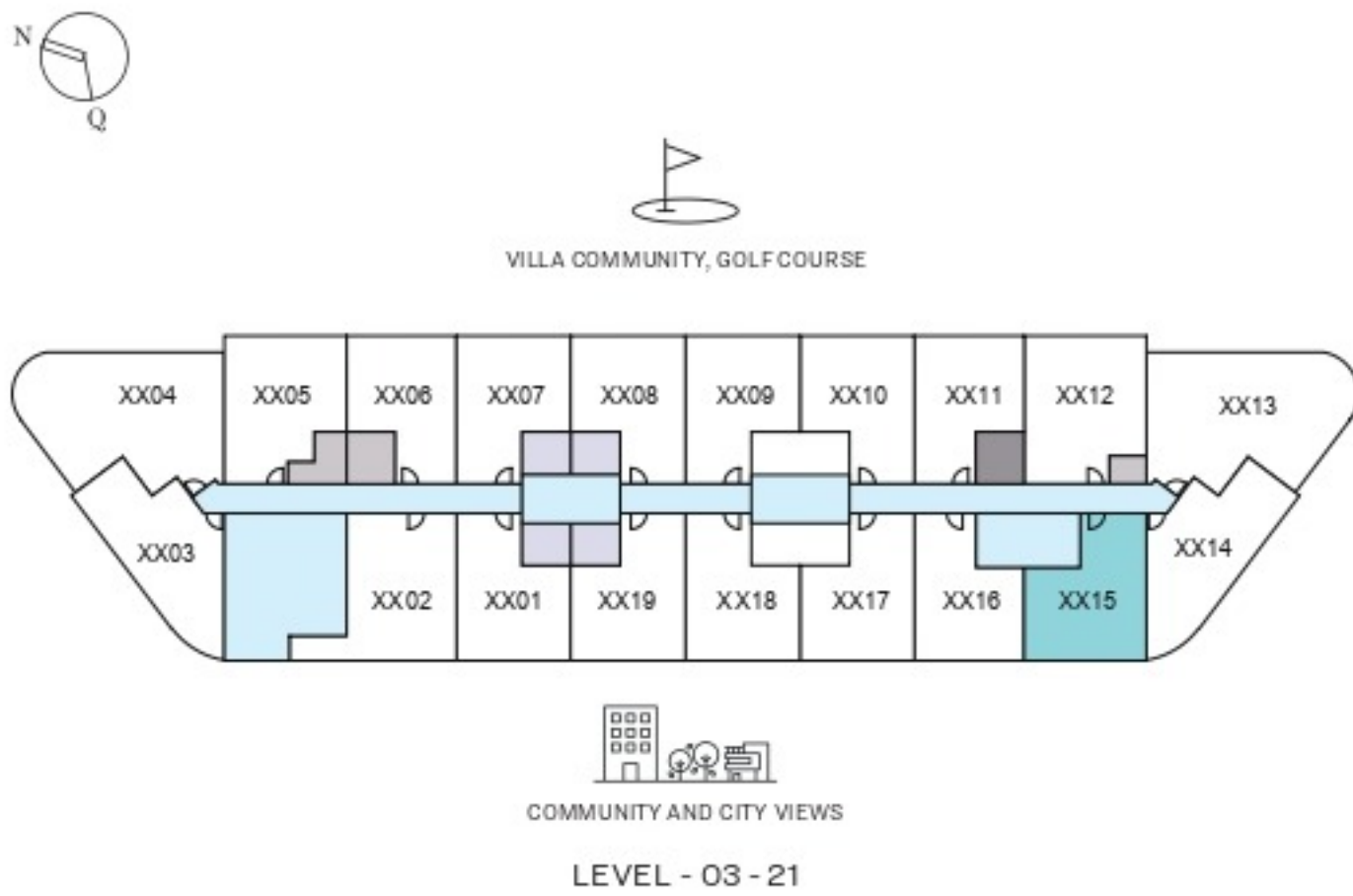

List of unit numbers with this unit plan:

VIEWS

Amenities

A315, A415, A515, A615, A715, A815, A915, A1015, A1115, A1215, A1315, A1415, A1515, A1615, A1715, A1815, A1915, A2015

Community, City View

A2115, A2215, A2315, A2415, A2515, A2615, A2715, A2815, A2915, A3015, A3115, A3215, A3315, A3415

Disclaimer: 1. All dimensions are in metric, measured to wall finishes. 2. All materials, dimensions & drawings are approximate. 3. Information is subject to change without notice, at developer's absolute discretion. 4. Actual area may vary from the stated area. 5. Drawing are not to scale. 6. All images used are for illustrative purpose only and do not represent the actual size, features, specifications, fittings and furnishings. 7. The developer reserves the right to make revisions/ alterations, at its absolute discretion, without any liability whatsoever.

1 BEDROOM APARTMENT

TYPE E (with balcony)

TOTAL SALEABLE AREA

SUITE = 485.56 SQ.FT.
BALCONY = 54.14 SQ.FT.
TOTAL = 539.70 SQ.FT.

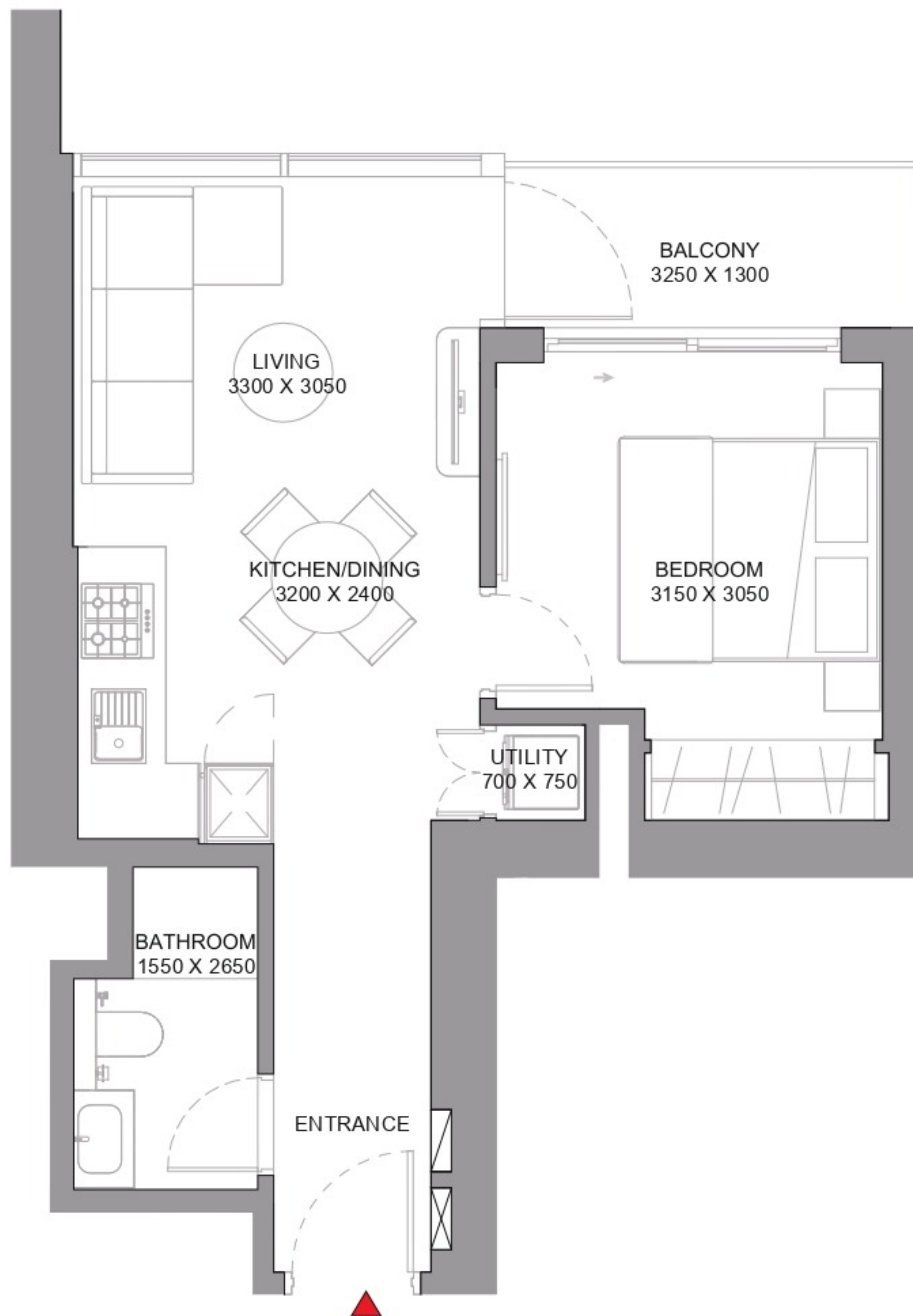

List of unit numbers with this unit plan:

VIEWS

Amenities

A315, A415, A515, A615, A715, A815, A915, A1015, A1115, A1215, A1315, A1415, A1515, A1615, A1715, A1815, A1915, A2015

Community, City View

A2115, A2215, A2315, A2415, A2515, A2615, A2715, A2815, A2915, A3015, A3115, A3215, A3315, A3415

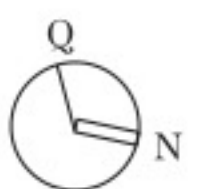

Disclaimer: 1. All dimensions are in metric, measured to wall finishes. 2. All materials, dimensions & drawings are approximate. 3. Information is subject to change without notice, at developer's absolute discretion. 4. Actual area may vary from the stated area. 5. Drawing are not to scale. 6. All images used are for illustrative purpose only and do not represent the actual size, features, specifications, fittings and furnishings. 7. The developer reserves the right to make revisions/ alterations, at its absolute discretion, without any liability whatsoever.

1.5 BEDROOM APARTMENT

TYPE A (with study room + balcony)

TOTAL SALEABLE AREA

SUITE = 609.02 SQ.FT.

BALCONY = 61.78 SQ.FT.

TOTAL = 670.80 SQ.FT.

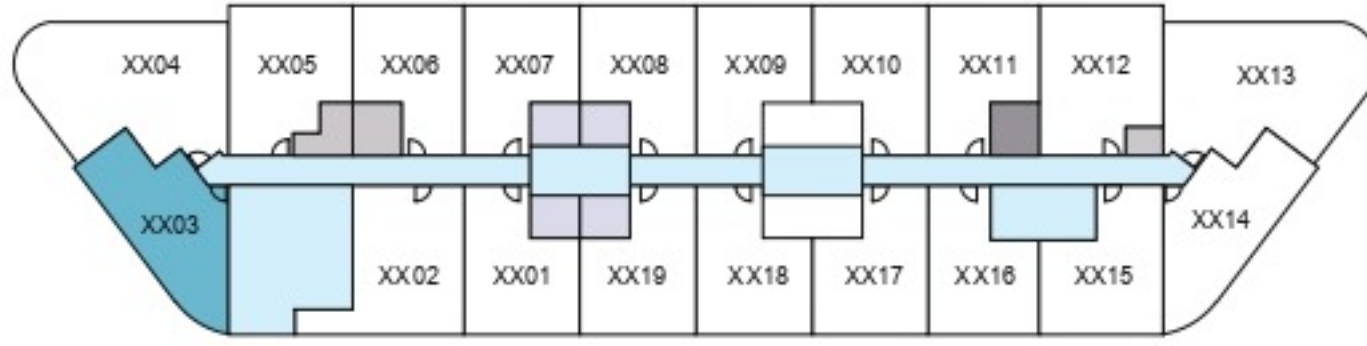

LEVEL - 03 - 21

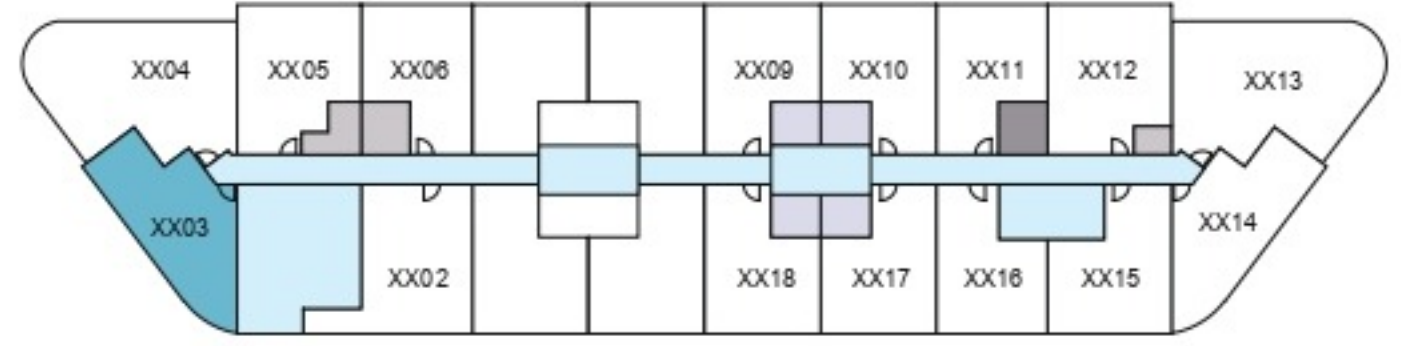
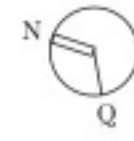

LEVEL - 22 - 32

UNIT

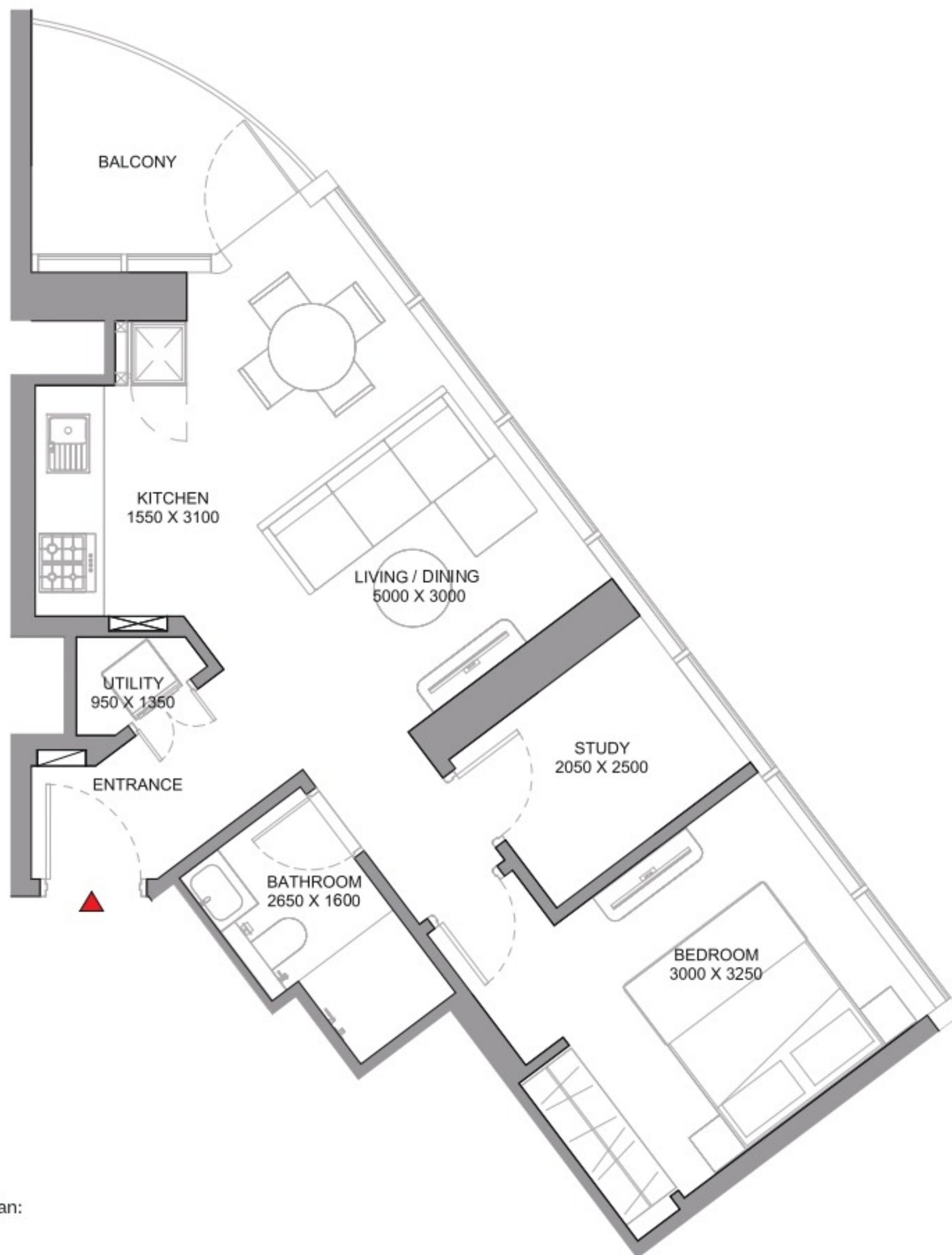

List of unit numbers with this unit plan:

VIEWS

Street View

A303, A403

Community, City View

A503, A603, A703, A803, A903, A1003, A1103, A1203, A1303, A1403, A1503, A1603, A1703, A1803, A1903, A2003, A2103, A2203, A2303, A2403, A2503, A2603, A2703, A2803, A2903, A3003, A3103, A3203

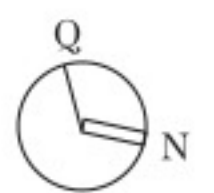

1.5 BEDROOM APARTMENT

TYPE B (with study room + balcony)

TOTAL SALEABLE AREA

SUITE = 605.25 SQ.FT.

BALCONY = 61.78 SQ.FT.

TOTAL = 667.03 SQ.FT.

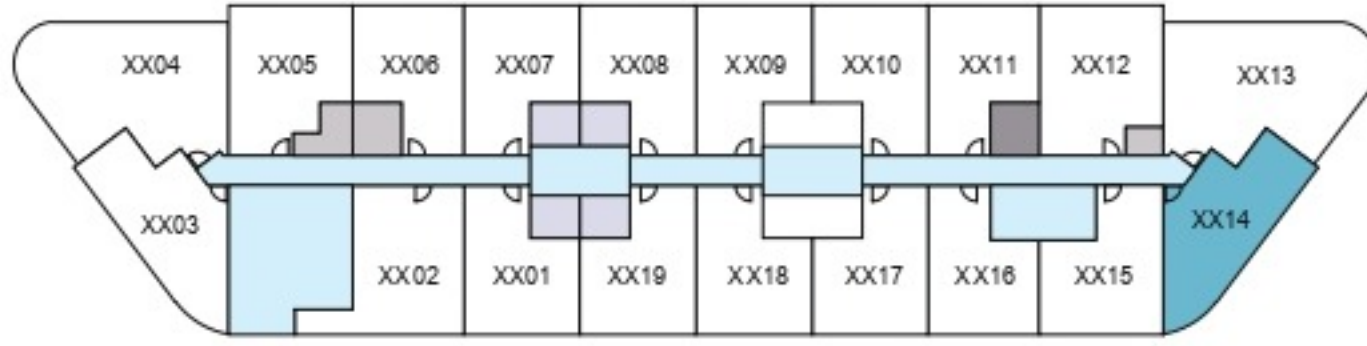
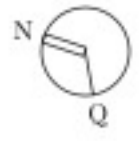

LEVEL - 03 - 21

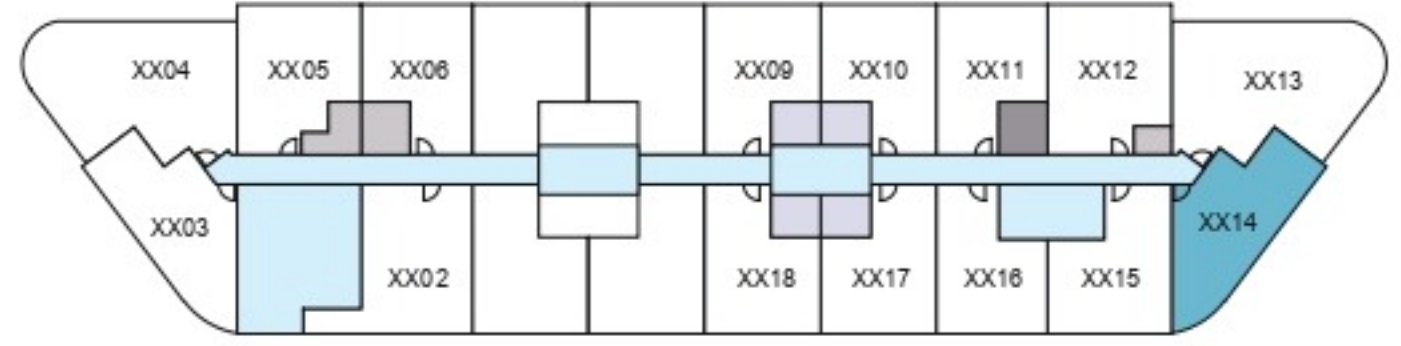
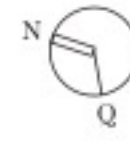

LEVEL - 22 - 32

UNIT

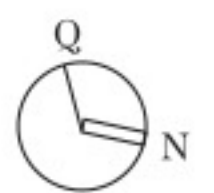
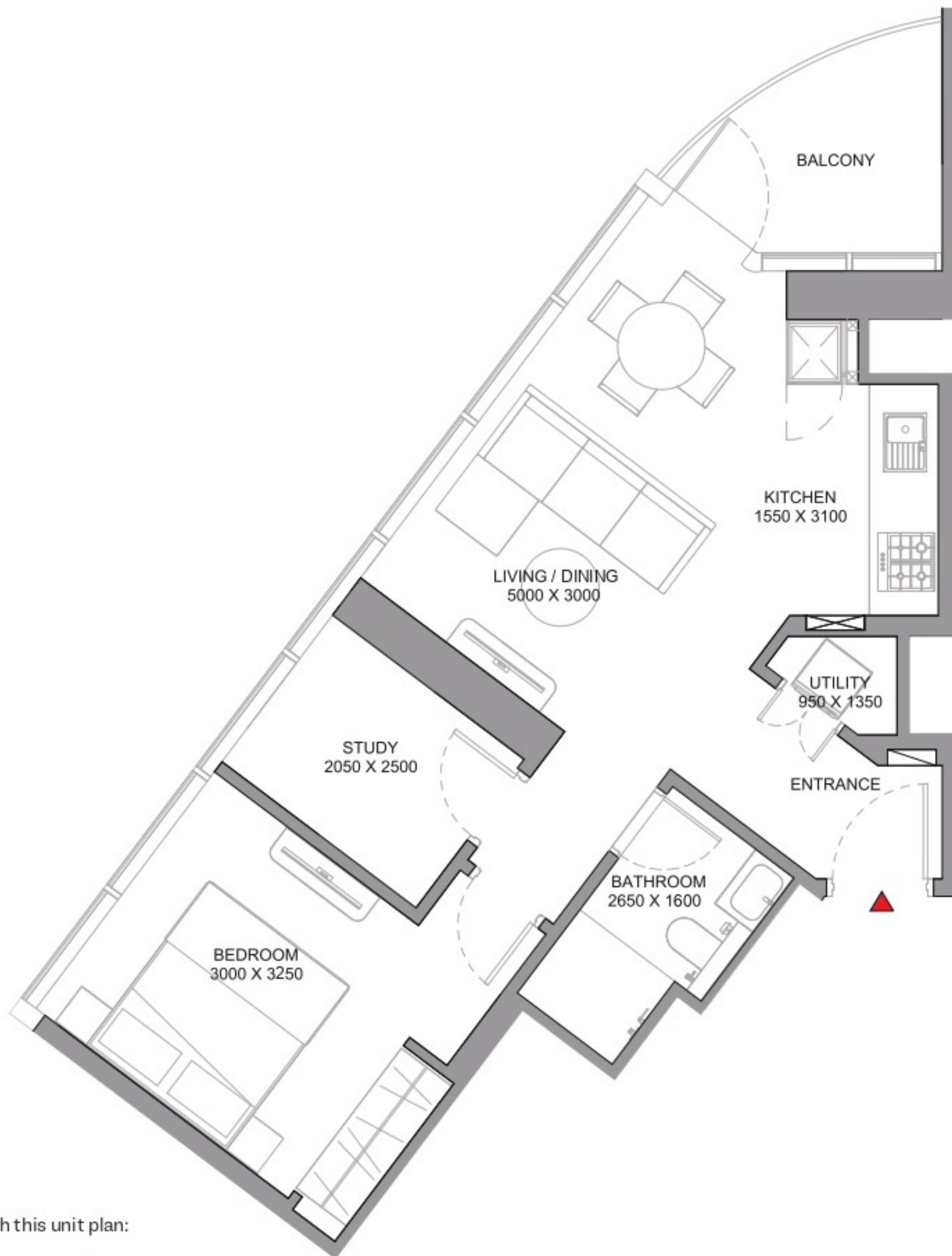

List of unit numbers with this unit plan:

VIEWS

Amenities

A314, A414, A514, A614, A714, A814, A914, A1014, A1114, A1214, A1314, A1414, A1514, A1614, A1714, A1814, A1914, A2014

Community, City View

A2114, A2214, A2314, A2414, A2514, A2614, A2714, A2814, A2914, A3014, A3114, A3214

Disclaimer: 1. All dimensions are in metric, measured to wall finishes. 2. All materials, dimensions & drawings are approximate. 3. Information is subject to change without notice, at developer's absolute discretion. 4. Actual area may vary from the stated area. 5. Drawing are not to scale. 6. All images used are for illustrative purpose only and do not represent the actual size, features, specifications, fittings and furnishings. 7. The developer reserves the right to make revisions/ alterations, at its absolute discretion, without any liability whatsoever.

1.5 BEDROOM APARTMENT

TYPE C (with store/study room, powder room + balcony)

TOTAL SALEABLE AREA

SUITE = 597.40 SQ.FT.
BALCONY = 99.78 SQ.FT.
TOTAL = 697.18 SQ.FT.

 UNIT

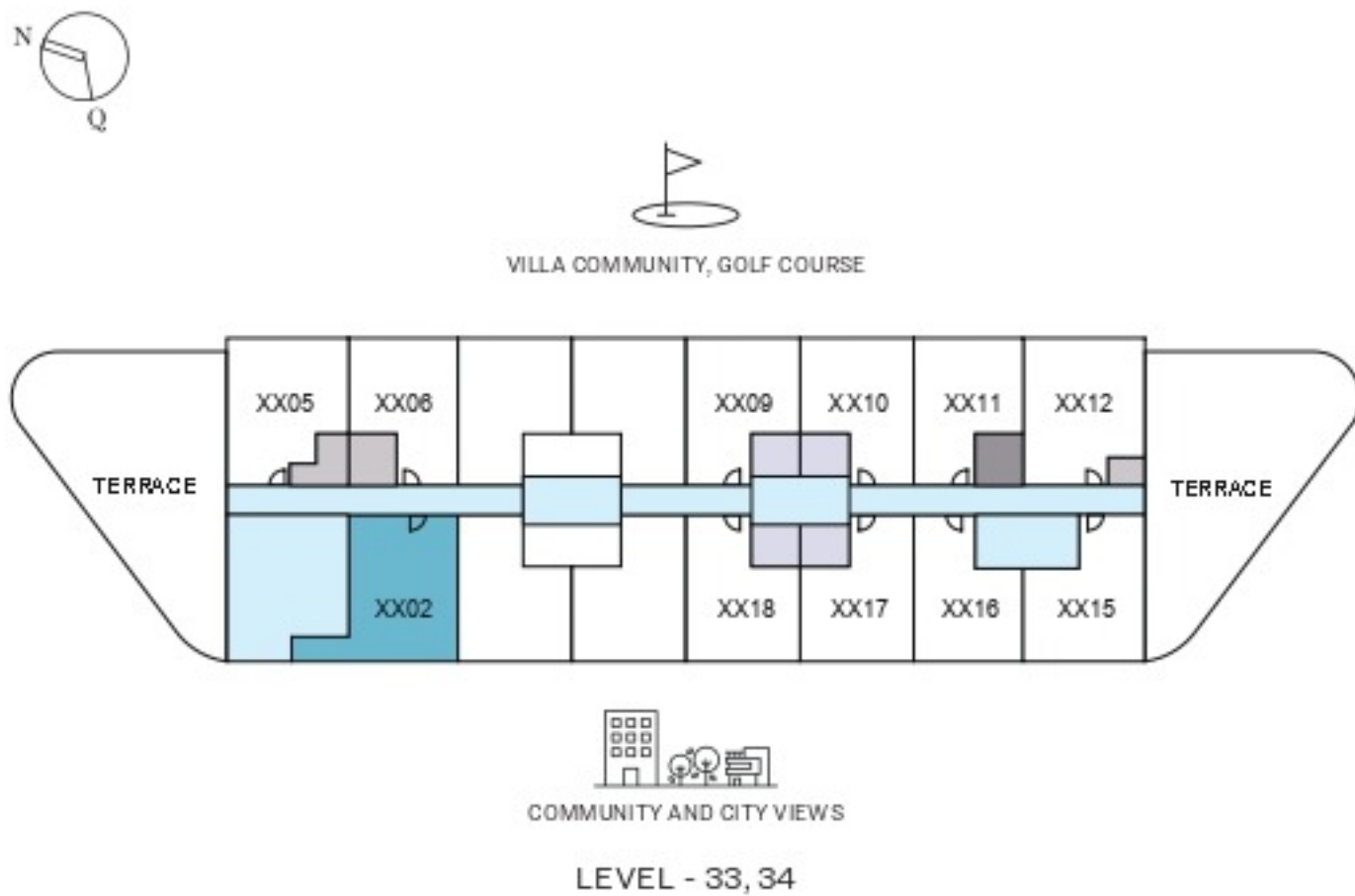
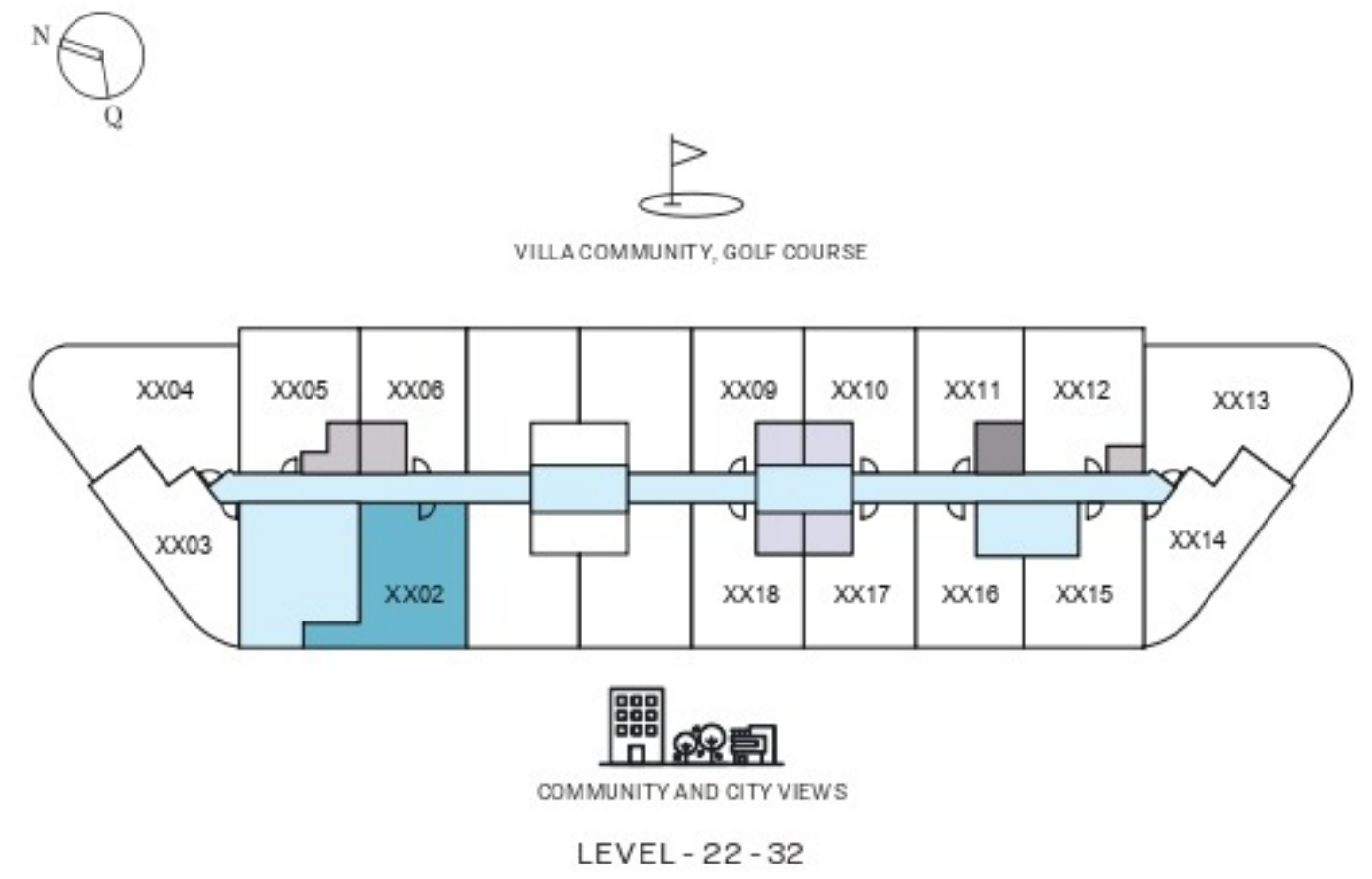
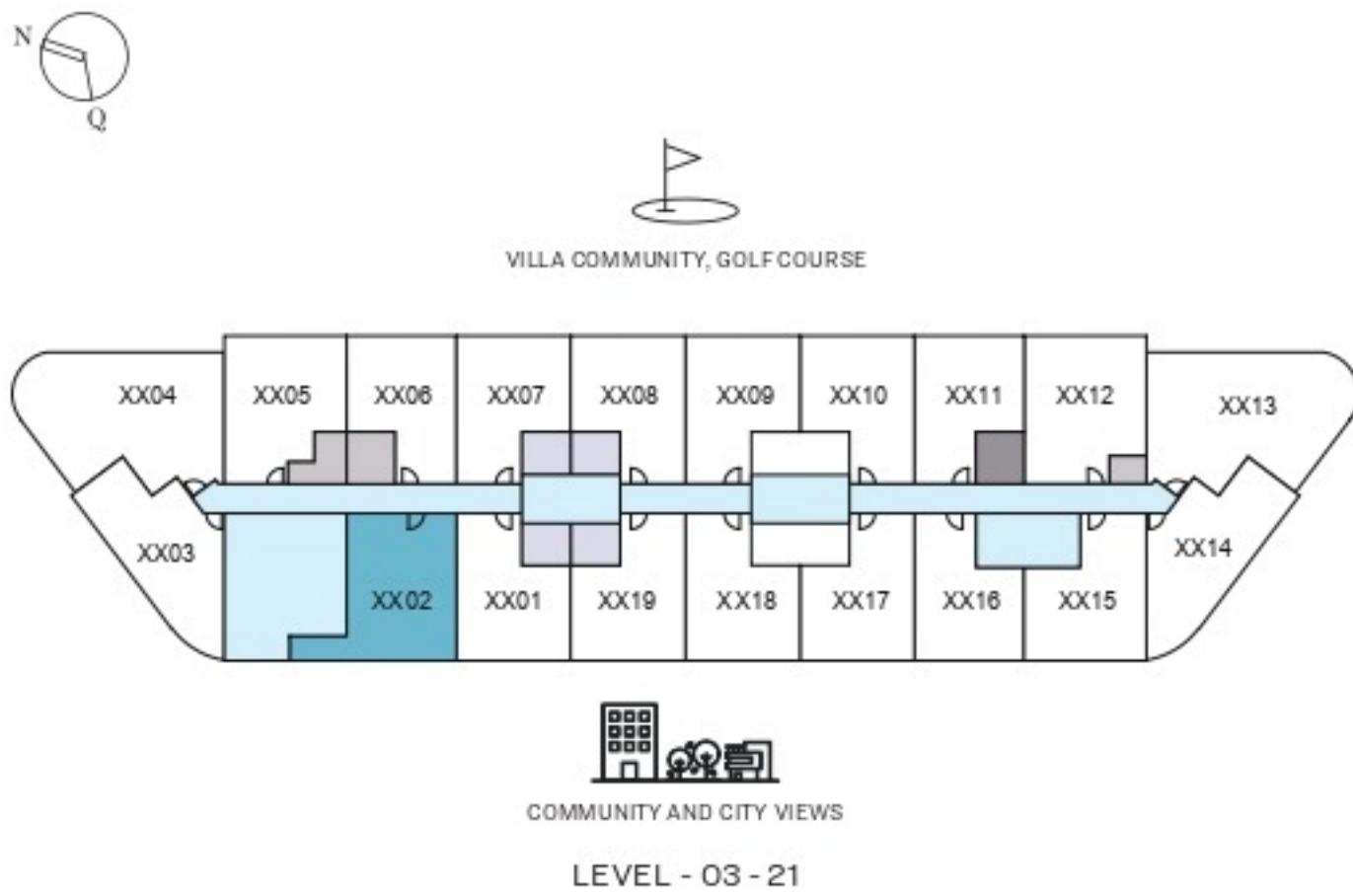

List of unit numbers with this unit plan:

VIEWS

Street View

A302, A402

Community, City View

A502, A602, A702, A802, A902, A1002, A1102, A1202, A1302, A1402, A1502, A1602, A1702, A1802, A1902, A2202, A2302, A2402, A2502, A2602, A2702, A2802, A2902, A3002, A3102, A3202, A3302, A3402

Disclaimer: 1. All dimensions are in metric, measured to wall finishes. 2. All materials, dimensions & drawings are approximate. 3. Information is subject to change without notice, at developer's absolute discretion. 4. Actual area may vary from the stated area. 5. Drawing are not to scale. 6. All images used are for illustrative purpose only and do not represent the actual size, features, specifications, fittings and furnishings. 7. The developer reserves the right to make revisions/ alterations, at its absolute discretion, without any liability whatsoever.

1.5 BEDROOM APARTMENT

TYPE C (with store/study room, powder room + balcony)

TOTAL SALEABLE AREA

SUITE = 597.40 SQ.FT.
BALCONY = 99.78 SQ.FT.
TOTAL = 697.18 SQ.FT.

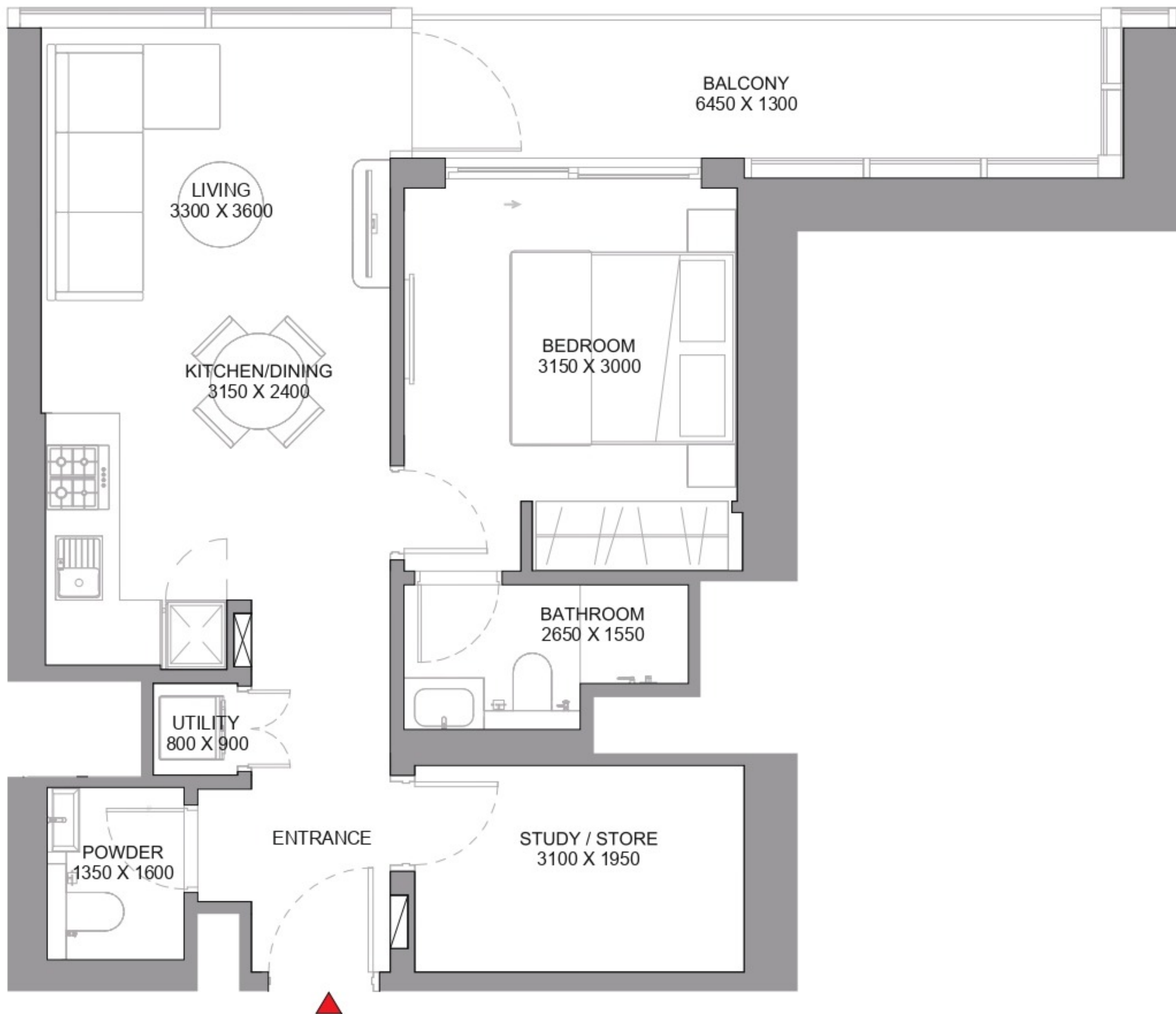

List of unit numbers with this unit plan:

VIEWS

Street View

A302, A402

Community, City View

A502, A602, A702, A802, A902, A1002, A1102, A1202, A1302, A1402, A1502, A1602, A1702, A1802, A1902, A2202, A2302, A2402, A2502, A2602, A2702, A2802, A2902, A3002, A3102, A3202, A3302, A3402

Disclaimer: 1. All dimensions are in metric, measured to wall finishes. 2. All materials, dimensions & drawings are approximate. 3. Information is subject to change without notice, at developer's absolute discretion. 4. Actual area may vary from the stated area. 5. Drawing are not to scale. 6. All images used are for illustrative purpose only and do not represent the actual size, features, specifications, fittings and furnishings. 7. The developer reserves the right to make revisions/ alterations, at its absolute discretion, without any liability whatsoever.

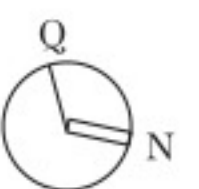

1.5 BEDROOM APARTMENT

TYPE D (with store/study room, powder room + balcony)

TOTAL SALEABLE AREA

SUITE = 567.47 SQ.FT.

BALCONY = 56.51 SQ.FT.

TOTAL = 623.98 SQ.FT.

 UNIT

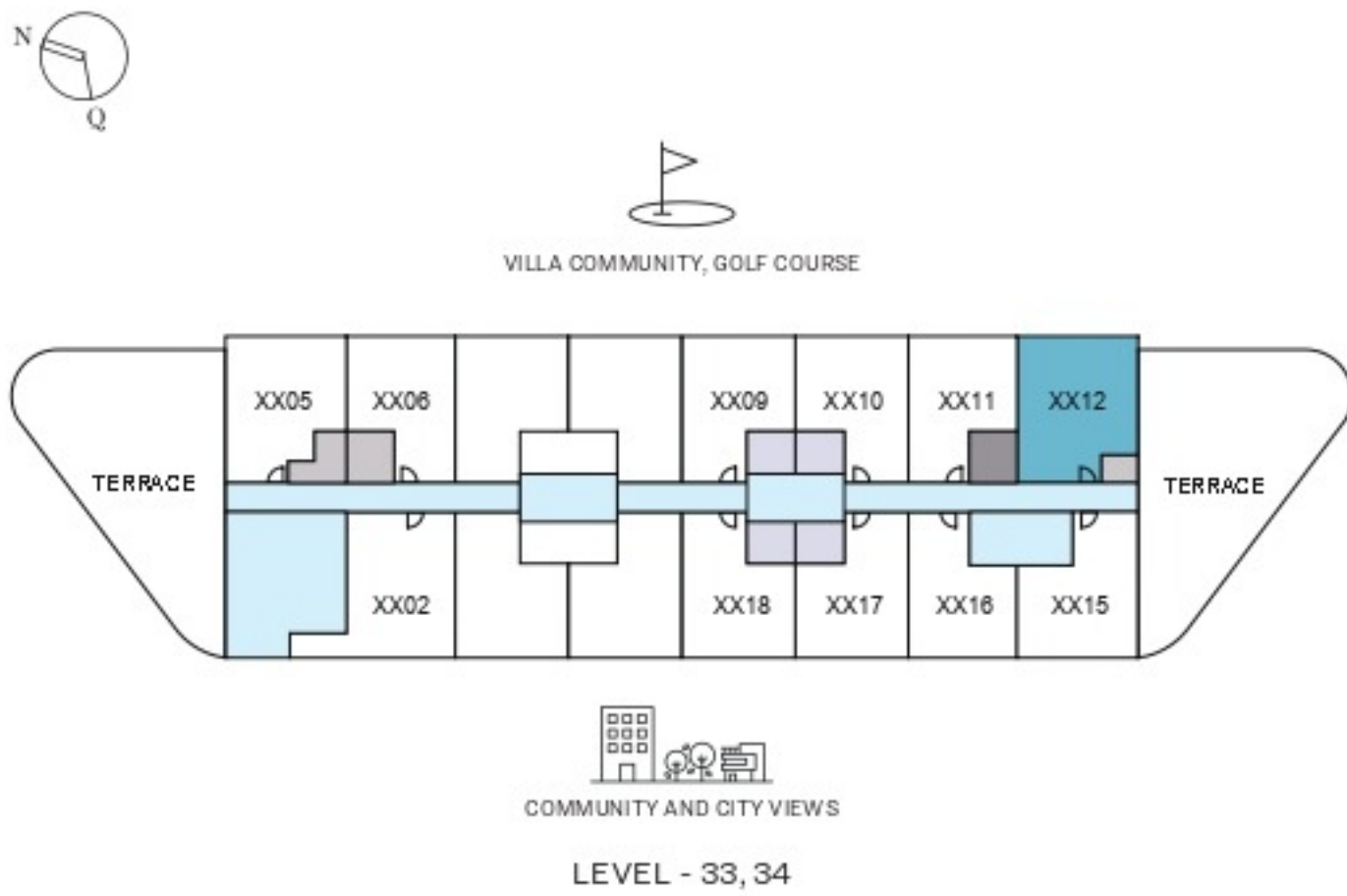
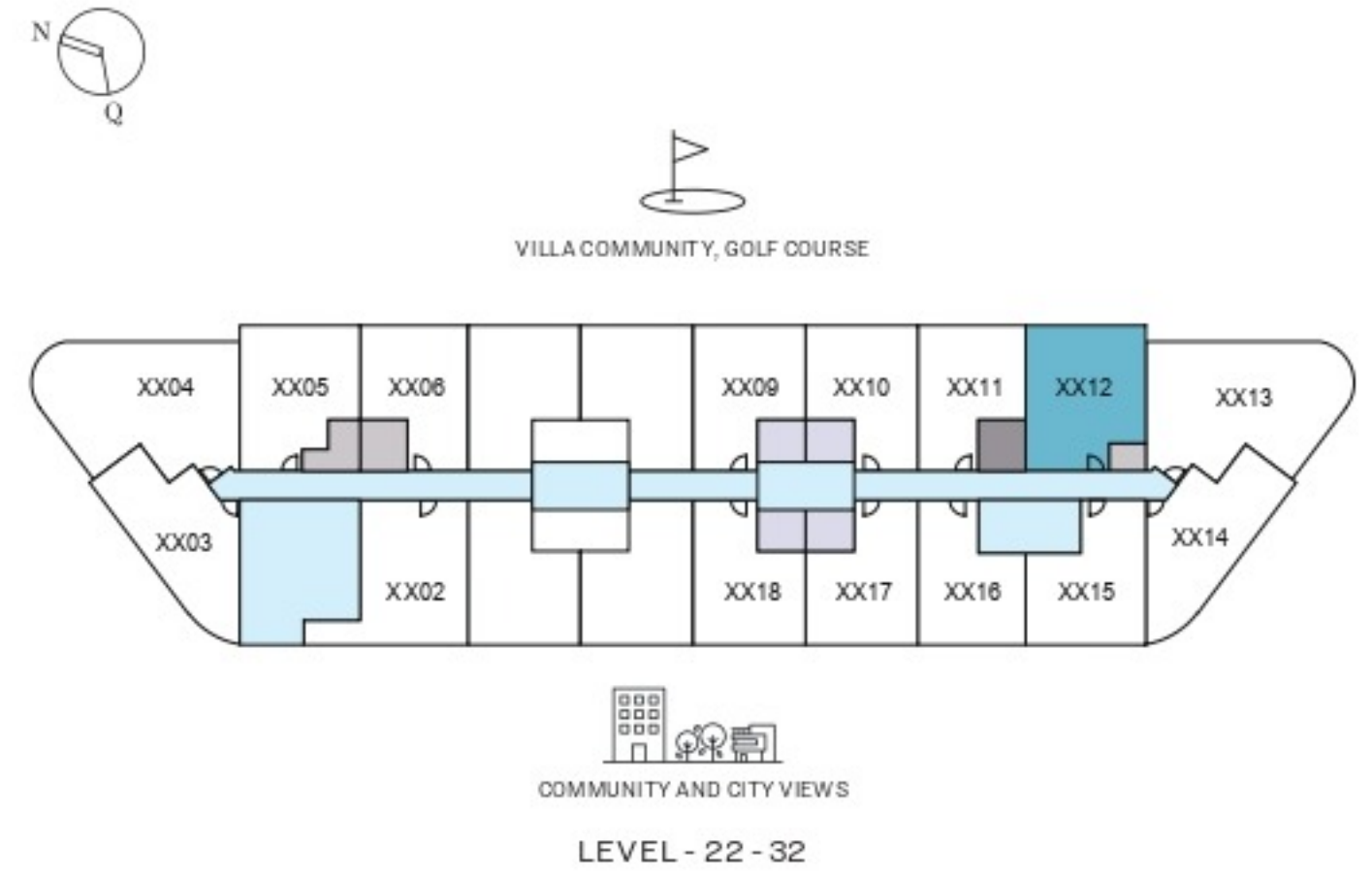

List of unit numbers with this unit plan:

VIEWS

Street View

A312, A412

Villa Community, Golf Course

A512, A612, A712, A812, A912, A1012, A1112, A1212, A1312, A1412, A1512, A1612, A1712, A1812, A1912, A2012, A2112, A2212, A2312, A2412, A2512, A2612, A2712, A2812, A2912, A3012, A3112, A3212, A3312, A3412

Disclaimer: 1. All dimensions are in metric, measured to wall finishes. 2. All materials, dimensions & drawings are approximate. 3. Information is subject to change without notice, at developer's absolute discretion. 4. Actual area may vary from the stated area. 5. Drawing are not to scale. 6. All images used are for illustrative purpose only and do not represent the actual size, features, specifications, fittings and furnishings. 7. The developer reserves the right to make revisions/ alterations, at its absolute discretion, without any liability whatsoever.

1.5 BEDROOM APARTMENT

TYPE D (with store/study room, powder room + balcony)

TOTAL SALEABLE AREA

SUITE = 567.47 SQ.FT.

BALCONY = 56.51 SQ.FT.

TOTAL = 623.98 SQ.FT.

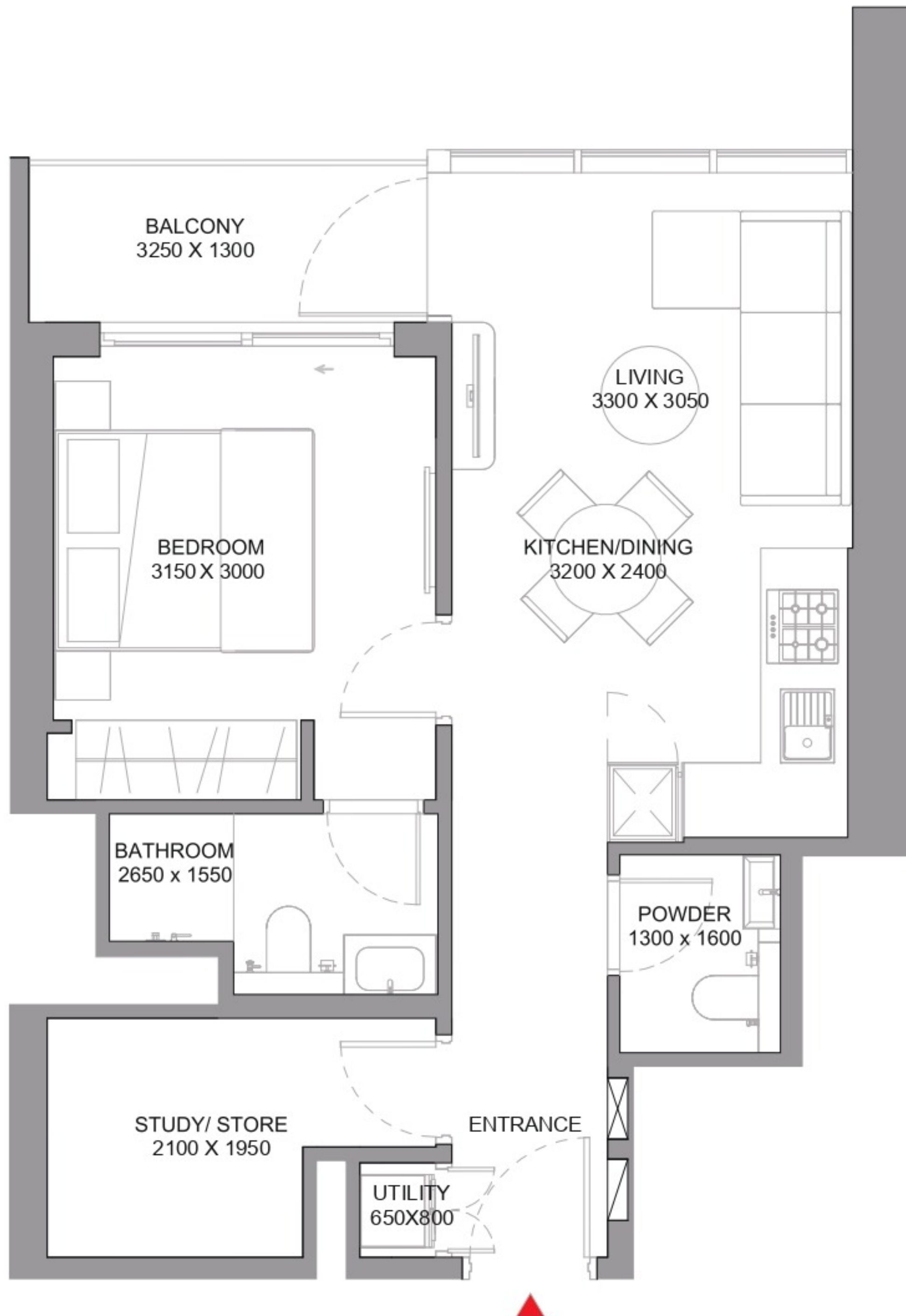

List of unit numbers with this unit plan:

VIEWS

Street View

A312, A412

Villa Community, Golf Course

A512, A612, A712, A812, A912, A1012, A1112, A1212, A1312, A1412, A1512, A1612, A1712, A1812, A1912, A2012, A2112, A2212, A2312, A2412, A2512, A2612, A2712, A2812, A2912, A3012, A3112, A3212, A3312, A3412

Disclaimer: 1. All dimensions are in metric, measured to wall finishes. 2. All materials, dimensions & drawings are approximate. 3. Information is subject to change without notice, at developer's absolute discretion. 4. Actual area may vary from the stated area. 5. Drawing are not to scale. 6. All images used are for illustrative purpose only and do not represent the actual size, features, specifications, fittings and furnishings. 7. The developer reserves the right to make revisions/ alterations, at its absolute discretion, without any liability whatsoever.

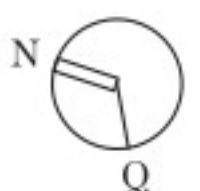

2 BEDROOM APARTMENT

TYPE A (with external shared powder + balcony)

TOTAL SALEABLE AREA

SUITE = 906.32 SQ.FT.
BALCONY = 78.15 SQ.FT.
TOTAL = 984.47 SQ.FT.

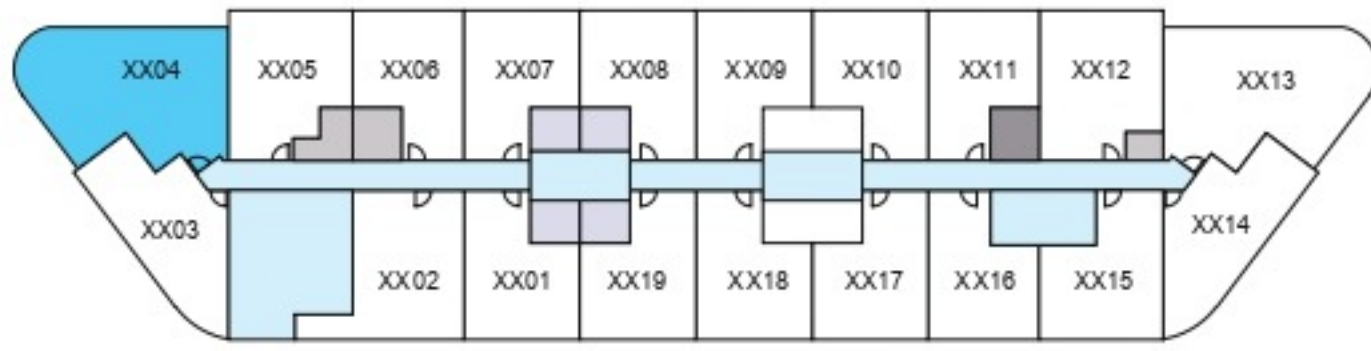

LEVEL - 03 - 21

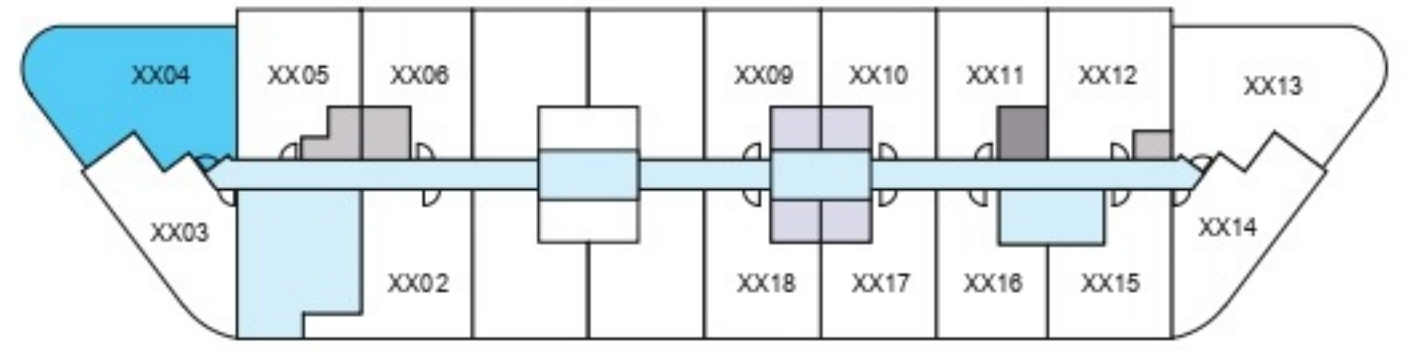
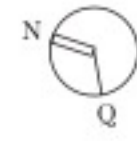

LEVEL - 22 - 32

■ UNIT

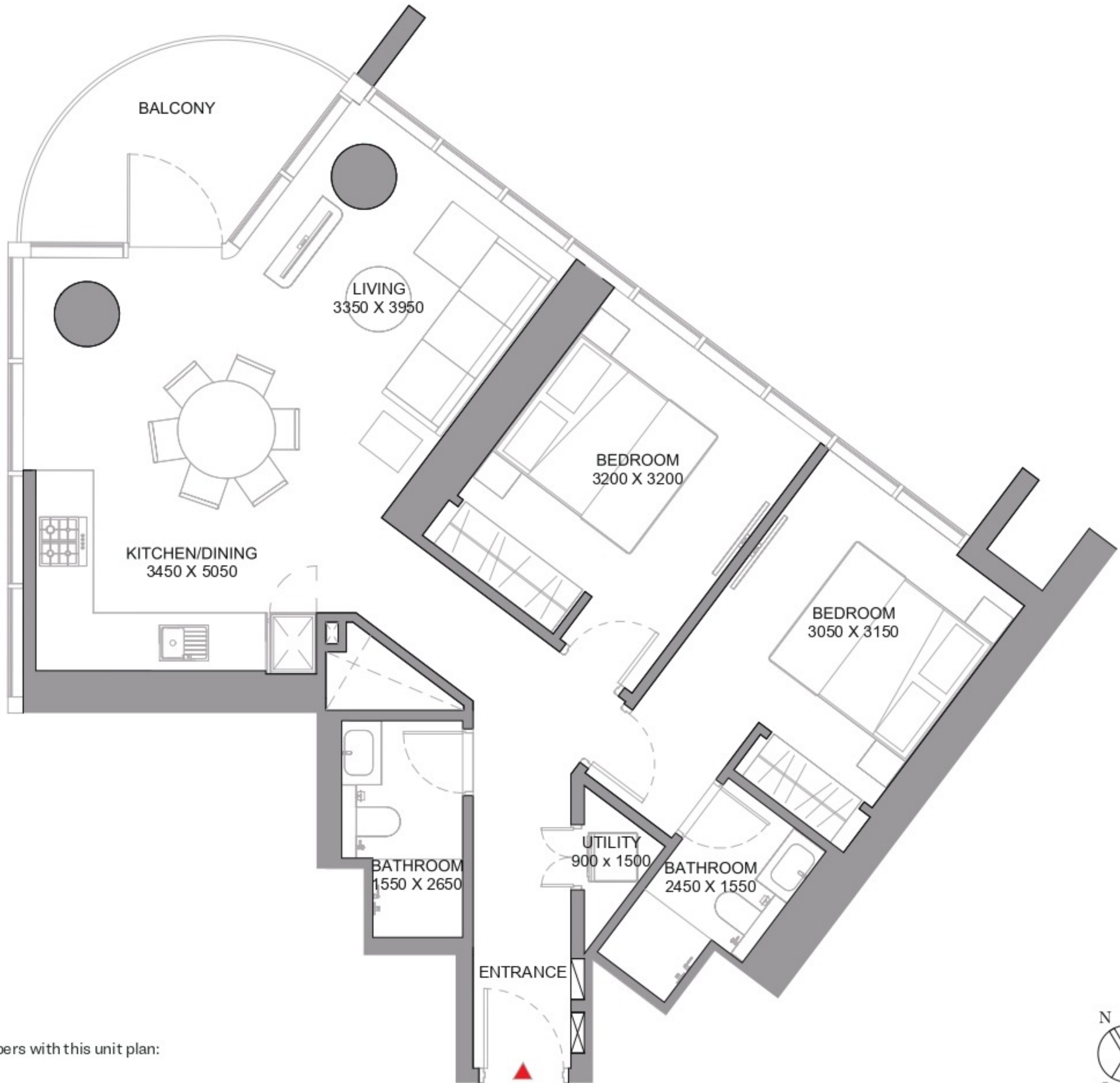

List of unit numbers with this unit plan:

VIEWS

Street View
A304, A404

180 degree views (City View, Miracle Garden, Villa Community, Golf Course)

A504, A604, A704, A804, A904, A1004, A1104, A1204, A1304, A1404, A1504, A1604, A1704, A1804, A1904, A2004, A2104, A2204, A2304, A2404, A2504, A2604, A2704, A2804, A2904, A3004, A3104, A3204

Disclaimer: 1. All dimensions are in metric, measured to wall finishes. 2. All materials, dimensions & drawings are approximate. 3. Information is subject to change without notice, at developer's absolute discretion. 4. Actual area may vary from the stated area. 5. Drawing are not to scale. 6. All images used are for illustrative purpose only and do not represent the actual size, features, specifications, fittings and furnishings. 7. The developer reserves the right to make revisions/ alterations, at its absolute discretion, without any liability whatsoever.

2 BEDROOM APARTMENT

TYPE B (with external shared powder + balcony)

TOTAL SALEABLE AREA

SUITE = 910.41 SQ.FT.
BALCONY = 78.04 SQ.FT.
TOTAL = 988.45 SQ.FT.

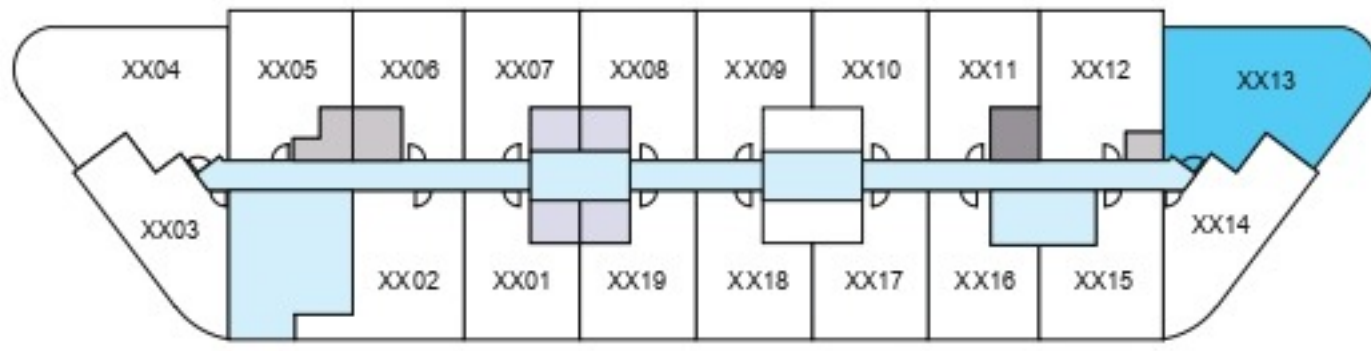

LEVEL - 03 - 21

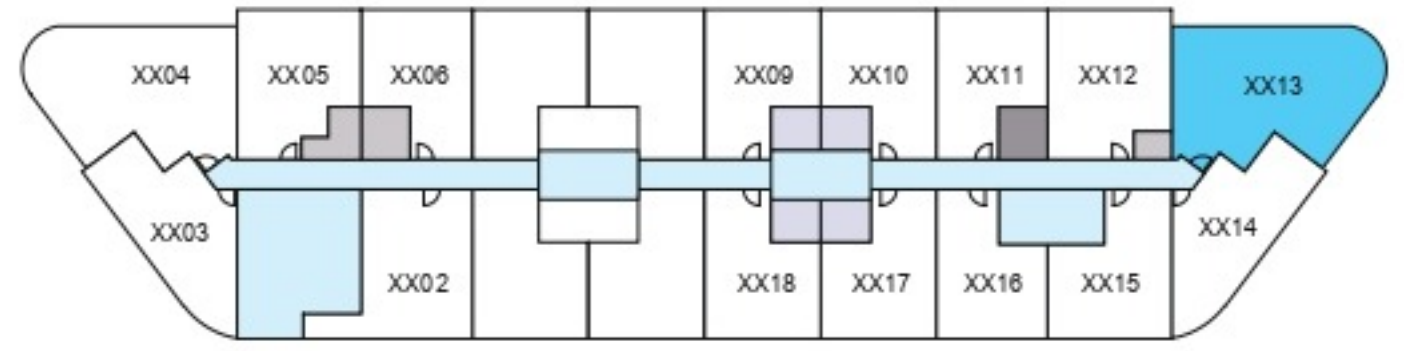
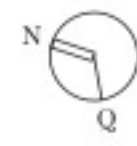

LEVEL - 22 - 32

■ UNIT

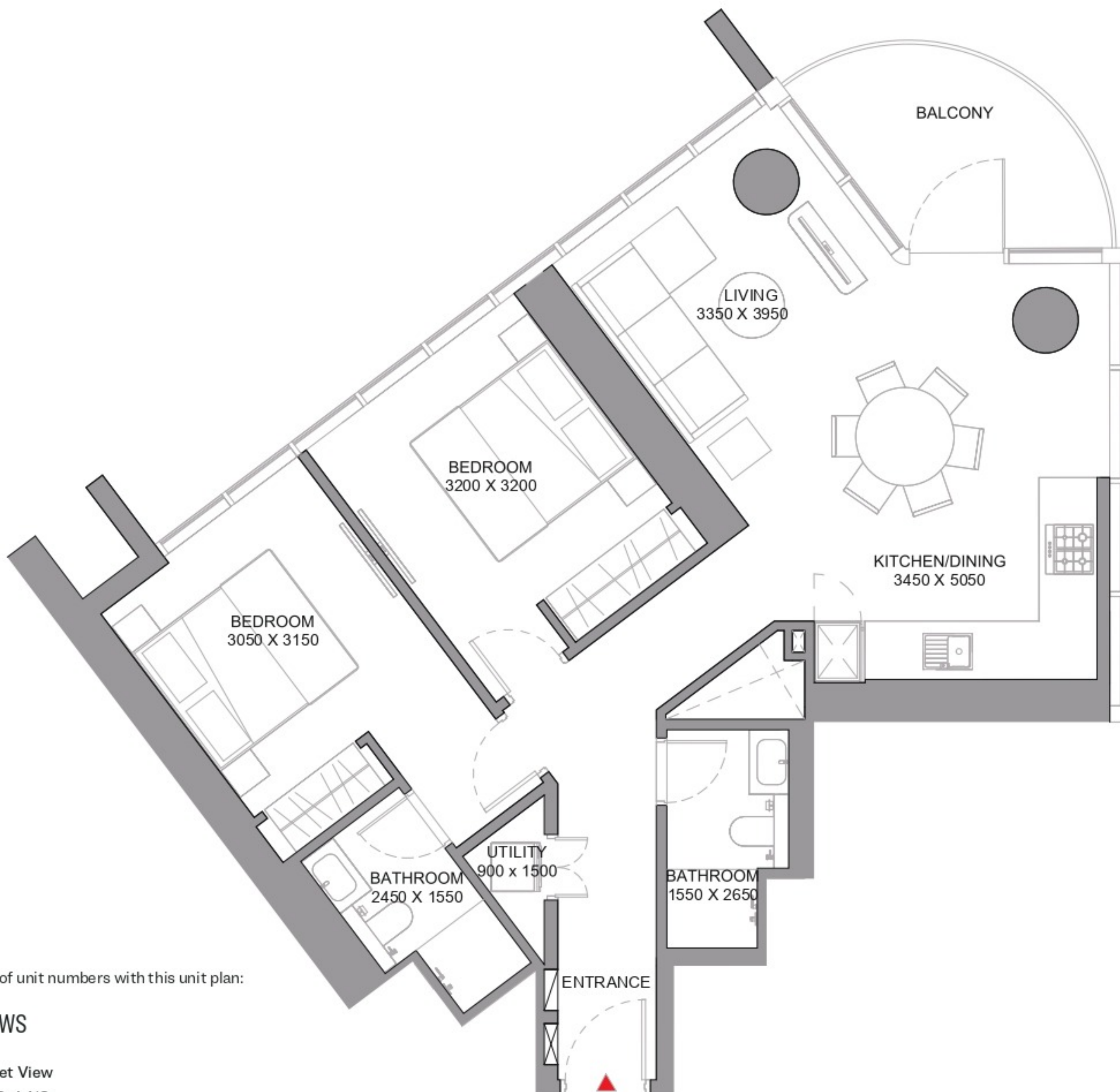

List of unit numbers with this unit plan:

VIEWS

Street View
A313, A413

180 degree views (Amenities, Community, Villa Community, Golf Course)

A513, A613, A713, A813, A913, A1013, A1113, A1213, A1313, A1413, A1513, A1613, A1713, A1813, A1913, A2013

180 degree views (Community, Villa Community, Golf Course)

A2113, A2213, A2313, A2413, A2513, A2613, A2713, A2813, A2913, A3013, A3113, A3213



Disclaimer: 1. All dimensions are in metric, measured to wall finishes. 2. All materials, dimensions & drawings are approximate. 3. Information is subject to change without notice, at developer's absolute discretion. 4. Actual area may vary from the stated area. 5. Drawing are not to scale. 6. All images used are for illustrative purpose only and do not represent the actual size, features, specifications, fittings and furnishings. 7. The developer reserves the right to make revisions/ alterations, at its absolute discretion, without any liability whatsoever.

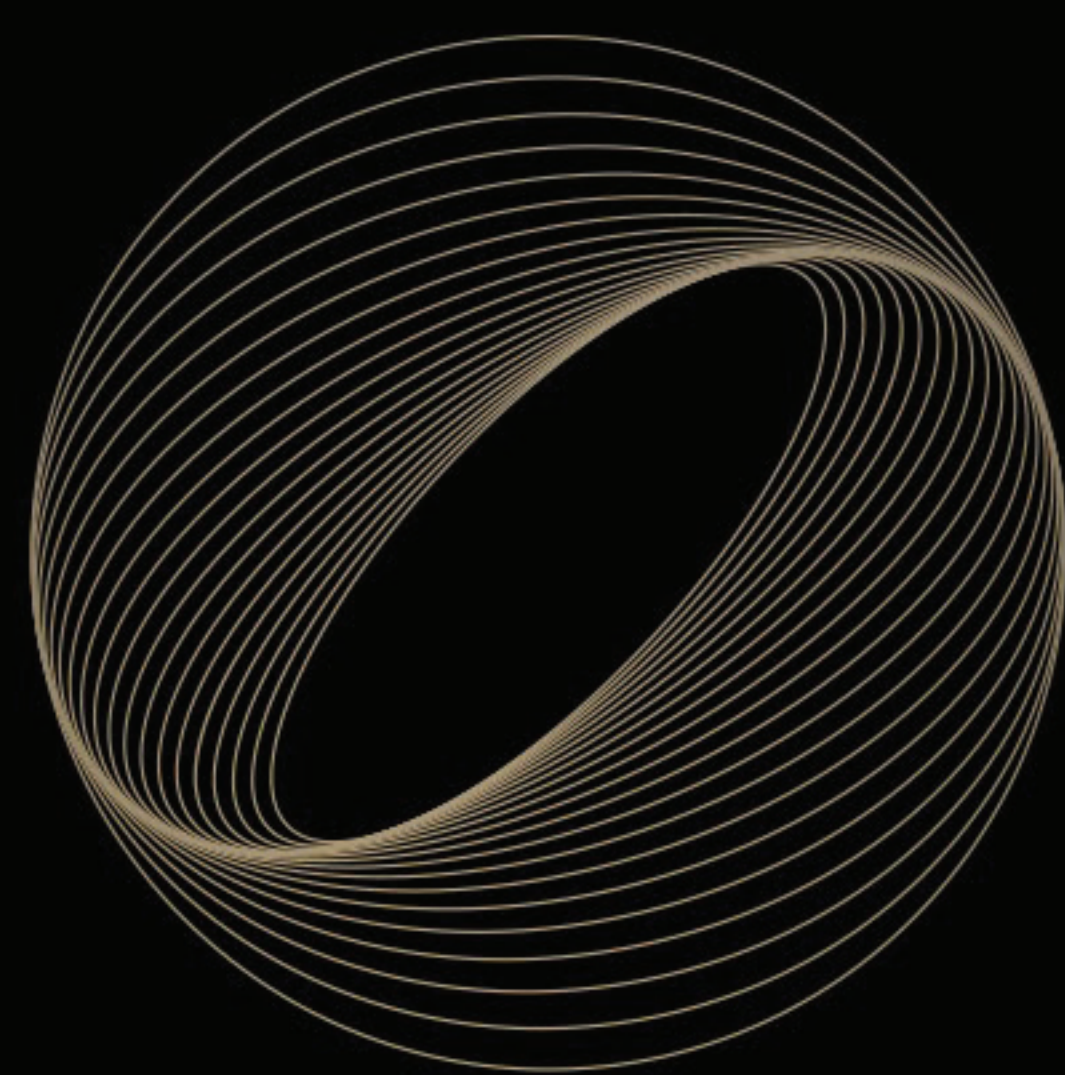

SOBHA
ORBIS

SOBHA
REALTY

