

Configuration guide

Avenue-Up
TV swivel mechanism
ruga.perissinotto &
Sciuto Architetti



Elements



Floor to ceiling support



Floor to wall support

Behind TV only

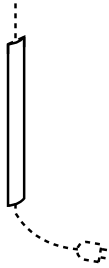

Cable duct

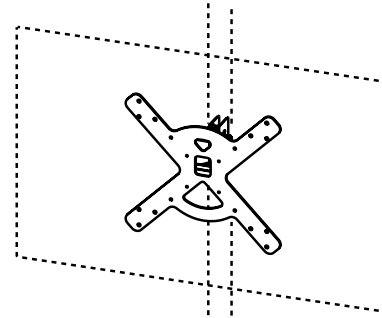

TV swivel mechanism

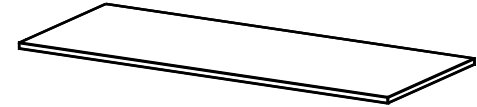

Shelf

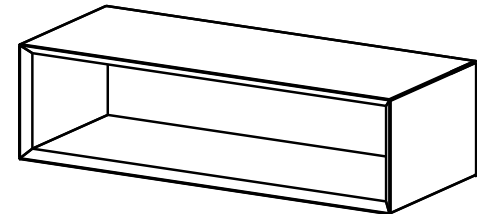

Units single/double sided
open 1 or 2 sides

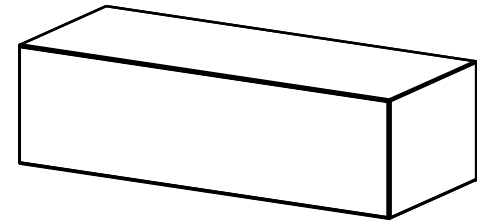

Units single/double sided

Finishes



Black, Bronze



Rovere naturale



Noce



Eucalipto



Rovere nero



Matt lacquer (30 colors)

TV cabling system

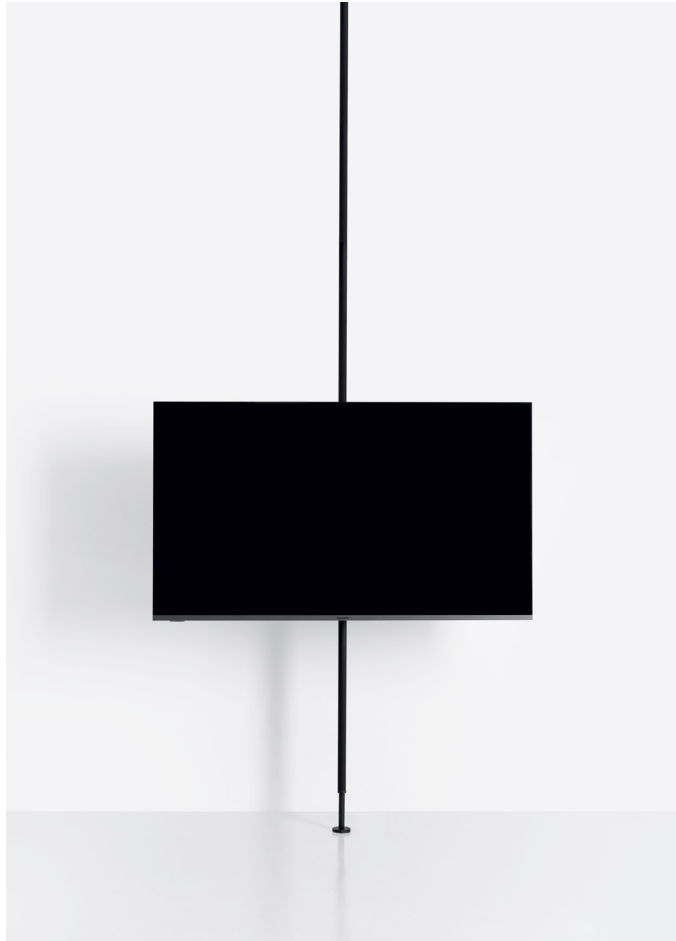

Floor to ceiling support



Floor to wall support



Images



Images



Composition examples

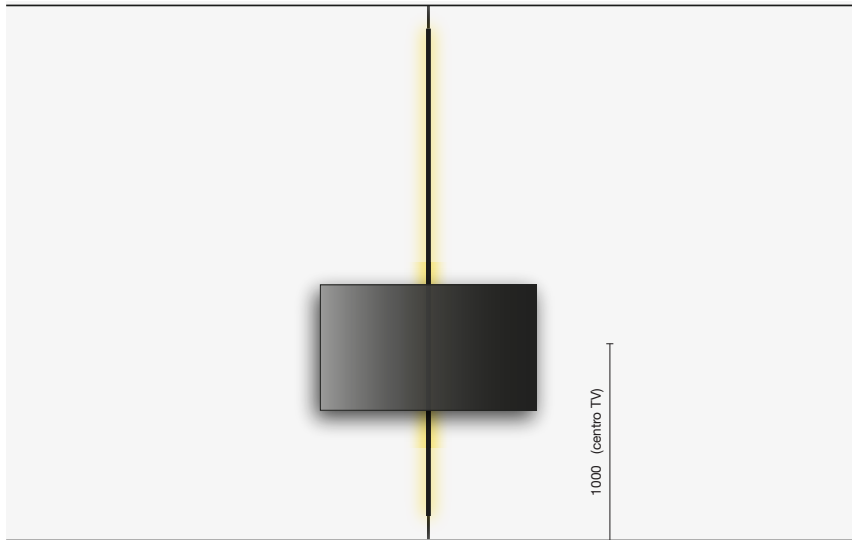

Composition 1

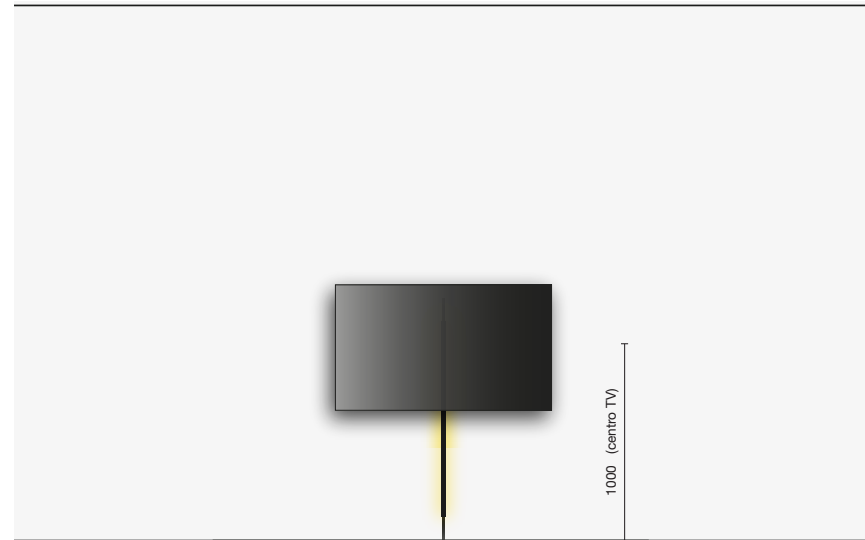

Composition 2

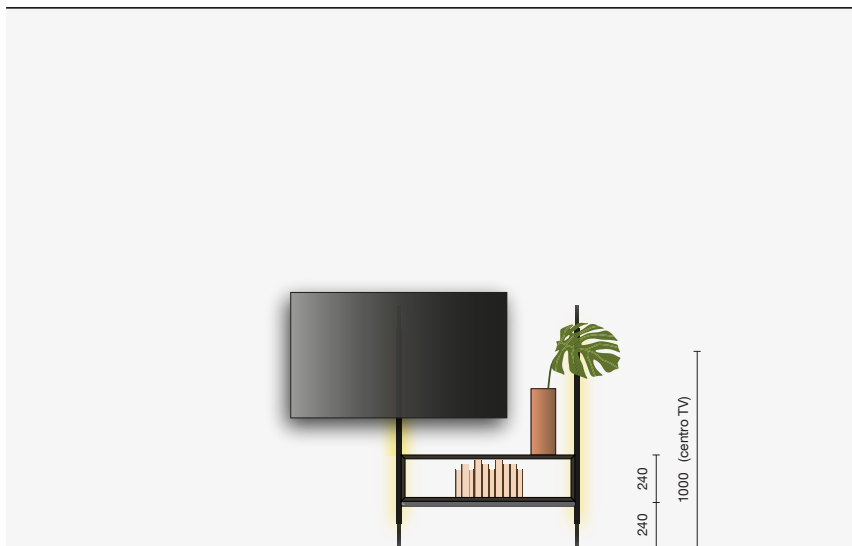

Composition 3 (rh/lh)

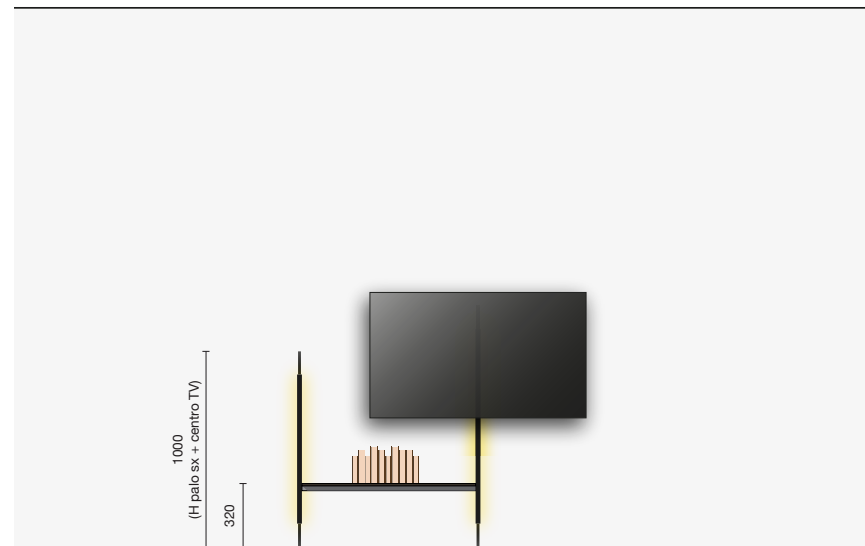

Composition 4 (rh/lh)

Composition examples

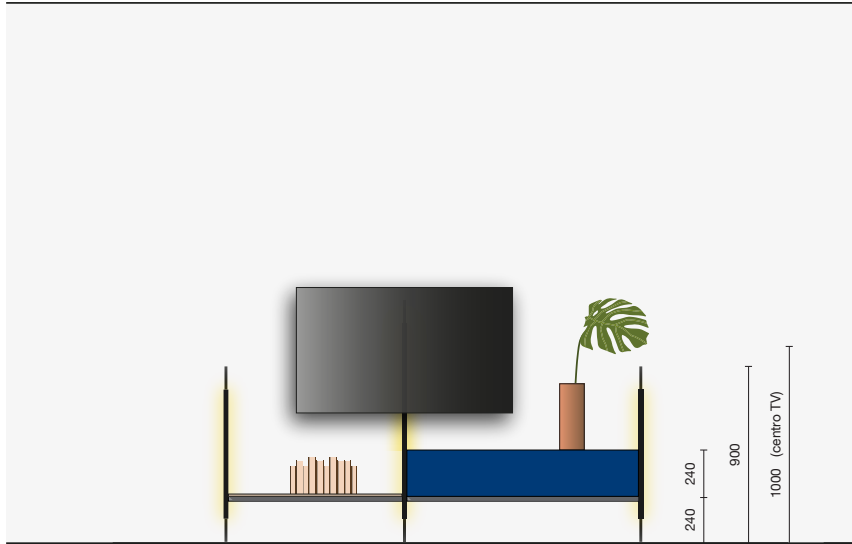

Composition 5 (rh/lh)

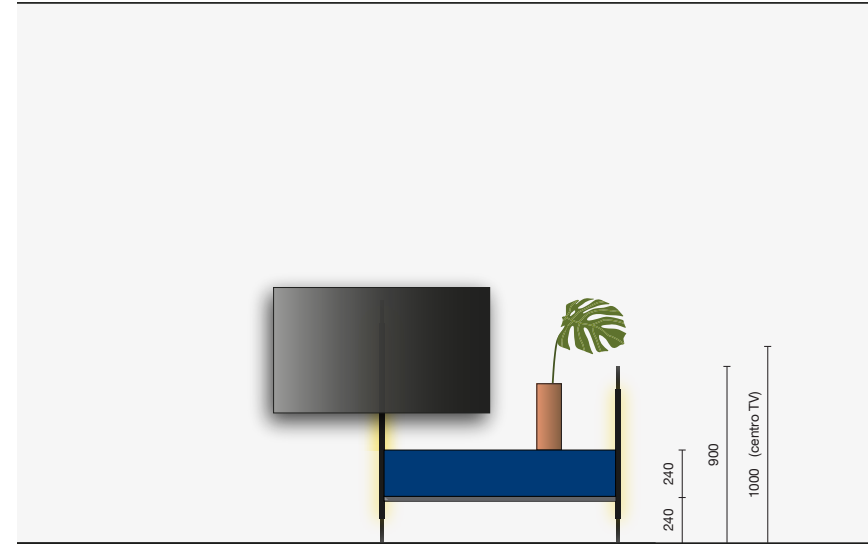

Composition 6 (rh/lh)

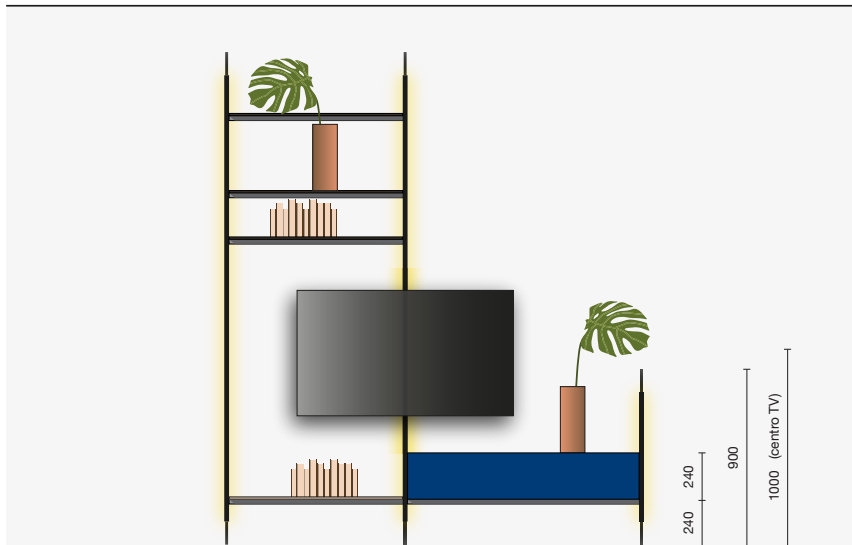

Composition 7 (rh/lh)

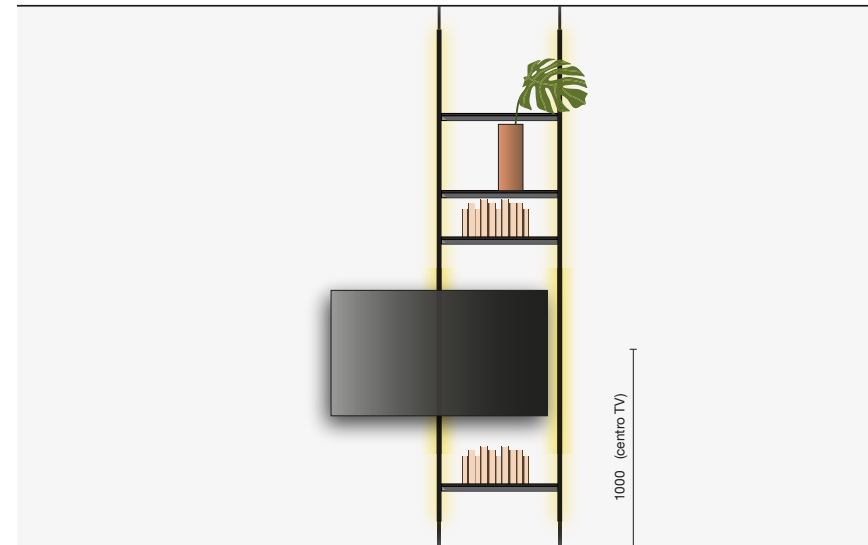

Composition 8 (rh/lh)