

Project Management

Project Management: Navigating the Complexity with a Systematic Approach



Abdullah Oguz, Ph.D.

Project Management

Project Management

Navigating the Complexity with a Systematic Approach

Abdullah Oguz

MSL Academic Endeavors
CLEVELAND, OHIO

Project Management by Abdullah Oguz is licensed under a [Creative Commons Attribution-NonCommercial 4.0 International License](https://creativecommons.org/licenses/by-nc/4.0/), except where otherwise noted.

Contents

Preface and Acknowledgements	xii
Interest/Adoption Form and Feedback/Report Form	xiv
Peer Reviewer Acknowledgements	xv
Chapter 1. Introduction to Project Management	16
1.0 Learning Objectives and Overview	17
1.1 Definition and Key Concepts of Project Management	18
1.2 Project Characteristics	20
1.3 Project Constraints	26
1.4 Project Success	29
1.5 Project Management Life Cycle and Process Groups	31
1.6 Project Management Knowledge Areas	34
1.7 Key Takeaways	35
1.8 Questions and Exercises	36
1.9 Attribution	37
Chapter 2. Strategy, Objectives, and Project Selection	38
2.0 Learning Objectives and Overview	39
2.1 Business Strategy and Goals	40
2.2 SMART Objectives	43
2.3 Business Case	48
2.4 Project Selection Process	51
2.5 Key Takeaways	59
2.6 Questions and Exercises	60
2.7 Attribution	61
Chapter 3. Project Initiation	62
3.0 Learning Objectives and Overview	63
3.1 Project Charter	64
3.2 Project Environment	72
3.3 Organizational Dimensions and the Structure	77
3.4 Project Management Office (PMO)	87
3.5 Key Takeaways	88
3.6 Questions and Exercises	89
3.7 Attribution	90
Chapter 4. Project Planning and the Project Scope	91
4.0 Learning Objectives and Overview	92
4.1 Project Planning	93
4.2 Eliciting Requirements	96
4.3 Requirements Traceability Matrix	102
4.4 Project Scope Management	104
4.5 Microsoft Project Tutorial	112
4.6 Key Takeaways	118

4.6 Questions and Exercises	119
4.8 Attribution	120
Chapter 5. Stakeholder Management	121
5.0 Learning Objectives and Overview	122
5.1 Identifying Stakeholders and Managing Their Expectations	123
5.2 Stakeholder Analysis	126
5.3 Managing and Monitoring Stakeholder Engagement	143
5.4 Key Takeaways	146
5.5 Questions and Exercises	147
5.6 Attribution	148
Chapter 6. Communication Management, Leadership, and Project Team Management	149
6.0 Learning Objective and Overview	150
6.1 Communications Management	151
6.2 Communication Types	154
6.3 Communications Management Protocol	156
6.4 Leadership Skills	157
6.5 Leadership Styles and Servant Leadership	166
6.6 Creating a Project Culture	168
6.7 Developing and Managing a Project Team	171
6.8 Key Takeaways	177
6.9 Questions and Exercises	179
6.10 Attribution	180
Chapter 7. Scheduling	181
7.0 Learning Objectives & Overview	182
7.1 Project Schedule Management Plan	183
7.2 Defining Activities	185
7.3 Estimating Activity Durations	189
7.4 Creating an Activity Network Diagram	194
7.5 Creating a Gantt Chart	207
7.6 Microsoft Project Tutorial	209
7.7 Key Takeaways	216
7.8 Questions and Exercises	217
7.9 Attribution	218
Chapter 8. Resource Management	219
8.0 Learning Objectives & Overview	220
8.1 Resource Management	221
8.2 Project Resource Management Plan	223
8.3 Estimating the Resources	226
8.4 Resource Allocation	227
8.5 Solving Resource Overallocation: Resource Leveling	231
8.6 Schedule Compression Techniques	233
8.7 Microsoft Project Tutorial	237

8.8 Key Takeaways	243
8.9 Questions and Exercises	244
8.10 Attribution	245
Chapter 9. Budget and Procurement	246
9.0 Learning Objectives and Overview	247
9.1 Project Costs	248
9.2 Project Cost Management Plan	251
9.3 Estimating Costs and Determining Budget	253
9.4 Establishing the Project Budget	259
9.5 Managing Project Costs	262
9.6 Project Procurement Management	263
9.7 Microsoft Project Tutorial	267
9.8 Key Takeaways	271
9.9 Questions and Exercises	272
9.10 Attribution	273
Chapter 10. Project Risks	274
10.0 Learning Objectives and Overview	275
10.1 Project Risk	276
10.2 Risk Management Plan	280
10.3 Identifying Risks	284
10.4 Risk Assessment	286
10.5 Developing and Implementing Risk Responses	290
10.6 Key Takeaways	294
10.7 Questions and Exercises	295
10.8 Attribution	296
Chapter 11. Monitoring and Controlling	297
11.0 Learning Objectives and Overview	298
11.1 Monitoring and Controlling Project Work	299
11.2 Qualitative Monitoring	305
11.3 Earned Value Management (EVM)	309
11.4 Change Control Process	315
11.5 MS Project Tutorial	318
11.6 Key Takeaways	326
11.7 Questions and Exercises	327
11.8 Attribution	328
Chapter 12. Agile (Adaptive) Project Management	329
12.0 Learning Objectives and Overview	330
12.1 Introduction to Agile	331
12.2 Adopting and Creating an Agile Environment	337
12.3 Common Agile Framework and Methods	345
12.4 Recent Trends in Agile Project Management	349
12.5 Key Takeaways	351

[12.6 Questions and Exercises](#) 352

[12.7 Attribution](#) 353

[Chapter 13. Closing the Project](#) 354

[13.0 Learning Objectives and Overview](#) 355

[13.1 Closing the Project](#) 356

[13.2 Activities to Close a Project](#) 359

[13.3 Post Implementation Reviews and Archiving Documents](#) 366

[13.4 Validating the Realization of Business Benefits](#) 371

[13.5 Key Takeaways](#) 372

[13.6 Questions and Exercises](#) 373

[13.7 Attribution](#) 374

[About the Author](#) 375

Preface and Acknowledgements

This book is just the beginning. It must be a dynamic process considering the fast pace of the modern world and evolving project management practices accordingly. Therefore, students and anyone who is interested in learning the basics of project management can benefit from this book not only now, but in the upcoming years. I welcome my colleagues and students who are willing to work with me to improve the book and provide students with an affordable solution in the long run. Of course, one textbook is not enough to learn about project management. Nevertheless, I am hoping that this textbook would be a salient resource that everyone can benefit from.

In this book, I wanted to demonstrate how project managers and teams can use project management software to facilitate their work. You can find tutorials of Microsoft Project, a popular project management software program utilized worldwide by numerous project managers and teams, at the end of Chapter 4 (Project Planning), Chapter 7 (Scheduling), Chapter 8 (Resource Management), Chapter 9 (Budget and Procurement), and Chapter 11 (Monitoring and Controlling).

While writing this book, I benefited from the OER project management books published earlier. I would like to thank the authors and contributors for their great work. These works are:

1. [Project Management by Adrienne Watt](#). © [CC BY \(Attribution\)](#).
2. [Project Management from Simple to Complex](#). © [CC BY \(Attribution\)](#).
3. [Project Management by Florence Daddey](#). © [CC BY \(Attribution\)](#).
4. [Project Management Fundamentals by Shelly Morris](#). © [CC BY \(Attribution\)](#).
5. [Project Management by Merrie Barron and Andrew R. Barron](#). © [CC BY \(Attribution\)](#).

This book would not be possible without the support of Cleveland State University (CSU). I was introduced to the world of Open Educational Resources (OERs) in the summer of 2021 with the Textbook Affordability Summer Symposium. During this symposium, I understood that this was definitely the solution that I have been looking for to ensure that students and all learners can access good quality resources free of charge. So, I decided to apply for the Fall 2021 Textbook Affordability Grant. Approval of my application led to a long and tiring, but very exciting process. This book wouldn't have been possible without the greatest project team of Amanda Goodsett, the Librarian, and OER and Copyright Advisor, and Barbara Loomis, the Digital Scholarly Publications and Programs Administrator, both from Michael Schwartz Library of CSU. I am immensely grateful to Mandi and Barb for their assistance, suggestions, and infinite patience.

I also owe an enormous debt of gratitude to the anonymous reviewers who gave me detailed and constructive comments on all the chapters.

Interest/Adoption Form and Feedback/Report Form

Interest/Adoption Form

For instructors: Please tell us a little bit about your class. If you are an instructor reviewing or selecting the text, please register [here](#). If you wish to report an error, please use the [Feedback/Report and Error Form](#).

Feedback/Report an Error Form

Please use the [Feedback/Report and Error Form](#) to provide feedback to the author of this open textbook Project Management. Your contact information is optional. If you are an instructor reviewing or selecting the text, please register at [here](#).

Peer Reviewer Acknowledgements

Every chapter of this text was blind peer reviewed by at least one and usually two peer reviewers prior to publication. The author and publisher of Project Management would like to thank the following Peer Reviewers for their input.

- Sharen Bakke, Senior College Lecturer, Information Systems Department, Cleveland State University
- Ike Ehie, Professor and CBA Faculty Fellow, College of Business, Kansas State University
- Lavognon Ika, Professor of Project Management, Telfer School of Management, University of Ottawa
- Simon Ringsmuth, Teaching and Learning Librarian, Oklahoma State University

Chapter 1. Introduction to Project Management

1.0 Learning Objectives and Overview

Learning Objectives

1. Define projects and explain the characteristics of the projects.
2. Explain two main project characteristics (uniqueness and being temporary) that distinguish projects from operations and processes.
3. Identify primary project constraints.
4. Explain why projects cannot be successful all the time.
5. Elaborate on the project management life cycle, the process groups, and knowledge areas.

Overview

This chapter's primary objective is to list and explain the key concepts related to project management and describe important benefits related to projects as well as the formal study of project management. This chapter provides an overview of project management, defining both projects and project management and exploring the difference between project management and operations management. Technological innovations and disruptions, and constantly changing social and economic conditions locally and all across the world impose new burdens on the organizations to shorten the time needed to develop and deliver new products and services that would increase organizations' competitive advantage. Therefore, many organizations have become more aware of adopting a systematic project management approach that can drive the change they desire (see Chapter 12). This chapter also provides the concepts of project life cycle, project management process groups, and project management knowledge areas according to the PMBOK Guide 6th Edition.

1.1 Definition and Key Concepts of Project Management

Projects are defined by PMBOK Guide 6th and 7th editions as “a temporary endeavor undertaken to create a unique product, service, or result”. These two characteristics will be detailed in the following section “Project Characteristics”. Besides, key project management concepts, which are constraints, key success factors, project life cycle, project process groups, and knowledge areas, will be delineated.

All of us are engaged in projects on a regular basis in our daily lives, and we use the term “project” frequently in our daily conversations. Although it had not been put forward in an organized way, people have been undertaking projects since the earliest days of organized human activity when our prehistoric ancestors had hunting parties. Large complex undertakings such as the seven wonders of the world including the only surviving artifact, the pyramids of Giza, were also projects. Even something as simple as creating a dinner or picking up your daughter from school can be considered a project. Renovating our house’s garage, planning a Disney vacation for kids, getting married, and achieving a degree, diploma or certificate are all projects as well. One of the common and most utilized project software programs, Microsoft Project Professional 2019, provides a “Wedding Planner” template.

Examples of some projects and their outcomes can be given as planning and executing the summer and winter Olympic games, building the Great Wall of China, developing the COVID-19 vaccine, constructing the Chernobyl New Safe Confinement, preparation, and publication of a journal or a project management textbook, building the Suez Canal, development of a commercial jet airplane such as Airbus A380 and Boeing 787, developing or modifying software packages, and successfully launching the Hubble Space Telescope. Besides these far-famed projects, Project Management Institute’s (PMI) web pages on “PMI Project of the Year Award” and “Most Influential Projects” would be very helpful to be familiar with some of the recent ongoing or successful, and influential projects implemented all across the world.

Organizations of all shapes and sizes continue to transform the ways they innovate and deliver to continuously improve customer satisfaction levels. If an organization wants to increase its revenue and profit, gain more market share, increase the number of loyal customers, and ultimately obtain a stronghold in its market, it needs to plan and execute projects that will lead to and drive change rather than just performing and relying on routine daily tasks. If we have a grocery market, selling the same products every day to the customers would help us maintain the profits at a level we can survive. However, consider that there is another grocery market started to operate in our neighborhood. Besides traditional in-person shopping, we all witness a significant surge in electronic commerce websites’ product portfolio and sales (e.g., web-based businesses such as Amazon and AliExpress, click and mortar businesses such as Walmart and Target). Together, both factors, a grocery market in the

neighborhood and e-commerce websites, could lead to a downward trend in sales and profit for our grocery market. Thus, even to protect our current position, we may have to come up with new ideas that have not been implemented by us before. We can add new brands to our shelves, offer new product lines, expand the store to accommodate more products, offer promotions to attract more customers, create social media and YouTube videos, launch a new e-commerce website, or establish a partnership with food delivery companies such as Grubhub and Uber eats. All of these ideas require preparing a business case to evaluate the feasibility of these ideas. If we decide to proceed with this idea, we can initiate a project to generate outcomes that would produce tangible and intangible benefits for our grocery market. Disruption is the new normal, but when an organization introduces change, it must be done correctly. Succeeding in such turbulent times means organizations cannot afford to waste precious resources on failed projects. This is the primary reason why many organizations recognize tools, techniques, and processes associated with project management, and implement a systematic project management approach relying on best practices and lessons learned.

<https://www.pmi.org/about/awards/professional/project-of-the-year>

<https://www.pmi.org/most-influential-projects>

1.2 Project Characteristics

PMBOK Guides define a project as a temporary endeavor undertaken to create a unique product, service, or result. The starting point in discussing how projects should be properly managed involves evaluating how we identify a project and understanding how we differentiate it from daily operations, and hence, clearly outline which tasks cannot be defined as a project. Therefore, it is of high importance to distinguish between a project and a process (or an operation that is a routine task repeated regularly).

A project has two primary attributes that distinguish it from ongoing and routine works that are business operations. They can be listed as below:

1. Projects and their outcomes are unique.
2. Projects are temporary, that is, they have a definite beginning and ending date.

Projects are completed when the project goals are achieved or it's determined that the project is no longer viable. Eventually, a successful project meets or exceeds the expectations of the stakeholders.

In the following subsections, let us discuss these two distinctive characteristics.

Unique outcome

Projects produce unique products, services, or results. Projects exist to bring about a product, service, process, or outcome that hasn't existed or been used before by the implementing organization or beneficiaries. While some projects are based on previous projects that were carried out in a similar fashion, each project is unique and begins with a business case and project charter. Constructing a replica of a building should be also considered a project although the same architectural blueprints are used. Although containing repetitive elements, this new construction work requires conceptualization and planning. A project manager is assigned to that project, who creates, develops, and manages a new project team and prepares detailed planning for the project constraints such as scope, schedule, budget, resources, risks, and quality. That building may be constructed in the same area (even next to the existing building) or another city, state, or country. Naturally, construction at other locations could necessitate substantial customization (tailoring) taking into account the internal influencers as well as external influencers such as weather, legislative regulations, and supply chain factors in new locations.

Projects can involve developing and producing a new deliverable. Besides, in many cases, they may address improving and modifying an existing deliverable. Examples of projects can be listed as below:

1. Modification of an ERP (Enterprise Resource Planning) system by revising the current modules

- and adding new modules,
2. Installing new safety features to a vehicle (e.g., new airbags, traction systems, accident prevention systems),
 3. Remodeling a building or a parking lot,
 4. Renovating the power lines all across a city or state,
 5. Reorganizing the workflow in a workplace such as a restaurant, grocery market, local motor vehicles bureau, and a library,
 6. Creating a designated area for self-checkout kiosks in markets,
 7. Creating a new TV, YouTube, or social media advertisement for a hand sanitizer.

Each project requires a unique approach based on the objectives to be achieved, the complexity and/or the size of the work required, the number, interests, and powers of stakeholders involved, and the clarity of the solutions being pursued. Those skilled in the art and science of project management can tailor the use of tools, techniques, and processes to maximize the value delivered to and by the organizations.

When the project deliverables are inspected and accepted by the client (i.e., customer or product owner), and the project is closed, the project manager can hand over the deliverables to the operational units which can be either internal or external clients. For example, if the project's objective was to create a new payroll information system in an organization, the system is delivered to the IT department and/or the payroll department of the organization. From there, these functional departments can utilize and maintain the system. The payroll department can pay the employees' salaries every month based on the inputs entered into the system. Paying salaries to these employees regularly becomes an operation (a routine task). Thus, the organization can gain benefits from the new system since payrolls are computed properly with minimum acceptable errors and by avoiding human errors. However, whenever there is a new need to modify the system or purchase a new one, this should be treated as a new project, which will require the establishment of a new project team and the assignment of a project manager. Therefore, this leads us to the second characteristic of a project, which is its temporary nature.

Temporary Nature

The second characteristic that distinguishes a project from an ongoing work is its temporary nature. Projects are not an everyday business process and have a definite beginning date and an end date. A project is assigned a schedule with a certain completion date because the ultimate objective of a project is to benefit from its deliverables. Therefore, a significant portion of project effort is dedicated to ensuring that the project is completed at the appointed time. To do this, schedules are created to explicitly indicate when tasks should begin and end. Activity network diagrams and Gantt charts help determine, visualize, and monitor the schedule of the whole project and the interdependence among project activities. Projects can last minutes, hours, days, weeks, months, or years.

In contrast with projects, operations are ongoing and repetitive. They involve work that is continuous without an ending date wherein the same processes are repeated to produce the same results. The

purpose of operations is to keep the organization functioning while the purpose of a project is to meet its strategic goals and create a change in the organization to acquire new or additional tangible or intangible benefits that cannot be acquired by conducting daily operations. Projects aim at moving an organization from a current state to a future desired state where the organization could find the opportunity to move forward and improve its financial and market conditions.

To illustrate this, consider a hypothetical automaker that operates on a global scale. Designing a new SUV and its components based on a strategic objective, creating prototypes, and conducting crash and safety tests require a systematic project management approach. After delivering the final product, this SUV can be placed into the assembly line in a factory. Whenever all the parts are assembled in this manufacturing facility by workers, robotic arms, and machinery, and hundreds of vehicles are manufactured on a daily, weekly, or monthly basis, this process becomes an operation. Ordering raw materials and vehicle parts to create many vehicles in the factory constitutes the operational process which also consists of the transactions occurring along the supply chain on an ongoing basis. As long as consumers demand this vehicle model and it is profitable for the company to manufacture and sell it, the company can continue manufacturing it. All these repetitive and routine manufacturing processes can be considered an operation. However, when there is a need to change some features of the vehicle (e.g., adding new airbags, modifying some engine components), the company would need to start a new project.

A project is completed when its goals are accomplished, and its deliverables are approved by the client. Sometimes projects end when it is determined that the goals and objectives cannot be accomplished or when the project outcome is no longer needed. Serious schedule delays or a need to increase the budget substantially might cause the project sponsor to consider cancellation. Some reasons to terminate the projects earlier than their scheduled completion time can be listed as follows:

1. Funding is exhausted or no longer available,
2. Resources (human or physical resources, or services) are no longer available,
3. The external client (funder) or the current or potential customers no longer wants the project completed,
4. The organization changed its strategy or determined a new priority,
5. Management decided to end the project, and
6. A legal cause or a new regulation necessitated the project to end.

It is not uncommon to terminate a project earlier than its completion time without achieving its goals and carrying out all the activities. Nevertheless, these unsuccessful projects are still considered as projects.

Case Study 1.1: Characteristics of a Project Undertaken by Grocery LLC

The uniqueness of a project and its temporary nature would help a business or organization to assess if it has a project, and hence, would need to implement a systematic project management approach and form a project team.

Consider a scenario that our organization is a grocery chain (Grocery LLC) with fifty branches across five states. During the weekends, and between 4 pm and 7 pm during the week, these branches, in general, experience more than usual traffic of customers. Therefore, long lines form in front of the current check-out stations where the cashiers work. Sometimes, it is not possible to assign an adequate number of cashiers to all the existing stations because of the lack of personnel. The chief operations officer (COO) of Grocery LLC visited CEO's office several times to discuss potential solutions to this problem. With the help of her operations team, she prepared a business case with several solutions. During the preparation of the business case, in order to elicit the business, stakeholder, and solution requirements of these solutions, the team sent paper and e-mail surveys to all the branches to understand managers' and employees' expectations and interviewed ten managers, ten supervisors, and thirty employees who volunteered for follow-up and further examination. Furthermore, two hundred customers who volunteered and were given a \$20 gift card to spend at the grocery market were interviewed when they visited these branches to do their shopping during the busy hours. The team also visited other grocery chains' markets which are the main competitors of Grocery LLC to observe their daily operations. The team also collaborated with a market research consultancy company for further analysis and to receive expert judgment. Among several options, the candidate solution with the highest priority was identified as the establishment of self-checkout areas in all the branches. This solution was discussed in the project selection committee meeting at which our organization's CFO, CTO, and senior representatives from three departments (R&D, procurement, and human resources) are the members. Based on pre-determined criteria and the weights that our organization uses for all the projects (see Chapter 2, Table 2.5), this solution was selected to proceed with as a project. The committee decided to organize the project as a program and to assign 5 project managers who are responsible for ten branches each. Grocery LLC wanted to start the project in January 2022 and finish all the works by August 2022. Once self-checkout areas are built and inspected to verify if they can be utilized to the full capacity with all the requirements met, customers will be able to check out their items themselves without the presence of cashiers, and, hence they can avoid crowded lines.

Based on this case study, we should ask, first off, if this can be considered a project. Projects are temporary, and hence have a definite start date and an end date. They result in the creation of a unique product, service, process, or outcome, and are completed when their goals and objectives have been met (or the objectives cannot be met, and accordingly they are terminated early) and finally signed off by the project sponsor and the clients (funder).

Using these criteria, let's examine if the establishment of self-checkout areas in all branches is a project:

- Is it unique?

Yes, because the self-checkout kiosks don't exist in this grocery chain. The outcome of this project offers a new way of service to the customers which would increase the speed of checkouts and reduce the lines at traditional checkout stations. The main purpose of this project is to provide faster service to the customers during busy hours. For each branch, a new design and implementation can be required due to the different layouts and sizes, and according to varying demands of the local customers.

Therefore, it is also a unique endeavor for each branch.

- Is this a temporary endeavor? Is there a way to determine when the project is completed?

Yes, the project starts in January 2022 and ends in August 2022. When the kiosks are installed and the self-checkout service is offered to the customers at each branch, we can close the project and disband the project teams. Then, this will become an operation that is carried out every day.

Besides these two characteristics, we should also ask another question that is related to the constraints of a project.

- Is there a way to determine stakeholder satisfaction?

Yes, the expectations of the stakeholders will be documented in the form of requirements while preparing a needs assessment, business case, and a benefits realization plan before a project start, and during the initiation and planning processes. These requirements will be compared to the finished product to determine if the self-checkout stations could satisfy the expectations of stakeholders, primarily market employees and customers.

Case Study 1.2: Characteristics of Another Project Undertaken by Grocery LLC (M-Commerce Project)

Consider a new scenario for Grocery LLC. Physical sales have declined since the onset of the COVID-19 pandemic all across the world. Customers prefer buying online instead of visiting a store in person since they have serious concerns to contract Covid-19. Our fifty stores in five states lost around 30% of regular customers, and the revenue declined by 25% since the start of the pandemic restrictions in March 2020. Considering the pessimistic trends forecasted regarding the pandemic as well as the increasing digitalization of companies and consumers, the project selection committee decided to have a better online presence by creating a mobile app and optimizing the website for mobile devices. Therefore, our current customers who purchase goods and services from our grocery stores, as well as potential customers, will have the opportunity to purchase through their computers and smartphones. So, our team was asked to elicit the requirements by communicating with the key stakeholders such as grocery managers and employees, and customers. It was planned to start this project on May 2, 2022, and finish on October 27, 2022.

Let's evaluate this project in terms of uniqueness and temporary nature.

- Is it unique?

Yes, because the grocery chain diversifies its sales channels by strengthening its online presence through optimizing its website for mobile devices and creating a new mobile application. The outcome of this project offers a new way of service to the customers.

- Is this a temporary endeavor? Is there a way to determine when the project is completed?

Yes, the project starts on May 2, 2022, and finishes on October 27, 2022. When the mobile app is ready for the customers to install on their smartphones, and customers can view the website on their mobile devices, we can perform administrative and financial tasks to close the project, and we can disband the project team. Then, this becomes a routine task for the operational units to maintain and support the website and mobile app.

- Is there a way to determine stakeholder satisfaction?

Yes, the expectations of the stakeholders will be documented in the form of requirements while preparing a business case, and during the initiation and planning processes. The requirements for a mobile app and optimized mobile website will be compared to the finished products to determine if they satisfy the expectations of stakeholders.

1.3 Project Constraints

Projects do not live in a vacuum. They are affected by many factors including constraints, assumptions, and internal and external factors (referred to as Enterprise Environmental Factors - EEFs by PMBOK Guide 6th Edition). Three main constraints (i.e., triple or iron triangle constraints) are scope, schedule, and cost, and they are considered the main pillars of a project. They are also regarded as the main reason why we need a systematic project management approach. These primary constraints also compete with each other. Therefore, project managers should consider trade-offs among them. For example, increasing the project scope may require a revision of the schedule and budget. In many cases, expanding the project scope with more product specifications and project activities would result in a longer schedule and higher budget. This trade-off will be discussed in the following sections, and mostly in their respective chapters. Maintaining the balance among these constraints is difficult because projects are prone to change. Thus, the technical and interpersonal skills of project managers, and how they utilize the best and proven practices of project management, and the quality of a project team are essential prerequisites of conducting an effective project.

Besides triple constraints, the other three constraints which are also tightly linked to the triple constraints are resources, quality, and risks. Tightly aligned with and at the top of all these six constraints, the success of a project depends on the client and/or stakeholder satisfaction. Clients make their decisions to accept the final deliverables of a project by evaluating these constraints.

Scope

Project scope is the work performed to deliver a product, service, or result with the specified features and functions. Scope refers to what the project is trying to achieve. It entails all the work involved in delivering the project outcomes and the processes used to produce them. It reflects the purpose of the project. The difference between the project and product scopes will be detailed in Chapter 4 “Project Planning”.

A project is built upon the scope. After all the product or service requirements are elicited from all relevant stakeholders, observations, documents, and other sources, the project manager can start working on the project activities which will be carried out to meet these requirements. After product requirements and project activities are defined, and the activities are sequenced, the project manager and the team can proceed with the estimation of activity durations, allocation of resources, estimation of costs, and identification of risks, quality, and performance metrics.

Schedule

A schedule is a model for executing the project's activities, including durations, dependencies, and other planning information. Project scheduling provides a detailed plan that represents how and when the project will carry out all the activities that would lead to the delivery of the products, services, and results defined in the project scope. It serves as a tool for communication and collaboration with all the stakeholders and managing and monitoring their expectations. It also serves as a baseline for performance reporting. While monitoring the performance and progress of a project, a schedule is assessed commonly to identify problems (e.g., delays, missed deadlines, incomplete deliverables) in the project. After the project team defines the activities based on the product and project scopes, activity durations are estimated, activities are sequenced, their interdependences are outlined, and hence, the resources can be allocated to each activity. The project schedule should also consider national, federal, or local holidays and the absence of human resources due to vacations and other issues such as sickness and family issues. We will discuss scheduling in Chapter 7 "Scheduling".

Cost

Cost is the budget approved for the project including all necessary expenses needed to deliver the project. Within organizations, project managers have to balance between not running out of money and not underspending because many projects receive funds or grants that have contract clauses with a "use it or lose it" approach to project funds. Poorly executed budget plans can result in a last-minute rush to spend the allocated funds. For virtually all projects, the cost is ultimately a limiting constraint; few projects can go over budget without eventually requiring corrective action. We will cost management in Chapter 9 "Budget and Procurement".

Quality

Quality is a combination of the standards and criteria to which the project's products must be delivered for them to perform effectively. As quoted by the PMBOK Guide 6th Edition from ISO 9000 standards, "quality as a delivered performance or result is the degree to which a set of inherent characteristics fulfill requirements". The product must perform to provide the functionality expected, solve the identified problem, and deliver the benefit and value expected. It must also meet other performance requirements, or service levels, such as availability, reliability, and maintainability, and have acceptable finish and polish. We will discuss quality management in Chapter 11 "Monitoring and Controlling".

Resources

In order to carry out and complete project activities, the project manager should allocate various resources such as human resources for the project team and all other activities, physical resources (e.g., equipment, materials, facilities, software, testing environments, licenses, infrastructure, and supplies), and services (e.g., consulting and subcontractors). Resources can be determined and

allocated when the activities are defined and scheduled. Then, the budget for each activity can be computed based on the allocation of all resources. We will discuss resource management in Chapter 8 “Resource Management”.

Risks

A risk is an uncertain event or condition that, if occurs, has a positive or negative effect on one or more project objectives. Negative risks are called threats, and positive risks are called opportunities. Two main factors determine the severity of a risk: (1) Probability of the occurrence, and (2) impact on the project. Risk responses are planned based on the severity level. We will discuss individual and overall project risks and their management in Chapter 10 “Project Risks”.

Project Management Institute. (2017). A guide to the Project Management Body of Knowledge (PMBOK guide) (6th ed.). Project Management Institute.

Project Management Institute. (2021). A guide to the Project Management Body of Knowledge (PMBOK guide) (7th ed.). Project Management Institute.

Project Management Institute. (2017). A guide to the Project Management Body of Knowledge (PMBOK guide) (6th ed.). Project Management Institute.

Project Management Institute. (2021). A guide to the Project Management Body of Knowledge (PMBOK guide) (7th ed.). Project Management Institute.

1.4 Project Success

Project success and project management success are generally evaluated as different concepts. Project success deals with the impacts of a project's final product or service on stakeholders. Projects aim to create a unique outcome. Project management success focuses on the processes of a project including the successful accomplishment of the scope, within budget (cost), within time (schedule), and quality aspects. In our grocery chain example, we can close the project when the self-checkout areas are inspected by the inspection committee that is composed of the representatives of the operational unit which is responsible for all fifty markets, and also several store managers. The evaluation and acceptance are conducted by the inspection committee by comparing the requirements with the final deliverables, validating that all the requirements have been implemented, and the self-checkout stations are ready to use by the customers. The inspection committee checks all fifty branches to confirm if the requirements in the project scope were met, and quality standards are complied with. Let's assume that the project finished on time, and the budget was not exceeded. Therefore, we can consider this as a project management success. Eventually, we can close the project and disband the project teams.

After these self-checkout areas opened for the customers, we observed that most of the customers started to avoid these areas and continued to use checkout stations where cashiers and baggers are available even though customers waited in lines for more than ten minutes. This project was successfully managed but did not meet the client and customer expectations. Projects are initiated by organizations to address business needs (problems or opportunities) and create tangible and intangible benefits by creating an outcome that organizations can benefit from. Realized value of the project can be measured by the project stakeholders. However, our company couldn't gain the expected value. When the underlying reasons were investigated, it was found that lack of human contact was the main reason. Most of the customers, especially Generation X and baby boomers, still wanted to maintain an interaction with employees to ask for the warranties, the quality of the items, or even have a short chat with the cashiers and baggers. Since it was not a problem due to the technology but affected the solution significantly, the COO and her team decided to add some employees in these areas to help the customers. After changes were done, it was observed that more customers started using the self-checkout areas. However, the operational team decided to monitor the performance of these areas to take further actions if needed.

It is evident that not all projects benefit from successful completion. Many factors influence the success of a project. PMI 2020 Pulse of the Profession reported that 11.4% of investment is wasted due to poor project performance. What makes it worse is that this percentage spikes up to 67% in the organizations that undervalue project management as a strategic competency for driving change. PMI's same study reported that the factors responsible for the failure were lack of clearly defined and/or achievable milestones and objectives to measure progress (37%), poor communication (19%), lack of

communication by senior management (18%), employee resistance (14%), and insufficient funding (9%).

Another report by the Standish Group, "CHAOS 2020: Beyond Infinity", indicated that 31% of projects were successful while 50% were challenged and 19% failed. This report referred to three factors to improve project performance, that are good sponsor, good team, and good place.

Consequently, a project should be managed effectively by a project manager and the team. If not done so, projects may fail due to the factors listed below:

- Unrealistic and vague goals
- Uncontrolled expansion of the project scope (Scope creep)
- Absent or ineffective relations with the clients/customers and other stakeholders
- Cost overruns
- Schedule delays
- The insufficient amount and/or quality of resources
- Toxic organizational culture and politics (e.g., mistreatment, aggression, incivility, harassment)
- Organizational and/or team conflicts
- Poor communication with stakeholders
- Unsatisfied stakeholders
- Ineffective quality assurance and inspections, and/or poor quality

PMI (2020). Ahead of the Curve: Forging a Future-Focused Culture. Pulse of the Profession.

<https://www.pmi.org/learning/library/forging-future-focused-culture-11908>

<https://hennyportman.files.wordpress.com/2021/01/project-success-grc-standish-group-chaos-report-2020.jpg>

1.5 Project Management Life Cycle and Process Groups

Projects start their life by developing the project's foundations (i.e., primary objectives, high-level scope, schedule, budget and risks, project team composition), continue with planning all the knowledge areas, executing all the activities, and producing the outcomes (i.e., products, services, or processes), and end by reaching a close-out by archiving all the documents, completing all administrative works, and disbanding the team. This is the life cycle of a project, which makes it temporary and unique. This life cycle is composed of stages or phases which are generically named as starting (initiating, conceptualization), planning (organizing and preparing), implementing (executing, carrying out), and termination (close-out, ending) (Figure 1.1). These phases can also be named differently based on the industry, product scope, project complexity and size, needs of management, legal or regulatory requirements, decision points such as go/no-go decisions, and milestone review. For example, if the project aims to create an information system such as a payroll system, project life cycle stages can be named as feasibility study, elicitation of customer requirements, development of solutions, design, creating prototypes, coding, testing, transiting, commissioning, milestone review, lessons learned, administrative closure, and archiving.

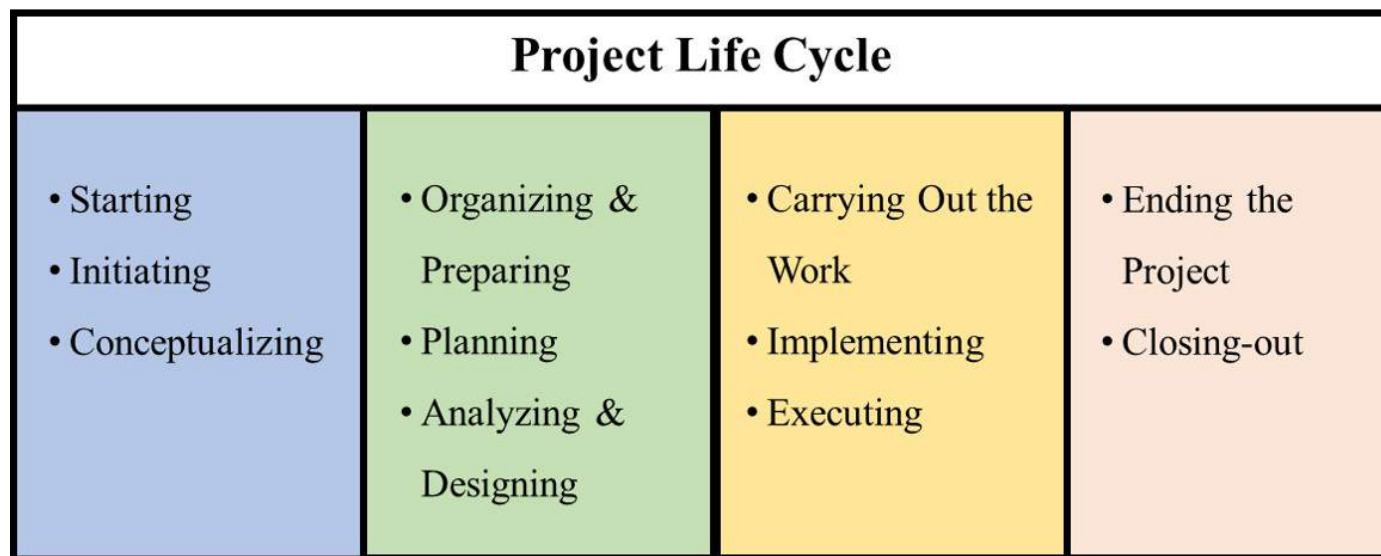

Figure 1.1 Project Life Cycle Phases

While project life cycle stages offer a step-by-step process to manage a project, practical issues require focusing on processes and their groups as described by the PMBOK Guide 6th Edition. The project life cycle is managed by executing a series of project management activities known as project management processes. These processes are prescriptive, which means that they explicate each process within an input-output diagram where various project management tools and techniques are utilized. Although

they are very helpful for project managers, PMBOK Guide 6th edition always emphasizes the tailoring of processes and techniques based on each project's own characteristics. This is why PMBOK Guide 7th Edition adopted a new approach through which the processes have been replaced by principles. Nevertheless, project managers can still benefit from the process-centered approach as processes provide a comprehensive guideline.

Each process makes use of inputs and produces outputs by using appropriate tools and techniques. These processes can be implemented globally across industries. For example, one of the processes, developing a project charter, is the starting point for all projects regardless of their industry, size, complexity, and location. This process uses business documents, agreements, enterprise environmental factors, and organizational process assets as inputs. It produces the outputs as a project charter and assumption log by utilizing tools and techniques such as expert judgment, data gathering, interpersonal and team skills, and meetings.

Different from project life cycle phases, but in line with them, these processes are grouped inside five project management process groups according to the PMBOK Guide 6th Edition. Names of these groups and their purposes are provided below:

1. Initiating

- To define a new project or a new phase of an existing project by obtaining authorization to start the project or phase.

1. Planning

- To establish the scope of the project, refine objectives, and define the course of action required to attain the objectives.

2. Executing

- To complete the work defined in the project management plan to satisfy the project requirements.

3. Monitoring and Controlling

- To track, review, and regulate the progress and performance of the project, to identify any areas in which changes to the plan are required, and to initiate the corresponding changes.

4. Closing

- To formally complete or close the project, phase, or contract.

An important factor that distinguishes these process groups from the life cycle stages is the addition of monitoring and controlling as a separate process group. Monitoring and controlling process group is

performed throughout the project as it is of high importance and necessity to ensure that the project is on the track, and to intervene in problems when detected. As seen in Figure 1.2, these process groups overlap with one another, and the sharp boundaries in the project life cycle disappear, which makes it more realistic. For instance, planning continues with lower levels of process interaction and effort while executing process group is conducted since plans and product requirements are subject to changes due to the factors such as changes in stakeholder requirements, dynamic market conditions, and technological advancements.

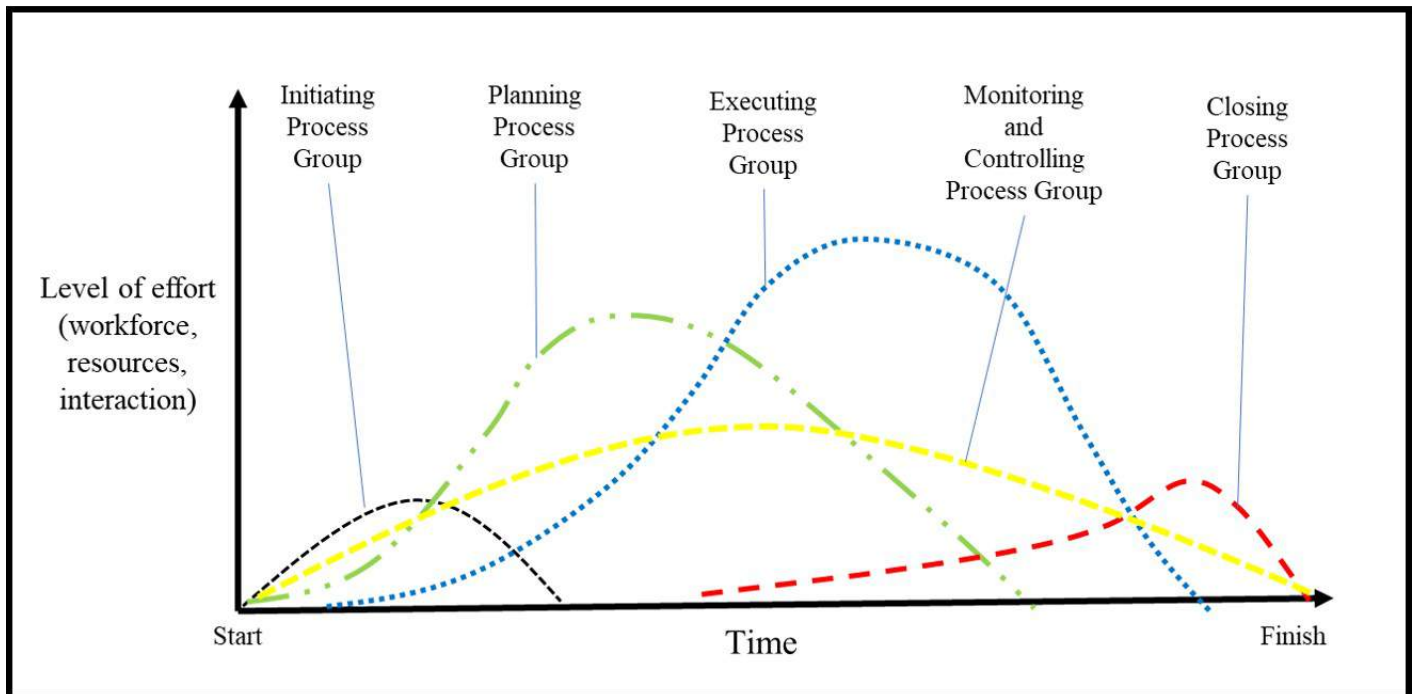

Figure 1.2: Project Management Process Groups (Adapted from PMBOK Guide 6th Edition)

1.6 Project Management Knowledge Areas

Another way of categorizing processes is through the knowledge areas according to the PMBOK Guide 6th edition. These knowledge areas are defined by knowledge requirements. They are:

1. Project Integration Management
2. Project Scope Management
3. Project Schedule Management
4. Project Cost Management
5. Project Quality Management
6. Project Resource Management
7. Project Communications Management
8. Project Risk Management
9. Project Procurement Management
10. Project Stakeholder Management

These knowledge areas constitute the basic layout of almost all project management textbooks. This also would be the main approach we are following throughout this book.

1.7 Key Takeaways

Key Takeaways

- A project is a temporary endeavor undertaken to create a unique product, service, or result.
- A project has two distinctive characteristics that distinguish it from ongoing and routine works - business operations. Projects are unique and temporary.
- Projects are confined to a variety of constraints. Triple (iron triangle) constraints are scope, schedule, and cost. Besides, and tightly linked with triple constraints, resources, quality, and risks are also evaluated as constraints.
- Project success deals with the impacts of a project's final product or service on stakeholders. Project management success focuses on the processes of a project including the successful accomplishment of the scope, within budget (cost), within time (schedule), and quality aspects. A project may be successfully managed but not meet the client or customer's expectations.
- The project life cycle is composed of phases which are generically named as starting (initiating, conceptualization), planning (organizing and preparing), implementing (executing, carrying out), and termination (close-out, ending).
- Different from project life cycle phases, but in line with them, processes are grouped inside five project management process groups according to the PMBOK Guide 6th Edition. They are named initiating, planning, executing, monitoring and controlling, and closing.
- Project management is also assessed in terms of knowledge areas that constitute the basic layout of most of the project management textbooks.

1.8 Questions and Exercises

There are 10 questions for this chapter. As you submit each answer, you will get immediate feedback and be taken to the next question.

An interactive or media element has been excluded from this version of the text. You can view it online here:

<https://pressbooks.ulib.csuohio.edu/project-management-navigating-the-complexity/?p=39>

1.9 Attribution

This chapter is a derivative of the following texts:

1. [Project Management by Adrienne Watt](#). © [CC BY \(Attribution\)](#).
2. [Project Management from Simple to Complex](#). © [CC BY \(Attribution\)](#).
3. [Project Management by Florence Daddey](#). © [CC BY \(Attribution\)](#).
4. [Project Management Fundamentals by Shelly Morris](#). © [CC BY \(Attribution\)](#).
5. [Project Management by Merrie Barron and Andrew R. Barron](#). © [CC BY \(Attribution\)](#).

Chapter 2. Strategy, Objectives, and Project Selection

2.0 Learning Objectives and Overview

Learning Objectives

1. Define the business strategy and goals that constitute the basis of business cases and projects in an organization, and describe the strategy cycle.
2. Create SMART objectives that can be used in business cases, project charters, and project management plans.
3. Outline the content of a business case that would lead to the selection of projects.
4. Employ a variety of selection models to select projects.

Overview

Projects don't start from out of anywhere. Before the organization's project selection committee and/or executive management decides on which projects the organization can go with, the reasons to start a project must be delineated in a pre-project stage. This stage often consists of the preparation of a business case accompanied by a needs assessment and a benefits realization management plan. A business case is a document that helps an organization decide whether the project will have a positive economic, financial, and/or social impact. Business analysts, systems analysts, or product managers, or a team composed of them and relevant stakeholders can prepare a business case. In many cases which are not rare, project managers can be assigned with the task to create a business case during the initiation of a project if the project's feasibility hasn't been assessed before. Organizations produce plenty of business cases in which the organizational needs are detailed. However, due to the scarcity of resources, time, and budget, and also taking into consideration the boundaries determined by the organizational priorities and strategic objectives, organizations choose only some of the business cases and their solutions as projects to develop. Project managers may not participate in this process. Nevertheless, it is of utmost importance for the project managers and teams to be familiar with the process since business cases constitute the basis of projects and they include fundamental information about the projects. Business cases are used as input to conceptualize a project and lead directly to the preparation of a project charter through which project managers can receive the authorization to start the project.

2.1 Business Strategy and Goals

Organizations exist to fulfill a purpose. These purposes are analyzed through a process and ultimately expressed in an organization's vision and mission statements. Vision statements are often very broad and they describe what the organizational leaders want the organization to accomplish. Mission statements are more specific: they describe how the organization is going to fulfill its vision. Recently, on many organizations' websites, mission and vision statements have not been explained separately, but as one statement named "mission statement". Organizations may also elaborate on their principles, values, culture, and goals to explicate their missions. Some examples of vision and mission statements as well as other information such as principles, values, and culture are provided below:

LinkedIn:

Vision: Create economic opportunity for every member of the global workforce.

Mission: The mission of LinkedIn is simple: connect the world's professionals to make them more productive and successful.

Facebook:

Mission: Give people the power to build community and bring the world closer together.

Culture: At Facebook, we are constantly iterating, solving problems, and working together to connect people all over the world. That's why it's important that our workforce reflects the diversity of the people we serve. Hiring people with different backgrounds and points of view helps us make better decisions, build better products and create better experiences for everyone.

Ikea:

Vision: Our vision is to create a better everyday life for the many people - for customers, but also for our co-workers and the people who work at our suppliers.

Business idea: While our vision tells us why we exist, our business idea tells us what we want to achieve. And for everyone that has visited IKEA, our business idea is pretty obvious - "to offer a wide range of well-designed, functional home furnishing products at prices so low, that as many people as possible will be able to afford them."

Microsoft:

Mission: Our mission is to empower every person and every organization on the planet to achieve more.

One way to consider the interrelated nature of Vision and Mission Statements, as well as other core components of an organization, is to think about them as part of what is called a Strategy Cycle. Figure 2.1 presents an orderly process for strategic management that helps us understand the process and the components of strategic analysis. The cycle ends with “vision and mission” statements which convey the executive summary of the whole process. We should also keep in mind that, most of the time, top managers deal with these steps simultaneously rather than following a stepwise approach.



Figure 2.1: The strategy cycle.
Attribution: Rice University, OpenStax

Organizations create specific strategies that should be pursued in the long term. Projects are often used to help carry out those strategies. These long-term objectives help organizations to gain a competitive advantage and a higher market share, and eventually to acquire a variety of tangible and intangible benefits in line with organizations’ field of operations (e.g., businesses, government agencies, nonprofits). These strategies are directly linked to the objectives being pursued and will vary widely depending on the industry and maturity of the organization. Whereas nonprofits or government agencies pursue to offer a public and social benefit, companies would target to acquire financial benefits. Examples of strategies an organization may implement include the launch of new products and services, the introduction of new technology, the streamlining of operational processes, and employee development initiatives. The strategies are embodied in objectives where they are described in detail.

The following section “SMART objectives” discusses how these objectives can be created in a way that makes sense to the organization and all the stakeholders

After the identification of strategic objectives, organizations choose strategies that will guide them for a period of time (i.e., one year, three, five, or ten years), and move into the strategy implementation stage. Depending on the complexity of the changes being introduced, the strategies may be implemented as individual stand-alone projects or programs consisting of multiple projects which are related to each other. Project and program managers apply their expertise to the implementation domain and play a vital role in helping organizations achieve their vision and mission. It is critically important that project and program managers understand an organization’s strategies and objectives. This knowledge allows them to ensure that the decisions being made in their projects and programs are aligned with the organization’s strategic direction.

<https://about.linkedin.com/>

<https://about.facebook.com/company-info/>

<https://www.ikea.com/us/en/this-is-ikea/about-us/vision-and-business-idea-pub7767c393>

<https://www.microsoft.com/en-us/about>

2.2 SMART Objectives

All the business cases, projects, project deliverables, activities, and milestones are characterized with objectives that describe what is expected to be achieved at the end. The information provided in this subsection can be used not only for business cases but also for projects and their components. Successful organizations are intentional about the actions they take to fulfill their vision and mission. These organizations analyze their external and internal environments to understand the opportunities and threats present in the environments in which they operate (see Chapter 3 - Project Initiation). An organization also must analyze and work within its own strengths and weaknesses. This analysis directly refers to a SWOT (Strengths, Weaknesses, Opportunities, Threats) analysis. These analyses can be used to inform the decision-making that follows.

The primary goal of a business case and a project and their objectives must be clearly defined, must contain a measure of how to assess whether they have been achieved, and should be realistic. A commonly utilized guideline to create this kind of objective is to follow the SMART protocol. SMART is an acronym that represents the criteria of *being specific, measurable, achievable, relevant, and time-based*. SMART objectives also serve as performance metrics to monitor the progress of a project and decide whether the outcomes are successful and can be accepted by the client or customer. Thus, the project manager can monitor and control these performance metrics.

Let's use a scenario to explicate each SMART criterion. Consider that our organization which is a regional office of a government agency (Department of Environment), named as Smalltown Office, has experienced some problems in providing quality service to the citizens in that region. We, as a team, were assigned to examine the problem and offer some solutions to overcome this quality problem.

Specific

We should develop unambiguous objectives that all our stakeholders can understand what we want to achieve. Thus, these objectives should be well-defined, specific, and written in clear, concise, and understandable terms. While creating an objective, we should ask "What do we want to accomplish?", "What do we intend to impact?", "Why is this goal important?", "Who is responsible for carrying out the action?", and "Who is our target audience/population?". Such questions would help us create specific objectives.

Based on our regional office's quality service problem, the business analyst created one of the business requirements as follows:

"The Smalltown Office affiliated with the Department of Environment in the State X will provide quality improvement training to the staff."

This objective can be considered specific as it addresses the primary objective by referring to the target population and responsible organization, and we want to achieve. However, it still lacks other elements of SMART.

Measurable

The success of a project relies on measurable quantitative criteria that must be met to achieve the objectives. If we don't use any metrics to measure the progress and performance, we can never be sure if we are on the track and can accomplish the targets when we finish the tasks or a project. These quantitative measures can indicate a number, percentage, or any standard unit. By means of measures, we can know that change has occurred how much, and in what direction. Besides, we should consider the source of verification and the data to prove the target is met. In our example, we can quantify the objective by adding the percentage of employees who are expected to receive this training.

"The Smalltown Office affiliated with the Department of Environment in the State X will provide quality improvement training to at least seventy-five percent of the staff members who communicate and interact directly with the citizens."

Sometimes, it is not possible to directly measure the performance or achievement. Quality improvement training could be an effective method to increase the quality of the services provided to the citizens. However, it is of high importance to ask directly the citizens using interviews or surveys about their satisfaction level with the services they receive. Therefore, we can support this objective with another objective as below:

"The satisfaction level of the citizens who receive service from Smalltown Office will increase by 25% according to a survey replied by at least 500 citizens."

In order to measure the improvement of 25%, the average satisfaction level of the citizens before the training is delivered should be measured, which would constitute the baseline. We also make this objective specific by adding the target audience who are at least 500 citizens.

Time-based

The last letter of the SMART acronym refers to "time-based" objectives. The SMART protocol doesn't necessarily impose an order of letters to follow while creating SMART objectives. However, discussing the time-based criterion can be more practical taking into consideration the nature of time as a measure itself. While assessing this criterion, we can address the issues such as how long to expect a project to take, and how much time for different success metrics to be met.

"The Smalltown Office affiliated with the Department of Environment in the State X will provide quality improvement training to at least seventy-five percent of the staff members who communicate and interact directly with the citizens by the end of July 2022."

“The satisfaction level of the citizens who receive service from Smalltown Office will increase by 25% according to a survey replied by at least 500 citizens by the end of December 2022.”

While we create these objectives, we should also consider if the performance measures and deadlines are realistic (achievable).

Achievable

We should also consider the factors that may affect the achievability of objectives. These factors include the evaluation of resources, knowledge, and time that are available to carry out the tasks to achieve the objectives. Therefore, in order to clarify achievability, it may be helpful for our team to explain who will deliver this quality improvement training to Smalltown Office employees, the availability of funds that can be allocated to the trainers, and the availability of an adequate number of employees that can serve the citizens in a timely manner while others receive the training. We should also clarify if the time to achieve these objectives is realistic. Can Smalltown Office provide this training to at least 75% of the staff by July 2022? Or do we need to reassess the percentage and the deadline? Constraints that may affect the achievement of these objectives should also be taken into account.

As can be seen here, SMART is an iterative process through which each criterion should be evaluated constantly considering the impact of each of them on other criteria.

Relevant

The last criterion that needs to be considered is the relevance of these objectives with higher-level organizational goals such as strategic objectives, mission and vision statements, and the goals of programs or portfolios that the business need or project is affiliated with. This alignment can ensure that the business case or project would have a higher chance of approval from the organizational leadership and greater buy-in from the stakeholders.

In our example for Smalltown Office, we should check the strategic plan of the Department of Environment. We need to see if there is an objective for the quality management and improvement that is planned for the organization as a whole, or the departments and regional offices. The review should not be limited to the strategic plan, but also other projects, programs, and portfolios since there may be a planned or ongoing project regarding quality management. Therefore, we can also avoid duplications and redundancy, and save time and budget.

Case Study 2.1: SMART Objectives for Grocery LLC’s Mobile-Commerce Scenario

We started working on a case study in Chapter 1 as regards a grocery chain, Grocery LLC, with fifty branches across five states. There were two business needs for this scenario:

1. Long lines form in front of the current check-out stations where the cashiers work.
2. Declining sales in markets since the onset of the COVID-19 pandemic.

Let's work on the second business need to develop SMART objectives. The primary objective is to create solutions for customers who purchase goods and services from our grocery stores through their smartphones. Based on the business case, it was decided to produce two solutions which are the optimization of the mobile website for Android and IOS, and a smartphone application. Objectives in line with these two solutions have been determined as:

1. To redesign the website in 2 months so it's responsive and easier for the customers to place orders on their smartphones.
2. To create a new mobile application in 2 months that can work in both operating systems (Android and IOS).

These two objectives can be considered specific as both describe what is intended to achieve for which audience. Besides, both are time-based. So, we know when we can have both solutions operational for the online customers. But we need more to evaluate other criteria (measurable, achievable, and relevant). Let's create another objective that supports these two objectives:

- In three months after the mobile website and the new mobile application go live, online sales will increase at least 25%, customer satisfaction will increase at least 20%, and we can retain our loyal customers.

This objective provides us with the quantitative measures to evaluate the effectiveness of the two solutions. Both help us understand if the customers do online shopping and if they are happy with their online shopping experience. Besides, we can ask our loyal customers if they also buy online, and thus they don't often prefer other stores and e-commerce websites to substitute for the physical shopping they used to do in our grocery markets. To verify these measures, we should have reliable sources as detailed below:

- Online sales figures before the mobile solutions are introduced and three months after they go live will be compared.
- Two surveys (before the mobile solutions are introduced and three months after they go live) will be conducted by a market research company to measure the satisfaction level of customers.
- The customers who have bought items from our company for the last three years will be interviewed to understand if they still do their shopping at our grocery markets and on new mobile solutions.

We also should answer these questions to assess if these objectives are achievable and relevant?

- Does the grocery chain have the time, budget, and resources to conduct and finish the whole project?
- Are these objectives in line with the grocery chain's mission statement, and strategic

objectives?

- Are there any conflicts with other ongoing or future projects? Is there a need to cooperate with other projects to share and assign resources or to synchronize some activities and deliverables?

<https://www.health.state.mn.us/communities/practice/resources/phqitoolbox/objectives.html>

2.3 Business Case

Organizations initiate projects to exploit business opportunities that are aligned with the organization's strategic goals or eliminate business problems they encounter. Projects are generally preceded by a business case that provides the economic, financial, and/or social feasibility and justification of the business need (Figure 2.2). However, some projects may be initiated in a short time with an order from the CEO or executive management team to address competitive measures, government mandates, or an exclusive inclination. Hence, there may not be a formal business case that the project team can utilize to initiate the project. Nevertheless, in such situations, project managers are generally asked to conduct a needs assessment and feasibility study as well as a benefits management plan. Business cases aim to respond to a need, generally in the form of a problem or an opportunity, and they are generally prepared by business analysts in an organization in collaboration with relevant units and stakeholders.

A business case attempts to elaborate on the need for a project by providing an analysis of the current state, a description of the desired future state, and the actions to take to fill the gap between the current state and the desired future state. It also includes business, stakeholder, solution, and transition requirements, designs and recommended solutions generated according to these requirements, and the evaluation of solutions to understand the potential value of these solutions. A business case is accompanied by a needs assessment and benefits realization management plan. A needs assessment often precedes the business case, and it is used to assess the current internal and external environments and current capabilities of the organization to determine the viable solution options that, when pursued, would help the organization meet the desired future state.

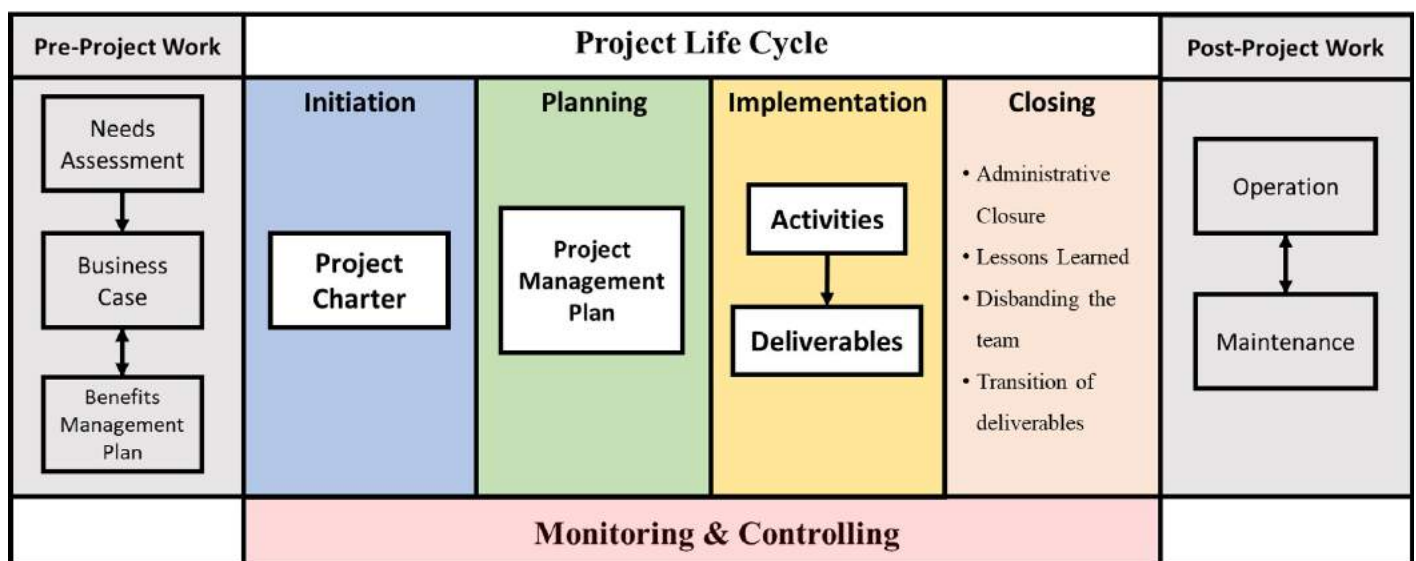

Figure 2.2: Pre-Project Work, Project Life Cycle, and Post-Project Work.

Source: PMBOK Guide 6th Edition

The value of a business case to the project is two-fold. First, it is used as an input in the development of a project charter during the initiation (starting, conceptualization) project life cycle stage. Additionally, it is utilized as input to identify stakeholders who may be affected by or may affect decisions, activities, or outcomes of a project. Therefore, business cases are utilized as a basis for authorization of further project management activities.

A business case can also be described as an economic feasibility study documented to justify and establish boundaries for the project. The validity of benefits is established through two accompanying processes, which are business needs analysis and cost-benefit analysis. Therefore, the required investment to start a project to acquire the expected outcomes can be justified from a business standpoint.

While many business cases share common elements, each one is tailored to the organization in which it is used. A business case can be formatted based on the needs of the organization and/or the organization's templates in its knowledge repository. The main components of a business generally consist of:

1. Need statement (Underlying problems or opportunities)
 - The cause-effect diagram (fishbone diagram) is a useful instrument in this stage to identify the underlying issues rather than describing the surface-level issues.
 - If it is an opportunity, the main contributors are investigated.
2. Statement of goals (Business requirements)
3. Stakeholders and their requirements
4. Analysis of current state and future state, and creation of a business change strategy
5. Constraints, dependencies, assumptions, risks, critical success factors, and decision criteria
6. Designs and alternative solutions
7. Potential value (benefits and costs)

Although preparation of a business case and its accompanying documents are considered a pre-project work, project managers may also involve in this process, in particular, if a PMO (Project Management Office) exists in an organization, or the project initiation is requested from the top level or if it is an urgent request from a client.

Project managers or project steering committees use the information available in a business case to initiate the project, identify stakeholders, and develop a project charter. A business case helps create performance metrics that are utilized to measure the project success against the objectives whenever a deliverable is produced and the project outcomes are generated at the end of the project.

Business cases play an essential role during project selection. Project selection committees or senior managers assess all the business cases and their recommended solutions as candidate projects. Due to various factors such as time, budget and resource constraints, internal and external factors, and organizational strategic priorities and plans, organizations cannot put all the projects into

implementation. The next section discusses the project selection criteria.

Project Management Institute. (2017). A guide to the Project Management Body of Knowledge (PMBOK guide) (6th ed.). Project Management Institute.

Project Management Institute. (2015). Business analysis for practitioners: A practice guide.

International Institute of Business Analysis. (2015). A guide to the Business Analysis Body of Knowledge (BABOK guide), version 3.0. Toronto, Ont: International Institute of Business Analysis.

Project Management Institute. (2015). Business analysis for practitioners: A practice guide

Project Management Institute. (2017). A guide to the Project Management Body of Knowledge (PMBOK guide) (6th ed.). Project Management Institute.

2.4 Project Selection Process

When selecting a project, both quantitative and qualitative analysis is useful in order to arrive at projects which have the greatest potential impact. Generally, more complex projects involve a greater amount of risk. They also require a longer implementation and business benefits realization period. Therefore, project selection decisions will weigh the benefits offered with the timeframe required to realize these benefits. Organizations will often consider the payback period, which refers to the amount of time it takes to recover the cost of an investment. Projects that offer significant benefits, and that can be realized in a relatively short time, are more likely to be approved. However, this is only one of the methods to evaluate if a project is favorable compared with other projects.

In Chapter 1, we started evaluating the uniqueness and temporary nature of a project through which our grocery market chain, Grocery LLC, aimed at establishing self-checkout areas at all fifty markets across five states to solve the problem of more than usual traffic between 4 pm and 7 pm during the weekdays. Assume that we had two solution candidates for this problem. One is the self-checkout area to be established at all fifty stores (See Chapter 1, Case Study 1.1). Let's name the "establishment of self-checkout areas" project as "Project B". We also wanted to evaluate another solution through which we can increase the number of checkout stations where our cashiers work. This solution is named Project A.

Table 2.1 provides cash inflows and outflows of two candidate projects assuming that both project deliverables have a lifetime of five years. As can be seen in Table 2.1, the payback period for Project A would be three years, which means that our organization can recover the cost (\$100,000) of this project's investment in three years.

$$-100,000 (\text{year } 0) + 30,000 (\text{year } 1) + 40,000 (\text{year } 2) + 30,000 (\text{year } 3) = 0$$

Table 2.1: Cash outflow and inflows of two projects (\$)

	Project A	Project B
	(Traditional checkout stations)	(Self-checkout areas)
Year 0	(\$100,000)	(\$200,000)
Year 1	\$30,000	\$15,000
Year 2	\$40,000	\$50,000
Year 3	\$30,000	\$75,000
Year 4	\$10,000	\$105,000
Year 5	\$10,000	\$75,000

For Project B, the payback period would be 3.57 years (3 years + 60,000/105,000). As can be seen in Table 2.2, when we finished the third year, the net cash flow was still negative (-200,000 + (15,000 + 50,000 + 75,000) = -60,000). Therefore, the breakeven point would be after the fourth year. Because Project A's payback period (3 years) is shorter than Project B's (3.57 years), we can prefer Project A over Project B only taking into account the payback period.

Table 2.2: Net cash inflows of two projects (\$)

	Project A	Net Cash Flow	Project B	Net Cash Flow
Year 0	(\$100,000)	(\$100,000)	(\$200,000)	(\$100,000)
Year 1	\$30,000	(\$70,000)	\$15,000	(\$185,000)
Year 2	\$40,000	(\$30,000)	\$50,000	(\$135,000)
Year 3	\$30,000	\$0	\$75,000	(\$60,000)
Year 4	\$10,000	\$10,000	\$105,000	\$45,000
Year 5	\$10,000	\$20,000	\$75,000	\$120,000

However, this financial method ignores a crucial factor that may affect the real value of our cash inflows, which is the time value of the money, that is affected by two main annual rates: (1) Inflation rate (p_t), and (2) required rate of return (r). Therefore, the discount factor needs to be incorporated into the computation to have real values.

$$\text{Discount factor} = \frac{1}{(1 + p_t + r)^n}$$

In our example above, let's take p_t 0.02, and r 0.08. Our organization expects to earn a minimum of 0.08 annually on average when we invest. This can also be considered as the opportunity cost.

$$\text{Year 1: Discount factor} = \frac{1}{(1+0.02+0.08)^1} = \frac{1}{1.10^1} = 0.9090$$

$$\text{Year 2: Discount factor} = \frac{1}{(1+0.02+0.08)^2} = \frac{1}{1.10^2} = 0.8264$$

$$\text{Year 3: Discount factor} = \frac{1}{(1+0.02+0.08)^3} = \frac{1}{1.10^3} = 0.7513$$

$$\text{Year 4: Discount factor} = \frac{1}{(1+0.02+0.08)^4} = \frac{1}{1.10^4} = 0.6830$$

$$\text{Year 5: Discount factor} = \frac{1}{(1+0.02+0.08)^5} = \frac{1}{1.10^5} = 0.6209$$

For each year, we should multiply the discount factor by each cash inflow to find the real value.

Table 2.3: Net cash outflow and inflows of two projects with discount factors (\$)

	Project A	Today's Value	Net Cash Flow	Project B	Today's Value	Net Cash Flow
Year 0	(\$100,000)	(\$100,000)	(\$100,000)	(\$200,000)	(\$200,000)	(\$200,000)
Year 1	\$30,000	\$27,273	(\$72,727)	\$15,000	\$13,636	(\$186,364)
Year 2	\$40,000	\$33,058	(\$39,669)	\$50,000	\$41,322	(\$145,041)
Year 3	\$30,000	\$22,539	(\$17,130)	\$75,000	\$56,349	(\$88,693)
Year 4	\$10,000	\$6,830	(\$10,300)	\$105,000	\$71,716	(\$16,976)
Year 5	\$10,000	\$6,209	(\$4,091)	\$75,000	\$46,569	\$29,593

As can be seen in Table 2.3, the payback period changed for both projects. The payback period for Project A cannot be attained in five years, which means that our organization cannot recover the cost (\$100,000) of this project's investment even in five years. For Project B, it would be 4.36 years (4 years + 16,976/46,569). Eventually, after taking into account the time value of the money, we can choose Project B over Project A on the contrary of our first decision without the discount factor.

NPV (Net Present Value) is another way of showing the long-term profitability of a project. At the end of the expected lifetime of a project outcome, NPV indicates the profit (Earnings - Project investment costs). As seen in Table 2.4, NPV is negative for Project A while it is positive for Project B. Therefore, we can select B over A.

Table 2.4: NPVs for Projects A and B (\$)

	Project A	Today's Value	Project B	Today's Value
Year 0	(\$100,000)	(\$100,000)	(\$200,000)	(\$200,000)
Year 1	\$30,000	\$27,273	\$15,000	\$13,636
Year 2	\$40,000	\$33,058	\$50,000	\$41,322
Year 3	\$30,000	\$22,539	\$75,000	\$56,349
Year 4	\$10,000	\$6,830	\$105,000	\$71,716
Year 5	\$10,000	\$6,209	\$75,000	\$46,569
NPV		(\$4,091)		\$29,593

Financial models such as payback period and NPV consider solely the financial indicators. Since little may be known about the specific solution at the time of project selection, financial evaluations are based on high-level estimates only. However, organizations need to consider other qualitative factors such as competitive advantage, future market potential, risk, legal and regulatory issues, and safety. Therefore, many organizations utilize project selection models where they can include criteria prioritized for the organization in general, and the projects and their affiliated programs and portfolios. In this chapter, we will discuss only one of the models commonly used by organizations, which is the weighted scoring model.

Non-financial reasons for selecting projects are often viewed as strategic considerations; they include everything from ending a dependency on an unreliable vendor to restoring the image of an organization. Once a project is selected, a more detailed financial analysis is often performed. Since decision-making models often consider numerous criteria when evaluating the change alternatives, tools such as the weighted scoring model are very helpful. Weighted scoring models introduce objectivity in what would otherwise be a very subjective decision-making process. A weighted scoring model allows decision-makers to structure the decision-making process by specifying and prioritizing needs by identifying decision-making criteria; evaluating, rating, and comparing different alternatives; and selecting the best matching solution.

Creating a weighted scoring model starts with careful consideration of decision-making criteria. In the case of project selection, many organizations refer to their strategic plans to identify important factors. These criteria are often a mix of financial and non-financial criteria. Once the criteria have been selected, we give each criterion a value, called a weight, in order to illustrate its relative importance. The more important the criterion, the higher its weight. Each of the potential change initiatives (e.g., business cases) is evaluated against the weighted criteria and given a score for each criterion. These models can help us introduce more objectivity into our decision-making.

Let us continue with our grocery market chain's project candidates. Thereafter, let us increase the number of projects to four. The project selection committee will evaluate these four potential projects based on six criteria. We have already discussed two projects' NPVs. The committee had scheduled a meeting today to discuss these four projects (Table 2.5). Project A targets to increase the traditional checkout stations in all the markets if their layouts allow for an expansion inside the markets. Project B aims to designate areas for self-checkout stations. In this project, we will need to reduce the number of traditional checkout stations. Project C's goal is to create new ads for television and social media (e.g., YouTube, Facebook, Instagram). Finally, Project D aims to create a new mobile (smartphone and tablet) application and make the current website compliant with the smartphones.

The organizational constraints (time, budget, resources, risks) allow the selection of a maximum of two projects. They are using a weighted scoring model. There are six criteria as shown in Table 2.5. They are strategic opportunity, competitive advantage in IT, the potential for higher market share, profitability (NPV), sustainability, and risk aversion. As can be seen here, we are not focusing on only the profitability, but also other factors that bring about a holistic approach to evaluating the feasibility and benefits of projects. The committee members will score each criterion. A score of 1 represents unfavorable, 2 satisfactory, and 3 favorable.

Although weights are provided out of 100 percent, in order to make the computation easier to follow, they are typed in Table 2.5 as two-digit numbers instead of decimals. Therefore, the total weight must not exceed 100. These weights may be decided after brainstorming meetings with subject matter experts and stakeholders. The subjectivity of these criteria's weights and points can be mitigated to some extent with the brainstorming activity. Most of the time, the organizations or the external client may impose the weights according to the organizational strategy and priorities.

Table 2.5: Weighted Scoring Model

Category	Weight	Projects			
		A	B	C	D
Strategic opportunity	25	1	3	2	3
Competitive advantage in IT	15	1	3	1	3
Potential for higher market share	20	2	2	3	3
Profitability (NPV)	10				
Sustainability	10	3	2	1	1
Risk aversion	20	3	2	3	1

As you can see in Table 2.5, NPV is just one of the criteria that is used by the selection committee. The required rate of return is 0.08, and the inflation rate is 0.02. We have already computed the discount factors above. The committee should incorporate the NPV scores based on the estimated cash flows given in Table 2.6, and the decision table in Table 2.7.

Table 2.6: Estimated cash flows (\$)

Project	Investment	Year 1	Year 2	Year 3	Year 4	Year 5
A	-100,000.00	30,000.00	40,000.00	30,000.00	10,000.00	10,000.00
B	-200,000.00	40,000.00	60,000.00	75,000.00	105,000.00	100,000.00
C	-30,000.00	20,000.00	15,000.00	10,000.00	3,000.00	1,000.00
C	-125,000.00	25,000.00	40,000.00	50,000.00	55,000.00	65,000.00

Table 2.7: NPV score decision table

NPV	SCORES
$NPV < 0$	1
$0 \leq NPV < 20,000$	2
$20,000 \leq NPV$	3

NPVs for four projects are, respectively, (1,046.07); 19,276.94; 8,284.08; and 42,182.60. Therefore, NPV scores are 1, 2, 2, and 3 respectively.

Table 2.8: Total Weighted Score (Computation of Total Scores)

Category	Weight	Projects				Weighted Scores			
		A	B	C	D	A	B	C	D
Strategic opportunity	25	1	3	2	3	25	75	50	75
Competitive advantage in IT	15	1	3	1	3	15	45	15	45
Potential for higher market share	20	2	2	3	3	40	40	60	60
Profitability (NPV)	10	1	3	2	2	10	30	20	20
Sustainability	10	3	2	1	1	30	20	10	10
Risk aversion	20	3	2	3	1	60	40	60	20
TOTAL SCORES	100					180	250	215	230

Based on the results, the selection committee should choose Project B (Self-checkout areas) since it has the highest score. Project D (M-commerce) has the second-highest total points (230 points). Since we can select two projects and initiate them, we can move forward for projects B and D. The project initiation will be discussed in Chapter 3. In that chapter and following chapters, we will focus on Project D.

However, it is always possible to modify the weights to favor another project. Therefore, this reminds us of the fact that these models are not free from subjectivity. For example, if we change the “strategic opportunity” weight from 15 to 10, the “competitive advantage in IT” weight from 25 to 10, the “profitability (NPV)” weight from 10 to 5, the “sustainability” weight from 10 to 25, and the “risk aversion” weight from 20 to 30, we can make Project A (Increasing the number of traditional checkout stations) the highest score. Hence, we can select Project A (Table 2.9). As can be seen in this example, this method is subject to substantial subjectivity.

Table 2.9: Total Weighted Score (Changed weights)

Category	Old Weight	New Weight	Projects				Weighted Scores			
			A	B	C	D	A	B	C	D
Strategic opportunity	15	10	1	3	2	3	10	30	20	30
Competitive advantage in IT	25	10	1	3	1	3	10	30	10	30
Potential for higher market share	20	20	2	2	3	3	40	40	60	60
Profitability (NPV)	10	5	1	3	2	2	5	15	10	10
Sustainability	10	25	3	2	1	1	75	50	25	25
Risk aversion	20	30	3	2	3	1	90	60	90	30
TOTAL SCORES		100					230	225	215	185

Weighted scoring models are easier to use as they offer structurally simple models. These models allow organizations to prioritize criteria according to their strategic objectives and client expectations. Management can directly ask the committees to consider the weights they provide so that it can be a direct reflection of managerial policy. Additionally, the weights can be modified in order to accommodate any changes in management and program levels. One of the apparent drawbacks of these models is that they don't allow a linear comparison among the projects. If a project gets 100 points, and another gets 200 points, it doesn't necessarily mean that the second project is two times more important than the first project. Another drawback could emerge when the number of criteria increases to a level where weights become relatively small. Thus, this model becomes like a non-weighted model at which criteria weights don't have an impact on the total scores.

This model is meant to add objectivity to our decision-making process; it is not meant to replace our own judgment. When the weighted scores are close, this indicates that a slight change in the weight of a criterion and/or a change in the subjective scores could significantly change the decision. For this reason, a weighted scoring model is often viewed as a tool that is meant to be revised as we learn more about what truly matters to us and/or the organization.

<https://www.investopedia.com/terms/p/paybackperiod.asp>

2.5 Key Takeaways

Key Takeaways

- Organizations create specific strategies that should be pursued in the long term. These long-term objectives help organizations to gain a competitive advantage and a higher market share, or to acquire a variety of tangible and intangible benefits in line with organizations' field of operations (e.g., businesses, government agencies, nonprofits). Projects are utilized to accomplish these long-term strategic objectives.
- The SMART protocol is commonly utilized by organizations to clearly define achievable and relevant objectives that contain measures and time-bound targets of how to assess whether they have been achieved. A commonly utilized guideline to create this kind of objective is to follow the SMART protocol. The SMART acronym represents being specific, measurable, achievable, relevant, and time-based.
- A business case is a feasibility document that justifies a need for an organization. It consists of the need statement, analysis of the current state and the desired future state, requirements, designs, and recommended solutions, and the evaluation of the solution to understanding the potential value.
- Organizations cannot put all the business cases and ideas into practice due to the constraints such as lack of time, resources, and budget. Thus, they implement project selection models to evaluate candidate projects and select some of them which satisfy the criteria of the models. These models are assessed in two main categories, that are financial and non-financial models. While payback period and net present value (NPV) fall into the financial models, weighted scoring models are used as non-financial models.

2.6 Questions and Exercises

There are 10 questions for this chapter. As you submit each answer, you will get immediate feedback and be taken to the next question.

An interactive or media element has been excluded from this version of the text. You can view it online here:

<https://pressbooks.ulib.csuohio.edu/project-management-navigating-the-complexity/?p=133>

2.7 Attribution

This chapter is a derivative of the following texts:

1. [Project Management by Adrienne Watt](#). © [CC BY \(Attribution\)](#).
2. [Project Management from Simple to Complex](#). © [CC BY \(Attribution\)](#).
3. [Project Management by Florence Daddey](#). © [CC BY \(Attribution\)](#).
4. [Project Management Fundamentals by Shelly Morris](#). © [CC BY \(Attribution\)](#).
5. Project Management by Merrie Barron and Andrew R. Barron. © [CC BY \(Attribution\)](#).

Chapter 3. Project Initiation

3.0 Learning Objectives and Overview

Learning Objectives

1. Explain the process of developing a project charter to authorize the project, and describe the roles of the project sponsor and project manager.
2. Describe the project environment, and outline the internal and external factors that may affect a project.
3. Explain the formal and informal organizational structure, and compare three main organizational structure types based on the project manager's authority level.
4. Describe the responsibilities of a Project Management Office (PMO).

All projects are undertaken for a reason. Some projects can be initiated for business reasons (i.e., strategic objectives) such as increasing profits, decreasing customer wait time, and improving employee working conditions. Other projects exist for social reasons such as a municipal recycling system or installing clean energy solutions. Often, the pressure to produce results encourages people to identify possible solutions without fully understanding the needs and purposes of the project. This approach can create a lot of immediate activity, but it also creates the likelihood that the change initiative will fail to deliver the proposed organizational value.

As detailed in Chapter 2, one of the best ways to gain approval for a project is to clearly communicate the project's objectives and describe how the project provides a solution for an organizational need or how it capitalizes on a business opportunity. A needs analysis that accompanies a business case is often conducted to better understand the underlying organizational needs and how meeting these needs would help the organization achieve strategic objectives (e.g., increase profits, improve customer experience, develop new products). Once alternative solutions are identified, each solution is assessed to determine if it supports the organization's vision and strategies. Issues of justification ("should we do the project?") and feasibility ("can we do the project?") are addressed for each solution. Finally, some projects are selected to initiate. It is important to note that project justification is a key part of the project initiation phase: a project must have a reason to exist and, if no such justification can be determined, then it's best to stop the project before too much time, money, and resources are invested in it. If issues of justification are not adequately addressed, the project will lack the required organizational support and, therefore, will ultimately be unsuccessful.

3.1 Project Charter

Project justification starts when a business case is prepared which addresses the needs, and feasibility of solutions. Project managers may be involved during this phase though it is also common not to have a project manager in this pre-project work. In organizations having a Project Management Office (PMO) or a program department, project managers, or a team of project managers and their assistants, could participate in developing the business case with business analysts, subject matter experts, and representatives from relevant departments. A business case could be prepared during the initiation if it wasn't made in the pre-project phase.

When a project selection committee decides to go with some of the projects proposed, the sponsor, business analysis team, relevant departments, or selection committee members can start the preparation of a project charter which will allow the formal authorization of the existence of a project. A project charter provides the project manager with the authority to apply organizational resources to project activities. Developing a project charter requires inputs such as business documents (business case, needs analysis, and benefits management plan), agreements, enterprise environmental factors (discussed in Project Environment below), and organizational process assets. A project charter is necessary to initiate both internal projects at which a client is a unit in our organization and external projects at which the client is outside our organization. If we are conducting a project with an external client, the two parties (i.e., our organization and the external client) will also need a formal and legally binding contract to establish an agreement.

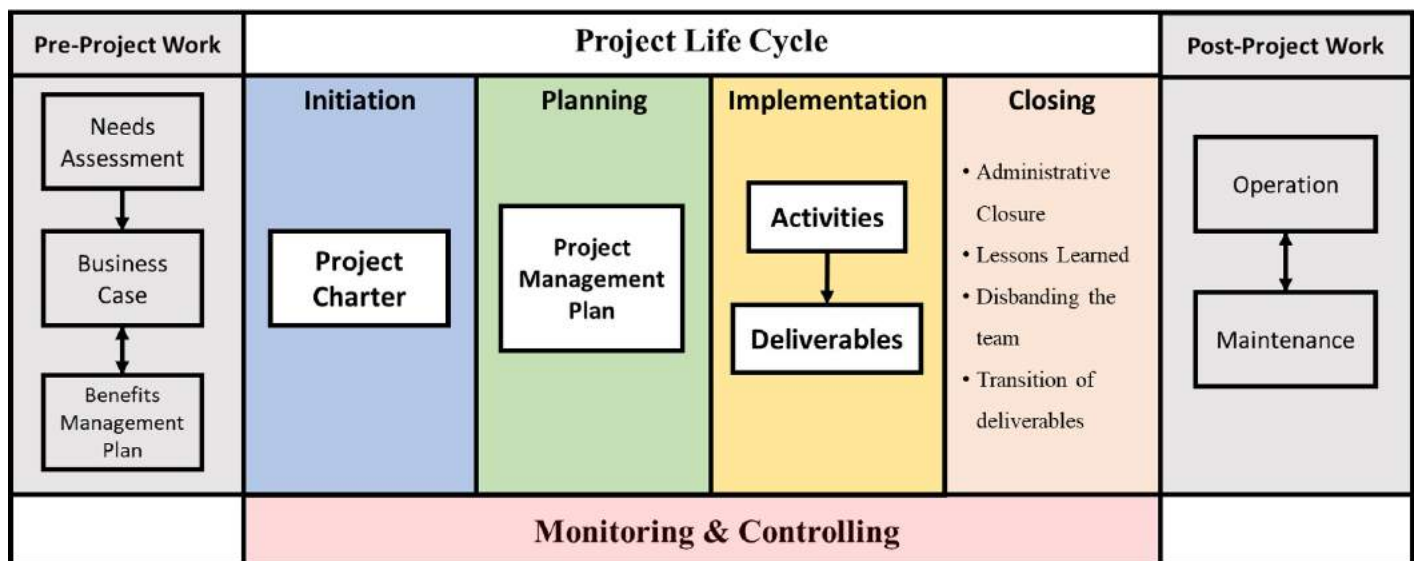

Figure 3.1: Pre-Project Work, Project Life Cycle, and Post-Project Work
 Source: PMBOK Guide 6th Edition

In the initiation stage (Figure 3.1), there are two main processes according to the PMBOK Guide 6th

edition: Developing a project charter and identifying stakeholders. The former process will be discussed in detail in Chapter 5 “People Management: Stakeholders and Communication”. The initiation of the project is the process group to start developing the project infrastructure to support all the activities associated with planning, executing, monitoring, and closing the project. In this stage, project managers should give the priority to address stakeholders’ expectations and concerns in order to properly determine all the components (e.g., scope, schedule, budget, resources, risks, quality) of the project. Therefore, project managers conduct one or more kickoff meetings to align all the various stakeholders. The strength of the initial alignment will have a big impact on project success. At this early stage, project managers learn how to identify the appropriate means of communication with key stakeholders. Effective communication with project stakeholders is another critical success factor so this work must begin early (see Chapters 5 and 6). Initiation is the first project life cycle stage to begin team building and developing collaborative approaches for working together. During the kick-off meeting, the project manager, the team, or the sponsor should share the information below with the main stakeholders involved:

- The project’s objectives
- Known priorities and success metrics
- Organizational constraints and related trade-offs
- A high-level description of the project scope
- Key milestones
- An initial list of project risks
- Key stakeholders

After the initial kick-off meeting, subsequent meetings with primary stakeholders lead to more clarification and elaboration on the information above and the development of a project charter. Just like with project justification documents, low complexity projects may have very short project charters while higher complexity projects may require longer, more comprehensive project charters. In either case, there are two very important aspects of the project charter: key stakeholders including a detailed description of their roles and responsibilities, and project success metrics.

A project charter must be approved by the project sponsor. The project sponsor is the most powerful stakeholder and is usually an executive in the organization with the authority to assign resources and enforce decisions regarding the project. They often initiate the project and, as such, are often referred to as the “initiating sponsor.” A project sponsor has the authority to start and stop the project and will support the completion of project objectives by removing the barriers to success. They can be regarded as the “external champion” because they often serve as the last escalation point when the project team needs support bringing an off-track project back on track. Successful project teams know how to leverage the power and position of the project sponsor and will proactively ask them to deliver influencing communications throughout the organization in order to maintain the project’s momentum and high morale within the team. Many project sponsors can assign one or more sustaining sponsors to act as the “internal champion(s)” of the project. The sustaining sponsors are often leaders of the internal departments that are most affected by the project, such as a marketing manager or human resources manager. When the project sponsor selects the sustaining sponsor(s), one of their goals is to

ensure that the project team frequently considers the organizational impacts of the changes being introduced. By keeping the sustaining sponsor(s) actively engaged in the project, they will ensure their teams are intently participating in the project and identifying the operational impacts that must be considered in order for the change to be sustained once the project has been completed. On a day-to-day basis, the sustaining sponsor(s) act as the first point of escalation as issues/risks are raised.

The project charter formally recognizes the existence of the project by presenting the project leader's understanding and conceptualization of the project's objectives. Most importantly, it authorizes the project leader to apply organizational resources to achieve the project's objectives. Once the Charter is approved and formally signed off, it becomes an agreement between the project leader and the project sponsor. As such, some organizations prefer to refer to this document as a letter of agreement instead of a project charter. Approval of this document, whether a letter of agreement or a project charter, signals the transition into the planning phase of the project.

The Content of a Project Charter

A project charter is a necessary document to initiate a project. Organizations may have different templates for a project charter. Below is a generic template for a project charter that would help students understand the main components and hence develop one in their individual and team (group) assignments, and when they are involved in project teams. Our template has thirteen sections. Case Study 3.1 below will elaborate on each section.

1. Project purpose
2. Measurable project objectives
3. High-level requirements
4. High-level project description, boundaries, and key deliverables
5. Assumptions and constraints
6. Overall project risk
7. Summary milestone schedule
8. Preapproved financial resources
9. Key stakeholder list
10. Project approval requirements
11. Project exit criteria
12. Project team
13. Name and authority of the sponsor authorizing the project charter.

Case Study 3.1: Project Charter of Grocery LLC's Mobile-Commerce Project

In Chapter 1, we started evaluating the uniqueness and temporary nature of the two projects. The first project aimed to establish self-checkout areas at all fifty markets across five states to solve the problem of more than usual traffic between 4 pm and 7 pm during the weekdays (Case 1.1). The second project aimed to create a new mobile application and make the current website compliant with the

smartphones (Case 1.2). In Chapter 2, we performed a weighted scoring model (Table 2.8) to compute the total scores of project candidates based on various criteria which are not only dependent on financial factors and chose projects A (self-checkout stations) and D (m-commerce). Project D addressed the problem of declining sales at Grocery LLC's all fifty markets in general with the onset of the COVID-19 pandemic. Considering the priority of the project and the pessimistic trends forecasted regarding the pandemic as well as the increasing digitalization of companies and consumers, we will use this project in this chapter and the following chapters.

1. **Project Purpose:**

To create solutions for customers who purchase goods and services from our grocery stores through their smartphones.

2. **Measurable Project Objectives:**

- i. To redesign the website in 2 months so it's more responsive and easier for the customers to place orders on their smartphones.
- ii. To create a new mobile application in 2 months that can work in both operating systems (Android and IOS).

In three months after the mobile website and the new mobile application go live, online sales will increase at least 25%, customer satisfaction will increase at least 20%, and we can retain our loyal customers.

- Online sales figures before the mobile solutions are introduced and three months after they go live will be compared.
- Two surveys (before the mobile solutions are introduced and three months after they go live) will be conducted by a market research company to measure the satisfaction level of customers.
- The customers who have bought items from our company for the last three years will be interviewed to understand if they still do their shopping at our grocery markets and on new mobile solutions.

3. **High-Level Requirements**

- The mobile website and smartphone application shall:
 - Include all the functions that a desktop website possesses.
 - Be accessed with the same login username and password.
 - Synchronize the customer profile and the cart with the desktop website.

4. **High-level project description, boundaries, and key deliverables**

Needs Statements are retrieved from the business cases if available.

There has been a steady decline for the last six months in online purchases. Our company lost many customers due to the pandemic. Customers prefer buying online instead of visiting a store in person since they have serious concerns to contract Covid-19. Our fifty stores in five states lost around 30% of regular customers, and the revenue declined by 25% since the start of the pandemic restrictions in March 2020. When our business analysts investigated the issue by conducting a root-cause analysis, they found that many customers use their smartphones to buy online rather than using their desktop or laptop computers. When the customers visited our company's website, they could not complete their online transactions since the website has not been optimized for mobile. Besides, we haven't had a mobile application that our customers can use on their smartphones. E-commerce websites such as Amazon, and brick and click stores such as Walmart and Target, and grocery chains such as Whole Foods (through Amazon) are strong competitors from which customers can do their online shopping conveniently.

Therefore, our project has been initiated to optimize the desktop website on both Android and IOS smartphones and to create a new smartphone application. In this project, we are not directly targeting tablets since their screen size would allow us to display the regular desktop website. Besides, the smartphone application can be used in tablets.

5. **Assumptions and Constraints**

- Assumptions:
 - i. A positive trend is expected in the long term that mobile e-commerce transactions will rise.
 - ii. Our current website will continue to function during the project.
 - iii. The owners and the top executives will continue to support this project.
- Constraints:
 - i. Some loyal customers who prefer in-person shopping may be resistant to change so that they may not want to use online shopping.

6. **Overall project risk**

- Shortage of web designers and mobile app developers
 - Due to the COVID-19 pandemic, there is a higher demand for web designers and mobile app developers. Besides, these qualified employees may not be available if they contract COVID-19 when they

are working on our project.

- During the execution of our project, customers may prefer to do their shopping on large e-commerce websites such as Amazon as they can find more varieties with lower prices and better deals. Therefore, our deliverables may not be utilized in the way that is desired.

7. **Summary Milestone Schedule**

The project starts on May 2, 2022, and finishes on July 1, 2022.

- i. Kick-off: May 2, 2022
- ii. Finalization of requirements elicitation: May 10
- iii. Completion of analysis and design: May 25
- iv. Completion of coding and testing: June 15
- v. Completion of alpha testing: June 20
- vi. Completion of beta testing: June 30
- vii. Customers can visit the mobile website and install the smartphone app: July 1, 2022

8. **Preapproved Financial Resources**

The initial budget for this project was determined as \$200,000. Two similar projects conducted and completed by two other companies were used. The itemized budget will be available and can be revised when the analysis and design are completed.

9. **Key Stakeholder List**

1. Project manager (Senior Systems Analyst)
2. Project team members (The core team)
3. Project sponsor (Chief Operations Officer - COO)
4. Product owner (The representative from the operational department who was assigned by the COO)
5. IT Department
6. Sales Department
7. Marketing Department
8. HR Department
9. Store managers and employees
10. Suppliers

11. Online customers
12. Customers who visit the stores in person
13. Government agencies that announce the pandemic restrictions

10. **Project Approval Requirements**

The mobile website and the smartphone app will be subject to alpha testing first. Then, beta testing will follow, where customers can install the beta version on their smartphones and do their online shopping. During the implementation of the beta version, all the feedback from customers and their mobile devices will be evaluated and the bugs and problems will be corrected. When the mobile website and the app are fully functional, customers should log in with their usernames and passwords, browse items, add them to their carts, proceed to checkout, and complete their payment.

The sponsor must approve the sign-off after they receive the inspection and acceptance report.

11. **Project Exit Criteria**

- The project will be closed successfully if both deliverables pass beta testing and all the human resources working on this project are paid.
- The project will be canceled if the financial situation of our company worsens significantly so that it is not possible to fund the project.

12. **Project Team**

- i. Project manager: Senior systems analyst
- ii. Two systems (business) analysts
- iii. Two UI/UX designers
- iv. Three developers (including Android and IOS developers, and the backend developer)
- v. Two testers (quality assurance engineers)
- vi. Two sales and marketing experts

13. **Authority of the Sponsor**

The COO (Chief Operations Officer) of Grocery LLC is the sponsor. The project manager will have the full authority to identify the necessary tasks and resources needed to complete all the project activities and deliverables. The sponsor shall authorize the project and assign the project manager when they approve this project charter.

Project Management Institute. (2017). A guide to the Project Management Body of Knowledge (PMBOK guide) (6th ed.). Project Management Institute.

Project Charter template from www.projectmanagement.com

3.2 Project Environment

When the business case and the project charter, and later, the project management plan and its subcomponents are prepared, the project environment surrounding the project should be examined thoroughly to delineate the factors that may have a negative or positive impact on the project activities and its outcomes. In PMBOK Guide 6th Edition, this environment is composed of enterprise environmental factors (EEFs) and organizational process assets (OPAs). PMBOK Guide 7th edition refers to them as the project environment. The project environment is composed of two components - internal and external, which are described in detail in the following sections.

3.2.1 Internal Environment

The internal environment in which a project is developed consists of the factors that are internal to the organization, but outside the project itself. These factors include elements such as organizational culture, structure, and governance as well as security and safety measures. Other tangible elements include geographic location as well as distribution of facilities and resources, infrastructure, IT software and hardware, resource availability, and employee capability. The internal environment also includes organizational process assets, which are processes, policies, and procedures as well as organizational knowledge bases (e.g., financial data, historical information, lessons learned, project files from previous projects).

Consider the project charter example above. While we are creating the business case as well as preparing the project charter and project management plans, it would be wise to incorporate all the factors that may affect the mobile app and website optimization project. We should enumerate the main properties of our grocery store chain, some of which are provided below:

- Strategic objectives, mission, and vision
- Organizational values and beliefs
- Cultural norms that influence the relationships among coworkers
- Code of conduct
- The number of employees
- Geographic locations and the size of the stores
- Variety of the products and services sold
- Financial situation

We should also take into account the organizational structure of the headquarters and all the branches. This also helps us identify internal and external stakeholders who are affected by our project and who may affect our project. Additionally, this helps us identify the dependencies among the departmental

units, and also identify internal resources that might need to be utilized to complete the project. Reporting structure inside the organization could influence our project's decision-making and change request processes. When our project needs to utilize hardware and software tools to facilitate the activities, we can obtain them in an expedited way directly from the assets of our organization, which also saves the budget. When we need resources such as human resources, materials, and equipment, since we have already delineated the organizational structure with tasks and responsibilities of each unit, we can benefit from the agreements which have already been made with approved providers and subcontractors. Another advantage of listing all the capabilities of our organizations would be when we establish the project team. If our organization employs business or systems analysts, developers, user interface designers, or testers, we can ask their managers or executive-level managers above these managers to provide these qualified employees with specialized knowledge for our project. This may also reduce the external risks that we may face if we hire them from outside our organization. We will elaborate on the organizational structure in the "Organizational Structure" section below.

3.2.2 External Environment

A project's external environment consists of the factors that exist outside of the organization. It includes market conditions, social and cultural influences and issues, legal restrictions, commercial databases, academic research, government or industry standards, financial considerations, and physical environmental elements.

Figure 3.2 illustrates types of general macro environments and forces that are interrelated and affect organizations: sociocultural, technological, economic, government and political, natural disasters, and human-induced problems that affect industries and organizations. Macro environment refers to the outermost layer of elements in a firm's external environment that can impact a business but are generally beyond the firm's direct control, such as the economy and political activity. This environment can also affect projects conducted by organizations. For example, economic environmental forces generally include such elements in the economy as exchange rates and wages, employment statistics, and related factors such as inflation, recessions, and other shocks—negative and positive. Additional factors include hiring and unemployment, employee benefits, factors affecting organizational operating costs, revenues, and profits, all of which are affected by global, national, regional, and local economies. Politics and governmental policies, international wars, natural disasters, technological inventions, and sociocultural forces could directly affect our organization and the projects or may interact with other forces such as economic forces.

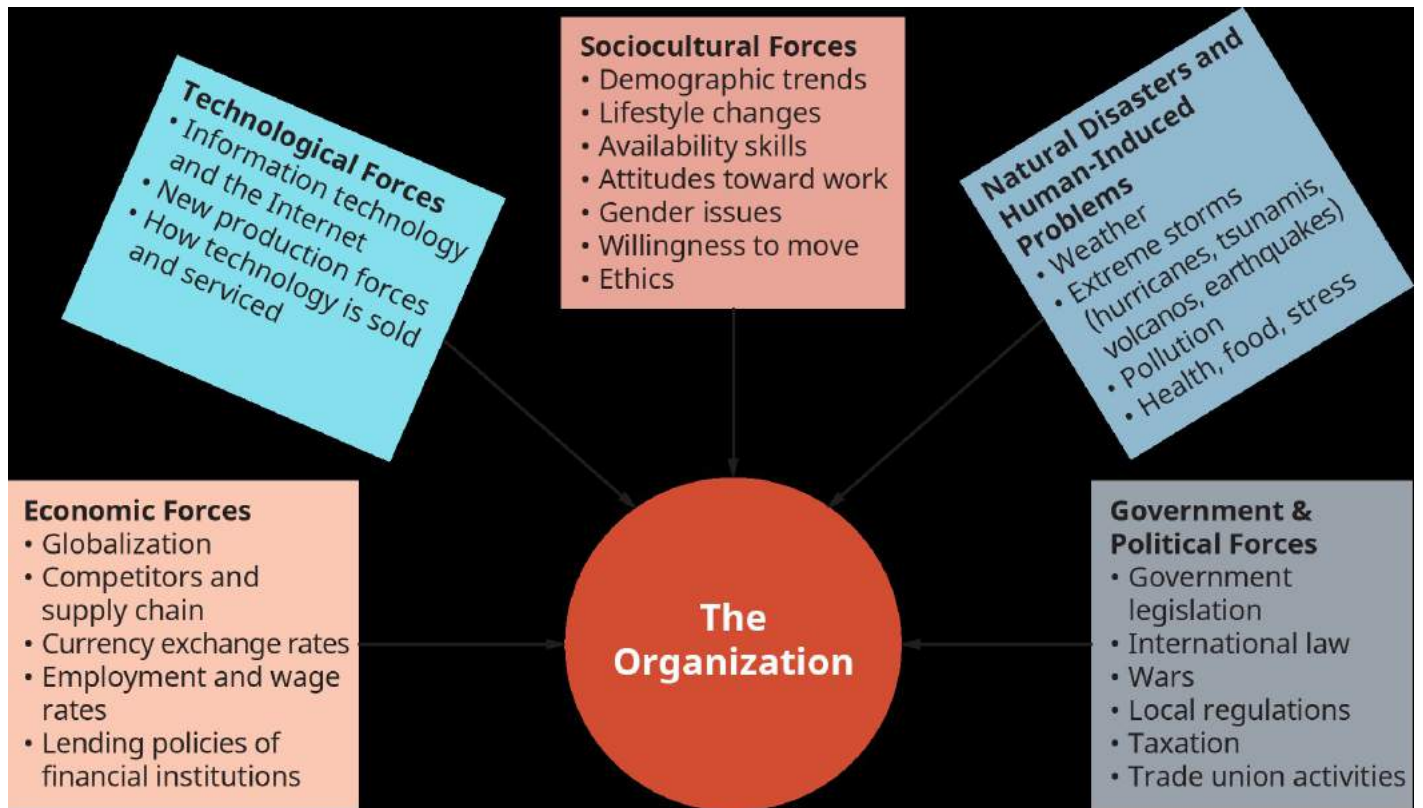

Figure 3.2: Macro Forces and Environments (Attribution: Copyright Rice University, OpenStax, under CC-BY 4.0 license)

Besides the macro environment as explained above and illustrated in Figure 3.2, the micro environment is another external environment element that refers to the middle layer of elements in a firm's external environment, primarily concerned with a firm's industry situation. Harvard strategy professor Michael Porter developed an analysis tool to evaluate a firm's micro environment. Porter's Five Forces is a tool used to examine different micro-environmental groups in order to understand the impact each group has on a firm in an industry (Figure 3.3). In this textbook, we will not explain each factor (See the reference link). However, these five factors, industry rivalry, the threat of new entrants, threat of substitutes, supplier power, and buyer power, could have a substantial influence on a project. Therefore, we should take these external factors into account while assessing the factors that may affect our project from outside the organization.

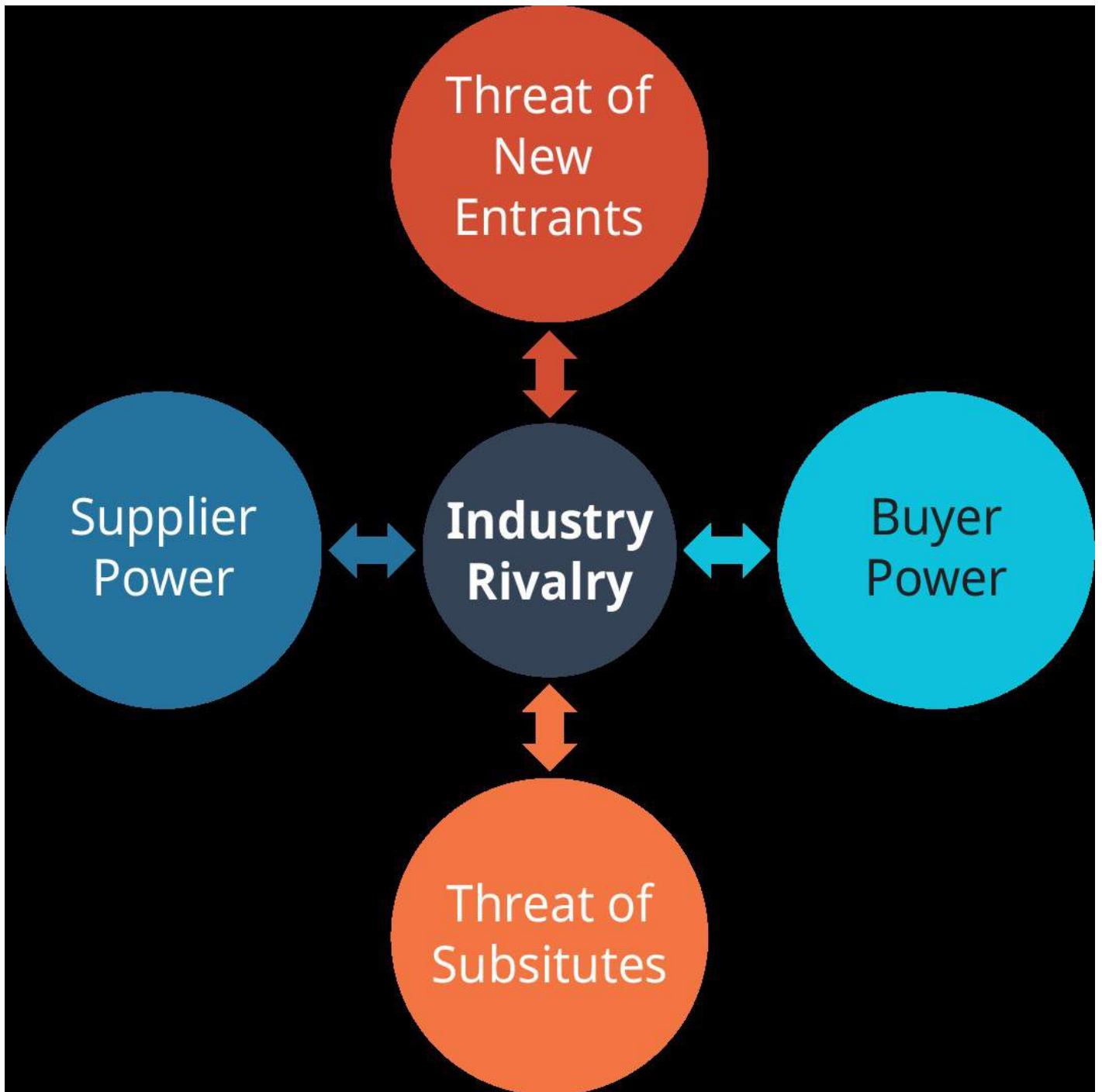

Figure 3.3: Porter's Five Forces Model of Industry Competition (Attribution: Copyright Rice University, OpenStax, under CC-BY 4.0 license)

It is important to keep these external factors in mind when preparing for and managing a project since many if not most of these external factors and any changes in these factors may have negative or positive impacts on projects. They could lead to risks that may put the project activities and deliverables, and the overall project in jeopardy.

Project Management Institute. (2017). A guide to the Project Management Body of Knowledge (PMBOK guide) (6th ed.). Project Management Institute.

Project Management Institute. (2021). A guide to the Project Management Body of Knowledge (PMBOK

guide) (7th ed.). Project Management Institute.

Principles of Management. (2019). Retrieved from

<https://openstax.org/books/principles-management/pages/8-4-a-firms-micro-environment-porters-five-forces?query=micro%20environment&target=%7B%22type%22%3A%22search%22%2C%22index%22%3A0%7D#fs-idm537041840>

3.3 Organizational Dimensions and the Structure

Organizations have formal and informal subsystems that affect everything from big-picture strategic planning and execution to daily operations. Figure 3.4 shows internal organizational dimensions. Formal subsystems include leadership, strategy, management, goals, marketing, operations, technology, and structure. Informal subsystems consist of culture, norms, relationships, politics, and leadership skills. Understanding organizational dimensions - and how projects fit within them - gives project managers insights into managing projects more effectively and efficiently.



Figure 3.4: Internal Organization (Attribution: Copyright Rice University, OpenStax, under CC-BY 4.0 license)

3.3.1 Formal Subsystem

An organization's formal subsystems govern how various tasks are divided, resources are deployed, and how units/departments are coordinated in an organization. An organizational structure includes a set of formal tasks assigned to employees and departments, formal reporting relationship, and a design to ensure effective coordination of employees across departments/units with the help of authority, reliability, responsibility, and accountability, which are fundamental to developing organizational structures and workflow based on their clear understanding by all employees. In short, an organizational structure is the system of task and reporting relationships that control and motivate colleagues to achieve organizational goals. In discussing organizational structure, the following principles are important:

1. Authority is the ability to make decisions, issue orders, and allocate resources to achieve desired outcomes. This power is granted to individuals (possibly by the position) so that they can make full decisions.
2. Reliability is the degree to which the project team member can be dependent to ensure the success of the project with a sound and consistent effort.
3. Responsibility is an obligation incurred by individuals in their roles in the formal organization to effectively perform assignments or to work on the success of the project with or without guidance or authorization.
4. Accountability refers to the extent to which an individual or project team is answerable to the project stakeholders and provides visible evidence of action.

Authority and responsibility can be delegated to lower levels in the organization, whereas accountability usually rests with an individual at a higher level.

An organizational structure outlines the various roles within an organization, which positions report to specific individuals or departments, and how an organization segments its operations into a discrete department. An organizational structure is an arrangement of positions that is most appropriate for the company at a specific point in time. Given the rapidly changing environment in which organizations operate, a structure that works today might be outdated tomorrow. That's why we hear so often about organizations restructuring—altering existing organizational structures to become more competitive/efficient once conditions have changed.

Organizational structures can be categorized in terms of a spectrum of a project manager's authority. This spectrum includes three main types as below:

1. Functional (Centralized)
2. Matrix
3. Project-oriented / Projectized

As illustrated in Figure 3.5, the project manager's authority is none or little in a functional organization whereas it is high to almost total in a project-oriented organization. However, each of the organization types has advantages and disadvantages, and some organizations can even be a mix of multiple types.

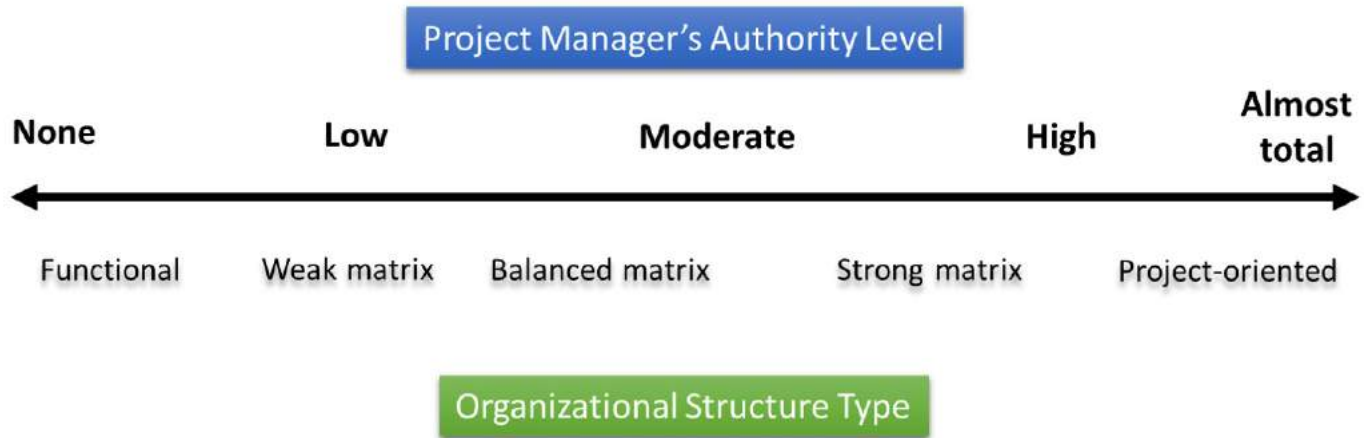

Figure 3.5: The Spectrum of Organizational Structure Types based on Project Manager's Authority Level

A functional organization has workgroups arranged by the tasks and jobs being performed by specialized departments such as manufacturing, marketing and sales, human resources, and finance as seen in Figure 3.6. Since there is not any project management department or office, a project manager or a coordinator is generally selected from the department that is primarily responsible for conducting a given project. However, this person may not have a designated project manager or coordinator role, and their service in this role is often temporary until the project is completed. This department is generally the main beneficiary of the project or it is the implementing department. For example, if the project's goal is to improve customer service, a project manager can be selected from among senior or experienced employees, who is also considered as a subject matter expert in the topic of the project, from the "Customer Service" division under the "Marketing & Sales" department. This person may not work full time as a project manager as they may still carry out the routine tasks of their division and department. Additionally, this project manager would be under the supervision of the "Marketing & Sales" department manager. When they need human resources and other resources, they may not be able to directly obtain them but should negotiate with their manager (Marketing & Sales department in our case) and other department managers (e.g., Manufacturing, Finance). Thus, the project budget is managed by the functional manager, not the project manager. Moreover, the project team may not have administrative staff. Therefore, the project manager may use their department's administrative staff on a part-time basis. The main advantage of this organization type is that the project manager can acquire qualified and experienced human resources from other functional departments.



Figure 3.6: Functional Organization Type

When we move to the right on the spectrum (Figure 3.5), we can arrive at a weak matrix organization where functional units still exist but the role of project manager also becomes more well-defined, and might even be its own role within the organization. In a weak matrix, the project manager still works part-time in their department while they have more authority than they have in a functional organization, but at a low level (Figure 3.7).

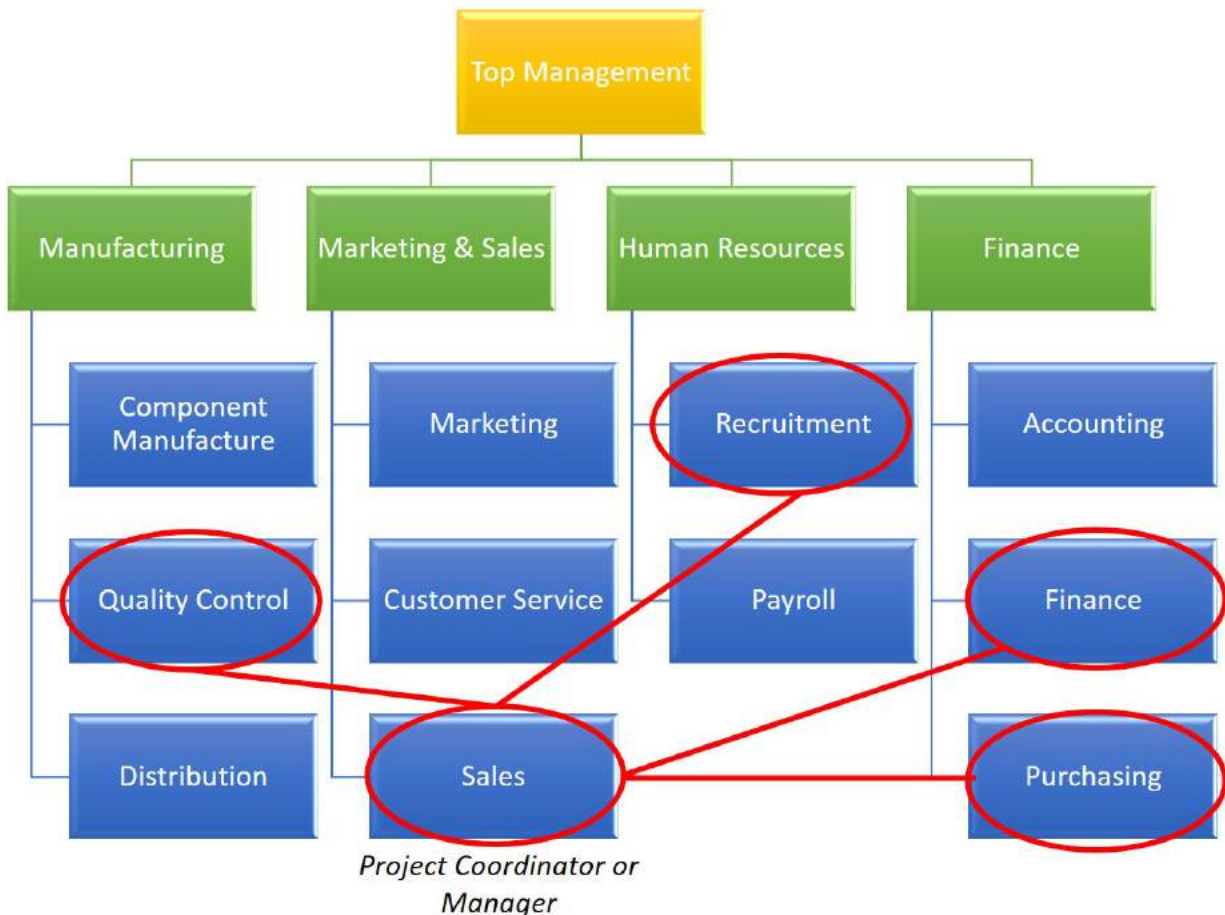

Figure 3.7: Weak Matrix Organization Type

As we continue across the spectrum, we now have a balanced matrix organization type in which we may have a designated project manager with a higher authority. The project manager may manage the project budget to some extent, not completely, although the functional manager has still more say.

As illustrated in Figure 3.8, in a strong matrix organization type, a Project Management Office (PMO) or a designated program management office is added besides functional departments. This department employs full-time project managers with a designated job role. They manage the project budget, and their authority becomes moderate to high. They can also have a full-time administrative staff. This organizational structure may be preferred by many project managers since they can acquire qualified and experienced team members from functional departments inside the organization while they have higher levels of authority.



Figure 3.8: Strong Matrix Organization Type

In a project-oriented or projectized organization type, tasks are arranged by projects, not functions (Figure 3.9). Project managers work independently with a very high authority having full-time designated job roles. However, they may have some challenges while acquiring human resources and other resources since the organization doesn't have specialized departments where skilled and experienced employees work.

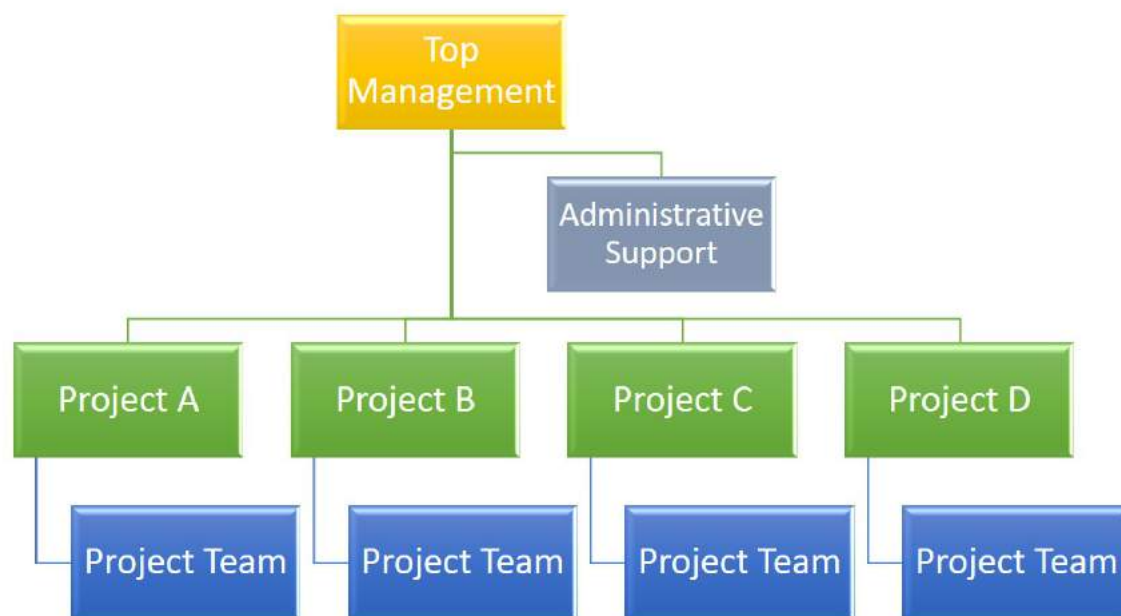

Figure 3.9: Project-Oriented Organization Type

3.3.2 Informal Subsystem

When working with internal stakeholders (those who are inside an organization) and external stakeholders (those who are outside an organization) on a project, it is essential to pay close attention to the hierarchy and authority relationships, relationships, context, history, and the corporate or organizational culture. Organizational (corporate) culture refers to the beliefs, attitudes, and values that the organization's members share and the behaviors consistent with them (which they give rise to). Organizational culture sets one organization apart from another and dictates how members of the organization will see you, interact with you, and sometimes judge you. Often, projects also have a specific culture, work norms, and social conventions (see Chapter 6).

An organization's culture is defined by the shared values and meanings its members hold in common and that is articulated and practiced by an organization's leaders. Purpose, embodied in corporate culture, is embedded in and helps define organizations. Ed Schein, one of the most influential experts on culture, also defined organizational corporate culture as "a pattern of shared tacit assumptions learned or developed by a group as it solves its problems of external adaptation and internal integration that have worked well enough to be considered valid and, therefore, to be taught to new members as the correct way to perceive, think, and feel in relation to those problems." Some aspects of organizational culture are easily observed; others are more difficult to discern. We can easily observe the office environment and how people dress and speak. In one company, individuals work separately in closed offices; in another, teams may work in a shared environment. The subtler components of

organizational culture, such as the values and overarching business philosophy, may not be readily apparent, but they are reflected in member behaviors, symbols, and conventions used. Organizational culture can give coworkers a sense of identity through which they feel they are an indispensable component of a larger and strong structure.

Some cultures are more conducive to project success than others. As a project leader, it is very important to understand the unique nature of the corporate culture that we operate in. This understanding allows us to put in place the processes and systems most likely to lead to project success.

Organizational culture is considered one of the most important internal dimensions of an organization's effectiveness criteria. Peter Drucker, an influential management guru, once stated, "Culture eats strategy for breakfast." He meant that corporate culture is more influential than strategy in terms of motivating employees' beliefs, behaviors, relationships, and ways they work since culture is based on values. Strategy and other internal dimensions of an organization are also very important, but organizational culture serves two crucial purposes: First, culture helps an organization adapt to and integrate with its external environment by adopting the right values to respond to external threats and opportunities. Secondly, culture creates internal unity by bringing members together so they work more cohesively to achieve common goals. Culture is both the personality and glue that binds an organization. It is also important to note that organizational cultures are generally framed and influenced by the top-level leader or founder. This individual's vision, values, and mission set the "tone at the top," which influences both the ethics and legal foundations, modeling how other officers and employees work and behave. A framework used to study how an organization and its culture fit with the environment is offered in the Competing Values Framework (Figure 3.10).

Competing Values Framework Cameron & Quinn (1999)

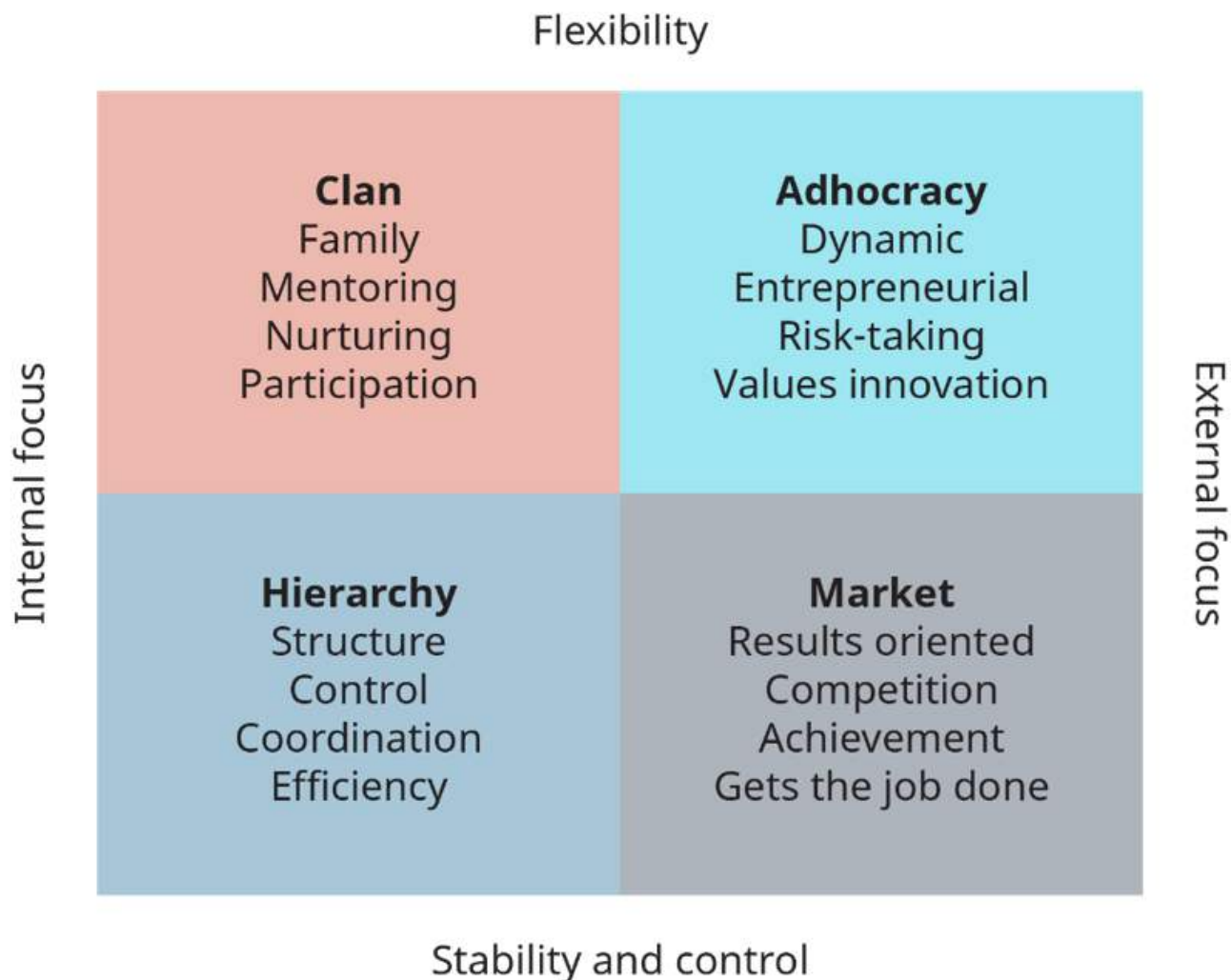

Figure 3.10: The Competing Values Framework as adapted from K. Cameron and R. Quinn, 1999. Diagnosing and Changing Organizational Culture, Addison-Wesley, p. 32.

(Attribution: Copyright Rice University, OpenStax, under CC-BY 4.0 license)

Assume that you are leading a project in an organization with a hierarchical culture. Projects are about changing the way an organization operates. Introducing change in an organization with this type of culture can be very challenging because they value caution, conservative approaches, and careful decision-making. If the project you are leading involves the introduction of innovative practices and technologies, it may be very difficult and time-consuming to get the approvals required to proceed with the project at its various stages. Innovative practices are not guaranteed to work; success requires a high degree of risk tolerance in decision-making processes. This may be difficult to achieve in organizations with this type of culture. Furthermore, the already aggressive schedule of employees in hierarchal organizations may not be able to accommodate the potential numerous and lengthy deliverable reviews required for innovative projects, causing project success to be viewed as unachievable. Project leaders in this type of culture are wise to speak openly and candidly about the

project's risks and plan for additional deliverable reviews as a way of setting the project up for success. If this very same innovative project was being delivered in an organization with a market culture, the decision-making approach and the schedule are likely to be fundamentally different.

Schein, E. (2017). *Organizational culture and leadership*, 5th ed., Hoboken, N.J.: John Wiley & Sons.

Hyken, S. (2015, December 5). Drucker said culture eats strategy for breakfast. *Forbes*.

<https://www.forbes.com/sites/shephyken/2015/12/05/drucker-said-culture-eats-strategy-for-breakfast-and-enterprise-rent-a-car-proves-it/#7a7572822749>

3.4 Project Management Office (PMO)

A project management office (PMO) is an organizational structure that standardizes the project-related governance processes and facilitates the sharing of resources, methodologies, tools, and techniques. The responsibilities of a PMO can range from providing project management support functions to the direct management of one or more projects.

Many large and even medium-sized organizations have created a department to oversee and support projects throughout the organization. This is an attempt to reduce the high number of failed projects. These offices are usually called PMO. The PMO may be the home of all the project managers in an organization, or it may simply be a resource for all project managers, who report to their line areas. PMBOK Guide 6th Edition categorizes PMOs as supportive, controlling, and directive. Supportive PMOs provide a consultative role while controlling PMOs provide support and require compliance through various means. Directive PMOs have full-time project managers who participate in the projects and manage directly by taking full control of the projects.

In general, PMOs help ensure that projects are aligned with organizational objectives, provide templates and procedures for use by project managers, provide training and mentorship, provide facilitation, stay abreast of the latest trends in project management, and serve as a repository for project reports and lessons learned.

Project Management Institute. (2017). A guide to the Project Management Body of Knowledge (PMBOK guide) (6th ed.). Project Management Institute.

3.5 Key Takeaways

Key Takeaways

- The official selection of a project based on the alignment of its business case with project selection criteria is followed by the development of a project charter that authorizes the project manager to apply organizational resources in order to achieve the project's objectives.
- A project charter consists of high-level content about a project such as a project purpose, measurable project objectives, high-level requirements, key deliverables, constraints, assumptions, overall project risks, summary milestone schedule, preapproved financial resources, key stakeholder list, project approval requirements, project exit criteria, project team members, and the information regarding the sponsor. A project charter provides the project manager with the authority to apply organizational resources to project activities. It is signed off by the project sponsor.
- A project is significantly affected by the environment comprised of internal and external factors. These factors should be taken into account while developing a business case, and while initiating, planning, executing and closing a project.
- Organizational structure, as an internal environmental factor, plays a critical role in projects as they are an indispensable part of the organization they belong to. The formal subsystem of the organizational structure consists of three main organization types, that are functional, matrix, and project-oriented. The informal subsystem includes the organizational culture which sets one organization apart from another with the beliefs, attitudes, and values the organization's members share.

3.6 Questions and Exercises

There are 10 questions for this chapter. As you submit each answer, you will get immediate feedback and be taken to the next question.

An interactive or media element has been excluded from this version of the text. You can view it online here:

<https://pressbooks.ulib.csuohio.edu/project-management-navigating-the-complexity/?p=151>

3.7 Attribution

This chapter is a derivative of the following texts:

1. [Project Management by Adrienne Watt](#). © [CC BY \(Attribution\)](#).
2. [Project Management from Simple to Complex](#). © [CC BY \(Attribution\)](#).
3. [Project Management by Florence Daddey](#). © [CC BY \(Attribution\)](#).
4. [Project Management Fundamentals by Shelly Morris](#). © [CC BY \(Attribution\)](#).
5. [Project Management by Merrie Barron and Andrew R. Barron](#). © [CC BY \(Attribution\)](#).
6. [Principles of Management](#) © [CC BY \(Attribution\)](#).

Chapter 4. Project Planning and the Project Scope

4.0 Learning Objectives and Overview

Learning Objectives

1. Describe the importance and purpose of project planning.
2. Identify the basic processes and activities required in the planning phase.
3. Explain the main components of requirements elicitation.
4. List the main components of a project management plan.
5. Describe the process to develop a detailed description of the project.
6. Elaborate on the WBS structure to subdivide project deliverables and project work into smaller, more manageable components.
7. Practice on Microsoft Project to create a WBS.

4.0 Overview

After the project charter is approved by the sponsor, the project manager is appointed as the primarily responsible authority to utilize the budget and resources, define the primary components of the project such as scope, cost, schedule, quality, and risks, manage, control and monitor project activities, and finally close the project. From now on, the project manager is ready to enter the second phase in the project management life cycle. This is referred to as the planning phase, which directly follows the initiation phase. The planning phase involves creating a set of plans to help guide the team through the execution and closure as well as the monitoring and controlling which occurs throughout the whole project. The plans created during this phase help the project manager and the team manage triple (iron triangle) constraints, which are scope, schedule and cost, and other constraints such as quality, resources, and risks, and other related issues and knowledge areas (e.g., integration, procurement, stakeholders, communication). They also help the project manager lead the project team and work with external suppliers to ensure that the project deliverables can be delivered on time, within budget, and with the desired functionality.

4.1 Project Planning

Planning consists of the processes required to establish the scope of the project, refine the objectives, and define the course of action required to attain the objectives that the project was undertaken to achieve. Although most of the project effort (i.e., making use of the workforce and other resources) is spent during the execution phase that occurs after the planning phase, project managers and their teams face the most challenging tasks and perform many processes during the planning phase. The project planning phase is often the most challenging phase for a project manager, as the project manager is often required to make educated guesses about the team members, resources required for all the activities, and the schedule and budget needed to complete the project. In addition, the planning includes communications and procurement activities, as well as planning contracts with any third-party suppliers.

Thorough and proper planning helps the team have a smoother execution process with a better prediction level. However, it is of high importance to keep in mind that predictability is at low levels in many projects in terms of scope (requirements and project activities), schedule, budget, and risks. This is why agile (adaptive) project management comes to the forefront, which started in the 1990s with software projects and extended to information systems projects over time, and other fields such as, but not limited to, new product development, high technology projects, and start-ups. Agile project management will be discussed in Chapter 12 “Agile (Adaptive) Project Management”.

Project planning is at the heart of the project life cycle and tells everyone involved where the project is going and how the team is going to get there. It involves creating a set of plans to help guide the team through the implementation and closure phases of the project. The plans created during this phase help the project team manage time, cost, quality, changes, risk, and related issues. The purpose of the project planning phase is to:

- Provide guidance and direction on how scope, schedule, cost, quality, resources, communications, risks, procurements, and stakeholders will be managed throughout the project,
- Refine and elaborate on the SMART (Specific, Measurable, Achievable, Relevant, Time-based) objectives, establish the business, stakeholder, solution, and transition requirements, and translate them to project activities by defining the scope and create WBS (Work Breakdown Structure),
- Develop project schedule by defining and sequencing project activities and milestones, and by estimating activity durations.
- Determine resources, identify risks based on the requirements and activities, and eventually estimate costs and determine project budget,
- Identify the methods to track, review, and regulate the progress and performance of the

- project (e.g., EVM - Earned Value Management),
- Communicate and collaborate with all the stakeholders, and obtain the approval of the sponsor and the client, and proceed to the next phase, which is the implementation (execution) phase.

Project managers identify the work to be done for the project in collaboration with the stakeholders including the project sponsor, team members, relevant functional departments of our organization, end-users, customers, regulatory organizations, and government agencies - in short, all the stakeholders that are affected by or are affecting the overall project or at least one activity, decision or outcome. Once the major components of the project are known, the project manager can assign those in the team who will carry out the detailed planning of the project's sub-components. The lowest level manageable activities are called "work packages" in predictive (waterfall) methodology. We will discuss Work Breakdown Structure (WBS) which is composed of work packages in its section below. In agile methods and frameworks, especially in Scrum, which is the most common agile framework utilized by organizations worldwide, "sprints", "timeboxes", or "cycles" are used with compressed life cycle stages (see Chapter 12).

The planning phase refines the project's objectives in the Project Charter, which were identified at higher levels during the initiation phase. This phase also includes planning the steps necessary to meet those objectives by further identifying the specific activities and resources required to complete the project. Once the project objectives have been fully recognized, they must be clearly articulated, specifically developing each of them according to the SMART protocol. These objectives would lead to the identification and elaboration of product requirements in line with the project deliverables. Often, the very act of describing a project's objectives using detailed, precise language allows us to better understand the project's scope. This articulation serves as the basis for the development of requirements. What this means is that, after an objective has been clearly articulated, it can be described in concrete (measurable) terms and the steps to achieve it are easier to identify. If a poor job is done of articulating the objectives, the requirements will be misdirected, and the resulting project will not represent the true need.

In general, the planning phase involves three fundamental components: Identifying the scope, preparing the schedule, and estimating the costs. These are triple constraints that also serve as our baselines throughout the project to measure the project's success. After these activities are complete, it is a good time to identify and try to deal with anything that might pose a threat or an opportunity to the successful completion of the project. This is called risk management. In risk management, the threats and opportunities are identified along with the action that is to be taken as a response in order to optimize the likelihood of project success (see Chapter 10). In the initiation phase, a preliminary list of project stakeholders was identified. During the planning phase, the list is reviewed to ensure that it remains current and stakeholders continue to be prioritized. Stakeholder engagement is a critical success factor, and communication plays a key role in this engagement. Effective project leaders spend about 90% of their time on a project communicating with stakeholders. An effective communication plan is one of the tools used to ensure stakeholders remain informed and supportive of the project's objectives (see Chapters 5 and 6).

In some instances, organizations need to obtain products and utilize services from outside of the organization. Overseeing these transactions is known as procurement management. During the planning stage, procurement management involves identifying the type of vendors required and the selection criteria to be used. Finally, project managers ensure that the team understands the quality expectations of the stakeholders. In order to fulfill these expectations, a quality management plan is developed to identify quality targets, assurance, and control measures, along with an acceptance plan.

Throughout all these project planning activities, it is the job of the Project Manager to integrate the team's planning efforts—a process known as integration management. Developing a project charter and a project management plan are two processes of seven processes carried out within the project integration management. Project managers should assure that all the necessary processes and activities are included to identify, define, combine, unify, and coordinate the various process and project management activities. They should manage the interdependencies among all the project management knowledge areas. Consequently, a comprehensive project plan should be created to ensure all the various management plans identified above are cohesive and well-aligned.

In this chapter, we will elaborate on the development of a project scope management plan including requirements management. Other subcomponents of the project management plan will be explained in their respective chapters (e.g., project communications management plan in Chapter 6; project schedule management plan in Chapter 8).

Project Management Institute. (2017). *A guide to the Project Management Body of Knowledge (PMBOK guide) (6th ed.)*. Project Management Institute.

Project Management Institute. (2017). *A guide to the Project Management Body of Knowledge (PMBOK guide) (6th ed.)*. Project Management Institute.

Project Management Institute. (2017). *A guide to the Project Management Body of Knowledge (PMBOK guide) (6th ed.)*. Project Management Institute.

Project Management Institute. (2017). *A guide to the Project Management Body of Knowledge (PMBOK guide) (6th ed.)*. Project Management Institute.

4.2 Eliciting Requirements

After all the deliverables are identified, the project manager needs to document all the requirements of the project. While PMBOK Guide 6th Edition refers to this process as “Collect Requirements”, BABOK Guide v3 refers to elicitation. Elicitation is more than just collecting. As BABOK Guide states “It is the drawing forth or receiving of information from stakeholders or other sources. It is the main path to discovering requirements and design information, and might involve talking with stakeholders directly, researching topics, experimenting, or simply being handed information.” BABOK Guide defines a requirement as a usable representation of a need. The nature of the representation may be a document (or set of documents) but can vary widely depending on the circumstances.

The requirement is defined by the PMI Guide to Business Analysis as “a condition or capability that is required to be present in a product, service, or result to satisfy a contract or other formally imposed specification.” The responsibility for defining requirements should be assigned to resources that have sufficient business subject matter expertise and decision-making authority. Project teams consist of business analysts who are involved in the elicitation of requirements. There may be other job titles that perform business analysis. These titles were enumerated by BABOK Guide as business architect, business systems analyst, data analyst, enterprise analyst, management consultant, process analyst, product manager, product owner, requirements engineer, and systems analyst.

A project manager must assure that requirements are defined in a way that project activities can be determined and sequenced, and hence, a schedule and budget can be created. As quoted by the Business Analysis for Practitioners: A Practice Guide, “inaccurate requirements gathering” was reported by 37% of organizations as a primary cause of project failure. Poor requirements management practices were identified as the second leading cause of project failure, second only to changing organizational priorities. Therefore, project managers need to ensure that all the stakeholders have been identified so that requirements can be elicited thoroughly from all of them, and all the expectations and concerns can be addressed.

A requirement represents something that can be met by a product, service, or process, and can address a need of the business, person, or group of people. A requirement should be independent of the design of the solution that addresses it. A requirement may explain a feature that is to be met by a product or software component. The project’s requirements, defined in the scope management plan, describe what a project is supposed to accomplish and how the project is supposed to be created and implemented. Requirements may include attributes like dimensions, ease of use, color, specific ingredients, and so on.

When a specific type of requirement is under discussion, the term requirement is preceded by a qualifier such as stakeholder, business, or solution. The hierarchical relationship among requirements can be illustrated in Figure 4.1.

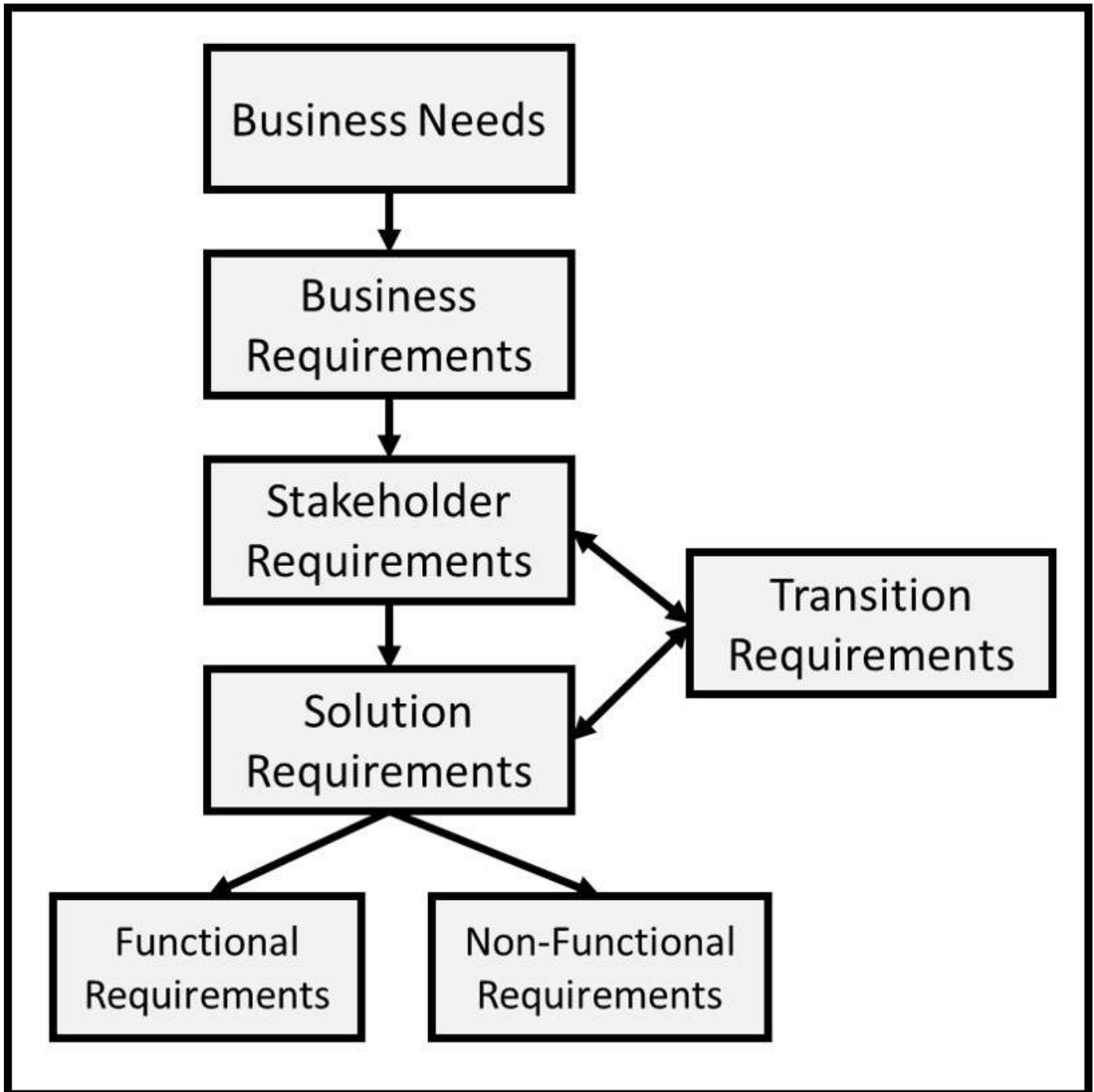

Figure 4.1: Relationships between Requirements

(Adapted from "Requirements Classification Schema" in "A Guide to the Business Analysis Body of Knowledge® - BABOK® guide", version 3.0)

As illustrated in Figure 4.1, business requirements are developed based on the business needs (problems or opportunities) that an organization is striving to find a solution to overcome the problem or exploit the opportunity. As discussed with examples in Chapter 2, objectives should be SMART (Specific, Measurable, Achievable, Relevant, Time-based). Project Managers should also consider this SMART protocol while creating requirements, especially when getting into greater detail about business requirements. Requirements must be measurable, testable, related to identified business needs or opportunities, and defined to a level of detail sufficient for system design. Moving down, as

illustrated in Figure 4.1, means that requirements are determined in a hierarchy starting from the business requirement at the top, and elaborating on them with stakeholder requirements, and solution requirements. Besides these three requirement types which are structured in a hierarchy, there is a fourth type called transition requirements.

Business requirements are the needs of the internal or external client, always from a management perspective. They are the statements of goals, objectives, and outcomes that describe why a change has been initiated. They can apply to the whole of an enterprise, a business area, or a specific initiative. Business requirements are statements of the business rationale for the project. They are usually expressed in broad outcomes, satisfying the business needs, rather than specific functions the system must perform. These requirements grow out of the vision for the product that, in turn, is driven by mission (or business) goals and objectives. We can define our business requirements as below:

- A mobile application shall be used by customers of our grocery stores.
- Customers should access the mobile website and applications on their smartphones and tablets, and complete the purchase.

In our Project Charter example in Chapter 3, the high-level requirements were as follows. They can be considered either business requirements or stakeholder requirements.

- The mobile website and smartphone application shall:
 - Include all the functions that a desktop website possesses.
 - Be accessed with the same login username and password.
 - Synchronize the customer profile and the cart with the desktop website.

In order to elicit the requirements, a team should dig deep by implementing various techniques such as interviews, surveys, focus group meetings, observations, and document analysis. In organizations, business analysts or other positions performing the tasks of a business analyst perform these techniques to ensure that they can address the need from the perspective of stakeholders (e.g., customers, end-users). Stakeholder requirements serve as a bridge between business and solution requirements. In our m-commerce project initiated by Grocery LLC, we can write some of the stakeholder requirements as below:

- **Business Requirement:** A mobile application shall be used by customers of our grocery stores.
- **Stakeholder Requirements:**
 - Customers shall log in to the application by using their usernames and passwords.
 - Customers shall also log in to the application through biometrics identification.
 - Customers shall use their usernames and passwords across all interfaces (mobile application, mobile website, and desktop website).
 - Customer profile information including the name, shipping and billing addresses, and payment accounts shall synchronize across all interfaces (mobile application, mobile website, and desktop website).

- Customers shall browse the items of their choice after selecting the categories or typing on a search box.

After stakeholder requirements are developed, solution requirements can be derived from these stakeholder requirements. They describe the capabilities and qualities of a solution that meets the stakeholder requirements. Thus, they can provide an appropriate level of detail for the development and implementation of the solution. These requirements are divided into two subcategories as functional and non-functional requirements.

Functional requirements describe the characteristics of the final deliverable in ordinary non-technical language. They should be understandable to the customers, and the customers should play a direct role in their development. Functional requirements are what you want the deliverable to do. They describe the capabilities that a solution must have in terms of the behavior and information that the solution will manage.

- **Stakeholder Requirement:** Customers shall log in to the application by using their usernames and passwords.
 - **Functional Solution Requirement:** Customers shall receive a one-time password to their mobile phones as a text message or to their email addresses so that they can type this one-time password on the mobile application or the mobile application can recognize the text message and automatically transfer it to the mobile application.
- **Stakeholder Requirement:** Customer profile information including the name, shipping and billing addresses, and payment accounts shall synchronize across all interfaces (mobile application, mobile website, and desktop website).
 - **Functional Solution Requirement:** The profile page consists of the fields “First Name”, “Middle Name”, “Last Name”, “Gender”, “Street Address”, “Apartment/Suite Number”, “City”, “State”, “Zip Code”, “Mobile Phone Number”, “Other Phone Number”, “Debit/Credit Card Number”, “Debit/Credit Card Expiration Date”, and “Debit/Credit Card Security Code”.
 - **Functional Solution Requirement:** When customers type new information or edit existing information in their profile pages on only one of the interfaces, this information will be updated immediately on other interfaces.

Non-functional requirements or quality of service requirements do not relate directly to the behavior or functionality of the solution, but rather describe conditions under which a solution must remain effective or qualities that a solution must have. End users cannot see directly on the mobile application how these requirements are met.

- **Stakeholder Requirement:** Customers shall view the total price of the items they added to their cart, and shall checkout by entering their addresses and payment information.
 - **Non-Functional Solution Requirement:** The system shall confirm the validity of the payment tool (debit or credit card), and carry out the transaction securely by blocking

any breach from outside the system.

The last requirement type is the transition requirements (Figure 4.1). These requirements describe the capabilities that the solution must have and the conditions the solution must meet to facilitate transition from the current state to the future state, but which are not needed once the change is complete. They describe temporary capabilities such as data conversion, training and business continuity requirements. They are essential for the organizational readiness to make the project outcomes and deliverables operational. In our m-commerce project, some transition requirement examples can be outlined as below:

- **Functional solution requirement:** Customers shall be able to chat with and have a phone call with call center agents and customer service representatives when they need to contact due to any issues or demands related to the mobile application.
- **Transition requirements:** Before mobile application becomes operational, it shall be ensured that:
 - Employees in call centers shall be trained to effectively find solutions to the customers' requests through the mobile application.
 - Call centers shall be equipped with the necessary hardware and software tools to support customers who do their shopping on the mobile application.
 - Call centers shall be supported via a stable and fast network connection.
 - The call center database shall be hosted in a cloud server with a backup option.

The effective specification of requirements is one of the most challenging undertakings project managers face. Inadequately specified requirements will usually lead to poor project results.

Documenting requirements is much more than just the process of writing down the requirements as the user sees them; it should cover not only what decisions have been made, but why they have been made, as well. Understanding the reasoning that was used to arrive at a decision is critical in avoiding repetition. For example, the fact that a particular feature has been excluded, because it is simply not feasible, needs to be recorded. If it is not, then the project risks wasted work and repetition, when a stakeholder requests the feature be reinstated during development or testing.

Once the project requirements are documented, the next step is for key stakeholders to sign off on the requirements to confirm that everyone is operating with the same set of expectations. While the project manager is responsible for making certain the requirements are documented, it does not mean that the project manager performs this task. The project manager enlists the help of all the stakeholders (business analysts, requirement analysts, business process owners, customers, and other team members) to conduct the discussions, brainstorming, and interviews, and to document and sign off the requirements. As with many aspects of project management, the project manager is responsible only for enabling the process and facilitating it. If the project manager feels that the quality of the document is questionable, their duty is to stop the development process.

The project manager reviews the requirements, incorporates them into the project documentation

library, and uses them as input for the project plan.

International Institute of Business Analysis. (2015). A guide to the Business Analysis Body of Knowledge (BABOK guide), version 3.0. Toronto, Ont: International Institute of Business Analysis.

Business Analysis for Practitioners: A Practice Guide (2015). Project Management Institute.

Business Analysis for Practitioners: A Practice Guide (2015). Project Management Institute.

International Institute of Business Analysis. (2015). A guide to the Business Analysis Body of Knowledge (BABOK guide), version 3.0. Toronto, Ont: International Institute of Business Analysis.

International Institute of Business Analysis. (2015). A guide to the Business Analysis Body of Knowledge (BABOK guide), version 3.0. Toronto, Ont: International Institute of Business Analysis.

International Institute of Business Analysis. (2015). A guide to the Business Analysis Body of Knowledge (BABOK guide), version 3.0. Toronto, Ont: International Institute of Business Analysis.

International Institute of Business Analysis. (2015). A guide to the Business Analysis Body of Knowledge (BABOK guide), version 3.0. Toronto, Ont: International Institute of Business Analysis.

International Institute of Business Analysis. (2015). A guide to the Business Analysis Body of Knowledge (BABOK guide), version 3.0. Toronto, Ont: International Institute of Business Analysis.

4.3 Requirements Traceability Matrix

The project team should link the requirements to the activities and deliverables that satisfy them during the project. Requirements traceability matrix is a common structure that is used by project teams. It also shows each requirement's relationship to other requirements. Traceability is used to help ensure that the solution conforms to requirements and to assist in scope, change, risk, time, cost, and communication management. A formal traceability matrix is usually built hierarchically, starting with high-level requirements and filling in the details as the requirement is progressively elaborated. This hierarchy is similar to an outline that is filled in as more detail is known.

This matrix can include the information regarding:

- Requirement ID
 - A unique identifier
- Associate ID
 - A unique identifier for requirements associated with higher-level requirements
- Requirement category
- Requirement description
 - A textual description of the requirement
- Current status
 - E.g., active, canceled, deferred, added, approved, assigned, completed.
- Status date
- Business needs, goals, and objectives
 - To address the rationale of inclusion
- Project objectives
 - To address the rationale of inclusion
- WBS number
 - The relationship of the requirement with project activities and milestones
- Design ID
 - The relationship of the requirement with the design elements
- Build ID
 - The relationship of the requirement with an implementation of a specific feature
- Test strategy and test scenarios (e.g., technical/system case tests, user/acceptance case tests)
 - Test cases that will validate that the built features perform as required by the requirements.

Let's create a small version of the requirements traceability matrix for Grocery LLC's m-commerce project.

- ID (1): Customers shall log in to the application by using their usernames and passwords.
- ID (2): Customer profile information including the name, shipping and billing addresses, and payment accounts shall synchronize across all interfaces (mobile application, mobile website, and desktop website).

Table 4.1: Requirements Traceability Matrix

ID	Associate ID	Requirements Description	Current Status	WBS	Design ID	Build ID	Test case
1	1.1	Customers shall receive a one-time password to their mobile phones.	Active	2.2 3.2	D3 D6	B3 B8	Case 2
	1.2	Customers shall be able to prefer signing in to the mobile application by swiping their fingerprints on their smartphones.	Active	2.2 3.2	D3 D6	B3	Case 3
2	2.1	The profile page consists of the fields "First Name", "Middle Name", "Last Name", "Gender", "Street Address", "Apartment/Suite Number", "City", "State", "Zip Code", "Mobile Phone Number", "Other Phone Number", "Debit/Credit Card Number", "Debit/Credit Card Expiration Date", and "Debit/Credit Card Security Code".	Active	2.2 4.4 5.2	D2	B2	Case 6
	2.2	When customers type new information or edit existing information in their profile pages on only one of the interfaces, this information will be updated immediately on other interfaces.	Active	2.2 4.4 5.2	D2 D9	B2	Case 7

International Institute of Business Analysis. (2015). A guide to the Business Analysis Body of Knowledge (BABOK guide), version 3.0. Toronto, Ont: International Institute of Business Analysis.

Business Analysis for Practitioners: A Practice Guide (2015). Project Management Institute.

4.4 Project Scope Management

Before starting the implementation of any project activities, the project team needs to know exactly what work has to be done. Therefore, the team needs to plan first to provide guidance and direction on how the scope will be managed throughout the project. In this very beginning process, the project team creates a scope management plan that documents how the project and product scope will be defined, validated, and controlled. Project managers should coordinate the responsibilities of each team member. In order to do so, they should know exactly what they're going to do to meet the project's objectives. Therefore, the scope planning process is the very first thing to be done. Project scope planning is concerned with the definition of all the work needed to successfully meet the project objectives. Project managers and teams should have a clear picture of all the work that needs to happen on their projects, and as the project progresses, they should ensure that the scope is up to date.

4.4.1 Defining the Scope

We already have a head start on refining the project's objectives in quantifiable terms, but now we need to plan further and write down all the intermediate and final deliverables that we will produce over the course of the project. Deliverables include everything that we produce for the project (i.e., anything that the project will deliver). The deliverables for the project include all of the products or services that we are performing for the internal or external clients, and/or the end-users and customers. They include every intermediate document, plan, schedule, budget, blueprint, and anything else that will be made along the way, including all of the project management documents that are put together. Project deliverables are tangible outcomes, measurable results, or specific items that must be produced to consider either the project or the project phase completed. Intermediate deliverables, like the objectives, must be specific and verifiable.

All deliverables must be described in a sufficient level of detail so that they can be differentiated from related deliverables. For example:

- A twin-engine plane versus a single-engine plane
- A red marker versus a green marker
- A daily report versus a weekly report
- A departmental solution versus an enterprise solution

In our case of m-commerce project carried out by Grocery LLC, there are two main deliverables which are:

1. A mobile application that can be installed on Android and IOS smartphones.
2. A mobile website optimized for Android and IOS smartphones.

We should also define what is not included in the project's scope. M-commerce project doesn't directly target tablets since their screen size would allow them to display the regular desktop website. Besides, the smartphone application can be used in tablets. Besides, smartphones with operating systems other than Android and IOS are excluded.

One of the project manager's primary functions is to accurately document the deliverables of the project and then manage the project so that they are produced according to the agreed-on criteria. Deliverables are the output of each development phase, described in a quantifiable way to assure measurability. In our case study, project objectives have been provided to ensure measurability:

1. To redesign the website in 2 months so it's more responsive and easier for the customers to place orders on their smartphones.
2. To create a new mobile application in 2 months that can work in both operating systems (Android and IOS).

The process of defining scope generates a "Project Scope Statement". It is the description of the project scope, major deliverables, assumptions, and constraints. The project charter contains high-level information while the project scope statement contains a detailed description of the scope components. The project scope statement documents the entire scope, including project and product scope. Project Scope Statement is composed of the components as outlined below. Readers should always keep in mind that they should create a long and detailed statement when they work as a project manager or a team member on a project in their organizations.

1. **Product scope description**

The mobile application and the mobile website will have the same functions that allow online customers to conveniently do their shopping by browsing, searching, and locating the items they want to purchase, adding them to the cart, specifying the number and weight of the items, choosing the delivery and shipping options, checking out via their payment option, and tracking the items they ordered. The mobile application will work on smartphones having Android and IOS. Customers will use the same username and password they use to access the desktop version. If they leave the application or the website, the items in their cart will not be removed and synchronized with all the interfaces (mobile application, mobile website, and desktop website). If an item's price changes or this item is sold out, they will be notified of this when they access their carts.

2. **Deliverables**

- A mobile application
- Optimized mobile website

3. **Acceptance criteria**

The mobile website and the smartphone app will be subject to alpha testing first. Then, beta testing will follow, where customers can install the beta version on their smartphones and do their online shopping. During the implementation of the beta version, all the feedback from customers and their mobile

devices will be evaluated and the bugs and problems will be corrected. When the mobile website and the app are fully functional, customers should log in with their usernames and passwords, browse items, add them to their carts, proceed to checkout, and complete their payment.

The sponsor must approve the sign-off after they receive the inspection and acceptance report.

4. **Project exclusions**

- This project doesn't directly target tablets since their screen size would allow them to display the regular desktop website. Besides, the smartphone application can be used in tablets.
- Smartphones with operating systems other than Android and IOS are excluded.

4.4.2 Work Breakdown Structure (WBS)

After defining deliverables and requirements, and creating a Project Scope Statement, the next step would be to create a Work Breakdown Structure (WBS) that defines all the activities required to complete the project. The WBS defines the scope of the project and breaks the work down into components that can be scheduled, estimated, and easily monitored and controlled. The idea behind the WBS is simple: dividing a complicated task into smaller tasks until we reach a level that cannot be further subdivided. We stop breaking down the work when we reach a low enough level to perform an estimate of the desired accuracy. At that point, it is usually easier to estimate how long the small task will take and how much it will cost to perform than it would have been to estimate these factors at the higher levels. Each descending level of the WBS represents an increased level of detailed definition of the project work. A WBS also provides the necessary framework for detailed cost estimating and control, along with providing guidance for schedule development and control.

The purpose of developing a WBS is to allow easier management of each component, accurate estimation of time, cost, and resource requirements, easier assignment of human resources, and easier assignment of responsibility for activities.

WBS is a hierarchical decomposition of the project into phases, deliverables, and work packages. It is a tree structure, which shows a subdivision of effort required to achieve an objective. In a project, the WBS is developed by starting with the end objective and successively subdividing it into manageable components in terms of size, duration, and responsibility, which includes all steps necessary to achieve the objective. An example of this hierarchical decomposition can be starting from the highest level which is the project and moving downwards along the systems, subsystems, components, tasks, and subtasks, and stopping when we arrive at the lowest level which is work packages.

The WBS creation involves:

- Listing all the project outputs (deliverables and other direct results)
- Identifying all the activities required to deliver the outputs
- Subdividing these activities into subactivities and tasks
- Identifying the deliverable and milestone(s) of each task

- Considering the usage of all the resources (personnel and material) required to complete each task

WBS formatting can be made through various approaches such as the top-down approach, the use of organization-specific guidelines, and the use of WBS templates. The WBS can be developed in different ways to represent the second level after the highest level, the project. The second level can represent the phases of the project life cycle or major deliverables. Below illustrates a WBS with major deliverables at the second level.

0 Project Name

1 Major Deliverable

1.1 Sub Deliverable

1.2 Sub Deliverable

1.3 Sub Deliverable

2 Major Deliverable

2.1 Sub Deliverable

2.1.1 Work Package

2.1.2 Work Package

2.1.3 Work Package

2.1.4 Work Package

2.2 Sub Deliverable

2.3 Sub Deliverable

3 Major Deliverable

3.1 Sub Deliverable

3.1.1 Work Package

3.1.2 Work Package

3.1.3 Work Package

3.2 Sub Deliverable

3.2.1 Work Package

3.2.2 Work Package

3.3 Sub Deliverable

4.4.3 Case Study 4.1: WBS of Grocery LLC's M-Commerce Project

Based on the Project Charter we developed in Chapter 3 as well as the requirements and the scope detailed in this chapter for Grocery LLC's M-Commerce Project, we can create a WBS for the mobile application as below. Optimization of the mobile website is not included in this WBS. Different from the generic WBS above which has been developed based on the major deliverables and sub deliverables, the WBS below displays the phases of the project in the second level (e.g., scope, analysis/application requirements, deployment). This WBS has three levels including the highest level which is the project itself. In Chapter 7 "Scheduling", we will have an exercise regarding the fourth level for "1.3 Preparation of Project Charter" in the "Defining Activities" section. Although some WBS components such as "1.6 Initiation stage complete" and "2.7 Analysis Complete" are on the Activities column, they are milestones with zero duration which show

Table 4.2: WBS for the Mobile App Development Project

WBS	Activities
0	Mobile App Development
1	Scope
1.1	Clarify project purpose and determine project scope
1.2	Secure project sponsorship
1.3	Preparation of project charter
1.4	Approval of project charter by the sponsor
1.5	Secure core resources
1.6	Initiation stage complete
2	Analysis/App Requirements
2.1	Conduct needs analysis
2.2	Draft preliminary stakeholder specifications
2.3	Review specifications with team and stakeholders
2.4	Incorporate feedback on the specifications
2.5	Develop preliminary budget and delivery timeline
2.6	Obtain approvals to proceed (concept, timeline, budget, resources)
2.7	Analysis complete
3	Design
3.1	Review preliminary stakeholder specifications
3.2	Develop solution (functional and non-functional) specifications
3.3	Develop transition requirements
3.4	Develop design mockups based on specifications
3.5	Review specifications
3.6	Incorporate feedback into specifications
3.7	Obtain approval to proceed
3.8	Design complete
4	Development
4.1	Review solution and transition specifications
4.2	Assign development staff
4.3	Develop on SDKs (Software Development Kits)
4.4	Developer testing (primary debugging)
4.5	Development complete
5	Testing

5.1	Develop a test plan based on specifications and SDK
5.2	Conduct automated test plans
5.3	Conduct performance and stress tests
5.4	Conduct regression testing
5.5	Conduct localization testing
6	Training
6.1	Develop training specifications for end users
6.2	Develop training specifications for helpdesk support staff
6.3	Develop training materials
6.4	Finalize training materials
6.5	Training materials complete
7	Documentation
7.1	Develop Help specification
7.2	Develop Help system
7.3	Review Help documentation
7.4	Incorporate Help documentation feedback
7.5	Develop user manuals specifications
7.6	Develop user manuals
7.7	Review all user documentation
7.8	Incorporate user documentation feedback
7.9	Documentation complete
8	Pilot
8.1	Identify test group
8.2	Develop software delivery mechanism
8.3	Install/deploy software
8.4	Obtain user feedback
8.5	Evaluate testing information
8.6	Pilot complete
9	Deployment
9.1	Determine final deployment strategy
9.2	Develop deployment methodology
9.3	Get approval from Android and Apple stores
9.4	Train support staff
9.5	Deploy software

9.6	Deployment complete
10	Post Implementation Review
10.1	Document lessons learned
10.2	Archive all documents
10.3	Complete all pending payments
10.4	Create software maintenance team
10.5	Final meeting with stakeholders to close the project
10.6	Disband the team

Project Management Institute. (2017). A guide to the Project Management Body of Knowledge (PMBOK guide) (6th ed.). Project Management Institute.

Project Management Institute. (2017). A guide to the Project Management Body of Knowledge (PMBOK guide) (6th ed.). Project Management Institute.

Project Management Institute. (2017). A guide to the Project Management Body of Knowledge (PMBOK guide) (6th ed.). Project Management Institute.

Project Management Institute. (2017). A guide to the Project Management Body of Knowledge (PMBOK guide) (6th ed.). Project Management Institute.

Adopted from Microsoft Project Professional 2019 Software Development Plan Template

4.5 Microsoft Project Tutorial

Microsoft Project is one of the most common software tools used in project management across the world. In this textbook, we use Project Professional 2019. Recently, Project Professional 2021 has been introduced. As the main functions remain the same in these versions, we will continue using the 2019 version. If new versions necessitate an update, the online version of this book will be updated. In this book, all our examples and screenshots are based on the 2019 version. At many universities in the USA, students may be allowed to access the Microsoft Azure website (<https://portal.azure.com/>) with their school credentials (username and password). Therefore, they can download Microsoft software programs on the “Education” webpage (Figure 4.2), such as Project Professional 2021 or 2019, Access 2016, 2019 or 2021, Visio Professional 2016, 2019 or 2021, and Visual Studio, as well as Windows 10 or 11.

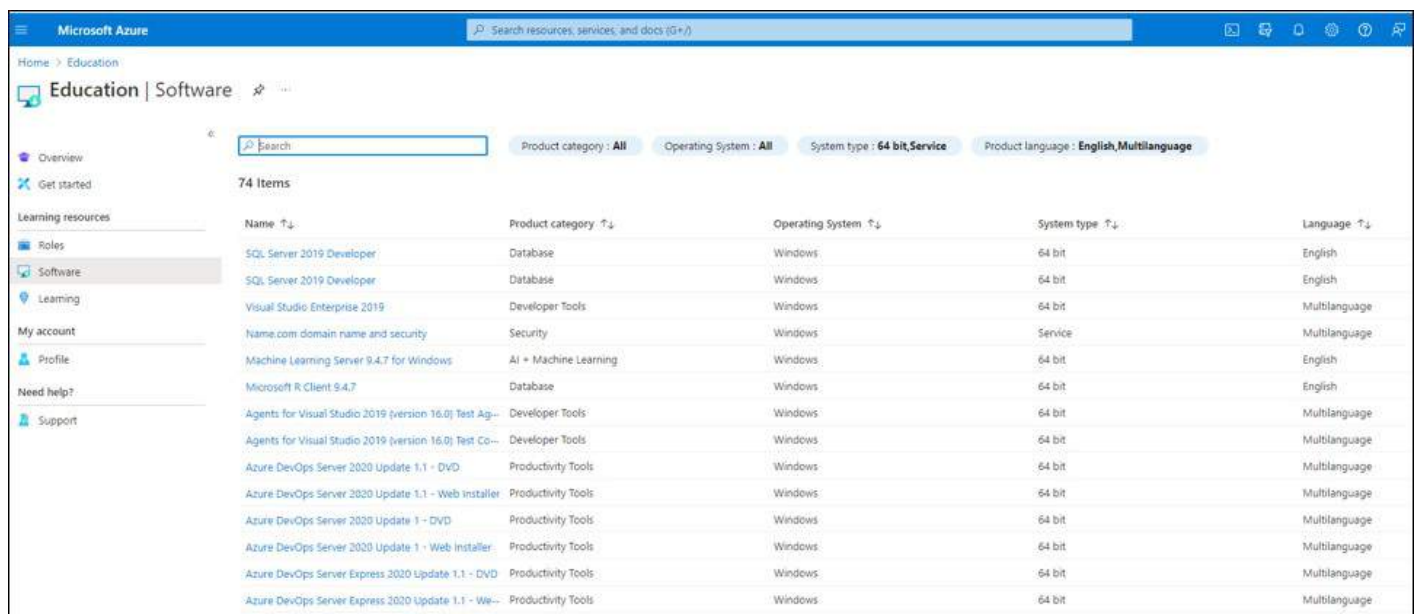

Figure 4.2: Microsoft Azure Portal – Education webpage

If you have a MacBook, you cannot download MS Project directly. The only way to run MS Project on your MacBook would be to dual-boot Windows and macOS on your MacBook. You can visit <https://support.apple.com/en-us/HT201468> for more information. Nevertheless, many school labs and libraries provide computers in which MS Project 2019 or earlier versions are installed.

When you open MS Project for the first time, you can open a “Blank Project” or you can select a template (Figure 4.3).

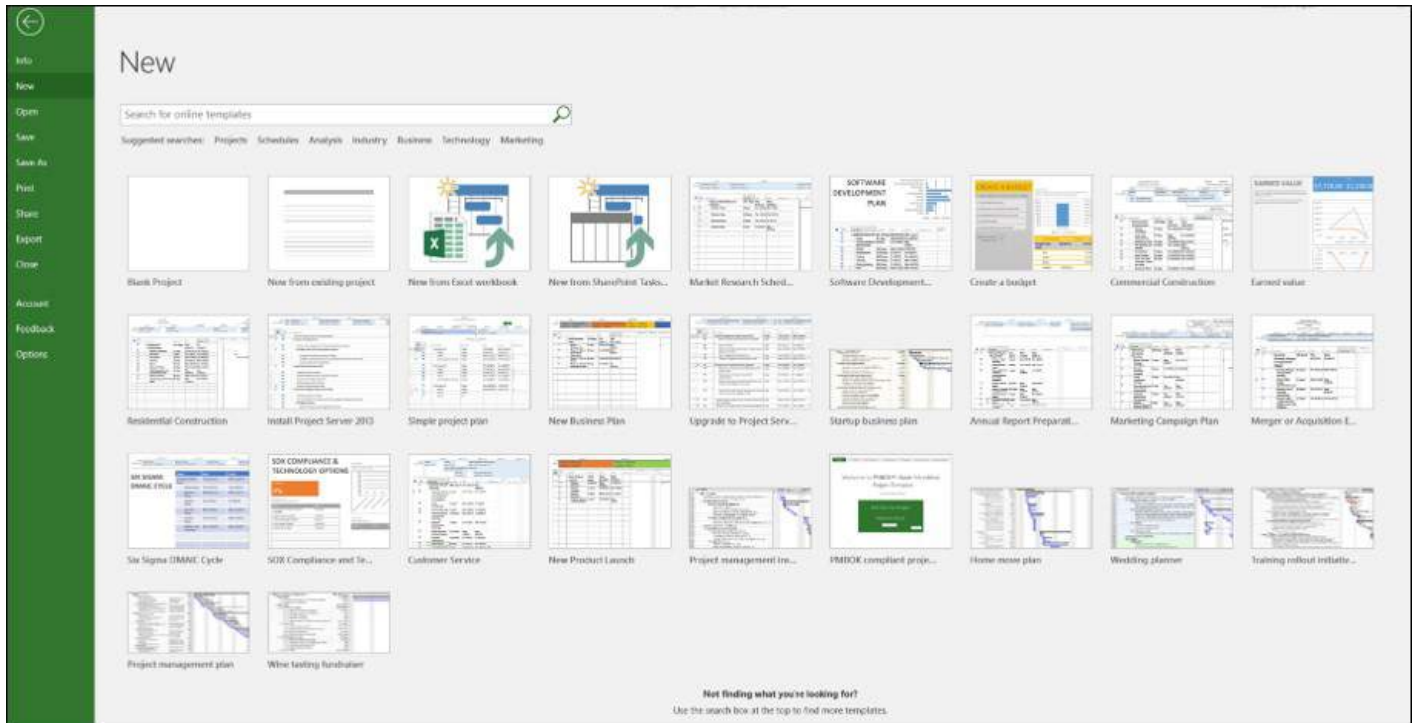

Figure 4.3: MS Project “New” Window

When you select “Blank Project”, the project page will open with a ribbon that includes tabs (in the same format we have on Microsoft Office programs such as Word, Excel, and PowerPoint) (Figure 4.4). While the default view is “Gantt with Timeline”, we changed it from “Options” to “Gantt Chart” view. Therefore, Figure 4.4 doesn’t display the timeline. In Figure 4.5, under Project View, default view is set as Gantt with Timeline.

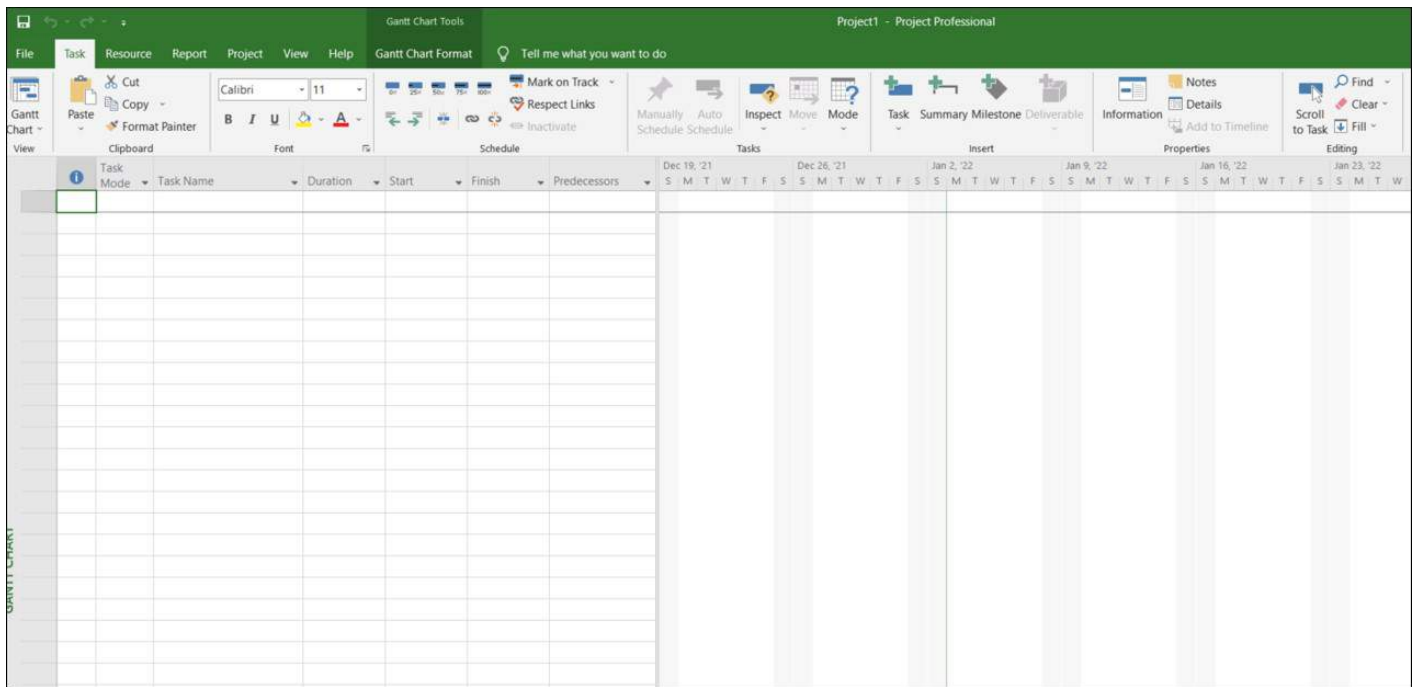

Figure 4.4: Blank Project (Gantt Chart with Timeline)

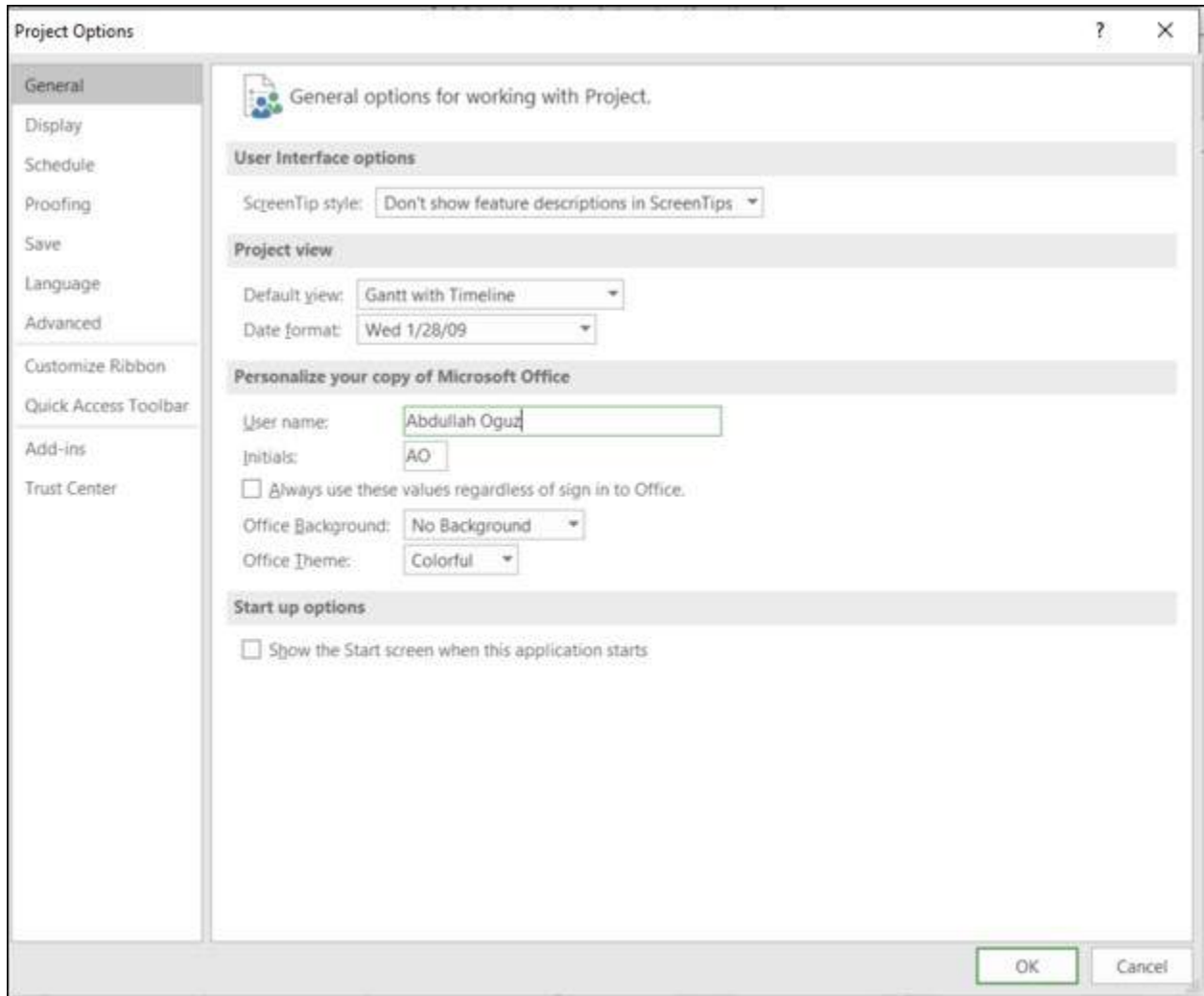

Figure 4.5: Project Options - General tab

In this chapter's tutorial and the following chapters, we will use "Gantt with Timeline" as our default view. Besides, we are not changing the schedule options. It means that we are not working at the weekends, and our durations are automatically labeled as "days". However, we can type another unit such as a week (wk or wks) or month (mon or mons) (Figure 4.6).

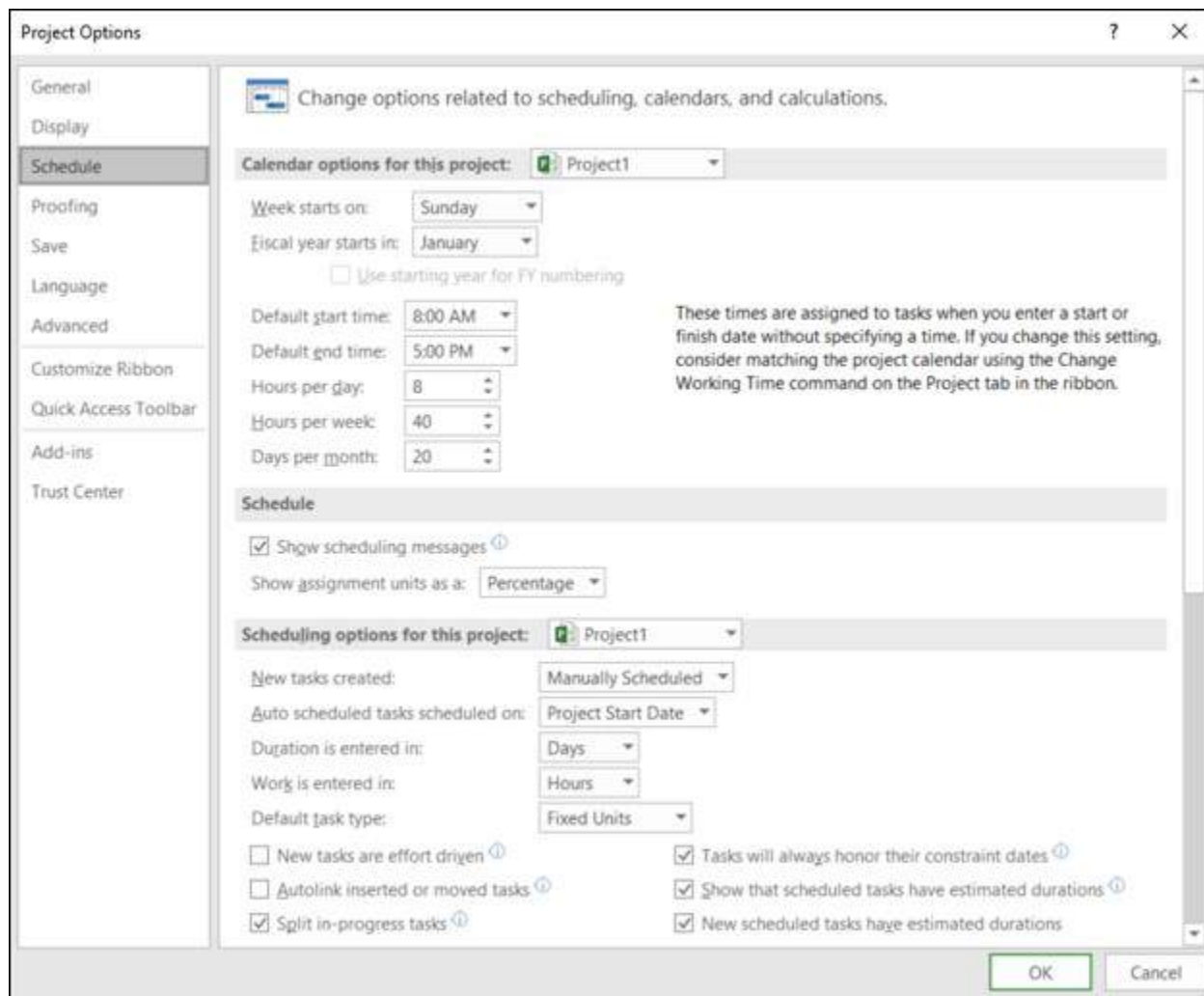

Figure 4.6: Project Options - Schedule tab

Under the “Format” tab, we should check “Project Summary Task” first. Therefore, our project’s total duration can be automatically calculated by MS Project. The row number becomes zero for the project summary task. If we insert a column titled “WBS”, the system also gives zero to this task. MS Project doesn’t use the name “Activity”, but “Task”.

		Task Mode ▾	WBS ▾	Task Name ▾	Duration ▾	Start ▾	Finish ▾
0			0	Project1	0 days?	Sun 10/10/2	Sun 10/10/2

Figure 4.7: Project Summary Task

For this MS Project tutorial, we will use letters and numbers for the activities. A is the project, and it is the highest level which is 1. The lowest level in our WBS is the third level.

Table 4.3: Activities

WBS Level	Activity
1	A
2	a1
2	a2
3	a21
3	a22
1	B
2	b1
3	b11
3	b12
1	b2

After we type all the activities, we can select a1 and a2, and indent them as both are under A (Figure 4.8). WBS numbers are given automatically by MS Project when we indent and outdent. After we indent a1 and a2, these two activities can be subtasks of A which could be considered as a phase or major deliverable.

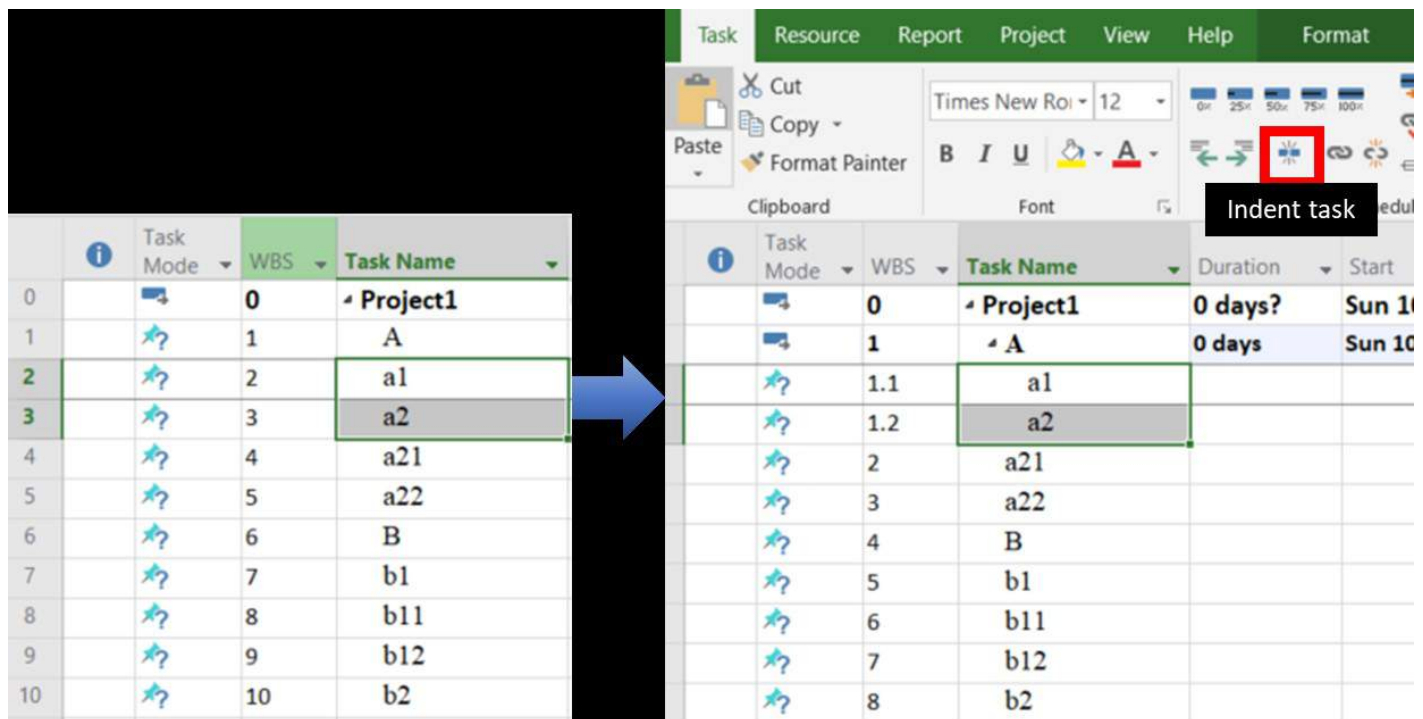

Figure 4.8: Indenting tasks “a1” and “a2”

For a21 and a22 at the third level, we should click the “Indent Task” icon twice as they are under a2 which is at the second level. Figure 4.9 displays the WBS numbers after all the activities have been indented.

	i	Task Mode	WBS	Task Name		i	Task Mode	WBS	Task Name
0		☰	0	Project1		0	☰	0	Project1
1		☒	1	A		1	☰	1	A
2		☒	2	a1		2	☒	1.1	a1
3		☒	3	a2		3	☰	1.2	a2
4		☒	4	a21		4	☒	1.2.1	a21
5		☒	5	a22		5	☒	1.2.2	a22
6		☒	6	B		6	☰	2	B
7		☒	7	b1		7	☰	2.1	b1
8		☒	8	b11		8	☒	2.1.1	b11
9		☒	9	b12		9	☒	2.1.2	b12
10		☒	10	b2		10	☒	2.2	b2

Figure 4.9: Indenting all the tasks at second and third WBS levels

As can be seen in Figure 4.9, WBS numbers changed automatically when we indented the tasks. This tutorial served as an introduction to Microsoft Project and only discussed how a WBS can be created. Therefore, we have not typed the durations and predecessors. We will cover them in Chapter 7 “Scheduling”.

4.6 Key Takeaways

Key Takeaways

- The project planning phase is often the most challenging phase for a project manager, as the project manager is often required to make educated guesses about the team members, resources required for all the activities, and the schedule and budget needed to complete the project.
- Thorough and proper planning helps project managers and teams have a smoother execution process with a better prediction level and a higher probability of project success. Developing a project management plan involves creating a set of plans to help guide the team through the implementation and closure phases of the project.
- Project managers identify the work to be done for the project in collaboration with the stakeholders including the project sponsor, team members, relevant functional departments of our organization, end-users, customers, regulatory organizations, and government agencies.
- A project manager must assure that requirements are defined in a way that project activities can be determined and sequenced, and hence, a schedule and budget can be created.
- A requirement represents something that can be met by a product, service, or process, and can address a need of the business, person, or group of people. Business requirements are developed based on the business needs (problems or opportunities) that an organization is striving to find a solution to overcome the problem or exploit the opportunity.
- Requirements can be categorized as business, stakeholder, solution, and transition requirements.
- In order to elicit the requirements, a team should dig deep by implementing various techniques such as interviews, surveys, focus group meetings, observations, and document analysis.
- Requirements traceability matrix is used to link the requirements to the activities and deliverables that satisfy them during the project.
- Planning starts with developing a scope management plan that documents how the project and product scope will be defined, validated, and controlled.
- The project scope statement describes the project scope, major deliverables, assumptions, constraints, acceptance criteria, and project exclusions (what the scope doesn't include).
- The WBS (Work Breakdown Structure) breaks the project scope down into components that can be scheduled, estimated, and easily monitored and controlled. The lowest level of a WBS is called a work package.

4.6 Questions and Exercises

There are 8 questions for this chapter. As you submit each answer, you will get immediate feedback and be taken to the next question.

An interactive or media element has been excluded from this version of the text. You can view it online here:

<https://pressbooks.ulib.csuohio.edu/project-management-navigating-the-complexity/?p=324>

4.8 Attribution

This chapter is a derivative of the following texts:

1. [Project Management by Adrienne Watt](#). © [CC BY \(Attribution\)](#).
2. [Project Management from Simple to Complex](#). © [CC BY \(Attribution\)](#).
3. [Project Management by Florence Daddey](#). © [CC BY \(Attribution\)](#).
4. [Project Management Fundamentals by Shelly Morris](#). © [CC BY \(Attribution\)](#).
5. [Project Management by Merrie Barron and Andrew R. Barron](#). © [CC BY \(Attribution\)](#).
6. [Principles of Management](#) © [CC BY \(Attribution\)](#).

Chapter 5. Stakeholder Management

5.0 Learning Objectives and Overview

Learning Objectives

1. Describe the process to identify stakeholders in a project and create a stakeholder register.
2. Explain the management of stakeholders to meet their needs and expectations, address issues, and foster appropriate stakeholder engagement involvement.
3. List the conditions when project managers need to update the stakeholder engagement plan.

5.0 Overview

A project is successful when it achieves its objectives and meets or exceeds the expectations of the stakeholders who are individuals, groups, teams, businesses, corporations, communities, government organizations, or non-governmental organizations who either care about or have a vested interest in a project. They may affect the whole project, its outcomes, some activities, or even only a decision, an activity, or an outcome of the project negatively or positively. Stakeholders may be actively involved with project activities or have something to either gain or lose as a result of the project. Project managers and their teams spent most of their time communicating and collaborating with the stakeholders. Indeed, project managers, themselves, spent 90% of their time communicating. This chapter discusses stakeholder management and how project managers should pay attention to while they communicate with the stakeholders including their key stakeholders such as project team members, sponsors, internal or external clients, customers, end-users, and regulatory and government agencies.

Project Management Institute. (2017). A guide to the Project Management Body of Knowledge (PMBOK guide) (6th ed.). Project Management Institute.

5.1 Identifying Stakeholders and Managing Their Expectations

A project starts with two processes - developing the project charter and identifying stakeholders. Triple constraints (scope, schedule, cost) and stakeholders constitute the main pillars of a project. If stakeholders are not identified properly, the project and its outcomes cannot address all the stakeholders' expectations and concerns. Incomplete elicitation of the requirements from stakeholders might leave some key requirements out of the equation, putting the project and its outcomes in danger.

Stakeholders are those who have a positive or negative influence on the project, or who are or might be positively or negatively affected by the project, or its activities, decisions, and outcomes. Stakeholders can be anyone including, but not limited to, individuals, groups, teams, businesses, corporations, communities, government agencies, not-for-profit organizations, international bodies, and non-governmental organizations. They may affect the whole project, or only one or some of the decisions or activities, or the outcomes of the project negatively or positively. Stakeholders may be involved actively or passively in the project, or its activities and decisions. When you manage a project to add lanes to a highway, motorists are stakeholders who are positively affected by the outcome of this project whereas they may be affected negatively during the construction due to the closed roads and detours. However, your project may negatively affect residents who live near the highway during your project (with construction noise) and after your project with far-reaching implications (increased traffic noise and pollution). Stakeholders can be inside the implementing or client organization (e.g., subcontractors who undertake the construction work of additional lanes) or outside it (e.g., motorists, residents).

Internal stakeholders which are inside the organization, but not limited to, are:

- Project sponsor
- Project manager
- Project team members
- PMO (Project Management Office)
- Program manager
- Project/Portfolio steering committee
- Board of trustees
- Company owners/founders
- Top management (e.g., C-level executives)
- Project managers of other projects in the organization
- Functional departments/units in the organization, their managers, and all employees (e.g., research & development, finance, accounting, human resources, sales, marketing, manufacturing)

- End users in functional departments, regional offices, and international offices of the organization
- Regional offices/branches of the organization
- International offices/branches of the organization

External stakeholders which are outside the organization, but not limited to, are:

- Customers
- End users outside the organization
- Suppliers
- Contractors and subcontractors
- Shareholders
- Regulatory bodies
- Government agencies (e.g., federal, state, local, county)
- Current and potential competitors

Often there is more than one major stakeholder in the project. An increase in the number of stakeholders adds stress to the project and influences the project's complexity level. The business or emotional investment of the stakeholder in the project and the ability of the stakeholder to influence the project outcomes or execution approach also impact the stakeholder complexity of the project. In addition to the number of stakeholders and their level of investment, the degree to which the project stakeholders agree or disagree also influences the project's complexity and outcomes.

While identifying stakeholders, in the initiation stage of a project, a project charter generally consists of key stakeholders whose power or interest levels are at a high level. Key stakeholders can make or break the success of a project. Even if all the deliverables are met and the objectives are satisfied, if your key stakeholders aren't happy, nobody's happy. This is why all the key stakeholders must be identified before proceeding with the preparation of the project management plan. However, identifying the stakeholders doesn't finish in the initiation stage, but is an ongoing process through which project managers should review and analyze their interests, involvement, interdependencies, influences, and potential impact on project success regularly during the project life cycle. Data representation techniques such as stakeholder power/interest grid/matrix help a lot to review where stakeholders are positioned based on the criteria used and be prepared and implement strategies to manage stakeholders. In the following subsection, we will discuss one of the common data representation techniques, power/interest grid (matrix) based on a scenario.

There are many project decelerators, one of which is the lack of stakeholder support. Whether the stakeholders support our project or not, if they are important to the project, we must secure their support. How do you we that? First, we must identify who our stakeholders are. Just because they are important in the organization does not necessarily mean they are important to our project. Just because they think they are important does not mean they are. Just because they don't think they need to be involved does not mean they do not have to be. The typical suspects that we should consider would be our top managers, relevant departments' managers, supervisors or key employees, and the project

sponsor (champion), our internal or external client, subject matter experts (SMEs) we need to consult, and the selection or steering committee reviewing and approving our project. In some situations, some think they are stakeholders in our project. Even though they aren't, as they perceive that they are affected by the project and its activities and decisions, we should consider them as stakeholders. From our perspective, they may not be, but we should be careful while handling them. They could be influential with those who have the power to impact our project. We shouldn't dismiss them out of hand.

Project Management Institute. (2017). *A guide to the Project Management Body of Knowledge (PMBOK guide) (6th ed.)*. Project Management Institute.

Project Management Institute. (2017). *A guide to the Project Management Body of Knowledge (PMBOK guide) (6th ed.)*. Project Management Institute.

5.2 Stakeholder Analysis

After the initial assessment has been completed, stakeholder prioritization can occur. A power/interest grid would be a very helpful tool for prioritization (Figure 5.1). It helps project managers categorize stakeholders and create effective communication strategies for each category of stakeholder on the project. This tool is one of the most common techniques utilized to group stakeholders according to their level of authority (power) and their level of concern about the project's activities and outcomes (interest). Besides the power/interest grid, other techniques can be used such as power/influence grid, impact/influence grid, stakeholder cube, and salience model. In this book, we will not cover these techniques.

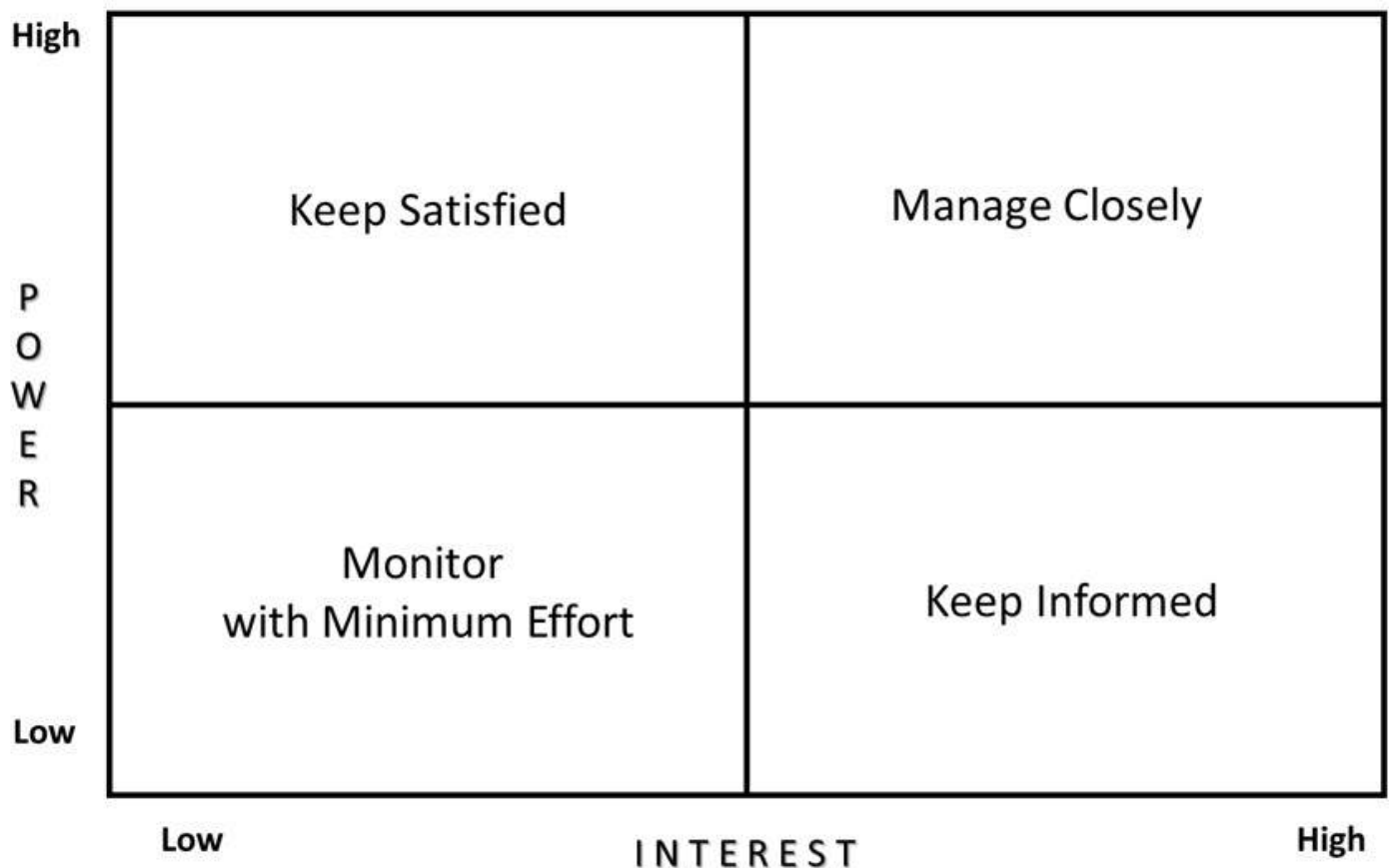

Figure 5.1. Stakeholder Matrix: Power/Interest Grid and the Strategies to Deal with the Stakeholders

The stakeholder power/interest grid is a two-dimensional matrix with four quadrants. Power refers to the authority of stakeholders through which they can affect the course of activities and decisions and may block or facilitate and accelerate them. Interest refers to stakeholders' level of concern about the project's activities and outcomes, and how they are affected by them, either negative or positive. While carrying out the activities to identify stakeholders, we should make our research and investigation

thoroughly to determine and prioritize the stakeholders. Some stakeholders would have more power and interest in our project. Therefore, we should identify them, and create a strategy to engage them during the project. These strategies have been indicated in Figure 5.1 for each quadrant based on the level of power and interest.

Properties of each quadrant with the potential stakeholder inside them have been described below:

1. High power - High interest: These stakeholders are decision-makers and have the biggest impact on the project's success and hence we must closely manage their expectations. We should work closely with them to ensure that they agree with and support the change. The project sponsor, project manager, and the team can be included in this quadrant.
2. High power - Low Interest: These stakeholders need to be kept satisfied even though they aren't interested because they yield power. This type of stakeholders should be dealt with cautiously as well since they may use their power in a not desired way in the project if they become unsatisfied. Government and regulatory agencies which inspect the quality of your work in compliance with legal provisions and standards can be included in this quadrant.
3. Low power - High interest: We should keep these stakeholders adequately informed and talk to them to ensure that no major issues are arising. They are likely to be very concerned and may feel anxious about a lack of control. They can often be very helpful with the detail of your project. Our customers or end-users who are willing to purchase the outcome of the project (e.g., a product or a service) can be included in this quadrant.
4. Low power - Low interest: We should monitor these stakeholders, but do not bore them with excessive communication. The public and the customers who are not willing to purchase our products can be included in this quadrant. We can send them newsletters once every month, but not every week. We should monitor their interest and power level in case they may change.

When considering a stakeholder's interest, we should assess the following:

- How is their performance evaluated?
- Will their performance be impacted by the project and/or the project's outcomes?
- Are they needed to help produce the project's outcomes?

When considering a stakeholder's power, we should assess the following:

- What position do they currently hold in our organization or their organizations?
- How much authority does this position afford them over the project?
- Can they influence people in positions of high power?

Tools such as stakeholder power/interest grid help project managers prioritize stakeholders. Some stakeholders have little interest and little power in a project and as a result, do not require as much contact from the project team. Understanding who these stakeholders are allows the project team to spend more time with the stakeholders that have a significant interest in the project and who exert significant influence over the project. Project teams assess the interest and power of project stakeholders by researching their current positions and their actions in previous change initiatives, and

by directly speaking with them about the project.

Below, let's consider a fictitious case study of a vehicle rental company to elaborate on the stakeholder power/interest grid.

5.2.1 Case Study 5.1: A Vehicle Rental Company's Project for their Booking System

Our car rental company, Best Rental Company Worldwide (BRCW), has a serious problem. Our booking system crashes frequently. The employees working in the relevant departments, branches, and the call center cannot process the information properly. Besides, there are significant errors in scheduling and pricing while individual and corporate customers are renting vehicles on the company's website, and when they reach the call center to book a vehicle. The company's IT director, who is CTO (Chief Technology Officer), asked us to initiate a project that would address the problems, and solve them. First, we should create a business case that should investigate the problem thoroughly. We should figure out the underlying reasons. In order to dig into the reasons, we should first identify the stakeholders to whom we should consult to learn what they experience with the current system, and what their concerns and expectations are. Our team targets to develop a new booking module in the ERP system, a website, and a mobile application our customers will access and use to book vehicles. We identified the stakeholders as follows:

1. Project manager
2. Project team members
3. Project sponsor: IT Director - Chief Technology Officer (CTO)
4. Steering Committee (composed of car rental company managers)
5. IT Department
6. HR Department
7. Sales Department
8. Marketing Department
9. Maintenance / Repair Department
10. Call Center and its managers and employees
11. Branches across the USA (and their managers and employees)
12. Branches outside the USA
13. Individual Customers
14. Organizational Customers (Corporates that rent vehicles based on a contract with BRCW)
15. Insurance companies
16. Travel agencies (including e-commerce agencies such as Expedia)
17. Vehicle manufacturers
18. Suppliers of vehicle spare parts and consumables for offices at the central units and branches
19. Government agencies (e.g., Department of Transportation, US Environmental Protection Agency)
20. Google Play store (for Android phones and tablets) and App Store (for Apple phones and

tablets)

21. Not-for-profit organizations (e.g., associations that were established to reduce carbon emissions)

Project sponsor, project manager, project team members, steering committee, IT, sales, marketing and maintenance/repair departments, call center, and branches all across the USA are our internal stakeholders that are inside our company, BRCW. Although it may look counterintuitive to include the manager and team members, they are also stakeholders. Indeed, they are the most important stakeholders who have a strong impact on project activities, milestones, decisions, deliverables, outcomes, and the overall project.

P O W E R	High	<p><u>Keep Satisfied</u></p> <ol style="list-style-type: none"> 1. Google Play Store 2. App Store 	<p><u>Manage Closely</u></p> <ol style="list-style-type: none"> 1. Project Manager 2. Project Team Members 3. Project Sponsor 4. Steering Committee 5. IT Department 6. Representative of internal customers 	
	Low	<p><u>Monitor with Minimum Effort</u></p> <ol style="list-style-type: none"> 1. Government agencies 2. Not-for-profit organizations 3. Occasional individual customers 4. Suppliers 	<p><u>Keep Informed</u></p> <ol style="list-style-type: none"> 1. Sales Department 2. Marketing Department 3. Maintenance Department 4. Internal customers 5. Frequent individual customers 6. Organizational customers 7. Insurance companies 8. Travel agencies 9. Vehicle manufacturers 	
		Low	INTEREST	High

Figure 5.2. Stakeholder Power/Interest Grid for Rental Car Company's Project

5.2.1.1 Project Sponsor

The project sponsor is typically the most powerful stakeholder. In our case, CTO is the sponsor. Sponsors have high power and high interest. They are the decision-makers and act as a supervisor and controller of the project. Sponsors often initiate the project by signing off and approving the project charter and authorizing the project manager to form and lead the team, start planning, define the scope, activities, schedule, and risks, and allocate and utilize the budget and resources. A sponsor is the

authority superior to the project manager inside the organization and acts as a supervisor and facilitator during the project. A sponsor releases the budget for the team to use for the project activities. If the project client is one of the units of the organization, that is an internal client, the project sponsor also becomes the funder. If the client is outside the organization, this external client becomes the funder while the sponsor should be still inside the organization that is implementing the project. A legal contract is created between the organization (where the project sponsor, project manager, and team are), and the external client (funder). While the contract is a legally binding agreement, we still need a project charter that should be signed by the sponsor who is in our organization where the team resides. The charter should be based on the contract, and it regulates the requirements and resource allocations on the organization's side. As discussed in Chapter 3 regarding the project charter, the project sponsor can be referred to as the "initiating sponsor." They have the authority to start and stop the project and will support the achievement of project objectives by removing the barriers to success. They can be regarded as the "external champion" because they often serve as the last escalation point when the project team needs support bringing an off-track project back on track. Successful project teams know how to leverage the power and position of the project sponsor and will proactively ask them to deliver influencing communications throughout the organization in order to maintain the project's momentum and high morale within the team. Project sponsors can assign one or more sustaining sponsors to act as the "internal champion(s)" of the project. These sponsors are often leaders of the internal departments that are most affected by the project, such as a marketing manager or human resources manager. When the project sponsor selects the sustaining sponsor(s), one of their goals is to ensure that the project team frequently considers the organizational impacts of the changes being introduced. By keeping the sustaining sponsor(s) actively engaged in the project, they will ensure their teams are intently participating in the project and identifying the operational impacts that must be considered in order for the change to be sustained once the project has been completed.

5.2.1.2 Project Manager and Project Team

The project manager and the team members have high power and high interest since they are responsible for conducting all the teamwork and project activities, and they define and sequence activities, estimate their duration, budget, and resources, identify resources and allocate them, identify and manage risks, and monitor and control all project activities. They are those who are held accountable in the first place for the success of the project. Project managers have to deal with stakeholders external to the organization as well as the internal environment, certainly more complex than what a manager in an internal environment faces. For example, suppliers who are late in delivering crucial parts may blow the project schedule. To compound the problem, project managers generally have little or no direct control over any of these stakeholders. Therefore, it is a challenging process for project managers and the team. We will discuss team management in more detail in Chapter 6.

5.2.1.3 Top Management and Steering Committee

Top management may include the president of the company, vice-presidents, directors, division

managers, and the corporate operating committee. They direct the strategy and development of the organization. Project managers should have top management support, which means it will be easier to recruit the best staff to carry out the project and acquire needed material and resources. Moreover, visibility can enhance a project manager's professional standing in the company. On the minus side, failure can be quite dramatic and visible to all, and if the project is large as is in our case and expensive, the cost of failure will be more substantial than for a smaller, less visible project. Therefore, while dealing with top management, project managers should develop in-depth plans and major milestones that must be approved by top management during the planning and design phases of the project. They should ask top management associated with the project for their information reporting needs and frequency. They should also develop a status reporting methodology to be distributed on a scheduled basis, and keep them informed of project risks and potential impacts at all times. In our case study, the steering committee which is composed of top managers and their representatives plays a crucial role during the project.

5.2.1.4 Functional Departments

In our case study, we have functional departments, which are the IT, sales, marketing, and maintenance/repair departments as well as branches all across the USA. In general, central functional units have more authority than the regional offices have. All these units have managers and employees at various hierarchical levels. Among the central units, the IT department is the one that we should work with more closely since the project is directly related to their responsibilities, and most of the human and physical resources we need for the project activities reside in the IT department. Therefore, the IT department has high power and high interest. The project also needs human resources from the sales, marketing, and maintenance departments. We need to consult subject matter experts in these departments. Therefore, these department heads control their resources, and we rely on them. If we have a good relationship with them, they may be able to consistently provide the best staff and the best equipment for our project. Employees from these departments may be in our core team, or they may attend the project activities. Since the booking system directly affects their day-to-day operations, they have a higher interest. However, their power level may not be very high all the time. It may fluctuate from moderately high levels to lower interest levels though it is generally not very low.

5.2.1.5 Internal Customers: Branches and Call Center

The branches in our case, and also the call center, are the internal customers of our project. They will be the end-users of the new ERP module when our individual customers and employers of our organizational customers visit the branches or call the call center to book a vehicle or to talk about another issue related to the booking (e.g., complaints, roadside assistance). These two categories of internal customers are those who hold the power to accept or reject the deliverables of activities and the overall project when completed. However, they are generally represented by their managers, a product owner, or an inspection and acceptance committee who have high power and naturally very high interest. Therefore, we should place them in the quadrant that makes us manage them closely. Early in the relationship, the project manager will need to negotiate, clarify, and document project specifications and deliverables. After the project begins, the project manager must stay tuned in to the

customer's concerns and issues and keep the customer informed. If call center agents don't find the new system user-friendly and easy to use, they may resist using it. They must be kept informed frequently, and their feedback should be sought especially in critical decisions. Their resistance and dissatisfaction may lead to rework, which may cause the project to have budget overruns and schedule slippages. This is why continuous user involvement and feedback are crucial during the project to minimize the risk of unacceptance.

While dealing with internal customers, the project manager and the team should pay attention to ensuring clarity about what stakeholders, in particular customers, want precisely. This is a part of product and project scope management. Project managers should assign business and/or systems analysts who can elicit requirements utilizing techniques such as surveys, interviews, focus group meetings, workshops, root and cause analysis, and document analysis. Project managers should be aware of any issues regarding the lack of documentation for what is wanted, lack of knowledge of the customer's organization and operating characteristics, unrealistic deadlines, budgets, or specifications requested by the customer, hesitancy of the customer to sign off on the project or accept responsibility for decisions, and changes in project scope. As explicated in Chapter 3 "Project Initiation" and Chapter 4 "Project Planning", project managers should address the needs and expectations of stakeholders such as customers, clients, or owners, and be sure to do the following:

- Learn the organization's organizational structure, culture, buzzwords, and business.
- Clarify all project requirements and specifications in a written agreement.
- Specify a change procedure clearly in change management and configuration management plans.
- Establish the project manager as the focal point of communications in the project organization.

5.2.1.6 External Customers

Providing clarity about what stakeholders want precisely, as explained above for internal customers, is true for external customers too. Business and/or systems analysts should also elicit requirements from external customers by utilizing techniques such as surveys, interviews, focus group meetings, workshops, root and cause analysis, and document analysis. External customers are outside our organization. Therefore, they are within the external stakeholders. In our case, external customers are individual customers (people who rent vehicles for leisure or work) and organizational customers (corporates that rent vehicles based on a contract). When we finalize our project, they can book the rental vehicles on our website and mobile app, call the call center to reserve a vehicle or talk about another issue related to the booking (e.g., complaints, roadside assistance) or they can visit a branch to reserve, pick up or return a rental vehicle. Organizational customers, in general, have a contractual relationship with our company as they regularly and frequently rent vehicles with better prices and conditions. They will be interested in our new booking system since a more effective system helps them have a smoother process with minimum flaws. Most of the individual customers may not be frequent customers. They may pursue lower prices by comparing the prices based on the vehicle type. Therefore, their interest in our new system may not be high most of the time. We can name them as occasional individual customers. However, the customers who rent their vehicles from our company regularly may

be interested in our project, and they may be willing to receive newsletters, for example, once every month in their email accounts. The power level for both individual and organizational customers would be low since they don't have the authority and decision-making authority to significantly affect the course of the project (Figure 5.2).

5.2.1.7 External Stakeholders

In our case, individual customers (see 5.2.1.6), organizational customers (see 5.2.1.6), mobile app stores, insurance companies, travel agencies (including e-commerce agencies), vehicle manufacturers, suppliers, government agencies, and not-for-profit organizations are our external stakeholders.

An important stakeholder group in our case would be two common **mobile application stores** - Android's Google Play and Apple's App Store. Our mobile app developers and testers will use their SDKs (Software Development Kits), and they should authenticate the app before it can be used by the customers on their smartphones. There will be also standards such as regarding privacy and security that we need to comply with. Thus, these two stores will have high power in our project. However, their interest level may not be high as they are not impacted by this project and its outcomes. We should keep them satisfied by complying with their standards, and terms and conditions.

Government and regulatory agencies are generally considered to have high power and low interest if they have an inspection and approval authority in the project. Project managers working in certain heavily regulated environments (e.g., pharmaceutical, banking, or military industries) will have to deal with government regulators and departments. These can include all or some levels of government from municipal, provincial, federal, to international. Besides, constructors are subject to permits and inspections from the local (city and county offices such as Public Works, Fire, and Health Departments) and federal agencies regarding the quality and legal standards they need to adhere to in their constructions (e.g., building permits, fire evacuation plan, fire and smoke equipment, safety). This is why these agencies' power level is high. In our case, government agencies were listed as the Department of Transportation and the US Environmental Protection Agency. Although these agencies may perform controls and inspections, and release permits for our operations, they may not have power and interest in our booking system. Thus, they are inside the low-power and low-interest quadrant in Figure 5.2. If there is a function or condition that need to be added to our system, and these agencies should approve before we make the system available, then we can include them inside the high-power and low-interest quadrant.

In our booking system project, we also have **not-for-profit organizations** such as associations that were established to reduce carbon emissions. Similar to government agencies in our case, these organizations may not have power in our project. However, they may have a low or moderate level of interest since the system could include the fuel efficiency rates for each car. In Figure 5.2, they were placed within the low-power and low-interest quadrant.

Insurance companies and travel agencies may be interested in our new booking system since some of them have an ongoing contractual relationship with our company. When a customer wants to rent a

vehicle, they can select an insurance plan during their rental time. Travel agencies, and/or travel websites (e.g., Expedia, Priceline) communicate with our company's system to check the availability of our rental cars. Therefore, both insurance companies and travel agencies may be interested in our project. However, their power level would be at a low level as they don't have the decision-making authority to affect the project activities.

Another stakeholder would be **vehicle manufacturers** from which our company, BRCW, purchases the vehicles to rent to the customers. Although they have a high interest in our vehicle portfolio, and they have an ongoing relationship with our company, they may not have a high-level interest in the booking system. Indeed, vehicle manufacturers prefer their vehicles to appear in the booking system with high-quality pictures and accurate technical information. This is why they may have a moderate level of interest in our booking system. They would be willing to see the same look and feel or the picture and information quality available in our current system. Therefore, they were placed in the low-power and high-interest quadrant in Figure 5.2. We can also use the maintenance and service points of these vehicle manufacturers. However, this wouldn't be related to the booking system.

Another stakeholder, **suppliers** of vehicle spare parts and consumables for offices at the central units and branches, wouldn't have a high interest in our booking system. They may have a moderate level of interest in the functions and conditions in our ERP module if spare parts and consumables are included. Neither do they have power in our project. Many projects heavily depend on goods provided by outside suppliers. This is true for example of construction projects where lumber, nails, brick, and mortar come from outside suppliers. If the supplied goods are delivered late or in short supply or of poor quality or if the price is greater than originally quoted, the project may suffer. Therefore, their interest level would be high. However, in our case, their interest level wouldn't be high. Hence, they were replaced in the low-power and low-interest quadrant in Figure 5.2.

We didn't include any contractors in our case study. However, there are times when organizations don't have in-house expertise. Thus, available resources and work is farmed out to contractors or subcontractors for the whole project or some of the activities. In a construction project, these subcontractors may be consultants, electricians, carpenters, and architects. Managing them requires many of the skills needed to manage full-time project team members. We may have problems with them regarding the quality of the work, cost overruns, and schedule slippage.

5.2.2 Case Study 5.2: Grocery LLC's Mobile-Commerce Project

In Chapter 3 of this textbook, we created a project charter in the initiation phase of Grocery LLC's mobile e-commerce project. The stakeholders specified in this charter under "9. Key Stakeholder List" are below. Besides, project team members who are indicated under "12. Project Team" in Chapter 3 have been included in the list below.

1. Project manager (Senior Systems Analyst)
2. Project team members (The core team)
 - a. Project manager: Senior systems analyst

-
- b. Two systems (business) analysts
 - c. Two UI/UX designers
 - d. Three developers (including Android and IOS developers, and the backend developer)
 - e. Two testers (quality assurance engineers)
 - f. Two sales and marketing experts
3. Project sponsor (Chief Operations Officer - COO)
 4. Product owner (The representative from the operational department who was assigned by the COO)
 5. IT Department
 6. Sales Department
 7. Marketing Department
 8. HR Department
 9. Store managers and employees
 10. Suppliers
 11. Online customers
 12. Customers who visit the stores in person
 13. Government agencies that announce the pandemic restrictions
 14. Google Play and App Store for the mobile application

The stakeholders have been placed on the grid as illustrated in Figure 5.3. Different from Figure 5.2, this grid shows each stakeholder with dots inside their quadrants. We should always keep in mind that the location of each dot should be justified, and they don't indicate a GPS location so that they provide a comparison of their locations with other stakeholders.

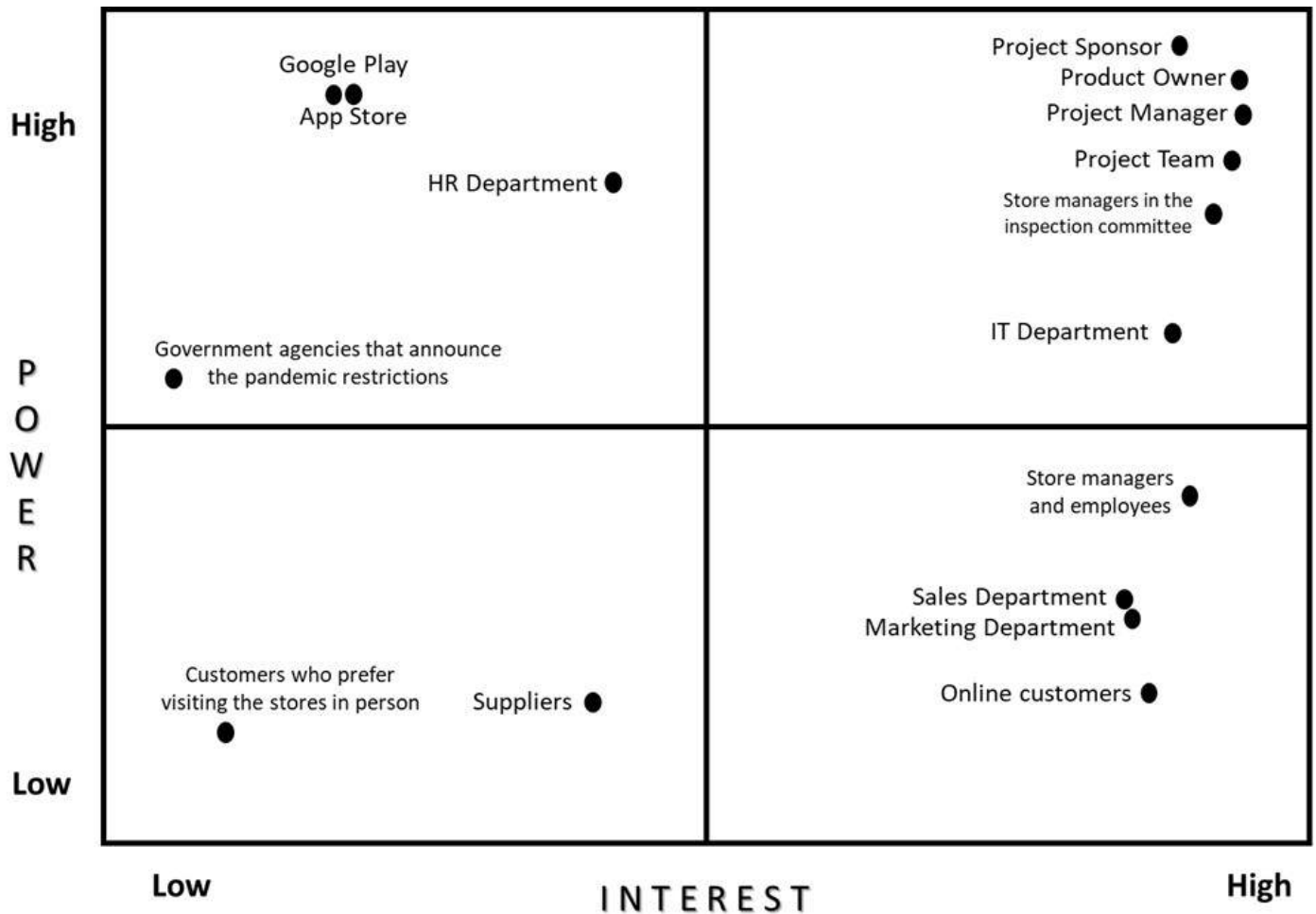

Figure 5.3. Stakeholder Power/Interest Grid for Mobile Commerce Project

High Power - High Interest Quadrant

We have explained in Case Study 1.1 that the project sponsor, project manager, and project team are placed in this quadrant. The product owner in the m-commerce project of Grocery LLC is a representative from the operational department who was assigned by the COO. This person represents the interests of the internal client, and the priority of the product specification is managed and directed by this person. Therefore, the product owner has a high authority to affect the course of the project, and naturally, their interest is at a very high level from the very beginning to the very end of the project, extending beyond the completion of the project. Let's assume that two store managers will be assigned to the inspection committee that will assess the performance measures of the mobile application to grant acceptance. In any case, whether they are at the committee or not, store managers are directly affected by the activities and outcome of this project. Finally, the IT Department will be the main functional unit that will coordinate this project's technical activities (programming, testing, deployment), and assign systems (business) analysts, UI/UX designers, developers (including Android and IOS developers, and the backend developer), and testers if these human resources are available in this department. If they are not available, the IT department will start a recruitment process through the HR department.

High Power - Low Interest Quadrant

Similar to Case Study 1.1, mobile application stores, Android's Google Play and Apple's App Store, would have high power in this project. Developers and testers in this project will use their SDKs (Software Development Kits), and they should authenticate the app before it can be used by the customers on their smartphones. Thus, we should keep them satisfied by complying with their standards, and terms and conditions. During the project, we should keep an eye on the announcements made by the government agencies regarding the pandemic. Modifications or new restrictions may affect the ongoing activities, and challenge the allocation of human and physical resources. The fourth stakeholder in this quadrant would be the HR department. Although the HR department may not have high interest, their power level could be higher due to the fact that the recruitment process should be carried out through them as explained above in the "high power - high interest quadrant".

Low Power - High Interest Quadrant

As indicated in the "high power - high interest quadrant", store managers' interest will be high as their stores will need to manage the online orders. They will also be interested in the features of this application and its store interface since the store employees will need a user-friendly application to process the orders smoothly. Therefore, employees are expected to have a high-level interest in this project. Although both managers' and employees' power to influence the project activities and outcomes wouldn't be high, we can still expect a moderate level of power because of their key role in the process. In the headquarters of Grocery LLC, sales and marketing departments are expected to have a high interest in this project. Actually, both departments will provide human resources directly in the project team. Besides, the mobile application's content and its marketing tools will be managed by these two departments. Finally, we can place online customers in this quadrant as the end-users of the mobile app. The project team should elicit these stakeholders' expectations from the app while creating, validating, and finalizing the requirements of the app.

Low power - Low Interest Quadrant

In this case study, we have two stakeholder groups in this quadrant. Suppliers have a key and frequent relationship with the grocery chain. However, their interest would be mostly on the supply chain management system through which they communicate with the chain and the intermediaries to dispatch the items ordered by the stores. Increased sales by means of the mobile app would benefit suppliers. However, the relationship with the grocery chain depends on the agreements and contracts independent of the mobile application. Nevertheless, we can still expect a moderate level of interest in this project. The second stakeholder group in this project would be customers who prefer visiting the stores in person, and hence who don't think of using the mobile app. Their interest level can be at a minimum level.

5.2.3 Stakeholder Register

In order to have a better picture of stakeholders, we should have a stakeholder register accompanied by

the power/interest grid we delineated above. This register should include information about all our stakeholders, both key and those with low interest and low power. Table 5.1 illustrates an example of a stakeholder register based on our case study about a rental vehicle booking system implemented at BRCW.

Table 5.1. Stakeholder Register

ID	Stakeholder Name, Title, and Contact Information	Organization Name	Power Level (H/M/L)	Interest Level (H/M/L)	Current Level of Support	Level of Support Required	Risk Rating (H/M/L)	Related Stakeholders	Issues & Concerns	Engagement Strategy & Tactics
1	Project Sponsor CTO	BRCW	H	H	Supports Actively	Supports Actively	L	<ul style="list-style-type: none"> Project Team Steering Committee IT Department 	Committed to the project and wants to ensure the external resources the organization provides deliver on expectations.	Should be managed closely. Signs off the project charter and the plan, and authorizes the project manager. Releases the budget and resources. Very frequent communication.
2	Google Play Store	Google (Android)	H	L	Neutral	Supports	M	<ul style="list-style-type: none"> App Store Project Team 	Should authenticate our app before it can be used by our customers on their smartphones. Google Play's SDK will be used. App features, privacy, and security issues should be complied with. New apps must target at least Android 11 (API level 30).	Google Play guidelines must be followed for compliance.
3	Organizational Customer	Company X	L	H	Opposes	Supports	H	<ul style="list-style-type: none"> Project Team Sales Department Call Center Branches 	Company X managers raised some issues in the recent meetings to terminate the contract with BRCW. They don't think that BRCW can create a new effective app.	The project team and sales department must communicate with this stakeholder's top management frequently to show BRCW's commitment to this project. Each increment of the website and mobile app should be shown to receive feedback.
4	Occasional individual customers	NA	L	L	Neutral	Supports	L	<ul style="list-style-type: none"> Project Team Call Center Branches 	They try to find the most affordable price among many rental companies' offers.	The new booking system should be optimized to show the best offers to these customers.

Level of support (either current or desired) can be evaluated in five levels:

1. Supports Actively: Anticipates and feels the need for change, actively works with the project team.

2. Supports: Anticipates and feels the need for change, but does not involve in the project team.
3. Neutral – Neither supporting nor opposing.
4. Opposes – Neither feels the need for change nor tries to prevent the change.
5. Opposes Actively – Doesn't see the need for change, actively working to prevent the change.

In some cases, it isn't uncommon for project managers to be working with stakeholders that are not supportive of the project. They may feel the project is not going to benefit them or their organizations. They may also resist making the changes that are necessary to support the project's outcomes. Some stakeholders are very upfront about their resistance and others are not. In these situations, the project sponsor may be integral to winning these stakeholders over. Knowing when to tactfully involve others in stakeholder management is another key success factor for effective project management.

Stakeholders are critical factors to be taken into account while identifying the risks. Their risk rating helps the team determine individual and overall project risks. The project manager and the team should use judgment in deciding how to handle each stakeholder by evaluating their current and desired support level, the potential impact on the project activities, decisions and outcomes, and their issues and concerns regarding the project and other stakeholders. The role of stakeholders in identifying and managing risks will be discussed in Chapter 10.

Stakeholders may convey their issues regarding the project explicitly or implicitly. Therefore, the team should attempt to analyze and list what kind of issues and concerns are available and may emerge during the implementation of the project. Based on all the inputs discussed, the team should carry out brainstorming sessions and come up with strategies for the stakeholders whose lack of support significantly might impact the project's success, how to gain their support, and how to engage them effectively in the project. Table 5.1 includes issues and concerns with four stakeholders in the rental booking system project, and engagement strategy and tactics.

Furthermore, we should consider the relationship among stakeholders. Can we improve the project's chances by working with those who support us to improve the views of those who oppose? Therefore, as indicated in Table 5.1, it would be helpful for the team to have information regarding the relationships among the stakeholders. For example, related stakeholders have been indicated as the project team, sales department, call center, and branches for organizational customers.

A stakeholder register is a living document that should be reassessed regularly as is done for other plans and documents such as risk register and issue log (see Chapter 10). Thus, the project team should assign some time in their weekly or monthly meetings to discuss whether revisions are required to do in the stakeholder register. Stakeholders' power and interest levels, support levels, risk ratings, issues and concerns, and accordingly engagement strategies and tactics could change throughout the project. Besides, new stakeholders may be added later. This process is discussed in 5.3 "Managing and Monitoring Stakeholders".

5.2.2.1 Stakeholder Engagement Assessment Matrix

Another data representation tool that can be used is a Stakeholder Engagement Assessment Matrix. It

can also be incorporated into the stakeholder register. In Table 5.1 above, the level of support was indicated in five levels: (1) Supports actively, (2) supports, (3) neutral, (4) opposes, and (5) opposes actively. Besides this, another matrix can be used as detailed in the PMBOK Guide 6th Edition. C indicates the current engagement level whereas D indicates desired level.

Table 5.2 Stakeholder Engagement Assessment Matrix (Adopted from PMBOK Guide 6th Edition)

Stakeholder ID	Unaware	Resistant	Neutral	Supportive	Leading
1		C	D		
2	C			D	
3				C	D

*C: Current, D: Desired

As indicated in Table 5.2, stakeholders are evaluated based on five levels of engagement. They may be unaware of the project and its potential impacts. They may be aware of the project and potential impacts but resistant to any changes that may occur as a result of the work or outcomes of the project. These stakeholders will be unsupportive of the work or outcomes of the project. When stakeholders are aware of the project but neither supportive nor unsupportive, we can classify them as neutral. When they are aware of the project and potential impacts and supportive of the work and its outcomes, we can classify them as supportive. Eventually, stakeholders are classified as leading when they are aware of the project and potential impacts and actively engaged in ensuring that the project is a success.

5.2.2.2 Responsibility Assignment Matrix (RACI Chart)

Another data representation technique that can be used to illustrate each team member's and relevant stakeholders' roles and responsibilities in each project activity can be a responsibility assignment matrix. It shows the project resources assigned to each work package (lowest level activities in a WBS). One of the common responsibility assignment matrices is RACI (responsible, accountable, consult, and inform) chart. A RACI chart is a useful tool to ensure clear assignment of roles and responsibilities when the team consists of internal and external resources. As seen in Table 5.3, a RACI chart displays the activities associated with team members and stakeholders.

In order to avoid confusion about who is ultimately in charge of supervision and/or decision-making for an activity, there should be only one person associated with accountability. A role that is "Accountable" has the final authority or accountability for the task's completion. This role is generally assumed by the project sponsor, project manager, or a supervisor or team members delegated by the project manager for an activity. As seen in Table 5.3, for each activity, we have only one role that assumes an accountability role. For example, in the "Collect Requirements" activity, Jim is the team member who is responsible for coordinating the whole activity and/or performing the tasks directly. Jim can consult Jane and Anna who may be subject matter experts who have a substantial amount of experience and

knowledge or those who are affected significantly by the activity and have an interest in this activity and the overall project. Thus, Jim can interview Jane and Anna, and learn about their needs, expectations, and concerns. Mary can be the project manager or the supervisor in the team that audits and approves the activity and its deliverables. Tom could be a stakeholder with high interest and low power. We should keep him informed about what is going on in this activity. We can also receive feedback from Tom to improve the tasks in this activity.

Table 5.3 RACI Chart

Activity	Team Member or Stakeholder					
	Jim	Mary	Chris	Jane	Anna	Tom
Plan Scope Management	A	R	R	I	C	C
Collect Requirements	R	A	I	C	C	I
Define Scope	A	R	R	I	C	C
Create WBS	A	R	R	R	I	

Project Management Institute. (2017). A guide to the Project Management Body of Knowledge (PMBOK guide) (6th ed.). Project Management Institute.

<https://www.projectmanagement.com/wikis/368897/stakeholder-analysis--using-the-power-interest-grid>

International Institute of Business Analysis. (2015). A guide to the Business Analysis Body of Knowledge (BABOK Guide), version 3.0. Toronto, Ont: International Institute of Business Analysis.

Anupam (n.d.). Stakeholder Analysis Register. Retrieved from <https://www.projectmanagement.com/>

Anupam (n.d.). Stakeholder Analysis Register. Retrieved from <https://www.projectmanagement.com/>

Project Management Institute. (2017). A guide to the Project Management Body of Knowledge (PMBOK guide) (6th ed.). Project Management Institute.

Project Management Institute. (2017). A guide to the Project Management Body of Knowledge (PMBOK guide) (6th ed.). Project Management Institute.

5.3 Managing and Monitoring Stakeholder Engagement

After we identify the stakeholders, analyze their positions in terms of interests, power, influence, involvement, interdependencies, and potential impact on the project success, and accordingly develop strategies to involve them in the project to make them supportive of the project (and at least not opposing the project), we can manage and monitor their engagement. This engagement should be detailed in a stakeholder engagement plan which is a component of the project management plan that identifies the strategies and actions required to promote the productive involvement of stakeholders in decision making and execution. The stakeholder power/interest grid, stakeholder register, and other data gathering and analysis techniques are included in this plan created to guide the project team throughout the project to identify the strategies and approaches for engaging stakeholders.

During the execution of project activities, the project manager allocates most of the workforce and resources required for activities and spends a substantial amount of the budget. Based on the stakeholder engagement plan and its components, project managers should communicate and work with stakeholders to meet their needs and expectations, address issues, and foster appropriate stakeholder involvement. This plan helps us while eliciting stakeholders' requirements, expectations, and concerns, having meetings, interviews, and workshops with them, sending them periodic newsletters to keep them updated about the progress of our project, carrying out the activities to create deliverables that can satisfy their needs, and closing out the project after the approval of the client.

Identification of stakeholders brings about another key aspect of stakeholder management - communication with them. The communication protocol must be incorporated into the stakeholder engagement plan. Communication methods can be adapted to suit the unique nature of the project. This adaptation will also strongly affect project success. Key questions the project team needs to address are:

- Which stakeholders will make the decision in the organization on a specific issue, and which of them should be involved in this process? In particular, to whom we should consult about an issue, and inform?
- What type of communication types and methods should we utilize? Do the stakeholders want lengthy documents? Formal or informal communication? Is "short and sweet" the typical standard?
- What medium of communication is preferred? What kind of medium is usually chosen for various situations? Check the lessons learned repositories to see what past projects have done.

Although project managers keep each stakeholder's expectations and needs in mind throughout each

conversation, report or email, we should always remember that the interests of both our company and the client are more important than any stakeholder's interests. However, preferring our company's or client's interests over other stakeholders' may lead to failure during the implementation or after the deliverables of the project are made available for the clients and customers in the market. Market demand is a critical determinant of the success of our project outcome.

No matter what stakeholders' needs or wants are, all of them will respect the project manager who:

- always provides justification of the actions and results, even when telling them something they don't want to hear,
- Takes ownership of the project,
- Is predictable and reliable,
- Stands by his or her decisions, and
- Takes accountability for mistakes.

Achieving a project's objectives takes a focused, well-organized project manager who can engage with a committed team and gain the support of all stakeholders. Building strong, trusting relationships with interested parties from the start can make the difference between project success and failure. Managing stakeholder engagement helps to ensure that stakeholders clearly understand the project goals, objectives, benefits, and risks for the project, as well as how their contribution will enhance project success.

The project manager's interpersonal skills are needed especially while communicating with the stakeholders (see Chapter 6 for more discussion of interpersonal and leadership skills). Project managers must rely on their soft skills to be effective. Effective project management spends a significant amount of time building relationships with stakeholders. It is of high importance for a project manager to obtain, confirm, and maintain stakeholders' commitment to the success of the project. Project managers manage their expectations through negotiation and communication. Building trust and maintaining an open line of communication are critical in working with all stakeholders. Keeping stakeholders involved is essential and it requires more than simply sharing information. The project manager must ask for their input and demonstrate an understanding of a stakeholder's unique business challenges. This level of understanding is often done through simple and regular check-ins with stakeholders. Project managers who are successful in relationship building understand each stakeholder's capacity to participate and honor their time constraints. Then, addressing risks or potential concerns and anticipating future issues that may be raised by stakeholders would be less challenging for a project manager equipped with effective interpersonal skills. Finally, project managers can clarify and resolve issues that have been identified.

Besides managing stakeholder engagement, project managers should assure that they and their teams monitor stakeholder relationships, and modify engagement strategies and plans during the project when needed. As is the case for all knowledge areas, project managers have a critical responsibility to track, review and regulate the progress and performance of the project, and accordingly to identify areas where modifications are required in the plan, and to perform corrective and preventive actions if

needed. Stakeholders' interests and power levels may change during the project. This leads to a change in strategies to engage them. Moreover, a stakeholder's support of the project objectives and outcomes may change in an opposite direction. It may move from supportive to resistant due to various factors. Supporting stakeholders may find new information that isn't in favor of their interests, and even may give harm. In our rental vehicle booking case, assume that one of the insurance companies that we work with is not included in the new system as an insurance provider. This company's representatives thought that their company's partnership with BRCW would continue. However, they were informed that their company's offer will be listed as an alternative to another insurance company's offer. Therefore, their attitudes may change to oppose the project when they are informed about it.

Project Management Institute. (2017). A guide to the Project Management Body of Knowledge (PMBOK guide) (6th ed.). Project Management Institute.

Project Management Institute. (2017). A guide to the Project Management Body of Knowledge (PMBOK guide) (6th ed.). Project Management Institute.

Project Management Institute. (2017). A guide to the Project Management Body of Knowledge (PMBOK guide) (6th ed.). Project Management Institute.

Project Management Institute. (2017). A guide to the Project Management Body of Knowledge (PMBOK guide) (6th ed.). Project Management Institute.

5.4 Key Takeaways

Key Takeaways

- Stakeholders are those who have a positive or negative influence on the project, or who are or might be positively or negatively affected by the project, or its activities, decisions, and outcomes. Stakeholders can be anyone including, but not limited to, individuals, groups, teams, businesses, corporations, communities, government agencies, not-for-profit organizations, international bodies, and non-governmental organizations.
- The stakeholder power/interest grid is a two-dimensional matrix with four quadrants. It helps project leaders categorize stakeholders and create effective communication strategies for each category of stakeholder on the project.
- Stakeholder register provides a snapshot about all the stakeholders in terms of their power and interest levels, current and required support levels, risk ratings, their relationship to other stakeholders, issues and concerns, and engagement strategy and tactics to keep them supportive of the project or keep their resistance in a very low level.
- One of the common responsibility assignment matrices is the RACI (responsible, accountable, consult, and inform) chart which is a useful tool to ensure clear assignment of roles and responsibilities when the team consists of internal and external resources.
- The project manager's interpersonal skills are needed especially while communicating with the stakeholders. Project managers must rely on their soft skills to be effective. Effective project manager spends a significant amount of time building relationships with stakeholders. It is of high importance for a project manager to obtain, confirm, or maintain stakeholders' commitment to the success of the project.

5.5 Questions and Exercises

There are 8 questions for this chapter. As you submit each answer, you will get immediate feedback and be taken to the next question.

An interactive or media element has been excluded from this version of the text. You can view it online here:

<https://pressbooks.ulib.csuohio.edu/project-management-navigating-the-complexity/?p=435>

5.6 Attribution

This chapter is a derivative of the following texts:

1. [Project Management by Adrienne Watt](#). © [CC BY \(Attribution\)](#).
2. [Project Management from Simple to Complex](#). © [CC BY \(Attribution\)](#).
3. [Project Management by Florence Daddey](#). © [CC BY \(Attribution\)](#).
4. [Project Management Fundamentals by Shelly Morris](#). © [CC BY \(Attribution\)](#).
5. [Project Management by Merrie Barron and Andrew R. Barron](#). © [CC BY \(Attribution\)](#).

Chapter 6. Communication Management, Leadership, and Project Team Management

6.0 Learning Objective and Overview

Learning Objectives

1. Evaluate the importance of good communication in project management
2. Create a communication management plan.
3. Describe the interpersonal and technical skills that project managers need to lead project teams and manage the projects effectively.
4. Explain the methods of how project managers can cope with conflicts by utilizing interpersonal skills.
5. List the leadership styles, and define the servant leadership that is favored for project managers.
6. Explain how project managers can create a culture pertinent to a project.
7. Describe the processes to develop and manage project teams.
8. Describe the virtual project teams that are exponentially utilized worldwide by all types of organizations, and compare in-person and virtual teams.

6.0 Overview

As highlighted in Chapter 5 “Stakeholder Management”, project managers and their teams spend most of their time communicating and collaborating with the stakeholders. Indeed, project managers, themselves, spend 90% of their time communicating. Therefore, most of this chapter addresses the aspects of communication which is necessary to sustain a healthy relationship with all the stakeholders besides project team members. In this chapter, we are also focusing on the team management that elaborates on the relationships between the project manager and other team members as well the relationships among all team members. Working with people, inside and outside the project team, involves dealing with them both logically and emotionally. A successful working relationship between individuals begins with appreciating the importance of emotions and how they relate to personality types, leadership styles, negotiations, and setting goals.

Project Management Institute. (2017). A guide to the Project Management Body of Knowledge (PMBOK guide) (6th ed.). Project Management Institute.

6.1 Communications Management

Projects require teamwork, and team members must communicate with each other in a variety of ways. The documents they produce must be collected, distributed, and stored in an appropriate manner to assure timely and accurate communication between team members. This process is often assisted by a variety of technologies including computer and smartphone software programs and applications. The advent of the Internet accompanied by various ICTs (Information and Communication Technologies), and the emergence of the COVID-19 pandemic by the end of 2019 accelerated the process of digitalization for people, and all organizations including the companies, multinational corporates, non-governmental organizations, governments, and international bodies. Thus, the adoption and spread of ICTs worldwide across organizations and countries increased exponentially. The utilization of global virtual teams in organizations increased to unprecedented levels. 94% of the respondents of CultureWizard's Global Virtual Work Survey indicated that employees want to continue working from home—at least part time. More virtual presence has brought about new challenges as detailed in the “Virtual Teams” section in this chapter.

ICTs can facilitate faster and better communication, or they can become a barrier if they are not well understood and applied appropriately. Besides, as detailed in Chapter 5, the project manager and the team should be in ongoing contact with all the stakeholders based on their power and interest levels, and other factors such as influence, involvement, support required, and interdependencies. This necessitates the manager to choose an optimal portfolio of communication technologies and methodologies. Therefore, these issues should be well-thought by the project manager while preparing the project plan and its subcomponent “Project Communications Management Plan”.

6.1.1 Communication Management Plan

Communications management is about keeping everybody in the loop. The communications planning process concerns defining the types of information we will deliver, who will receive it, the format for communicating it, and the timing of its release and distribution. Hence, it is of high importance to make sure everybody gets the right message at the right time.

As is the case for all knowledge areas (e.g., scope, schedule, cost, resource, risk, communication, stakeholder), the first step is to plan so that we can delineate the guidelines that we should follow during the execution of the project activities, and while we monitor and control them. This provides us a direction based on the information needs of each stakeholder, available organizational assets, and the needs of the project. All projects require a sound communication plan, but not all projects will have the same types of communication or the same methods for collecting, analyzing, and distributing the information. The communication plan documents the types of information needs the stakeholders have,

when the information should be distributed, how the information will be delivered with which frequency, who will receive it, and the format and technologies we will use to communicate.

First off, we should figure out what kind of communication our stakeholders (including the project team) need so they can make good decisions and they are well-informed. This is called the communications requirements analysis. Our project will produce a lot of information, so we don't want to overwhelm the stakeholders with all of it. Our job is to figure out what they feel is valuable. Therefore, the stakeholder power/interest grid (matrix) and the stakeholder engagement assessment matrix would be very helpful to determine the priorities of each stakeholder, and how we can communicate with each of them (see Chapter 5), Communicating valuable information doesn't mean we always paint a rosy picture. Communications to stakeholders may consist of either good news or bad news. The point is that we don't want to bury stakeholders in too much information but we do want to give them enough so that they're informed and can make appropriate decisions. ICTs have a major impact on how we keep people in the loop. Therefore, our analysis and the plan should include them.

We should answer the questions below in our communications management plan:

- What are the methods of communicating that we need to consider? Which methods can we choose to transfer information?
 - It can take many forms, such as written reports, conversations, email, formal status reports, meetings, online databases, online schedules, and project websites.
- How should we arrange the timing of the information exchange or need for updates? What is the reporting frequency for each stakeholder according to the expectations and concerns of stakeholders?
 - Based on the role and responsibilities of team members, and the interest and power levels of stakeholders, methods, and frequency should be identified for each stakeholder.
 - In "Case Study 5.2" in Chapter 3 which created the stakeholder power/interest grid for Grocery LLC's mobile-commerce project, we indicated store managers in the inspection committee and online customers who are willing to do their shopping through the mobile app. While we can communicate with these store managers more frequently (e.g., once a week) by in-person and online meetings, and emails during the project, we can communicate with the customers less frequently by sending them updates in a newsletter format every two weeks.
- Who is the person responsible for communicating the information? Who authorizes the release of confidential information? Who receives the information according to their needs, expectations, and concerns?
- Do we need to procure new technology or systems, or are there systems already in place that will work?
 - This is also a part of enterprise environmental factors and organizational process assets to take into consideration while planning any knowledge areas in project management.

- The technologies available to us help plan how we will keep everyone notified of project status and issues.
- What is the experience of our staff with the technology? Are there project team members and stakeholders experienced at using this technology, or should we need to train them?
- How does the project team function? Are they located together or spread out across several locations in a country or the world?
- What are the resources, time, and budget allocated for communication activities?

The answers to these questions should be documented in the communication plan. Keep in mind that all the components of a project management plan are interrelated. A communication plan cannot be prepared independently of other components such as the plans for the scope, schedule, cost, risk, and stakeholders. For example, concerning ICTs, we should consider if the technology we are choosing would work throughout the life of the project or we should upgrade or update it at some point.

The types of information we will communicate typically include project status, project scope statements and updates, project baseline information, risks, action items, performance measures, project acceptance, and so on. We should also consider the language, format, content, and level of detail. The information needs of the stakeholders must be determined as early in the planning phase of the project management life cycle as possible so that as we develop project planning documents, we already know who should receive copies of them and how they should be delivered.

CultureWizard. 2020 Trends in Global Virtual Work: Metamorphosis of the Global Workplace. 2020.
<https://www.rw-3.com/virtual-teams-exec-report-2020>

PMBOK 6th edition.

Project Management Institute. (2017). A guide to the Project Management Body of Knowledge (PMBOK guide) (6th ed.). Project Management Institute.

6.2 Communication Types

The communication management plan should address the needs, expectations, and concerns of the project team and the stakeholders by considering the communication types. Completing a complex project successfully requires good communication among team members. If those team members work in the same building, they can arrange regular meetings, simply stop by each other's office space to get a quick answer, or even discuss a project informally at other places like meeting rooms and even in the kitchen and next to the coffee machine. Many projects are performed by teams that interact primarily through electronic communication and are, therefore, called virtual teams (see 5.7). However, virtual interaction has been exponentially prevalent for many organizations and collocated project teams. To avoid miscommunication that can harm trust and to include team members in a project culture, the project team needs a plan for communicating reliably and in a timely manner. This planning begins with understanding two major categories of communication - synchronous and asynchronous.

6.2.1 Synchronous Communications

If all the parties to the communication are taking part in the exchange at the same time, the communication is synchronous. The following are examples of synchronous communications:

- **In-person meetings:** This is the traditional meeting method utilized by collocated teams. Some virtual teams may also prefer in-person meetings several times (e.g., kick-off and closing meetings) during the project life cycle to socialize and build trust.
- **One-on-one and conference phone (audio) calls:** These calls would be effective if there is an urgent need to meet, and participants are not available for video calls.
- **Video conferences:** These meetings have prevailed with the widespread utilization of virtual teams and the emergence of the COVID-19 pandemic. Online tools such as Skype, Zoom, Google Meet, and WhatsApp are used for video conferences.
- **Integrated solutions such as Microsoft Teams:** Teams can use synchronous communication tools such as video conferences and instant messaging, and they can share the files with other team members (asynchronous).
- **IM (instant messaging):** Team members can exchange text or voice messages on computers and mobile devices. They can also have group pages on which more than two members can chat and share documents, pictures, and videos. IM may not be synchronous all the time, and it provides an opportunity for the team members to reply later, and keep the records of the chat logs.

6.2.2 Asynchronous Communications

Getting a team together at the same time can be a challenge—especially if they are spread out across time zones. Many types of communication do not require that the parties are present at the same time. This type of communication is asynchronous. There are several choices of asynchronous communications such as mails and faxes. Recently, asynchronous communication has also been transferred mostly to online communication. In many projects, there is a need to deliver mails and packages to other team members or sub-teams, and stakeholders in different locations. Physical signatures can be still demanded to comply with the legal requirements. However, online tools have been allowing people to sign electronically, which is also legally acceptable (e.g., Adobe Acrobat, DocuSign). Therefore, this provides time and cost-saving opportunities to the project teams. Electronic mail (email) is widely used to coordinate projects and for the communication and collaboration between team members and with stakeholders. Emails have several valuable characteristics for project management. Information can be sent to a list of team members. Messages can be saved to document the process in case of a misunderstanding or miscommunication. Files can be attached and distributed.

6.3 Communications Management Protocol

The communication management plan should include a protocol that delineates all the critical communication channels for the team and stakeholders, such as the purpose of communication, ICTs utilized, frequency of communications, and types of information to be communicated. An example of a Communications Management Protocol has been provided in Table 6.1 which includes only four purposes of communication.

Table 6.1. Communications Management Protocol

Purpose of Communication	Schedule Frequency	ICTs or Other Means Utilized	Types of Information	Participants: Team Members and Stakeholders
Planning	Every week on Monday	Microsoft Teams Zoom OneDrive Emails	Requirements Project activities Schedule Cost Risks and issues	All the team members
Retrospective	Every week on Friday	Microsoft Teams Zoom OneDrive Emails	Status updates Lessons learned	All the team members
Emergency	As needed	Zoom or In-person	Depends on the reason for emergency	All the team members
Status updates	Every week after the retrospective meeting Or as needed	Emails Zoom or In-person meetings	Progress report Tracking Gantt Chart Comparison of baselines with the latest situation	Project sponsor Client All team members

6.4 Leadership Skills

Project managers, as leaders, spend 90% of their time communicating with team members and stakeholders. Therefore, communication is the most important leadership skill a project manager should possess, but not the only one. Project managers need a large number of skills which include administrative skills, organizational skills, and technical skills associated with the technology of the project. The types of skills and the depth of the skills needed are closely connected to the size and complexity of the project. This is why each project needs tailoring according to various factors including the purpose, objectives, business field, size, complexity, and stakeholders. Although project managers always need to possess interpersonal skills to communicate and collaborate effectively with the team members and stakeholders, on smaller, less complex projects, they need a greater degree of technical skills. On larger, more complex projects, project managers need more organizational skills to deal with the complexity.

PMBOK Guide 6th Edition differentiates among three skill sets project managers should possess – technical project management, leadership, and strategic and business management. Contrary to the name as is referred to as technical, it doesn't indicate the skills regarding product and industry expertise. This expertise is included inside strategic and business management skills. PMBOK Guide highlights this skill set as “technical project management skills”, and defines them as the skills to effectively apply project management knowledge to deliver the desired outcomes for projects and programs. Organizations look for project managers who are competent in implementing a systematic project management approach applying the right artifacts and methods to achieve the project objectives. Accordingly, project managers should be able to define critical success factors for the project, create plans for all the knowledge areas (i.e., integration, scope, schedule, cost, quality, resource, communications, risk, procurement, stakeholders), create, manage and monitor the project team, conduct all project management processes, monitor and control all the project work, close out the project, and disband the team. Besides, project managers should have the capability to decide which development approach would be the best for the project. Therefore, they should know the development approaches including traditional (waterfall or predictive) and agile (adaptive) tools, techniques, and methods. As indicated, strategic and business management skills include developing and applying pertinent product and industry expertise. They involve the ability to see the high-level overview of the organization and effectively negotiate and implement decisions and actions that support strategic alignment and innovation. This ability may include a working knowledge of other functions such as finance, marketing, and operations. This business knowledge is also known as domain knowledge.

The third skillset, leadership skills, involves the ability to guide, motivate, and direct a team. Leadership is defined as a social (interpersonal) influence relationship between two or more persons who depend on each other to attain certain mutual goals in a group situation. Effective leadership helps individuals

and groups achieve their goals by focusing on the group's maintenance needs (the need for individuals to fit and work together by having, for example, shared norms) and task needs (the need for the group to make progress toward attaining the goal that brought them together). These skills include negotiation, resilience, communication, problem-solving, critical thinking, and interpersonal skills.

Projects have become increasingly more complicated as more businesses execute their strategies through projects. Project management is more than just working with numbers, templates, charts, graphs, and computing systems. Though they can be counted, a common denominator in all projects is people. But they are not just numbers. A large part of the project manager's role involves dealing with people. Hence, project managers should study people's behaviors and motivations. Project managers must be perceived to be credible by the project team and stakeholders. They should detect and clarify the ambiguities effectively to remove the obstacles. On projects, the environment changes frequently, and the project manager must apply the appropriate leadership approach for each situation. They must have good communication skills. Lack of communication skills and team-building skills as well as organizational skills would cause problems in a project and could lead to failure.

PMBOK Guide 6th Edition makes an analogy of a music conductor for the project managers. This analogy is a perfect example describing the responsibilities and skills of project managers. An orchestra conductor coordinates a variety of performers who play different instruments and should ensure that the audience enjoys the music on the day of the performance. It may be a chamber orchestra composed of 25 musicians, or a large one like a symphony orchestra with up to 100 members. The conductor cannot know how to play all the instruments in an orchestra, but only one of them or a few of them. However, the conductor must assure that all the performers playing the instruments including but not limited to violins, violas, cellos, double basses, flutes, oboes, clarinets, kettledrums, and harps must create a piece of music in harmony that the audience can enjoy. Conductors perform many rehearsals with all the performers to achieve this harmony. During these rehearsals and the performance, most of the work of the conductor would be regarding communication with all the performers.

The project manager leads the project team during a project life cycle. As explained in Chapter 2, project managers may start working in the pre-project phase (preparation of a need statement, business case, and benefits realization management plan) to assess the feasibility of candidate projects, especially when the organization has a dedicated PMO (Project Management Office) or has a strong matrix or project-oriented structure. However, in general, project managers are assigned in the initiation (starting, conceptualization) phase, or the planning phase after the project charter is approved by the project sponsor. A project manager may be involved after the project is closed out to evaluate the performance of the outcome, and more importantly to evaluate if the outcome can generate the expected value (both tangible and intangible values as detailed in measurable project objectives). Although we use the term "project manager" in this textbook, you can come across a variety of concepts such as project leader, project lead, and project coordinator in other resources and also in this textbook in different sections. We assume in this textbook that a project manager is also a project leader, and should possess interpersonal leadership skills.

In the following subsections, we will focus on leadership and interpersonal skills a project manager

should possess.

6.4.1 Listening

One of the most important communication skills of the project manager is the ability to actively listen. Active listening is placing oneself in the speaker's position as much as possible, understanding the communication from the point of view of the speaker, observing and paying attention to the body language and other environmental cues, and striving not just to hear, but to understand. Active listening takes focus and practice to become effective. It enables a project manager to go beyond the basic information that is being shared and to develop a more complete understanding of the information.

Example: Client's Body Language

We work with a client on a project. The person in charge of the project in the client company just returned from a trip to Australia where he reviewed the progress of the project with his company's board of directors. Then, he visited our office for a meeting with our project team. The project manager listened and took notes on the five concerns expressed by the board of directors to him during his visit to Australia.

Our team's project manager observed that the client's body language showed more tension than usual. This was a cue to listen very carefully. The project manager nodded occasionally and clearly demonstrated he was listening through his posture, small agreeable sounds, and body language. The project manager then began to provide feedback on what was said using phrases like "What I hear you say is..." or "It sounds like...." The project manager was clarifying the message that was communicated by the client.

The project manager then asked more probing questions and reflected on what was said. "It sounds as if it was a very tough board meeting." "Is there something going on beyond the events of the project?" From these observations and questions, the project manager discovered that the board of directors meeting in Australia did not go well. The company had experienced losses on other projects, and budget cuts meant fewer resources for the project and an expectation that the project would finish earlier than planned. The project manager also discovered that the client's future with the company would depend on the success of the project. The project manager asked, "Do you think we will need to do things differently?" They began to develop a plan to address the board of directors' concerns.

Through active listening, the project manager was able to develop an understanding of the issues that emerged from the board meeting and participate in developing solutions. Active listening and the trusting environment established by the project manager enabled the client to safely share information he had not planned on sharing and to participate in creating a workable plan that resulted in a successful project.

In the example above, the project manager used the following techniques:

- Listening intently to the words of the client and observing the client's body language
- Nodding and expressing interest in the client without forming rebuttals
- Providing feedback and asking for clarity while repeating a summary of the information back to the client
- Expressing understanding and empathy for the client

Therefore, as can be seen in the example above, active listening was important in establishing a common understanding from which an effective project plan could be developed.

6.4.2 Negotiation

When multiple people are involved in an endeavor, differences in opinions and desired outcomes naturally occur. Negotiation is a process for developing a mutually acceptable outcome when the desired outcome for each party conflicts. A project manager will often negotiate on different aspects of a project (e.g., scope, schedule, budget, quality, purchases, conflicts with stakeholders) with the client, team members, vendors, and other project stakeholders. Negotiation is an important skill in developing support for the project and preventing frustration among all parties involved, which could delay or cause project failure. Negotiation is used to achieve support or agreement that supports the work of the project or its outcomes and to resolve conflicts within the team or with other stakeholders.

Negotiations involve four principles:

1. Separate people from the problem:
 - Framing the discussions in terms of desired outcomes enables the negotiations to focus on finding new outcomes.
2. Focus on common interests:
 - By avoiding the focus on differences, both parties are more open to finding acceptable solutions.
3. Generate options that advance shared interests:
 - Once the common interests are understood, solutions that do not match with either party's interests can be discarded, and solutions that may serve both parties' interests can be more deeply explored.
4. Develop results based on standard criteria:
 - The standard criterion is the success of the project. This implies that the parties develop a common definition of project success.

For the project managers to successfully negotiate issues on the project, they should first seek to understand the position of the other party. They should figure out the concerns and expectations of

team members or stakeholders with whom they will negotiate, as well as the business drivers and personal drivers that are important to them. Without this understanding, it is difficult to find a solution that will satisfy them. Project managers should also seek to understand what outcomes are desirable to the project. Typically, more than one outcome is acceptable. Without knowing what outcomes are acceptable, it is difficult to find a solution that will produce that outcome.

6.4.3 Conflict Management

Conflict on a project can be expected because of a variety of reasons such as the level of stress, lack of information in particular during the early phases of the project, personal differences, role conflicts, and limited resources. Although good planning, effective communication, and healthy team building can reduce the amount of conflict, the conflict will still emerge. How the project manager deals with the conflict results in the conflict being destructive or an opportunity to build energy, creativity, and innovation.

One of the well-known conflict management models is the Thomas-Kilmann Conflict Mode Instrument (TKI) which assesses an individual's behavior in conflict situations when the concerns of two people appear to be incompatible. This model is based on two dimensions that describe a person's behavior in conflict.

1. Assertiveness: The extent to which the individual attempts to satisfy his or her own concerns.
2. Cooperativeness: The extent to which the individual attempts to satisfy the other person's concerns.

According to different levels of these two dimensions, the model defined five methods of dealing with conflict (Figure 6.1).

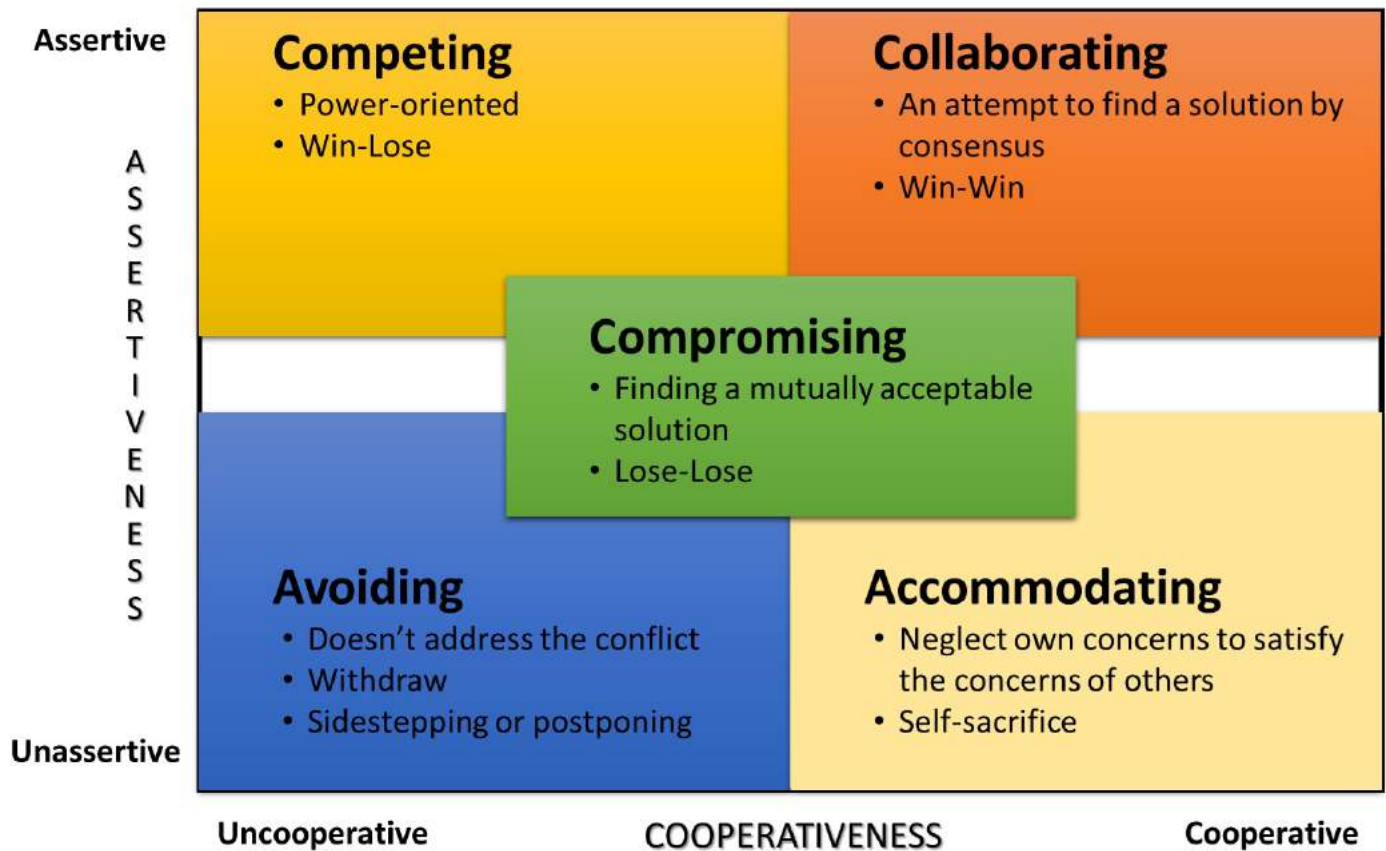

Figure 6.1 Thomas-Kilmann Conflict Mode Instrument

Competing (forcing) is assertive and uncooperative. It is a power-oriented mode. An individual pursues his or her own concerns at the other person's expense, using whatever power seems appropriate to win his or her position.

Collaborating is both assertive and cooperative. An individual attempts to work with the other person to find a solution that fully satisfies the concerns of both. It involves digging into an issue to identify the underlying concerns of the two individuals and to find an alternative that meets both sets of concerns.

Compromising is intermediate in both assertiveness and cooperativeness. The objective is to find an expedient, mutually acceptable solution that partially satisfies both parties. Compromising might mean splitting the difference, exchanging concessions, or seeking a quick middle-ground position.

Avoiding is unassertive and uncooperative. When avoiding, an individual does not immediately pursue his or her own concerns or those of the other person. He or she does not address the conflict. Avoiding might take the form of diplomatically sidestepping an issue, postponing an issue until a better time, or simply withdrawing from a threatening situation.

Accommodating is unassertive and cooperative, which is the opposite of competing. An individual neglects his or her own concerns to satisfy the concerns of the other person. Therefore, there is an element of self-sacrifice in this mode.

Each of these approaches can be effective and useful depending on the situation. Project managers will use each of these conflict resolution approaches depending on the project manager's personal approach and an assessment of the situation. Most project managers have a default approach that has emerged over time and is comfortable. For example, some project managers find the use of the project manager's power the easiest and quickest way to resolve problems. "Do it because I said so" is the mantra for project managers who use competing as the default approach to resolve conflict. The competing approach often succeeds in a situation where a quick resolution is needed, and the investment in the decision by the parties involved is low. Some project managers find accommodating with the client the most effective approach to dealing with client conflict.

Two examples have been provided below in order to elaborate on the conflict resolution methods in projects.

Resolving an Office Space Conflict

Two senior managers both want the office with the window. The project manager intercedes with little discussion and assigns the window office to the manager with the most seniority. The situation was a low-level conflict with no long-range consequences for the project and a solution all parties could accept. Therefore, the project manager applied the competing (forcing) method. Sometimes office size and location are culturally important, and this situation would take more investment to resolve.

Conflict Over a Change Order

In another example, the client rejected a request for a change order because she thought the change should have been foreseen by the project team and incorporated into the original scope of work. The project controls manager believed the client was using her power to avoid an expensive change order and suggested the project team refuse to do the work without a change order from the client. This is a more complex situation, with personal commitments to each side of the conflict and consequences for the project. The project manager needs a conflict resolution approach that increases the likelihood of a mutually acceptable solution for the project.

One conflict resolution approach involves evaluating the situation, developing a common understanding of the problem, developing alternative solutions, and mutually selecting a solution. Evaluating the situation typically includes gathering data. In this example, gathering data would include a review of the original scope of work and possibly of people's understandings, which might go beyond the written scope.

The second step in developing a resolution to the conflict is to restate, paraphrase, and reframe the problem behind the conflict to develop a common understanding of the problem. In our example, the common understanding may explore the change management process and determine that the current change management process may not achieve the client's goal of minimizing project changes. This phase is often the most difficult and may take an investment of time and energy to develop a common understanding of the problem.

After the problem has been restated and agreed on, alternative approaches are developed. This is a creative process that often means developing a new approach or changing the project plan. The result is a resolution to the conflict that is mutually agreeable to all team members. If all team members believe every effort was made to find a solution that achieved the project charter and met as many of the team member's goals as possible, there will be a greater commitment to the agreed-on solution.

6.4.4 Trust

Building trust in a project begins with the project manager. On complex projects, the assignment of a project manager with a high trust reputation can help establish the trust level needed. The project manager can also establish the cost of lying in a way that communicates an expectation and a value for trust in the project. Project managers can also assure that the official goals (stated goals) and operational goals (goals that are reinforced) are aligned. The project manager can create an atmosphere where informal communication is expected and reinforced.

Informal communication is important to establishing personal trust among team members and with the client and other stakeholders. Allotting time during project start-up meetings to allow team members to develop a personal relationship is important to establishing team trust. The informal discussion allows for a deeper understanding of the whole person and creates an atmosphere where trust can emerge.

Small events that reduce trust often take place on a project without anyone remembering what happened to create an environment of distrust. Taking fast and decisive action to establish a high cost of lying, communicating the expectation of honesty, and creating an atmosphere of trust are critical steps a project manager can take to ensure the success of complex projects.

Project managers can also establish expectations of team members to respect individual differences and skills, look and react to the positives, recognize each other's accomplishments, and value people's self-esteem to increase a sense of benevolent intent.

6.4.5 Emotional Intelligence (EQ)

Emotions are neither positive nor negative. Emotions are both a mental and physiological response to environmental and internal stimuli. Project managers need to understand and value their emotions to appropriately respond to the client, project team, stakeholders, and project environment. Daniel Goleman (Goleman, 1995) discussed emotional intelligence quotient (EQ) as a factor more important than IQ in predicting leadership success. Emotional intelligence is the ability to sense, understand, and effectively apply the power and acumens of emotions as a source of human energy, information, connection, and influence (Cooper and Sawaf, 1997).

Emotional intelligence includes the following:

- Self-awareness
- Self-regulation

- Empathy
- Relationship management

Emotions are important to generating energy around a concept, building commitment to goals, and developing high-performing teams. Emotional intelligence is an important part of the project manager's ability to build trust among the team members and with the client. It is an important factor in establishing credibility and open dialogue with project stakeholders. Emotional intelligence is a critical ability for project managers, and the more complex the project profile, the more important the project manager's EQ becomes to project success.

Project Management Institute. (2017). A guide to the Project Management Body of Knowledge (PMBOK guide) (6th ed.). Project Management Institute.

Retrieved from the OER titled "Principles of Management" on

<https://openstax.org/books/principles-management/pages/13-1-the-nature-of-leadership>

Retrieved from the OER titled "Project Management" by Adrienne Watt on

<https://opentextbc.ca/projectmanagement/chapter/chapter-11-resource-planning-project-management/>

Thomas, K. W. (2008). Thomas-Kilman conflict mode. TKI Profile and Interpretive Report, 1-11.

Retrieved from the OER titled "Project Management" by Adrienne Watt on

<https://opentextbc.ca/projectmanagement/chapter/chapter-11-resource-planning-project-management/>

Retrieved from the OER titled "Project Management" by Adrienne Watt on

<https://opentextbc.ca/projectmanagement/chapter/chapter-11-resource-planning-project-management/>

Goleman, D. (1996). Emotional intelligence. Why it can matter more than IQ. *Learning*, 24(6), 49-50.

Cooper, R. K., & Sawaf, A. C. (1997). Executive EQ: Emotional intelligence in leadership and organization (No. 658.409 C7841c Ej. 1 000003).

6.5 Leadership Styles and Servant Leadership

Leadership is a function of both the personal characteristics of the leader and the environment in which the leadership must occur. Several researchers have attempted to understand leadership from the perspective of the characteristics of the leader and the environment of the situation. These researchers described leaders as either autocratic or democratic (Tannenbaum & Schmidt, 1958), as pathfinders (visionaries), problem solvers (analytical), or implementers (team-oriented) (Leavitt, 1986), and as either transactional (focused on actions and decisions) or transformational (focused on the long-term needs of the group and organization) (Burns, 1978).

Fred Fiedler introduced contingency theory and the ability of leaders to adapt their leadership approach to the environment (Fiedler, 1971). Most leaders have a dominant leadership style that is most comfortable. For example, most engineers spend years training in analytical problem solving and often develop an analytical approach to leadership. A leadership style reflects personal characteristics and life experiences. Although a project manager's leadership style may be predominantly a pathfinder (using Leavitt's taxonomy), most project managers become problem solvers or implementers when they perceive the need for these leadership approaches. The leadership approach incorporates the dominant leadership style and Fiedler's contingency focus on adapting to the project environment.

PMBOK Guide 6th Edition provides a list of leadership styles as below:

1. Laissez-faire: Leaders allow the team to make their own decisions and establish their own goals. It is also referred to as taking a hands-off style.
2. Transactional: Leaders focus on goals, feedback, and accomplishment to determine rewards.
3. Servant: Leaders demonstrate a commitment to serve and put other people first. They focus on other people's growth, learning, development, autonomy, and well-being. They concentrate on relationships, community, and collaboration.
4. Transformational: Leaders empower followers through idealized attributes and behaviors, inspirational motivation, encouragement for innovation and creativity, and individual consideration.
5. Charismatic: Leaders are able to inspire with high energy. They are enthusiastic and self-confident and hold strong convictions.
6. Interactional: This leadership style is a combination of transactional, transformational, and charismatic leadership styles.

Among them, the "Agile Practice Guide" accompanying PMBOK Guide Sixth Edition highlights the servant leadership style in particular for the agile project management approach. Although servant leadership isn't unique to agile, project managers and organizations can observe and experience that this leadership style integrates into the agile mindset value. As the name refers, servant leaders serve

those on the team by promoting self-awareness, listening, helping team members and stakeholders improve themselves, coaching rather than controlling, facilitating coordination, removing obstacles and organizational impediments in front of the team, the members, and the project, promoting safety, respect, and trust, and promoting the energy and intelligence of others. We will discuss this leadership style more in Chapter 12 “Agile Project Management”.

No particular leadership approach is specifically appropriate for managing a project. Each project has a unique set of circumstances because, by definition, projects are unique endeavors. The leadership approach and the management skills required to be successful vary depending on the complexity profile of the project. The Project Management Institute published research that studied project management leadership skills and concluded that project managers needed good communication skills and the ability to build harmonious relationships and motivate others (Shi & Chen, 2006). Beyond this broad set of leadership skills, the successful leadership approach will depend on the profile of the project.

A transactional project manager with a strong command and control leadership approach may be very successful on a small software development project or a construction project, where tasks are clear, roles are well understood, and the project environment is cohesive. This same project manager is less likely to be successful on a larger, more complex project with a diverse project team and complicated work processes.

Each project phase may also require a different leadership approach. During the start-up phase of a project, when new team members are first assigned to the project, the project may require a command and control leadership approach. Later, as the project moves into the conceptual development phase, creativity becomes important, and the project management takes on a more transformational type leadership approach. Most experienced project managers can adjust their leadership approach to the needs of the project phase. Occasionally, on very large, complex projects, some companies will change project managers after the conceptual phase of the project to bring in a different project leadership approach or change project managers to manage the closeout of a project. Changing project managers may bring the right level of experience and the appropriate leadership approach but is also disruptive to a project. Senior management must balance the benefit of matching the right leadership approach with the cost of disrupting the project.

Tannenbaum, R., & Schmidt, W. (1958). How to Choose a Leadership Pattern. *Harvard Business Review* 36, 95-101.

Leavitt, H. (1986). *Corporate Pathfinders*. New York: Dow-Jones-Irwin and Penguin Books.

Burns, J.M. (1978). *Leadership*. New York: Harper & Row.

Fiedler, F.E. (1971). Validation and Extension of the Contingency Model of Leadership Effectiveness. *Psychological Bulletin*, 76(2), 128-48.

Project Management Institute, & Agile Alliance. (2017). *Agile practice guide*.

Shi, Q., & Chen, J. (2006). *The Human Side of Project Management: Leadership Skills*. Newtown Square, PA: Project Management Institute, Inc.

6.6 Creating a Project Culture

Project managers have a unique opportunity during the start-up of a project. They create a project culture, something organizational managers seldom have a chance to do. In most organizations, the corporate or organizational culture has developed over the life of the organization, and people associated with the organization understand what is valued, and what behaviors are expected. Edgar Schein defined culture as a pattern of basic assumptions formed by a group on how to perceive and address problems associated with both internal adaptation and external integration (Schein, 1990). While organizational culture constrains, stabilizes, and provides structure to the organization, it is being constantly enacted, created, and shaped by leadership behavior.

A project culture represents the shared norms, beliefs, values, and assumptions of the project team. Understanding the unique aspects of a project culture and developing an appropriate culture to match the project are important project management abilities. Culture is developed through the communication of the priority, the given status, and the alignment of official and operational rules. Official rules are the rules that are stated, and operational rules are the rules that are enforced. Project managers who align official and operational rules are more effective in developing a clear and strong project culture because the project rules are among the first aspects of the project culture to which team members are exposed when assigned to the project. In addition to official and operational rules, the project leadership can communicate what is important by the use of symbols, storytelling, rituals, rewards or punishments, and taboos.

6.6.1 Operational Rules on a Project in India

During the initiation of a project in India, members of the project team were given a policy that stated all travel expense claims must be submitted within three days of completion of travel. During the first few weeks, the administrative team began to understand that this was a difficult policy to enforce without creating moral problems on the project. Instead of changing the official rule, it was seldom enforced. The official rules and operational rules differed.

Later in the project, a worker was injured after crossing an area that was marked as unsafe. Workers indicated that they knew the official rules but it took too much time to go around the unsafe area. They assumed that official rules could be ignored if they were difficult to obey. The difference between official rules and operational rules of the project created a culture that made the communication of the priorities more difficult.

6.6.2 Creating a Culture of Safety

A project manager in South America who wanted to create a strong safety culture on a construction

project with significant safety concerns used several methods to create the desired culture. The very first meeting that project team members attended was a safety orientation. Members were issued a card—a symbol—after the meeting granting permission to participate in the project. The project leadership team told stories of previous projects where people were fired for breaking safety rules and often warned that the fastest way to get fired on the project was to break a safety rule—an example of storytelling. Every project meeting started with a discussion of a safety topic—a ritual—and any discussion of lessening the safety rules was forbidden—taboo—and was quickly and strongly cut off by the project leadership if it occurred.

As can be seen in both examples above, culture guides behavior and communicates what is important and is useful for establishing priorities. On projects that have a strong safety culture, team members feel free to challenge anyone who breaks a safety rule, even managers. The safety aspects of culture are stronger than the cultural aspects of the power of management.

6.6.3 Culture of Stakeholders

When project stakeholders do not share a common culture, project management must adapt its organizations and work processes to cope with cultural differences. Three major aspects of cultural difference that can affect a project are communications, negotiations, and decision-making. Communication is perhaps the most visible manifestation of culture. Project managers encounter cultural differences in communication in language, context, and candor. Language is clearly the highest barrier to communication. When project stakeholders do not share the same language, communication slows down and is often filtered to share only information that is deemed critical. The barrier to communication can influence project execution where quick and accurate exchange of ideas and information is critical. The interpretation of information reflects the extent that context and candor influence cultural expressions of ideas and understanding of information. In some cultures, an affirmative answer to a question does not always mean yes. The cultural influence can create confusion on a project where project stakeholders share more than one culture. It is of high importance to keep in mind that not all cultural differences are related to international projects. Corporate cultures and even regional differences can create cultural confusion on a project.

6.6.4 Culture Affects Communication in Mumbai

A project management consultant from the United States was asked to evaluate the effectiveness of a U.S. project management team executing a project in Mumbai, India. The project team reported that the project was on schedule and within budget. After a project review meeting where each of the engineering leads reported that the design of the project was on schedule, the consultant began informal discussions with individual engineers and began to discover that several critical aspects of the project were behind schedule, and without a mitigating strategy, the project would miss a critical window in the weather between monsoon seasons. The information on the project flowed through a cultural expectation to provide positive information. The project was eventually canceled by the U.S.-based corporation when the market and political risks increased.

Schein, E. H. (1990). Organizational culture (Vol. 45, No. 2, p. 109). American Psychological Association.

Retrieved from the OER titled "Principles of Management" on

<https://openstax.org/books/principles-management/pages/13-1-the-nature-of-leadership>

Retrieved from the OER titled "Principles of Management" on

<https://openstax.org/books/principles-management/pages/13-1-the-nature-of-leadership>

Retrieved from the OER titled "Project Management from Simple to Complex" on

<https://open.lib.umn.edu/projectmanagement/chapter/5-3-creating-a-project-culture/>

6.7 Developing and Managing a Project Team

A team is “a group of individuals who interact interdependently and who are brought together or come together voluntarily to achieve certain outcomes or accomplish particular tasks” (Berry, 2011, p.136). Teams are utilized in organizations to establish novel combinations of people who would work on unique problems and generate critical decisions as outcomes (Gersick, 1988). Much of the work that is performed today in organizations requires a focus on teamwork. The ability to work successfully as a team member, as well as the ability to lead teams, is an ultimate advantage within the workforce. Teams themselves must be managed, in addition to managing just the individuals, to be successful. We’ve all heard the quote originally coined by Aristotle that states that “the whole is greater than the sum of its parts.” This captures the nature of the team perfectly—there is such a synergy that comes from a team that the individuals alone are not able to create.

A team is a collaboration of people with different personalities that is led by a person with a favored leadership style. Managing the interactions of these personalities and styles as a group is an important aspect of project management. The project team is made up of people dedicated to the project. These people, team members, are generally borrowed from other departmental units in an organization or are recruited from outside the organization. They may work full-time, part-time, or in some of the activities when their skills are needed. As discussed in Chapter 3 “Project Initiation”, the formal organizational structure would have a substantial impact on how project teams are created and managed. In a functional organization, project managers may have low authority and control over the resources and budget. Besides, they may not work full time as a project manager as they may still carry out the routine tasks of their functional unit. The main advantage of a functional organization type is that the project manager can acquire qualified and experienced human resources from other functional departments. In a strong matrix organization type, a Project Management Office (PMO) or a designated program management office is added besides functional departments. This department employs full-time project managers with a designated job role. They manage the project budget, and their authority becomes moderate to high. They can also have a full-time administrative staff. This organizational structure may be preferred by many project managers since they can still acquire qualified and experienced team members from functional departments inside the organization. Among functional, weak matrix, strong matrix, and project-oriented organization types, a strong matrix structure may suggest more opportunities for a project manager. However, it is of high importance for a project manager to keep in mind and consider various internal and external factors as well as organizational politics.

In particular, in the functional, weak matrix, and balanced matrix organization types, there may be some difficulties for project managers while dealing with project team members. Since these members are borrowed from other units, they may work at the project less than 100% of their working time, and

project managers may not be their direct supervisors. Their priorities may be elsewhere. Thus, their dedication to the project objectives and activities couldn't reach the level project managers expect from them to accomplish their tasks and responsibilities as desired. They may be juggling more than one project as well as their full-time job and have difficulty meeting deadlines.

Project managers need to provide leadership, direction, and above all, support to team members as they go about accomplishing their tasks. Working closely with the team to solve problems can help project managers learn from the team and build rapport. As some of them have been explained above in the "Leadership Skills" section, managing project team members requires interpersonal skills. Here are some suggestions that can help with more effective team management:

- Involve team members in project planning.
- Arrange to meet privately and informally with each team member at several points in the project, perhaps for lunch or coffee.
- Be available to hear team members' concerns at any time.
- Encourage team members to pitch in and help others when needed.
- Complete a project performance review for team members.

6.7.1 Team Development Stages

One of the models used to describe team development is the Tuckman ladder. According to Tuckman (1965), small groups go through four stages of development which are forming, storming, norming, and performing. As a result of a literature review of fifty-five articles, Tuckman (1965) proposed a model of developmental stages for group settings over time. In respect to the group structure, he labeled these stages as (1) testing and dependence, (2) intragroup conflict, (3) development of group cohesion, and (4) functional role relatedness. Accordingly, he labeled the stages of task activity as (1) orientation to task, (2) emotional response to task demands, (3) open exchange of relevant interpretations, and (4) emergence of solutions. An essential correspondence between the perspectives of group structure and task activity caused Tuckman to summarize the group stages as "forming," "storming," "norming," and "performing." These four stages covered both group interpersonal and task activities. Tuckman and Jensen (1977) added the fifth stage as adjourning after they reviewed twenty-two studies.

The first stage, forming, is characterized by orientation to the group setting, testing the boundaries of interpersonal and task behaviors of other members, and a dependency relationship with the leader. The storming stage following the forming stage is characterized by conflict and polarization around interpersonal issues, with concomitant emotional responses in the task sphere. These behaviors with hidden agendas and prejudices serve as resistance to group influence and task requirements. In the third stage, norming, resistance to authority is overcome, in-group feeling and cohesiveness develop, new standards evolve, and new roles are adopted. In the performing stage, group energy is channeled into the task after the structural issues are resolved and the structure becomes supportive of task performance. The last stage, adjourning, indicates the completion of the project where groups disband, and team members are reassigned to other projects or tasks.

Although these classic stages in group development may not be apparent for all groups, and not all groups may follow them, they would be useful for predicting team performance (Mannix and Jehn, 2004) as well as conflicts and harassment cases within an organized framework. Besides, not all the teams could experience all stages and they may spend different times in stages (Ayoko et al., 2012). Some teams may also face challenges in the transition process from one stage to another, such as moving toward the norming stage from the storming stage. Nevertheless, all teams can find themselves in the performing stage while some of them would spend substantially longer times which could lead them to a higher achievement rating in the end. Johnson et al. (2002) proposed an iterative group development model based on Tuckman's model. In their model based on student virtual learning teams, there was no evidence of the storming stage for all student teams due to rapid movement between each stage given the limited time in accomplishing assignments. Thus, teams moved along forming, norming, and performing stages and they resolved the conflict when it arose among team members. After the conflict was resolved, teams continued the process of forming, norming, and performing.

6.7.2 Virtual Teams

Advances in ICTs have enabled the creation and utilization of virtual teams (VTs) within organizations in the last three decades (Alsharo et al., 2017). The advent of the Internet accompanied by various ICTs, and the emergence of the COVID-19 pandemic by the end of 2019 accelerated the process of digitalization for people, organizations, and governments. Thus, the adoption and spread of ICTs worldwide across organizations and countries increased exponentially. The utilization of global virtual teams in organizations increased to unprecedented levels. 94% of the respondents of CultureWizard's Global Virtual Work Survey indicated that they want to continue working from home—at least part time. These advances ensured the organizations to design their teams composed of members from different geographic locations and organizations virtually beyond a setting of the same location (Berry, 2011). Nevertheless, even though ICTs are prerequisites of VTs, other factors were also prominent in the process of shifting from traditional face-to-face teams to VTs. Some of these factors could be listed as increased use of horizontal organizational structure, the emergence of environments that require inter-organizational cooperation, continued shift from production to service and knowledge-intense work environments, and increasing globalization of trade and corporate activity (Townsend et al., 1998).

Virtual interactions and virtual teams cannot be considered identical concepts. Virtual interactions also occur in collocated teams extensively, such as the widespread exchange of emails in the same office (Berry, 2011). A VT can be distinguished from a face-to-face team in terms of several factors. The most prominent factor would be the use of ICTs as the primary communication and collaboration media. Taking into consideration the utilization of ICTs, VT members are less likely to observe physical behaviors (e.g., gestures and intonation), which face-to-face team members rely upon to establish and sustain trust (Alsharo et al., 2017). Virtual teams have various benefits such as task, resource and schedule flexibility, access to and bringing specialized skills and diverse experiences together in a relatively short time, enhanced knowledge sharing and repository, easier documentation of performance outcomes, and opportunities for accelerated problem solving and solution finding (Jimenez et al., 2017). Virtual teams employ experts who have acquired more flexibility in temporal and spatial

aspects since they save time by not traveling to meet their teammates. These time and cost-saving effects and flexible work schedule benefits are also commonly observed for the teleworkers who work outside of the office by means of virtual communication tools such as teleconferences, videoconferences, and intranets with remote log-in (Coenen and Kok, 2014). The ability to bridge time and space provides the team with the capability to respond and adjust to new tasks more rapidly, and human resources can be distributed more efficiently without physical relocation of employees thus leading to better utilization of human resources. Although flexibility is assumed to generate positive outcomes, it may cause inherent obstacles for virtual teams. The lack of shared work history among team members as well as less face-to-face interaction could bring about trust issues in virtual teams (Coenen and Kok, 2014).

While virtual teams can be confined to a region in a country or the entire country, they can extend beyond national and continental borders when members of VTs work and live in different countries (Pinjani and Palvia, 2013). One of the advantages of flexibility in Global Virtual Teams (GVTs) is easier access to skilled experts all around the world. This ensures the availability of resources in other parts of the world when scarcity exists in the organization's or project's geographical area. The dispersed structure of GVT members around the globe allows a 24-hour relay workflow (Carmel et al., 2010). For instance, members located in Asia and Australia can work on the project during their business hours. They can pass the work on to their colleagues in Europe and Africa for further processing, and then, they can pass it on to the colleagues in the Americas, who can work on it while their more eastern team members are asleep. This follow-the-sun approach creates a cycle of work through which GVT members pass the work on to the members in Asia and Australia, where 24-hour relay starts again (Carmel et al., 2010).

Despite the unprecedented benefits mostly owing to the developments in ICTs, the virtual nature of these teams is not immune to the challenges to effective collaboration and team outcomes (Alsharo et al., 2017). One of the essential challenges in virtual work is the elimination of face-to-face meetings that would otherwise help team members build interpersonal relationships (Cummings and Dennis, 2018). Lack of first impressions of other team members might have a substantial impact on the formation and functioning of the team, and the outcome of the teamwork. Cummings and Dennis (2018) contended that virtual team members examine each other's profiles on enterprise social networking sites to get acquainted with them, otherwise not possible in a dispersed team. Some of the problems that GVTs and their members might encounter can be enumerated as lack of trust, language and time barriers, cultural differences, lack of onsite monitoring, lack of tone and body language, and different interpretations by the members due to the lack of cues. Eventually, if these likely challenges are not addressed by the GVT leaders and upper hierarchical levels in the organization, virtual teams may cause disadvantages to the team members' well-being and job satisfaction, and team performance.

Team diversity or heterogeneity might have either a positive or negative impact on a team's performance. Although team diversity could exacerbate the conflict and emotional reactions in GVTs (Ayoko et al., 2012), and team members can build higher trust and cohesiveness in homogeneous teams (Drescher and Garbers, 2016), team diversity, on the contrary, could improve GVT effectiveness (Jimenez et al., 2017). The diverse backgrounds of team members could provide representation and

exchange of different opinions and perspectives within the team. Hence, this process can create value by providing a more extensive range of information sources and thus aiding creativity and problem solving, and a higher level of organizational learning and synergy (Berry, 2011; Jimenez et al., 2017).

CultureWizard's Global Virtual Work Survey pointed to complications in global virtual teams such as difficulty in building relationships (37%), managing conflict (33%), and lack of responsiveness from team members (20%). The survey also highlighted an issue with the technology as it cannot completely erase the barriers of miscommunication. The survey indicated that 75% of respondents use webcams to compensate for lack of face-to-face contact, but webcams come with their complications, such as ambient noise, feeling pressure to look attentive and professional on camera, and technical issues such as insufficient bandwidth or difficulty in operating new software.

Berry, G. R. (2011). Enhancing effectiveness on virtual teams: Understanding why traditional team skills are insufficient. *The Journal of Business Communication* (1973), 48(2), 186-206.

Gersick, C. J. (1988). Time and transition in work teams: Toward a new model of group development. *Academy of Management Journal*, 31(1), 9-41.

Tuckman, B. W. (1965). Developmental sequence in small groups. *Psychological Bulletin*, 63(6), 384.

Tuckman, B. W., & Jensen, M. A. C. (1977). Stages of small-group development revisited. *Group & Organization Studies*, 2(4), 419-427.

Mannix, E., & Jehn, K. A. (2004). Let's norm and storm, but not right now: Integrating models of group development and performance. In *Time in groups* (pp. 11-37). Emerald Group Publishing Limited.

Ayoko, O. B., Konrad, A. M., & Boyle, M. V. (2012). Online work: Managing conflict and emotions for performance in virtual teams. *European Management Journal*, 30(2), 156-174.

Johnson, S. D., Suriya, C., Yoon, S. W., Berrett, J. V., & La Fleur, J. (2002). Team development and group processes of virtual learning teams. *Computers & Education*, 39(4), 379-393.

Alsharo, M., Gregg, D., & Ramirez, R. (2017). Virtual team effectiveness: The role of knowledge sharing and trust. *Information & Management*, 54(4), 479-490.

Culture Wizard. 2020 Trends in Global Virtual Work: Metamorphosis of the Global Workplace. 2020. <https://www.rw-3.com/virtual-teams-exec-report-2020>

Berry, G. R. (2011). Enhancing effectiveness on virtual teams: Understanding why traditional team skills are insufficient. *The Journal of Business Communication* (1973), 48(2), 186-206.

Townsend, A. M., DeMarie, S. M., & Hendrickson, A. R. (1998). Virtual teams: Technology and the workplace of the future. *Academy of Management Perspectives*, 12(3), 17-29.

Alsharo, M., Gregg, D., & Ramirez, R. (2017). Virtual team effectiveness: The role of knowledge sharing and trust. *Information & Management*, 54(4), 479-490.

Jimenez, A., Boehe, D. M., Taras, V., & Caprar, D. V. (2017). Working across boundaries: current and future perspectives on global virtual teams. *Journal of International Management*, 23(4), 341-349.

Coenen, M., & Kok, R. A. (2014). Workplace flexibility and new product development performance: The role of telework and flexible work schedules. *European Management Journal*, 32(4), 564-576.

Pinjani, P., & Palvia, P. (2013). Trust and knowledge sharing in diverse global virtual teams. *Information & Management*, 50(4), 144-153.

Carmel, E., Espinosa, J. A., & Dubinsky, Y. (2010). "Follow the Sun" Workflow in Global Software Development. *Journal of Management Information Systems*, 27(1), 17-38.

- Cummings, J., & Dennis, A. (2018). Virtual First Impressions Matter: The Effect of Enterprise Social Networking Sites on Impression Formation in Virtual Teams. *MIS Quarterly*, 42(3), 697-717.
- Ayoko, O. B., Konrad, A. M., & Boyle, M. V. (2012). Online work: Managing conflict and emotions for performance in virtual teams. *European Management Journal*, 30(2), 156-174.
- Drescher, G., & Garbers, Y. (2016). Shared leadership and commonality: A policy-capturing study. *The Leadership Quarterly*, 27(2), 200-217.

6.8 Key Takeaways

Key Takeaways

- Project managers spend 90% of their time communicating with team members and stakeholders.
- ICTs (Information and Communication Technologies) can facilitate faster and better communication, or they can become a barrier if they are not well understood and applied appropriately.
- The communication management plan documents the types of information needs the stakeholders have, when the information should be distributed, how the information will be delivered with which frequency, who will receive it, and the format and technologies we will use to communicate.
- If all the parties to the communication are taking part in the exchange at the same time, the communication is synchronous. Many types of communication do not require that the parties are present at the same time. This type of communication is asynchronous.
- PMBOK Guide Sixth Edition differentiates among three skill sets project managers should possess – technical project management, leadership, and strategic and business management.
- Working with other people involves dealing with them both logically and emotionally.
- Active listening is placing oneself in the speaker's position as much as possible, understanding the communication from the point of view of the speaker, listening to the body language and other environmental cues, and striving not just to hear, but to understand.
- Negotiation is a process for developing a mutually acceptable outcome when the desired outcome for each party conflicts.
- Thomas-Kilmann Conflict Mode Instrument (TKI) defines five methods of dealing with conflict on a scale of assertiveness and cooperativeness: (1) Competing, (2) Collaborating, (3) Compromising, (4) Avoiding, and (5) Accommodating.
- Emotional intelligence is an important part of the project manager's ability to build trust among the team members and with the client. It is an important factor in establishing credibility and open dialogue with project stakeholders.
- Servant leaders serve by promoting self-awareness, listening, helping team members and stakeholders improve themselves, coaching rather than controlling, facilitating coordination, removing obstacles and organizational impediments in front of the team, the members, and the project, and promoting the energy and intelligence of others.
- Project culture is developed by communicating priority, status, and the alignment of official and operational rules. It is enforced through the use of symbols, storytelling, rituals, rewards or punishments, and taboos.
- A team is a collaboration of people with different personalities that is led by a person with a favored leadership style. Managing the interactions of these personalities and styles as a group is an important aspect of project management.
- According to the Tuckman Ladder, teams pass through five stages – forming, storming, norming, performing, and adjourning.

- One of the essential challenges in virtual work is the elimination of face-to-face meetings that would otherwise help team members build interpersonal relationships.

6.9 Questions and Exercises

There are 6 questions for this chapter. As you submit each answer, you will get immediate feedback and be taken to the next question.

An interactive or media element has been excluded from this version of the text. You can view it online here:

<https://pressbooks.ulib.csuohio.edu/project-management-navigating-the-complexity/?p=459>

6.10 Attribution

This chapter is a derivative of the following texts:

1. [Project Management by Adrienne Watt](#). © [CC BY \(Attribution\)](#).
2. [Project Management from Simple to Complex](#). © [CC BY \(Attribution\)](#).
3. [Project Management by Florence Daddey](#). © [CC BY \(Attribution\)](#).
4. [Project Management Fundamentals by Shelly Morris](#). © [CC BY \(Attribution\)](#).
5. [Project Management by Merrie Barron and Andrew R. Barron](#). © [CC BY \(Attribution\)](#).
6. [Principles of Management](#) © [CC BY \(Attribution\)](#).

Chapter 7. Scheduling

7.0 Learning Objectives & Overview

Learning Objectives

1. Describe the process to create a project schedule.
2. Define activities based on Work Breakdown Structure (WBS).
3. Describe how activities can be sequenced.
4. Elaborate on the techniques to estimate activity duration.
5. Create a network diagram by identifying the early start and early finish times, late start and late finish times, floats (slacks), and the critical path.
6. Practice on Microsoft Project to create a Gantt Chart and an Activity Network Diagram.

Overview

The project schedule is one of the triple project constraints besides scope and cost (budget). A project manager is responsible for planning, developing, managing, monitoring, and controlling the project schedule to ensure that project objectives can be achieved, and project outcomes can be delivered to the client and customers on time. Effective schedule management is integral to overall project success. The objective is to create a schedule that effectively and efficiently uses allocated resources to complete the project in the shortest amount of time possible. In order to develop a schedule, we first need to create a plan that will guide us during the project. Afterward, we should define the activities based on the WBS, sequence them in the right order, estimate the time it will take to complete these activities, and develop a schedule by creating a network diagram and Gantt chart.

7.1 Project Schedule Management Plan

As described in Chapter 4, project planning is at the heart of the project life cycle and tells everyone involved where we are going and how we are going to get there. It involves creating a set of plans to help guide our team through the implementation and closure phases of the project. The project schedule management plan is one of the sub-plans of our overall project plan. It provides the guidelines to project managers on how to develop a project schedule by defining and sequencing project activities and milestones, and by estimating activity durations. It is the process of establishing the policies, procedures, and documentation for planning, developing, managing, executing, and controlling the project schedule.

A project schedule management plan can consist of the following:

- **Unit of measurement**
 - Work hours, days, weeks, months
 - Daily working hours and shifts
 - Weekends and/or off-days
 - Local, national, and federal holidays
- **Creation of the activity list and attributes**
 - Describe how activities and their attributes will be defined, and who will be involved in this process.
- **Level of accuracy**
 - Acceptable range to ensure realistic activity duration estimates
 - Evaluation of the impact of risks on the overall project duration and each individual activity durations based on the project risk management plan
 - Methods describing how the schedule contingencies will be assessed.
- **Activity duration estimates**
 - Estimation methods (e.g., analogous, parametric, three-point, bottom-up)
- **Methods, tools, and software utilized to develop, manage, and monitor project schedule**
 - Specify the organization's procedures, policies, and resource calendars if they should be utilized.
 - Methods and tools such as Gantt Chart, WBS, project baseline, master and milestone schedule, Earned Value Management, and critical path method
 - Software such as Microsoft Project Professional, Excel, Visio, and Jira (for Kanban and Scrum), and online collaboration tools such as Monday, Trello, and Basecamp.
- **Rules and concepts to sequence activities and create an activity network diagram**

- Critical path method (Forward pass, backward pass, slacks)
- Critical chain method
- Predecessor dependencies (e.g., finish-to-start, start-to-start)
- **Rules for monitoring schedule performance**
 - Earned Value Management (EVM)
 - Control thresholds for deviations from the parameters in the schedule baseline
 - Using software such as Microsoft Project
- **Reporting formats**
 - Reporting formats and frequency should be in alignment with other project plans.
- **Approval of the schedule baseline**
 - Who will be responsible for preparation and control?
 - Who will approve the schedule baseline?

Project Management Institute. (2017). A guide to the Project Management Body of Knowledge (PMBOK guide) (6th ed.). Project Management Institute.

7.2 Defining Activities

In line with the project schedule management plan, we should start scheduling the whole project by defining activities based on the WBS (Work Breakdown Structure). The activity definition process is a further breakdown of the work package elements of the WBS. It documents the specific activities needed to fulfill the deliverables detailed in the WBS. These activities are not the deliverables themselves but the individual units of work that must be completed to fulfill the deliverables. Activity definition uses everything we already know about the project to divide the work into activities that can be estimated. We might want to look at all the lessons learned from similar projects our organization has done to get a good idea of what you need to do on the current one.

Detailed planning begins by identifying all the tasks to be completed. The project team begins by reviewing the scope of the project which is found in the project scope statement (predictive/waterfall projects) or the product backlog (see Chapter 12 for agile projects). A WBS allows the team to have a visual representation of the forthcoming work. As discussed in Chapter 4, the WBS is a powerful planning tool. By breaking the project down into smaller, more manageable components, the WBS assists project managers in identifying the specific tasks. The team then determines how long it will take to complete the required tasks.

Expert judgment from project team members with prior experience and from stakeholders that can be consulted can help us define activities while developing project scope statements and WBS. If we are asked to manage a project in a new domain, we could use subject matter experts in that particular field to help define tasks so we can understand what activities are going to be involved. We may want to create an activity list and then have the expert review it and suggest changes. Alternatively, we could involve the experts from the very beginning. Please see “7.3: Estimating Activity Durations” for more explanation regarding expert judgment.

Sometimes we start a project without knowing a lot about the work that we will be doing later. Rolling-wave planning lets us plan and schedule only the portion that we know enough about to plan well. When we don't know enough about a project, we can use placeholders for the unknown portions until we know more. These are extra items that are put at high levels in the WBS to allow us to plan for the unknown.

When we identify activities for the work packages, we can detail the activities in a project activity list which is a list of everything that needs to be done to complete the project, including all the activities that must be accomplished to deliver each work package with activity attributes. This list can consist of, but is not limited to:

1. Activity identifier

2. WBS number
3. Activity title
4. Scope of Work
5. The person responsible (RACI chart can be used. See Chapter 5)
6. Related activities
 - a. Higher level activities (WBS number)
 - b. Lower level activities (WBS number)
 - c. Predecessors (including dependencies, that are FS, FF, SF, SS)
 - d. Successors (including dependencies, that are FS, FF, SF, SS)
7. Resource requirements
8. Activity location
9. Level of effort required
10. Activity assumptions
11. Activity constraints

The example in Table 7.1 is based on the project charter we developed in Chapter 3 (Case Study 3.1: Project Charter of Grocery LLC’s Mobile-Commerce Project), and the WBS we developed in Chapter 4 (Case Study 4.1: WBS of Grocery LLC’s M-Commerce Project). In Table 7.1, we focus on Activity 1.3 “Preparation of Project Charter” in the WBS. Under Activity 1.3, we determined six activities that can serve as the lowest level of activities, which are work packages. That would make it possible for us to allocate resources in Chapter 8.

Table 7.1: Activity List Template (Adapted from a template on www.projectmanagement.com)

Activity List for Project “Grocery LLC’s M-Commerce Project”				
Activity identifier	Activity title	Scope of Work	Person Responsible	Predecessors
1.3	Preparation of Project Charter	The project charter that will authorize the project manager to undertake the responsibility of the project and apply the resources to project activities will be prepared.	Project Manager	1.1 1.2 1.3
1.3.1	Develop high-level scope	The high-level scope consists of the project purpose, measurable project objectives, high-level requirements, project description, boundaries, key deliverables, and assumptions and constraints.	Team Member 1	1.2
1.3.2	Identify overall project risks	This includes the identification of the risks that affect the project in general.	Team Member 2	1.3.1
1.3.3	Develop high-level schedule	This includes the estimation of the overall schedule with summary milestones.	Team Member 1	1.3.1
1.3.4	Identify main resources and develop a high-level budget	This includes the initial estimation of all resources (human resources, physical resources, and services), and the budget.	Team Member 2	1.3.3
1.3.5	Identify key stakeholders and project team member roles	Stakeholders with high-interest levels and/or power levels will be identified. The project team’s composition will be created. The qualifications required should be detailed. The project sponsor’s authority will be detailed.	Team Member 3	1.3.1 1.3.2

1.3.6	Develop project approval requirements and project exit criteria	Based on the project scope and other sections of the project charter, project approval requirements and exit criteria should be detailed. Exit criteria include the conditions that describe the early termination of the project.	Team Member 1, 2, 3	1.3.1 1.3.2 1.3.3 1.3.4 1.3.5
-------	---	--	---------------------	---

We can explain each column available in Table 7.1 as below:

Activity Identifier: Once the WBS is created for the project, the list of activities required to complete each work package needs to be developed by the project team. Each activity then needs to be assigned an Activity ID, which is placed in this column. The activity ID serves as a reference identification number during planning, developing, and controlling the project schedule.

Activity List: The name/unique label for the activity (in brief) is placed in this column.

Scope of Work: The description of work required to be done to complete the activity is placed in this column (in as much detail as possible).

Person Responsible: One person or more than one who will be responsible for delivering the activity must be mentioned in this column. It is always good to have a primary and an alternate team member assigned to this responsibility.

7.3 Estimating Activity Durations

After we define the lowest level of activities in an activity list, each activity is reviewed and evaluated to determine the duration (how long it will take to accomplish from beginning to end) and what resources (e.g., human resources, materials, facilities, and equipment) are needed. An estimate is an educated guess based on knowledge, experience, and inference—the process of deriving conclusions based on assumptions. The accuracy of the estimate is related to the quality of the knowledge and how that knowledge is applied. The person with the most knowledge may not be the most objective person to provide duration estimates. The person responsible for the work may also want to build in extra time. Therefore, multiple inputs into the duration estimate and a more detailed WBS help reduce bias—the making of decisions based on a prejudged perspective.

It is of high importance here to highlight how a milestone is different from an activity. A milestone is a significant point or event in a project. Milestones have zero duration because they represent a significant point or event. A milestone list identifies all project milestones and indicates whether the milestone is mandatory, such as those required by contract, or optional, such as those based on historical information.

The unit of time used to develop the activity duration is a function of the level of detail needed by the user of the schedule. The larger and more complex the project, the greater the need for detail, which usually translates into shorter durations for activities. However, it is common to use two types of units – one is days or weeks for activities, and hours to display the work hours.

In this textbook, we can elaborate on five types of estimation methods:

1. **Expert judgment:** The project team consults domain and implementation subject matter experts who have technical knowledge and experience in the areas the project activities are related to. If we are developing a new mobile application, we can consult software engineers, developers and testers, and systems analysts who were involved in activities to develop other mobile applications. They can provide us with the information regarding scheduling estimates for each activity we are planning to carry out.
2. **Appropriation method (Analogous estimating):** Actual durations from similar projects are reviewed, and the same proportions are applied to the current project. However, internal and external factors that affected the previous projects, and those that may affect the current project should be taken into account. Identified risks with their probability and impact considered could have a significant influence on duration estimates for the current project.
3. **Parametric estimating:** In this estimation technique, we can use equations and algorithms to calculate the duration based on the resources we use and how many hours they need to work,

or how many of them we need to use. This method is quantitative. We can multiply the quantity of work to be performed by the number of hours per unit of work. If we can estimate the amount of the work, we can divide it by the work that can be done in an hour. For example, let's assume that, in our m-commerce project, we estimated that software developers need to create 200 lines of code for a module. Based on the previous projects and the feedback we received from the subject matter experts, we have estimated that a developer can finish 40 lines in an hour. Therefore, a developer needs 5 hours to finish all 200 lines. We can also add a one-hour break and two-hour review for this task. Therefore, the total work hours amount to 8 hours which is translated to one day in our schedule. Another example can be regarding the installation of cables in an infrastructure project. If workers can install 100 feet of cable per hour, the duration required to install 1,000 feet would be 10 hours (1,000 feet divided by 100 feet per hour). This technique can produce higher levels of accuracy depending on the sophistication and underlying data built into the model. Parametric schedule estimates can be applied to a total project or segments of a project, in conjunction with other estimating methods. Entering data about the project into a formula, spreadsheet, or computer program produces a duration estimate by extrapolating information from a database of actual durations from past projects.

4. **Three-point estimates:** Duration estimates are done based on three scenarios:
 - a. A realistic estimate (most likely to occur - m)
 - b. An optimistic estimate (best-case scenario - o)
 - c. A pessimistic estimate (worst-case scenario - p)

In the three-point estimation method, two distributions are possible - triangular and beta. In triangular distribution, all three duration estimates get the same weight. In a beta distribution, the realistic estimate gets four-sixths of the weight whereas the other two estimates have one-sixth of the weight.

Triangular distribution:

$$tE = \frac{(o + m + p)}{3}$$

Beta distribution:

$$tE = \frac{(o + 4m + p)}{6}$$

Let's estimate the duration of the "1.3 Preparation of Project Charter" sub-activities. Our team gathered together in a meeting to review and discuss alternative durations. We also consulted subject matter experts who work in relevant departments in our organization and also external stakeholders who have an interest and/or power. Our organization and the team had implemented software and website development projects as well as several mobile application development projects. Therefore, we have reports including information regarding the realized durations and lessons learned. So, we can start with analogous estimating first. As we have already worked on similar projects, that would facilitate the estimation process both for schedule and budget. We can place the historical information on the Most Likely column. Based on the expert judgment, lessons learned, and discussions during our team meeting, we determined pessimistic and optimistic durations in Table 7.2.

Table 7.2: Estimating Activity Duration by Applying Three-Point Estimate Method

Duration Estimation (in business days)					
Activity identifier	Activity title	Optimistic	Most Likely	Pessimistic	Duration
1.3.1	Develop high-level scope	3	4	6	4.17
1.3.2	Identify overall project risks	3	5	9	5.33
1.3.3	Develop high-level schedule	4	6	10	6.33
1.3.4	Identify main resources and develop a high-level budget	1	2	5	2.33
1.3.5	Identify key stakeholders and project team member roles	5	7	12	7.50
1.3.6	Develop project approval requirements and project exit criteria	3	5	9	5.33

The computation of the duration for Activity 1.3.2 is shown below:

$$t_E = \frac{(o + 4m + p)}{6} = \frac{(3 + 4 * 5 + 9)}{6} = 5.33 \text{ days}$$

We can roll the duration estimates down or up to the nearest integral number.

- WBS method (Bottom-up estimating):** In this method, we start from the lowest level activities in the WBS - work packages. After we estimate the duration for all six activities (Table 7.2), we can find the duration of the parent activity, 1.3 "Preparation of Project Charter". The addition of duration for all six activities wouldn't be an operation of adding all numbers (4+5+6+2+8+5), which is equal to 30 days. We must consider the dependencies between the activities, which are detailed in sections numbered 7.4 and 7.5 of this chapter. Hence, we can find 22 days for 1.3. The same bottom-up estimating is applied to the activities (1.1., 1.2, 1.3, 1.4, 1.5), and the duration for "1. Scope" is found as 35 days. "1.6 Completion of the Scope Phase" is a milestone and has a duration of zero. The overall duration for "1. Scope"

is computed as 35 days as seen in Table 7.3.

Table 7.3. Schedule for Scope activities with durations rolled up in the higher levels

WBS	Activity Name	Duration	Start	Finish	Predecessors
1	Scope	35 days	Mon 5/2/22	Mon 6/20/22	
1.1	Clarify project purpose and determine project scope	5 days	Mon 5/2/22	Fri 5/6/22	
1.2	Secure project sponsorship	1 day	Mon 5/9/22	Mon 5/9/22	1.1
1.3	Preparation of project charter	22 days	Tue 5/10/22	Wed 6/8/22	
1.3.1	Develop high-level scope	4 days	Tue 5/10/22	Fri 5/13/22	1.2
1.3.2	Identify overall project risks	5 days	Mon 5/16/22	Fri 5/20/22	1.3.1
1.3.3	Develop high-level schedule	6 days	Mon 5/16/22	Mon 5/23/22	1.3.1
1.3.4	Identify main resources and develop a high-level budget	2 days	Tue 5/24/22	Wed 5/25/22	1.3.3
1.3.5	Identify key stakeholders and project team member roles	8 days	Mon 5/23/22	Wed 6/1/22	1.3.1 1.3.2
1.3.6	Develop project approval requirements and project exit criteria	5 days	Thu 6/2/22	Wed 6/8/22	1.3.1 1.3.2 1.3.3 1.3.4 1.3.5
1.4	Approval of project charter by the sponsor	2 days	Thu 6/9/22	Fri 6/10/22	1.3.6
1.5	Secure core resources	5 days	Mon 6/13/22	Fri 6/17/22	1.4
1.6	Completion of the scope phase	0 days	Mon 6/20/22	Mon 6/20/22	1.5

Project Management Institute. (2017). A guide to the Project Management Body of Knowledge (PMBOK guide) (6th ed.). Project Management Institute.

Project Management Institute. (2017). A guide to the Project Management Body of Knowledge (PMBOK guide) (6th ed.). Project Management Institute.

7.4 Creating an Activity Network Diagram

After we define the activities and estimate their duration, we are ready to create an activity network diagram which is a graphical representation of the logical relationship (i.e., dependencies) among the project activities. Duration estimation can also accompany the creation of an activity network. The process can be iterative, and the project team can move back and forth to refine the activities, durations, and their relationships with other activities.

Activities are carried out in order. Therefore, they have predecessors and successors. They have logical relationships or dependencies which show the sequence in which the activities are to be performed. There are four relationships between activities, which can be indicated as “Finish-to-Start” (FS), “Finish-to-Finish” (FF), “Start-to-Start” (SS), and “Start-to-Finish” (SF). The most common relationship is Finish-to-Start at which we start a successor activity once we finish the predecessor activity. Microsoft Project also uses FS as the default relationship. In the MS Project tutorial below, this topic has been also discussed. A start-to-Finish relationship is very rarely used.

Showing the activities in rectangles or circles, and their relationships (dependencies) as arrows is called a precedence diagramming method (PDM). This kind of diagram is also called an activity-on-node (AON) diagram (Figure 7.1). Another way to show how tasks relate is with the activity-on-arrow (AOA) diagram (Figure 7.1). AOA diagram is traditionally drawn using circles as the nodes, representing the beginning and ending points, and the arrows representing activities. AON is more commonly used and is supported by all project management programs. In this textbook, as is also used by PMBOK Guide Sixth Edition, we are using AON diagrams for creating activity network diagrams. Although we used circles in Figure 7.1 for AON, the most common implementation is to use rectangles. Microsoft Project uses rectangles as well.

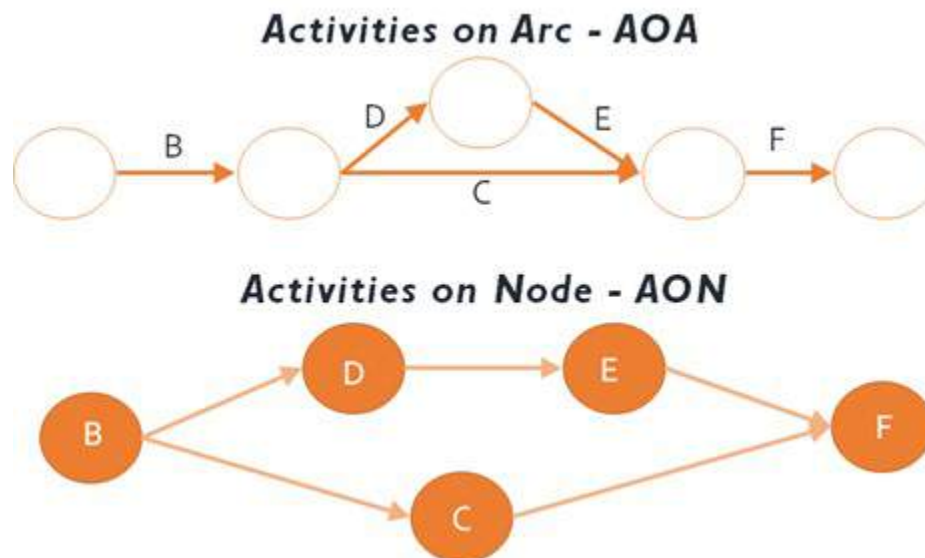

Figure 7.1: Activity Networks (either on Arc or Node)

7.4.1 Logical Relationships / Dependencies

As explained above, four logical relationships can be used in the precedence diagramming method while creating activity network diagrams. Besides these relationships, we will also discuss lags and leads.

Finish-to-Start (FS) Relationship

In this relationship, a predecessor activity should be finished in order to start the successor activity. This is the most common relationship between activities. As seen in Figure 7.2, Activity A must be finished to start Project B.



Figure 7.2: Finish-to-Start

Examples:

- We need to assemble all hardware and network components of a laptop (predecessor) to install the operating system on this laptop (successor).
- We must finish cooking all our meals (predecessor) to start serving them in the dinner (successor).
- We should finish packing all the luggage to start driving to the airport for the holiday.

Lag

A lag is the amount of time a successor activity can be delayed with respect to a predecessor activity. Consider that we should paint one room in our house. We need to apply plaster to walls first

(predecessor). When the walls dry, we can paint them (successor). It is an FS relationship. However, we need to wait for two days for the walls to dry. This causes a two-day delay between two activities which is called a lag (Figure 7.3).

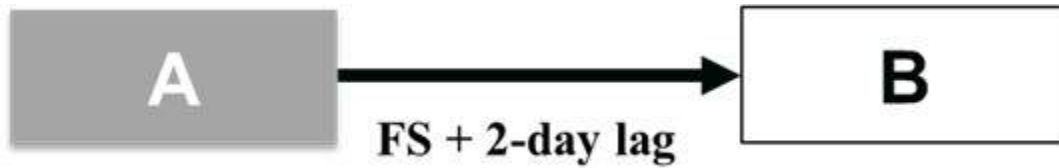

Figure 7.3: Finish-to-Start with a Lag

Lead

A lead is the opposite of a lag. A lead is the amount of time a successor activity can be advanced with respect to a predecessor activity. In Figure 7.4, Activity B (successor) can start three days before Activity A (predecessor) finishes. For example, in the project, we should elicit the requirements of stakeholders first. Then, we can start designing the product based on the requirements. If we have ten stakeholder groups, and five of them are key stakeholders, we can start the design before we finish all the elicitation.

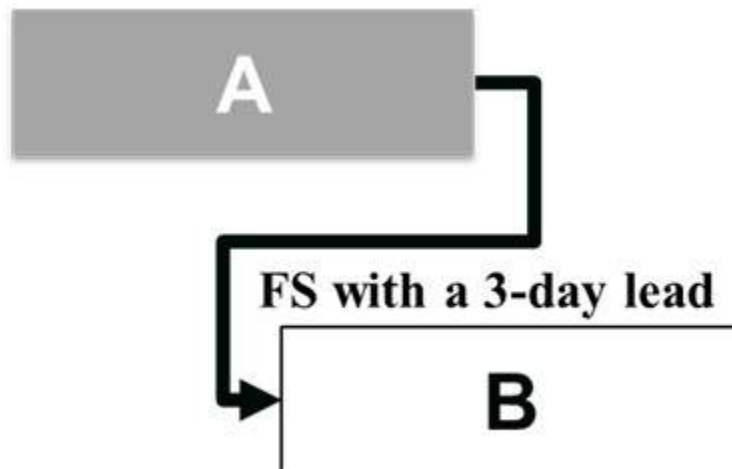

Figure 7.4: Finish-to-Start with a Lead

Finish-to-Finish (FF) Relationship

In this relationship, we cannot finish a successor activity (Activity B) if we don't finish a predecessor activity (Activity A). Therefore, Activity A must be finished to ensure that we can finish Activity B as well (Figure 7.5). These tasks can be carried out in parallel. It is common to have a lag between the predecessor and successor.

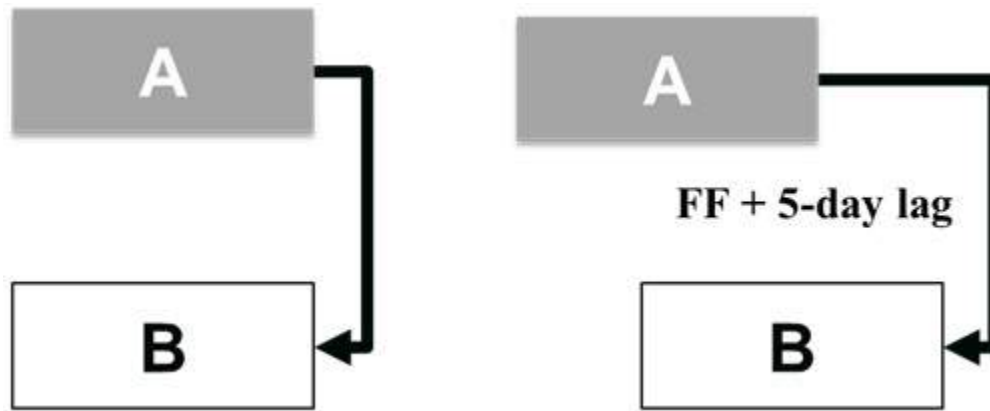

Figure 7.5: Finish-to-Finish

Examples:

- We are writing a new textbook, and it has 15 chapters. When we finish writing Chapter 15, we can complete the book.
- The contractor is finishing the installation of gas lines and plumbing in our new house (predecessor - Activity A). Another contractor who will install the kitchen appliances can finish the installation of these appliances (successor - Activity B) when gas lines and plumbing are done. The second contractor will finish the installation of appliances five days after the predecessor activity is completed. So, there is a lag of five days (Figure 7.5).

Start-to-Start (SS) Relationship

In this relationship, a successor activity (B) cannot start until we start the predecessor activity (A). Like a finish-to-finish relationship, it is possible to see a lag between these two activities. In Figure 7.6, the relationship on the right illustrates a 5-day lag. Activity B can start five days after Activity A starts.

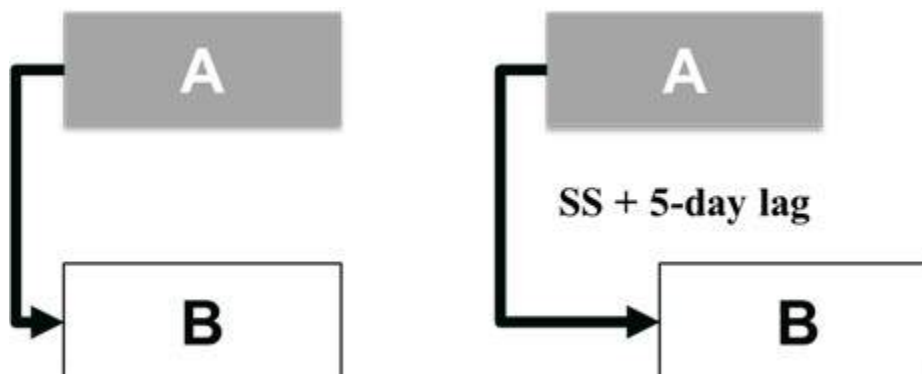

Figure 7.6: Start-to-Start

Examples:

- When developers start coding in a software project, testers may not need to wait until they finish all the coding. They can start testing after the coding starts. However, they may need to wait for several hours or days to start testing since some of the coding should be done so that

the testers have an adequate number of lines to test. This delay is named “lag” as explained above and also in the “Finish-to-Finish” relationship.

- We are drafting a user manual for our product (predecessor). This manual must be also reviewed to make it ready for publishing (successor). In order to start this review, we should start drafting the manual.

Start-to-Finish (SF) Relationship

This is the rarest relationship between project activities. Activity B (successor) cannot finish until Activity A (predecessor) activity has started (Figure 7.7). Consider that we developed a new order processing software. In the meantime, we still need to use the current software not to cause any interruptions in our operations. Activity A is “Shutting down the current software” while Activity B is “Making the new software operational”. We can finish Activity B when we start Activity A.



Figure 7.7: Start-to-Finish

7.4.2 Exercise to Create an Activity Network Diagram

Our exercise to create an activity network diagram starts with Table 7.4 below. We are assuming that all the dependencies are finish-to-start, and there are no lags or leads in this exercise. We will add other types of dependencies as well as lags and leads in the 7.6 Microsoft Project Professional tutorial.

Table 7.4: Activities

Activity	Duration (week)	Predecessors
A	1	-
B	2	-
C	2	A
D	4	A
E	1	B
F	2	C, D
G	3	E
H	1	G
I	4	G
J	1	F
K	3	J, H
L	4	I
M	1	K, L

We are using rectangular nodes for each activity with labels on them. Different software programs can be utilized to create these nodes. In this exercise, we are using Microsoft Visio. When we click “New” and search “PERT Chart” on Visio, we can select “PERT Chart” to open a new sheet. PERT stands for “Program Evaluation Review Technique”. It was developed by Booz-Allen and Hamilton as part of the United States Navy’s Polaris missile submarine program. PERT is a method for analyzing the tasks involved in completing a project, especially the time needed to complete each task, the dependencies among tasks, and the minimum time needed to complete the total project. Another method, CPM, the critical path method was developed in a joint venture by DuPont Corporation and Remington Rand Corporation for managing plant maintenance projects. The critical path determines the float, or schedule flexibility, for each activity by calculating the earliest start date, earliest finish date, latest start date, and latest finish date for each activity. This will be discussed in detail in the following sections (7.4.3 and 7.4.4). Rather than dealing with both methods separately, project managers use these methods together as they have been treated as a single method over time.

On Microsoft Visio, from PERT Chart Shapes, we drag PERT 1 shape (node) to the blank page. Activities are named as tasks here as is the case with Microsoft Project. We can choose the black color to fill and make the text white color for a good contrast. We can copy this shape, and paste it as needed. In our exercise, we have 13 nodes in total.

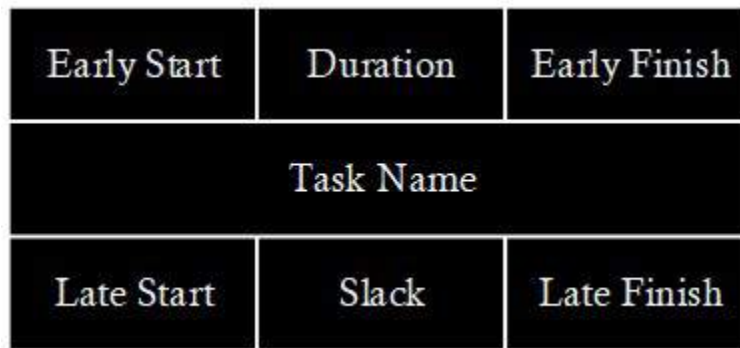

Figure 7.8: Activity Node with Labels

An activity node includes the labels as seen in Figure 7.8.

- Early Start (ES): The earliest time we can start an activity.
- Duration: How long it takes to finish all the tasks in an activity. It can be hours, days, weeks, or months.
- Early Finish (EF): The earliest time we can finish an activity.
- Late Start (LS): The latest time we can start an activity. Some activities may have some flexibilities (slacks or floats) that allow us to have some delay to start without affecting the overall project duration and other activities.
- Late Finish (LF): The latest time we can finish an activity. Based on the slacks (floats), we can finish an activity later than its scheduled completion time.
- Slack (Float): It is the difference between LS and ES, or between LF and EF. Both subtractions generate the same result.

In order to connect nodes, we can drag a line connector to the Visio page and connect two activities (Figure 7.9).

Figure 7.9. Connecting a Predecessor to its Successor (FS dependency)

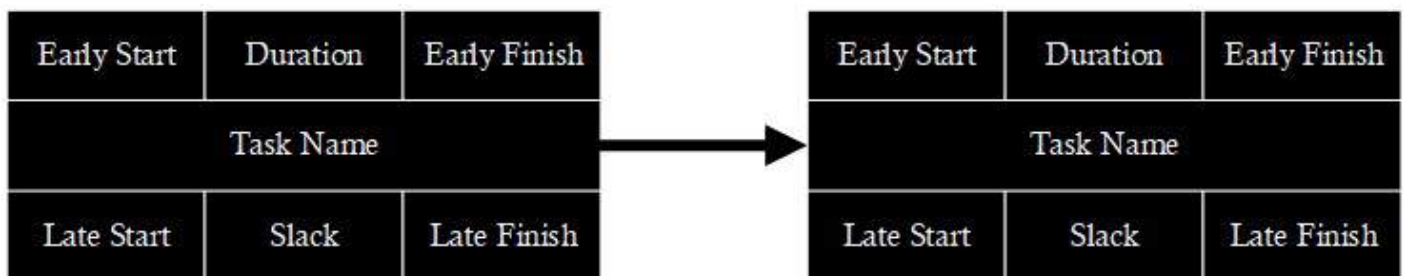

Figure 7.9. Connecting a Predecessor to its Successor (FS dependency)

We should place each activity node on the diagram by adhering to their precedence relationships with other activities (Table 7.4). After we connect all the nodes, we can type the duration for each activity as can be seen in Figure 7.10. All other parts in the nodes are zero for now. Besides, as all the dependencies are finish-to-start, the arrows (connectors) start from the right side of a predecessor activity and finish on the left side of a successor activity. For instance, when we finish Activity A, we can start both Activity C and Activity D. When we finish both, we can start Activity F.

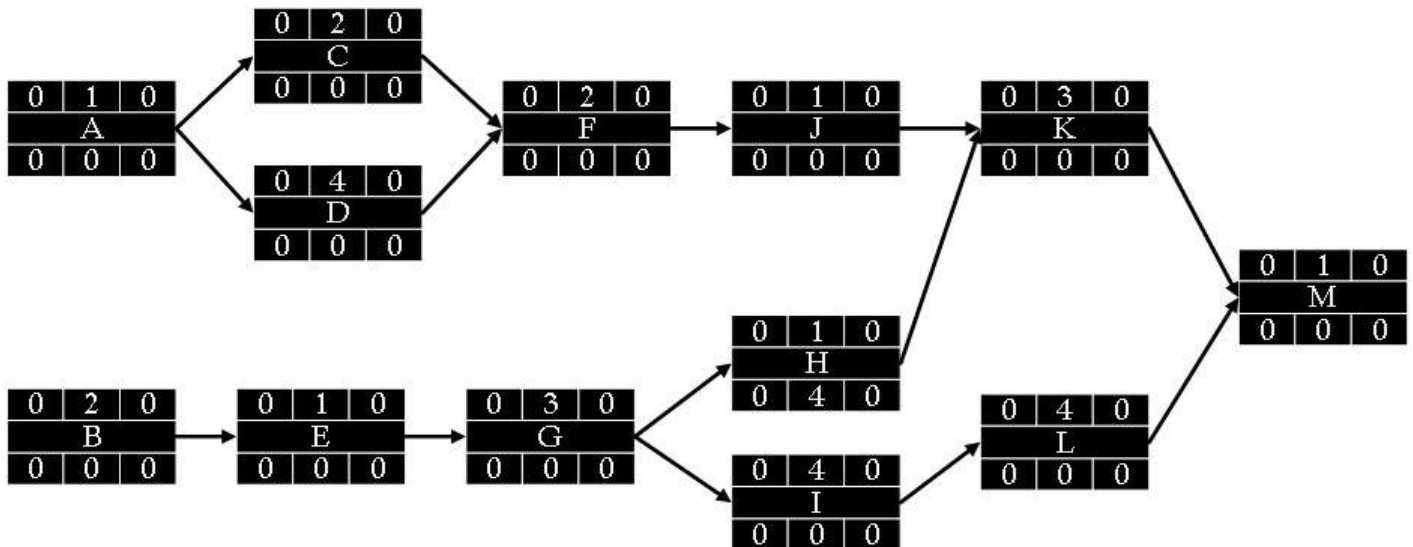

Figure 7.10: Activity Network Diagram with Durations

7.4.3 Forward Pass:

Now, we can start with a forward pass to determine the early start and early finish dates, and on the last activity, the overall time to finish the whole project. It is an additive move through the network from start to finish.

1. For two starting activities (A and B), ES is marked zero, which means that it is the very first day of the project (Figure 7.11).

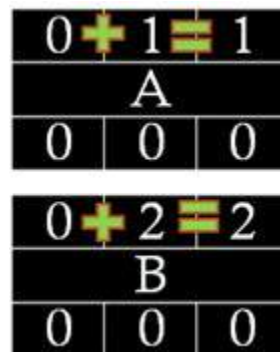

Figure 7.11: ES and EF times

2. We add ES to the duration for each activity to find EF. For A, EF is $(0+1) = 1$ week, and for B, it is $(0+2) = 2$ weeks. It means that we can finish A at the end of the first week, and finish B at the end of the second week (Figure 7.11).
3. Then, we carry the EF time to the nodes immediately succeeding the recently completed nodes (predecessors). C and D inherit 1 (EF) from A, and it becomes ES for both successor activities. For E, we pass 2 (EF for B) to E as the ES time. Then, we add new ES times to the duration of activities to find the EF for new successors (Figure 7.12).

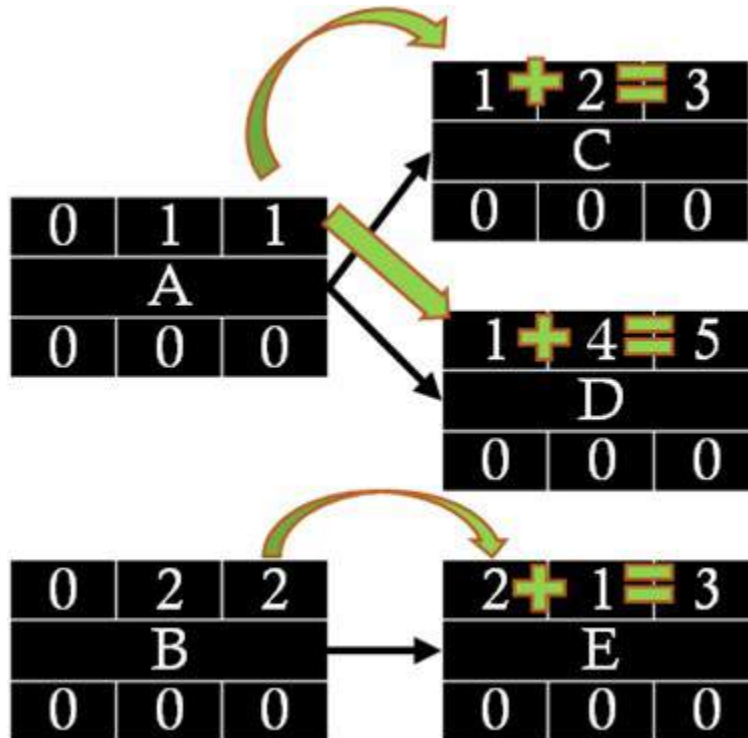

Figure 7.12: Passing predecessor ES times to successors as EF times

- At a merge point, as is the case when C and D merge at F, we pass the highest EF time of predecessors (C and D) to the successor activity (F) (Figure 7.13). EF time of D becomes ES time for F.

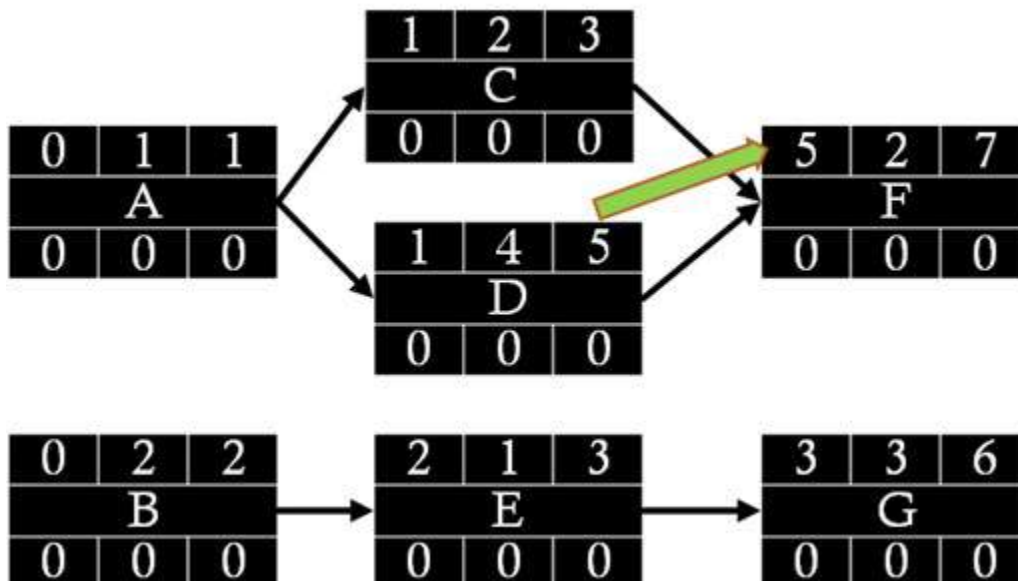

Figure 7.13: Passing predecessor ES times at merge points

- When the forward pass is done, we can generate all ES and EF times for all the activities. The EF of the last activity (M) gives us the overall duration of the project which is 15 weeks (Figure 7.14).

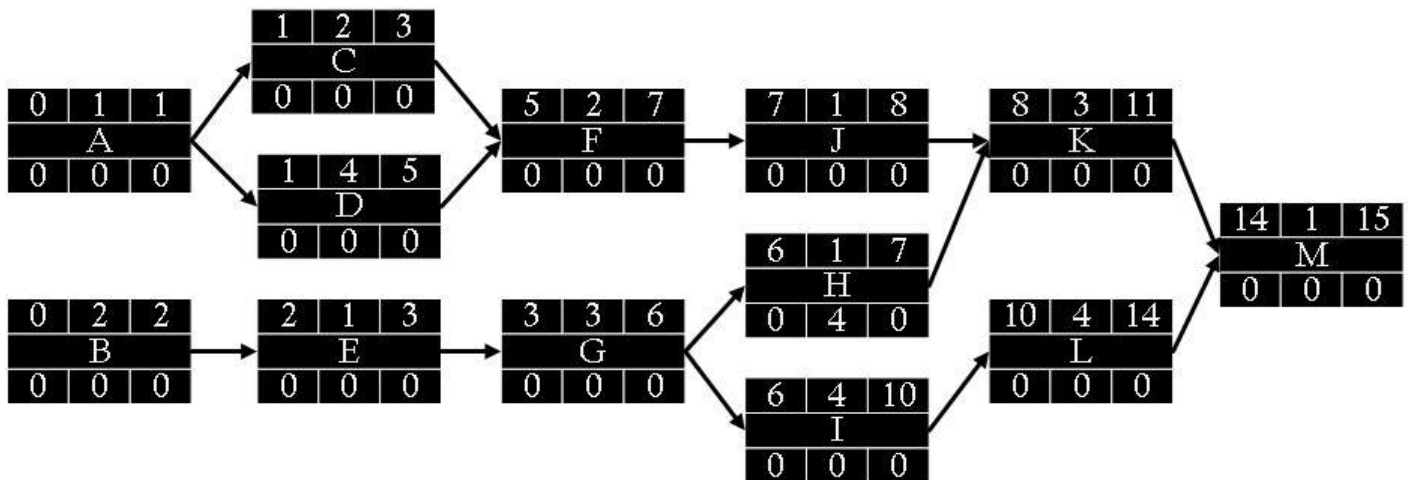

Figure 7.14: Completion of the forward pass

7.4.4 Backward Pass

Before starting the backward pass process, we should explain the critical path which is the path through the network that results in the latest completion date of the project. If any activity on the critical path is delayed, the completion of the project will be delayed by an equal amount. It is the path with the greatest total duration. Therefore, we can add the amount of time estimated for the duration of each activity to the previous activity to determine which path through the network has the longest total duration. As we will explain below, slack will be zero for all the activities on the critical path.

After we complete the forward pass process for all the activities, we can start backward pass by moving from the last activity to the starting activities. It is a subtractive move through the network from finish to the start. In our exercise, the last activity is M with a one-week duration, an ES of 14 weeks, and an EF of 15 weeks which also indicates the overall duration of the project.

1. Late Finish (LF) for the last activity M is passed from EF (15 weeks). Then, we subtract LF from the activity duration to find the Late Start (LS). It is $(15-1) = 14$ weeks (Figure 7.15).



Figure 7.15: Starting backward pass at the last activity

2. Now, it is possible to compute slacks for each activity. It is the difference between LS and ES,

or between LF and EF. Both calculations will generate the same result. For Activity M, it is (14-14) or (15-15), which is zero. Therefore, there are no slacks for this activity. We don't have any flexibility for this activity. We cannot have any delays to start the activity or to finish it. The activities where slack is zero are critical.

- Then, we carry back the LS time to the nodes immediately preceding the successor node. K and L inherit 14 (LS) from M, and it becomes LF for both predecessor activities. Then, we subtract LF times from the duration of activities to find the LS for these predecessors (Figure 7.16). The slack for L is (10-10) or (14-14), which is zero. Therefore, L is also a critical activity. The slack for K is (11-8) or (14-11), which is 3. It means that we can wait for an additional three weeks to start K because we need to wait until week 14.

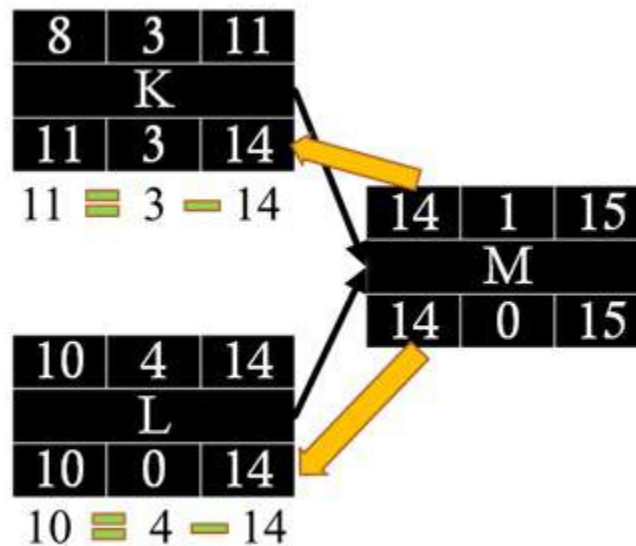

Figure 7.16: Passing LS times to successors as LF times

Figure 7.16: Passing LS times to successors as LF times

- At a burst point, as is the case when G is followed by two successors, H and I, we pass the lowest LS time of successors (H and I) to the predecessor activity G as its LF time. Therefore, 6 becomes the LF for Activity G (Figure 7.17).

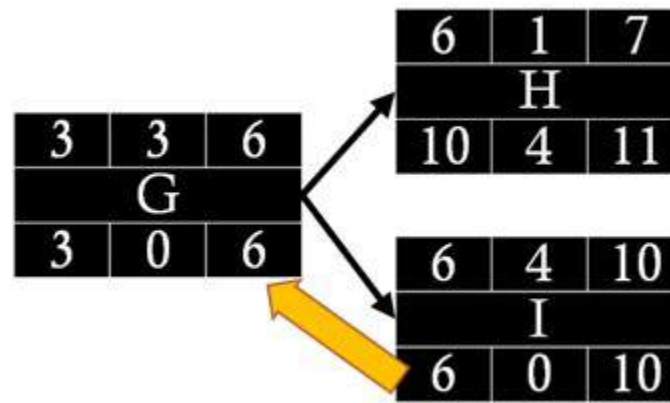

Figure 7.17: Passing successor LS times at burst points as LF times

5. When the backward pass is done for all the activities, we can generate all LS and LF times as well as slack times for all of them (Figure 7.18). Thus, we can determine the critical path where the total slack is zero.

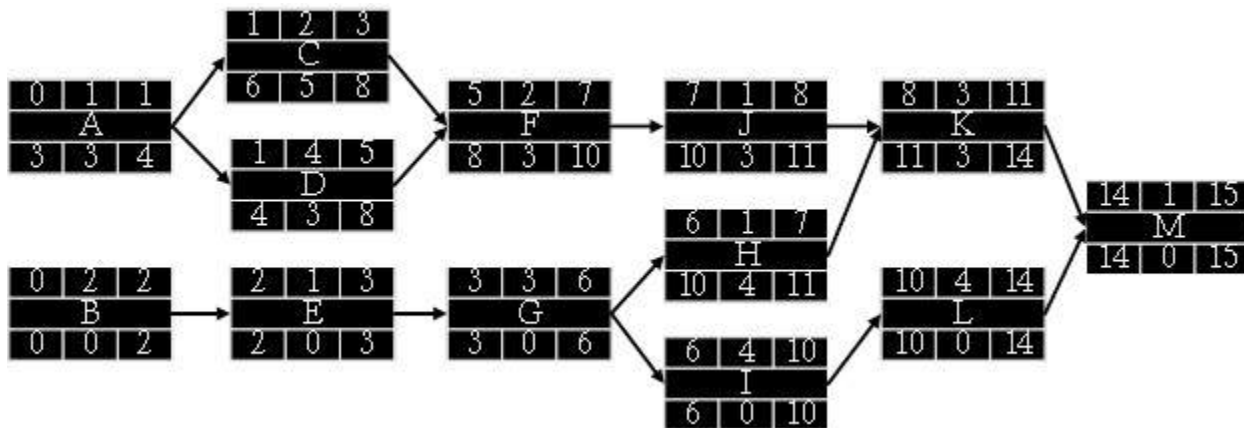

Figure 7.18: Completion of the backward pass

The critical path of this project is B - E - G - I - L - M. It is also the longest path. We need to start and finish all these six activities on their scheduled time not to cause any delay in the overall project. Non-critical paths are:

1. A - C - F - J - K - M: $1+2+2+1+3+1=10$ weeks
2. A - D - F - J - K - M: $1+4+2+1+3+1=12$ weeks
3. B - E - G - H - K - M: $2+1+3+1+3+1=11$ weeks

We should always keep in mind that the WBS is not a schedule, but it is the basis for it. The network diagram is a schedule but is used primarily to identify key scheduling information that ultimately goes into user-friendly schedule formats, such as milestone and Gantt charts. The network diagram provides important information to the project team. It provides information about how the tasks are related, where the risk points are in the schedule, how long it will take as currently planned to finish the project, and when each task needs to begin and end.

Schedules must be communicated to project stakeholders. Generally speaking, stakeholders want to know when the work will be completed. Once the completion date is determined, it is important to confirm whether this date can meet the expectations of the stakeholders, in particular the project sponsor, and internal or external clients. Once timeline commitments have been made, stakeholders must be kept up to date on any delays that will cause deviation from the agreed-upon schedule.

Project Management Institute. (2017). A guide to the Project Management Body of Knowledge (PMBOK guide) (6th ed.). Project Management Institute.

Project Management Institute. (2017). A guide to the Project Management Body of Knowledge (PMBOK guide) (6th ed.). Project Management Institute.

Project Management Institute. (2017). A guide to the Project Management Body of Knowledge (PMBOK guide) (6th ed.). Project Management Institute.

Project Management Institute. (2017). A guide to the Project Management Body of Knowledge (PMBOK guide) (6th ed.). Project Management Institute.

7.5 Creating a Gantt Chart

A Gantt chart is a type of bar chart, developed by Henry Gantt, that illustrates a project schedule. Gantt charts are easy to read and are commonly used to display scheduled activities. These charts display the start and finish dates of project activities. Gantt charts also show the dependency relationships (i.e., precedence network) between activities.

Gantt charts show all the key stages of a project and their duration as a bar chart, with the time scale across the top. The key stages are placed on the bar chart in sequence, starting in the top left corner and ending in the bottom right corner (Figure 7.12). A Gantt chart can be drawn quickly and easily and is often the first tool a project manager uses to provide a rough estimate of the time that it will take to complete the key tasks. The detailed Gantt chart is usually constructed after all WBS activities are identified, an activity list is created, activity durations are estimated, and predecessors are determined.

Let's continue with our example in table 7.3. The Gantt Chart for the Scope activities was created by using MS Project (Figure 7.19).

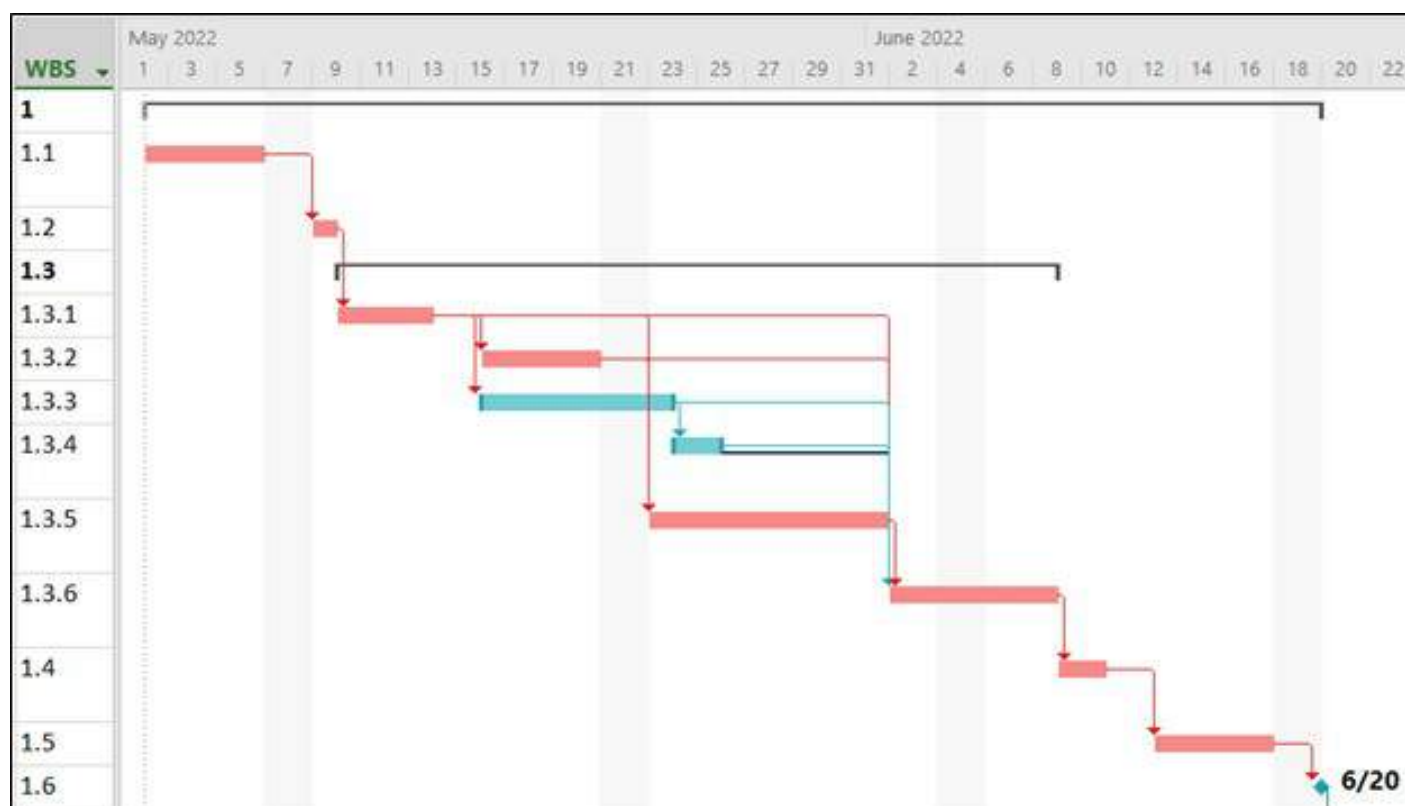

Figure 7.19: Gantt Chart for the “Scope” activities

In the Gantt chart in Figure 7.19, red bars show the critical tasks whereas blue bars illustrate the non-

critical tasks. Dependencies between all the activities are Finish-to-Start, which is the most common dependency and the default relationship in MS Project.

7.6 Microsoft Project Tutorial

The exercise in Table 7.5 has the same activities, durations, and predecessors as the exercise we used to develop a network diagram. In this exercise, we have added different dependencies (not only F-S), lags (a positive number showing a delay), and leads (a negative number showing an earlier start).

Table 7.5: Activities

Activity	Duration (week)	Dependencies	Lag	Predecessors
A	1	F-S	0	-
B	2	F-S	0	-
C	2	F-S	0	A
D	4	S-S	0	A
E	1	F-S	0	B
F	2	F-S	0	C, D
G	3	F-S	0	E
H	1	F-S	2 weeks	G
I	4	F-S	0	G
J	1	F-F	-1 week	F
K	3	F-S for H S-F for J	5 days for J	J, H
L	4	F-S	0	I
M	1	F-S for K F-F for L	1 week for L	K, L

When we start a new project on Microsoft Project, it is useful to check “Project Summary Task” under the “Format” tab. MS Project gives the row number zero to the project summary task. The question mark at the end of the duration shows that the duration is estimated.

Task Mode	Task Name	Duration	Start	Finish	Predecessors
0	Sample Project	0 days?	Tue 11/16/21	Tue 11/16/21	

Figure 7.20: Project Summary Task

Besides, just in the very beginning, it is of high importance to check “Critical Tasks” and “Slack” under the “Format” tab (Figure 7.21). When we type the tasks (activities), the Gantt Chart will start to highlight the critical and non-critical tasks in red and blue colors respectively.

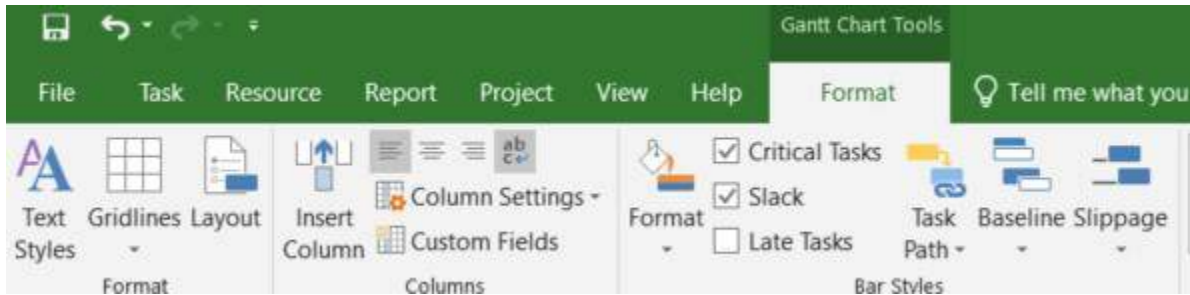

Figure 7.21: Checked critical tasks and slack under the Format tab

As the durations are in weeks, we should change the settings in the Options under the “File” tab. “Duration is entered in” is changed to “Weeks” (Figure 7.22).

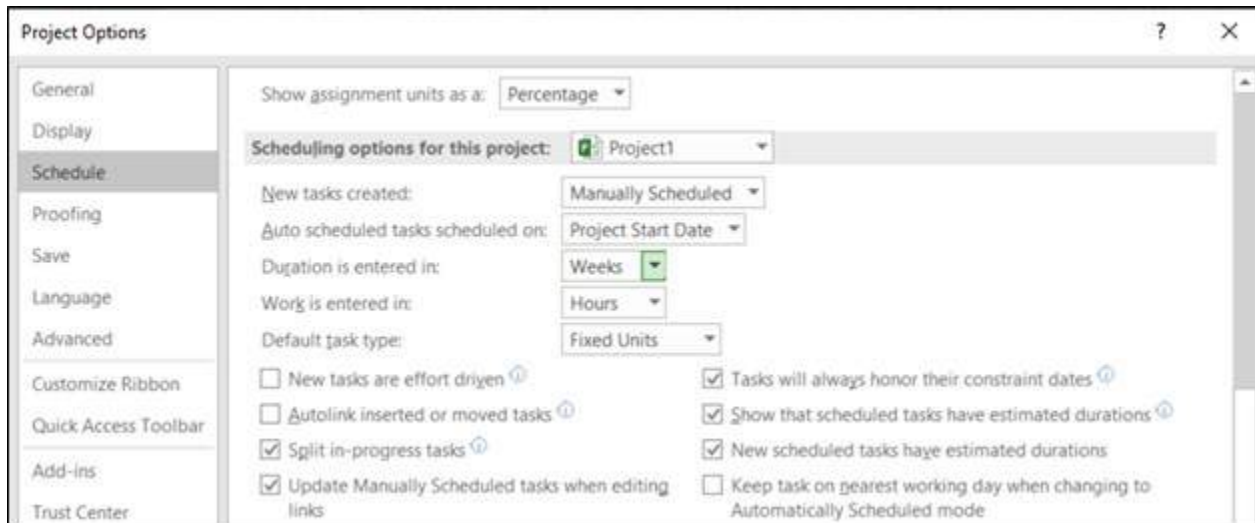

Figure 7.22: Changing the duration unit

First, we should type each activity on the “Task Name” column and durations on the “Duration” column. Then, we can select the predecessors from the dropdown menu on the “Predecessors” column (Figure 7.23).

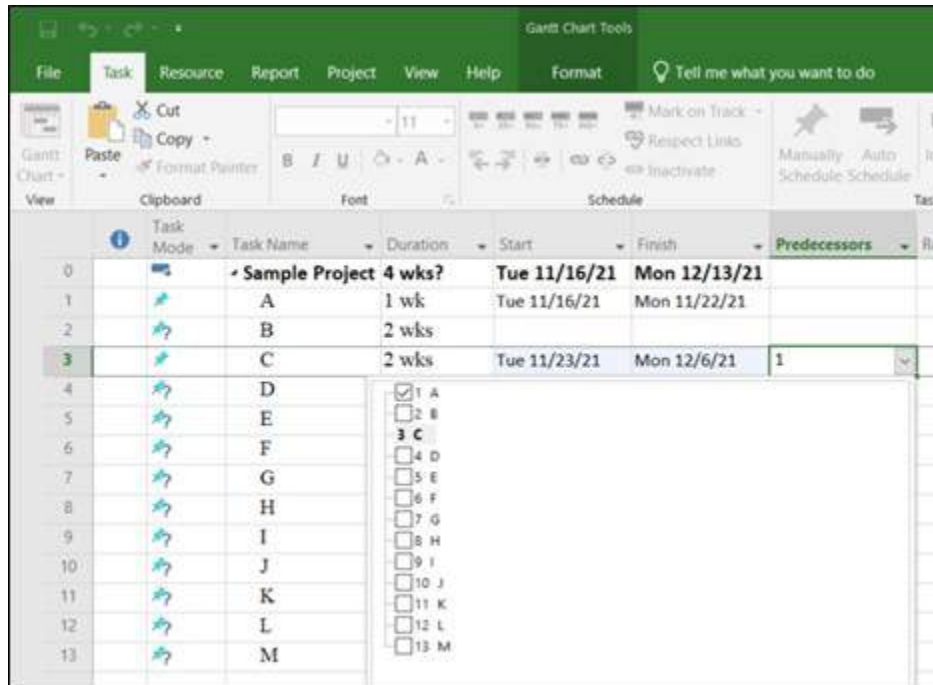

Figure 7.23: Selecting predecessors from the dropdown menu

When we finish typing all the activity predecessors, Gantt Chart will be completed on the right side of the window (Figure 7.24). As indicated above, red bars show critical tasks (with zero slack) and non-critical tasks (with slacks). MS Project allows the users to change the colors of the bars.

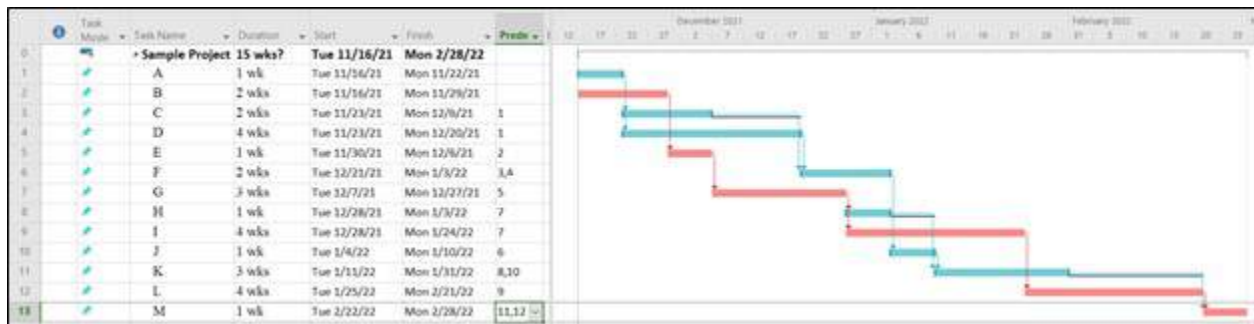

Figure 7.24: Gantt Chart

For this exercise, we are not changing the “Task Mode”, which is either automatically scheduled or manually scheduled (Figure 7.25). Project summary task is automatically scheduled since it adjusts the duration, and start and finish dates automatically when activity durations and predecessors are typed.

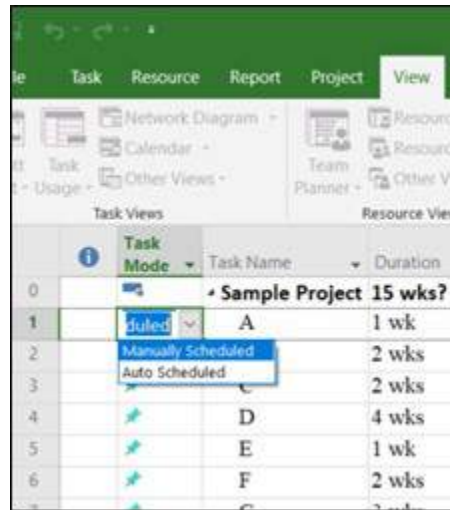

Figure 7.25: Task mode

When we double-click a task, the “Task Information” window opens (Figure 7.26). The dependency type is “Finish-to-Start (FS)” as default. Now we can change dependencies as indicated in Table 7.5.

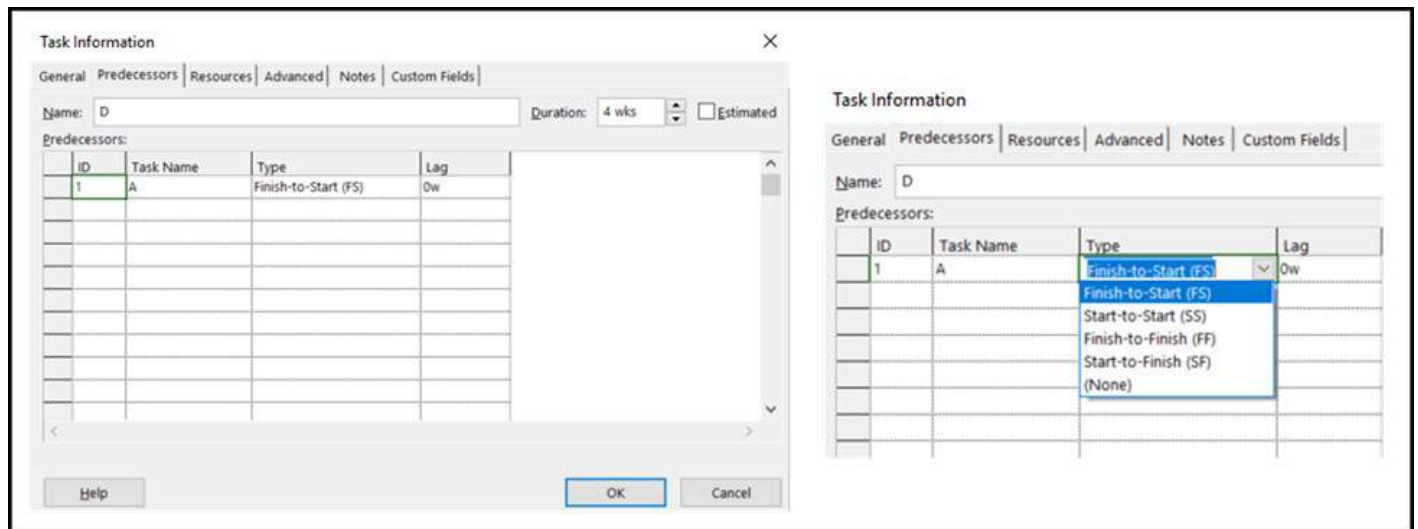

Figure 7.26: Task Information window

When we are done with predecessor types (dependencies), the predecessors with dependencies different from FS will appear on the “Predecessors” column for the relevant activities (Figure 7.27). These dependencies are shown inside a red circle in Figure 7.27.















		Task Mode	Task Name	Duration	Start	Finish	Preceder
0			Sample Project	14 wks?	Tue 11/16/21	Mon 2/21/22	
1			A	1 wk	Tue 11/16/21	Mon 11/22/21	
2			B	2 wks	Tue 11/16/21	Mon 11/29/21	
3			C	2 wks	Tue 11/23/21	Mon 12/6/21	1
4			D	4 wks	Tue 11/16/21	Mon 12/13/21	1SS
5			E	1 wk	Tue 11/30/21	Mon 12/6/21	2
6			F	2 wks	Tue 12/21/21	Mon 1/3/22	3,4
7			G	3 wks	Tue 12/7/21	Mon 12/27/21	5
8			H	1 wk	Tue 12/28/21	Mon 1/3/22	7
9			I	4 wks	Tue 12/28/21	Mon 1/24/22	7
10			J	1 wk	Tue 12/28/21	Mon 1/3/22	6FF
11			K	3 wks	Tue 1/4/22	Mon 1/24/22	8,10SF
12			L	4 wks	Tue 1/25/22	Mon 2/21/22	9
13			M	1 wk	Tue 2/15/22	Mon 2/21/22	11,12FF

Figure 7.27: Predecessors and dependencies

After we change the dependencies, it is important to click “Respect Links” under the “Task” tab since the task mode is manually scheduled and the new dependencies may affect the precedence relationships. As can be seen in Figure 7.28, MS Project highlights the boxes in light blue if there is a change.

Task Name	Duration	Start	Finish	Preceder
Sample Project	14 wks?	Tue 11/16/21	Mon 2/21/22	
A	1 wk	Tue 11/16/21	Mon 11/22/21	
B	2 wks	Tue 11/16/21	Mon 11/29/21	
C	2 wks	Tue 11/23/21	Mon 12/6/21	1
D	4 wks	Tue 11/16/21	Mon 12/13/21	1SS
E	1 wk	Tue 11/30/21	Mon 12/6/21	2
F	2 wks	Tue 12/14/21	Mon 12/27/21	3,4
G	3 wks	Tue 12/7/21	Mon 12/27/21	5
H	1 wk	Tue 12/28/21	Mon 1/3/22	7
I	4 wks	Tue 12/28/21	Mon 1/24/22	7
J	1 wk	Tue 12/21/21	Mon 12/27/21	6FF
K	3 wks	Tue 1/4/22	Mon 1/24/22	8,10SF
L	4 wks	Tue 1/25/22	Mon 2/21/22	9
M	1 wk	Tue 2/15/22	Mon 2/21/22	11,12FF

Figure 7.28: Highlighted changes

As can be seen in Figure 7.29, the dependency between A and D is not FS anymore D. It is Start-to-Start (SS). Therefore, the arrow starts from the left side of A’s bar on the Gantt Chart and connects to the left side of D’s bar. When it is FS, the arrow starts from the right side of the predecessor and connects to

the left side of the successor as can be seen in Figure 7.29 between A and C.

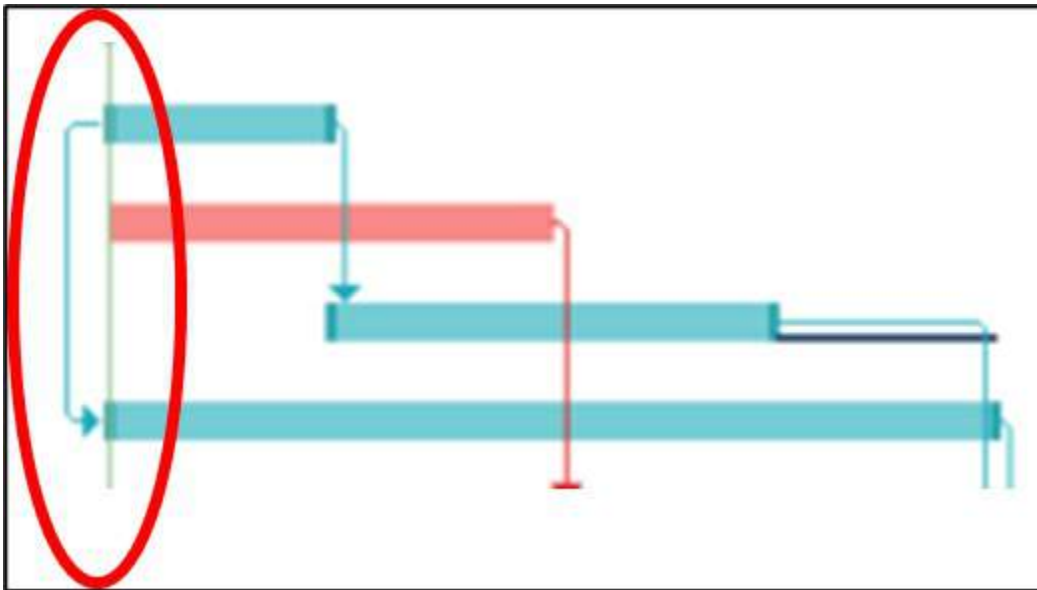

Figure 7.29: Start-to-Start dependency

In order to see the slacks for each activity, we can add a new column named “Free Slack” (Figure 7.30). The black underline attached to the left of Activity C in the Gantt Chart also shows the slack (Figure 7.29).

Task Name	Duration	Start	Finish	Free Slack	Prede
Sample Project	14 wks?	Tue 11/16/21	Mon 2/21/22	0 wks?	
A	1 wk	Tue 11/16/21	Mon 11/22/21	0 wks	
B	2 wks	Tue 11/16/21	Mon 11/29/21	0 wks	
C	2 wks	Tue 11/23/21	Mon 12/6/21	1 wk	1
D	4 wks	Tue 11/16/21	Mon 12/13/21	0 wks	15S
E	1 wk	Tue 11/30/21	Mon 12/6/21	0 wks	2
F	2 wks	Tue 12/14/21	Mon 12/27/21	0 wks	3,4
G	3 wks	Tue 12/7/21	Mon 12/27/21	0 wks	5
H	1 wk	Tue 12/28/21	Mon 1/3/22	0 wks	7
I	4 wks	Tue 12/28/21	Mon 1/24/22	0 wks	7
J	1 wk	Tue 12/21/21	Mon 12/27/21	5 wks	6FF
K	3 wks	Tue 1/4/22	Mon 1/24/22	3 wks	8,10SF
L	4 wks	Tue 1/25/22	Mon 2/21/22	0 wks	9
M	1 wk	Tue 2/15/22	Mon 2/21/22	0 wks	11,12FF

Figure 7.30: Free Slack column

Now we can create an activity network diagram by selecting “Network Diagram” on the dropdown menu that appears when we click the Gantt Chart located on the far-left part of the “Task” tab (Figure 7.31).

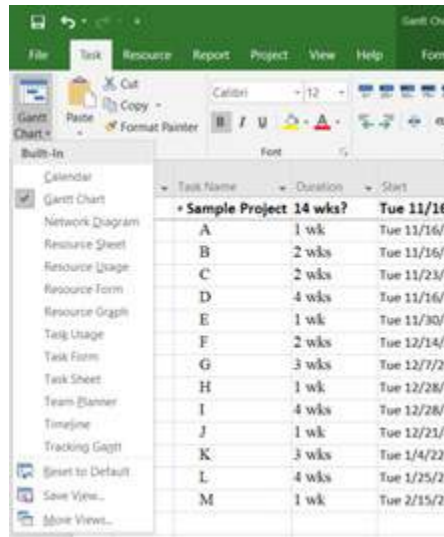

Figure 7.31: Selecting network diagram

Figure 7.32 displays the network diagram in a non-collapsed format. We should scroll toward the right to see other activities.

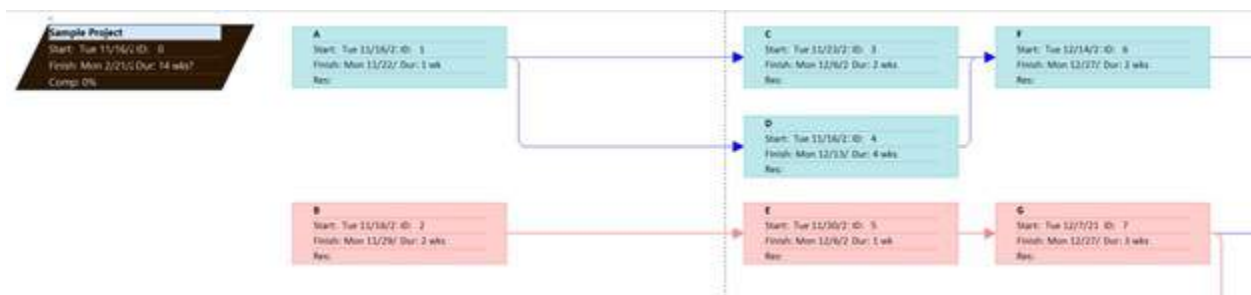

Figure 7.32: Network Diagram (Not collapsed)

In order to see the whole diagram without details, we should click “Collapse Boxes” and check “Straight Links” under the “Network Diagram Tools - Format” tab (Figure 7.33). The network diagram in MS Project illustrates the links in FS dependency. Therefore, it is convenient to see other dependencies on the Gantt Chart view.

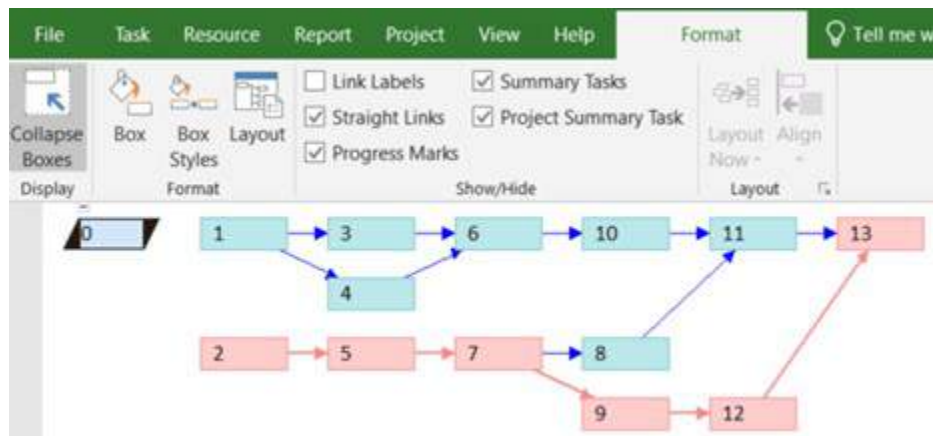

Figure 7.33: Network diagram (Collapsed)

7.7 Key Takeaways

Key Takeaways

- The project schedule management plan is one of the sub-plans of the overall project plan. It provides the guidelines on how to develop a project schedule by defining and sequencing project activities and milestones, and by estimating activity durations.
- The activity definition process is a further breakdown of the work package elements of the WBS which was created while planning the scope.
- After the lowest level activities are defined in the activity list, each activity is reviewed and evaluated to determine the duration. An estimate is an educated guess based on knowledge, experience, and inference. Five types of estimation methods are expert judgment, analogous estimating, parametric estimating, three-point estimates, and bottom-up estimating.
- Showing the activities in rectangles or circles, and their relationships (dependencies) as arrows is called a precedence diagramming method (PDM). This kind of diagram is also called an activity-on-node (AON) diagram.
- Four types of logical relationships (dependencies) are “Finish-to-Start” (FS), “Finish-to-Finish” (FF), “Start-to-Start” (SS), and “Start-to-Finish” (SF). The most common relationship is Finish-to-Start at which we start a successor activity once we finish the predecessor activity.
- The process to create an activity network diagram is composed of two main steps: (1) Forward pass, and (2) backward pass. When these steps are completed, the critical path can be identified.
- A Gantt chart is a type of bar chart that displays the start and finish dates of project activities, and their dependency relationships with one another.

7.8 Questions and Exercises

There are 8 questions for this chapter. As you submit each answer, you will get immediate feedback and be taken to the next question.

An interactive or media element has been excluded from this version of the text. You can view it online here:

<https://pressbooks.ulib.csuohio.edu/project-management-navigating-the-complexity/?p=584>

7.9 Attribution

This chapter is a derivative of the following texts:

1. [Project Management by Adrienne Watt](#). © [CC BY \(Attribution\)](#).
2. [Project Management from Simple to Complex](#). © [CC BY \(Attribution\)](#).
3. [Project Management by Florence Daddey](#). © [CC BY \(Attribution\)](#).
4. [Project Management Fundamentals by Shelly Morris](#). © [CC BY \(Attribution\)](#).
5. [Project Management by Merrie Barron and Andrew R. Barron](#). © [CC BY \(Attribution\)](#).
6. [Principles of Management](#) © [CC BY \(Attribution\)](#).

Chapter 8. Resource Management

8.0 Learning Objectives & Overview

Learning Objectives

1. Describe how to create a project resource plan.
2. Define the resources that will be utilized in a project, including the project team members.
3. Elaborate on resource loading, leveling, and crashing to conduct resource allocation effectively.
4. Practice on Microsoft Project to determine and allocate the resources, and solve resource overallocation and conflict problems as well as scheduling issues.

Overview

A project manager is responsible for planning, developing, managing, and monitoring and controlling the resources to ensure that project objectives can be achieved. Effective resource management is integral to overall project success. The objective is to identify and allocate resources effectively and efficiently to project activities to complete the project to the satisfaction of the stakeholders, in particular, clients and customers. Whereas scope, time, and cost are the main constraints of a project, they are tightly linked to the resources. After the scope and schedule are delineated, the project manager can continue with the identification and allocation of resources based on the scope (product requirements and project activities) and the schedule (how project activities are sequenced on a timescale). Allocation of resources allows the project manager to determine the overall project budget most of which is spent on resources.

8.1 Resource Management

Resource management is the efficient and effective deployment of an organization's resources when they are needed. We can classify the resources into three main categories:

1. Human resources (HRs)
 - a. Project team members (core team)
 - b. HRs outside the core team required for project activities
2. Physical resources
 - a. Equipment
 - b. Materials (Raw materials, supplies, consumables)
 - c. Inventory
 - d. Facilities
 - e. Infrastructure
 - f. IT hardware
 - g. IT software
 - h. Cloud computing resources
3. Services
 - a. Contractors and subcontractors
 - b. Consulting

Every activity in our activity list needs to have resources assigned to it. Before we can assign resources to the project, we need to know their availability. To assess resource availability, a project manager needs information about what resources we can use on our project when they're available to us, and the conditions of their availability. This is why a WBS (see Chapter 4) and an activity list (see Chapter 7) are critical in our project to plan for the resources.

The most important resource to a project is its people—the project team. We discussed the development and management of project teams in section 6.7 of Chapter 6. Projects have a core team that includes a project manager and key members with functional expertise. There may be also administrative personnel and members who assist the project manager. Core team members provide continuity and “corporate memory” throughout the project, particularly to external hires who may not be as familiar with the strengths and weaknesses of the organization's previous projects. Projects require specific expertise at specific moments in the schedule, depending on the milestones being delivered or the given phase of the project. An organization can host several strategic projects concurrently over the course of a budget year, which means that its employees can be working on more than one project at a time. Alternatively, an employee may be seconded away from his or her role within an organization to become part of a project team because of particular expertise. Moreover, projects often require talent and

resources that can only be acquired via contract work and third-party vendors. Procuring and coordinating these human resources, in tandem with managing the time aspect of the project, is critical to overall success.

8.2 Project Resource Management Plan

As described in Chapter 4, project planning is at the heart of the project life cycle and tells everyone involved where we are going and how we are going to get there. It involves creating a set of plans to help guide the project team through the implementation and closure phases of the project. The project resource management plan is one of the sub-plans of the overall project plan. It provides the guidelines to project managers on how to estimate, acquire, manage and utilize physical and team resources. It is the process of establishing the policies, procedures, and documentation for planning, developing, managing, executing, and controlling the project resources.

The resource management plan can consist of the following:

- Project Organization Charts
 - Project team members and their reporting relationships are displayed in these charts.
 - A team charter is prepared to establish team values, agreements, communication guidelines, decision-making criteria and processes, and operating guidelines for the team.
- Resource requirements
 - Types of resources (e.g., human resources, physical resources, services)
 - Human resources (Core team members and people for all project activities)
 - Required skills and competencies
 - Roles and responsibilities
 - Authority level (e.g., decision-making, inspecting, and accepting deliverables)
 - Effort in hours (e.g., daily working hours – full-time or part-time, the total amount of work hours)
 - Source (e.g., PMO – Project Management Office, other functional units, regional offices, outsourcing, offshoring)
 - WBS activity link
 - Required features for physical resources (e.g., equipment, materials, facilities, infrastructure, supplies)
- Project team resource management
 - Methods for developing and managing the project team
 - The decision criteria when to use project team human resources and the human resources outside the team.
- Resourcing strategy
 - How will resources be acquired and released from the project?
- Resourcing assumptions

- Are there any assumptions about the resource requirement estimates?
- Vacations, holidays, training, meetings, interruptions, sick leave.
- Rewards and recognition
 - Define the criteria for rewarding project team members for the work that they have done.
 - Which rewards will be given and when?
 - How much money is set aside for the project?
- Resource control
 - Which methods will be used to monitor and control the project resources?
- Health and safety
 - Are there specific health and safety practices that will be followed on the project?

In the resource management plan, including a Resource Breakdown Structure would help the team substantially to illustrate the needs in a hierarchical structure. An example is given in Figure 8.1 based on the case study regarding Grocery LLC’s M-Commerce Project.

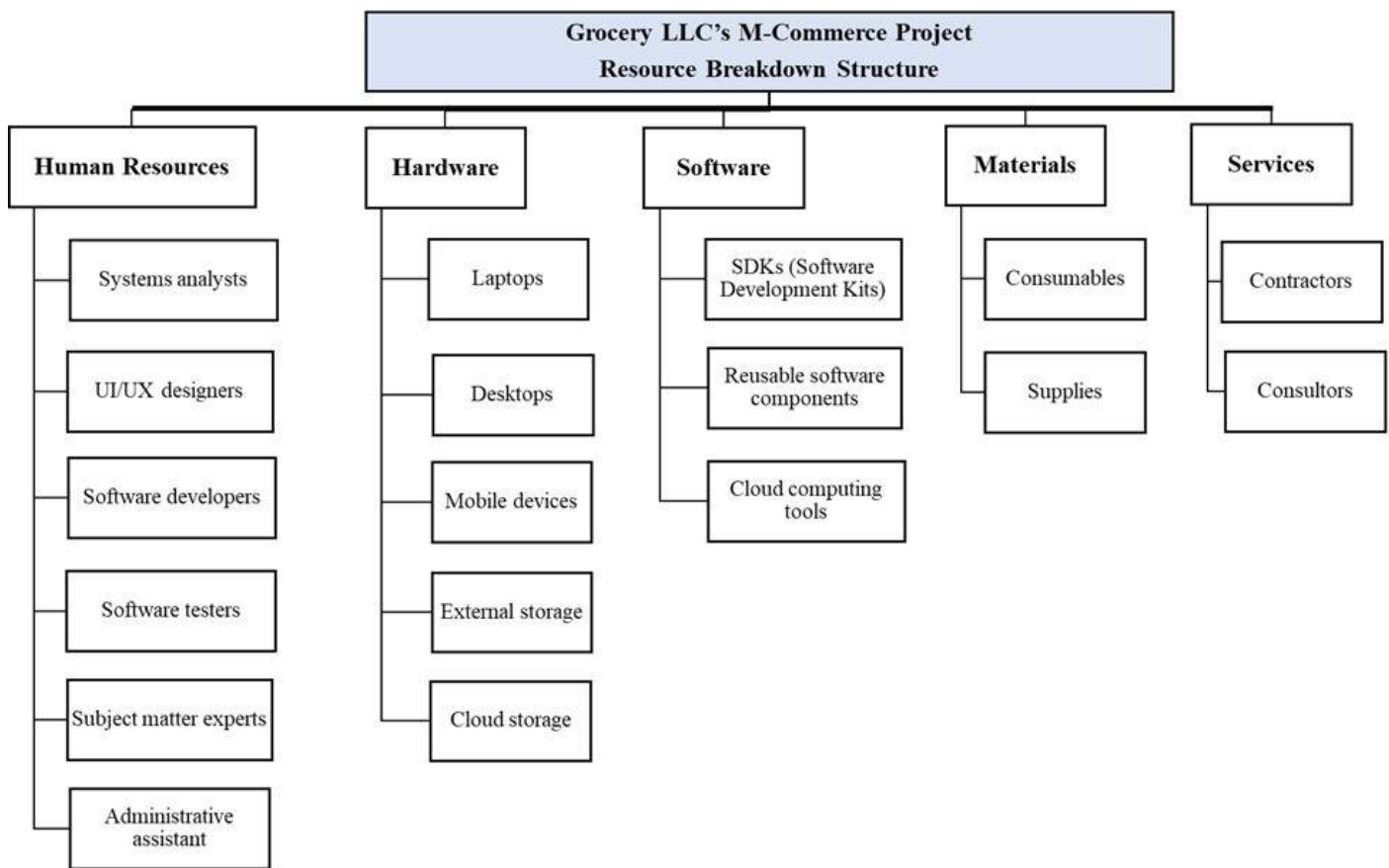

Figure 8.1: Resource Breakdown Structure (RBS) for M-Commerce Project

Project Management Institute. (2017). A guide to the Project Management Body of Knowledge (PMBOK guide) (6th ed.). Project Management Institute.

Project Management Institute. (2017). A guide to the Project Management Body of Knowledge (PMBOK guide) (6th ed.). Project Management Institute.

Project Management Institute. (2017). A guide to the Project Management Body of Knowledge (PMBOK guide) (6th ed.). Project Management Institute.

8.3 Estimating the Resources

The goal of activity resource estimating is to assign resources to each activity in the activity list. In order to estimate resources, we can use the similar techniques that we utilized to estimate schedule (see Chapter 7) and cost (see Chapter 9). In this book, we will describe four tools and techniques for estimating activity resources.

1. **Expert judgment:** The project team consults domain and implementation subject matter experts who have technical knowledge and experience in the areas the project activities are related to. When we are developing a mobile application, we can consult software engineers, developers and testers, and systems analysts who were involved in activities to develop other mobile applications. They can provide us with information regarding resource requirements.
2. **Alternative analysis:** We can consider several different options for how we can assign resources. This includes varying the number of resources as well as the kind of resources we use. Many times, there's more than one way to accomplish an activity and alternative analysis helps decide among the possibilities.
3. **Analogous estimating:** Information and lessons learned from previous projects, standards provided by the regulatory agencies, government organizations, and occupational associations, and the data that rely on articles, books, journals, and periodicals can be utilized to help us figure out what kind of and how many resources we need in our project activities.
4. **Bottom-up estimating:** We decompose our project activities by utilizing WBS. We break down complex activities into pieces. Therefore, we can work out the resource assignments for each piece. It is a process of estimating individual activity resource needs and then adding these up together to come up with a total estimate. Bottom-up estimating is an accurate means of estimating, given that the estimates at the lower levels are accurate. However, it takes a considerable amount of time to perform bottom-up estimating because every activity must be assessed and estimated accurately to be included in the bottom-up calculation. The smaller and more detailed the activity, the greater the accuracy and cost of this technique. An example is provided in the sections "8.4 Resource Allocation" and "8.5 Solving Resource Conflicts".

Project management software programs such as Microsoft Project often have features designed to help project managers estimate resource needs and constraints and find the best combination of assignments for the project.

8.4 Resource Allocation

Based on the Resource Management Plan and according to the estimation methods, the project team should identify the resources necessary for the project activities and should allocate them to execute the project activities. Allocation of resources is named “Resource Loading”. Then, the project team can have a resource usage calendar that exhibits the amounts of resources assigned to each activity during the project. Let’s continue with “Table 7.1. Activity List Template” from Chapter 7, and load resources to the activities of “1.3 Preparation of Project Charter”.

Table 8.2: Resource Loading for 1.3 “Preparation of Project Charter”

Activity List for Project "Grocery LLC's M-Commerce Project"					
Activity identifier	Activity title	Scope of Work	Person Responsible	Predecessors	Resources
1.3	Preparation of Project Charter	The project charter that will authorize the project manager to undertake the responsibility of the project and apply the resources to project activities will be prepared.	Project Manager	1.1 1.2	
1.3.1	Develop high-level scope	The high-level scope consists of the project purpose, measurable project objectives, high-level requirements, project description, boundaries, key deliverables, and assumptions and constraints.	Systems Analyst 1	1.2	Systems Analyst 1
1.3.2	Identify overall project risks	This includes the identification of the risks that affect the project in general.	Systems Analyst 2	1.3.1	Systems Analyst 2
1.3.3	Develop high-level schedule	This includes the estimation of the overall schedule with summary milestones.	Team Member 1	1.3.1	Systems Analyst 1
1.3.4	Identify main resources and develop a high-level budget	This includes the initial estimation of all resources (human resources, physical resources, and services), and the budget.	Team Member 2	1.3.3	Systems Analyst 1 Systems Analyst 2
1.3.5	Identify key stakeholders and project team member roles	Stakeholders with high-interest levels and/or power levels will be identified. The project team's composition will be created. The qualifications required should be detailed. The project sponsor's authority will be detailed.	Team Member 3	1.3.1 1.3.2	Systems Analyst 1 Systems Analyst 2 Sales & Marketing Expert 1 Sales & Marketing Expert 2
1.3.6	Develop project approval requirements and project exit criteria	Based on the project scope and other sections of the project charter, project approval requirements and exit criteria should be detailed. Exit criteria include the conditions that describe the early termination of the project.	Team Member 1, 2, 3	1.3.1 1.3.2 1.3.3 1.3.4 1.3.5	Systems Analyst 1 Systems Analyst 2

In Table 8.2, we only assigned human resources. We also assume that all the people work full-time, which is 8 hours a day. They work during the weekdays, which makes the weekly total work hours forty. In Table 8.3, we can see how human resources are distributed to the tasks by week.

Table 8.3: Resource Usage Calendar

Resource Name	Work	May 2	May 9	May 16	May 23	May 30	June 6
Systems Analyst 1	240 hrs	40	32	40	64	40	24
<i>Clarify project purpose and determine project scope</i>	40 hrs	40					
<i>Develop high-level scope</i>	32 hrs		32				
<i>Develop high-level schedule</i>	48 hrs			40	8		
<i>Identify main resources and develop a high-level budget</i>	16 hrs				16		
<i>Identify key stakeholders and project team member roles</i>	64 hrs				40	24	
<i>Develop project approval requirements and project exit criteria</i>	40 hrs					16	24
Systems Analyst 2	200 hrs	40	0	40	56	40	24
<i>Clarify project purpose and determine project scope</i>	40 hrs	40					
<i>Identify overall project risks</i>	40 hrs			40			
<i>Identify main resources and develop a high-level budget</i>	16 hrs				16		
<i>Identify key stakeholders and project team member roles</i>	64 hrs				40	24	
<i>Develop project approval requirements and project exit criteria</i>	40 hrs					16	24
Sales & Marketing Expert 1	104 hrs	40	0	0	40	24	0
<i>Clarify project purpose and determine project scope</i>	40 hrs	40					
<i>Identify key stakeholders and project team member roles</i>	64 hrs				40	24	
Sales & Marketing Expert 2	104 hrs	40	0	0	40	24	0
<i>Clarify project purpose and determine project scope</i>	40 hrs	40					
<i>Identify key stakeholders and project team member roles</i>	64 hrs				40	24	

Resource usage calendars help project teams evaluate whether resources are assigned without conflicts. As can be seen in Table 8.3, System Analyst 1 (SA1) and 2 (SA2), both, have resource overallocation problems on May 23rd week. SA1 works 64 hours on that week while SA2 works 56 hours. Both work more than 40 hours (8 hours per weekday) assuming that overtime work is not allowed. In the next section, we will discuss how to solve this overallocation by means of resource

leveling.

8.5 Solving Resource Overallocation: Resource Leveling

One of the techniques to solve resource conflicts is implementing resource leveling which is used to examine the unbalanced use of resources (usually people or equipment) over time and for resolving overallocation or conflicts. When performing project planning activities, the manager will attempt to schedule certain tasks simultaneously. When more resources are needed than are available, or perhaps a specific person is needed in both tasks, the tasks will have to be rescheduled sequentially to manage the constraint. Resource leveling during project planning is the process of resolving these conflicts. It can also be used to balance the workload of primary resources throughout the project, usually at the expense of one of the triple constraints (scope, schedule, cost).

As we discussed briefly in the previous section, both systems analysts are overallocated. Therefore, we should correct this issue since they cannot work more than 40 hours a week. Resource leveling would be one of the techniques to eliminate this problem. In resource leveling, we still use the same resources without adding new resources. However, this comes with a risk of schedule delay. Gantt Chart for the weeks of May 16, May 23, and May 30 is shown in Figure 8.2. As can be seen in the figure, 1.3.3 and 1.3.5 overlap on May 23, and SA1 works full time in two activities on the same day, which is not possible. Besides, 2-day activity 1.3.4 overlaps with 1.3.5, and both SA1 and SA2 work on both of the activities.

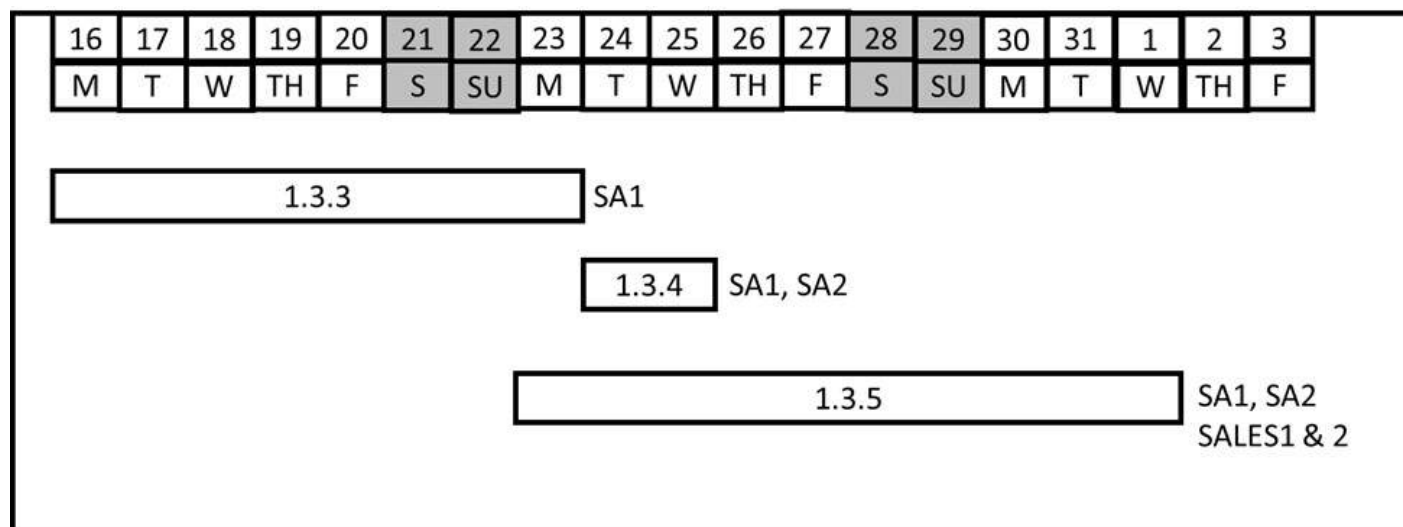

Figure 8.2: Gantt Chart before Resource Leveling

Since resource leveling utilizes the same resources, it may create schedule delays as seen in Figure 8.3. Activity 1.3.4 had to be moved to June 2 from May 24 to prevent any conflicts with 1.3.3 and 1.3.5. Its duration was also increased to 3 days from 2 days. Activity 1.3.5 starts on the same day, May 23.

However, its duration was also increased to 9 days from 8 days. Therefore, it finishes on May 2 instead of May 1. For these three activities, we have a three-day delay in total after resource leveling. Sometimes, splitting the tasks could be another option if the activities allow us to do so. This resource leveling could also affect the following activities, which may create a chain effect with more schedule slippages.

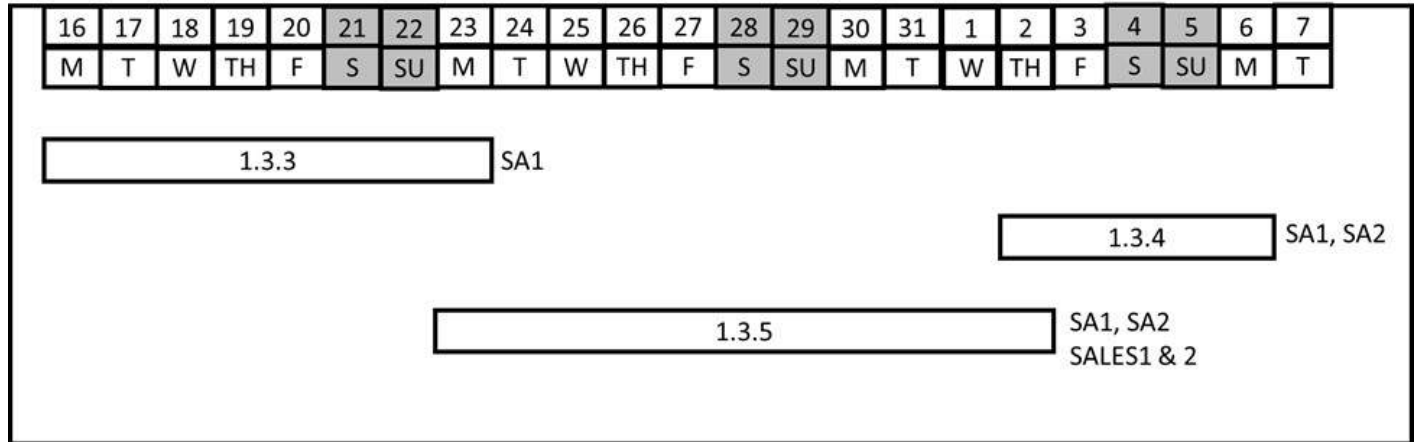

Figure 8.3: Gantt Chart after Resource Leveling

Another option to resolve conflicts would be assigning new resources to prevent schedule slippages. A third systems analyst can be assigned to activity 1.3.3 by removing SA1. With the new SA3, we can reallocate SA1 and SA2 in 1.3.4 and 1.3.5 by replacing them with SA3 for the days when SA1 and SA2 have conflicts with other activities. Apparently, this situation would impose additional costs on the project by adding a new systems analyst. However, we can avoid schedule slippages. Thus, the project manager should evaluate all the trade-off options between the schedule and the cost.

8.6 Schedule Compression Techniques

While resource leveling is mostly implemented during the planning stage of activities, schedule compression techniques such as crashing and fast-tracking are utilized during the execution of activities to accelerate the project. With crashing, the project manager adds additional resources to the critical activities (zero-slack activities) and saves time by spending more money on the additional resources. In this technique, existing resources can be asked to work overtime or we can add new resources. As seen in Figure 8.4, we assigned new resources to the three activities. With the added resources, and accordingly with more cost, we now had the opportunity to finish these activities in 8 days instead of 12 days.

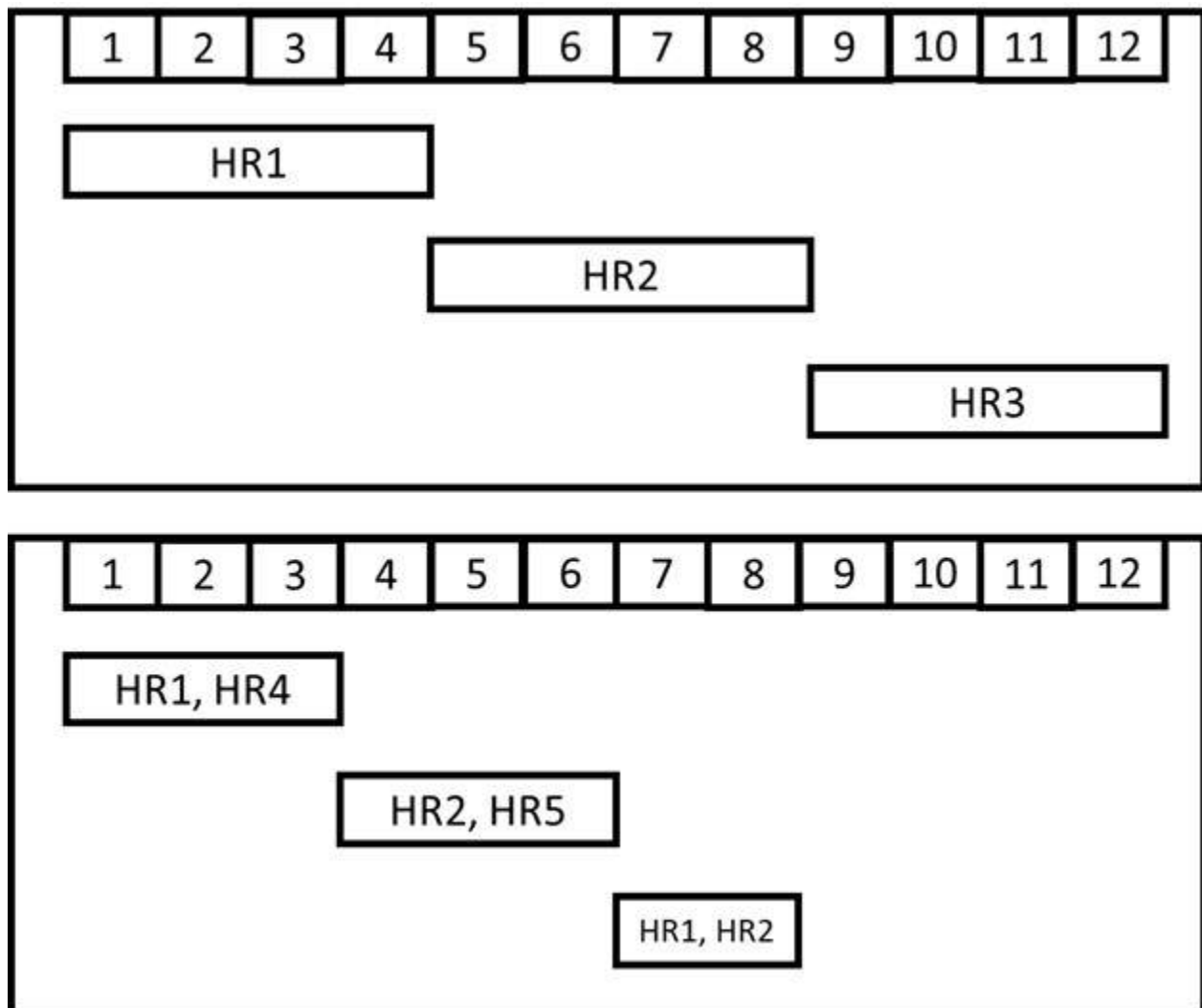

Figure 8.4: Crashing

Project managers should ponder all the alternatives and outcomes before deciding on crashing since

adding new resources may not shorten the duration all the time. If overtime is approved, people who work overtime may be less productive after a while with increased tiredness and less satisfaction. Besides, there may be internal and external dependencies. For example, we may be still waiting for a material ordered from a supplier which cannot deliver earlier. Regarding the equipment, we may not be able to increase the operating time if the equipment cannot work more than a certain number of hours a day. If the activities in which we crash resources are not critical, we cannot shorten the duration. Let's consider the project activity network diagram in Figure 7.14 from Chapter 7.

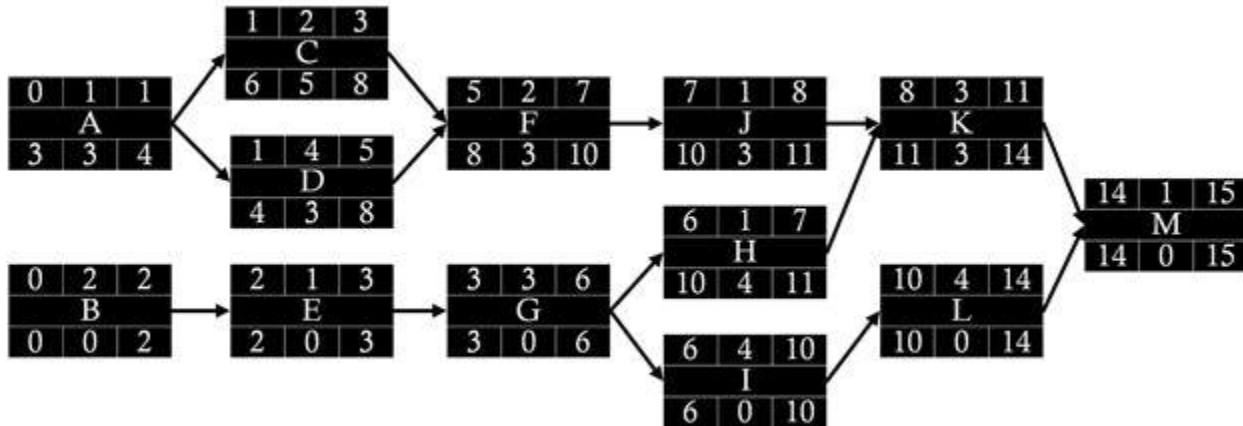

Figure 8.5: Activity Network Diagram from Chapter 7

Let's perform crashing in Activity D and Activity K. Each of D and K has a three-day slack. Let's assume that with additional resources, we can finish D in 3 weeks instead of 4 weeks, and the K in 1 week instead of 3 weeks. The new activity network diagram is in Figure 8.6. The total duration of the project remains the same, 15 weeks. D and K, the both, have one more day slack while it hasn't influenced the project duration. Therefore, we have just paid more for nothing.

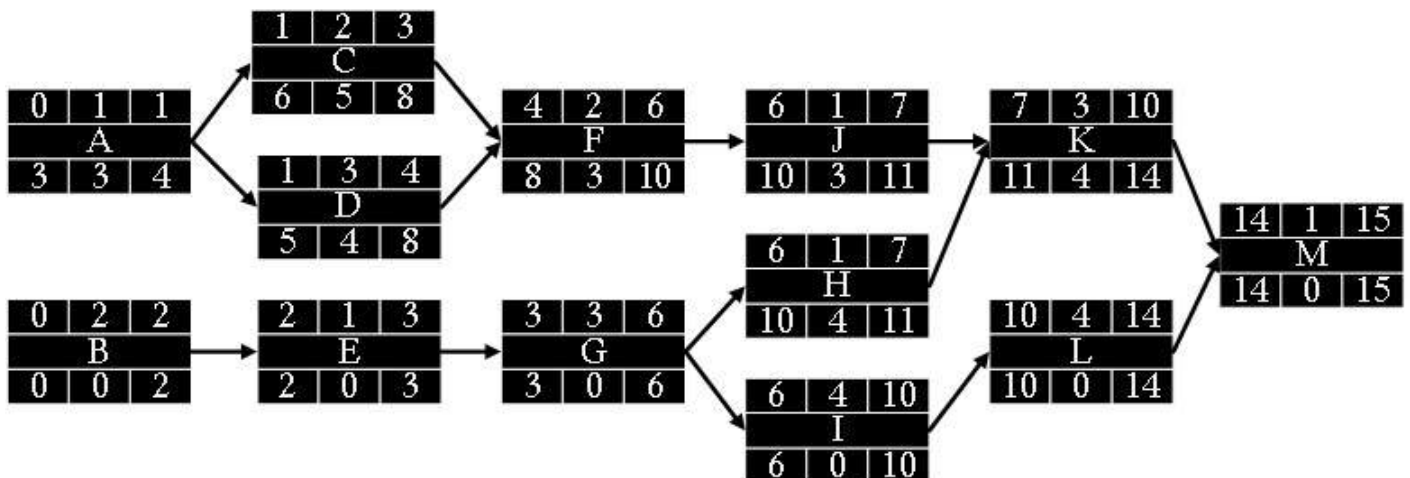

Figure 8.6: Activity Network Diagram after Crashing D and K

If we crash critical activities, we can save time on the project. Let's add new resources to Activity I and Activity L. The new duration for I and L is 3 weeks for each. As seen in Figure 8.6, the total duration of the project was reduced to 13 days from 15 days.

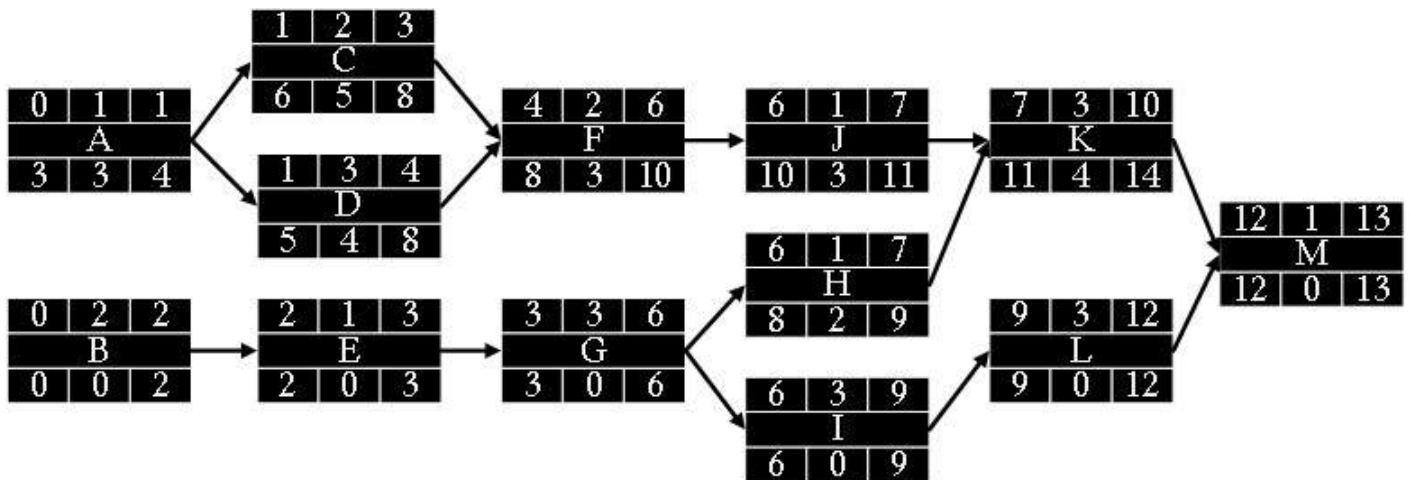

Figure 8.7: Activity Network Diagram after Crashing I and L

Another option to shorten the duration of a project is to implement fast-tracking. If some parts of the activities can be carried out in parallel, we can shorten the total duration. Let's use the example in Figure 8.4. In fast-tracking, we don't assign new resources. With the same resources, we can execute some parts of three activities in parallel. Let's assume that the first activity is coding and HR1 is working in this activity. The second activity is testing and HR2 is working in this activity. We don't need to wait for the first activity to be completed to start the second activity. We can add two-day leads (negative lags) between activities (Figure 8.8). After developers finish some of the codings, testers can start the testing. In this case, we can finish three activities in 8 days instead of 12 days as seen in Figure 8.8. However, using leads increases the coordination efforts. Therefore, the project manager should exert more concentrated efforts for coordination to prevent any quality risks. It may be still possible to increase the project costs although the probability is less when compared with crashing. It is of high importance to bear in mind that not all activities can be fast-tracked. The sequencing of the activities should be such that fast-tracking is permissible.

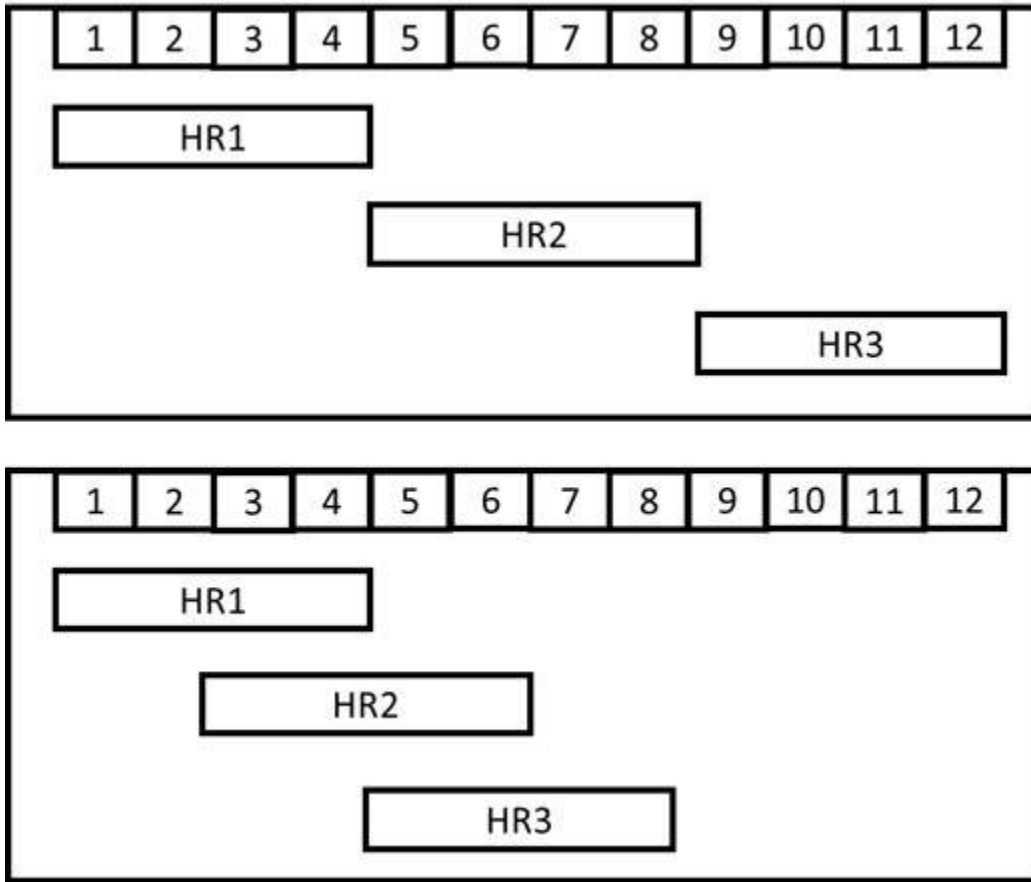

Figure 8.8: Fast Tracking

8.7 Microsoft Project Tutorial

For the MS Project tutorial, let's continue with our example of m-commerce project. Let's focus on "1. Scope". The WBS for the scope stage is in Table 8.4. This table also includes the duration, start and finish dates, and predecessors.

Table 8.4: WBS for the Scope of the M-Commerce Project

WBS	Task Name	Duration	Start	Finish	Predecessors
1	Scope	35 days	Mon 5/2/22	Mon 6/20/22	
1.1	Clarify project purpose and determine project scope.	5 days	Mon 5/2/22	Fri 5/6/22	
1.2	Secure project sponsorship	1 day	Mon 5/9/22	Mon 5/9/22	2
1.3	Preparation of project charter	22 days	Tue 5/10/22	Wed 6/8/22	
1.3.1	Develop high-level scope	4 days	Tue 5/10/22	Fri 5/13/22	3
1.3.2	Identify overall project risks	5 days	Mon 5/16/22	Fri 5/20/22	5
1.3.3	Develop high-level schedule	6 days	Mon 5/16/22	Mon 5/23/22	5
1.3.4	Identify main resources and develop a high-level budget	2 days	Tue 5/24/22	Wed 5/25/22	7
1.3.5	Identify key stakeholders and project team member roles	8 days	Mon 5/23/22	Wed 6/1/22	5,6
1.3.6	Develop project approval requirements and project exit criteria	5 days	Thu 6/2/22	Wed 6/8/22	5,6,7,8,9
1.4	Approval of project charter by the sponsor	2 days	Tue 6/9/22	Fri 6/10/22	10
1.5	Secure core resources	5 days	Mon 6/13/22	Fri 6/17/22	11
1.6	Initiation stage complete	0 days	Mon 6/20/22	Mon 6/20/22	12

Let's identify the resources that we can use for the scope. We should enter them in the Resource Sheet after we click "Resource Sheet" in the dropdown menu (Figure 8.9).

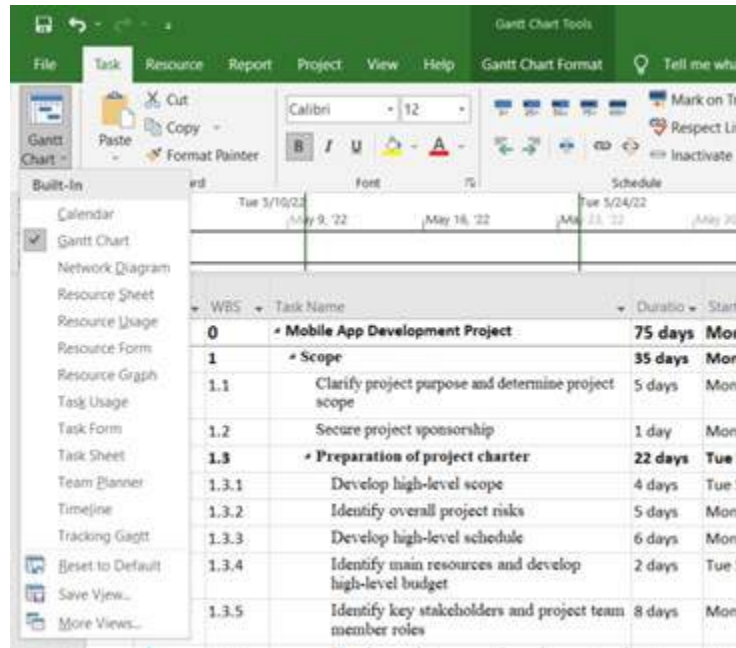

Figure 8.9: Dropdown Menu for the Resource Sheet

In the Resource Sheet window, we can type the resources. There are three types of resources in MS Project:

1. Work: Work resources are people and equipment. They have a standard rate per hour.
2. Material: Material resources are consumable supplies. They have a unit of measurement such as tones, boxes, and cubic yards.
3. Cost: Cost resources are independent costs we want to associate with a task such as a plane ticket.

Let's type all the resources as seen in Figure 8.10. In this chapter, we won't write standard rates, overtime rates, and cost/use. We will detail them in Chapter 9. We are only typing the human resources in this tutorial. Therefore, they are classified as "Work" type. We keep "Max" (Maximum units) 100% as they work full-time.

	Resource Name	Type	Material	Initials	Group	Max.	Std. Rate	Ovt. Rate	Cost/Use	Accrue	Base
1	Project Manager	Work		PM		100%	\$0.00/hr	\$0.00/hr	\$0.00	Prorated	Standard
2	Systems Analyst 1	Work		SA1		100%	\$0.00/hr	\$0.00/hr	\$0.00	Prorated	Standard
3	Systems Analyst 2	Work		SA2		100%	\$0.00/hr	\$0.00/hr	\$0.00	Prorated	Standard
4	UI/UX Designer 1	Work		DES1		100%	\$0.00/hr	\$0.00/hr	\$0.00	Prorated	Standard
5	UI/UX Designer 2	Work		DES2		100%	\$0.00/hr	\$0.00/hr	\$0.00	Prorated	Standard
6	Developer 1	Work		DEV1		100%	\$0.00/hr	\$0.00/hr	\$0.00	Prorated	Standard
7	Developer 2	Work		DEV2		100%	\$0.00/hr	\$0.00/hr	\$0.00	Prorated	Standard
8	Tester 1	Work		TEST1		100%	\$0.00/hr	\$0.00/hr	\$0.00	Prorated	Standard
9	Tester 2	Work		TEST2		100%	\$0.00/hr	\$0.00/hr	\$0.00	Prorated	Standard
10	Sales & Marketing Expert 1	Work		SALES1		100%	\$0.00/hr	\$0.00/hr	\$0.00	Prorated	Standard
11	Sales & Marketing Expert 2	Work		SALES2		100%	\$0.00/hr	\$0.00/hr	\$0.00	Prorated	Standard
12	Systems Analyst 3	Work		SA3		100%	\$0.00/hr	\$0.00/hr	\$0.00	Prorated	Standard

Figure 8.10: Resources in Resource Sheet

After we type the resources, we can assign them to their tasks in the Gantt Chart window on the dropdown menu (Figure 8.9).

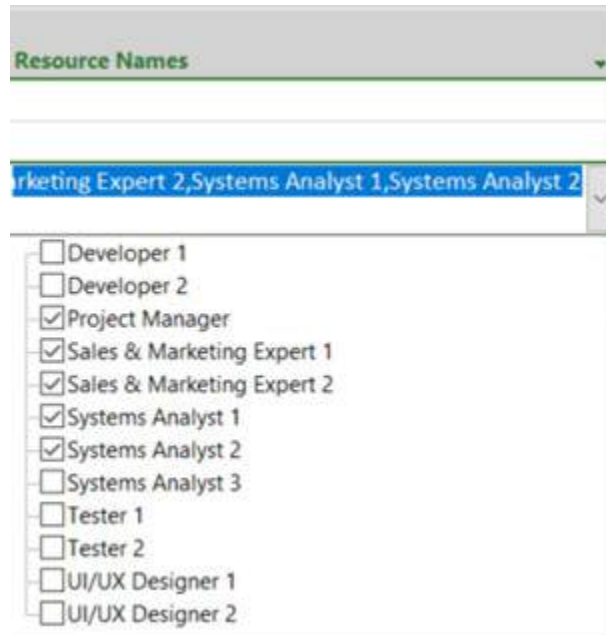

Figure 8.11: Assigning the Resources in the Tasks on Dropdown Menu

After we assign all the resources to their relevant tasks, we can see the information below as in Figure 8.12.

Task Mode	WBS	Task Name	Duration	Start	Finish	Pred	Resource Names
0	MS	0	Mobile App Development Project	75 days	Mon 5/2/22	Mon 8/15/22	
1	MS	1	Scope	35 days	Mon 5/2/22	Mon 6/20/22	
2		1.1	Clarify project purpose and determine project scope	5 days	Mon 5/2/22	Fri 5/6/22	Project Manager,Sales & Marketing Expert 1, Sales & Marketing Expert 2,Systems Analyst 1,Systems Analyst 2
3		1.2	Secure project sponsorship	1 day	Mon 5/9/22	Mon 5/9/22	2 Project Manager
4	MS	1.3	Preparation of project charter	22 days	Tue 5/10/22	Wed 6/8/22	
5		1.3.1	Develop high-level scope	4 days	Tue 5/10/22	Fri 5/13/22	3 Systems Analyst 1
6		1.3.2	Identify overall project risks	5 days	Mon 5/16/22	Fri 5/20/22	5 Systems Analyst 2
7		1.3.3	Develop high-level schedule	6 days	Mon 5/16/22	Mon 5/23/22	5 Systems Analyst 1
8		1.3.4	Identify main resources and develop high-level budget	2 days	Tue 5/24/22	Wed 5/25/22	7 Systems Analyst 1,Systems Analyst 2
9		1.3.5	Identify key stakeholders and project team member roles	8 days	Mon 5/23/22	Wed 6/1/22	5,6 Sales & Marketing Expert 1,Sales & Marketing Expert 2, Systems Analyst 1,Systems Analyst 2
10		1.3.6	Develop project approval requirements and project exit criteria	5 days	Thu 6/2/22	Wed 6/8/22	5,6,7,8; Systems Analyst 1,Systems Analyst 2
11		1.4	Approval of project charter by the sponsor	2 days	Thu 6/9/22	Fri 6/10/22	10 Project Manager
12		1.5	Secure core resources	5 days	Mon 6/13/22	Fri 6/17/22	11 Project Manager
13		1.6	Initiation stage complete	0 days	Mon 6/20/22	Mon 6/20/22	12

Figure 8.12: Assigning the Resources in the Tasks

The Gantt chart which is on the right side of the window would be as in Figure 8.13. The MS Project illustrates the Gantt chart with bars and the resources assigned to each task to the right of each task bar. As explained in Chapter 7, the red bar displays a critical path, and the blue bar displays a non-critical path.

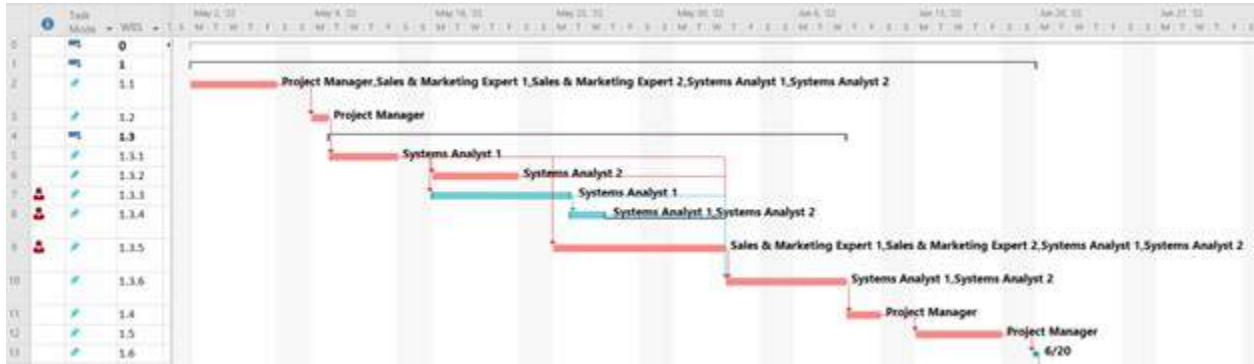

Figure 8.13: Gantt Chart for the Scope

As can be seen in Figures 8.12 and 8.13, there are three red people indicators in the first column. This is a warning for overallocated resources. We can investigate more to understand which resources are overallocated. On the dropdown menu in Figure 8.9, we can select “Resource Graph”. Figure 8.14 shows us that Systems Analyst 1 is overallocated on three days, which is more than 100%.



Figure 8.14: Resource Graph Displaying Overallocated Resources

We can implement resource leveling for these three activities. On the “Resource” tab, we can select “Level Resource” or “Level All” (Figure 8.15). Leveling options can also be modified. For this tutorial, we are not changing the options.

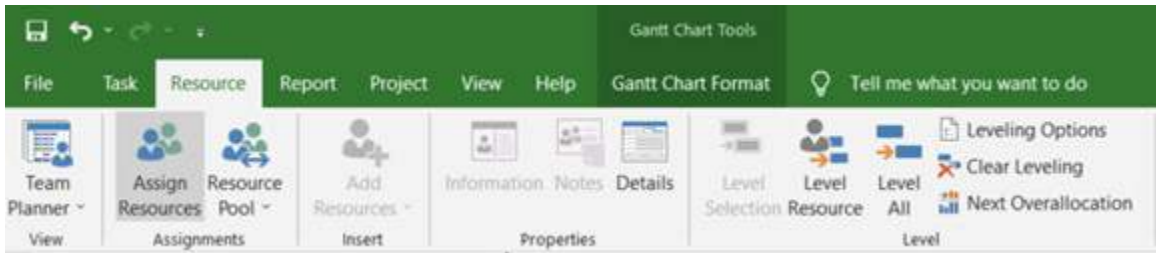

Figure 8.15: Resource Tab

When we click “Level All”, MS Project levels the resources in these three activities with resource overallocation (Figure 8.16). Therefore, our resource overallocation is resolved. The duration of 1.3 was 22 days before resource leveling. After the leveling, it is 25 days. Therefore, there is a 3-day slippage as we are using the same resources, and aren’t allocating new resources. However, the total duration of “1. Scope” didn’t change, and stayed at 35 days after leveling.

7			1.3.3	Develop high-level schedule	6 days	Mon 5/16/22	Mon 5/23/22	5
8			1.3.4	Identify main resources and develop high-level budget	2 days	Tue 5/24/22	Wed 5/25/22	7
9			1.3.5	Identify key stakeholders and project team member roles	8 days	Mon 5/23/22	Wed 6/1/22	5,6
10			1.3.6	Develop project approval requirements and project exit criteria	5 days	Thu 6/2/22	Wed 6/8/22	5,6,7,8,9

7			1.3.3	Develop high-level schedule	6 days	Mon 5/16/22	Mon 5/23/22	5
8			1.3.4	Identify main resources and develop high-level budget	3 days	Thu 6/2/22	Mon 6/6/22	7
9			1.3.5	Identify key stakeholders and project team member roles	9 days	Mon 5/23/22	Thu 6/2/22	5,6
10			1.3.6	Develop project approval requirements and project exit criteria	6 days	Mon 6/6/22	<u>Mon 6/13/22</u>	5,6,7,8,9

Figure 8.16: Schedule before and after Resource Leveling

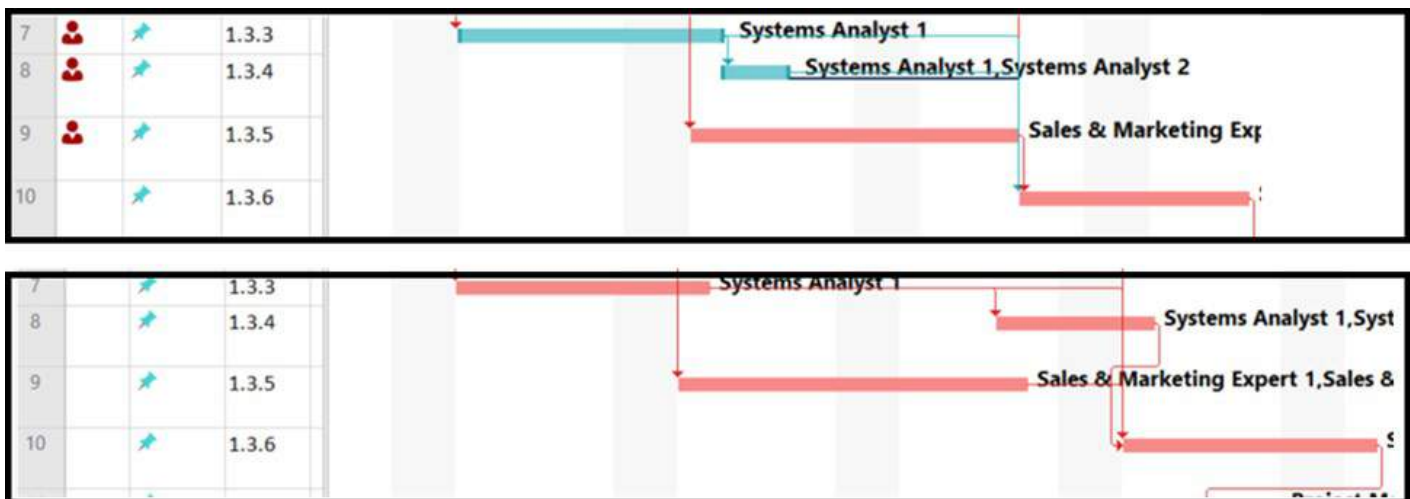

Figure 8.17: Gantt Chart before and after Resource Leveling

But we now experience a schedule slippage as seen in Figures 8.16 and 8.17. Besides, 1.3.6 and the following activities are affected. 1.3.6 has an underlined text for the Finish Date, which means that there is a scheduling problem. After resource leveling, it is common to experience schedule problems in

the following activities. To solve the scheduling problem in 1.3.6 and the following activities, we can click “Respect Links” for 1.3.6 and all the following activities. Besides, MS Project gives some options when we right-click on an underlined date as seen in Figure 8.18. When we right-clicked on the underlined finish date (Mon 6/13/22) of 1.3.6, it gave us the options “Fix in Task Inspector”, “Respect Links”, and “Switch to Auto Scheduled”.

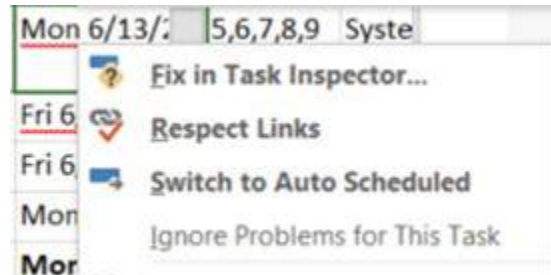

Figure 8.18: Solving Scheduling Problems

After all the scheduling problems are corrected, the total duration of Scope goes up to 39 days from 35 days (Figure 8.19).

1	Scope	39 days	Mon 5/2/22	Fri 6/24/22
1.1	Clarify project purpose and determine project scope	5 days	Mon 5/2/22	Fri 5/6/22
1.2	Secure project sponsorship	1 day	Mon 5/9/22	Mon 5/9/22
1.3	Preparation of project charter	26 days	Tue 5/10/22	Tue 6/14/22
1.3.1	Develop high-level scope	4 days	Tue 5/10/22	Fri 5/13/22
1.3.2	Identify overall project risks	5 days	Mon 5/16/22	Fri 5/20/22
1.3.3	Develop high-level schedule	6 days	Mon 5/16/22	Mon 5/23/22
1.3.4	Identify main resources and develop high-level budget	3 days	Thu 6/2/22	Mon 6/6/22
1.3.5	Identify key stakeholders and project team member roles	9 days	Mon 5/23/22	Thu 6/2/22
1.3.6	Develop project approval requirements and project exit criteria	6 days	Tue 6/7/22	Tue 6/14/22

Figure 8.18: Solving Scheduling Problems

8.8 Key Takeaways

Key Takeaways

- Resource management is the efficient and effective deployment of an organization's resources when they are needed. These resources can be classified as human resources, physical resources, and services.
- Planning resource management is the process of establishing the policies, procedures, and documentation for planning, developing, managing, executing, and controlling the project resources.
- Resource Breakdown Structure helps the team to illustrate the resource needs in a hierarchical structure.
- The techniques to estimate the resources are expert judgment, alternative analysis, analogous estimating, and bottom-up estimating.
- Allocation of the resources to the project activities is called "Resource Loading".
- Resource leveling is used to examine the unbalanced use of resources (usually people or equipment) over time and for resolving overallocation or conflicts.
- Schedule compression techniques such as crashing and fast-tracking are utilized to accelerate the project.

8.9 Questions and Exercises

There are 5 questions for this chapter. As you submit each answer, you will get immediate feedback and be taken to the next question.

An interactive or media element has been excluded from this version of the text. You can view it online here:

<https://pressbooks.ulib.csuohio.edu/project-management-navigating-the-complexity/?p=609>

8.10 Attribution

This chapter is a derivative of the following texts:

1. [Project Management by Adrienne Watt](#). © [CC BY \(Attribution\)](#).
2. [Project Management from Simple to Complex](#). © [CC BY \(Attribution\)](#).
3. [Project Management by Florence Daddey](#). © [CC BY \(Attribution\)](#).
4. [Project Management Fundamentals by Shelly Morris](#). © [CC BY \(Attribution\)](#).
5. [Project Management by Merrie Barron and Andrew R. Barron](#). © [CC BY \(Attribution\)](#).
6. [Principles of Management](#) © [CC BY \(Attribution\)](#).

Chapter 9. Budget and Procurement

9.0 Learning Objectives and Overview

Learning Objectives

1. Define the project cost and explain its types.
2. Create a project cost plan to help guide the project team through the implementation and closure phases of the project.
3. Define the budget estimation techniques.
4. Describe the process of documenting project procurement decisions, specifying the approach, and identifying potential sellers. Define the resources that will be utilized in a project, including the project team members
5. Practice the allocation of resources and calculation of their costs with Microsoft Project

Overview

While performing the planning of all the knowledge areas (e.g., scope, schedule, cost, quality, stakeholders, risks), the project manager should be aware of the fact that all knowledge areas are tightly linked to each other. That is, it is not possible to start with cost or quality first. The scope is the starting point when project managers with the help of business analysts, subject matter experts, clients, the project sponsor, and various stakeholders identify the project purpose, measurable objectives, requirements, deliverables, and WBS activities. Whereas scope, time, and cost are the main constraints of a project, all three are tightly linked to the resources, which are other constraints that include time and cost as critical resources. After the scope (see Chapters 3 and 4) and schedule (see Chapter 7) are delineated, the project manager can continue with the identification and allocation of resources based on the scope (requirements and project activities) and the schedule (how project activities are sequenced with duration for each of them). Allocation of resources provides the project manager to determine the overall project budget most of which is spent on resources (Chapter 8).

Every project boils down to money. If we had a bigger budget, we could probably get more people to do the project more quickly and deliver more. That's why no project plan is complete until we come up with a budget. But no matter whether the project is big or small, and no matter how many resources and activities are in it, the process for figuring out the financial bottom line is always the same. This chapter starts with defining the project cost and its types, then elaborates on the cost management plan, continues with how to estimate costs and determine the budget, and ends with project procurement management. We will expand Microsoft Project exercises in chapters 4 (scope), 7, (schedule), and 8 (resources) by specifying the cost for all the activities and the overall project.

9.1 Project Costs

One of the criteria of project success is completing the project within budget. Developing and controlling a project budget that will accomplish the project objectives is a critical project management skill. Although stakeholders expect the project to be executed effectively and efficiently, pressures to remain within budget vary based on the unique constraints and priorities of the project. On some projects, the project completion date is the highest priority leading to a more flexible budget to accommodate the inflexible deadline. Moreover, the project's scope may have to be scaled back if it is too ambitious to finish in time. On other projects, for example, ones with limited funding available, remaining within budget is the highest priority. When this is the case, effective cost management is imperative and trade-offs with scope, quality, and/or time may be required.

9.1.1 Boston's Infamous Big Dig (Central Artery/Tunnel) Project

One of the notorious examples of project budget overrun is Boston's Big Dig project although its outcome had significant benefits to the Boston residents by lowering traffic jams and pollution. Central Artery/Tunnel Project, the official name of the project, was the largest, most challenging highway project in the history of the United States. This project's objective was to reduce traffic and improve mobility in one of America's oldest, most congested major cities. Although the project had been planned in the 1980s, it was completed in 2007. Its original completion was scheduled in the late 1990s, and its original cost was estimated to be about 3 million dollars. However, including the interest to be paid, the total cost was estimated to be 24 million dollars. As listed by Greiman and Warburton (2009), common causes for cost escalation on the Big Dig included: the failure to include a cost for inflation in each contract; delays in project completion; and the actual rate of inflation being greater than the planned estimate. Other factors that impacted the Big Dig were financing shortfalls and interest rates, scope changes, shortages of materials and labor, price increases, and market changes, weak project managers, technical and design complexity, unexpected events and force majeure, and political and legal risks.

The Big Dig project is considered a mega project, and unfortunately, many mega projects suffered a substantial cost overrun as well as other problems regarding the scope, schedule, risks, and resources, which in turn, led to the cost overruns. However, smaller projects, even our personal projects such as moving to another house and going on a summer vacation, may experience problems with the cost. When problems start in a project, the sponsor, clients, and other stakeholders first realize the abnormality in the budget which is an explicit reflection of something going bad. The more money we spend over the estimated budget, the more it hurts the stakeholders since the financial assets of a project, organizations and individuals can be analogous to the blood of a living thing.

Some of the reasons why projects fail to keep themselves on track with regard to their budget can be

outlined below:

1. Project activities may not be identified in accordance with the project objectives and product scope. For example, if the project manager doesn't include the required travel and accommodation expenses that are required for the factory test in another city or country.
2. The duration of project activities may not be estimated correctly, thus leading to shorter or longer duration. For example, if an activity's duration is determined as one week whereas it requires at least two weeks to complete all the tasks, an additional week would lead to more labor and material costs.
3. Underestimation of costs per activity and resource. Let's assume that the minimum hourly wage of a systems analyst is \$30 currently, and it is difficult to find one who can accept a wage below \$30. However, we take into account the costs in a similar project which was completed two years ago. Thus, we estimated \$20 per hour for a systems analyst. If two analysts work for 100 hours in total, this underestimation could cause us to spend an additional \$1,000 in the best scenario.
4. Risk identification is an essential process during the planning phase. If risks cannot be identified properly (see Chapter 10), for instance, if a risk that may put the project in jeopardy is overlooked, we will need to allocate an additional budget in case the risk occurs. In a worse case, the project may fail, which cannot be even saved with an additional budget.

9.1.2 Project Cost Types

There are generally three different types of project costs:

1. Direct costs
2. Project-induced overhead costs
3. General administrative costs

The primary difference between these costs is how closely related they are to the specific activities of the project.

Direct costs are directly related to specific project tasks. These costs represent the labor, time, and materials associated with specific tasks. If a software developer works on our m-commerce project for 40 hours, each hour they work to code the mobile application will be incurred as a direct cost. These are generally variable costs as is the case for the software developer cost.

Project-induced overhead costs are incurred as a result of the project's existence, but they are not directly related to specific tasks. These costs represent the compensation paid to individuals who are supporting the project in its entirety, such as the project leader and their support staff (project analysts, coordinators, etc.). These costs also represent materials, facilities, and related equipment that were purchased to support the project in general. The rental and maintenance of workspace for the project team members, as well as their computers and related information technology, supplies, and lunch (if provided), are all examples of overhead costs. If we rent an office for the developers and testers to work together, then this fixed cost would be also a direct cost.

Lastly, **general administrative costs** are indirectly related to a project, and they are incurred even if the project is not carried out. Examples of this type of cost include marketing, human resources, and accounting department-related expenses. These departments may provide ad-hoc and minimal support to the project teams and as a result, the project sponsors may want a portion of their costs to be allocated to all projects underway in the organization. Allocating a portion of the costs to the project provides the executive with a full picture of all costs incurred due to the implementation of strategic change initiatives in the organization. Since the allocation methods are often very subjective, many organizations exclude general administrative costs from the project budget.

It is important to note that some projects require the direct involvement of these administrative functions. This should be clearly identified in the project's work breakdown structure. For instance, a project that involves the introduction of new technology will alter the way people work and this may require members of the human resources department to reevaluate existing job descriptions, compensation levels, and so forth. In this instance, the human resources function is a work package and the costs associated with their work are direct costs.

The Big Dig: project background. (n.d). Highway Division - Massachusetts Department of Transportation. Retrieved from <https://www.mass.gov/info-details/the-big-dig-project-background>
Retrieved from <https://interestingengineering.com/7-big-facts-about-the-big-dig>
Tran A.B. (2014). Federal spending on Massachusetts transportation over time. Retrieved from <https://www.bostonglobe.com/2014/12/05/federal-spending-massachusetts-transportation-over-time/eIx7CAnnHS33eaIFbuinIM/story.html>
Greiman, V. & Warburton, R. D. H. (2009). Deconstructing the Big Dig: best practices for mega-project cost estimating. Paper presented at PMI® Global Congress 2009—North America, Orlando, FL.
Newtown Square, PA: Project Management Institute.

9.2 Project Cost Management Plan

As described in Chapter 4, project planning is at the heart of the project life cycle and tells everyone involved where we are going and how we are going to get there. It involves creating a set of plans to help guide our team through the implementation and closure phases of the project. The project cost management plan is one of the sub-plans of our overall project plan. It provides guidelines to project managers on how to estimate, budget, manage, monitor, and control project costs.

A project cost management plan consists of similar items that we have in a schedule management plan. This plan can consist of the following:

- **Process descriptions**
 - What processes will be used for cost management?
 - These processes include planning, estimating costs, and establishing the overall budget.
- **Unit of measurement**
 - Daily working hours and shifts for human resources and equipment
 - Weekends and/or off-days for especially human resources
 - Metric (e.g., meter, liter, kilogram) or imperial (e.g., inch, gallon, pound) system measurement units
- **Level of accuracy**
 - Acceptable range to ensure realistic cost estimates (e.g., $\pm 10\%$, ± 20)
 - Evaluation of the impact of risks on the costs of each activity and overall project based on the project risk management plan
 - Methods describing how the cost contingencies will be assessed.
 - Procedure to account for fluctuations in currency exchange rates
- **Level of precision**
 - The degree to which cost estimates will be rounded up or down (e.g., \$95.55 to \$96; \$95.45 to \$95; \$495.75 to \$496 or \$500)
 - Evaluated based on the scope, size, and complexity of the project.
- **Cost estimation methods**
 - Estimation methods (e.g., expert judgment, analogous, parametric, three-point, bottom-up), and when they will be utilized.
- **Methods, tools, and software utilized to develop, manage, and monitor project cost**
 - Specify the organizational procedures and policies if they should be utilized.
 - Methods and tools such as control accounts, WBS, project baseline, Earned Value

Management, and critical path method

- Reserve analysis to set aside some money for cost overruns due to risks in order to implement risk mitigation strategies.
- Software such as Microsoft Project Professional, Excel, Visio, and Jira (for Kanban and Scrum), and online collaboration tools such as Monday, Trello, and Basecamp.

- **Rules for monitoring cost performance**

- Earned Value Management (EVM)
- Defining the points in the WBS at which measurement of control accounts will be performed
- How strategic funding choices would be managed.
- Control thresholds for deviations from the parameters in the cost baseline
- Using software such as Microsoft Project

- **Reporting formats**

- Reporting formats and frequency should be in alignment with other project plans.
- When, how frequently, and to whom are we reporting?

- **Approval of the cost baseline**

- Who will be responsible for preparation and control?
- Who will approve the cost baseline?

Project Management Institute. (2017). A guide to the Project Management Body of Knowledge (PMBOK guide) (6th ed.). Project Management Institute.

Project Management Institute. (2017). A guide to the Project Management Body of Knowledge (PMBOK guide) (6th ed.). Project Management Institute.

Harrin, E. (2014) 7 Things for your cost management plan. Retrieved from

<https://www.projectmanagement.com/blog-post/7645/7-things-for-your-cost-management-plan>

Harrin, E. (2014) 7 Things for your cost management plan. Retrieved from

<https://www.projectmanagement.com/blog-post/7645/7-things-for-your-cost-management-plan>

9.3 Estimating Costs and Determining Budget

As detailed in Chapter 2, financial indicators are commonly utilized in business cases and their accompanying benefits management plan while selecting projects to continue with. Whereas financial indicators such as profitability, NPV (Net Present Value), and payback period are helpful in the selection process to understand the economic feasibility of the projects, we should emphasize again that there are multiple criteria besides financial indicators. During this selection process and when the project is conceptualized to create a project charter, business analysts and project managers usually don't have an adequate amount of information to estimate an accurate cost. Therefore, estimation techniques such as expert judgment and analogous estimating could be more helpful during the earlier stages. Expert judgment of experienced managers can help make more accurate estimates with less detailed information. Estimates in the earliest stages also include information from previous projects (i.e., analogous estimating) that can be adjusted and scaled to match the size and complexity of the current project. Besides standardized formulas can be used (parametric estimating). When we make an estimate early in the project without knowing much about it, that estimate is called a rough order-of-magnitude estimate (or a ballpark estimate). This estimate will become more refined as time goes on and we learn more about the project. In a later stage, the planning phase, when we develop the WBS and activity list, bottom-up estimating accompanied by three-point estimates can generate cost estimates with better accuracy.

The goal of estimating costs is to determine the monetary resources required for the project^[1]. In order to estimate costs for individual activities and the overall project, as explained above, we can use the techniques that we utilized to estimate schedule and resources. In this textbook, we will describe five tools and techniques for estimating costs.

9.3.1 Expert Judgment

As discussed in Chapters 7 and 8, the project team consults domain and implementation subject matter experts who have technical knowledge and experience in the areas the project activities are related. These experts are those who worked on previous similar projects, and/or those who have information in the industry, discipline, and application area. Experts in organizations' finance, accounting, and procurement departments are usually consulted. All these experts can be consulted during the pre-project work, and also during the initiating and planning.

9.3.2 Analogous estimating

As discussed in Chapters 7 and 8, information and lessons learned from previous projects, standards provided by the regulatory agencies, government organizations, and occupational associations, and the

data that rely on articles, books, journals, and periodicals can be utilized to estimate costs. If a similar project cost a certain amount, then it can be reasonable to assume that the current project will cost about the same. However, many factors need to be taken into account since simply copying the costs from previous projects and pasting them on the new project's cost tables wouldn't work for most of the projects. Few projects have the same size and complexity. Therefore, estimates must be adjusted upward or downward to account for the differences. Inflation and currency rates as well as socio-economic conditions are important indicators that would entail an adjustment. The selection of projects that are similar and the amount of adjustment needed is up to the judgment of the person or the team who makes the estimate. It should include the lessons learned from previous projects, both at an organizational level and individual level. Therefore, this judgment is based on many years of experience comprised of successful and unsuccessful projects and their estimates.

9.3.3 Parametric estimating

As explained in Chapter 7, in this estimation technique, we can use equations and algorithms to calculate the costs. This method is quantitative. Estimates are calculated by multiplying measured parameters by cost-per-unit values. If the project consists of activities that are common to many other projects, average costs are available per unit. For example, if we ask a construction company how much it would cost to build a standard office building, they will ask for the size of the building in square feet and the city in which the building will be built. From these two factors—size and location—the company's estimator can predict the cost of the building. Factors like size and location are parameters—measurable factors that can be used in an equation to calculate a result. The estimator knows the average cost per square foot of a typical office building and adjustments for local labor costs. Other parameters such as quality of finishes are used to further refine the estimate. Readers can visit Cost To Build's website <https://www.costtobuild.net/calculator.html> to estimate the cost of their dream houses and garages. In Chapter 7, for Grocery LLC's m-commerce project, we calculated the time software developers need to create 200 lines of code for a module. Based on the previous projects and the feedback we received from the subject matter experts, we have estimated that a developer can finish 40 lines in an hour, and hence 200 lines in 5 hours. We also added a one-hour break and a two-hour review for this task. Therefore, the total work hours amounted to 8 hours. If the average hourly rate of a software developer is \$50, for this activity, we will pay \$400 (\$50 x 8 hours). Project managers can also prefer deducting one hour of break time. This technique can produce higher levels of accuracy depending on the sophistication and underlying data built into the model. Parametric estimates can be applied to the whole project or segments of it, in conjunction with other estimating methods.

9.3.4 Three-point estimating

As is done for activity duration estimates (see Chapter 7), cost estimates can be also done based on three scenarios:

- a. A realistic estimate (most likely to occur - m)
- b. An optimistic estimate (best-case scenario - o)

- c. A pessimistic estimate (worst-case scenario - p)

Please refer to the exercise inside the “7.3 Estimating Activity Durations” sections in Chapter 7. Furthermore, three-point estimating is detailed in “9.3.1 Case Study 9.1: Estimating the Cost for M-Commerce Project’s Scope Component”.

9.3.5 Bottom-up estimating

As discussed in Chapters 7 and 8, we decompose our project activities through WBS by breaking down complex activities into pieces - work packages. Cost estimation can be made more accurately after each activity duration is estimated, and the resources required for each activity are identified. It is a process of estimating individual activity costs and then adding these together to come up with a total estimate. It takes a considerable amount of time to perform bottom-up estimating because every activity must be assessed and estimated accurately to be included in the bottom-up calculation. The smaller and more detailed the activity, the greater the accuracy and cost of this technique. Parametric estimating and three-point estimating are commonly utilized together with bottom-up estimating.

9.3.6 Case Study 9.1: Estimating the Cost for M-Commerce Project’s Scope Component

Let’s continue with our example in Chapter 8. Table 9.1 is the revised resource usage calendar (Table 8.3) after resources are leveled.

Table 9.1: Resource Usage Calendar after Resource Leveling

Resource Name	Work	May 2	May 9	May 16	May 23	May 30
Systems Analyst 1	168 hrs	40	32	40	24	32
<i>Clarify project purpose and determine project scope</i>	40 hrs	40				
<i>Develop high-level scope</i>	32 hrs		32			
<i>Develop high-level schedule</i>	48 hrs			40	8	
<i>Identify main resources and develop a high-level budget</i>	16 hrs				16	
<i>Identify key stakeholders and project team member roles</i>	16 hrs					16
<i>Develop project approval requirements and project exit criteria</i>	16 hrs					16
Systems Analyst 2	144 hrs	40	0	40	24	40
<i>Clarify project purpose and determine project scope</i>	40 hrs	40				
<i>Identify overall project risks</i>	40 hrs			40		
<i>Identify main resources and develop a high-level budget</i>	16 hrs				16	
<i>Identify key stakeholders and project team member roles</i>	24 hrs				8	16
<i>Develop project approval requirements and project exit criteria</i>	24 hrs					24
Sales & Marketing Expert 1	64 hrs	40	0	0	8	16
<i>Clarify project purpose and determine project scope</i>	40 hrs	40				
<i>Identify key stakeholders and project team member roles</i>	24 hrs				8	16
Sales & Marketing Expert 2	64 hrs	40	0	0	8	16
<i>Clarify project purpose and determine project scope</i>	40 hrs	40				
<i>Identify key stakeholders and project team member roles</i>	24 hrs				8	16

To conduct a parametric estimating, we should know the hourly rates of these four human resources. In this example, we assume that we only use these resources, and they work full-time in project activities. Their hourly rates are given in Table 9.2 below. Besides these four human resources, we have the project manager who is always involved in all project activities to coordinate them and ensure that all of them are smoothly performed and completed. Therefore, we won't assign an hourly rate to the project manager, but a weekly rate of \$2,000. The duration of "Scope" is 6 weeks. Therefore, the cost of the project manager is \$12,000 for the "Scope".

Table 9.2: Hourly Rates of Four Team Members

Human Resources	Hourly Rate	Total Work Hours	Total Cost for the Scope
Systems Analyst 1	\$30.00	168	\$5,040.00
Systems Analyst 2	\$30.00	144	\$4,320.00
Sales and Marketing Expert 1	\$20.00	64	\$1,280.00
Sales and Marketing Expert 2	\$20.00	64	\$1,280.00
Project Manager	\$2,000.00 (Weekly rate)	6 weeks	\$12,000.00
TOTAL			\$23,920

As can be seen in Table 9.2, parametric estimating has been used to calculate the total costs for the scope. For instance, systems analyst 1 will be paid \$5,040 which is the result of a multiplication of \$30 by 168 hours. We also added the project manager's six-week cost making the total cost for the "Scope" \$23,920.

Table 9.3 details the costs by activity. As can be seen in this table, work packages under 1.3 are added to compute the total cost of 1.3, and all the activities are added to compute the total cost of the "Scope".

Table 9.3: Bottom-Up Estimating for the "Scope"

WBS	Activity Name	Cost
1.1	Clarify project purpose and determine project scope	\$4,000.00
1.2	Secure project sponsorship	\$0.00
1.3	Secure project charter	\$7,920.00
1.3.1	Develop high-level scope	\$960.00
1.3.2	Identify overall project risks	\$1,200.00
1.3.3	Develop high-level schedule	\$1,440.00
1.3.4	Identify main resources and develop a high-level budget	\$960.00
1.3.5	Identify key stakeholders and project team member roles	\$2,160.00
1.3.6	Develop project approval requirements and project exit criteria	\$1,200.00
1.4	Approval of project charter by the sponsor	\$0.00
1.5	Secure core resources	\$0.00
1.6	Initiation stage complete	\$0.00
	Project Manager's Salary	\$12,000.00
	TOTAL COST OF SCOPE	\$23,920.00

Let's also assume that, first, we utilized a three-point estimation for the activities of 1.3 in the initiation

phase, as seen in Table 9.4, but then we had details of each activity (e.g., requirements to be met, hours that team members should work to finish the activities) and recruited the people by signing contracts. Table 9.4 shows the three-point estimation in a beta distribution. The calculation below is for activity 1.3.1. After all the costs are estimated, we can add all of them to compute the total cost of 1.3 (Bottom-up estimating).

Beta distribution:

$$tE = \frac{(o+4m+p)}{6} = \frac{(735+4*890+1500)}{6} = \$965.83$$

Table 9.4: Three-Point Estimating for 1.3 of the “Scope”

WBS	Optimistic	Most Likely	Pessimistic	Cost
1.3				\$7,913.33
1.3.1	735	890	1500	\$965.83
1.3.2	850	1150	1600	\$1,175.00
1.3.3	925	1550	1945	\$1,511.67
1.3.4	515	825	1600	\$902.50
1.3.5	1450	2035	3250	\$2,140.00
1.3.6	880	1165	1770	\$1,218.33

Project management software such as Microsoft Project will often have features designed to help project managers estimate resource needs and constraints, and accordingly compute the costs for each activity and the overall project. Please see 9.6 “Microsoft Project Tutorials”.

Project Management Institute. (2017). A guide to the Project Management Body of Knowledge (PMBOK guide) (6th ed.). Project Management Institute.

Project Management Institute. (2017). A guide to the Project Management Body of Knowledge (PMBOK guide) (6th ed.). Project Management Institute.

International Institute of Business Analysis. (2015). A guide to the Business Analysis Body of Knowledge (BABOK Guide), version 3.0. Toronto, Ont: International Institute of Business Analysis.

Project Management Institute. (2017). A guide to the Project Management Body of Knowledge (PMBOK guide) (6th ed.). Project Management Institute.

9.4 Establishing the Project Budget

Once the cost of each activity is estimated, it is possible to determine how much money is needed for each activity and component, and the whole project. The process of subtotaling costs by category or activity is called cost aggregation. PMBOK Guide Sixth Edition defines this process as “Determine Budget” which is a process of aggregating the estimated costs of individual activities or work packages to establish an authorized cost baseline. This baseline is a time-phased budget that can be used to measure and monitor cost performance after it has been approved by the key project stakeholders. The aggregated budget is integrated with the project schedule in order to produce the time-phased budget. Costs are associated with tasks, and since each task has a start date and a duration period, it is possible to calculate how much money will be spent by any particular date during the project. Recognizing that all the money required to deliver the project is not needed upfront, allows the cash flow needs of the project to be effectively managed. For smaller organizations facing cash flow challenges, this can result in significant savings as the money required to pay for resources can be transferred to the project account shortly before it is needed.

Figure 9.1 illustrates the project budget components. While estimating the costs (see section 9.3), the project team should take into account the uncertainties that may affect the costs. This requires a reserve analysis which is conducted in line with risk management (See Chapter 10). Therefore, cost estimates are accompanied by contingency reserves for each activity and work package, if applicable. As can be seen in Figure 9.1, contingency reserve is included within the cost baseline. Therefore, these reserves must be incorporated into the baseline that ensures the monitoring and controlling of the project cost performance.

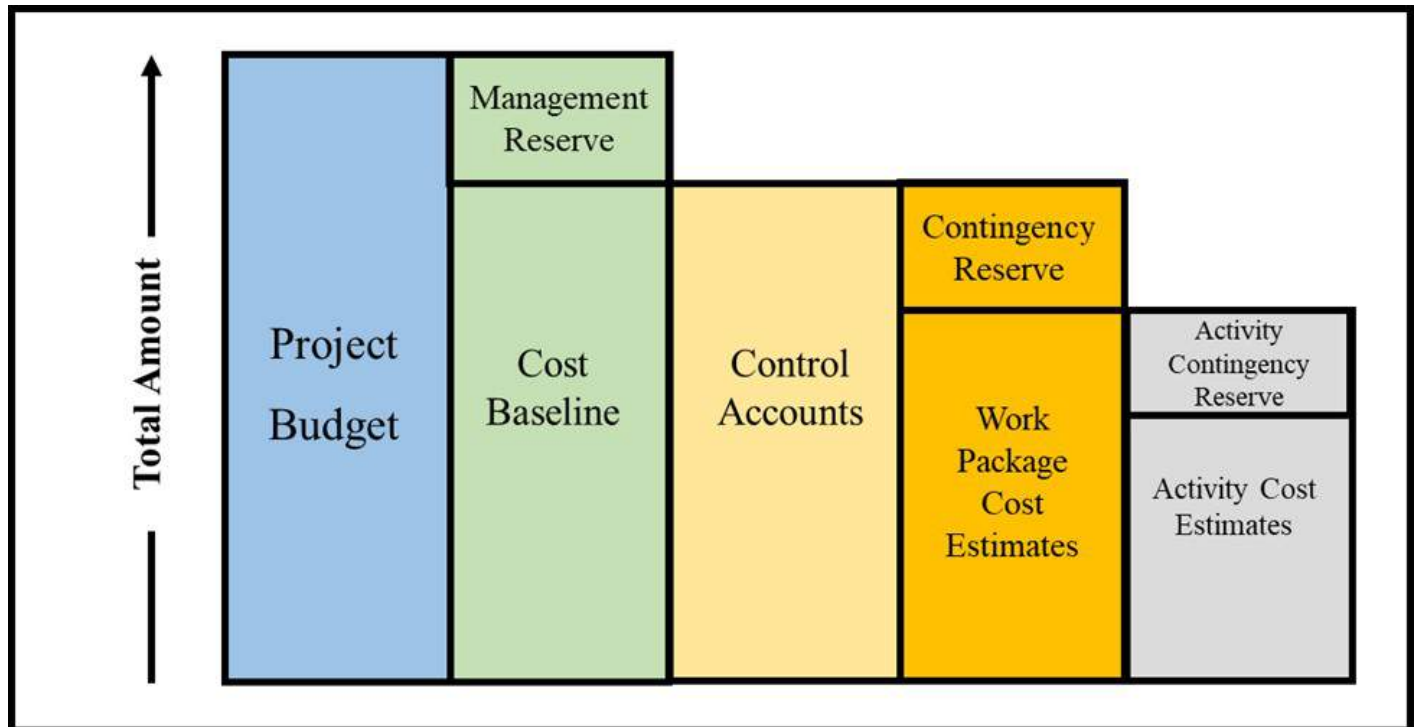

Figure 9.1: Project Budget Components
Adapted from PMBOK Guide Sixth Edition

Let's elaborate more on the reserve analysis. Contingency reserves are determined according to the risks that can be identified by the project team. Thus, they are called "known-unknowns". In our m-commerce project, our team identified a risk regarding the shortage of software developers. The demand for developers increased recently since the demand for online games and mobile apps has been on a sharp rise after the emergence of the COVID-19 pandemic. Therefore, we may experience a shortage of developers in the market. This risk can directly affect the activities under "2. Analysis/App Requirements" and "4. Development". Therefore, it would be appropriate to allocate contingency reserves to each affected activity. Unlike contingency reserve, management reserve is determined based on "unknown-unknowns" and applies to the whole budget. One obvious risk that emerged at the end of 2019 and has had a severe impact on all countries since March 2020 is the COVID-19 pandemic. This pandemic was an unknown-unknown for all the projects across the world.

The amount of a contingency reserve for each activity or a higher WBS level is determined after the risks and the strategies are identified and detailed (see Chapter 10). For instance, if an activity to test a website's functions and security is estimated to cost \$10,000, the project team can put an additional budget of \$2,000 to ensure an effective response to the security gaps if occurs. Then, the cost baseline of this activity becomes \$12,000 ($\$10,000 + \$2,000$). It can be adjusted when more information becomes available as time passes and activities are conducted and completed. It is also possible that new risks may emerge which has not been forecasted while the project management plans were being prepared. This is why project teams have regular meetings at which all the project components, issues, and risks are reviewed, which allows the team to take timely actions.

If we turn back to Table 9.3, we can see that the contingency reserves are not determined, therefore, the cost baseline includes only the resource costs. Let's assume that the project team agreed on

contingency reserves for three activities as shown in Table 9.5. Therefore, the cost baseline increases from \$23,920 to \$24,920.

Table 9.5: Cost Estimates and Contingency Reserves for “Scope” component

WBS	Activity Name	Cost	Contingency Reserve	Cost Baseline
1.1	Clarify project purpose and determine project scope	\$4,000.00	\$300.00	\$4,300.00
1.2	Secure project sponsorship	\$0.00	\$0.00	\$0.00
1.3	Preparation of project charter	\$7,920.00	\$0.00	\$7,920.00
1.3.1	Develop high-level scope	\$960.00	\$0.00	\$960.00
1.3.2	Identify main resources and develop a high-level budget	\$1,200.00	\$0.00	\$1,200.00
1.3.3	Develop high-level schedule	\$1,440.00	\$0.00	\$1,440.00
1.3.4	Identify main resources and develop a high-level budget	\$960.00	\$400.00	\$1,360.00
1.3.5	Identify key stakeholders and project team member roles	\$2,160.00	\$300.00	\$2,460.00
1.3.6	Develop project approval requirements and project exit criteria	\$1,200.00	\$0.00	\$1,200.00
1.4	Approval of project charter by the sponsor	\$0.00	\$0.00	\$0.00
1.5	Secure core resources	\$0.00	\$0.00	\$0.00
1.6	Initiation stage complete	\$0.00	\$0.00	\$0.00
	Project Manager’s Salary	\$12,000.00	\$0.00	\$12,000.00
	TOTAL COST OF SCOPE	\$23,920.00	1,000.00	\$24,920.00

Project Management Institute. (2017). A guide to the Project Management Body of Knowledge (PMBOK guide) (6th ed.). Project Management Institute.

9.5 Managing Project Costs

A key aspect of ongoing cost management is monitoring cost estimates. Projects seldom go according to plan in every detail. Baseline budgets often change after they have been approved. Successful project leaders understand that estimates are just that, estimates. As new information and real experience occur, it may be necessary to revise an estimate. In some cases, the revision is minor and does not impact the achievement of the project's total budget. In other instances, the necessary revisions are significant, and a new baseline needs to be created. Project managers need to discuss the ongoing management of the schedule with key stakeholders to understand their expectations of when/how they are informed of changes that need to be made. Stakeholders' expectations for ongoing cost management can be documented in the Cost Management Plan.

The project manager must be able to identify when costs are varying from the budget and, thus, manage these variations. A project manager must regularly compare the amount of money spent with the budgeted amount and report this information to managers and stakeholders. It is necessary to establish an understanding of how this progress will be measured and reported. Earned Value Management (EVM) is an effective tool used by project managers to monitor and control these variations. We will elaborate on EVM in Chapter 11.

If the total amount spent on a project is equal to or less than the amount budgeted, the project can still be in trouble if the funding for the project is not available when it is needed. There is a natural tension between the financial people in an organization, who do not want to pay for the use of money that is just sitting in a checking account, and the project manager, who wants to be sure that there is enough money available to pay for project expenses. The financial people prefer to keep the company's money working on other investments until the last moment before transferring it to the project account. The contractors and vendors have similar concerns, and they want to get paid as soon as possible so they can put the money to work in their own organizations. The project manager would like to have as much cash available as possible to use if activities exceed budget expectations.

As explained in section 9.4, project managers keep contingency and management reserves in case risks occur and activities need more money. In practice, most projects face uncertainties that increase costs above the original estimates. Estimating the likelihood of such uncertainties is part of risk analysis, which is discussed in more detail in Chapter 10.

9.6 Project Procurement Management

The procurement effort on projects varies widely and depends on the type of project. The “procurement cycle” reflects all procurement-related activities from when the decision is made to outsource equipment through to the payment of bills and closing of procurement contracts.

In less complex projects, the project team performs the work associated with procurement management. The procurement cycle includes:

- Identifying the required materials, equipment, and supplies
- Identifying the potential vendors
- Preparing requests for quotes (RFQs) and requests for proposals (RFPs), which include product/service specifications and a detailed delivery schedule
- Evaluating RFQs and RFPs to select the most suitable vendors
- Awarding and signing contracts
- Administering the contract and monitoring vendors’ performance
- Managing contract changes
- Closing out the contract upon work completion

On more complex projects, procurement professionals may be assigned to assist the team throughout the project’s lifetime.

9.6.1 Procurement Management Plan

In order to manage the process effectively and efficiently, we need to plan as we did for all the other knowledge areas (i.e., scope, schedule, cost, stakeholders, communication, resources). Therefore, we need to prepare a procurement management plan to document project procurement decisions, specify the approach, and identify potential sellers. We need to think about all of the work that we will contract out before doing anything else. We will want to plan for any purchases and acquisitions. Here’s where we take a close look at our needs, to be sure that we need to create a contract. Therefore, we should figure out what kinds of contracts make sense for our project, and we try to define all of the parts of our project that will be contracted out. We work out how we manage contracts, what metrics contracts should meet to be considered successful, how we will pick a seller, and how we will administer the contract once the work is happening.

The procurement management plan details how the procurement process will be managed. It can include the following information:

- Roles and responsibilities of the project team and procurement professionals

- The types of contracts we plan to use, and any metrics that will be used to measure the contractor's performance.
- The planned delivery dates for the work or products we are contracting.
- The organization's standard procurement documents and processes that our project must use and comply with.
- How many vendors or contractors are involved and how they will be managed.
- How purchasing may impact the constraints and assumptions of the project plan.
- Coordination of purchasing lead times with the development of the project schedule.
- Identification of prequalified sellers (if known).

The procurement management plan like all other management plans becomes a subsidiary of the project management plan. Some tools and techniques we may use during the procurement planning stage include make or buy analysis and defining the contract type.

9.6.2 Make or Buy Analysis

This means figuring out whether or not we should be contracting the work or doing it ourselves. It could also mean deciding whether to build a solution for the organization's or client's needs or buy one that is already available in the market. Most of the same factors that help us make every other major project decision will help us with this one. How much does it cost to build it as opposed to buy it? How will this decision affect the scope of the project? How about the project schedule? Do we have time to do the work and still meet our commitments? As we plan out what we will and won't contract, we need to have thought through our reasoning pretty carefully.

There are some resources (like heavy equipment) that our company can buy, rent, or lease depending on the situation. We need to examine leasing versus buying costs and determine the best way to go forward.

9.6.3 Contract Types

We should know a little bit about the major kinds of contracts so that we choose the one that creates the fairest and most workable deal for us and the contractor. Some contracts are fixed price. No matter how much time or effort goes into them, we always pay the same (Figure 9.2). The cost (or revenue to the vendor) is constant regardless of the effort applied or the delivery date. Some contracts are cost reimbursable also called cost plus (Figure 9.3). This is where the seller charges us for the cost of doing the work plus some fee or rate. In a cost reimbursable or cost-plus contract, the seller is guaranteed a specific fee. The third major kind of contract is time and materials (Figure 9.4). That's where the buyer pays a rate for the time spent working on the project and also pays for all the materials used to do the work. In a time and materials contract, the cost (or revenue to the vendor) increases with increased effort.

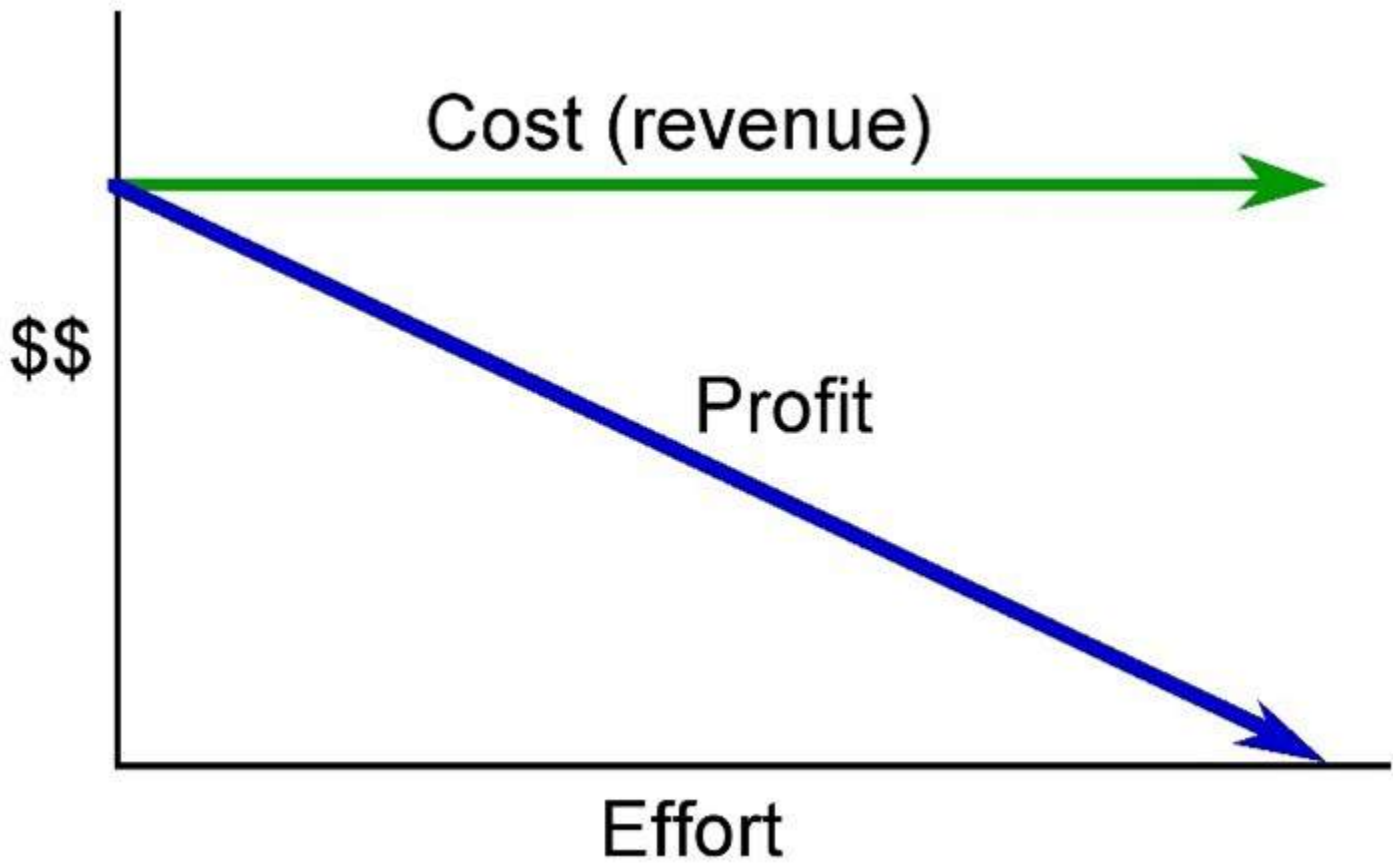

Figure 9.2: A fixed-price contract

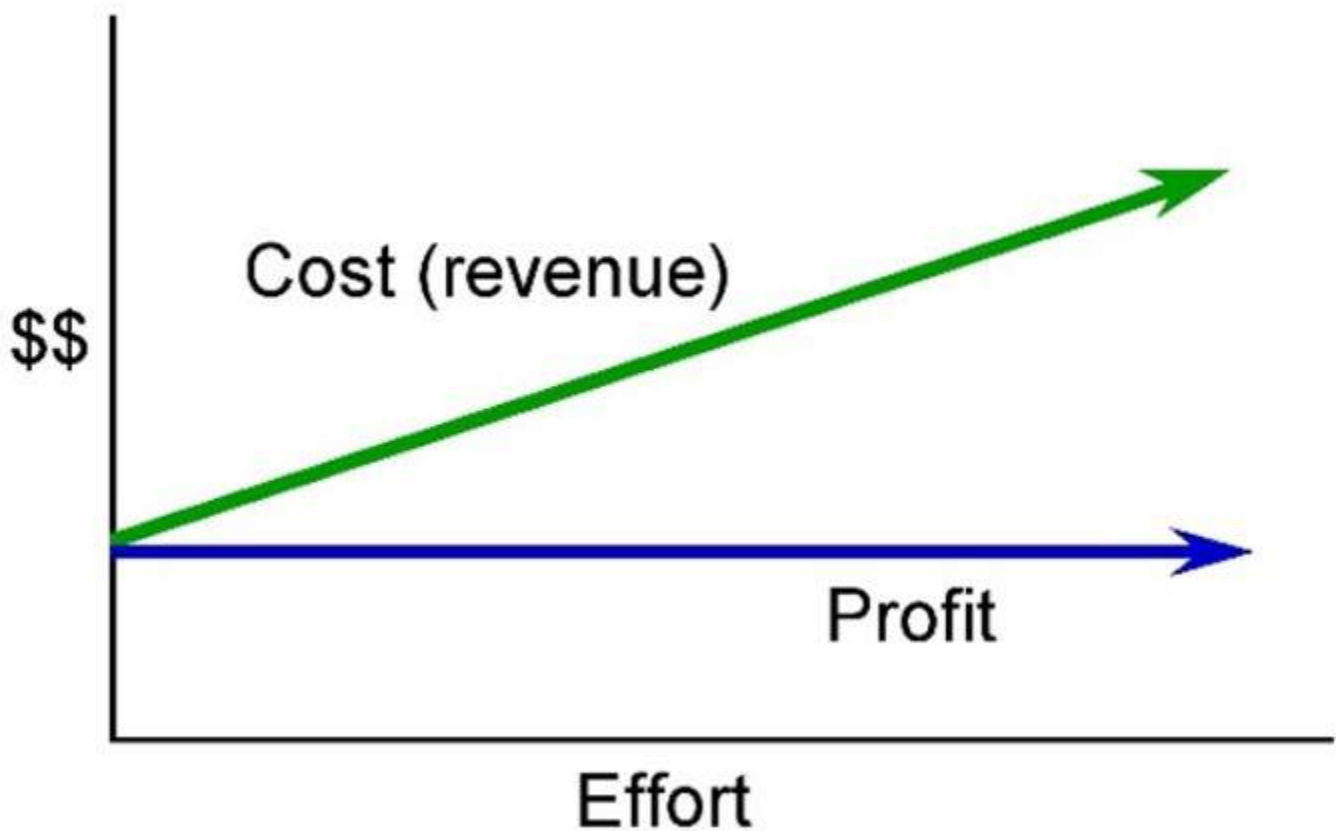

Figure 9.3: A cost reimbursable or cost plus

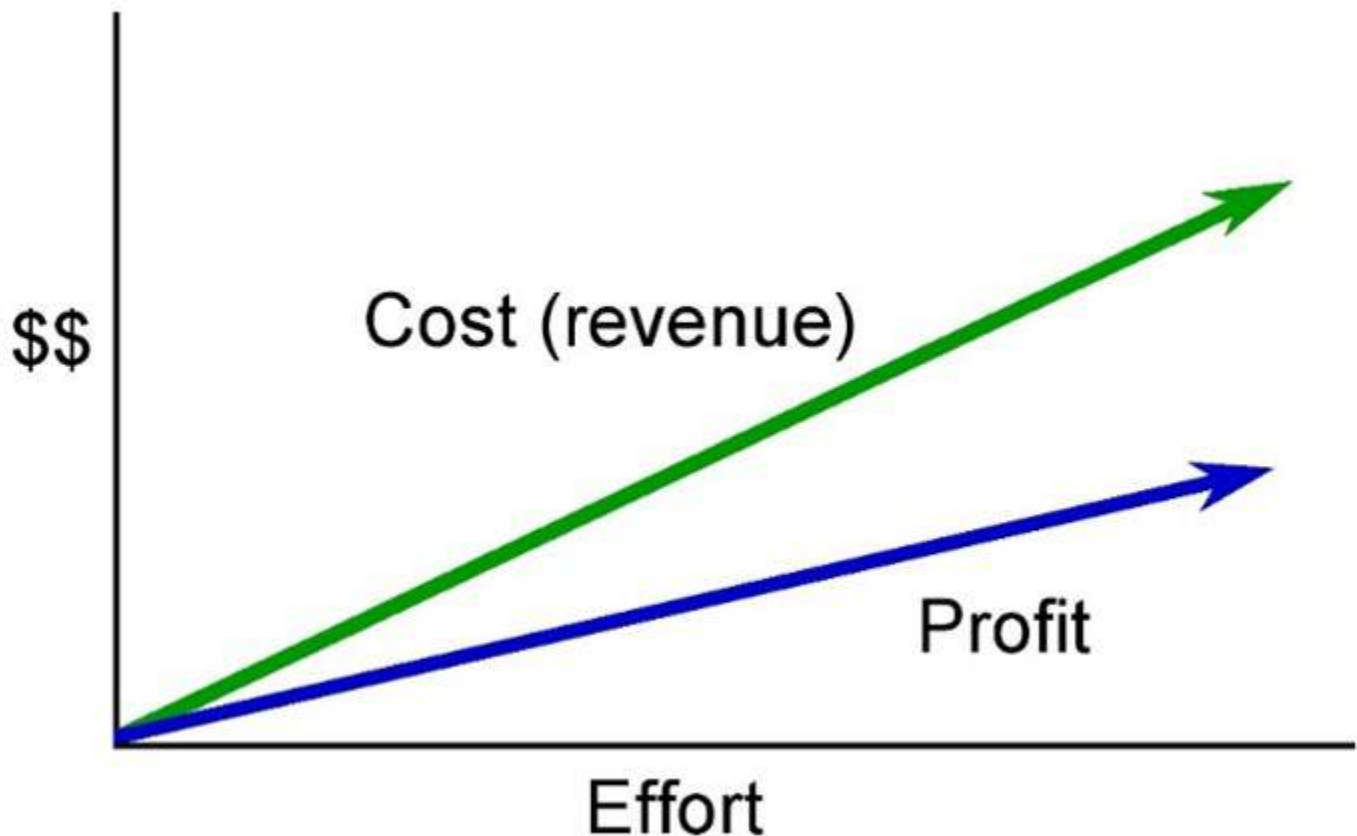

Figure 9.4: A time and materials contract

Contractual agreements with vendors often require partial payment of their costs during the project. Those contracts can be managed more conveniently if the unit of measure for partial completion is the same as that used for cost budgeting. For example, if a graphic designer is putting together several pieces of artwork for a textbook, their contract may call for partial payment after 25% of their total number of drawings is complete.

Project Management Institute. (2017). A guide to the Project Management Body of Knowledge (PMBOK guide) (6th ed.). Project Management Institute.

9.7 Microsoft Project Tutorial

For the MS Project tutorial, let's continue with our example of the project for developing a mobile application. Here, we are building upon the Chapter 8 tutorial. Therefore, we are working on "1. Scope" (Table 9.6). This table also includes the duration, start and finish dates, and predecessors.

Table 9.6: WBS for the Scope Activities of the M-Commerce Project

WBS	Task Name	Duration	Start	Finish	Predecessors
1	Scope	35 Days	Mon 5/2/22	Mon 6/20/22	
1.1	Clarify project purpose and determine project scope	5 days	Mon 5/2/22	Fri 5/6/22	2
1.2	Secure project sponsorship	1 day	Mon 5/9/22	Mon 5/9/22	3
1.3	Preparation of project charter	22 days	Tue 5/10/22	Wed 6/8/22	
1.3.1	Develop high-level scope	4 days	Tue 5/10/22	Fri 5/13/22	3
1.3.2	Identify overall project risks	5 days	Mon 5/16/22	Fri 5/20/22	5
1.3.3	Develop high-level schedule	6 days	Mon 5/16/22	Mon 5/23/22	5
1.3.4	Identify main resources and develop a high-level budget	2 days	Tue 5/24/22	Wed 5/25/22	7
1.3.5	Identify key stakeholders and project team member roles	8 days	Mon 5/23/22	Wed 6/1/22	5,6
1.3.6	Develop project approval requirements and project exit criteria	5 days	Thu 6/2/22	Wed 6/8/22	5,6,7,8,9
1.4	Approval of project charter by the sponsor	2 days	Thu 6/9/22	Fri 6/10/22	10
1.5	Secure core resources	5 days	Mon 6/13/22	Fri 6/17/22	11
1.6	Initiation stage complete	0 days	Mon 6/20/22	Mon 6/20/22	12

We identified the resources in Chapter 8. Now, in the Resource Sheet, we can type the standard rates of resources (Figure 8.8).

Resource Name	Type	Material	Initials	Group	Max.	Std. Rate	Ovt. Rate	Cost/Use	Accrued	Base Calendar
Project Manager	Cost		PM						Prorated	
Systems Analyst 1	Work		SA1		100%	\$30.00/hr	\$0.00/hr	\$0.00	Prorated	Standard
Systems Analyst 2	Work		SA2		100%	\$30.00/hr	\$0.00/hr	\$0.00	Prorated	Standard
UI/UX Designer 1	Work		DES1		100%	\$0.00/hr	\$0.00/hr	\$0.00	Prorated	Standard
UI/UX Designer 2	Work		DES2		100%	\$0.00/hr	\$0.00/hr	\$0.00	Prorated	Standard
Developer 1	Work		DEV1		100%	\$0.00/hr	\$0.00/hr	\$0.00	Prorated	Standard
Developer 2	Work		DEV2		100%	\$0.00/hr	\$0.00/hr	\$0.00	Prorated	Standard
Tester 1	Work		TEST1		100%	\$0.00/hr	\$0.00/hr	\$0.00	Prorated	Standard
Tester 2	Work		TEST2		100%	\$0.00/hr	\$0.00/hr	\$0.00	Prorated	Standard
Sales & Marketing Expert 1	Work		SALES1		100%	\$20.00/hr	\$0.00/hr	\$0.00	Prorated	Standard
Sales & Marketing Expert 2	Work		SALES2		100%	\$20.00/hr	\$0.00/hr	\$0.00	Prorated	Standard
Systems Analyst 3	Work		SA3		100%	\$0.00/hr	\$0.00/hr	\$0.00	Prorated	Standard
Contingency Reserve	Cost		C						Prorated	

Figure 9.5: Resource Sheet

In the Resource Sheet, there are three types of resources:

1. Work: Work resources are people and equipment. They have a standard rate per hour.
2. Material: Material resources are consumable supplies. They have a unit of measurement such as tones, boxes, and cubic yards.
3. Cost: Cost resources are independent costs we want to associate with a task such as a plane ticket.

In Table 9.5 (Section 9.4), we determined contingency reserves for three activities. As seen in Figure 9.5 above, contingency reserves were indicated as a “Cost” type which is independent of hourly work.

For activity 1.1, let’s double-click on the activity row. The “Task Information” window will pop up. Then, let’s click the “Resources” tab. For the work type resources (i.e., Sales and Marketing Experts and Systems Analysts), the cost is calculated automatically based on the hours worked. For the cost type, we must type the cost on this window. For activity 1.1, the contingency reserve is \$300 (Figure 9.6).

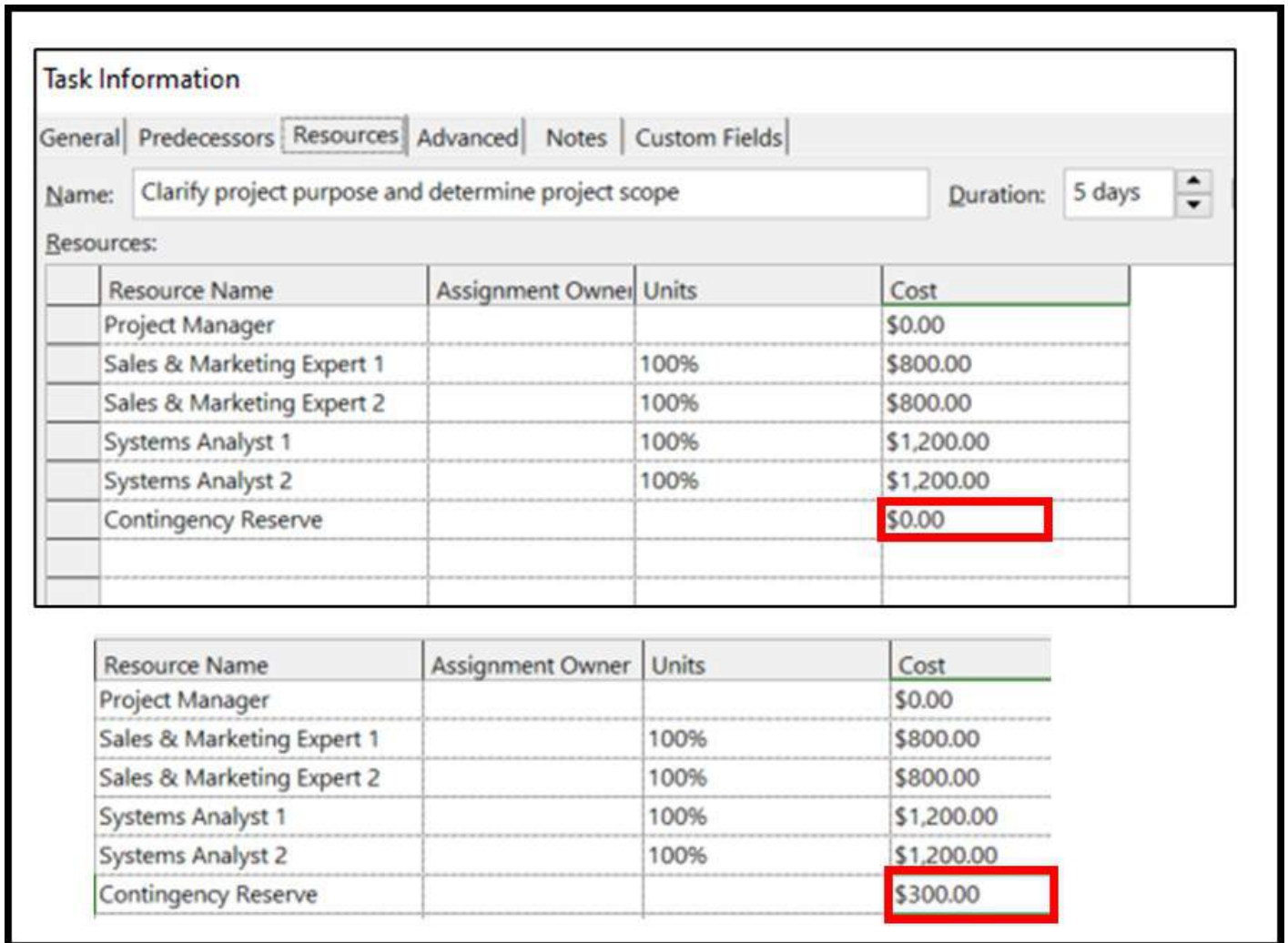

Figure 9.6: Resources tab on the Task Information window

When we finish typing the contingency reserves for the other two activities, the Gantt Chart will be as in Figure 9.7.



Figure 9.7: Gantt Chart with the resources indicated on the right of the bars

In this tutorial, we ignore the project manager’s salary. As seen in Figure 9.8, we can insert a new column “Cost” to the left of Resource Names, and therefore, we can directly see the cost per activity on

the main window (Gantt Chart view).

WBS	Task Name	Duration	Start	Finish	Predecessors	Resource Names	Cost
0	Mobile App Development Project	129 days	Mon 5/2/22	Thu 10/27/22			\$12,920.00
1	Scope	30 days	Mon 5/2/22	Mon 6/13/22			\$12,920.00
1.1	Clarify project purpose and determine project scope	5 days	Mon 5/2/22	Fri 5/6/22		Project Manager,Sales & Marketin	\$4,300.00
1.2	Secure project sponsorship	1 day	Mon 5/9/22	Mon 5/9/22	2	Project Manager	\$0.00
1.3	Preparation of project charter	19 days	Tue 5/10/22	Fri 6/3/22			\$8,620.00
1.3.1	Develop high-level scope	4 days	Tue 5/10/22	Fri 5/13/22	3	Systems Analyst 1	\$960.00
1.3.2	Identify overall project risks	5 days	Mon 5/16/22	Fri 5/20/22	5	Systems Analyst 2	\$1,200.00
1.3.3	Develop high-level schedule	6 days	Mon 5/16/22	Mon 5/23/22	5	Systems Analyst 1	\$1,440.00
1.3.4	Identify main resources and develop high-level budget	3 days	Tue 5/24/22	Thu 5/26/22	7	Systems Analyst 1, Systems Analyst 2,Contingency	\$1,360.00
1.3.5	Identify key stakeholders and project team member roles	3 days	Fri 5/27/22	Tue 5/31/22	6,7,8	Sales & Marketing Expert 1, Sales & Marketing Expert 2,System	\$2,460.00
1.3.6	Develop project approval requirements and project exit criteria	3 days	Wed 6/1/22	Fri 6/3/22	5,6,7,8,9	Systems Analyst 1, Systems Analyst 2	\$1,200.00
1.4	Approval of project charter by the sponsor	2 days	Mon 6/6/22	Tue 6/7/22	10	Project Manager	\$0.00
1.5	Secure core resources	3 days	Wed 6/8/22	Fri 6/10/22	11	Project Manager	\$0.00

Figure 9.8: Adding a cost column to the right of Resource Names

9.8 Key Takeaways

Key Takeaways

- Allocation of resources provides the project manager to determine the overall project budget most of which is spent on resources.
- Three types of project costs are direct costs, direct overhead costs, and general administrative costs.
- The project cost management plan is one of the sub-plans of our overall project plan, and it provides guidelines to project managers on how to estimate, budget, manage, monitor, and control project costs.
- The techniques to estimate costs are expert judgment, analogous estimating, parametric estimating, three-point estimating, and bottom-up estimating. Generally, project managers utilize some of the techniques together to estimate the activity costs.
- The process of subtotaling costs by category or activity is called cost aggregation. This process leads to the establishment of a cost baseline which is a time-phased budget that can be used to measure and monitor cost performance after it has been approved by the key project stakeholders.
- Funds allocated to deal with known-unknowns are called contingency reserves. The monetary amount of contingency reserves is determined after the risks and the strategies to mitigate risks' impact are identified and detailed.
- Projects seldom go according to plan in every detail. Baseline budgets often change after they have been approved.
- A project procurement management plan documents project procurement decisions, specify the approach, and identify potential sellers.
- Project teams should figure out whether to build a solution for the organization's or client's needs or buy one that is already available in the market.
- The most common contract types are fixed-price, cost reimbursable or cost plus, and time and materials contracts.

9.9 Questions and Exercises

There are 7 questions for this chapter. As you submit each answer, you will get immediate feedback and be taken to the next question.

An interactive or media element has been excluded from this version of the text. You can view it online here:

<https://pressbooks.ulib.csuohio.edu/project-management-navigating-the-complexity/?p=893>

9.10 Attribution

This chapter is a derivative of the following texts:

1. [Project Management by Adrienne Watt](#). © [CC BY \(Attribution\)](#).
2. [Project Management from Simple to Complex](#). © [CC BY \(Attribution\)](#).
3. [Project Management by Florence Daddey](#). © [CC BY \(Attribution\)](#).
4. [Project Management Fundamentals by Shelly Morris](#). © [CC BY \(Attribution\)](#).
5. [Project Management by Merrie Barron and Andrew R. Barron](#). © [CC BY \(Attribution\)](#).
6. [Principles of Management](#) © [CC BY \(Attribution\)](#).

Chapter 10. Project Risks

10.0 Learning Objectives and Overview

Learning Objectives

1. Define project risks and differentiate between risk types.
2. Identify risks that may occur during the implementation of a project.
3. Describe the process to create a project risk management plan.
4. Conduct a qualitative risk analysis.
5. Develop and implement risk responses based on identification and analysis of risks.

Overview

Although project managers can prepare a well-thought-out and comprehensive project scope, schedule and cost management plans, they cannot ensure that all these plans are free of problems that may occur due to numerous reasons during the project. Even the most carefully planned projects can run into trouble. No matter how well we plan, our project can always encounter unexpected problems. Team members get sick or quit, resources that we depend on turn out to be unavailable, even the weather can throw us for a loop (e.g., a snowstorm). So, does that mean that we are helpless against unknown problems? No! We can use risk planning to identify potential problems that could cause trouble for the project, analyze how likely they are to occur, take action to prevent the risks we can avoid, and minimize the ones that we can't. In this chapter, we will discuss both negative risks (i.e., threats) and positive risks (i.e., opportunities). A project manager must always keep in mind that risks mean uncertainties, not solely problems or threats all the time, since they are sometimes opportunities that we should consider exploiting. There are no risk-free projects because there is an infinite number of events that can have a negative or positive effect on projects. Project managers must be prepared to deal with uncertainties. Planning for events that can delay a project, decrease its quality, or increase its budget is a necessary part of project planning.

10.1 Project Risk

Risks are an aspect of uncertainty . Therefore, an uncertainty is not equal to a risk. Risks can be measured while uncertainties cannot be. That is, potential outcomes of a risk can be described whereas it wouldn't be possible to determine the outcomes for uncertainties. Risks can be controlled if response strategies can be defined and monitored during the project. Project team can respond to a risk if the risk triggers are identified and there is an owner of the risk who monitors the risk among other factors. Thus, when the project teams discuss all possible uncertainties in the initiation and planning stages, they determine the occurrence probability and the impact scale. For example, in our m-commerce project, testers may not determine some of the important code errors, which might lead to rework, schedule slippage and cost overruns. Considering the previous projects and lessons learned, we can predict the probability and how it may affect the project if the risk occurs. However, we can never be sure that this tester has malicious intentions to help a strong competitor. This would be an uncertainty, not a risk.

Project risk is an uncertain event or condition that, if occurs, has a positive or negative effect on one or more project objectives . Risks exist in all projects. It is of high importance to keep in mind that a risk does not always create negative outcomes, but can lead to positive outcomes. The subsections 10.1.1 and 10.1.2 below elaborate on both types of risk with examples.

10.1.1 Negative Project Risks

It is the reality that project teams mostly encounter negative risks. These risks might jeopardize the well-being of a project's progress and lead to failure if they occur. Some examples of a negative project risk are:

- Machines can fail in the middle of a critical activity.
- A vendor may not dispatch raw materials on time, or they may be damaged during a long journey from the vendor's or supplier's country to our project's location.
- A key human resource for an activity may become sick or may find a better job and leave the organization.
- Projects that depend on good weather, such as road construction projects, face risk of delays due to exceptionally wet or windy weather.
- Safety risks are also common on construction projects.
- Changes in the value of local currency during a project affect purchasing power and budgets on projects with large international components.

A short example for negative risks:

A construction company is building a 20-storey building in a Northeastern state, and they are expected to finish it by February. However, the project team is aware of the fact that winter is not a preferred season to carry out construction works, and the adverse weather conditions may disrupt activities leading to schedule delays and cost overruns. This is why the project team should evaluate all the possible risks that may result from inclement weather such as snowstorms. Project team can obtain the long-term historical data and seasonal forecasts from the National Weather Service, and can monitor the daily and weekly weather forecast.

A short example for negative risks:

A construction company is building a 20-storey building in a Northeastern state, and they are expected to finish it by February. However, the project team is aware of the fact that winter is not a preferred season to carry out construction works, and the adverse weather conditions may disrupt activities leading to schedule delays and cost overruns. This is why the project team should evaluate all the possible risks that may result from inclement weather such as snowstorms. Project team can obtain the long-term historical data and seasonal forecasts from the National Weather Service, and can monitor the daily and weekly weather forecast.

10.1.2 Positive Project Risks

Some uncertainties that we are not 100% sure that they may be materialized can make it easier to achieve a project's objectives. When this type of uncertain happens, the risk is positive and is therefore referred to as an opportunity. Some examples for positive risks can be described below:

- The potential of finding an easier way to do a task
- Acquiring some materials in exchange for lower prices than estimated
- A potential change in organizational process that can accelerate the procurement of some materials
- A new technology that has been developed and can be introduced to the market while we carry out the project
- A grant our organization had applied, which can provide more funds to our project if accepted

As for the five positive risks above, a project manager's response strategy would be exploit or enhance (among five alternative strategies in total - see 10.5.2) when they occur.

A short example for positive risks:

Company XYZ is thinking of developing a new electric toothbrush which customers are asking for according to the consumer surveys across the USA. Project team prepared all the plans, and estimated that this project will take nine months to finish. At the end of the project, the new

toothbrush can be introduced to the market. During the development and testing of various toothbrush types, project team will use a 3D printer to create prototypes. While working on the risk management plan, team has been aware of ongoing research on a new 3D printer that is faster and can print more durable items with more details. Based on the analysis, team found that this new printer can expedite the project. If this positive risk occurs during the project, it can expedite the project by one month resulting in a 8-month project duration. So, project team decided to allocate a contingency reserve for this opportunity. If the 3D printing company can make this new printer available to the market around the fifth month of the project at the latest, project team can purchase it. The estimated cost for this new printer was determined as \$25,000. Therefore, this money will be placed as a contingency reserve.

10.1.3 Known-Unknowns and Unknown-Unknowns

As discussed in Chapter 9 for contingency and management reserves, risks can be categorized as known-unknowns or unknown-unknowns. As regards known-unknowns, we can identify these risks in the planning stage, and estimate costs, and additional schedule and resources needed, if they occur. The costs allocated to compensate for managing these risks are named “contingency reserve”. However, it is not always possible for project teams to predict all the risks. Therefore, a management reserve is assigned besides the cost baseline (in which contingency reserves are accounted for). One obvious risk that emerged at the end of 2019 and has had a severe impact on all countries since March 2020 is the COVID-19 pandemic. This pandemic was an unknown-unknown for all the projects across the world. Some projects were able to overcome the issues by using their management reserves besides contingency reserves. However, numerous projects failed although they had contingency and management reserves since the impact of this pandemic exceeded the projects alone.

10.1.4 Individual and Overall Project Risks

Besides the categorization of risks as negative and positive, and as known-unknowns and unknown-unknowns, another categorization would be individual and overall project risks. Individual risks can affect the achievement of project objectives, and disrupt some activities, decisions, components, or deliverables. They can affect only one or some of the activities, but not always the whole project. If a risk has an impact on the project as a whole, this risk is considered an overall project risk. Let’s consider the case study of “Grocery LLC’s M-Commerce Project” (see 4.4.3 for the WBS). One project objective can be formulated as “to complete the elicitation of mobile app requirements as well as budget, schedule and resource estimates on which all the key stakeholders agree”. The activity 2.3 “Review specifications with team and stakeholders” is essential to identify the requirements that address all stakeholders’ expectations and concerns. However, some of the stakeholders may not agree on some of the requirements (see 5.2.2 for all the stakeholders in this project). Priorities of the top management, project sponsor, and product owner might not always overlap with one another. When the project team and team members review risks, they need to consider all possible risks that may affect the activity 2.3 and the overall project. If the conflict among stakeholders affects this objective, and therefore the activity 2.3, this would be counted as an individual project risk. Project team should create a contingency budget and schedule for this activity. If there is a risk of obtaining fund to conduct

project activities, this would have an impact on the whole project, and will affect the overall project objective that aims at creating a mobile app. Project team must also develop risk response strategies to tackle with this risk. Besides, project team can determine an acceptable range of negative and positive variations for overall risks.

Project Management Institute. (2021) PMBOK® Guide (7th ed). Project Management Institute.

Project Management Institute. (2017). A guide to the Project Management Body of Knowledge (PMBOK guide) (6th ed.). Project Management Institute

10.2 Risk Management Plan

The risk management plan is a component of the project management plan that describes how risk management activities will be structured and performed. This plan tells us how we are going to handle individual and overall risks in our project. It documents how we will identify and analyze risks, who will be responsible for doing it, and how often we will review the risks (since we have to meet about risk planning with the project team throughout the project.)

This plan allows the project team to reduce the likelihood of negative surprises (problems, weaknesses, and threats), proactively take advantage of positive risks (opportunities), and ensure risk management is considered when schedules, budgets, and other management plans are developed. Creating and maintaining a risk management plan significantly increases the likelihood of project success. The risk management plan identifies the processes and procedures to be used in managing risk throughout the life of the project. It includes a number of key sections such as risk sources, categories, assessment definitions (e.g., very high to very low), probability/impact assessment (matrix), roles and responsibilities, budget and schedule estimates for risk-related activities, and the risk register. Like the other knowledge area (e.g., scope, schedule, stakeholder) management plans, the risk management plan is integrated into the project management plan, and must be aligned with all the subplans and the project management plan.

The risk management plan can consist of some or all of the following items:

- **Methodology**

- What kind of approaches, tools, and data sources will be utilized to perform risk management activities (e.g., risk identification, risk assessment, risk response strategies)?
- g., checklists, risk indicator scales, probability-impact matrices, informal direct risk assessment, probabilistic modeling.

- **Risk strategy**

- **Roles and responsibilities**

- The guidelines how identified risks will be assigned to team members, and how these risk owners will take care of risks, and monitor them.

- **Risk categories**

- Risks can be grouped into high-level categories to facilitate the identification of individual risks. Some of the categories can be technical, cost, schedule, client, contractual, weather, financial, political, environmental, and people.
- Similar to a WBS (Work Breakdown Structure), RBS (Risk Breakdown Structure) would be a very helpful tool (Table 10.1).

- **Risk probability and impact**
 - Level and percentage of probabilities and impact of negative and positive risks
 - Which project aspects will be included in the impact analysis (e.g., scope, quality, schedule, cost, safety, environment)?
- **Risk register**
 - How will the risk register be structured?
 - Components such as risk ID, description, risk owner, probability, and impact (see 10.3)
- **Risk response plan**
 - How will risk response plan be structured?
 - Strategies for negative and positive risks, and individual and overall project risks.
- **Funding of reserves**
 - How will contingency and management reserves be determined and released?
- **Reporting formats**
 - Reporting formats and frequency should be in alignment with other project plans.

Table 10.1: An Example of a Risk Breakdown Structure (RBS)

Adapted from Project Management Institute's Learning website

Level 0	Level 1	Level 2	Level 3
Project Risk	Management	Corporate	History/experience/culture
			Organizational stability
			Financial
		Team Management	Poor team communication
			Changes in the core team
			Inadequate number of staff
		Customer & Stakeholder	Requirements
			Communication issues
			Contractual
	External	Environmental	Physical environment
			Facilities/site
			Local services
			Pollution risk
			Community protests
		Legal & Political	Political
			Legal/regulatory
			Interest groups
		Economic	Labor market
			Labor conditions
			Currency
			Inflation rate
	Technical	Requirements	Scope uncertainty
			Scope creep
			Complexity
			Issues with stakeholders
		Performance	Technical limits
			Quality
Rework			
Evaluation criteria			
Application		Organizational experience	
		HR skill sets and experience	
		Physical resources	

Project Management Institute. (2017). A guide to the Project Management Body of Knowledge (PMBOK guide) (6th ed.). Project Management Institute.

Retrieved from <https://www.pmi.org/learning/library/risk-breakdown-structure-understand-risks-1042>

10.3 Identifying Risks

A more disciplined process involves using checklists of potential risks and evaluating the likelihood that those events might happen on the project. Some companies and industries develop risk checklists based on experience from past projects. These checklists can be helpful to the project manager and project team in identifying both specific risks on the checklist and expanding the thinking of the team. The past experience of the project team, project experience within the company, and experts in the industry can be valuable resources for identifying potential risk on a project.

When risks are identified, they are recorded in a risk register. It is a key tool that helps project teams keep track of the status of risks, ensure response plans are effectively implemented, and new risks are managed. The register is an output of the process of identifying project risks. The project charter can involve some of the risks, generally the overall risks. After the WBS and activity list are created, and the schedule, resources and cost are estimated for all the activities, the project team can identify the risks more easily. Project team must review this register periodically by assigning each risk to a team member.

Risk register can be composed of the items below:

- Risk ID
- Description
- Related WBS activity or activities
- Risk owner (Name of the team member who monitors the risk)
- Risk trigger (How do we know the risk is becoming an issue or has reached a point that requires action?)
- Risk category (based on RBS categories)
- Probability (How likely does the risk occur?)
- Impact (How will the risk affect the project if it occurs? E.g., schedule delay, budget overrun, quality issues)
- Probability-Impact Score (Multiplying probability percentage by impact percentage)
- Risk response strategy (see 10.5)
- Description of the response (see 10.5)
- Response owner (if different from the risk owner)
- Expected impact of the response (What result do we expect from the response?)

Table 10.2 illustrates a short version of a sample risk register for Grocery LLC's M-Commerce Project. Only six columns have been included in this risk register.

Table 10.2: An Example of a Risk Register

ID	Risk Category	Related WBS Activity	Description	Risk Owner	Risk Trigger
1.0	Financial	Overall project	Cost estimates may be exceeded considering the factors of inflation and foreign exchange currency rates.	Systems Analyst 1	If the CPI (cost performance index) drops below 0.90, we will need to seek additional funding from management.
2.2	Management	2.1 2.2 2.3 2.4 2.5	The demand on the developers increased recently since the demand for online games and mobile apps have been on a sharp rise after the emergence of COVID-19 pandemic. We may experience a shortage of developers in the market.	Systems Analyst 2	Ten days before the "Analysis/App Requirements" component starts, we must assure that Developer 1 starts working in project activities.
2.5	Management & Technical	Overall project	Risk of building an app that our target users don't want.	Project Manager	Project manager should review each activity's tasks and performance with the core team and the project sponsor to detect any potential risks. Weekly risk review meetings

10.4 Risk Assessment

After the potential risks have been identified, the project team evaluates the risks based on the probability of occurrence and impact if they occur. This is a qualitative risk analysis method. In this textbook, we will not discuss quantitative risk analysis process. Readers can check “11.4 Perform Quantitative Risk Analysis” in PMBOK Guide Sixth Edition for an overview of quantitative risk analysis methods.

Not all risks are equal. Some risk events are more likely to happen than others, and the impact of a risk event can vary greatly. Therefore, project teams perform qualitative risk analysis in order to prioritize individual project risks by assessing their probability of occurrence and impact. This assessment technique is conducted by the project team. Team members indicate their opinions regarding each risk. Therefore, this kind of process introduces bias into the assessment. However, project manager assumes the role of a facilitator or a moderator to minimize the bias by implementing techniques such as Delphi. Besides, in order to minimize the bias and provide a consensus, the project manager should clarify the underlying mechanism of how each team member and expert justify their perceptions as regards the probability and impact.

For the qualitative risk analysis, let’s use a five-scale measure: Very low, low, medium, high, and very high (Table 10.3). It is always possible to have more and fewer number of scales. Each level may correspond with different percentage values depending on the project, project manager, and organizational policies. Table 10.2 displays two different percentages of probability. Organizations may have an overarching policy to implement levels, percentages, and risk categories. In this case, project manager must comply with this policy.

Table 10.3: Risk Probability Levels

Level Names	Level Values (%)	Alternative Level Values (%)
Very low	5%	10%
Low	10%	30%
Medium	30%	50%
High	50%	70%
Very High	70%	90%

The probability, alone, wouldn’t make sense if we disregard the impact of the risk. Just think that our project is in an area where a large earthquake hits every thirty years. Since the frequency doesn’t look high, we can give a very low probability level (5%). However, we should consider the impact of an earthquake if it occurs. Although the probability may be 5%, the impact of an earthquake to disrupt

project activities would be high. Even in our m-commerce project, an earthquake would have a number of negative effects such as power outages, water supply problems, transportation issues, supply chain problems, and in a worse scenario, destroyed buildings and infrastructure, and fatalities. This is also the case for an epidemic or pandemic. Therefore, we can decide on a very high impact value (0.9) while the probability is 0.05.

Table 10.4 displays the impact levels and values for the impact of risks on schedule. Project managers can use criteria for different areas such as schedule, cost, safety, environment and quality to determine the impact of level. For each area, description for each impact level should be described to eliminate ambiguities. According to Table 10.4, if an activity takes 10 days to finish, and we found that a risk may add an additional 1 day, it means that we have a delay by 10%. Therefore, the impact is low, and its value is 0.3.

Table 10.4: Description of Impact Levels Regarding Schedule

Impact	Description	Value
Very low	Delay by 5%	0.1
Low	Delay by 10%	0.3
Medium	Delay by 20%	0.5
High	Delay by 40%	0.7
Very High	Delay by 50%	0.9

When we use several areas besides schedule, we should formulate how to generate an overall impact level. We can use a non-weighted or a weighted model to combine all areas' values. Table 10.5 shows the impact levels regarding cost.

Table 10.5: Description of Impact Levels Regarding Cost

Impact	Description	Value
Very low	Budget overrun by 5%	0.1
Low	Budget overrun by 10%	0.3
Medium	Budget overrun by 20%	0.5
High	Budget overrun by 40%	0.7
Very High	Budget overrun by 50%	0.9

Table 10.6 displays the risk severity score which is found by multiplying probability by impact percentages. In Table 10.6, there are three severity levels: (1) Green indicates low-level severity, which is between 0% and 15%, inclusive, (2) Orange indicates medium-level severity, which is between 16% and 40%, inclusive, and (3) Red indicates high-level severity, which is at 41% and above.

Table 10.6: Probability - Impact (Severity) Score

			Probability				
			Very low	Low	Medium	High	Very High
			0.05	0.10	0.30	0.50	0.70
Impact	Very Low	0.10	0.01	0.01	0.03	0.05	0.07
	Low	0.30	0.02	0.03	0.09	0.15	0.21
	Medium	0.50	0.03	0.05	0.15	0.25	0.35
	High	0.70	0.04	0.07	0.21	0.35	0.49
	Very High	0.90	0.05	0.09	0.27	0.45	0.63

Not all project managers conduct a formal risk assessment on projects. There may be barriers to identifying risks. David Parker and Alison Mobey (Parker & Mobey, 2004) found in a phenomenological study of project managers that there was a low understanding of the tools and benefits of a structured analysis of project risks. The lack of formal risk management tools was seen as a barrier to implementing a risk management program. The level of investment in formal risk management was also associated with managerial psychological dimensions.

Some project managers are more proactive and will develop elaborate risk management programs for their projects. Other managers are reactive and are more confident in their ability to handle unexpected events without prior planning, while some managers are risk averse and prefer to be optimistic and not consider risks or to avoid taking risks whenever possible.

In projects with low complexity, the project manager may informally track items that may be considered risk items. On more complex projects, the project management team may develop a list of items perceived to be higher risk and track them during project reviews. On projects with greater complexity, the process for evaluating risk is more formal with a risk assessment meeting or series of meetings during the life of the project to assess risks at different phases of the project. On highly complex projects, an outside expert may be included in the risk assessment process, and the risk assessment plan may take a more prominent place in the project execution plan.

On complex projects, statistical models are sometimes used to evaluate risk because there are too many different possible combinations of risks to calculate them one at a time. These are considered as quantitative risk analysis. One example of the statistical model used on projects is the Monte Carlo simulation, which simulates a possible range of outcomes by trying many different combinations of risks based on their likelihood. The output from a Monte Carlo simulation provides the project team with the probability of an event occurring within a range and for combinations of events. For example, the typical output from a Monte Carlo simulation may reflect that there is a 10 percent chance that one of the three important pieces of equipment will be late and that the weather will also be unusually bad after the equipment arrives.

Project Management Institute. (2017). A guide to the Project Management Body of Knowledge (PMBOK guide) (6th ed.). Project Management Institute.

Parker, D., & Mobey, A. (2004). Action Research to Explore Perceptions of Risk in Project Management. *International Journal of Productivity and Performance Management* 53(1), 18-32.

10.5 Developing and Implementing Risk Responses

After the risks are identified, described, and assigned to a team member to keep track, and their probability and impact scores are produced, hence risks are prioritized, the project team can continue with planning the risk responses. Which strategy and the action does the team have in order to respond to the risk's negative or positive impact? These strategies depend on factors such as whether the risk is negative or positive, and its severity or significance. Project managers can utilize mathematical optimization models or real options analysis as a basis for a more robust economic analysis of alternative risk response strategies in projects with a greater complexity.

10.5.1 Strategies Developed for Negative Risks (Threats)

The project team responds to negative risks in various ways:

1. Escalation
2. Avoidance
3. Transfer
4. Mitigation
5. Acceptance

Each of these responses can be an effective tool in reducing individual risks as well as the overall risk profile of the project. The risk response plan captures the risk management approach for each identified risk event and actions the project management team will take to manage the risk.

Escalation is implemented when the threat is outside of the scope of the project, and it is beyond the project manager's control, that is the project manager isn't capable of developing and implementing a response to this threat. Therefore, project manager should escalate the risk to a higher authority such as project sponsor, project steering committee, or the client. If there is a resource conflict with another project in our organization, it would be a wise move to escalate this issue to the sponsor or top management so that it can be solved at the program or portfolio level, or at the organizational level. Risks or issues related to project objectives, resource and inter-group conflicts, ambiguous roles and responsibilities, scope disagreements, third party dependencies are some known situations calling for escalations. Such issues require higher level intervention because many times the authority, decision making, resources or effort required to resolve them are beyond a project manager's horizon. At times, the project manager may want to involve higher authorities for information-only escalations to keep them abreast of potential issues in the project. Escalation should be treated as a professional act and should be done in an effective way. Project managers should escalate timely if something is blocking the project and is beyond the project manager's control. One should not hesitate to escalate within the

performing organization and in the client's organization as well. A proactive escalation and risk communication is far better than unpleasant surprises requiring costly fixes to the project.

Risk avoidance usually involves developing an alternative strategy with a higher probability of success, but, usually, the associated cost of task completion also becomes higher. A common risk avoidance technique is using proven and existing technologies rather than adopting new techniques, even though the new techniques may show promise of better performance and/or lower costs. A project team may choose a vendor with a proven track record over a new vendor that is providing significant price incentives to avoid the risk of working with a new vendor. Alternatively, a project team that requires drug testing for team members is practicing risk avoidance by attempting to evade damage done by someone under the influence.

Risk mitigation is a response to a risk that cannot be avoided or if it is unwise to avoid it (due to risk avoidance strategies being too expensive, too time-consuming, etc.). In this case, the project team is attempting to reduce the likelihood and impact of a risk. For instance, assigning highly skilled resources to an activity or performing more tests to detect irregularities and problems reduces the likelihood and impact of errors occurring. In product development projects, teams can develop prototypes to mitigate the risks by obtaining early feedback on requirements by providing a model of the expected product before actually building it. These prototypes can be small-scale products, computer generated 2D and 3D models, mock-ups, or simulations.

Risk transfer is a risk reduction method that shifts the ownership of a threat from the project to another party. The purchase of insurance on certain items is a risk-transfer method. The risk is transferred from the project to the insurance company by paying a risk premium to another party that takes on the risk. A construction project in the Caribbean may purchase hurricane insurance that would cover the cost of a hurricane damaging the construction site. The purchase of insurance is usually connected to risks that can significantly impact the project while being out of the project team's control, such as weather, accidents, sharp fluctuations in currency, political unrest, and labor strikes. Using performance bonds, warranties and guarantee, and establishing agreements are also considered as responses to transfer the risks.

The fifth strategy, risk acceptance, involves doing nothing in response to the risk. The acceptance response is a good one when the likelihood and impact of a risk are low. In some cases, little else can be done about the risk, leading to acceptance being the only feasible option. When this response is chosen, an active strategy to deal with the risk would be to establish a contingency reserve that includes funds, time and/or resources to handle the threat.

10.5.2 Strategies Developed for Positive Risks (Opportunities)

As previously mentioned, positive risks (opportunities) are uncertainties that, if materialized, will have a positive impact on the project. The strategies to deal with positive risks can be listed as follows:

1. Escalation

2. Exploitation
3. Sharing
4. Enhancing
5. Acceptance

Escalation of positive risks has the same process as is for negative risks. When the client tells the project manager that they are considering adapting the product for a different market and asks if we are interested in bidding for the work, we can escalate this opportunity to the project sponsor. Another escalation strategy can be implemented when a team member identifies an opportunity to create a new value stream for the business. This opportunity is escalated for senior management attention.

Risk exploitation can be considered analogous to risk avoidance strategy in negative risks. Risk exploitation strategy attempts to eliminate the uncertainty and ensure the occurrence of the opportunity. An example of this could be pursuing a bonus that is available only if an activity is completed early. In this case, the project team will reallocate resources in order to ensure the activity finishes early and the bonus is obtained. Project managers can use new technologies or technology upgrades to reduce cost and duration by means of this strategy.

Risk-sharing can be considered analogous to risk transfer strategy in negative risks. It involves partnering with others to share responsibility for the risk. Partnering with another company via risk-sharing partnerships or joint ventures to share the risk is advantageous when the other company has the expertise and experience that the project team lacks. This increases the likelihood of the opportunity materializing and, if it does, both organizations share the gains.

Risk enhancement can be considered analogous to risk mitigation strategy in negative risks. This strategy attempts to increase the probability and/or impact of an opportunity. However, it does not seek to ensure its occurrence. Project teams need to focus on the causes of an opportunity to take the advantage of it. For one component of our project, we were aware of that an investor is interested in the deliverables of this component since their non-profit organization can benefit from them. We can communicate with this investor and their non-profit organization to learn more about their objectives.

The fifth strategy is the risk acceptance which is also used for negative risks. This risk strategy involves doing nothing in response to the positive risk (opportunity). This acceptance response is a good one when the likelihood and impact of a risk is low, or taking action is too costly or it needs a disproportionate amount of effort compared to the size of the work in the project and the benefit we can have. For example, for an activity, we want to have two highly-skilled engineers who work at another project. If we can convince them, we believe that we can have a better quality in our new product development, and we can finish this activity earlier. However, their project manager isn't willing to release them since they are key people in that project. Thus, we just accept this risk, and decide to do nothing.

10.5.3 Contingency Plan

The project risk plan balances the investment of the risk response implementations against the benefit for the project. The project team often develops an alternative method for accomplishing a project goal when a risk event has been identified that may frustrate the accomplishment of that goal. These plans are called contingency plans. The risk of a truck drivers' strike may be mitigated with a contingency plan that uses a train to transport the needed equipment for the project. If a critical piece of equipment is late, the impact on the schedule can be mitigated by making changes to the schedule to accommodate a late equipment delivery.

Contingency funds are funds set aside by the project team to address unforeseen events that cause the project costs to increase. Projects with a high-risk profile will typically have a large contingency budget. Although the amount of contingency allocated in the project budget is a function of the risks identified in the risk analysis process, contingency is typically managed as one line item in the project budget.

Some project managers allocate the contingency budget to the items in the budget that have high risk rather than developing one line item in the budget for contingencies. This approach allows the project team to track the use of contingency against the risk plan. This approach also allocates the responsibility to manage the risk budget to the managers responsible for those line items. The availability of contingency funds in the line item budget may also increase the use of contingency funds to solve problems rather than finding alternative, less costly solutions. Most project managers, especially on more complex projects, manage contingency funds at the project level, with approval of the project manager required before contingency funds can be used.

Project Management Institute. (2017). A guide to the Project Management Body of Knowledge (PMBOK guide) (6th ed.). Project Management Institute.

Retrieved from

<https://project-management.com/a-guide-to-escalation-in-project-management/#:~:text=Project%20managers%20should%20escalate%20timely,the%20client's%20organization%20as%20well.>

Project Management Institute. (2017). A guide to the Project Management Body of Knowledge (PMBOK guide) (6th ed.). Project Management Institute.

Retrieved from

https://www.projectmanagement.com/contentPages/article.cfm?ID=350338&thisPageURL=/articles/350338/Risk-Escalation#_=_

Retrieved from

https://www.projectmanagement.com/contentPages/article.cfm?ID=350338&thisPageURL=/articles/350338/Risk-Escalation#_=_

10.6 Key Takeaways

Key Takeaways

- Project risk is an uncertain event or condition that, if occurs, has a positive or negative effect on one or more project objectives.
- Contingency reserve is allocated for known-unknowns whereas management reserve is allocated for unknown-unknowns.
- The risk management plan is a component of the project management plan that describes how risk management activities will be structured and performed.
- When risks are identified, they are recorded in a risk register. It is a key tool that helps project teams keep track of the status of risks, ensure response plans are effectively implemented, and new risks are managed.
- Project teams perform qualitative risk analysis in order to prioritize individual project risks by assessing their probability of occurrence and impact.
- The strategies to respond negative risks are escalation, avoidance, transfer, mitigation, and acceptance.
- The strategies to respond positive risks are escalation, exploitation, sharing, enhancing, and acceptance.
- The project team develops contingency plans as an alternative method for accomplishing a project goal when a risk event has been identified.

10.7 Questions and Exercises

There are 11 questions for this chapter. As you submit each answer, you will get immediate feedback and be taken to the next question.

An interactive or media element has been excluded from this version of the text. You can view it online here:

<https://pressbooks.ulib.csuohio.edu/project-management-navigating-the-complexity/?p=1232>

10.8 Attribution

This chapter is a derivative of the following texts:

1. [Project Management by Adrienne Watt](#). © [CC BY \(Attribution\)](#).
2. [Project Management from Simple to Complex](#). © [CC BY \(Attribution\)](#).
3. [Project Management by Florence Daddey](#). © [CC BY \(Attribution\)](#).
4. [Project Management Fundamentals by Shelly Morris](#). © [CC BY \(Attribution\)](#).
5. [Project Management by Merrie Barron and Andrew R. Barron](#). © [CC BY \(Attribution\)](#).
6. [Principles of Management](#) © [CC BY \(Attribution\)](#).

Chapter 11. Monitoring and Controlling

11.0 Learning Objectives and Overview

Learning Objectives

1. Explain the monitoring and controlling process and differentiate between monitoring and controlling.
2. Describe qualitative monitoring for project management knowledge areas except for schedule and cost.
3. Describe Earned Value Management (EVM), a quantitative monitoring tool, to monitor and control of the progress of project activities.
4. Define the change control process.

Overview

The monitoring and controlling process differentiates from other processes (i.e., initiating, planning, executing, and closing out), in that, it spans throughout the whole project. Project managers should ensure that everything is on track (e.g., scheduled activities are completed on time, there is no budget overrun), and take the project back on track if it deviates from its three main baselines, which are triple (iron) constraints, scope, schedule and cost, and other constraints such as quality and resources, and the satisfaction of the client and stakeholder eventually. Project managers implement a holistic approach by focusing on all the aspects of a project to keep the project on track and accomplish a successful closeout where the client and stakeholders are satisfied with the project outcomes. There are various techniques utilized to monitor and control the projects, which have been discussed in sections 11.2 and 11.3 in this chapter.

11.1 Monitoring and Controlling Project Work

Before the project gets approval to continue, business (or systems) analysts, or a team of analysts and product owners combined with representatives of business units and other relevant stakeholders create a business case and benefits realization management plan. Project managers may also participate in this process if the organization has a PMO (see Chapters 2 and 3). At the very beginning of the project, that is the initiation phase, the project charter is prepared, and with the approval of the project sponsor and the client, project plans are built upon those documents and processes in order to elaborate on the main pillars of the project (i.e., scope, schedule, cost, quality, risks, resources, and stakeholders). While establishing a strong baseline is a key factor in project success, ineffective monitoring and controlling can spoil all the efforts that were done to establish this strong baseline. Let's remember the causes which lead to project failure to meet the project activities as discussed in Chapter 1 under "1.4 Project Success". According to the PMI 2020 Pulse of the Profession report, the factors responsible for the failure were listed as a lack of clearly defined and/or achievable milestones and objectives to measure progress (37%), poor communication (19%), lack of communication by senior management (18%), employee resistance (14%), and insufficient funding (9%). The monitoring and controlling process relies on clearly defined milestones and objectives to measure progress. One of the key responsibilities of a project manager is to monitor and control all the project work and ensure that everything is on track. This process consists of tracking, reviewing, and reporting the overall progress to meet the performance objectives defined in the project management plan.

It is important to note that it is much easier to monitor project success on small projects. Due to far fewer team members, stakeholders, and complexities to consider, the project's progress is more easily observed. However, on higher complexity projects that require many people, who are often spread out over different locations, project leaders are unable to use simple observation to assess progress. In these instances, it is important to have more robust tools and techniques (see sections 1.2 and 1.3 for qualitative and quantitative monitoring tools) that monitor the success of the full project team.

The project team evaluates its performance against the plans that have been developed. Every project requires a monitoring and control system. This system considers the following:

1. What information is needed and how should it be collected?
2. When (and with what frequency) should this information be collected?
3. Who should collect and analyze this information?
4. How should this information be represented from a reporting perspective?
5. Who should prepare the reports?
6. Who should receive the reports?

Monitoring and controlling project work allows stakeholders to understand the current state of the

project, recognize the actions taken to address any performance issues, and have visibility into the future project status with cost and schedule forecasts. It is important to note that it is much easier to monitor the progress and performance issues on small projects. Due to far fewer team members, stakeholders, and complexities to consider, the project's progress is more easily observed. However, in more complex projects that require many people, who are often spread out over different locations, project leaders are unable to use simple observation to assess progress. In these instances, it is important to have more robust tools and techniques that monitor the success of the full project team (see Sections 11.1.2, 11.2, and 11.3 below).

11.1.1 The Difference between Monitoring and Controlling

Although the process is traditionally named “monitoring and controlling”, we should know that there are differences between these two concepts. Controlling cannot be carried out by the project team if monitoring has not been done properly or at all. Thus, monitoring leads to controlling while controlling may require more monitoring if controlling determines that sufficient information couldn't be derived from the monitoring process.

Let's clarify the distinction between monitoring and controlling.

Monitoring

- Collecting project performance data
- Producing performance measures
- Reporting and disseminating performance information

Controlling:

- Comparing actual performance with planned performance
- Analyzing variances
- Assessing trends to affect process improvements
- Evaluating possible alternatives
- Recommending appropriate corrective action as needed

As seen above, we collect the data and analyze them to create performance measures. For example, our project dashboard can indicate our current status regarding the schedule and budget. We can also have a detailed Excel file exhibiting our day-to-day activities and actual costs. If this data is produced properly, we can continue with the controlling first by comparing the actual performance with planned performance, that is the project baseline. After we evaluate the variances and trends, we can evaluate possible alternatives to recommend corrective actions.

Monitoring and controlling process involves regularly measuring progress on a project to ensure it continues meeting objectives and addressing current organizational needs. It involves determining what corrective action is required, when it must occur, and who must do it. Monitoring begins at the very beginning of the project (initiation) and increases in density in the planning phase because it is easy to

get off track with planning efforts (Figure 11.1). Besides, the execution of project activities would need a considerable amount of attention from the project manager and team to monitor and control activities and performance measures (Figure 11.1). When the traditional predictive/waterfall development methodology is used, the team monitors performance against the timeline, budget, scope, and quality objectives for the entire project. When an adaptive approach is used, progress within the iteration is assessed (see Chapter 12).

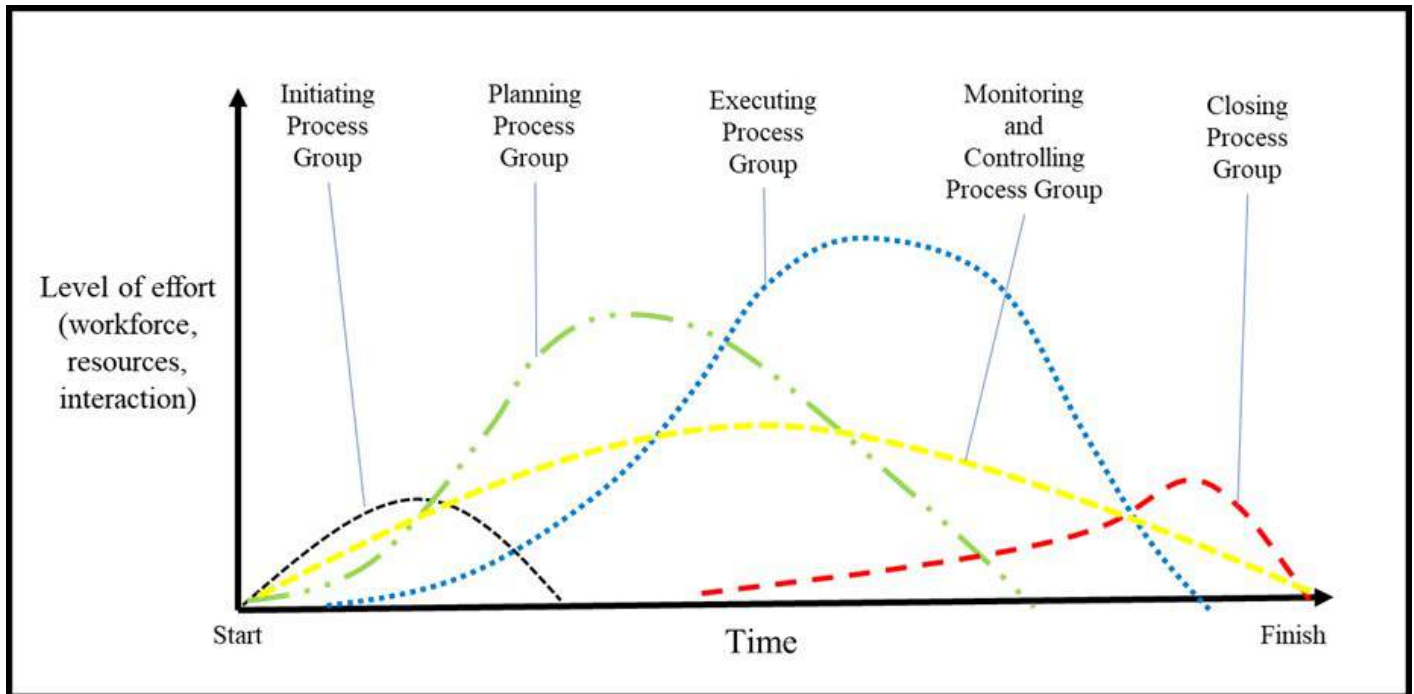

Figure 11.1: Project Management Process Groups
(Adapted from PMBOK Guide 6th Edition)

11.1.2 Tools Utilized to Conduct Effective Monitoring

Effective monitoring requires an effective system that allows the project team to collect performance data accurately and with minimum errors. The commonly collected information includes the status of the project budget and the project schedule. The work completed to date, what has yet to be completed, and the likelihood of completing the project on time and within budget are of particular interest. How this monitoring is performed quantitatively will be detailed below in 11.3 “Earned Value Management”. In addition, it is important to identify the risks and issues that require attention. Whenever possible, information technology should be used to collect and analyze the information and distribute the reports. Different organizations require different roles to collect and analyze the project information. In organizations with a project management office (PMO), PMOs may be accountable for progress reporting in an “end-to-end” way, meaning they would be involved from information collection all the way to report distribution. Organizational policies (from a formal perspective) and organizational culture (from an informal perspective) influence who and how progress monitoring is performed.

One of the common methods used to monitor progress is team meetings. Team meetings are highly collaborative and serve many purposes, including information sharing and team development. Depending on the nature of the project, these meetings may be focused exclusively on sharing the status of tasks underway. It is also possible for status discussions to lead to team planning. The individuals who participate in these meetings vary depending on many factors, such as development methodology in use, organizational culture, project complexity, and status of the overall project. The frequency of team meetings is pretty higher in agile (adaptive) projects than the traditional (predictive/waterfall) projects in order to ensure agility, flexibility, on-time interventions, and timely feedback from team members and the product owner. For example, agile teams, in particular Scrum teams, have daily standups to discuss what has been completed since the last standup meeting, what is planned to complete until the next meeting, and what the impediments, risks, and problems that members may encounter are (see Chapter 12, Section 12.2.2).

Project teams typically develop different reports for different stakeholders. Stakeholders who have a high interest and high power/influence will receive more information, more frequently (recall the stakeholder power/interest grid presented in Chapter 5). Depending on the priority and duration of the project, the reporting frequency could be daily, weekly, monthly, or quarterly.

We can mention three different types of project reports as follows:

1. Status reports - where the project stands at a specific point in time
2. Progress reports - what the project team has accomplished during a certain period
3. Forecast reports - future project status based on current project status and known trends

Tables 11.1, 11.2, and 11.3 exhibit short examples of status, progress and forecast reports, respectively, based on our example of the overall case discussed throughout the book (see Section 1.2.4 “Case Study 1.2: Characteristics of Another Project Undertaken by Grocery LLC (M-Commerce Project)”).

Table 11.1: An Example of an Overview based on a Status Report



Period	May 27, 2022 - July 7, 2022	
Team Name	Grocery LLC M-Commerce Project Team	
Status Report Prepared by:	Project Manager	
Overall Status:	 Green - On Track	 Yellow - Caution Red - Problem

Table 11.2: An Example of a Progress Report

Activities/Deliverables Completed Since Last Reporting Period

WBS #	Activity Name	Duration	Date Completed	Comments
2.1	Review needs analysis based on the business case	3 days	Tue 5/31/22	<i>The review has some issues due to the missing key points in the preceding activities. However, the team worked very well to compensate for the delay. No delay was experienced.</i>
2.2	Elicit requirements from stakeholders	10 days	Sun 6/10/22	<i>It finished two-day earlier than its planned 6/14 schedule.</i>
2.3	Draft preliminary stakeholder specifications	7 days	Tue 6/21/22	<i>An additional two days were added from 2.2.</i>
2.4	Review specifications with team and stakeholders	5 days	Tue 6/28/22	<i>Finished on time.</i>
2.5	Incorporate feedback on the specifications	3 days	Fri 7/1/22	<i>Finished on time.</i>
2.6	Develop a preliminary budget and delivery timeline	3 days	Wed 7/6/22	<i>The one-day delay was experienced due to the absence of a representative from the budget department.</i>
2.7	Obtain approvals to proceed (concept, timeline, budget, resources)	1 day	Wed 7/6/22	<i>The meeting with the sponsor took 3 hours. The sponsor was convinced that we could proceed with the activities under the third component "Design".</i>
2.8	Analysis complete	0 days	Thu 7/7/22	<i>Milestone achieved.</i>

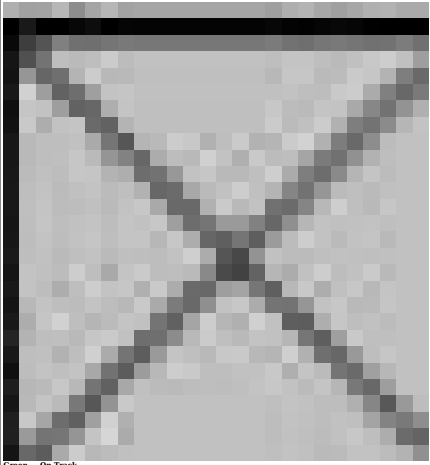
Table 11.3: An Example of a Forecast Report

Activities & Deliverables for the Next Reporting Period

WBS#	Activity Name	Duration	Date to be Completed	Comments
3.1	Review preliminary stakeholder specifications	3 days	Mon 7/11/22	<i>Stakeholder Z (high power, high interest) notified us of some serious conflicts in the preliminary stakeholder specifications. We may expect a 2-day delay. The sponsor should be informed immediately.</i>
3.2	Develop solution (functional and non-functional) specifications	5 days	Mon 7/18/22	<i>Developer 1 may not be available during this activity. Therefore, a developer must be kept as a substitute to ensure attendance.</i>
3.3	Develop transition requirements	2 days	Wed 7/20/22	<i>No delay is expected.</i>
3.4	Develop design mockups based on specifications	5 days	Wed 7/27/22	<i>Stakeholder Z may have some objections. Project member 2 will be assigned to communicate with this stakeholder.</i>
3.5	Review specifications	2 days	Fri 7/29/22	<i>The same issue with Stakeholder Z.</i>
3.6	Incorporate feedback into specifications	2 days	Tue 8/2/22	<i>The same issue with Stakeholder Z.</i>
3.7	Finalize project management plan	8 days	Fri 8/12/22	<i>Based on the stakeholders' feedback, we may experience delays.</i>
3.8	Design complete	0 days	Mon 8/15/22	<i>No comments.</i>

PMI (2020). Ahead of the Curve: Forging a Future-Focused Culture. Pulse of the Profession. Retrieved from <https://www.pmi.org/learning/library/forging-future-focused-culture-11908>

Project Management Institute. (2017). A guide to the Project Management Body of Knowledge (PMBOK guide) (6th ed.). Project Management Institute.

Project Management Institute. (2017). A guide to the Project Management Body of Knowledge (PMBOK guide) (6th ed.). Project Management Institute.

Project Management Institute. (2017). A guide to the Project Management Body of Knowledge (PMBOK guide) (6th ed.). Project Management Institute.

Project Management Institute. (2017). A guide to the Project Management Body of Knowledge (PMBOK guide) (6th ed.). Project Management Institute.

Interthink. (n.d.). Project HEADWAY Project Team Status Report. Retrieved from

<https://www.projectmanagement.com/deliverables/235123/project-headway-project-team-status-report>

Interthink. (n.d.). Project HEADWAY Project Team Status Report. Retrieved from

<https://www.projectmanagement.com/deliverables/235123/project-headway-project-team-status-report>

Interthink. (n.d.). Project HEADWAY Project Team Status Report. Retrieved from

<https://www.projectmanagement.com/deliverables/235123/project-headway-project-team-status-report>

11.2 Qualitative Monitoring

Qualitative monitoring, as its name implies, involves measuring quality rather than quantity. In the context of project management, qualitative monitoring addresses the following questions:

- **Scope:** Is the team delivering on the intended scope in order to fulfill the project's objectives and organizational needs?
- **Quality:** Is the quality of the deliverables meeting stakeholder expectations?
- **Stakeholders:** Are stakeholders engaged?
- **Communications:** Are project communications effective?
- **Risks:** Are risks and opportunities being effectively managed by the team?
- **Resources:** Are resources being effectively managed and available as expected?
- **Procurement:** Are the expectations outlined in procurement contracts being adhered to by vendors?
- **Team Management:** Has the team become high-performing and are individual team members meeting performance expectations?

11.2.1 Validating and Controlling Scope

The approach taken to monitor and control scope depends on the development methodology used. The predictive/waterfall approach involves a sequential definition of requirements and scope, which then leads to solution development. This approach is commonly utilized when the organization has a clear vision of the project's end outcome. Given this, monitoring and controlling scope occurs with the premise that significant scope changes are not expected. Validating scope involves formal acceptance of the completed project deliverables by the project sponsor and their assigned designates. Acceptance often requires deliverable reviews where the quality of the work is inspected before sign-off is provided. Changes may be required. These changes can be a result of poor quality (which leads to re-work) or new requirements intended to improve the organizational value of the project's outcomes. New requirements are carefully controlled. This is necessary because once solution development begins, the project's resources, timelines, and budget were all defined with a specific scope in mind. A scope change may mean those resources, timelines, and budgets are now insufficient to deliver on the increased scope. Controlling scope in this situation requires the project team to assess the impact of the new requirement on all the project's constraints. If necessary, the team will seek approval for additional funding, time, and/or resources to pursue the new requirement. Project leaders need to reserve judgment on scope changes until the impact and benefits are clearly understood. The term "scope creep" refers to the poorly controlled expansion of scope over time. This means that the scope expands, perhaps unintentionally, without an understanding of its impact on the project's other constraints, such as time and budget. Therefore, utilizing an integrated approach for change management is a critical

success factor for projects using the predictive/waterfall approach.

Projects that follow an adaptive development methodology, such as agile, view scope change very differently. Scope definition, as well as solution development and testing, occur in an iterative or incremental fashion. As new requirements are identified, they are evaluated from a cost/complexity and benefit perspective, and if worth pursuing, they will be scheduled into a future iteration. A continuous improvement mindset encourages scope definition to occur in cycles.

11.2.2 Controlling Quality

Quality is about ensuring the expectations of the project sponsor have been met. This involves ensuring the expectations of the end-user community are well understood. High quality is achieved by planning for it (proactive) rather than by reacting to problems after they are identified (reactive).

Standards are chosen and processes are established to achieve those standards in the planning phase. Project quality focuses on the end deliverables that reflect the purpose of the project. The project leader is responsible for developing a quality management plan that defines the quality expectations and for ensuring the specifications and expectations are met. In the execution phase, the project team attempts to prevent quality issues from occurring with the use of quality management techniques, such as checklists, assessments, and lean six-sigma tools. Lean six-sigma tools are focused on creating efficient and effective processes that involve error-proofing methods.

In the monitoring and control phase, the project team reviews the project deliverables to ensure they are ready for review and sign-off. Ideally, this review leads to deliverable acceptance. However, the team may encounter problems that they are unable to prevent. When this occurs, the team's objective is to determine how to fix these problems. One of the most effective ways to address a problem is to begin by understanding its root cause(s). Cause-and-effect diagrams, which are also referred to as fishbone or Ishikawa diagrams, are very effective for this purpose.

11.2.3 Monitoring Stakeholder Engagement

Project teams cannot control stakeholders. However, they can significantly influence their level of engagement. During the planning phase of a project, the stakeholder register is created (see Chapter 5) which is an effective tool for keeping track of a project's stakeholders, their relative interest in the project, and their level of power/influence over the project's outcomes. The register provides an effective starting place for determining how to engage stakeholders according to their power and interest levels if a Power/Interest Grid is used.

During the monitoring and control phase, the project team looks for new stakeholders and monitors the engagement level of existing stakeholders. Engagement techniques will vary from one organization to another as their respective cultural norms and values influence how individuals work together. Some organizations prefer face-to-face interaction while others prefer the use of electronic messaging and project team websites. Whatever the methods are used to engage stakeholders, it is important to keep

stakeholders informed of the project's progress and to find the right approaches for meaningfully involving stakeholders throughout the life of the project.

A project leader's interpersonal skills are critical in stakeholder management (See Chapters 5 and 6). Some stakeholders may have become unresponsive to the project team's requests. When this occurs, the project leader's relationship-building skills will be put to the test as they attempt to understand the stakeholder's actions. Conflict resolution skills, such as negotiating, are vital because stakeholders are very likely to have differing priorities, and successfully navigating these conflicts can be the difference between project success and project failure.

11.2.4 Monitoring Communications

Communication is one of the most effective ways to keep team members and all other stakeholders engaged. In order for this communication to be effective, it must be developed and delivered in ways that consider stakeholder roles and communication preferences. During the planning phase, a communication plan would be created to guide the project team's communication efforts throughout the project (See Chapter 6). It is important for project leaders to proactively determine if the selected communication methods will be suitable for the key stakeholders. This is done by directly asking them and monitoring their responsiveness to the communication delivered. Another important way to determine if project stakeholders are well-informed is to pay careful attention to the questions they ask. Questions about project progress that have been addressed in recent project communications are a good sign that the communication techniques may not be effective for a particular stakeholder. When this occurs, it is time to revisit the communication plan and make the appropriate adjustments.

11.2.5 Controlling Procurements

Monitoring procurement includes ensuring the vendors' performance meets the agreed-upon, often contractual, requirements. The complexity of the project determines the number and type of vendors procured. This, in turn, determines the nature of the monitored activities. For instance, projects that only require supplies to be purchased externally will have much simpler vendor management processes than projects that had to outsource the completion of some of the work to external consultants.

Key tools and techniques that may be used in procurement management include inspections, audits, formal change control methods, vendor-produced performance reports, payment systems, and contract administration.

11.2.6 Monitoring Risks

Monitoring and controlling risks involves implementing a risk management plan. A key aspect of this plan is often the risk register, which helps the team keep track of the project risks, triggers (early warning signs), and risk responses (See Chapter 10). Risk responses can be implemented in any phase of the project as long as documentation is kept up to date.

Many project teams establish contingency plans and contingency funds to account for all types of risks (e.g., negative and positive risks, individual and overall project risks). When these risks materialize, the project team determines if the contingency plans and/or funds will address these risks and, if so, they will be implemented. If contingency plans/funds don't suffice, the project team must identify workarounds. Contingency plans and workarounds are then monitored to determine if they were effective. Additional corrective action may be required.

11.2.7 Controlling Resources

Projects require human resources, physical resources, and services in order to produce the desired outcomes (See Chapter 8). During monitoring and controlling, the project leader assesses the effectiveness of all types of resources.

With respect to the project team, effective project managers continuously assess the performance of the team and its members. Effective coaching and mentoring skills are essential and can be the difference between project success and failure (See Chapter 6). In addition, a project leader must sometimes make the difficult decision to replace team members when they are not able to perform as expected or the ensuing conflicts cannot be resolved. Conflict management skills are important in this regard (See Chapter 6). Proactive conflict management requires the project leader to continuously monitor stress levels in the team in an attempt to anticipate the likelihood of rising conflict. Monitoring resource utilization levels in the project schedule and staying connected to project team members are also critical activities that the project leader must perform. Lastly, many projects require people with different skills at different times. Project leaders should be actively monitoring when these skills will be required and ensuring people join/transition off the project at the appropriate times.

The availability and effectiveness of physical resources are also closely monitored. In some instances, faulty or ineffective equipment has to be replaced. If the scope of the project changes, new equipment and technology may be required, which, in turn, may lead to additional work in procurement management.

Monitoring and controlling is about integrating all the teams while assuring that work is being completed at a steady rate to keep the project on track. This phase is vital to the overall success of the project. Thus, requiring additional, highly-skilled resources, is a key consideration during the planning phase.

11.3 Earned Value Management (EVM)

A project manager must regularly compare the amount of money spent with the budgeted amount and report this information to key stakeholders. In addition, project managers must also compare the progress of the actual work completed with the estimated durations in the project schedule. One of the quantitative monitoring techniques project managers utilize is Earned Value Management (EVM) which combines scope, schedule and cost baselines to determine the project's well-being and to decide whether an action is required in case of problems. EVM is essential to project success. It is used extensively in many business fields and organizations such as the Department of Defense (DOD) and construction industries while the IT industry has not due to the reasons such as practicing agile (adaptive) project management and hence lack of a fixed baseline.

EVM is a quantitative monitoring technique that uses metrics and indexes to assess project performance. Earned value analysis compares the performance measurement baseline to the actual schedule and cost performance. EVM integrates the scope baseline with the cost baseline and schedule baseline to form the performance measurement baseline [ii]. The application of earned value in the early initiation and planning phases of a project increases the validity and usefulness of the cost and schedule baseline and is an excellent verification of the project scope assumptions and the scope baseline. Once established, these baselines become the best source for understanding project performance during execution. A comparison of actual performance (both cost and schedule) against this baseline provides feedback on project status and data, not only for projecting probable outcomes but also for management to make timely and useful decisions using objective data. EVM, known as "management with the lights on", is based on the principle that past patterns and trends can indicate future conditions. EVM helps us clearly and objectively see where our project is headed compared to where it's supposed to be.

EVM can help answer the questions below:

- Are we delivering more or less work than planned?
- When is the project likely to be completed?
- Are we currently over or under budget?
- What is the remaining work likely to cost?
- What is the entire project likely to cost?
- How much will we be over or under budget at the end of the project?
- What is driving the significant cost and/or schedule variances?

In EVM, there is an important point that must be clarified. We will always see monetary amounts even though we are measuring the scope or schedule performance. The denominator for all of them is the currency we are using for our project. If we are using the US dollar, the denominator would be the US

dollar. The analogy for EVM would be doing shopping in a market. We buy different items such as olive oil, cookies, milk, eggs, and laundry detergent. All these items are converted to a monetary value, and it allows us to compare the prices between different brands. In the end, we know the total amount in dollars. This is exactly what is happening for EVM. Therefore, when we see a result showing dollars, it doesn't necessarily mean that it is related to the cost. It can indicate a problem in scope (e.g., not all planned activities have been completed) or schedule (e.g., the project is behind schedule).

11.3.1 Main EVM Parameters

To start with EVM, we should elaborate on three key dimensions. They are:

1. **Planned Value (PV)** is the amount of work that is estimated and planned to be done by a particular date in the project. This work is measured by the cost of planned work by a specific date. As explained above, EVM measures all the values with monetary units to create a common measurement scale. PV includes contingency reserve while excluding management reserve. Microsoft Project also uses the term BCWS (Budgeted Cost of Work Scheduled) besides PV. Total PV can be referred to as Performance Measurement Baseline (PMB) or Budget at Completion (BAC).

Let's consider our Grocery LLC's m-commerce project. Let's assume that we outsourced the development component to a software company. Therefore, this component would be a project for this company. They divided the development of the mobile app interface and the backend part into ten activities (e.g., user profile and settings, items to purchase with pictures, features and prices, payment, order tracking, databases, etc.). There are ten activities to finish the development of the mobile app (scope baseline). Then, we can continue with the testing of the mobile app. Each development activity was scheduled to be three days. In total, the mobile app will be ready to test in thirty days (schedule baseline). Let's also assume that we need to pay \$2,000 for each phase. Total cost baseline for all ten activities is \$20,000 ($\$2,000 \times 10$). For earned value analysis, we consider \$20,000 as our total planned value which is also named BAC (Budget at Completion).

2. **Earned Value (EV)** is the amount of work that has been completed by a particular date in the project. This work is measured by the cost of work performed and completed by a specific date. Microsoft Project also uses the term BCWP (Budgeted Cost of Work Performed) besides EV.

Let's assume that the company we outsourced the development component finished five activities at the end of the eighteenth day. The planned value by that day was 6 activities, which amounts to \$12,000 ($\$2,000 \times 6$). However, only five activities were completed, which is 50% of the planned work. This is our earned value which can be measured as \$10,000 ($\$2,000 \times 5$).

3. **Actual Cost (AC)** is the sum of the amounts which has been spent on the project so far. Microsoft Project also uses the term ACWP (Actual Cost of Work Performed) besides AC.

For the five activities completed, we paid \$11,200. This is the actual cost at the end of the eighteenth day (the status date).

11.3.2 Variance Analysis

After we calculate PV, EV, and AC, we can conduct variance analysis to figure out if we are on, over, or under budget, and if we are on, behind, or ahead of the schedule.

Cost Variance (CV) and Cost Performance Index (CPI)

The difference between EV and AC is the cost variance (CV).

$$CV = EV - AC$$

If the cost variance is negative, we can conclude that the project as of the status date is over budget. If the cost variance is positive, this indicates that the project is under budget. If CV is zero, it means that the project is on track in terms of the budget.

In our example, at the end of the eighteenth day, we could finish five activities. EV is \$10,000, and AC is \$11,200.

$$CV = 10,000 - 11,200 = -1,200$$

It means that our project stands over the budget.

Instead of CV, we can also use CPI (Cost Performance Index) which gives us a ratio instead of an absolute number. CPI uses the same variables as CV but expresses them as a ratio. CPI is calculated as follows:

$$CPI = EV / AC$$

$$CPI = 10,000 / 11,200 = 0.89$$

CPI is a measure of the cost efficiency of budget resources. When CPI is less than 1.0, it indicates a cost overrun. When CPI is greater than 1.0, it indicates a cost underrun for the work completed. If it is 1.0, it indicates that the project budget is on track.

Schedule Variance (SV) and Schedule Performance Index (SPI)

The difference between planned value and actual progress (earned value) is the schedule variance (SV).

$$SV = EV - PV$$

If less value has been earned than was planned, the schedule variance is negative, which means the project is behind schedule. If there is a positive variance, it indicates that the project is ahead of its planned schedule. If SV is zero, it means that the project schedule is on track.

In our example, at the end of the eighteenth day, we could finish five activities. EV is \$10,000, and PV is \$12,000.

$$SV = 10,000 - 12,000 = -2,000$$

It means that our project is behind its schedule. -\$2,000 does not indicate a number related to the cost. As mentioned above, the monetary unit is the common measure we are using for the schedule baseline and variance as well.

Instead of SV, we can also use SPI (Schedule Performance Index) which gives us a ratio instead of an absolute number. SPI uses the same variables as SV but expresses them as a ratio. SPI is calculated as follows:

$$SPI = EV / PV$$

$$SPI = 10,000 / 12,000 = 0.83$$

SPI is a measure of schedule efficiency. It measures how efficiently the project team is accomplishing the work. When SPI is less than 1.0, it indicates that the project is behind schedule while an SPI that is greater than 1.0 indicates that the project is ahead of schedule. If it is 1.0, it indicates that the project schedule is on track.

11.3.3 Trend Analysis

After PV, EV, and AC values are generated, and variance analysis is performed, we can conduct trend analysis to predict how our project may perform during the rest of the project, and when the project is completed.

Trend Analysis for Schedule

We can estimate the new project completion time. In our example, the project is behind schedule. Let's figure out if we may have a delay if the SPI remains the same. We had scheduled to finish the development component in 30 days. The current SPI is 0.83. If we cannot improve the SPI, we will end up with a delay.

$$\text{Adjusted schedule estimate} = \text{Original schedule estimate (schedule baseline)} / \text{SPI}$$

$$\text{Adjusted schedule estimate} = 30 \text{ days} / 0.83 = 36.14 \text{ days}$$

Therefore, we may have a delay of 6 days in this component.

Trend Analysis for Budget

We can estimate the new project budget. In our example, the project is over budget. Therefore, may we expect to spend more than what we estimated in our cost baseline (BAC - budget at completion which is the total PV)? If we assume that CPI won't change during the rest of the project, we can use the formula below:

EAC (Estimate at Completion) = BAC / CPI

$$\text{EAC} = \$20,000 / 0.89 = \$22,472$$

Therefore, we can estimate that we may find ourselves spending \$22,472 instead of \$20,000 which was our cost baseline. The difference between BAC and EAC gives us VAC (Variance at Completion).

VAC = BAC - EAC

$$\text{VAC} = \$20,000 - \$22,472 = -\$2,472$$

Thus, if we cannot improve the current CPI, we may spend an additional \$2,427 when the project is completed.

Another parameter that we can generate is ETC (Estimate to Complete).

ETC = EAC - AC

$$\text{ETC} = \$22,472 - \$11,200 = \$11,272$$

Thus, we expect to spend \$11,272 during the rest of the project.

The third parameter we can use is TCPI (To-Complete Performance Index). Project managers use TCPI to calculate the CPI that is required to get back the project on budget.

TCPI = (BAC-EV) / (BAC-AC)

$$\text{TCPI} = (\$20,000 - \$10,000) / (\$20,000 - \$11,200) = 1.14$$

The project manager should assess the CPI (1.14) required to get the project back on track with its cost baseline. This assessment would be based on various factors such as the availability and quality of resources for the remaining activities, and the project team's commitment and performance.

Ayers, J. (2021). Earned Value Management (EVM) Applied to Large IT Project. Retrieved from <https://www.projectmanagement.com/videos/690277/earned-value-management--evm--applied-to-large-it-project>

Project Management Institute. (2017). A guide to the Project Management Body of Knowledge (PMBOK guide) (6th ed.). Project Management Institute.

Project Management Institute. (2011). Practice Standard for Earned Value Management - Second Edition.

Retrieved from <https://www.pmi.org/pmbok-guide-standards/framework/earned-value-management-2nd>.

M. T. Cox MBA, D. (2013). Project Management at Work: Practical, Relevant Results. United States: iUniverse.

Project Management Institute. (2011). Practice Standard for Earned Value Management - Second Edition.

Project Management Institute. (2017). A guide to the Project Management Body of Knowledge (PMBOK

guide) (6th ed.). Project Management Institute.

11.4 Change Control Process

The monitoring and controlling process is a constant process starting at the very beginning of the project, and it finishes when the project is closed out. As detailed in Section 11.1, monitoring and controlling involves regularly measuring progress on a project to ensure it continues meeting objectives and addressing current organizational needs. Project managers monitor the project work by collecting project performance data, producing performance measures, and reporting and disseminating performance information. Then, they compare actual performance with planned performance, analyze variances and assess trends to affect process improvements (see Section 11.3), and finally evaluate possible alternatives and recommend appropriate corrective action as needed.

In order to manage the control process effectively, projects must have a change management plan and a configuration management plan which are sub-plans of the overall project management plan. A change management plan provides the direction for managing the change control process and documents the roles and responsibilities of the approval authority or the change control board if available. The configuration management plan describes the configurable items of the project and identifies the items that will be recorded and updated so that the product of the project remains consistent and operable. Therefore, these plans guide project managers and teams while they need to make a change in the project, and configure primarily the product scope.

When we find a problem, we can't just make a change since we should evaluate possible alternatives and consider risk response strategies and the availability of contingency reserves (see Chapter 10). What if corrective actions exceed our schedule or budget constraints? We need to evaluate triple constraint elements (scope, schedule, and cost) and other constraints such as resources and quality. Compromising the quality of the outcomes and deliverables would endanger the approval process, and hence lead to a project failure. Therefore, we have to figure out if it is worth making the change. Change control is a set of procedures that let us make changes in an organized way.

Anytime we need to make a change to our project management plan, we need to start with a change request. This request is generally in the form of a document (Table 11.4). Any change to the project needs to be documented so we can figure out what needs to be done, by when, and by whom. Any stakeholder can request a change. Once the change request is documented, it is submitted to a change control board, in particular, if the project is within a program or portfolio, and this necessitates the submission of change requests exceeding a specified cost. A change control board is a group of people who consider changes for approval. Not every change control system has a board. The change control system is designed based on various factors such as the size and complexity of the project, organizational policies, business field, and contract requirements. The change requests are generally submitted to the project sponsor by the project manager for review and approval. The project manager is responsible to monitor the change process from the very beginning to the very end. Putting the

recommended changes through change control will help us evaluate the impact and update all the necessary documents. Not all changes are approved, but if the changes and repairs are approved, we send them back to the team to put them in place.

Table 11.4: Change Request Form Template

Project Name:		
Project Number:		
Project Manager:		
Requestor Name:		
Request Date:		
Resolution Requested		
Description of Change:		
Reason for Change:		
Impact on Scope and/or Deliverables:		
Impact on Resources and Quality:		
Impact on Time and Cost:		
Disposition of Change Resolution:	Accepted:	Denied:
Project Manager Name & Signature	Date: _____	
Project Sponsor Name & Signature	Date: _____	

Change requests are made to modify documents, deliverables, and baselines. They are issued to expand, adjust, or reduce project scope, product scope, or quality requirements and schedule or cost baselines. They can include corrective actions, preventive actions, defect repairs, and updates. Project teams may need to assess the product and project scope, and this may require the teams to discuss the issues with stakeholders to determine if there is a need to revise requirements or add new ones.

In order to keep the track of change requests and actions taken, a “Project Change Request Tracking Log” (Table 11.5) can be held along with an “Issue Log”.

Although monitoring and controlling process is performed throughout the project, most of the effort would be expended especially during the execution (implementation) phase. Resources outside the core project team are assigned, and costs are usually the highest during this phase. Besides, scheduling issues would arise in this phase as project activities are carried out and human and physical resources are assigned. Project managers experience the greatest conflicts over the schedule in this phase. Some

activities may take longer than estimated. Some risks may occur creating schedule slippages. Project managers first apply techniques without the need for a change request if triple constraints aren't affected. Nevertheless, project managers should implement a holistic approach by taking into account all constraints and knowledge areas.

Table 11.5: Project Change Request Tracking Log Template

Project Change Request Tracking Log									
Project Name:									
Project Manager									
Submission Data			Impact Analysis			PM Review and Approval			
Request#	Submitted By:	Date	Date Assigned to Analyst	Assigned to	Date Analysis Completed	Date Reviewed	Committee Decision	Date Approved	Date Request Integrated into Project Plan

Project Management Institute. (2017). A guide to the Project Management Body of Knowledge (PMBOK guide) (6th ed.). Project Management Institute.

Project Management Institute. (2017). A guide to the Project Management Body of Knowledge (PMBOK guide) (6th ed.). Project Management Institute.

Project Management Institute. (2017). A guide to the Project Management Body of Knowledge (PMBOK guide) (6th ed.). Project Management Institute.

11.5 MS Project Tutorial

This MS Project tutorial will elaborate on how to conduct an EVM analysis. Table 11.6 provides a project with 15 activities.

Table 11.6: Project Activities

Activity	Duration (weeks)	Predecessors
A	2	—
B	3	—
C	1	A, B
D	3	C
E	2	C
F	2	D, E
G	3	E
H	4	F, G
I	2	H
J	6	I
K	4	J
L	3	J
M	2	J
N	2	K, L, M
O	1	N

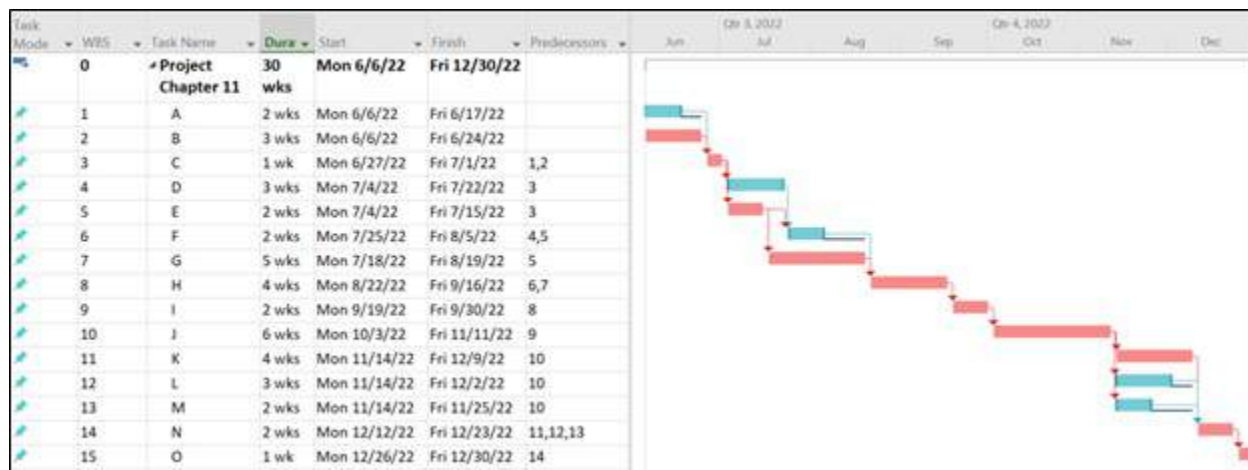

Figure 11.2: WBS, Schedule, and the Gantt Chart

In this project, the resources that are assigned to each activity are given in Table 11.7. All the resources are “Work” type resources which means that they are either people or equipment.

Table 11.7: Resources and Costs

Resource Name	Standard Rate	Activities
a	\$20.00/hr	A
b	\$40.00/hr	B
c	\$30.00/hr	C
d	\$15.00/hr	D
e	\$35.00/hr	E
f	\$50.00/hr	F
g	\$30.00/hr	G
h	\$25.00/hr	H
i	\$40.00/hr	I
j	\$40.00/hr	J
k	\$25.00/hr	K
l	\$25.00/hr	L
m	\$20.00/hr	M
n	\$35.00/hr	N
o	\$50.00/hr	O
Additional Cost 1	\$35.00/hr	C
Additional Cost 2	\$25.00/hr	F

Under the View tab, we click the “Resource Sheet”. Then, we can type the resource names and costs as

seen in Table 11.7. The Resource Sheet on MS Project is given in Figure 11.3.

Resource Name	Type	Max.	Std. Rate	Ovt. Rate	Cost/Use	Accrue	Base Calendar
a	Work	100%	\$20.00/hr	\$0.00/hr	\$0.00	Prorated	Standard
b	Work	100%	\$40.00/hr	\$0.00/hr	\$0.00	Prorated	Standard
c	Work	100%	\$30.00/hr	\$0.00/hr	\$0.00	Prorated	Standard
d	Work	100%	\$15.00/hr	\$0.00/hr	\$0.00	Prorated	Standard
e	Work	100%	\$35.00/hr	\$0.00/hr	\$0.00	Prorated	Standard
f	Work	100%	\$50.00/hr	\$0.00/hr	\$0.00	Prorated	Standard
g	Work	100%	\$30.00/hr	\$0.00/hr	\$0.00	Prorated	Standard
h	Work	100%	\$25.00/hr	\$0.00/hr	\$0.00	Prorated	Standard
i	Work	100%	\$40.00/hr	\$0.00/hr	\$0.00	Prorated	Standard
j	Work	100%	\$40.00/hr	\$0.00/hr	\$0.00	Prorated	Standard
k	Work	100%	\$25.00/hr	\$0.00/hr	\$0.00	Prorated	Standard
l	Work	100%	\$25.00/hr	\$0.00/hr	\$0.00	Prorated	Standard
m	Work	100%	\$20.00/hr	\$0.00/hr	\$0.00	Prorated	Standard
n	Work	100%	\$35.00/hr	\$0.00/hr	\$0.00	Prorated	Standard
o	Work	100%	\$50.00/hr	\$0.00/hr	\$0.00	Prorated	Standard
Additional Cost 1	Work	100%	\$35.00/hr	\$0.00/hr	\$0.00	Prorated	Standard
Additional Cost 2	Work	100%	\$25.00/hr	\$0.00/hr	\$0.00	Prorated	Standard

Figure 11.3: Resource Sheet

Let’s select all the resources except additional costs from the drop-down menu for each resource on the Gantt Chart view. Besides, we add a new column “Cost” to the left of “Resource Names”. As can be seen in Figure 11.4, the total estimated cost of the project is \$52,400. This figure would be also our BAC (Budget at Completion).

Task Mode	WBS	Task Name	Duration	Start	Finish	Predecessor	Resource Names	Cost
	0	Project Chapter 11	30 wks	Mon 6/6/22	Fri 12/30/22			\$52,400.00
	1	A	2 wks	Mon 6/6/22	Fri 6/17/22		a	\$1,600.00
	2	B	3 wks	Mon 6/6/22	Fri 6/24/22		b	\$4,800.00
	3	C	1 wk	Mon 6/27/22	Fri 7/1/22	1,2	c	\$1,200.00
	4	D	3 wks	Mon 7/4/22	Fri 7/22/22	3	d	\$1,800.00
	5	E	2 wks	Mon 7/4/22	Fri 7/15/22	3	e	\$2,800.00
	6	F	2 wks	Mon 7/25/22	Fri 8/5/22	4,5	f	\$4,000.00
	7	G	5 wks	Mon 7/18/22	Fri 8/19/22	5	g	\$6,000.00
	8	H	4 wks	Mon 8/22/22	Fri 9/16/22	6,7	h	\$4,000.00
	9	I	2 wks	Mon 9/19/22	Fri 9/30/22	8	i	\$3,200.00
	10	J	6 wks	Mon 10/3/22	Fri 11/11/22	9	j	\$9,600.00
	11	K	4 wks	Mon 11/14/22	Fri 12/9/22	10	k	\$4,000.00
	12	L	3 wks	Mon 11/14/22	Fri 12/2/22	10	l	\$3,000.00
	13	M	2 wks	Mon 11/14/22	Fri 11/25/22	10	m	\$1,600.00
	14	N	2 wks	Mon 12/12/22	Fri 12/23/22	11,12,13	n	\$2,800.00
	15	O	1 wk	Mon 12/26/22	Fri 12/30/22	14	o	\$2,000.00

Figure 11.4: Gantt Chart View with the Resources Selected

Under the “Task” tab, we can select “Tracking Gantt” from the drop-down menu (Figure 11.5).

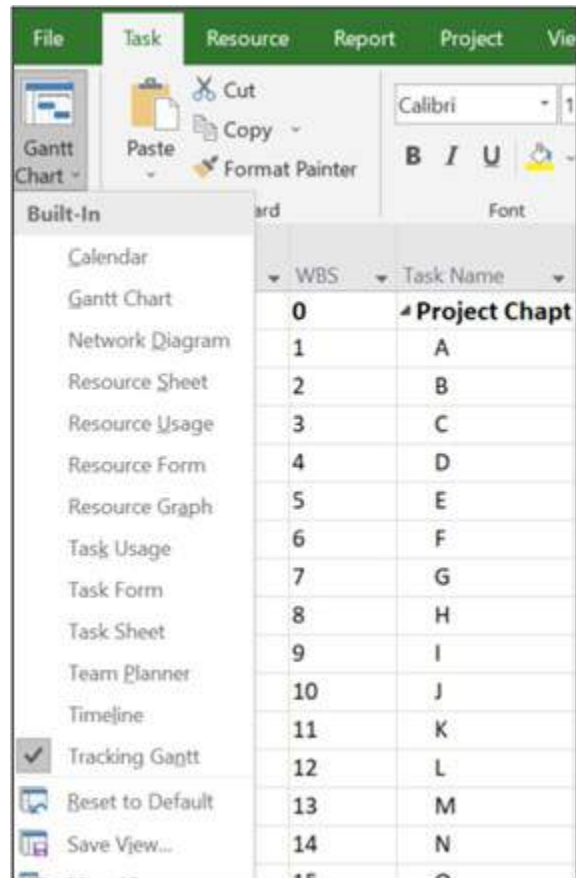

Figure 11.5: Selecting Tracking Gantt View

In order to create schedule and cost baselines, we must create a baseline by clicking “Set Baseline” under the “Project” tab. We can click OK as shown in Figure 11.6.

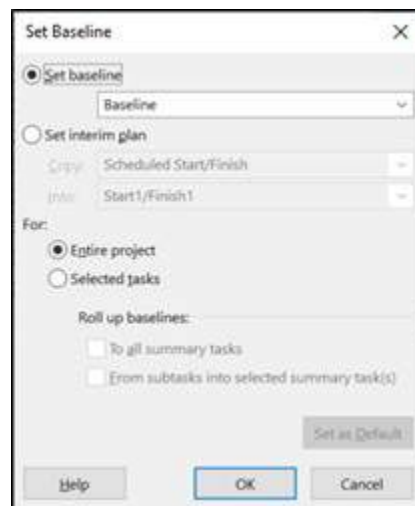

Figure 11.6: Set Baseline Window

The Tracking Gantt Chart is shown in Figure 11.7. As we haven’t indicated any progress yet, all the progress percentages are zero percent. Each bar is now composed of two horizontal parts. The lower part which is darker displays the baseline.

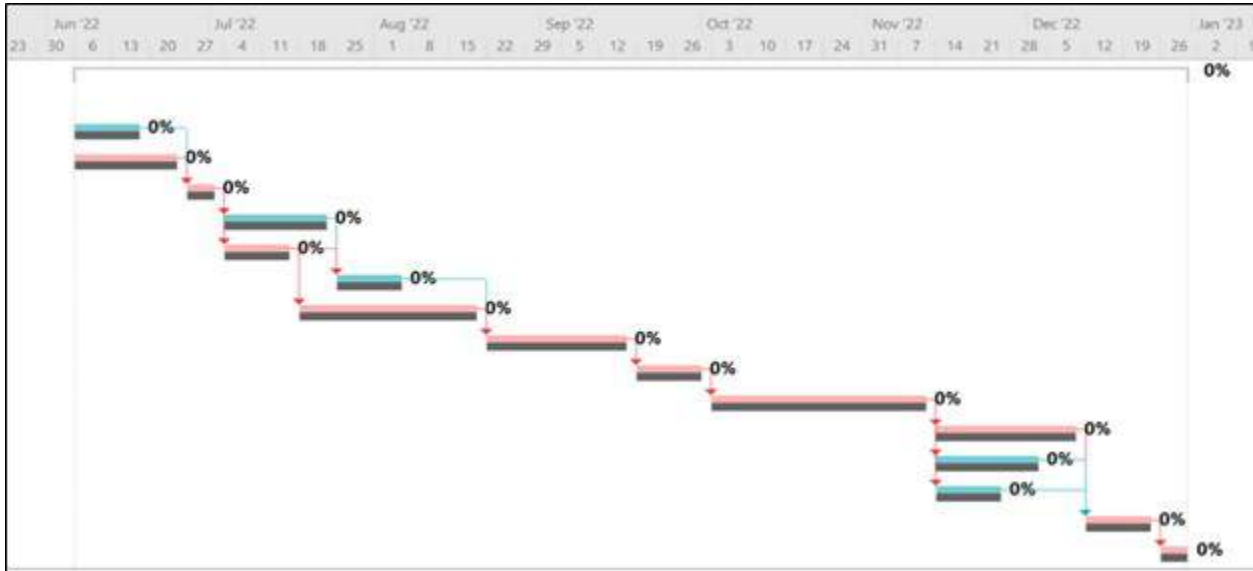

Figure 11.7: Tracking Gantt Chart

The project started on June 6, 2022. The estimated completion date is December 30, 2022. Let’s assume that some time passed in the project. Let’s make the current date September 18, 2022. Under the “Project” tab, click “Project Information”. Changing the current date won’t suffice (Figure 11.8). It will help us to see the date on the Gantt Chart. Rather, we need to change the status date to create a scenario as of September 18, 2022.

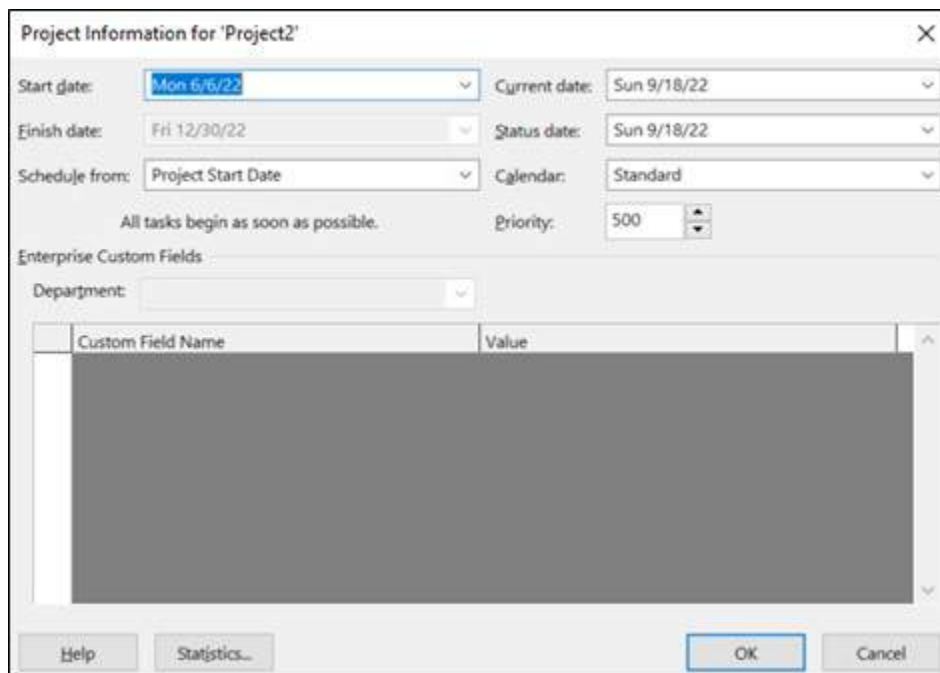

Figure 11.8: Project Information Window

Now, we can change the completion percentages for each activity, and add “Additional Resources” to create the impression as if we made some progress on activities, and spent more money on some of the activities. As indicated in Table 11.7, additional costs are added to activities C and F (Figure 11.9). The project cost changed to \$55,800 with the additional costs from its cost baseline of \$52,400.

Task Mode	WBS	Task Name	Duration	Start	Finish	Predecessor	Resource Names	Cost
	0	Project	30 wks	Mon 6/6/22	Fri 12/30/22			\$55,800.00
		Chapter 11						
	1	A	2 wks	Mon 6/6/22	Fri 6/17/22		a	\$1,600.00
	2	B	3 wks	Mon 6/6/22	Fri 6/24/22		b	\$4,800.00
	3	C	1 wk	Mon 6/27/22	Fri 7/1/22	1,2	c,Additional Cost 1	\$2,600.00
	4	D	3 wks	Mon 7/4/22	Fri 7/22/22	3	d	\$1,800.00
	5	E	2 wks	Mon 7/4/22	Fri 7/15/22	3	e	\$2,800.00
	6	F	2 wks	Mon 7/25/22	Fri 8/5/22	4,5	f,Additional Cost 2	\$6,000.00
	7	G	5 wks	Mon 7/18/22	Fri 8/19/22	5	g	\$6,000.00
	8	H	4 wks	Mon 8/22/22	Fri 9/16/22	6,7	h	\$4,000.00
	9	I	2 wks	Mon 9/19/22	Fri 9/30/22	8	i	\$3,200.00
	10	J	6 wks	Mon 10/3/22	Fri 11/11/22	9	j	\$9,600.00
	11	K	4 wks	Mon 11/14/22	Fri 12/9/22	10	k	\$4,000.00
	12	L	3 wks	Mon 11/14/22	Fri 12/2/22	10	l	\$3,000.00
	13	M	2 wks	Mon 11/14/22	Fri 11/25/22	10	m	\$1,600.00
	14	N	2 wks	Mon 12/12/22	Fri 12/23/22	11,12,13	n	\$2,800.00
	15	O	1 wk	Mon 12/26/22	Fri 12/30/22	14	o	\$2,000.00

Figure 11.9: Additional Costs added to activities C and F

As shown in Table 11.8, we will also change the completion percentages for each activity.

Table 11.8: Completion Percentages for the Activities

Activity	Completion Percentage
A	100
B	100
C	100
D	100
E	100
F	100
G	100
H	50
I	0
J	0
K	0
L	0
M	0
N	0
O	0

We can use the shortcuts for completion percentages (0%, 25%, 50%, 75%, 100%). Or double-clicking a task opens the “Task Information” window. From the “Percent complete” on this window, we can type

any percentage (Figure 11.10).

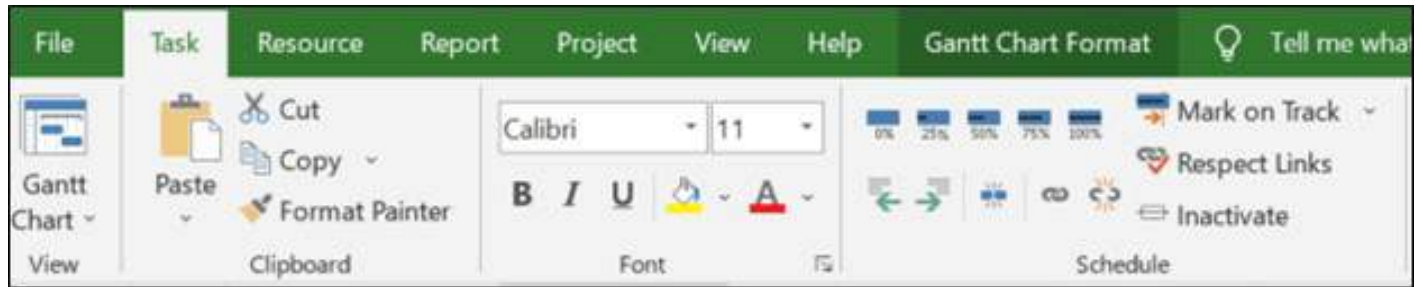

Figure 11.10: Shortcuts for Completion Percentages

After we mark the completion percentages for each task, we can see the percentages to the left of each bar on the Gantt Chart (Figure 11.11). Besides, the upper horizontal section of each bar will get darker for 100% completion, and the “Indicators” column will place ticks for these activities. Activity H has a 50% completion. Therefore, its upper horizontal section turned darker red for half of the activity. We should remember that weekends are considered holidays on Microsoft Project (default setting). Therefore, the coverage area may not necessarily display a 50% area on a bar.

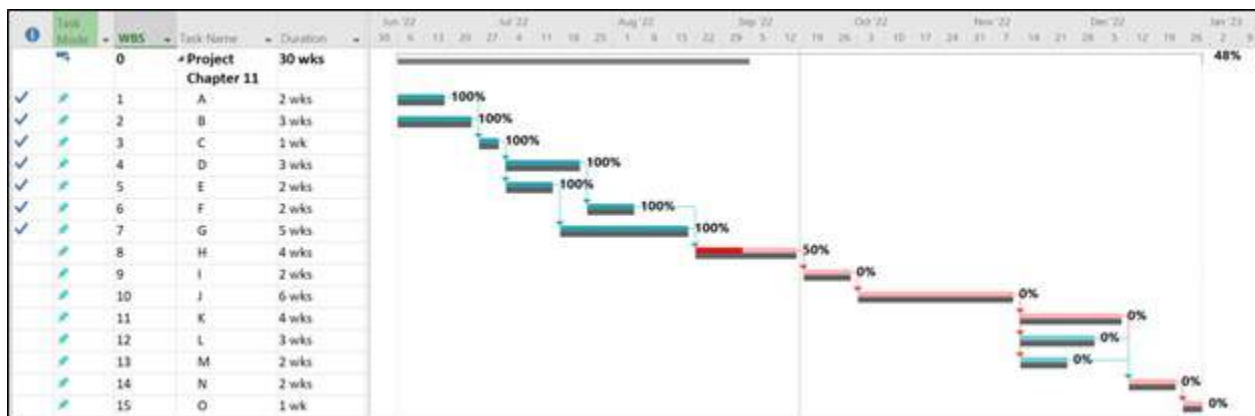

Figure 11.11: The Percentages marked to the right of each bar on the Gantt Chart

So, our scenario dictates that we finished 100% of activities A, B, C, D, E, F, and G, and 50% of activity H. Besides, we spent more money on activities C and F.

Now, we can open the EVM table. In the View tab, we click Tables and select More Tables. In the new menu window, we choose Earned Value. In the new sheet, we should insert SPI as a new column to the right of the existing “SV” column, and CPI as a new column to the right of the existing “CV” column. Figure 11.12 displays the Earned Value table view as of September 18, 2022. An SPI value of 0.92 indicates that our project is behind schedule. A CPI value of 0.88 indicates that our project has an overrun budget issue. Microsoft Project provides EAC, BAC, and VAC values (Figure 11.12). Our cost baseline was \$52,400. If we assume that the CPI value of 0.88 doesn’t change during the rest of the project, we can estimate to pay \$59,761 (EAC - Estimate at Completion) by the end of the project, which is \$7,361 (VAC - Variation at Completion) more than our cost baseline.

Task Name	Planned Value - PV (BCWS)	Earned Value - EV (BCWP)	AC (ACWP)	SV	SPI	CV	CPI	EAC	BAC	VAC
Project	\$26,200.00	\$24,200.00	\$27,600.00	(\$2,000.00)	0.92	(\$3,400.00)	0.88	\$59,761.98	\$52,400.00	(\$7,361.98)
Chapter 11										
A	\$1,600.00	\$1,600.00	\$1,600.00	\$0.00	1	\$0.00	1	\$1,600.00	\$1,600.00	\$0.00
B	\$4,800.00	\$4,800.00	\$4,800.00	\$0.00	1	\$0.00	1	\$4,800.00	\$4,800.00	\$0.00
C	\$1,200.00	\$1,200.00	\$2,600.00	\$0.00	1	(\$1,400.00)	0.46	\$2,600.00	\$1,200.00	(\$1,400.00)
D	\$1,800.00	\$1,800.00	\$1,800.00	\$0.00	1	\$0.00	1	\$1,800.00	\$1,800.00	\$0.00
E	\$2,800.00	\$2,800.00	\$2,800.00	\$0.00	1	\$0.00	1	\$2,800.00	\$2,800.00	\$0.00
F	\$4,000.00	\$4,000.00	\$6,000.00	\$0.00	1	(\$2,000.00)	0.67	\$6,000.00	\$4,000.00	(\$2,000.00)
G	\$6,000.00	\$6,000.00	\$6,000.00	\$0.00	1	\$0.00	1	\$6,000.00	\$6,000.00	\$0.00
H	\$4,000.00	\$2,000.00	\$2,000.00	(\$2,000.00)	0.5	\$0.00	1	\$4,000.00	\$4,000.00	\$0.00
I	\$0.00	\$0.00	\$0.00	\$0.00	0	\$0.00	0	\$3,200.00	\$3,200.00	\$0.00
J	\$0.00	\$0.00	\$0.00	\$0.00	0	\$0.00	0	\$9,600.00	\$9,600.00	\$0.00
K	\$0.00	\$0.00	\$0.00	\$0.00	0	\$0.00	0	\$4,000.00	\$4,000.00	\$0.00
L	\$0.00	\$0.00	\$0.00	\$0.00	0	\$0.00	0	\$3,000.00	\$3,000.00	\$0.00
M	\$0.00	\$0.00	\$0.00	\$0.00	0	\$0.00	0	\$1,600.00	\$1,600.00	\$0.00
N	\$0.00	\$0.00	\$0.00	\$0.00	0	\$0.00	0	\$2,800.00	\$2,800.00	\$0.00
O	\$0.00	\$0.00	\$0.00	\$0.00	0	\$0.00	0	\$2,000.00	\$2,000.00	\$0.00

Figure 11.12: Earned Value Table View

Our schedule baseline was 30 weeks (Figure 11.2). SPI is 0.92 as of September 18, 2022. If we cannot improve this SPI and it remains the same during the rest of the project, there may be a delay of 2.6 weeks $[1 - (30 \text{ weeks} / 0.92)]$.

11.6 Key Takeaways

Key Takeaways

- The monitoring and controlling process consists of tracking, reviewing, and reporting the overall progress to meet the performance objectives defined in the project management plan.
- Project managers monitor the project work by collecting project performance data, producing performance measures, and reporting and disseminating performance information. Then, they compare actual performance with planned performance, analyze variances and assess trends to affect process improvements, and finally evaluate possible alternatives and recommend appropriate corrective action as needed.
- Qualitative monitoring involves measuring quality rather than quantity, and it focuses on the scope, quality, stakeholders, communications, risks, resources, procurement, and team management.
- Earned Value Management (EVM) is a quantitative monitoring technique that uses metrics and indexes to assess project performance. Earned value analysis compares the performance measurement baseline to the actual schedule and cost performance.
- The main EVM parameters are planned value (PV), earned value (EV), and actual cost (AC).
- CPI is a measure of the cost efficiency of budget resources. When CPI is less than 1.0, it indicates a cost overrun.
- SPI is a measure of schedule efficiency. When SPI is less than 1.0, it indicates that the project is behind schedule.
- After PV, EV, and AC values are generated, and variance analysis (e.g., CPI and SPI) is performed, we can conduct trend analysis to predict how our project may perform during the rest of the project, and when the project is completed.
- In order to manage the control process effectively, projects must have a change management plan and a configuration management plan which are sub-plans of the overall project management plan.
- Any change to the project needs to be documented so we can figure out what needs to be done, by when, and by whom. Any stakeholder can request a change.

11.7 Questions and Exercises

There are 10 questions for this chapter. As you submit each answer, you will get immediate feedback and be taken to the next question.

An interactive or media element has been excluded from this version of the text. You can view it online here:

<https://pressbooks.ulib.csuohio.edu/project-management-navigating-the-complexity/?p=1235>

11.8 Attribution

This chapter is a derivative of the following texts:

1. [Project Management by Adrienne Watt](#). © [CC BY \(Attribution\)](#).
2. [Project Management from Simple to Complex](#). © [CC BY \(Attribution\)](#).
3. [Project Management by Florence Daddey](#). © [CC BY \(Attribution\)](#).
4. [Project Management Fundamentals by Shelly Morris](#). © [CC BY \(Attribution\)](#).
5. [Project Management by Merrie Barron and Andrew R. Barron](#). © [CC BY \(Attribution\)](#).
6. [Principles of Management](#) © [CC BY \(Attribution\)](#).

Chapter 12. Agile (Adaptive) Project Management

12.0 Learning Objectives and Overview

Learning Objectives

1. Recognize and describe the evolution and founding principles of agile project management approach.
2. List and describe the factors to consider when adopting an agile approach.
3. Identify the elements of an agile environment.
4. Recognize the most common agile methods and scaling frameworks.
5. Describe the recent trends in agile project management.

Overview

In the previous chapters, we discussed all the project management concepts and methods by mostly referring to the waterfall (predictive, traditional) project management approach implicitly or explicitly. Although all these concepts and methods are applicable to agile (adaptive) projects, these projects are developed on evolving requirements accompanied by an upfront planning which is not as comprehensive as it is in waterfall approach. Rather, the planning in agile approach is spread throughout the projects over separate iterations, sprints, or timeboxes. Each short iteration allows the project team to refine the requirements in accordance with the uncertainties, risks, technological changes, and stakeholder expectations and concerns. This chapter will first discuss the historical background of agile project frameworks and methods, and their key principles. Then, it will describe the factors to consider when adopting an agile approach, identify the elements of an agile environment, and elaborate on the most common agile methods and scaling frameworks. Finally, this chapter will address the recent trends in agile project management according to the 15th State of Agile Report.

Digital.ai. (2021). 15th State of Agile Report.

<https://digital.ai/resource-center/analyst-reports/state-of-agile-report>

12.1 Introduction to Agile

1980s and 1990s were the years software development teams started to have serious problems with developing and finishing their software projects which were getting more complex with more computer power and digitalization of businesses and organizations. Project managers and developers faced more and more problems when they were using the traditional waterfall approach (Figure 12.2 in the section 12.1.2). The development of software necessitated more collaboration among the project manager, developers, testers and users, and constant feedback from the users. Besides, new requirements were emerging while the software was being developed, and the client and end users were not always happy with the final product when they had the chance to see it after some time passed. Therefore, new methods started to emerge among software developers who lead this type of projects. Lean methodology created by Toyota for their production system, and utilized by many manufacturers was an inspiration for many of these software developers. In addition to the lean manufacturing process, just-in-time process and total quality management movement were other influencers of agile project management. Furthermore, Kanban which is a process improvement method in manufacturing was adapted to the software development life cycle.

As indicated above, new methods began to emerge in the 1980s and mostly in the 1990s as a response to some of the challenges that developers faced when using a waterfall approach.

One of the first to become popular was Rapid Application Development (RAD). James Martin, an IT consultant, developed an approach through which he divided the process into four distinct phases, namely, (1) requirements planning phase, (2) user design phase, (3) construction phase, and (4) cutover phase. It involved creating prototypes and using them to elicit requirements, validate designs and evolve toward usable solutions (Figure 12.1). RAD, itself, led to the development of alternative approaches as well.

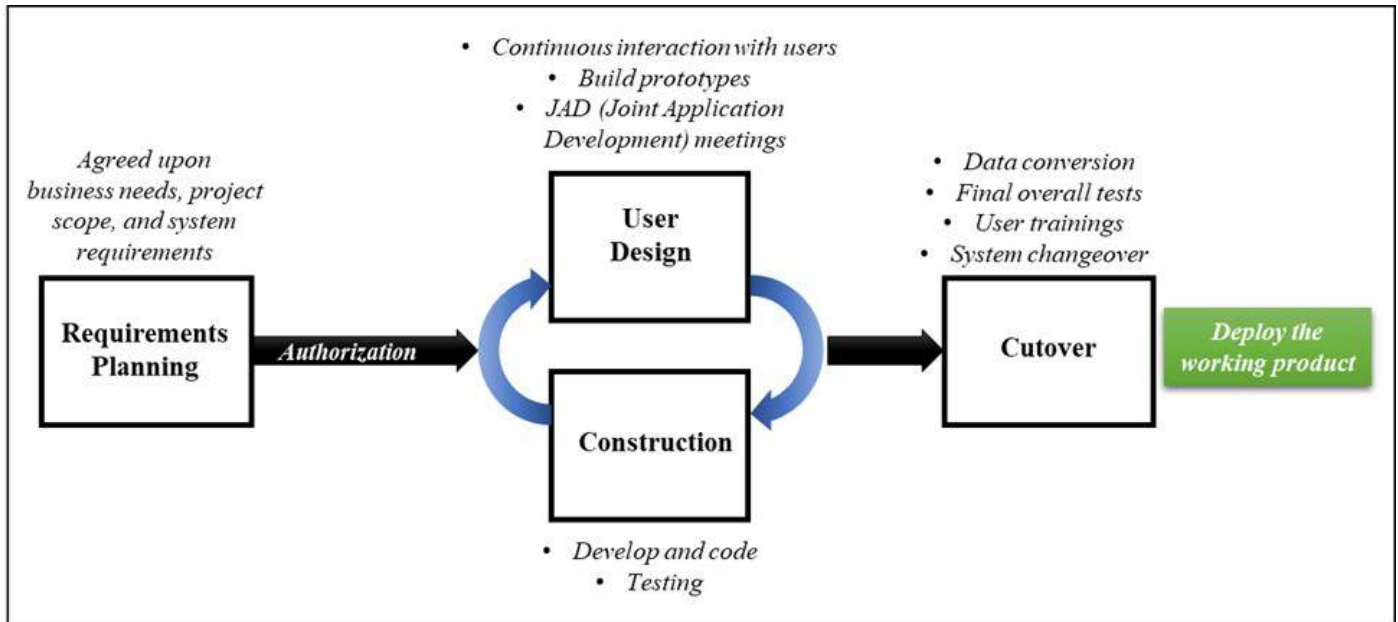

Figure 12.1: Rapid Application Development (RAD) Phases

Before Agile Alliance had their first meeting in 1999, there had been a diversification of agile methods which were called as lightweight methods as compared to the heavyweight waterfall models. The most popular methods were Crystal methods (1992), Dynamic Systems Development Model (DSDM) (1995), Scrum (1995), Feature Driven Development (FDD) (1997), Extreme Programming (XP) (1999), and Adaptive Software Development (ASD) (2000). Through the 1990s, a number of alternative ways to organize and structure the development of software products emerged as mentioned above, and they eventually evolved into the “agile” in 2001 with “Agile Manifesto”.

12.1.1 Agile Manifesto

At their initial meeting in 1999, the pioneers of agile methods discussed the similarity of XP with other methods and decided to meet again, with a broader range of people, to explore common ground. In 2001, a group of 17 people met at Snowbird Ski Resort in Utah to talk, ski, relax and try to find common ground between their thoughts on software development. They represented the leading thinkers from XP, Scrum, DSDM, ASD, Crystal, FDD and Pragmatic Programming, along with others who wanted a viable alternative to traditional heavyweight and documentation-driven development processes. They published the “Agile Manifesto” that embodied the values they all believed in and a set of guiding principles (Figure 12.2). Thus, the Agile Alliance was born.

Manifesto for agile software development

We are uncovering better ways of developing software by doing it and helping others do it. Through this work we have come to value:

Individuals and interactions over processes and tools.

Working Software over comprehensive documentation.

Customer Collaboration over contract negotiation.

Responding to Change over following a plan.

That is, while there is value in the things on the right, we value the items on the left more.

Figure 12.2: Agile Manifesto

Twelve Agile Principles behind the Agile Manifesto are listed below:

1. Our highest priority is to satisfy the **customer** through **early** and **continuous delivery** of **valuable software**.
2. Welcome **changing requirements**, even late in development. Agile processes harness change for the customer's competitive advantage.
3. Deliver **working software frequently**, from a couple of weeks to a couple of months, with a preference for the shorter timescale.
4. **Business** people and **developers** must work **together daily** throughout the project.
5. Build projects around **motivated** individuals. Give them the **environment** and **support** they need, and **trust** them to get the job done.
6. The most efficient and effective method of **conveying information** to and within a development team is **face-to-face conversation**.
7. **Working software** is the primary **measure of progress**.
8. Agile processes promote **sustainable development**. The sponsors, developers and users should be able to maintain a **constant pace** indefinitely.
9. **Continuous attention** to **technical excellence** and **good design** enhances agility.
10. **Simplicity** - the art of maximizing the amount of work not done - is essential.

11. The best architectures, requirements and designs, emerge from **self-organizing teams**.
12. At **regular intervals**, the team **reflects** on how to become more effective, then **tunes and adjusts** its **behavior** accordingly.

12.1.2 Differences between Waterfall and Agile Methods

As can be seen in Figure 12.3, in the waterfall (predictive, traditional) project management approach, the process is linear and sequential. Project teams should finish one stage to proceed with the following stage. As seen in Figure 12.3, the agile (adaptive) project management approach compresses the sequential phases in small timeboxes. Therefore, agile teams work on a limited number of requirements (i.e., user stories) at a time, and they can receive frequent stakeholder feedback at the end of each timebox when they create a partial working product.

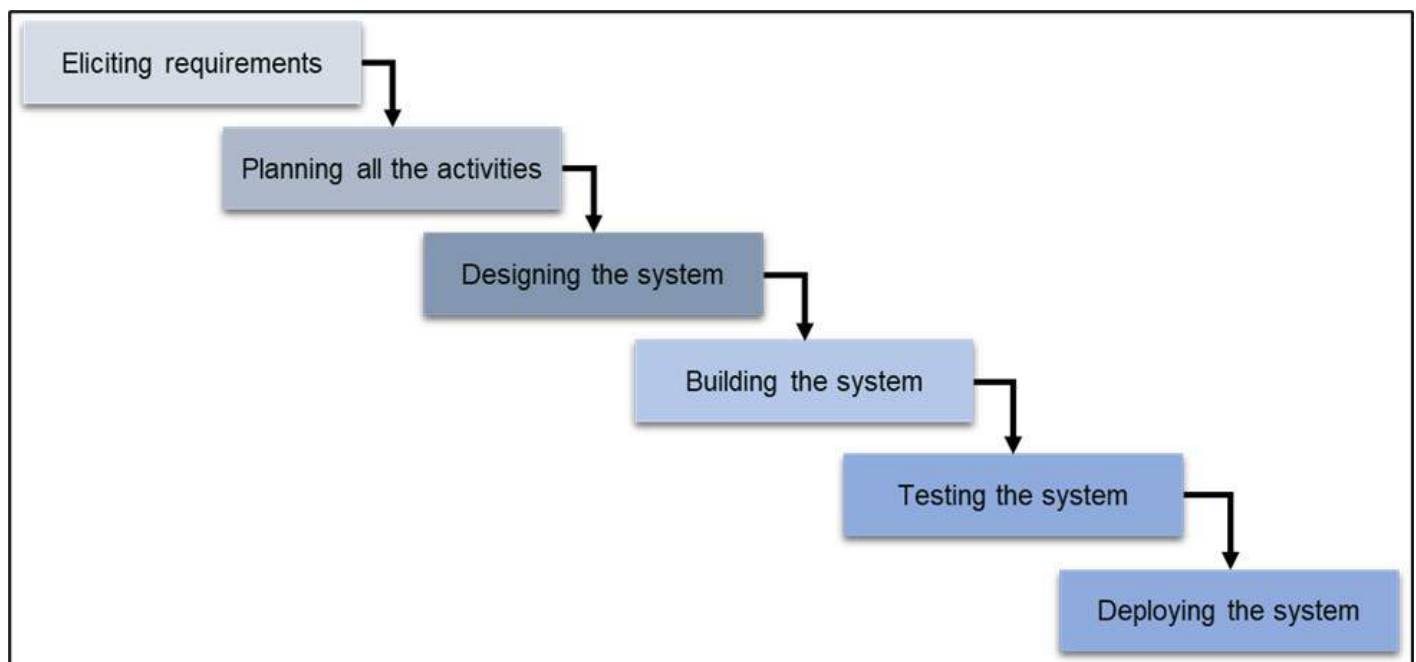

Figure 12.3: Waterfall Project Management

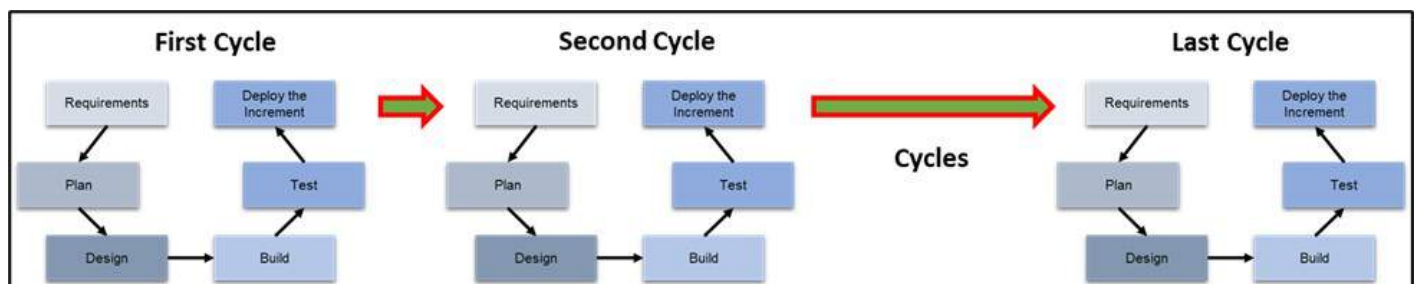

Figure 12.4: Agile Project Management

The frequent interaction with the client and stakeholders offers an environment where the frustration level of stakeholders is minimized. Nevertheless, agile methods may not be appropriate for all projects. Waterfall project approach may work better when:

- Requirements are very well understood and can be fixed before the implementation begins.
- Client's and customers' expectations from the product is stable and substantial changes can be avoided.
- Technology and the tools utilized are understood very well by the stakeholders, and changes that may affect the project's progress are not expected.
- The duration of the project is relatively short.
- The uncertainty is at a low level.
- Resources are available, and easy to acquire.

Therefore, we can implement a waterfall project when we expect low uncertainty and define the project and product scope, and project constraints easily with clear and unambiguous procedures. The production domain and processes involved are usually well understood and there are typically low levels of execution uncertainty and risk. However, if we cannot define the product scope, and uncertainty level is high, an agile approach would be better to move gradually by clarifying the requirements and uncertainties with the active involvement of clients and stakeholders.

In agile projects, client and stakeholder involvement can be provided constantly since product owners are a part of the team, and the increments are reviewed by the product owner and the client frequently. In waterfall projects, the interaction with the client is deferred to the end of a phase, for instance, when the software coding and testing are complete. However, in real life projects, teams often implement a hybrid approach which is a blend of waterfall approach and some principles of agile such as client involvement and feedback.

12.1.3 An Example: Grocery LLC Decides on the Project Approach for the “Self-Checkout Stations Project”

As discussed in section 1.2.3 titled “Case Study 1.1: Characteristics of a Project Undertaken by Grocery LLC”, the grocery chain, Grocery LLC, considers establishing self-checkout station areas in all fifty branches to find a solution to long lines in front of the current checkout stations where the cashiers work. The project selection committee discussed the solution and decided to implement this project. As part of requirements elicitation, business analysis team surveyed managers and employees, and interviewed customers. Besides, the team visited the competitors' markets and made market research to have a better understanding of possible solutions in the market. The team concluded that self-checkout has been increasingly deployed in many grocery store and pharmacy chains (e.g., Walmart, Target, CVS) across the United States, and the manufacturers and service providers are experience. Therefore, the sponsor, project manager, and relevant departments had a meeting to discuss the project management approach. They decided to implement a waterfall approach supported by continuous stakeholder interaction as is done in agile methods.

- Managers, employees, and customers conveyed their requirements. The analysis revealed that requirements are consistent with the current implementations and the research consultancy company's report. Therefore, it was concluded that requirements are very well understood and

can be fixed to a large extent before the implementation begins. However, in order to keep up with the technological advancements and to be prepared for the risks such as new waves of pandemic, it was decided to establish a continuous interaction and feedback system with the stakeholders.

- There are experienced companies which provide competitive prices to acquire the systems. They implemented numerous projects across the United States. They have comprehensive knowledge of the current and upcoming technologies.
- The duration of the project is 8 months.

12.1.4 An Example: Grocery LLC Decides on the Project Approach for the “M-Commerce Project”.

As discussed in section 1.2.4 titled “Case Study 1.2: Characteristics of Another Project Undertaken by Grocery LLC (M-Commerce Project)”, the grocery chain, Grocery LLC, considers having a better online presence by creating a mobile app and optimizing the website for mobile devices in particular due to the negative effects of pandemic on the number of in-store customers, hence significantly decreased revenue and profit. In the initiation stage, project manager prepared a report justifying the need for conducting an agile methodology, i.e., Scrum, during this project in order to accelerate the pace and achieve the outcome in a relatively shorter time, receive constant and timely feedback from the employees and customers, keep a healthy interaction with the stakeholders, and adjust the specifications to the fast and unprecedented changing technologies and socioeconomic conditions. Since it was not easy for the project manager and the team to oversee the near future in a turbulent environment (e.g., Covid cases and hospitalizations rocketing to the peak in a very short time), the sponsor and the project steering committee supported the project manager’s decision to implement an agile method. The Scrum cycles (sprints) were set as two weeks so that a working app and mobile website can be developed gradually with some of the requirements and functions at the end of each sprint, which can allow frequent end-user feedback and interaction.

Rothman, J. (2017). *Create Your Successful Agile Project: Collaborate, Measure, Estimate, Deliver*. Pragmatic Bookshelf.

Cobb, C. G. (2015). *The project manager's guide to mastering Agile: Principles and practices for an adaptive approach*. John Wiley & Sons.

Martin, J. (1991). *Rapid application development*. Macmillan Publishing Co., Inc.

Martin, J. (1991). *Rapid application development*. Macmillan Publishing Co., Inc..

Retrieved from <https://agilemanifesto.org/history.html>.

Retrieved from <https://agilemanifesto.org/principles.html>.

Project Management Institute. (2017). *Agile Practice Guide*. Project Management Institute.

12.2 Adopting and Creating an Agile Environment

12.2.1 A Case Study of the Penta Transformations

A Six-Month Cultural Transformation: The Penta Story

Penta Technologies, a family-owned construction software company in Wisconsin, developed and provided customized accounting and finance ERP systems, labor productivity suites, and payroll tools for construction back-office services. However, the convenience of customization led to more complicated workload for the project teams and employees while it was a relief for the clients. Rather than focusing on the effectiveness of projects and their outcomes, the company dealt mostly with the contract negotiation and customer emergencies. The main issues were the implementation of a traditional project management approach that made the frequency of delivery slow and inconsistent. However, the solution was not that easy just by switching to an agile structure. The president and the COO figured out that there are organizational and cultural barriers that need to be overcome first. First of all, they reduced the number of executives to three, which simplified the decision making and allowed space for the team to identify the most urgent issue, optimizing the product development teams. But this was only the initial step to transition to a more agile structure. The COO announced that they were going to partner with everyone in the organization to figure out the best structure for the business. As a result, employees' feedback was aggregated in five areas that need attention: (1) Remove functional silos, (2) more ownership in the work, (3) remove unnecessary and complex processes, (4) stop micromanagement and improve trust, and (5) more focus on value. Based on this valuable employee feedback, a team conducted research on different organizational structures. The team suggested a transition to the Scrum framework which a team-based and servant-leadership organizational structure. This was just the beginning for Penta. However, this case showed that organizations need to evaluate the current organizational structure and culture, and develop a novel background and mindset over which they can build the new agile structure. A new house cannot be constructed over an old and torn foundation. We need to ensure that the foundation is so strong that it can bear

12.2.2 Creating a Novel Mindset: Agile

As can be seen in the case study of Penta Technologies above, organizations don't start creating, adopting and implementing an agile project approach in one day as is the case for all the actions organizations should take. A long and well-thought-out process is inevitable to generate ideas effectively, which can benefit the organization in the long term. As for the agile environment, the challenging process requires adoption of an agile mindset that spans throughout the organization

including the executive team, managers, supervisors, and all other employees. At the very beginning, organizations and their project teams and leaders should answer many questions, some of which are provided below, to develop an implementation strategy:

- How can organizations, their employees, and project teams and in particular, their members, act in an agile manner?
 - Are there organizational impediments that we need take care of (e.g., issues in formal structure such governance and policies, and informal structure such as organizational culture)?
 - What are the levels of acceptance and resistance that we may expect from the executives, managers, employees, project managers, and team members?
 - How can we measure these levels (e.g. survey, interviews, focus group meetings) so that we can create an action plan?
 - What kind of activities (e.g., seminars, webinars, training, social events) do we need to organize?
- What can our teams deliver quickly and obtain early feedback to benefit the next delivery cycle?
 - Are our products appropriate for quick incremental deliverables?
- How can the teams act in a transparent manner?
- What works can be avoided in order to focus on high-priority items?
- How can a servant-leadership approach benefit the achievement of the team's goals and project objectives?

12.2.3 Benefits and Challenges of Agile Project Management

When organizations start utilizing agile project management approach and principles, they can expect to see the benefits below:

- They can find opportunities to deliver business benefits at an early stage through addressing straightforward problems.
- They can shorten the time to introduce new products and services to the markets and customers.
- They can increase and maintain the adaptability to changing needs of customers.
- They can achieve an improved quality of products and services through short cycles and constant client and stakeholder interaction and feedback.
- Ultimately, they can maximize the return on investment.

Gustavsson (2016) examined the literature to list the common benefits of implementing agile project management in a non-software development context. Top ten benefits indicated by Gustavsson (2016) are listed below:

- Better collaboration in the team

- Increased customer interaction
- Increased productivity and speed
- Increased flexibility in coping with the change
- Better understanding of goals/tasks/requirements
- Increased transparency and visibility
- Increased quality
- Customer-centered value adding priority process
- Increased knowledge sharing
- Increased cross-organizational collaboration

However, Gustavsson (2016) also examined the problems and challenges while adopting and implementing agile approach, and outlined eleven challenges as below:

- Changing mindset to allow flexibility
- Lack of process visibility
- Buy-in from managers
- Difficult to see benefits early in the project
- Inadequate knowledge sharing
- Individual work, lack of communication
- Long-term planning
- Lack of stakeholder engagement
- Scope creep (uncontrolled expansion of the scope with product requirements and project activities)
- Insufficient resource allocation
- Redundant work

These results demonstrate that no one system, approach, or methodology is alone perfect. Project managers and team members always need to take into account the coexistence of pros and cons of anything used in a project by incorporating the cost-benefit analysis. While increased knowledge sharing was indicated as a benefit, challenges presented a challenge of inadequate knowledge sharing. Thus, decision-makers and project managers should consider the factors that may cause inadequate knowledge sharing in an agile environment. This is also valid for other elements such as flexibility, communication, early delivery, and resources as well as triple constraints (i.e., scope, schedule, and budget).

Regarding the project success, Serrador and Pinto's (2015) quantitative analysis of 1,002 projects across multiple industries and countries concluded that agile methods have a positive impact on two dimensions of project success which are efficiency and overall stakeholder satisfaction against organizational goals.

12.2.4 The Elements of an Agile Environment

Although the roles and the practices of each agile method and framework vary from one to another,

there are common roles and practices across them. In this section, we will elaborate on these.

12.2.4.1 Common Agile Roles and How Agile Team Works

There are three main roles in agile teams.

1. Cross-functional and self-organizing teams and their members
2. Product owner
3. Team facilitator

Considering the self-organizing structure of agile teams and the role of project manager as a team facilitator and servant leader, we can first focus on the team members who form the agile teams. Cross-functional teams consist of members with various skills from different areas. If it is a software development team, it can be composed of designers, systems analysts, developers, testers, and business unit representatives. Team members discuss the tasks and pick the ones they think would fit the best. Team facilitator (or the project manager) doesn't tell who should do what, but acts as an obstacle remover and a coordinator. Agile teams generally work during short cycles (i.e., iterations) to release a working product, an incomplete but a testable partial product, which is named as increments. Rather than creating the whole website with its all backend features in three months, these teams create a number of web pages with some of the properties and functions in a short time (e.g., a two-week iteration). In the end of each iteration, the team presents the increment in the form of a partial product (e.g., three web pages). The product owner representing the client and the end-users provide the feedback about what they think of these three web pages. They may say "We want the navigation bar at the top with that size and those colors" or "The pictures should not cover more than one third of the row while not zoomed in". These increments help the team receive feedback constantly. Therefore, they can work on each increment based on the feedback, and they can improve the product. This provides the team with the opportunity to make timely and effective interventions which otherwise would cause serious problems at the end of the project. So, when the team receives the feedback as regards the navigation bar's position and color, they apply the request to the current and future web page layouts. However, another feedback may still want the team to change the position and color. This is an ongoing process with constant interaction with the client, end users, and stakeholders. In a waterfall project management approach, the team finishes the development of the whole website, and submit it to the client for the inspection of the client and its end users. However, in the meantime, a three-month duration passes, and the possibility of receiving feedback from the client that can lead to a serious rework could be high.

As is discussed above, these teams are self-organizing teams, which means that team members decide on the tasks that each will work during an iteration, rather than a team facilitator tell them what they need to do. Agile teams are generally small teams smaller than 10 members. These teams use techniques to collaborate more effectively such as pairing, swarming, and mobbing. Pairing is generally utilized by XP (Extreme Programming) teams when software developers write codes. While one member works on coding, the second member checks the quality of the coding made by the first member. Another collaboration technique is swarming through which multiple team members focus collectively

on resolving a specific impediment.

A second agile role is the product owner who is responsible for guiding the direction of the product. Product owners can be a representative of the internal or external client, or a person who represents the client and the stakeholders. Product owners keep a constant daily communication with the agile team. They provide the product backlog which includes the user stories (requirements), and prioritize the user stories. Product owners are the bridge between the clients (and their end-users, customer and stakeholders) and the agile team. The feedback conveyed by the product owner is used to develop the increments at each cycle. Product owners communicate with subject matter experts to produce good-quality user stories (requirements) and offer effective feedback. Recently, IIBA (International Institute of Business Analysis) have offered a new certificate, “Certificate in Product Ownership Analysis”, which integrates product ownership and business analysis.

The third and the final role is a team facilitator which can be also named as project manager, scrum master, project team lead, or team coach based on the method or framework utilized, and/or the organization’s guidelines. In agile teams, project managers’ role is different from the traditional role they play in waterfall (predictive) project management. Generally, in traditional approach, project managers are the ultimate authority in a team who decides which tasks are carried by which member. Their authority with respect to the control is high. However, in agile teams, project managers should be the facilitators and coaches, and they need to adopt a servant leadership approach. Team members organize the tasks that needs to be carried out during a cycle. Project managers help them in removing the impediments, overcoming the conflicts inside the team or with stakeholders, and coaching the members to allow them to improve their skills. For example, if team members find themselves in a conflict with a stakeholder and cannot solve the issue themselves, the project manager gets involved to resolve the conflict. Or developers in the team may ask the project manager to buy a license for a software which can help them produce a better quality IT solution or complete the activities earlier. Servant leaders empower their teams and facilitate their teams’ success by promoting self-awareness, listening, helping people grow, coaching, promoting safety, respect and trust, and promoting the energy and intelligence of others. They practice their leading through service to the team focusing on understanding and addressing the needs and development of team members. Hence, interpersonal skills such as team building, motivating, communicating, influencing, decision making, political and cultural awareness, negotiating, facilitating, managing conflict, and coaching are more important than the technical skills.

12.2.4.2 Common Agile Practices

Agile teams utilize various artifacts and events to conduct their tasks and achieve project objectives. Although they are used in different agile methods with same or different names, the Scrum framework which is the most common agile method make use of all of these artifacts and events. They are:

1. Team charter
2. User stories and backlog
3. Planning of each iteration or cycle (Not a comprehensive upfront planning)

4. Daily standups
5. Demonstration or reviews
6. Retrospectives
7. Backlog refinement

A **team charter** is necessary for all types of projects. It consists of team values, working agreements, ground rules, and group norms. It is a social contract which indicates how the team members interact with each other. The primary objective of a team charter is to create an agile environment where project managers, team members, and product owner can work to the best of their ability. In agile projects, the team charter has to define what “ready” and “done” mean. In particular, when teams use a Kanban board (see Figure 12.5), tasks are organized on a timebox (i.e., cycle, iteration, Scrum sprint) to display and monitor their status such as to-do, doing (in progress), and done. Teams can assess the completeness of user stories and tasks according to the definition of “done”. Therefore, they can evaluate the completed tasks consistently.

User stories are requirements presented in a story form for the team to understand the needs of the client and stakeholders. They, together, establish the product backlog, the basis of the plan and each iteration. The structure of a user story is given below. These stories don’t only convey what a stakeholder expects from a product or service, but also includes the reason why that stakeholder needs. The project team can better understand why the stakeholder asks for a requirement. It can give a clue to the team if the requirement is a must or not, or if it is possible to incorporate into the product.

- As a “user/stakeholder”, I want to “perform a function / an action / an app feature” so that I can “acquire a benefit / an expected outcome”.

Let’s consider that our grocery chain’s m-commerce project is conducted as an agile project. Therefore, we have created some of the user stories. It is of high importance to keep in mind that product owner doesn’t need to list all the user stories since one of the advantages of agile projects is that a product evolves throughout the project based on the feedback of the end-users. Three user stories are provided below as examples that can be used in this m-commerce project:

- As a customer, I want to browse all the items under relevant categories (e.g., bakery, beverages, laundry and cleaning, electronics) so that I can find the items I am looking for and view all the related items on a single window or page, or more than one page with the page numbers displayed at the bottom of each page.
- As an administrator, I want to disable accounts which are not valid anymore so that we can manage the active accounts and archive the disabled accounts.
- As a shopper (or a store employee who is picking up the ordered items from the shelves), I want to view all the online orders assigned to me on my mobile device so that I can start shopping two hours before the delivery begins.

Table 12.1 exhibits four user stories selected from our m-commerce project. In order to keep the user story column shorter, we removed the “so that” part which provides the reasoning of why the stakeholder needs this requirement.

Table 12.1: A Backlog composed of Four User Stories

User Story	Estimation	Priority
As a customer, I want to log on the mobile app with the same username and password that I use to log on the website.	2	1
As a customer, I want to create an account in three minutes.	5	2
As an administrator, I want to see all the orders on my dashboards, and filter and sort them according to various criteria.	2	3
As a store shopper, I want to view all the online orders assigned to me in my mobile device.	3	4

Product owners prioritize the user stories. Before each cycle starts, sufficient numbers of user stories with the highest priority are pulled from the backlog so that the team can work on these user stories. Let's assume that the user stories in Table 12.1 were selected for the first cycle / timebox since the team decided to pull the highest priority user stories for the first cycle. Priority is only one factor to consider while selecting the user stories. Teams also estimate the story size taking into account the estimated time to finish and other criteria such as the effort and resources required to complete these tasks. Analogous estimating technique that takes into account the information from other projects, experience of project managers and team members from previous projects, and lessons learned helps the teams to create these estimates. Estimations are very important to make a better planning if the team can complete them in one cycle or iteration. While scrum teams set a specific time to finish each iteration (e.g., 1 week, 2 weeks, 30 days), Kanban teams focus on the user stories by means WIP (Work in Progress) limits. Therefore, Kanban teams don't necessarily set a timebox, but they commit to completing an increment of work by focusing on a limited number of manageable tasks.

Instead of carrying out an overall project planning and trying to predict all the aspects of a project (e.g., scope, requirements, schedule, cost) as is done in waterfall project before the implementation phase starts, agile projects work on a limited number of requirements. Thus, **planning** can be done at the beginning of each cycle, which allows the team to adjust itself according to the feedback from end-users, and changing requirements and conditions. As the project progresses, agile teams generally spend less time in the initial phases (e.g., requirements, planning, design as exhibited in Figure 12.4). Hence, they can focus more on implementation.

Another practice in agile projects is the **daily standup meetings** which occur mostly in the early morning before starting the daily tasks. They are called standup meetings since members generally stand up instead of sitting so that they can accelerate the meetings by avoiding the comfort of sitting. Although team members don't meet in person at the collocated offices as it used to be due to the wider utilization of virtual teams recently and because of the Covid-19 pandemic measures that mandated to stay at home, agile teams continue holding these standup meetings, being the mostly utilized agile practice, in online platforms such as Microsoft Teams and Zoom. The project leader or a team member can take the lead in standup meetings. In general, team members discuss the three questions below:

1. What have I completed since the last standup meeting?
2. What am I planning to complete until the next standup meeting?
3. What are the impediments, risks and problems that I may encounter?

When teams create an increment (e.g., a website with three web pages, an EPR module for accounting with limited functions, a prototype of a machine that is intended to manufacture spare auto parts) at the end of a cycle, they can **demonstrate** how this increment works. The product owner assesses the demonstration and collects the feedback from end-users. Therefore, the team can continue building upon the increment according to the feedback. Although negative feedback from the product owner may lead to a frustration for the team, frequent feedback in earlier stages prevents the team from heading in a wrong direction. The team leader's servant leadership role as a coach can help the team enable frequent delivery.

At the end of each cycle, agile teams discuss what worked and what could have been better in that cycle. These **retrospectives** help the teams learn from their previous work. The lesson learned process becomes more frequent in line with the review and feedback from the product owner and end-users. As one of the agile principles indicate, "at regular intervals, the team reflects on how to become more effective, then tunes and adjusts its behavior accordingly." Teams may also decide to retrospect at different times, not only limited to the end of the cycles. For example, the project manager may call for a retrospective meeting when the team is stuck and cannot complete the work. Therefore, this meeting can help the team determine the underlying reason of the bottleneck and find a solution with a facilitated brainstorming session.

The last common agile practice to mention is the **backlog refinement process** which occurs generally in the middle of iterations. In this refinement meetings, product owners present story ideas to the team and the team learns about the potential challenges or problems in the stories.

Scrum.org. (2020). A Six-Month Cultural Transformation: The Penta Story. Retrieved from <https://www.scrum.org/resources/six-month-cultural-transformation-penta-story>

Project Management Institute. (2017). Agile Practice Guide. Project Management Institute.

Gustavsson, T. (2016). Benefits of agile project management in a non-software development context: A literature review. In Fifth International Scientific Conference on Project Management in the Baltic Countries, April 14-15, 2016, Riga, University of Latvia (pp. 114-124). Latvijas Universitate.

Information is available on <https://www.iaa.borg/business-analysis-certifications/certificate-in-product-ownership-analysis-iiba-cpoa/#get-cpoa-certified>.

Project Management Institute. (2017). Agile Practice Guide. Project Management Institute.

Project Management Institute. (2017). A guide to the Project Management Body of Knowledge (PMBOK guide) (6th ed.). Project Management Institute.

Digital.ai. (2021). 15th State of Agile Report.

<https://digital.ai/resource-center/analyst-reports/state-of-agile-report>

Project Management Institute. (2017). Agile Practice Guide. Project Management Institute.

Project Management Institute. (2017). Agile Practice Guide. Project Management Institute.

12.3 Common Agile Framework and Methods

Although there are many agile approaches, only several of them are utilized commonly by organizations. The Agile Practice Guide by PMI (Project Management Institute) lists the single-team agile methods as below:

1. Scrum
2. Extreme Programming (XP)
3. Kanban
4. Crystal methods
5. Scrumban
6. Feature-Driven Development (FDD)
7. Dynamic Systems Development Method (DSDM)
8. Agile Unified Process (AgileUP)

Besides single-team agile approaches, higher-than-single-team level (e.g., enterprise-level) scaling frameworks are provided below:

1. Scrum of Scrums
2. Scaled Agile Framework (SAFe®)
3. Large Scale Scrum (LeSS)
4. Enterprise Scrum
5. Disciplined Agile (DA)

12.3.1 Scrum

Scrum is the most utilized single-team agile method. It consists of roles, events, artifacts, and rules. Scrum events are sprints, sprint planning, daily scrum, sprint review, and spring retrospective. Scrum artifacts are product backlog, sprint backlog, and increments. It uses an iterative approach to deliver a working product (i.e., an increment) at the end of each timebox. These timeboxes are called sprints which last generally for one month, or four weeks, or shorter with consistent durations. When a two-week sprint duration is determined, all the sprints are set at two weeks. At the end each sprint, a potentially releasable increment of product is produced. A scrum team is composed of product owner, development team, and scrum master. The scrum master is responsible for ensuring the Scrum process is upheld and works to ensure the Scrum team adheres to the practices and rules as well as coaches the team on removing impediments.

12.3.2 Kanban

The Japanese word “kanban” means “visual board” or a “sign”. It was first developed and applied by Toyota as a scheduling system for just-in-time manufacturing. The workflow is visualized on a Kanban (Figure 12.5). The Kanban board is also used by Scrum teams.

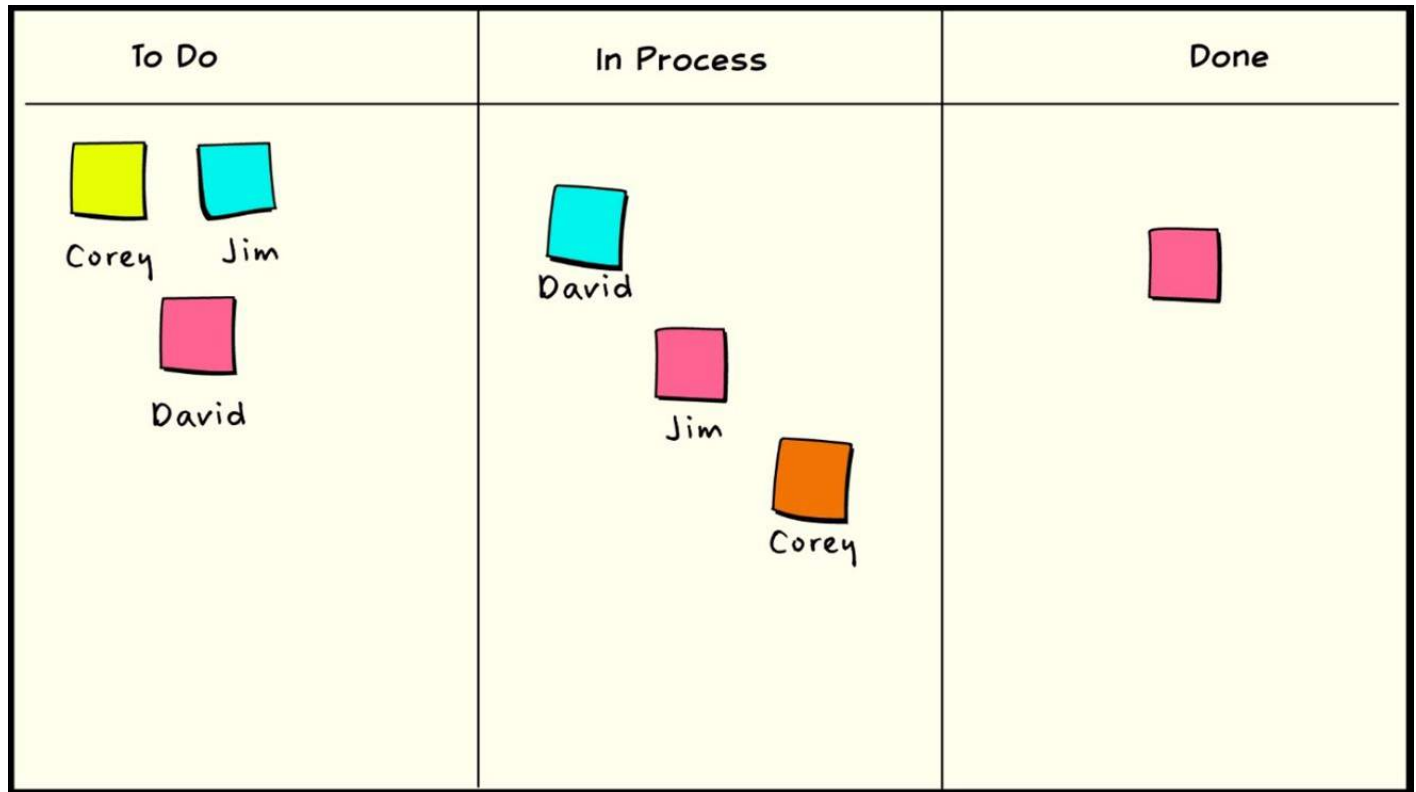

Figure 12.5: A task board in Kanban

(Retrieved from <https://www.agilealliance.org/scrumban/>)

The work is split into pieces, and each item is written on a card. Then, they are put on the wall, or it can be visualized in a software program or a website such as Jira. Explicit limits are assigned in Kanban projects so that each workflow state can have limited number of in-progress items (Work in Progress - WIP). The team tries to finish these tasks in the shortest possible time. This lead time is measured so that the team can optimize the process to make the lead time as small and predictable as possible.

12.3.3 Scrumban

Scrumban is an agile approach originally designed as a way to transition from Scrum to Kanban. Scrumban teams use Scrum as a framework and Kanban for process improvement. It uses the prescriptive nature of Scrum to be agile, and uses the process improvement of Kanban to allow the team to continually improve its process. In Scrumban, the work is organized into small “sprints” and leverages the use of Kanban boards to visualize and monitor the work. There are no predefined roles in Scrumban as is the case in Kanban. However, the Scrumban teams generally retain the Scrum roles.

12.3.4 eXtreme Programming (XP)

As the name implies, XP is utilized by software teams. It is an agile software development framework that aims to produce higher quality software, and higher quality of life for the development team. XP is the most specific of the agile frameworks regarding appropriate engineering practices for software development. This method does not only focus on project management like other methods and frameworks do, but also focuses on how teams actually build code. Like Scrum, it has practices and values that help teams get into an effective mindset. One of the primary practices of XP is pair programming through which coding process is conducted by two developers working together at a single computer. While one member works on coding, the second member checks the quality of the coding made by the first member. Another unique XP practice is the coding the unit test first. Before writing the code, a unit test is created so that new codes are automatically tested.

12.3.5 SAFe® (Scaled Agile Framework)

The SAFe is the most common scaling framework according to the 15th State of Agile Report published in 2021. Thirty-seven percent of respondents indicated that their organization applies SAFe while 9% uses scrum of scrums and 6% uses enterprise scrum. The SAFe focuses on providing a knowledge base of patterns for scaling development work across all levels of the enterprise (Figure 12.6). It also focuses on detailing practices, roles, and activities at the portfolio, program, and team levels. SAFe organizes the enterprise around value streams that focus on providing continuous value to the customer.

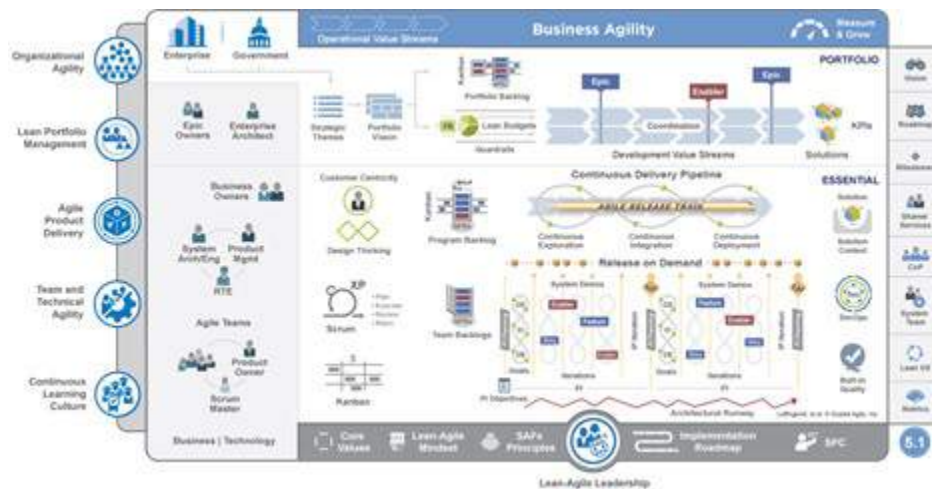

Figure 12.6: SAFe 5 for Lean Enterprises

(Retrieved from <https://www.scaledagileframework.com/>)

Project Management Institute. (2017). Agile Practice Guide. Project Management Institute.

Retrieved from <https://kanbanize.com/kanban-resources/getting-started/what-is-kanban>.

Project Management Institute. (2017). Agile Practice Guide. Project Management Institute.

Retrieved from <https://www.agilealliance.org/glossary/xp/>.

Retrieved from <http://www.extremeprogramming.org/rules/pair.html>.

Retrieved from <http://www.extremeprogramming.org/rules/testfirst.html>.

Digital.ai. (2021). 15th State of Agile Report.

<https://digital.ai/resource-center/analyst-reports/state-of-agile-report>

Project Management Institute. (2017). Agile Practice Guide. Project Management Institute.

12.4 Recent Trends in Agile Project Management

Organizations, whether they are multinational corporations, non-profits, government agencies, or international organizations, often make use of agile project methods and frameworks. Although agile started with the software development projects (see Section 12.1), its utilization has become common in other IT projects, and eventually non-IT projects such as new product development projects have practiced agile methods increasingly. A survey conducted by PMI (Project Management Institute) found that 23% of the organizations worldwide utilized agile techniques whereas 47% used predictive approach. However, another 23% also used hybrid approaches (e.g., using waterfall's sequential and linear project life cycle stages while establishing a more frequent communication and feedback system with the client and stakeholders).

A recent study is the 15th State of Agile Report conducted in 2021 by digital.ai. Their data is up-to-date and reflect the impact of COVID-19 pandemic. Their sample is dominantly composed of people who work in agile teams or in organizations which implement agile approach. This report highlights salient insights from the practice as detailed below:

- The most popular agile approach is Scrum. 66% of the respondents identified Scrum as the methodology they follow most closely. Besides, 9% indicated that they use ScrumBan and 6% blends the Scrum with XP. Therefore, Scrum's share is 81% in total.
- The most popular scaling approach is SAFe with 37%. SAFe was followed by Scrum@Scale / Scrum of Scrums (9%) and Enterprise Scrum (6%).
- The top five agile techniques and practices used by the organizations are daily standups (87%), retrospectives (83%), sprint/iteration planning (83%), sprint/iteration reviews (81%), and short iterations (63%).
- The top five agile planning and delivery tools are Kanban boards (77%), taskboards (67%) spreadsheets (66%), agile project management tools (64%), and bug trackers (62%).
- The top five reasons to adopt agile are "enhance ability to manage changing priorities", "accelerate software delivery", "increase team productivity", "improve business and IT alignment", and "enhance software quality".
- The top five challenges in organizations regarding agile practices are "inconsistent processes and practices across teams", "organizational culture at odds with agile values", "general organization resistance to change", "lack of skills/experience with agile methods", and "not enough leadership participation".
- Eighty-one percent of the respondents recommended Jira as a software tool in agile planning and management. Jira was followed by Digital.ai agility (formerly VersionOne) and Azure DevOps. Thirty-five percent recommended Microsoft Project.

Digital.ai. (2021). 15th State of Agile Report.

<https://digital.ai/resource-center/analyst-reports/state-of-agile-report>

12.5 Key Takeaways

Key Takeaways

- Agile project management approach has been utilized by project teams since 1990s when it started to emerge among software developers.
- In 2001, agile practitioners published a manifesto named “Manifesto for agile software development” that put forward a set of guiding principles for agile project management.
- Agile manifesto highlights the importance of “individuals and interactions”, “working software”, “customer collaboration”, and “responding to change” to distinguish itself with the traditional waterfall project management approach.
- While waterfall approach is linear and sequential, agile approach compresses the sequential phases in small timeboxes (iterations) to create increments at the end of each timebox.
- There main agile roles are cross-functional teams and their members, product owners, and team facilitators.
- Common agile practices are team charter, user stories and backlog, planning of each iteration or cycle, daily standups. demonstration or reviews, retrospectives, and backlog refinement.
- The structure of a user story is generally in a format as follows: As a “user/stakeholder”, I want to “perform a function / an action / an app feature” so that I can “acquire a benefit / an expected outcome”.
- The Agile Practice Guide by PMI (Project Management Institute) lists the single-team agile methods as Scrum, Extreme Programming (XP), Kanban, Crystal methods, Scrumban, Feature-Driven Development (FDD), Dynamic Systems Development Method (DSDM), and Agile Unified Process (AgileUP).
- The SAFe® (Scaled Agile Framework) is the most common scaling framework according to the 15th State of Agile Report published in 2021. It focuses on providing a knowledge base of patterns for scaling development work across all levels of the enterprise.

12.6 Questions and Exercises

There are 10 questions for this chapter. As you submit each answer, you will get immediate feedback and be taken to the next question.

An interactive or media element has been excluded from this version of the text. You can view it online here:

<https://pressbooks.ulib.csuohio.edu/project-management-navigating-the-complexity/?p=1238>

12.7 Attribution

This chapter is a derivative of the following texts:

1. [Project Management by Adrienne Watt](#). © [CC BY \(Attribution\)](#).
2. [Project Management from Simple to Complex](#). © [CC BY \(Attribution\)](#).
3. [Project Management by Florence Daddey](#). © [CC BY \(Attribution\)](#).
4. [Project Management Fundamentals by Shelly Morris](#). © [CC BY \(Attribution\)](#).
5. [Project Management by Merrie Barron and Andrew R. Barron](#). © [CC BY \(Attribution\)](#).
6. [Principles of Management](#) © [CC BY \(Attribution\)](#).

Chapter 13. Closing the Project

13.0 Learning Objectives and Overview

Learning Objective

1. Explain the importance and benefits of the project closure.
2. Elaborate on the activities conducted by the project team while closing a project.
3. Explain the post-implementation review.
4. Describe how the benefits realization is monitored and validated following the closing phase of a project.

Overview

As discussed in Chapter 1 “Introduction to Project Management”, projects are temporary. They have a definite beginning and ending date. Projects finish when their unique outcomes (i.e., results, deliverables) are produced and become available for the client and its end users as well as the customers to use. Once the project deliverables are approved by the internal or external client (or an inspection and acceptance committee), the project manager can start the closing phase. Although closing a project might seem easier compared with the implementation phase, this process still requires delicate attention as detailed in the following sections.

13.1 Closing the Project

All projects end. Some of them are completed successfully when their triple constraints are within the acceptable ranges (e.g., budget is overrun by 7% when the range is 10%), project objectives are accomplished, and the stakeholders, in particular the client, are happy with the outcome. However, as discussed in Chapter 1 (see 1.4 Project Success), it is not uncommon for many projects to underperform due to various factors such as scope creep (i.e., uncontrolled expansion of product requirements and project activities), schedule delays, budget overruns, and miscommunication with stakeholders, or to fail that leads to early termination. In both cases, whether they are successful or not, projects need to be closed. Therefore, project managers must lead the process to formally close the project. This process helps project managers, teams, project sponsors, and internal and external stakeholders evaluate the project performance, and assess what went right and wrong. Figure 13.1, which is originally available in Chapter 1, exhibits the project life cycle if the project follows all the phases, and can make it to the end of the project by producing the deliverables.

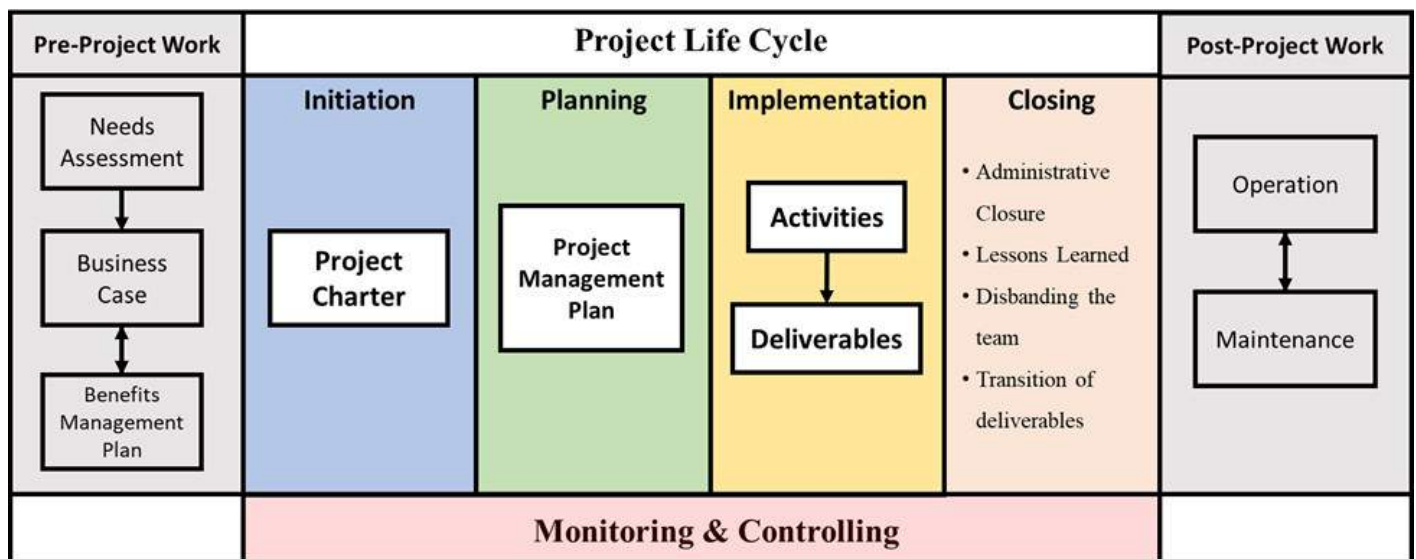

Figure 13.1: Project Life Cycle Phases (including the pre-project and post-project works)

Project completion is often the most neglected phase of the project life cycle. Once the project is over, it's easy to pack things up, throw some files in a drawer, and start moving right into the initiation phase of the next project. Hold on. We are not done yet. When closing the project, the project manager reviews the project management plan to ensure that all project work is completed and that the project has met its objectives. It is of high importance here to highlight that project closure cannot start unless the deliverables (e.g., a new mobile application for online shopping, a new data center for an insurance company, a newly developed diabetics medication, an apartment complex that is ready to accept new tenants, an improved business process, etc.) are ready to use. Therefore, the implementation phase in the project life cycle is completed with the acceptance of these deliverables (Figure 13.1) and signals

that it is time to close the project.

13.1.1 Case Study: Closing out the Grocery LLC's M-Commerce Project

Grocery LLC's M-Commerce Project started on May 2, 2022, and the deployment was completed on November 3, 2022. The mobile app was subject to alpha testing first. Then, beta testing was carried out during the "Pilot" phase, where customers installed the beta version on their smartphones and did their online shopping. During the implementation of the beta version, all the feedback from customers and their mobile devices was evaluated and the bugs and problems were corrected. The inspection and acceptance committee was composed of Grocery LLC's three representatives from the IT department, two representatives from the Operations department, and two store managers. The committee checked the final version and didn't find a problem that may hinder the launch of the mobile app. The sponsor approved the sign-off after they received the inspection and acceptance report. Finally, the mobile app was introduced to Android and Apple online stores and is ready to use by online customers. Now, customers can log in with their usernames and passwords, browse items, add them to their carts, proceed to checkout, and complete their payments. We can start the closing phase since the deployment has been completed. As seen in Figure 13.2, "Closeout & Project Implementation Review" can start as the deployment is completed.

M-Commerce Project Phases (Mobile App)

Initiation	Planning	Implementation	Closing
<ul style="list-style-type: none"> • Initiation and Scope (including the preparation of project charter, and approval of the charter by the sponsor) 	<ul style="list-style-type: none"> • Analysis/App Requirements • Design (finishes with the activity "Finalize Project Management Plan") 	<ul style="list-style-type: none"> • Development • Testing • Training Materials • Documentation • Pilot • Deployment 	<ul style="list-style-type: none"> • Closeout & Post Implementation Review

Figure 13.2: Project Life Cycle Phases of M-Commerce Project

The project's closeout activities are given in Table 13.1.

Table 13.1: Closeout Activities of Grocery LLC's M-Commerce Project

WBS Number	Activity & Pot Implementation
10	Closeout & Post Implementation Review
10.1	Document lessons learned
10.2	Archive all documents
10.3	Complete all pending payments
10.4	Final meeting with stakeholders to close the project
10.5	Disband the team

We will refer to this case study in the following sections when needed.

13.1.2 Key Activities to Consider while Closing the Project

The key activities when we close out the project can be listed below:

1. Ensuring that all tasks are completed, and the deliverables have been checked and approved by the client (or its inspection and acceptance committee).
2. Collecting project reports and documents and making sure that all project documents and deliverables are up-to-date.
3. Making sure that all issues (e.g., disputes with vendors, conflict with stakeholders, legal issues, issues in compliance with standards) are resolved.
4. Ensuring that all costs are charged to the project.
5. Releasing the final deliverables to the project sponsor, the internal and external client, and appropriate stakeholders.
6. Disseminating information to all the stakeholders to formalize acceptance of the project, and its deliverables (products or services).
7. Notifying all the stakeholders of the project completion.
8. Terminating supplier and vendor contracts.
9. Consulting with the legal department to ensure that there are not and won't be any legal issues that may result from the contracts and legally binding documents.
10. Releasing project resources (e.g., team members, facilities, equipment, materials).
11. Conducting a post-implementation review including a discussion about the lessons learned.
12. Finishing the paperwork, archiving, and storing all the project information including the lessons learned document in an organizational repository.
13. Ensuring that all the project information can be accessed easily (e.g., cloud storage, physical files) by the current project team and future project managers and teams.

Project Management Institute. (2017). A guide to the Project Management Body of Knowledge (PMBOK guide) (6th ed.). Project Management Institute.

13.2 Activities to Close a Project

The following sub-sections elaborate on the activities to close a project.

13.2.1 Ending the Implementation Phase

After we ensure that all the project activities are completed and the deliveries have been accepted by the client (the product owner and end users), we can start the activities to close the project. Once the project activities are completed in the implementation phase, we need to request the project sponsor to initiate a formal acceptance process through which the internal or external client (or the inspection/acceptance committee) is involved. They're interested in knowing if the product or service of the project meets the objectives the project set out to accomplish. If our documentation is up-to-date, we will have the project results at hand to share with them.

In this phase, it is also of high importance to make sure that the implementation phase covered the post-project work composed of operation and maintenance. The project manager should ask the questions below to make sure that the project deliverables can be maintained and supported effectively after the deliverables are handed over to the client.

Let's consider the questions below for our m-commerce project:

- Does the vendor offer 24/7/365 support for the mobile app? Are the rates for such support acceptable to the client?
- Has a formal service level agreement been developed and put into effect between the organization and vendor to maintain continued support and service?
- What provisions have been made for future upgrades and enhancements of the mobile app?
- Does the necessary cloud capacity and storage exist for the future expansion of the system?
- Has Grocery LLC's IT support staff been trained in supporting the technology? Can they resolve technical issues, or are they able to contact the vendor or third-party suppliers for further support?
- Has the help desk staff been trained to identify and log calls from users of the solution?
- Is the help desk number clearly displayed on the mobile app, so our in-store shoppers and customers know whom to contact?
- Has the project manager provided the help desk with a script of possible problems that users of the new solution could encounter?

13.2.2 Contract Closure

Contracts come to a close just as projects come to a close. Contracts are different from project charters and project management plans (Figure 13.3). They are legally binding documents with the client and the contractors or subcontractors. If the client is internal which means that it is a functional unit of our organization, we won't need a contract. In this case, the project charter and the plans will act as formal documents that keep the project sponsor and the project manager accountable.

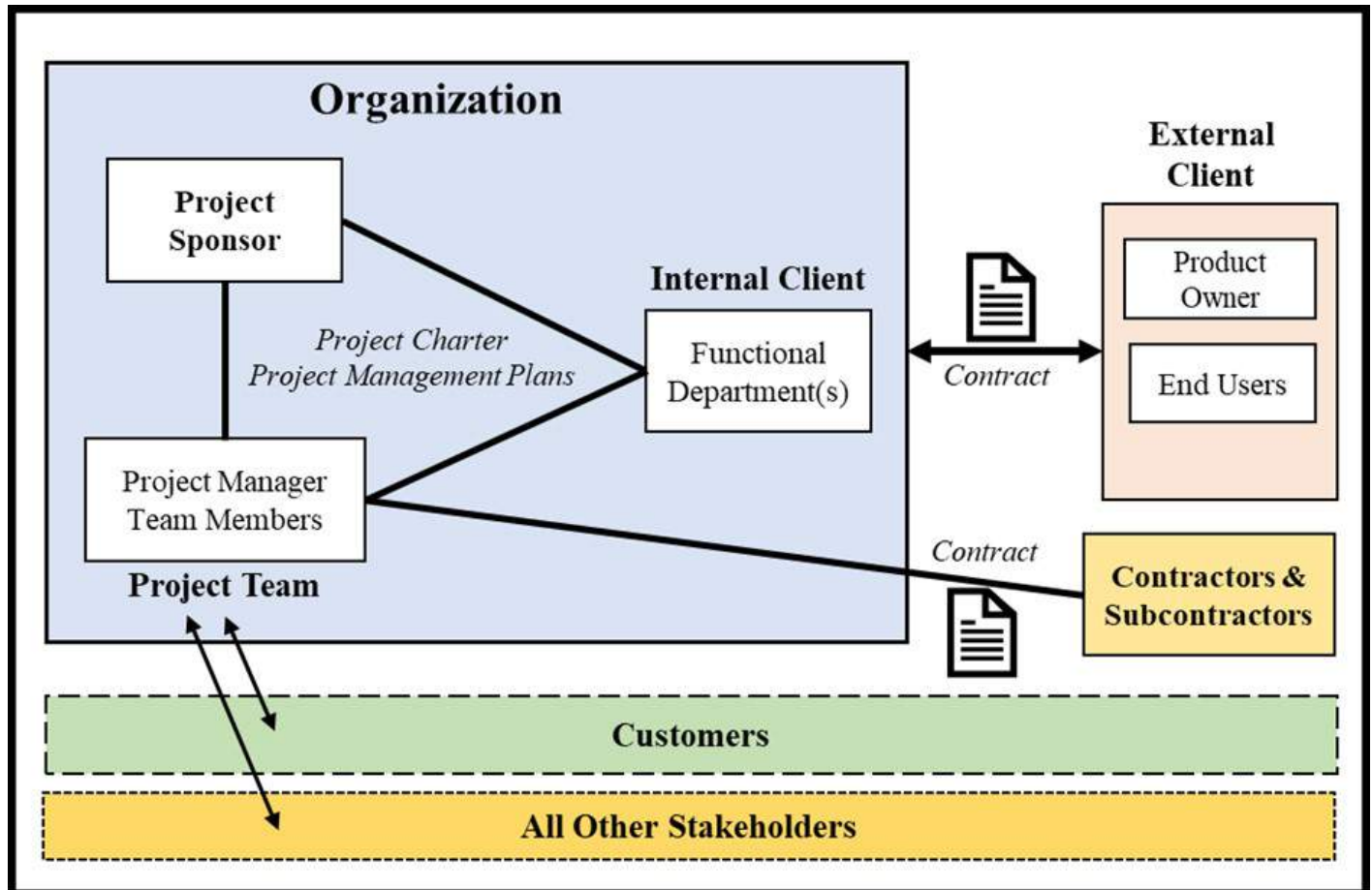

Figure 13.3: The Relationships Among the Project Sponsor, Project Manager, Internal and External Clients, Customers, and Stakeholders

Contractors and subcontractors may be still present if some project activities or the overall project is outsourced to them. Therefore, not all projects require a contract closure process. Contract closure is concerned with completing and settling the terms of the contracts. In M-Commerce Project, as mentioned in Chapter 11, we outsourced the development component to a software company. We assumed that we need to pay \$2,000 for each phase. Total cost baseline for all ten activities was \$20,000 (\$2,000 x 10). Therefore, our planned value was \$20,000. When we finished five activities, the actual cost was \$11,200. When closing the contracts, we should pay attention to the actual costs and the terms and conditions of the contract. The project manager should ask questions such as "Did the contractor finish all the activities and meet the requirements as indicated in the contract?", "Are all the

cost calculations correct?”, “Did we make all the payments?”, and “Do we need to wait for a while to make some payments as stipulated in the contract?”

The contract closure process supports the project completion process because it determines if the work described in the contracts was completed accurately and satisfactorily. Obviously, this process applies only to those phases, deliverables, or portions of the project that were performed under the contract. Contract closure updates the project records, detailing the final results of the work on the project. Contracts may have specific terms or conditions for completion. We should be aware of these terms or conditions so that project completion isn't held up because we missed an important detail. If we are administering the contract ourselves, we should be sure to ask our procurement department if there are any special conditions that we should be aware of so that the project team doesn't inadvertently delay contract project closure.

One of the purposes of the contract closure process is to provide formal notice to the seller, usually in written form, that the deliverables are acceptable and satisfactory or have been rejected. If the product or service does not meet the expectations, the vendor will need to correct the problems before we issue a formal acceptance notice. Before the contract is closed, any minor items that need to be repaired or completed are placed on a punch list, which is a list of all the items found by the client or team, or manager that still remain to be done. Hopefully, quality audits have been performed during the project, and the vendor was allowed to make corrections earlier in the process than the closing phase. It's not a good idea to wait until the very end of the project and then spring all the problems and issues on the vendor at once. It's much more efficient to discuss problems with the vendor as the project progresses because it provides the opportunity for correction when the problems occur.

The project team will then work on all of the items on the punch list, building a small schedule to complete the remaining work. If the number of items on the punch list is too large or the amount of work is significant, the project team continues to work on the project. Once the punch list becomes smaller, the project manager begins closing down the project, maintaining only enough staff and equipment to support the team that is working on the punch list.

If the product or service does meet the project's expectations and is acceptable, formal written notice to the seller is required, indicating that the contract is complete. This is the formal acceptance and closure of the contract. It's the project manager's responsibility to document the formal acceptance of the contract. Many times, the provisions for formalizing acceptance and closing the contract are spelled out in the contract itself.

If we have a procurement department handling the contract administration, they will expect us to inform them when the contract is complete and will in turn follow the formal procedures to let the seller know the contract is complete. However, we will still note the contract completion in our copy of the project records.

13.2.3 Disbanding the Project Team and Reassigning All Project Resources

Project managers need to consider in an earlier stage what project team members would do after the project ends. If they are the employees of our organization, project managers should provide sufficient and early notification to the team members to relieve them of future concerns. They may go back to their functional departments to continue with their operational tasks or get assigned to a new project. If the organization has a Project Management Office (PMO), and these members work at this PMO, they will continue working on other projects. Project managers should keep their managers, or other project managers, informed as the project gets closer to completion, so that they have time to adequately plan for the return to their departments or transfer to other projects. Project managers should let them know a few months ahead of time what the schedule looks like and how soon they can plan on using the team members on new projects. This gives the other managers the ability to start planning activities and scheduling activity dates.

Besides the team members, we also need to consider other resources such as physical resources, facilities, materials, and equipment used by the team. If there are unused materials that cannot be returned to the supplier, and also consumables, they can be transferred to other projects or relevant departments so that they can use them and save some money. If the project team used office space, a manufacturing facility, or a lab, the facilities department of the organization must be notified. Timely notifications would help the organization plan in advance for the utilization of these resources by other projects and units, or if they need to be sold or released.

13.2.4 Final Payments

The final payments are usually more than a simple percentage of the work that remains to be completed. Completing the project might involve fixing the most difficult problems that are disproportionately expensive to solve, so the final payment should be large enough to motivate the vendor to give the project a high priority so that the project can be completed on time.

If the contractors, subcontractors, suppliers, and vendors have met all the contractual obligations, including fixing problems and making repairs as noted on a punch list, which lists the work that doesn't conform to contract specifications, the project team signs off on the contract and submits it to the accounting department for final payment. They are notified that the last payment is final and completes the contractual agreement with the project. Besides, the performance of suppliers and vendors is reviewed to determine if they should still be included in the list of qualified suppliers or vendors.

In some cases, there may be a provisional acceptance instead of a final acceptance. Thus, the final acceptance may take place later (e.g., one year after the provisional acceptance). A small amount of payment may be held for the final acceptance. Or the contract may contain fines in case of problems that may occur until the final acceptance.

13.2.5 Administrative Closure & Archiving of Project Documents

The project manager must ensure that all the administrative tasks required to close the project have been completed. Thus, the project manager can use a checklist as shown in Table 13.2.

Table 13.2: A Checklist for the Administrative Closure

Item	Completed
Project Team	
• Performance reports shared with functional managers	
• One-on-one debriefs completed	
• Coaching plans updated	
• Resources released to functional units and/or other projects	
• Project completion party completed	
Project documents	
• All inspection and acceptance reports received	
• Lessons learned report filed, uploaded to the online repository for the access of all project teams	
• Contract closure completed	
• Final project report completed	
• All project documents archived	
Project manager	
• Wrap-up meeting with the sponsor, client, key stakeholders, etc. completed	
• Personal development plan updated	

The following are some of the project documents that are archived:

- Business case, needs assessment, and project benefits management plan
- Project charter
- Project management plan and its sub-plans (e.g., plans for scope, requirements, schedule, cost, quality, resources, communication, risks, procurement, stakeholders, change, and configuration)
- Scope, schedule, and cost baselines

- Basis of estimates
- Team charter
- Risk register
- Issue log
- Quality reports
- Test and evaluation documents
- Inspection and acceptance reports
- All financial documents (e.g., pay stubs, invoices)
- Lessons learned register
- Final project report

The documents associated with the project must be stored in a safe location where they can be retrieved for future reference. Signed contracts or other documents that might be used in tax reviews or lawsuits must be stored. Organizations have legal document storage and retrieval policies that apply to project documents and must be followed. Generally, organizations and Project Management Offices (PMOs) store all the project documents in an electronic folder and/or a software program.

Care should be taken to store documents in a form that can be recovered easily. If the documents are stored electronically, standard naming conventions should be used so documents can be sorted and grouped by name. If documents are stored in paper form, the expiration date of the documents should be determined so they can be destroyed at some point in the future.

13.2.6 Sample Sponsor Project Closure Letter

A sample letter a project sponsor can write has been provided below:

Dear <Salutation>,

Thank you for allowing us the honor of working on <Project X>. We found working with both yourself and your organization to be a fruitful experience and are pleased to present the following results:

- The successful outcome of <Project X>
 - <Deliverable 1>
 - <Deliverable 2>
 - <Deliverable 3>
- The expected delivery date of <MM/DD/YYYY> was met
- The project came in at <percent over/under budget>
- Surveyed stakeholder approval was <#> out of <#>

At this time, we consider <Project X> to be completed and are submitting our final invoice for \$<XX,XXX> to your accounts receivable department under your purchase order number <P.O. Number>. Your help in securing payment for our services will be appreciated.

Additionally, during the project, we identified the following potential opportunities for your review:

- <Improvement A>
- <Improvement B>
- <Improvement C>

Should you be interested in pursuing any of these options and/or additional opportunities, please consider utilizing our organization so we can leverage our skills and experience with you. Again, thank you for selecting us to work on your project. If you have any questions or comments, please do not hesitate to contact me.

Sincerely,

Project Sponsor

ProjectManagement.com. (n.d). Checklist for Support After Project Closure. Retrieved from <https://www.projectmanagement.com/checklists/216024/checklist-for-support-after-project-closure>

Jordan, A. (n.d.). Project Closure Report. Retrieved from <https://www.projectmanagement.com/deliverables/286683/project-closure-report>

ProjectManagement.com. (n.d). Sponsor Project Closure Letter. Retrieved from <https://www.projectmanagement.com/deliverables/173276/sponsor-project-closure-letter>

13.3 Post Implementation Reviews and Archiving Documents

13.3.1 Lessons Learned

Regular reviews are made during the project in the presence of team members and other stakeholders if needed. These reviews help the project manager and the team review the current situation, determine if there is a need to revise the project documents and plans, and take timely actions to prevent any problems that may occur later in the project. After the implementation of project activities is finalized and the deliverables are inspected and accepted by the client, the project team reviews all the documents and meets to discuss what went well and wrong during the project, and what could have been done to avoid the problems that occurred. It is of great importance to remember here that the lesson learned process doesn't start in the close-out phase. As can be recalled from Figure 13.4 (also see Chapter 1), the closing process starts before the closing phase of the project life cycle starts. The project team has already produced many documents, reports, logs, and registers, and they have been edited and numerous new records have been added in parallel with project activities in the implementation phase. Therefore, some aspects of the closing process such as keeping the lessons learned register can start during the implementation when the project team learns from their experience and add them into the lessons learned register after a thorough discussion and assessment.

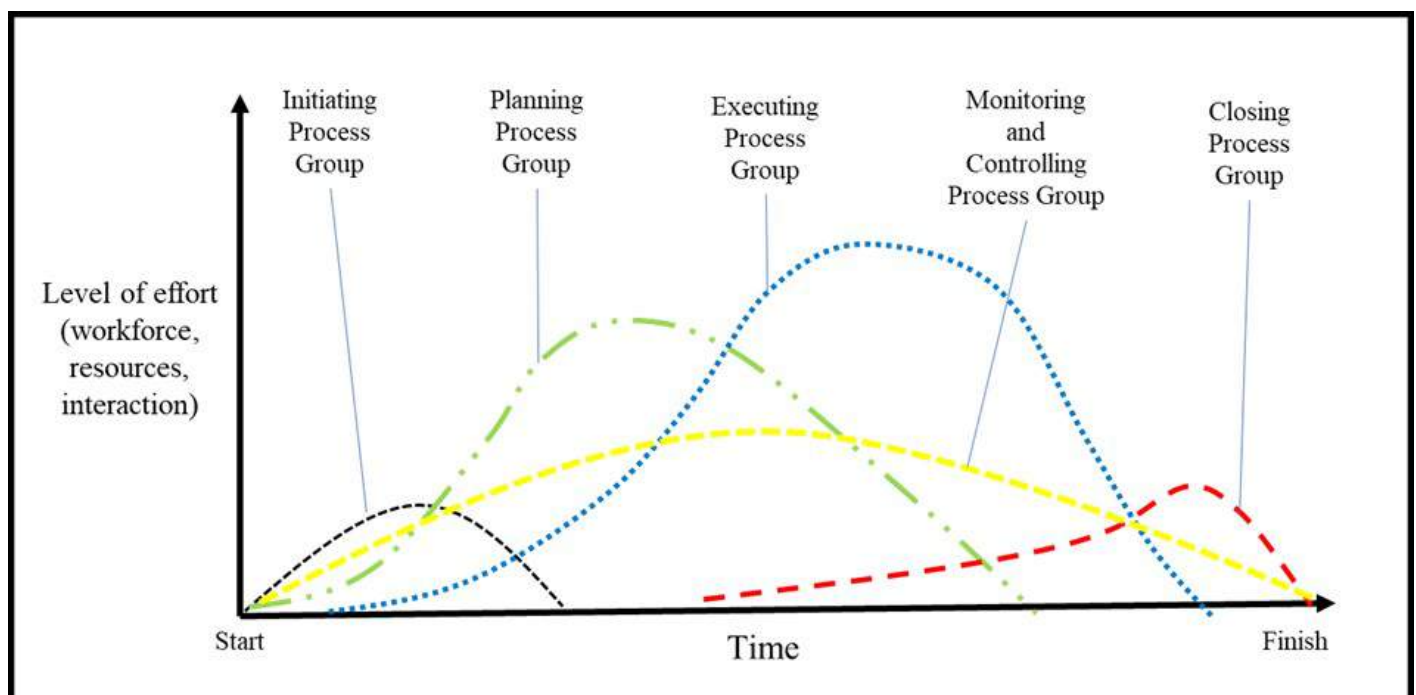

Figure 13.4 Project Management Process Groups (Adapted from PMBOK Guide 6th Edition) (Have you gotten permission from PMI to use this graph?)

If the project is considered a success, the discussion can center on why the project was successful and the challenges that had to be overcome in order to achieve success. Lessons learned meetings are often quite enjoyable when the project was successful. If the project was unsuccessful, the conversation centers on the causes of failure. Table 13.3 provides two lessons from the M-Commerce project.

Table 13.3: Lessons Learned Register for M-Commerce Project

Lessons Learned	Recommendation for Future Projects
<p>Although our Risk Register identified a risk stating that “Cost estimates may be exceeded considering the factors of inflation and foreign exchange currency rates.” the risk trigger was indicated as “If the CPI (cost performance index) drops below 0.90, we will need to seek additional funding from management.”, the Systems Analyst 1 did not notify the project manager and the team of the problem when CPI decreased to 85%. An unexpected spike in the inflation rate in the USA increased the activity costs.</p>	<p>In future projects, it is of high importance to determine the risk owner as the project manager, not another member. Besides, a second person can be assigned to assist the project manager.</p>
<p>Our mobile app had serious issues regarding the bugs, and the app stores notified us of the deficiencies in the field of privacy. The developers and testers didn’t respond on time.</p>	<p>In future projects, in the recruitment process, the developers and testers should be asked to include their experience in previous mobile app projects in detail in their job applications. A minimum of three years of experience should be required. Besides, they should explain how they solved problems.</p>

Many project leaders request external facilitation in this situation so they can fully participate in the discussions. In addition, an external facilitator can help ensure the conversations remain objective and avoid tones of blame. A common approach is to identify, all in the context of the project’s objectives, what should be continued, what should be started, and what should be stopped. This is often referred to as the start/stop/continue approach.

Quality management is a process of continual improvement that includes learning from past projects and making changes to improve the next project. This process is documented as evidence that quality management practices are in use. Some organizations have formal procedures for changing work processes and integrating the lessons learned from the project so future projects can benefit. Some organizations are less formal in the approach and expect individuals to learn from the experience, take the experience to their next project, and share what they learned with others in an informal way.

13.3.2 Trust and Alignment Effectiveness

The project leadership reviews the effect of trust—or lack of trust—on the project and the effectiveness of alignment meetings in building trust. The team determines which problems might have been foreseen and mitigated and which ones could not have been reasonably predicted. Project stakeholder register, change log, issue log, and risk register can help the team in this assessment. Other questions that can be asked in this assessment are:

- What were the cues that were missed by the team that indicated a problem was emerging?
- What could the team have done to better predict and prevent trust issues?

13.3.3 Schedule and Budget Management

The original schedule of activities and the network diagram is compared to the actual schedule of events. Earned Value Management (EVM) tools can help the team a lot while making this comparison (see Chapter 11). Events that caused changes to the schedule are reviewed to see how the use of contingency reserves and slacks (floats) mitigated the disruption caused by those events. The original estimates of contingency time are reviewed to determine if they were adequate and if the estimates of duration and float were accurate. These activities are necessary for the project team to develop expertise in estimating schedule elements in future projects—they are not used to place blame. As discussed in Chapter 7, this can be significantly helpful in analogous estimating of activity durations in future projects. Besides, a review of budget estimates for the cost of work scheduled is compared to the actual costs. If the estimates are frequently different from the actual costs, the choice of estimating method is reviewed. In a similar vein, the results of the budget review would be an important input to future projects through analogous estimating (see Chapter 9). In this analysis, EVM is again an effective tool to compare the earned value to the actual cost.

13.3.4 Risk Response Strategies

After the project is finished, the estimates of risk can be reviewed and compared to the events that actually took place. The risk register, qualitative and quantitative risk assessment tools, risk response strategies, issue log, and stakeholder register will be of significant help to the project team to conduct this review. The following questions can help the team assess the risk management process during the project:

1. Did the risks identified in the planning phase occur?
2. If an identified risk occurred, was the response strategy sufficient to deal with the risk? Was the contingency reserve sufficient?
3. Did events occur that were unforeseen (e.g., unknown unknowns)?
4. What cues and triggers existed that may have allowed the team to predict these events?
5. Was the management reserve sufficient to cover unforeseen risks?

Let's assume that, in our M-Commerce Project, the second risk with the ID number 2.2 in Table 10.2 "An Example of a Risk Register" occurred (Table 13.4). Systems Analyst 2 (SA2) monitored the risk effectively, and checked with Developer 1 if they can work on the five activities under "2. Analysis/App Requirements". Developer 1 notified SA2 of their absence. Therefore, SA2 asked Developer 2 to attend the activities. While the hourly rate of Developer 1 was \$35, Developer 2 asked for \$45. This caused an additional cost of \$1,840. However, as can be recalled from Chapter 9 and the second question above, contingency reserve can be allocated in the budget within the cost baseline if the response strategy requires additional funds to deal with the risks. In this case, let's consider that the project team included a \$2,000 contingency reserve to cover the absence of Developer 1 (Table 13.5). Thus, this

contingency reserve was sufficient, and it didn't hurt the project. Eventually, this situation is recorded as a lesson learned.

Table 13.4: Risk 2.2 of M-Commerce Project

ID	Related WBS Activity	Description	Risk Owner	Risk Trigger	Contingency Reserve
2.2	2.1 2.2 2.3 2.4 2.5	The demand for developers increased recently since the demand for online games and mobile apps has been on a sharp rise after the emergence of the COVID-19 pandemic. We may experience a shortage of developers in the market.	Systems Analyst 2	Ten days before the "Analysis/App Requirements" component starts, we must assure that Developer 1 starts working on project activities.	\$2,000

Table 13.5: Costs of "Analysis/App Requirements" Stage of M-Commerce Project

WBS	Activity Name	Duration	Cost
2	Analysis/App Requirements	29 days	\$31,960.00
2.1	Review needs analysis based on the business case	3 days	\$2,760.00
2.2	Elicit requirements from stakeholders	10 days	\$10,000.00
2.3	Draft preliminary stakeholder specifications	5 days	\$5,000.00
2.4	Review specifications with team and stakeholders	5 days	\$8,600.00
2.5	Incorporate feedback on the specifications	3 days	\$2,160.00
2.6	Develop a preliminary budget and delivery timeline	2 days	\$1,440.00
2.7	Obtain approvals to proceed (concept, timeline, budget, resources)	1 days	\$0.00
2.8	Analysis complete (Milestone)	0 days	\$0.00
	Contingency Reserve		\$2,000

13.3.5 Client and Stakeholder Satisfaction

Relationships with the client are reviewed by the team and the relevant internal stakeholders such as the project sponsor, project steering committee, and functional departments. In the meetings held with the client, they are given the opportunity to express satisfaction and identify areas in which project communication and other factors could be improved. Often a senior manager from the organization interviews the client to develop feedback on the project team's performance. An internal or external audit also helps the team and the organization evaluate the relationships with the client and stakeholders, and assess the overall satisfaction of the client.

A general report that provides an overview of the project is created to provide stakeholders with a summary of the project. The report includes the original goals and objectives and statements that show how the project met those goals and objectives. Performance on the schedule and budget are summarized and an assessment of client satisfaction is provided.

This report is also submitted to the senior management as an executive summary containing all the information provided to the stakeholders. The report identifies practices and processes that could be improved or lessons that were learned that could be useful for future projects.

13.4 Validating the Realization of Business Benefits

All projects are initiated as a way to create value for the organization. This value may be expressed in many different ways. For instance, it can be a tangible benefit such as incremental sales associated with launching a new product or service, or an intangible benefit such as increased employee satisfaction associated with introducing time-saving technology. Further, the project may result in streamlining business processes, which will ultimately result in less staff required to complete the work. There are many more possibilities.

Many organizations create a business benefits realization plan, whereas other organizations include the business benefits realization approach as part of their project management plan. Either way, the following should be considered:

1. What are the benefits? In stating the benefits, the SMART principle should be used (see Chapter 2).
2. How will the business benefits be tracked? This should be a consideration during solution design as it may be necessary to create the mechanisms for the collection of the required information.
3. Who is accountable for tracking and communicating the business benefits?
4. Who is accountable for taking the appropriate actions to realize the business benefits? For instance, in projects involving productivity improvements, if the business benefits involve the release of staff, who will be accountable for making this happen?
5. When are the business benefits expected to be fully realized?

13.5 Key Takeaways

Key Takeaways

- Projects finish when their unique outcomes (i.e., results, deliverables) are produced, and become available for the client and/or customers to use. Some projects are completed successfully, but it is not uncommon to see that many projects fail. In both cases, projects need to be closed, and the activities and procedures must be carried out in the closing phase.
- When closing the project, the project manager reviews the project management plan to ensure that all project work is completed and that the project has met its objectives.
- Once the project outcomes are documented, the project manager needs to request formal acceptance from the client (or the inspection/acceptance committee).
- The contract closure process supports the project completion process because it determines if the work described in the contracts was completed accurately and satisfactorily. One of the purposes of the contract closure process is to provide formal notice to the seller, usually in written form, that the deliverables are acceptable and satisfactory or have been rejected.
- Disbanding the project team and reassigning team members should be finalized in the closeout phase. Besides, project managers deal with releasing other resources such as physical resources, facilities, materials, and equipment used by the team.
- The documents associated with the project must be stored in a safe location where they can be retrieved for future reference.
- After the implementation of project activities is finalized and the deliverables are inspected and accepted by the client, the project team reviews all the documents and meets to discuss what went well and wrong during the project, and what could have been done to avoid the problems that occurred. This leads to the finalization of a lesson learned register.
- Post-implementation reviews include the lesson learned process, reviewing trust and alignment effectiveness, evaluating the schedule and budget management by utilizing various tools such as EVM, reviewing the risks, strategies, and responses, discussing client and stakeholder satisfaction, and producing a final report for the client, senior management, and other stakeholders.
- The performance of the project outcomes is monitored according to the benefits realization plan.

13.6 Questions and Exercises

There are 3 questions for this chapter. As you submit each answer, you will get immediate feedback and be taken to the next question.

An interactive or media element has been excluded from this version of the text. You can view it online here:

<https://pressbooks.ulib.csuohio.edu/project-management-navigating-the-complexity/?p=1257>

13.7 Attribution

This chapter is a derivative of the following texts:

1. [Project Management by Adrienne Watt](#). © [CC BY \(Attribution\)](#).
2. [Project Management from Simple to Complex](#). © [CC BY \(Attribution\)](#).
3. [Project Management by Florence Daddey](#). © [CC BY \(Attribution\)](#).
4. [Project Management Fundamentals by Shelly Morris](#). © [CC BY \(Attribution\)](#).
5. [Project Management by Merrie Barron and Andrew R. Barron](#). © [CC BY \(Attribution\)](#).
6. [Principles of Management](#) © [CC BY \(Attribution\)](#).

About the Author

Abdullah Oguz is an Assistant Professor of Management Information Systems in the School of Business at Central Connecticut State University. He was a visiting lecturer at the Monte Ahuja College of Business, Cleveland State University. Abdullah has a Ph.D. in Information Systems from the University of North Carolina Greensboro. Prior to that, he worked as a senior member of the Projects and Technical Systems Department of the Turkish Customs Administration. His research interests include workplace cyberbullying, cybersecurity, societal implications of big data analytics, and the effects of IT use on social well-being. His research has been published in the Journal of the Association for Information Systems and presented at the ICIS 2019 Doctoral Consortium in Munich, Germany. Abdullah received the Best Reviewer Award at the 2017 Americas Conference on Information Systems (AMCIS), held in Boston, USA.