

47 cm

217 cm

44 cm

# 30 PLANOS

# MUEBLES MODERNOS

117 cm

42.5 cm

42.5 cm

10.5 cm

40 cm

150 cm

10 cm

12 cm

53 cm

17 cm

40 cm

39 cm

12 cm

31 cm

# Mueble Moderno #01

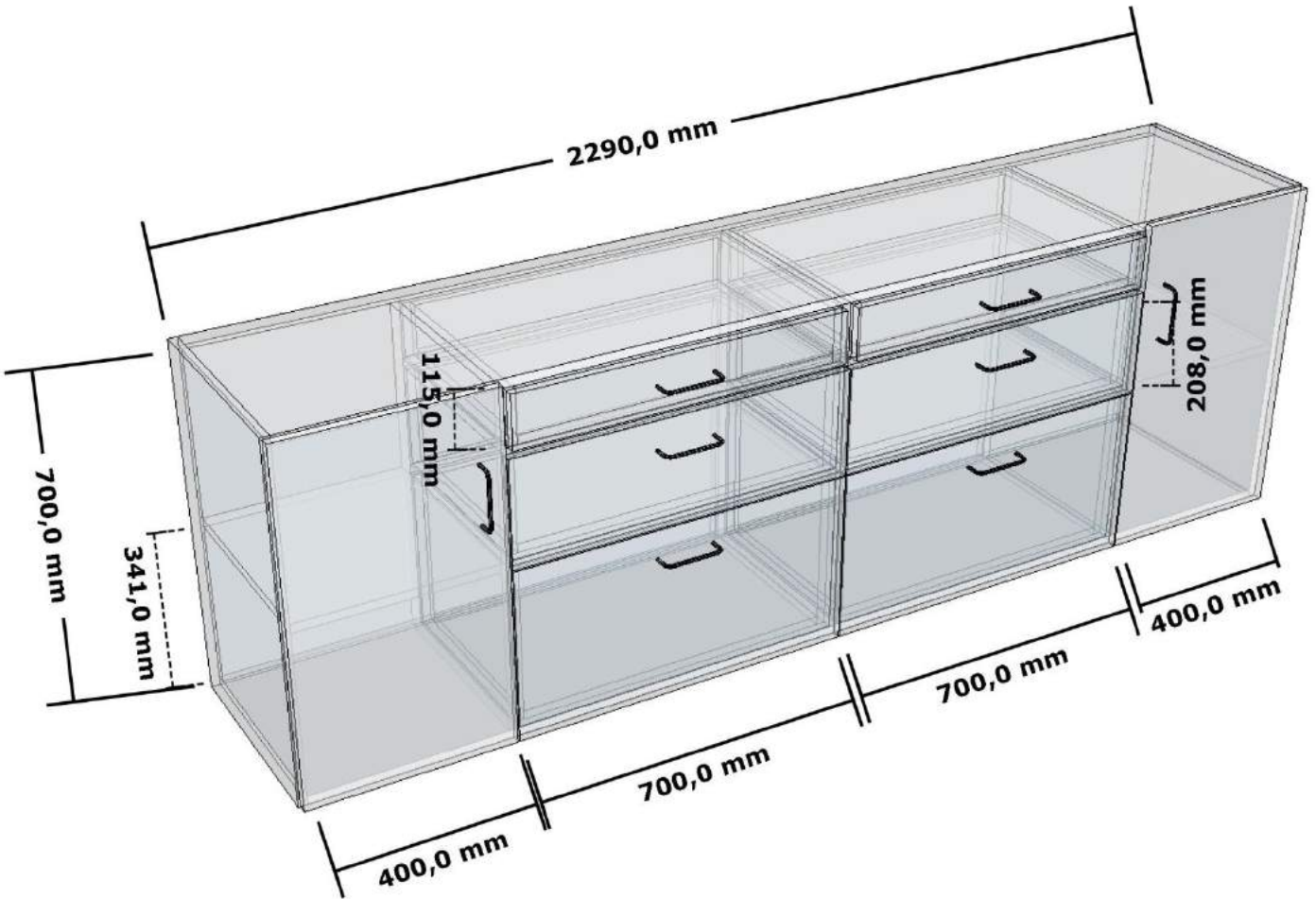
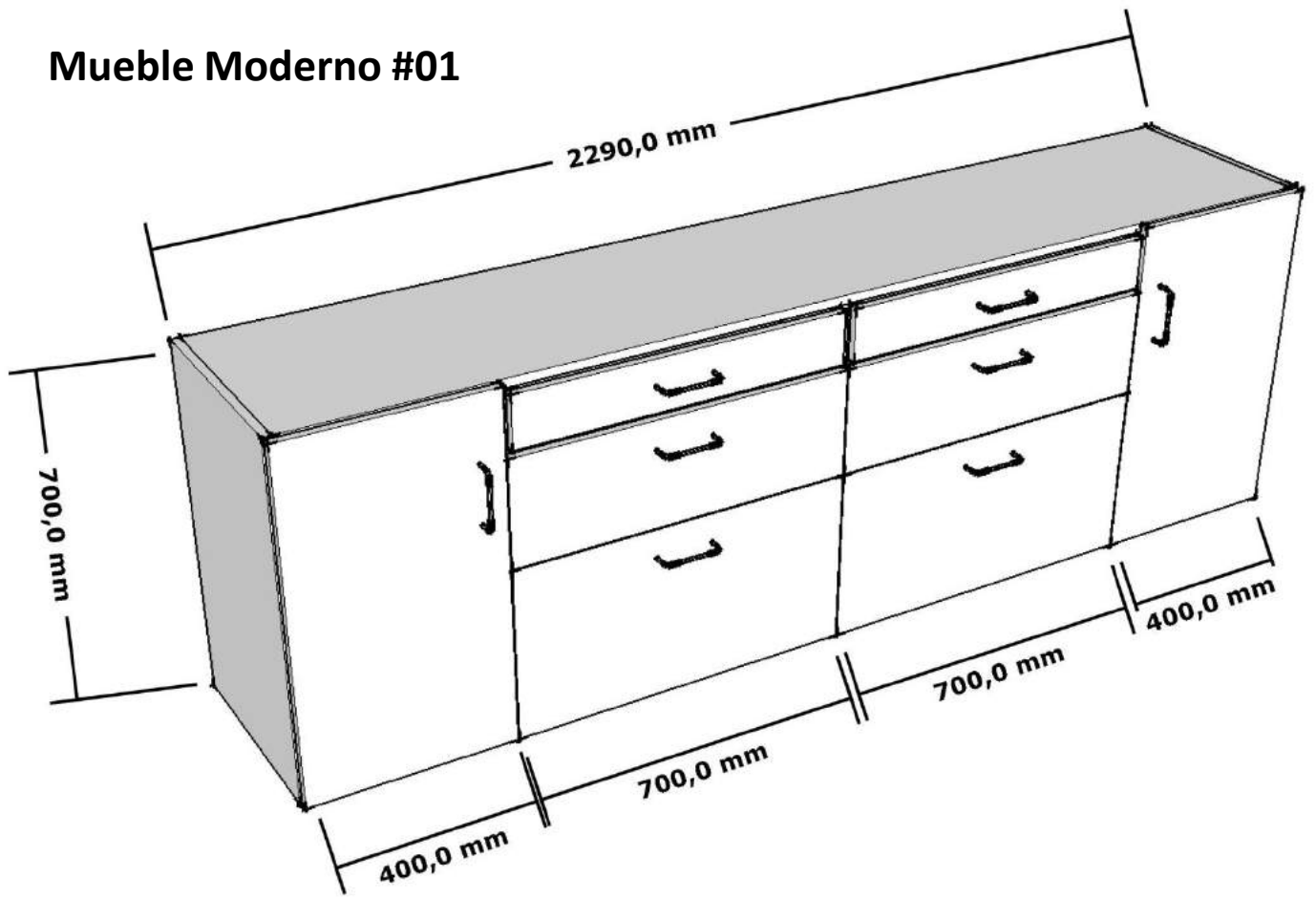

Num	Material	Referencia	Cantidad	Altura (mm)	Anchura (mm)	Espesor (mm)
1	MELA_BL, 18.00	Techo	1	2254.00	447.00	18.00
2	MELA_BL, 18.00	Suelo	1	2254.00	447.00	18.00
3	MELA_BL, 18.00	Lateral Derecho	1	736.00	447.00	18.00
4	MELA_BL, 18.00	Lateral Izquierdo	1	736.00	447.00	18.00
5	MELA_BL, 18.00	Trasera	1	700.00	2254.00	18.00
6	MELA_BL, 18.00	Estante Fijo [1]	1	400.00	429.00	18.00
7	MELA_BL, 18.00	Estante Fijo [2]	1	700.00	429.00	18.00
8	MELA_BL, 18.00	Estante Fijo [3]	1	700.00	429.00	18.00
9	MELA_BL, 18.00	Estante Fijo [4]	1	400.00	429.00	18.00
10	MELA_BL, 18.00	Estante Fijo [5]	1	700.00	429.00	18.00
11	MELA_BL, 18.00	Estante Fijo [6]	1	700.00	429.00	18.00
12	MELA_BL, 18.00	División Vertical [1]	1	700.00	429.00	18.00
13	MELA_BL, 18.00	División Vertical [2]	1	700.00	429.00	18.00
14	MELA_BL, 18.00	División Vertical [3]	1	700.00	429.00	18.00
15	MELA_BL, 18.00	Puerta 1 (unica) [1]	1	730.00	422.50	18.00
16	MELA_BL, 18.00	Puerta 1 (unica) [2]	1	730.00	422.50	18.00
17	MELA_BL, 18.00	Cajón 1 [1]	1	363.50	715.00	18.00
18	MELA_BL, 18.00	Cajón 1 [2]	1	363.50	715.00	18.00
19	MELA_BL, 18.00	Cajón 1 [3]	1	108.00	694.00	18.00
20	MELA_BL, 18.00	Cajón 1 [4]	1	108.00	695.50	18.00
21	MELA_BL, 18.00	Cajón 1 [5]	1	223.00	715.00	18.00
22	MELA_BL, 18.00	Cajón 1 [6]	1	223.00	715.00	18.00
23	MELA_BL, 18.00	Lateral Der Cajón 1 [1]	1	410.00	333.00	18.00
24	MELA_BL, 18.00	Lateral Der Cajón 1 [2]	1	410.00	333.00	18.00
25	MELA_BL, 18.00	Lateral Der Cajón 1 [3]	1	428.00	107.00	18.00
26	MELA_BL, 18.00	Lateral Der Cajón 1 [4]	1	428.00	107.00	18.00
27	MELA_BL, 18.00	Lateral Der Cajón 1 [5]	1	410.00	200.00	18.00
28	MELA_BL, 18.00	Lateral Der Cajón 1 [6]	1	410.00	200.00	18.00
29	MELA_BL, 18.00	Lateral Izq Cajón 1 [1]	1	410.00	333.00	18.00
30	MELA_BL, 18.00	Lateral Izq Cajón 1 [2]	1	410.00	333.00	18.00
31	MELA_BL, 18.00	Lateral Izq Cajón 1 [3]	1	428.00	107.00	18.00
32	MELA_BL, 18.00	Lateral Izq Cajón 1 [4]	1	428.00	107.00	18.00
33	MELA_BL, 18.00	Lateral Izq Cajón 1 [5]	1	410.00	200.00	18.00
34	MELA_BL, 18.00	Lateral Izq Cajón 1 [6]	1	410.00	200.00	18.00
35	MELA_BL, 18.00	Fondo Cajón 1 [1]	1	658.00	392.00	18.00
36	MELA_BL, 18.00	Fondo Cajón 1 [2]	1	658.00	392.00	18.00
37	MELA_BL, 18.00	Fondo Cajón 1 [3]	1	658.00	410.00	18.00
38	MELA_BL, 18.00	Fondo Cajón 1 [4]	1	658.00	410.00	18.00
39	MELA_BL, 18.00	Fondo Cajón 1 [5]	1	658.00	392.00	18.00
40	MELA_BL, 18.00	Fondo Cajón 1 [6]	1	658.00	392.00	18.00
41	MELA_BL, 18.00	Trasera Cajón 1 [1]	1	658.00	333.00	18.00
42	MELA_BL, 18.00	Trasera Cajón 1 [2]	1	658.00	333.00	18.00
43	MELA_BL, 18.00	Trasera Cajón 1 [3]	1	658.00	107.00	18.00
44	MELA_BL, 18.00	Trasera Cajón 1 [4]	1	658.00	107.00	18.00
45	MELA_BL, 18.00	Trasera Cajón 1 [5]	1	658.00	200.00	18.00
46	MELA_BL, 18.00	Trasera Cajón 1 [6]	1	658.00	200.00	18.00
47	MELA_BL, 18.00	Contra-Frente Cajón 1 [1]	1	694.00	333.00	18.00
48	MELA_BL, 18.00	Contra-Frente Cajón 1 [2]	1	694.00	333.00	18.00
49	MELA_BL, 18.00	Contra-Frente Cajón 1 [5]	1	694.00	200.00	18.00
50	MELA_BL, 18.00	Contra-Frente Cajón 1 [6]	1	694.00	200.00	18.00

## Mueble Moderno #02

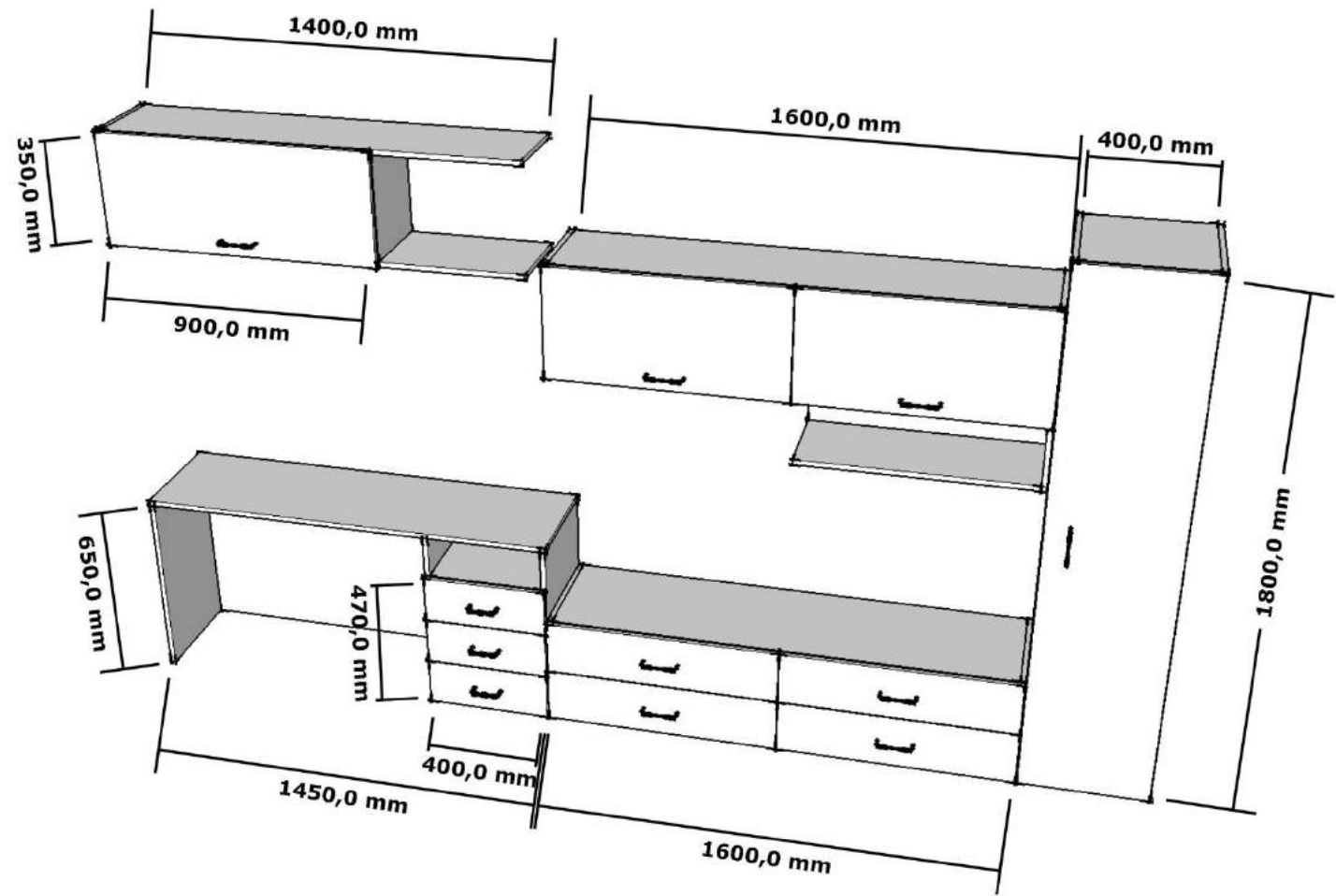

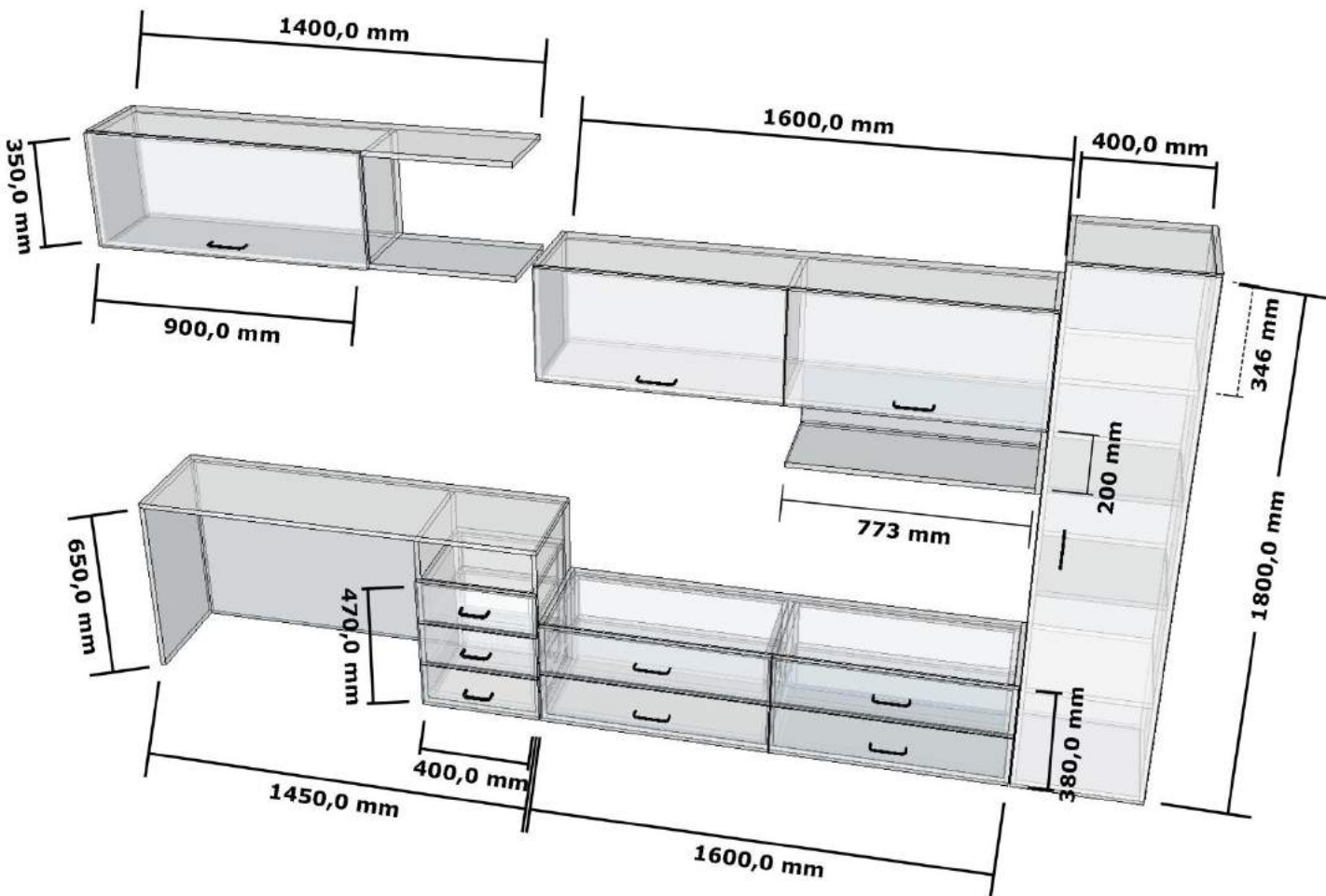

Num	Material	Referencia	Cantidad	Altura (mm)	Anchura (mm)	Espesor (mm)
1	MELA_BL, 18.00	Techo	1	400.00	418.00	18.00
2	MELA_BL, 18.00	Suelo	1	400.00	418.00	18.00
3	MELA_BL, 18.00	Lateral Derecho	1	1836.00	418.00	18.00
4	MELA_BL, 18.00	Lateral Izquierdo	1	1836.00	418.00	18.00
5	MELA_BL, 18.00	Trasera	1	1800.00	400.00	18.00
6	MELA_BL, 18.00	Estante Fijo [1]	1	400.00	400.00	18.00
7	MELA_BL, 18.00	Estante Fijo [2]	1	400.00	400.00	18.00
8	MELA_BL, 18.00	Estante Fijo [3]	1	400.00	400.00	18.00
9	MELA_BL, 18.00	Estante Fijo [4]	1	400.00	400.00	18.00
10	MELA_BL, 18.00	Puerta 1 (unica) [1]	1	1830.00	430.00	18.00

Num	Material	Referencia	Cantidad	Altura (mm)	Anchura (mm)	Espesor (mm)
1	MELA_BL, 18.00	Techo	1	1582.00	397.00	18.00
2	MELA_BL, 18.00	Suelo	1	1582.00	397.00	18.00
3	MELA_BL, 18.00	Lateral Derecho	1	386.00	397.00	18.00
4	MELA_BL, 18.00	Lateral Izquierdo	1	386.00	397.00	18.00
5	MELA_BL, 18.00	Trasera	1	350.00	1582.00	18.00
6	MELA_BL, 18.00	División Vertical [1]	1	350.00	379.00	18.00
7	MELA_BL, 18.00	Cajón 1 [1]_1	1	188.50	804.50	18.00
8	MELA_BL, 18.00	Cajón 1 [1]_2	1	188.50	804.50	18.00
9	MELA_BL, 18.00	Cajón 1 [2]_1	1	188.50	804.50	18.00
10	MELA_BL, 18.00	Cajón 1 [2]_2	1	188.50	804.50	18.00
11	MELA_BL, 18.00	Lateral Der Cajón 1 [1]_1	1	360.00	165.50	18.00
12	MELA_BL, 18.00	Lateral Der Cajón 1 [1]_2	1	360.00	165.50	18.00
13	MELA_BL, 18.00	Lateral Der Cajón 1 [2]_1	1	360.00	165.50	18.00
14	MELA_BL, 18.00	Lateral Der Cajón 1 [2]_2	1	360.00	165.50	18.00
15	MELA_BL, 18.00	Lateral Izq Cajón 1 [1]_1	1	360.00	165.50	18.00
16	MELA_BL, 18.00	Lateral Izq Cajón 1 [1]_2	1	360.00	165.50	18.00
17	MELA_BL, 18.00	Lateral Izq Cajón 1 [2]_1	1	360.00	165.50	18.00
18	MELA_BL, 18.00	Lateral Izq Cajón 1 [2]_2	1	360.00	165.50	18.00
19	MELA_BL, 18.00	Fondo Cajón 1 [1]_1	1	740.00	342.00	18.00
20	MELA_BL, 18.00	Fondo Cajón 1 [1]_2	1	740.00	342.00	18.00
21	MELA_BL, 18.00	Fondo Cajón 1 [2]_1	1	740.00	342.00	18.00
22	MELA_BL, 18.00	Fondo Cajón 1 [2]_2	1	740.00	342.00	18.00
23	MELA_BL, 18.00	Trasera Cajón 1 [1]_1	1	740.00	165.50	18.00
24	MELA_BL, 18.00	Trasera Cajón 1 [1]_2	1	740.00	165.50	18.00
25	MELA_BL, 18.00	Trasera Cajón 1 [2]_1	1	740.00	165.50	18.00
26	MELA_BL, 18.00	Trasera Cajón 1 [2]_2	1	740.00	165.50	18.00
27	MELA_BL, 18.00	Contra-Frente Cajón 1 [1]_1	1	776.00	165.50	18.00
28	MELA_BL, 18.00	Contra-Frente Cajón 1 [1]_2	1	776.00	165.50	18.00
29	MELA_BL, 18.00	Contra-Frente Cajón 1 [2]_1	1	776.00	165.50	18.00
30	MELA_BL, 18.00	Contra-Frente Cajón 1 [2]_2	1	776.00	165.50	18.00

Num	Material	Referencia	Cantidad	Altura (mm)	Anchura (mm)	Espesor (mm)
1	MELA_BL, 18.00	Techo	1	1454.00	397.00	18.00
2	MELA_BL, 18.00	Lateral Derecho	1	650.00	397.00	18.00
3	MELA_BL, 18.00	Lateral Izquierdo	1	650.00	397.00	18.00
4	MELA_BL, 18.00	Trasera	1	650.00	1418.00	18.00
5	MELA_BL, 18.00	Estante Fijo [1]	1	400.00	379.00	18.00
6	MELA_BL, 18.00	División Libre 1 [1]	1	400.00	379.00	18.00
7	MELA_BL, 18.00	División Vertical [1]	1	650.00	379.00	18.00
8	MELA_BL, 18.00	Cajón 1 [1]_1	1	164.67	430.00	18.00
9	MELA_BL, 18.00	Cajón 1 [1]_2	1	164.67	430.00	18.00
10	MELA_BL, 18.00	Cajón 1 [1]_3	1	164.67	430.00	18.00
11	MELA_BL, 18.00	Lateral Der Cajón 1 [1]_1	1	360.00	141.67	18.00
12	MELA_BL, 18.00	Lateral Der Cajón 1 [1]_2	1	360.00	156.67	18.00
13	MELA_BL, 18.00	Lateral Der Cajón 1 [1]_3	1	360.00	141.67	18.00
14	MELA_BL, 18.00	Lateral Izq Cajón 1 [1]_1	1	360.00	141.67	18.00
15	MELA_BL, 18.00	Lateral Izq Cajón 1 [1]_2	1	360.00	156.67	18.00
16	MELA_BL, 18.00	Lateral Izq Cajón 1 [1]_3	1	360.00	141.67	18.00
17	MELA_BL, 18.00	Fondo Cajón 1 [1]_1	1	358.00	342.00	18.00
18	MELA_BL, 18.00	Fondo Cajón 1 [1]_2	1	358.00	342.00	18.00
19	MELA_BL, 18.00	Fondo Cajón 1 [1]_3	1	358.00	342.00	18.00
20	MELA_BL, 18.00	Trasera Cajón 1 [1]_1	1	358.00	141.67	18.00
21	MELA_BL, 18.00	Trasera Cajón 1 [1]_2	1	358.00	156.67	18.00
22	MELA_BL, 18.00	Trasera Cajón 1 [1]_3	1	358.00	141.67	18.00
23	MELA_BL, 18.00	Contra-Frente Cajón 1 [1]_1	1	394.00	141.67	18.00
24	MELA_BL, 18.00	Contra-Frente Cajón 1 [1]_2	1	394.00	156.67	18.00
25	MELA_BL, 18.00	Contra-Frente Cajón 1 [1]_3	1	394.00	141.67	18.00

Num	Material	Referencia	Cantidad	Altura (mm)	Anchura (mm)	Espesor (mm)
1	MELA_BL, 18.00	Suelo	1	773.00	318.00	18.00
2	MELA_BL, 18.00	Lateral Derecho	1	218.00	318.00	18.00
3	MELA_BL, 18.00	Trasera	1	200.00	773.00	18.00

Num	Material	Referencia	Cantidad	Altura (mm)	Anchura (mm)	Espesor (mm)
1	MELA_BL, 18.00	Techo	1	1564.00	318.00	18.00
2	MELA_BL, 18.00	Suelo	1	1564.00	318.00	18.00
3	MELA_BL, 18.00	Lateral Derecho	1	386.00	318.00	18.00
4	MELA_BL, 18.00	Lateral Izquierdo	1	386.00	318.00	18.00
5	MELA_BL, 18.00	Trasera	1	350.00	1564.00	18.00
6	MELA_BL, 18.00	División Vertical [1]	1	350.00	300.00	18.00
7	MELA_BL, 18.00	Puerta 1 (unica) [1]	1	380.00	795.50	18.00
8	MELA_BL, 18.00	Puerta 1 (unica) [2]	1	380.00	795.50	18.00

Num	Material	Referencia	Cantidad	Altura (mm)	Anchura (mm)	Espesor (mm)
1	MELA_BL, 18.00	Techo	1	1400.00	297.00	18.00
2	MELA_BL, 18.00	Suelo	1	1400.00	297.00	18.00
3	MELA_BL, 18.00	Lateral Izquierdo	1	386.00	297.00	18.00
4	MELA_BL, 18.00	División Libre 1 [1]	1	900.00	350.00	18.00
5	MELA_BL, 18.00	División Vertical [1]	1	350.00	297.00	18.00
6	MELA_BL, 18.00	Puerta 1 (unica) [1]	1	380.00	930.00	18.00

## Mueble Moderno #03

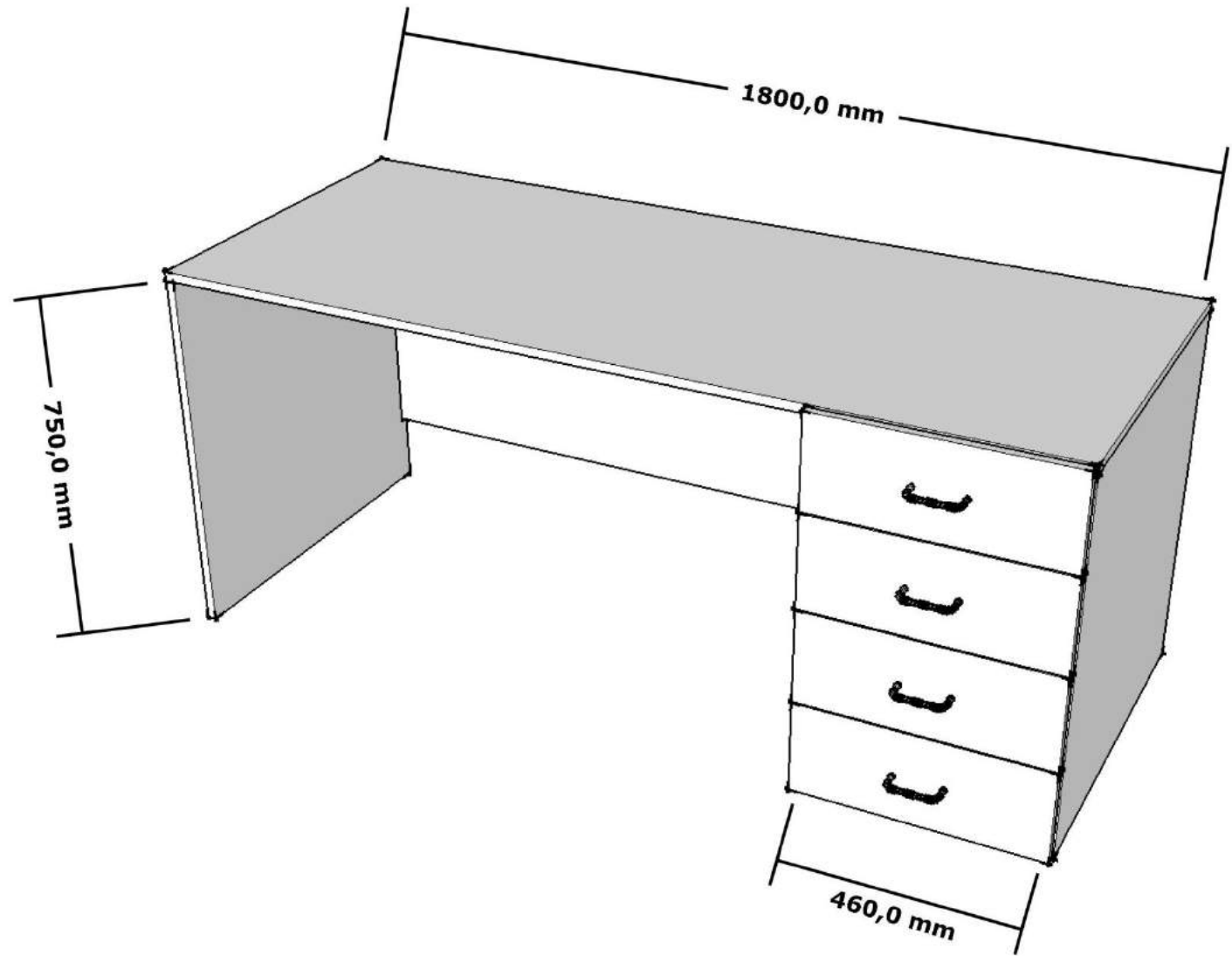



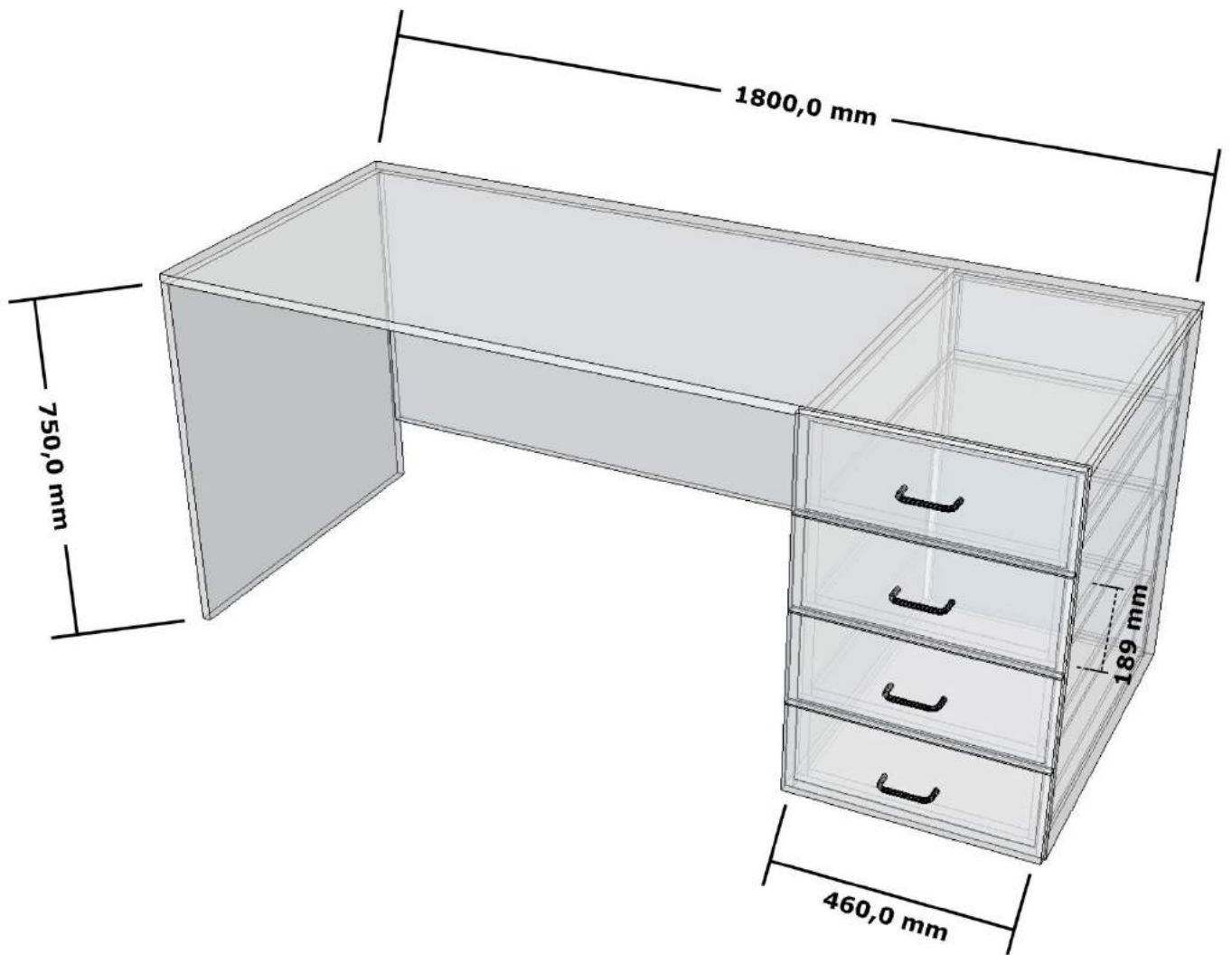

Num	Material	Referencia	Cantidad	Altura (mm)	Anchura (mm)	Espesor (mm)
1	MELA_BL, 18.00	Techo	1	1818.00	747.00	18.00
2	MELA_BL, 18.00	Lateral Derecho	1	750.00	747.00	18.00
3	MELA_BL, 18.00	Lateral Izquierdo	1	750.00	747.00	18.00
4	MELA_BL, 18.00	División Libre 1 [1]	1	750.00	460.00	18.00
5	MELA_BL, 18.00	División Libre 1 [2]	1	1304.00	600.00	18.00
6	MELA_BL, 18.00	División Libre 1 [3]	1	729.00	460.00	18.00
7	MELA_BL, 18.00	División Vertical [1]	1	750.00	747.00	18.00
8	MELA_BL, 18.00	Cajón 1 [1]_1	1	188.25	490.00	18.00
9	MELA_BL, 18.00	Cajón 1 [1]_2	1	188.25	490.00	18.00
10	MELA_BL, 18.00	Cajón 1 [1]_3	1	188.25	490.00	18.00
11	MELA_BL, 18.00	Cajón 1 [1]_4	1	188.25	490.00	18.00
12	MELA_BL, 18.00	Lateral Der Cajón 1 [1]_1	1	710.00	165.25	18.00
13	MELA_BL, 18.00	Lateral Der Cajón 1 [1]_2	1	710.00	180.25	18.00
14	MELA_BL, 18.00	Lateral Der Cajón 1 [1]_3	1	710.00	180.25	18.00
15	MELA_BL, 18.00	Lateral Der Cajón 1 [1]_4	1	710.00	165.25	18.00
16	MELA_BL, 18.00	Lateral Izq Cajón 1 [1]_1	1	710.00	165.25	18.00
17	MELA_BL, 18.00	Lateral Izq Cajón 1 [1]_2	1	710.00	180.25	18.00
18	MELA_BL, 18.00	Lateral Izq Cajón 1 [1]_3	1	710.00	180.25	18.00
19	MELA_BL, 18.00	Lateral Izq Cajón 1 [1]_4	1	710.00	165.25	18.00
20	MELA_BL, 18.00	Fondo Cajón 1 [1]_1	1	692.00	418.00	18.00
21	MELA_BL, 18.00	Fondo Cajón 1 [1]_2	1	692.00	418.00	18.00
22	MELA_BL, 18.00	Fondo Cajón 1 [1]_3	1	692.00	418.00	18.00
23	MELA_BL, 18.00	Fondo Cajón 1 [1]_4	1	692.00	418.00	18.00
24	MELA_BL, 18.00	Trasera Cajón 1 [1]_1	1	418.00	165.25	18.00
25	MELA_BL, 18.00	Trasera Cajón 1 [1]_2	1	418.00	180.25	18.00
26	MELA_BL, 18.00	Trasera Cajón 1 [1]_3	1	418.00	180.25	18.00
27	MELA_BL, 18.00	Trasera Cajón 1 [1]_4	1	418.00	165.25	18.00
28	MELA_BL, 18.00	Contra-Frente Cajón 1 [1]_1	1	454.00	165.25	18.00
29	MELA_BL, 18.00	Contra-Frente Cajón 1 [1]_2	1	454.00	180.25	18.00
30	MELA_BL, 18.00	Contra-Frente Cajón 1 [1]_3	1	454.00	180.25	18.00
31	MELA_BL, 18.00	Contra-Frente Cajón 1 [1]_4	1	454.00	165.25	18.00

# Mueble Moderno #04

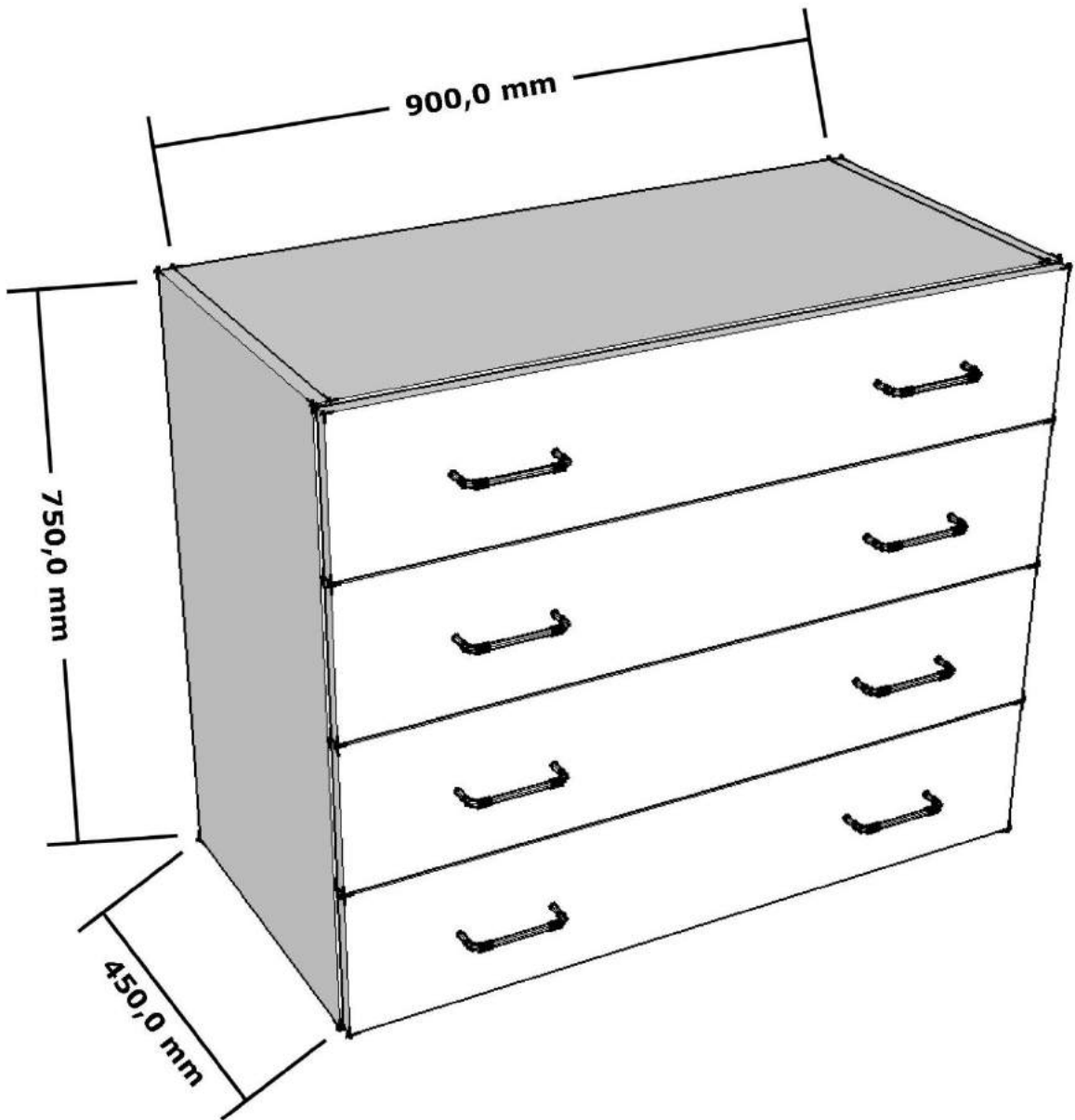

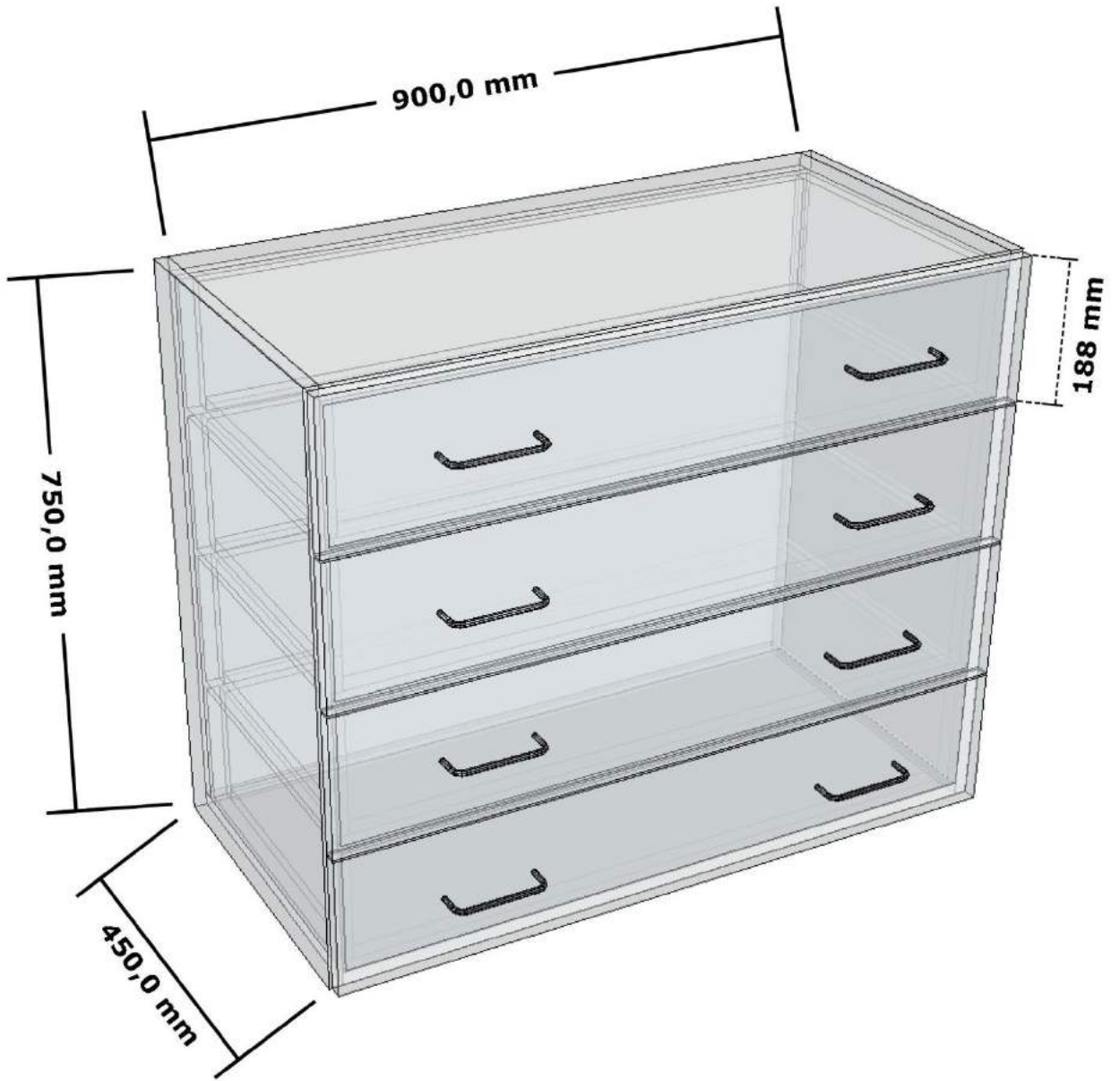

Num	Material	Referencia	Cantidad	Altura (mm)	Anchura (mm)	Espesor (mm)
1	MELA_BL, 18.00	Techo	1	900.00	447.00	18.00
2	MELA_BL, 18.00	Suelo	1	900.00	447.00	18.00
3	MELA_BL, 18.00	Lateral Derecho	1	768.00	447.00	18.00
4	MELA_BL, 18.00	Lateral Izquierdo	1	768.00	447.00	18.00
5	MELA_BL, 18.00	Trasera	1	732.00	900.00	18.00
6	MELA_BL, 18.00	Cajón 1 [1]_1	1	188.25	930.00	18.00
7	MELA_BL, 18.00	Cajón 1 [1]_2	1	188.25	930.00	18.00
8	MELA_BL, 18.00	Cajón 1 [1]_3	1	188.25	930.00	18.00
9	MELA_BL, 18.00	Cajón 1 [1]_4	1	188.25	930.00	18.00
10	MELA_BL, 18.00	Lateral Der Cajón 1 [1]_1	1	410.00	165.25	18.00
11	MELA_BL, 18.00	Lateral Der Cajón 1 [1]_2	1	410.00	180.25	18.00
12	MELA_BL, 18.00	Lateral Der Cajón 1 [1]_3	1	410.00	180.25	18.00
13	MELA_BL, 18.00	Lateral Der Cajón 1 [1]_4	1	410.00	165.25	18.00
14	MELA_BL, 18.00	Lateral Izq Cajón 1 [1]_1	1	410.00	165.25	18.00
15	MELA_BL, 18.00	Lateral Izq Cajón 1 [1]_2	1	410.00	180.25	18.00
16	MELA_BL, 18.00	Lateral Izq Cajón 1 [1]_3	1	410.00	180.25	18.00
17	MELA_BL, 18.00	Lateral Izq Cajón 1 [1]_4	1	410.00	165.25	18.00
18	MELA_BL, 18.00	Fondo Cajón 1 [1]_1	1	858.00	392.00	18.00
19	MELA_BL, 18.00	Fondo Cajón 1 [1]_2	1	858.00	392.00	18.00
20	MELA_BL, 18.00	Fondo Cajón 1 [1]_3	1	858.00	392.00	18.00
21	MELA_BL, 18.00	Fondo Cajón 1 [1]_4	1	858.00	392.00	18.00
22	MELA_BL, 18.00	Trasera Cajón 1 [1]_1	1	858.00	165.25	18.00
23	MELA_BL, 18.00	Trasera Cajón 1 [1]_2	1	858.00	180.25	18.00
24	MELA_BL, 18.00	Trasera Cajón 1 [1]_3	1	858.00	180.25	18.00
25	MELA_BL, 18.00	Trasera Cajón 1 [1]_4	1	858.00	165.25	18.00
26	MELA_BL, 18.00	Contra-Frente Cajón 1 [1]_1	1	894.00	165.25	18.00
27	MELA_BL, 18.00	Contra-Frente Cajón 1 [1]_2	1	894.00	180.25	18.00
28	MELA_BL, 18.00	Contra-Frente Cajón 1 [1]_3	1	894.00	180.25	18.00
29	MELA_BL, 18.00	Contra-Frente Cajón 1 [1]_4	1	894.00	165.25	18.00

# Mueble Moderno #05

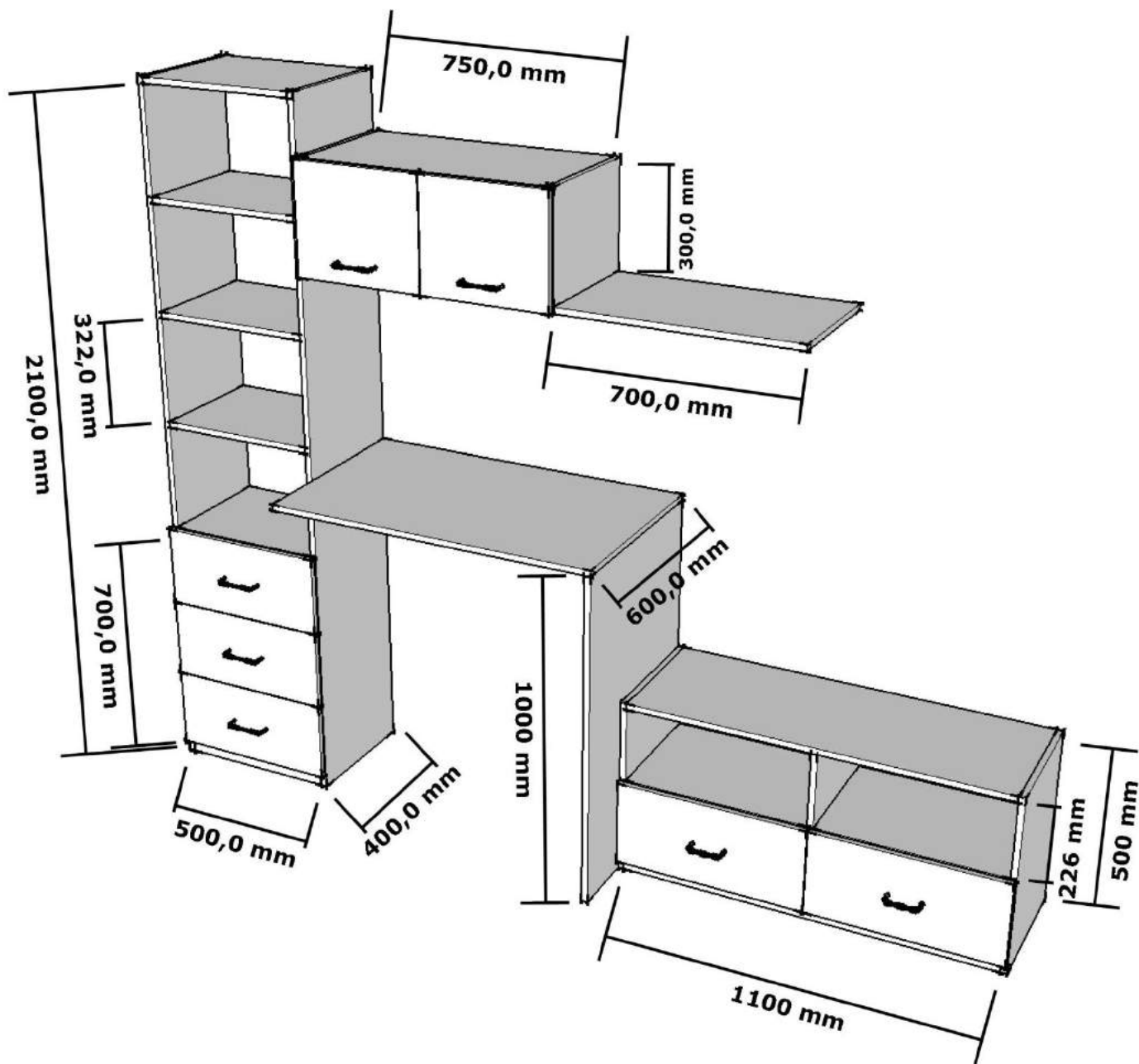

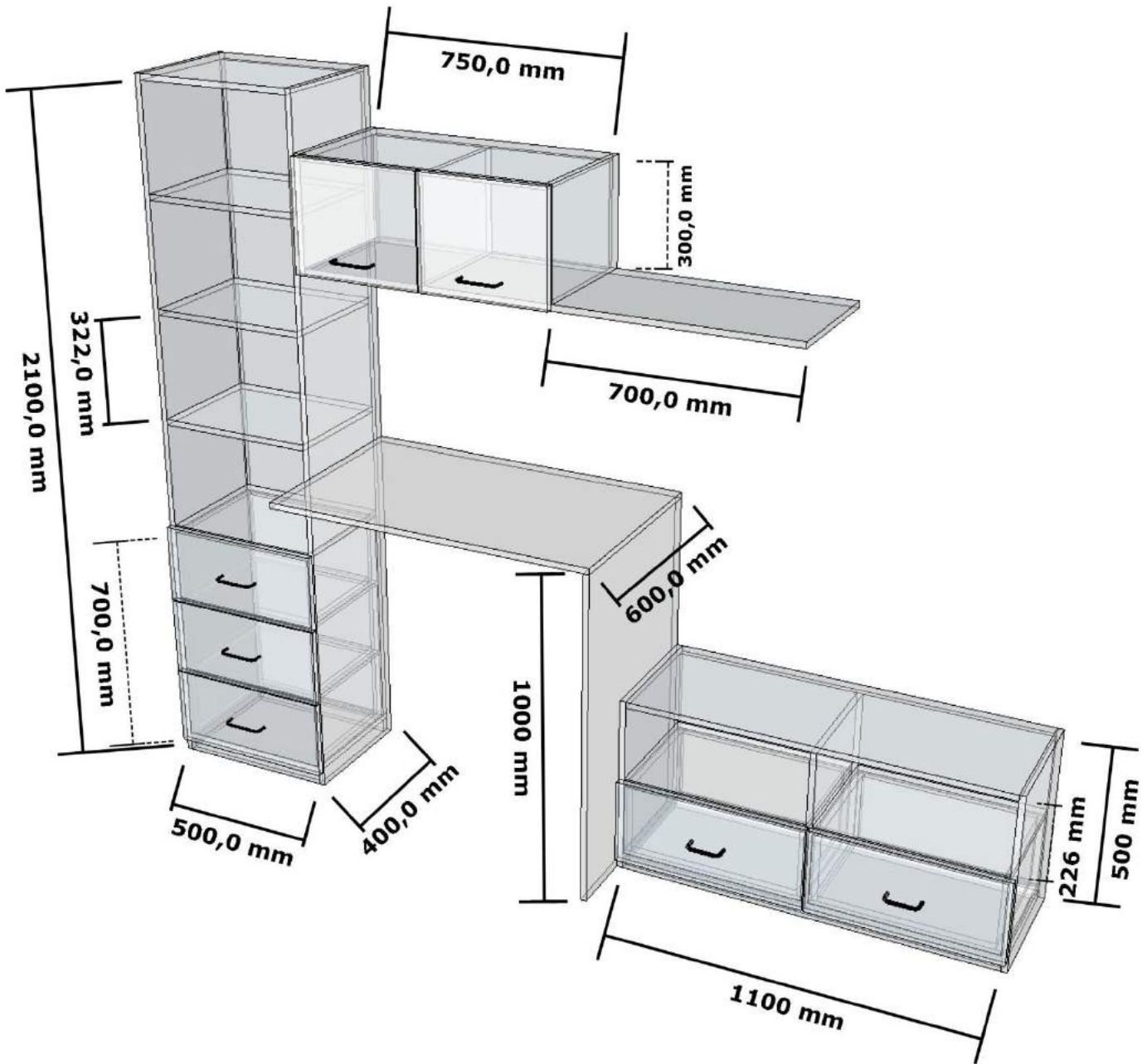

Num	Material	Referencia	Cantidad	Altura (mm)	Anchura (mm)	Espesor (mm)
1	MELA_BL, 18.00	Techo	1	482.00	397.00	18.00
2	MELA_BL, 18.00	Suelo	1	482.00	397.00	18.00
3	MELA_BL, 18.00	Lateral Derecho	1	2136.00	397.00	18.00
4	MELA_BL, 18.00	Lateral Izquierdo	1	2136.00	397.00	18.00
5	MELA_BL, 18.00	Trasera	1	2060.00	482.00	18.00
6	MELA_BL, 18.00	Estante Fijo [1]	1	482.00	379.00	18.00
7	MELA_BL, 18.00	Estante Fijo [2]	1	482.00	379.00	18.00
8	MELA_BL, 18.00	Estante Fijo [3]	1	482.00	379.00	18.00
9	MELA_BL, 18.00	Estante Fijo [4]	1	482.00	379.00	18.00
10	MELA_BL, 18.00	Cajón 1 [1]_1	1	241.33	512.00	18.00
11	MELA_BL, 18.00	Cajón 1 [1]_2	1	241.33	512.00	18.00
12	MELA_BL, 18.00	Cajón 1 [1]_3	1	241.33	512.00	18.00
13	MELA_BL, 18.00	Lateral Der Cajón 1 [1]_1	1	360.00	218.33	18.00
14	MELA_BL, 18.00	Lateral Der Cajón 1 [1]_2	1	360.00	233.33	18.00
15	MELA_BL, 18.00	Lateral Der Cajón 1 [1]_3	1	360.00	218.33	18.00
16	MELA_BL, 18.00	Lateral Izq Cajón 1 [1]_1	1	360.00	218.33	18.00
17	MELA_BL, 18.00	Lateral Izq Cajón 1 [1]_2	1	360.00	233.33	18.00
18	MELA_BL, 18.00	Lateral Izq Cajón 1 [1]_3	1	360.00	218.33	18.00
19	MELA_BL, 18.00	Fondo Cajón 1 [1]_1	1	440.00	342.00	18.00
20	MELA_BL, 18.00	Fondo Cajón 1 [1]_2	1	440.00	342.00	18.00
21	MELA_BL, 18.00	Fondo Cajón 1 [1]_3	1	440.00	342.00	18.00
22	MELA_BL, 18.00	Trasera Cajón 1 [1]_1	1	440.00	218.33	18.00
23	MELA_BL, 18.00	Trasera Cajón 1 [1]_2	1	440.00	233.33	18.00
24	MELA_BL, 18.00	Trasera Cajón 1 [1]_3	1	440.00	218.33	18.00
25	MELA_BL, 18.00	Contra-Frente Cajón 1 [1]_1	1	476.00	218.33	18.00
26	MELA_BL, 18.00	Contra-Frente Cajón 1 [1]_2	1	476.00	233.33	18.00
27	MELA_BL, 18.00	Contra-Frente Cajón 1 [1]_3	1	476.00	218.33	18.00
28	MELA_BL, 18.00	Zócalo 1 [1]	1	482.00	40.00	18.00
29	MELA_BL, 18.00	Zócalo 1 [2]	1	482.00	40.00	18.00

Num	Material	Referencia	Cantidad	Altura (mm)	Anchura (mm)	Espesor (mm)
1	MELA_BL, 18.00	Techo	1	998.00	600.00	18.00
2	MELA_BL, 18.00	Lateral Derecho	1	1000.00	600.00	18.00



Num	Material	Referencia	Cantidad	Altura (mm)	Anchura (mm)	Espesor (mm)
1	MELA_BL, 18.00	Techo	1	1100.00	397.00	18.00
2	MELA_BL, 18.00	Suelo	1	1100.00	397.00	18.00
3	MELA_BL, 18.00	Lateral Derecho	1	536.00	397.00	18.00
4	MELA_BL, 18.00	Lateral Izquierdo	1	536.00	397.00	18.00
5	MELA_BL, 18.00	Trasera	1	470.00	1100.00	18.00
6	MELA_BL, 18.00	Estante Fijo [1]	1	541.00	379.00	18.00
7	MELA_BL, 18.00	Estante Fijo [2]	1	541.00	379.00	18.00
8	MELA_BL, 18.00	División Vertical [1]	1	470.00	379.00	18.00
9	MELA_BL, 18.00	Cajón 1 [1]	1	256.00	563.50	18.00
10	MELA_BL, 18.00	Cajón 1 [2]	1	256.00	563.50	18.00
11	MELA_BL, 18.00	Lateral Der Cajón 1 [1]	1	360.00	218.00	18.00
12	MELA_BL, 18.00	Lateral Der Cajón 1 [2]	1	360.00	218.00	18.00
13	MELA_BL, 18.00	Lateral Izq Cajón 1 [1]	1	360.00	218.00	18.00
14	MELA_BL, 18.00	Lateral Izq Cajón 1 [2]	1	360.00	218.00	18.00
15	MELA_BL, 18.00	Fondo Cajón 1 [1]	1	499.00	342.00	18.00
16	MELA_BL, 18.00	Fondo Cajón 1 [2]	1	499.00	342.00	18.00
17	MELA_BL, 18.00	Trasera Cajón 1 [1]	1	499.00	218.00	18.00
18	MELA_BL, 18.00	Trasera Cajón 1 [2]	1	499.00	218.00	18.00
19	MELA_BL, 18.00	Contra-Frente Cajón 1 [1]	1	535.00	218.00	18.00
20	MELA_BL, 18.00	Contra-Frente Cajón 1 [2]	1	535.00	218.00	18.00
21	MELA_BL, 18.00	Zócalo 1 [1]	1	1100.00	30.00	18.00
22	MELA_BL, 18.00	Zócalo 1 [2]	1	1100.00	30.00	18.00

Num	Material	Referencia	Cantidad	Altura (mm)	Anchura (mm)	Espesor (mm)
1	MELA_BL, 18.00	Techo	1	750.00	397.00	18.00
2	MELA_BL, 18.00	Suelo	1	1468.00	397.00	18.00
3	MELA_BL, 18.00	Lateral Derecho	1	318.00	397.00	18.00
4	MELA_BL, 18.00	Lateral Izquierdo	1	336.00	397.00	18.00
5	MELA_BL, 18.00	Trasera	1	300.00	750.00	18.00
6	MELA_BL, 18.00	División Vertical [1]	1	300.00	379.00	18.00
7	MELA_BL, 18.00	Puerta 1 (unica) [1]	1	330.00	388.50	18.00
8	MELA_BL, 18.00	Puerta 1 (unica) [2]	1	330.00	388.50	18.00

# Mueble Moderno #06

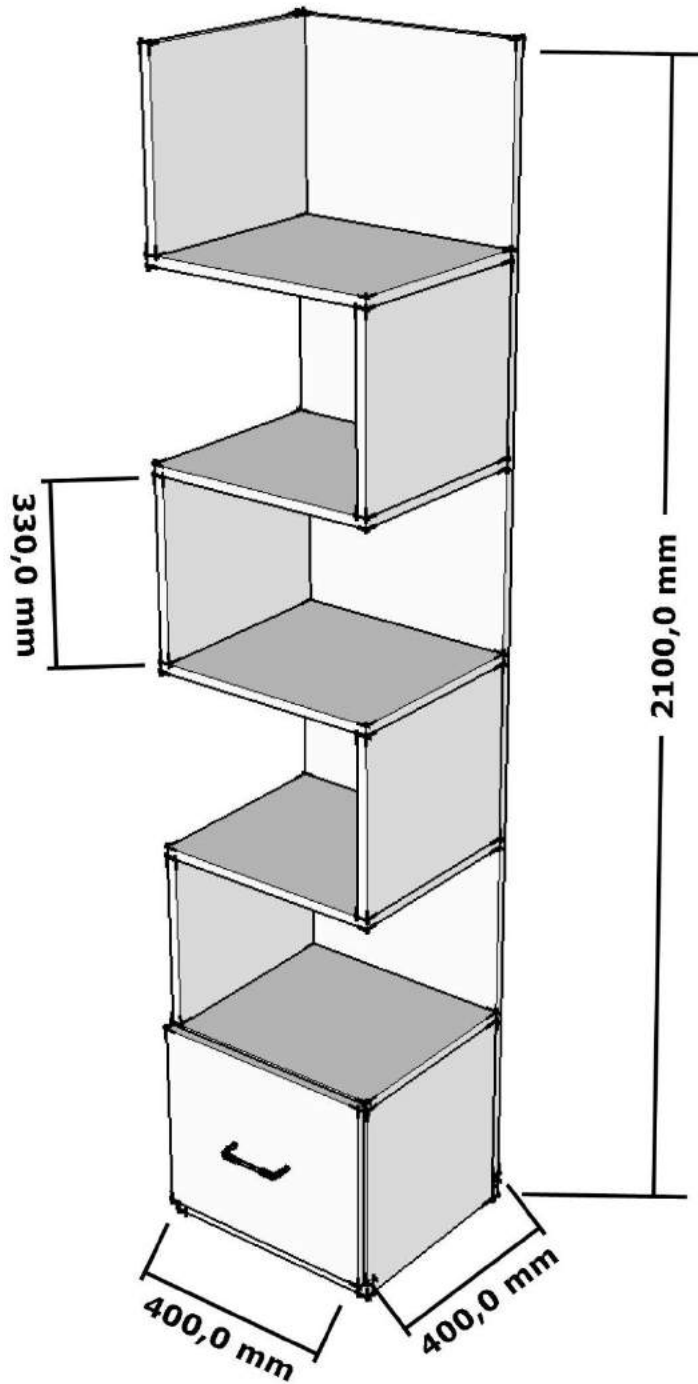

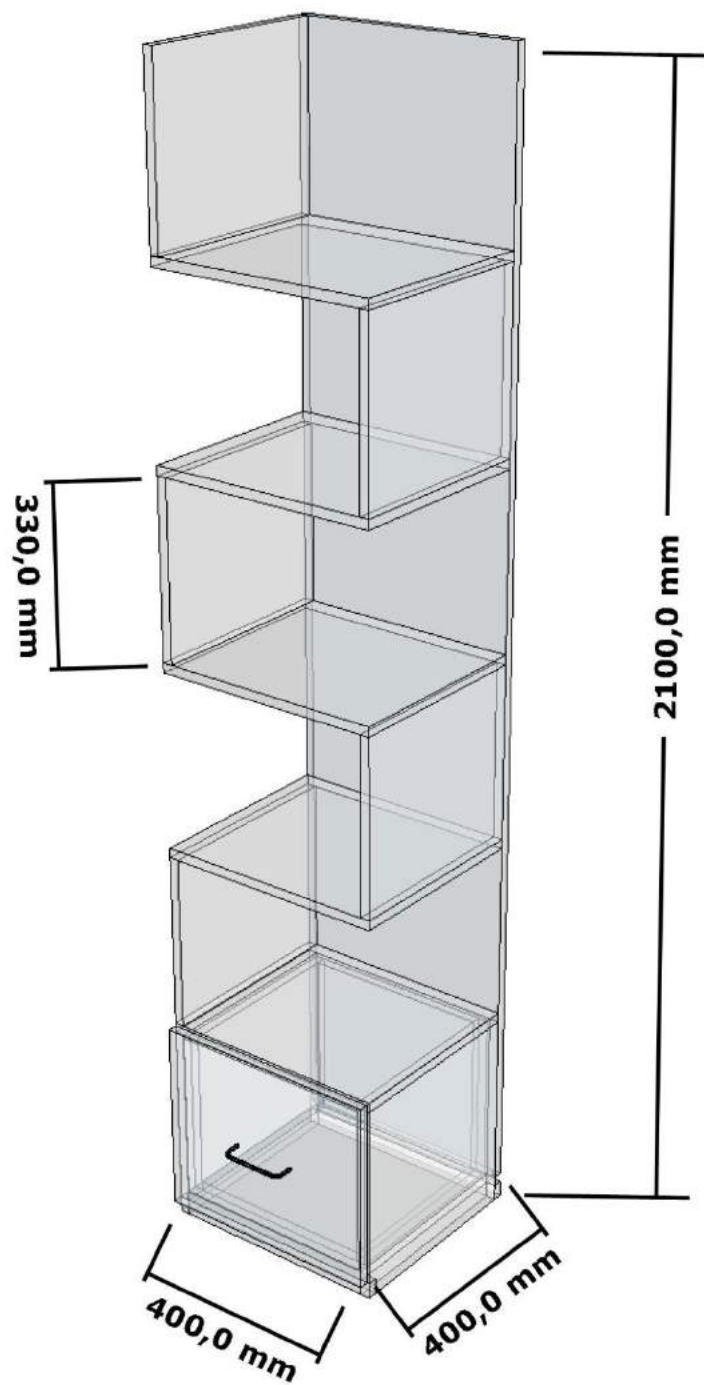

Num	Material	Referencia	Cantidad	Altura (mm)	Anchura (mm)	Espesor (mm)
1	MELA_BL, 18.00	Suelo	1	400.00	397.00	18.00
2	MELA_BL, 18.00	Trasera	1	2070.00	436.00	18.00
3	MELA_BL, 18.00	Estante Fijo [1]	1	436.00	379.00	18.00
4	MELA_BL, 18.00	Estante Fijo [2]	1	436.00	379.00	18.00
5	MELA_BL, 18.00	Estante Fijo [3]	1	436.00	379.00	18.00
6	MELA_BL, 18.00	Estante Fijo [4]	1	436.00	379.00	18.00
7	MELA_BL, 18.00	Estante Fijo [5]	1	436.00	379.00	18.00
8	MELA_BL, 18.00	División Vertical [1]	1	378.00	379.00	18.00
9	MELA_BL, 18.00	División Vertical [2]	1	378.00	379.00	18.00
10	MELA_BL, 18.00	División Vertical [3]	1	330.00	379.00	18.00
11	MELA_BL, 18.00	División Vertical [4]	1	330.00	379.00	18.00
12	MELA_BL, 18.00	División Vertical [5]	1	330.00	379.00	18.00
13	MELA_BL, 18.00	División Vertical [6]	1	330.00	379.00	18.00
14	MELA_BL, 18.00	División Vertical [7]	1	330.00	379.00	18.00
15	MELA_BL, 18.00	Cajón 1 [1]	1	360.00	430.00	18.00
16	MELA_BL, 18.00	Lateral Der Cajón 1 [1]	1	360.00	322.00	18.00
17	MELA_BL, 18.00	Lateral Izq Cajón 1 [1]	1	360.00	322.00	18.00
18	MELA_BL, 18.00	Fondo Cajón 1 [1]	1	358.00	342.00	18.00
19	MELA_BL, 18.00	Trasera Cajón 1 [1]	1	358.00	322.00	18.00
20	MELA_BL, 18.00	Contra-Frente Cajón 1 [1]	1	394.00	322.00	18.00
21	MELA_BL, 18.00	Zócalo 1 [1]	1	436.00	30.00	18.00
22	MELA_BL, 18.00	Zócalo 1 [2]	1	436.00	30.00	18.00

# Mueble Moderno #07

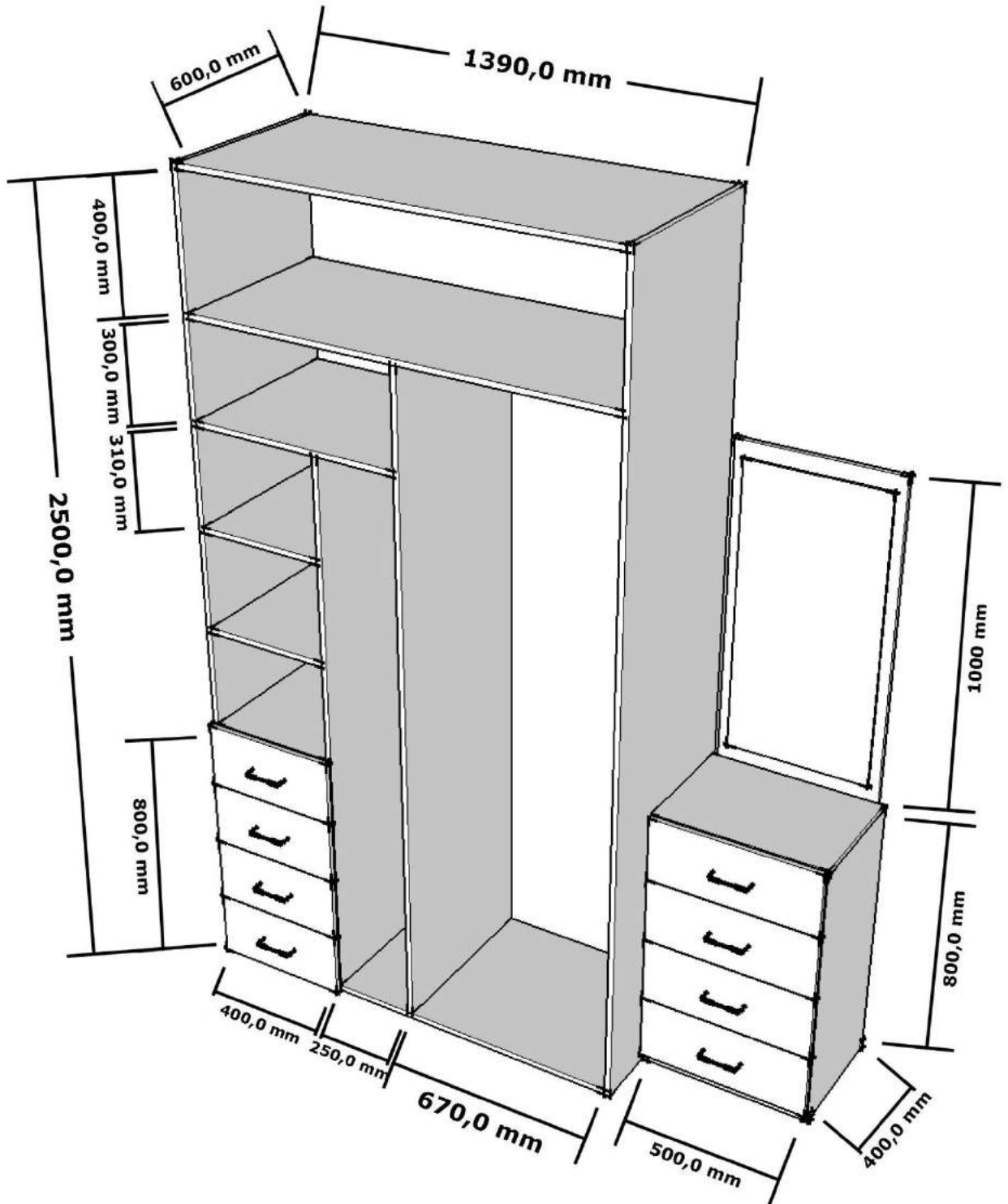

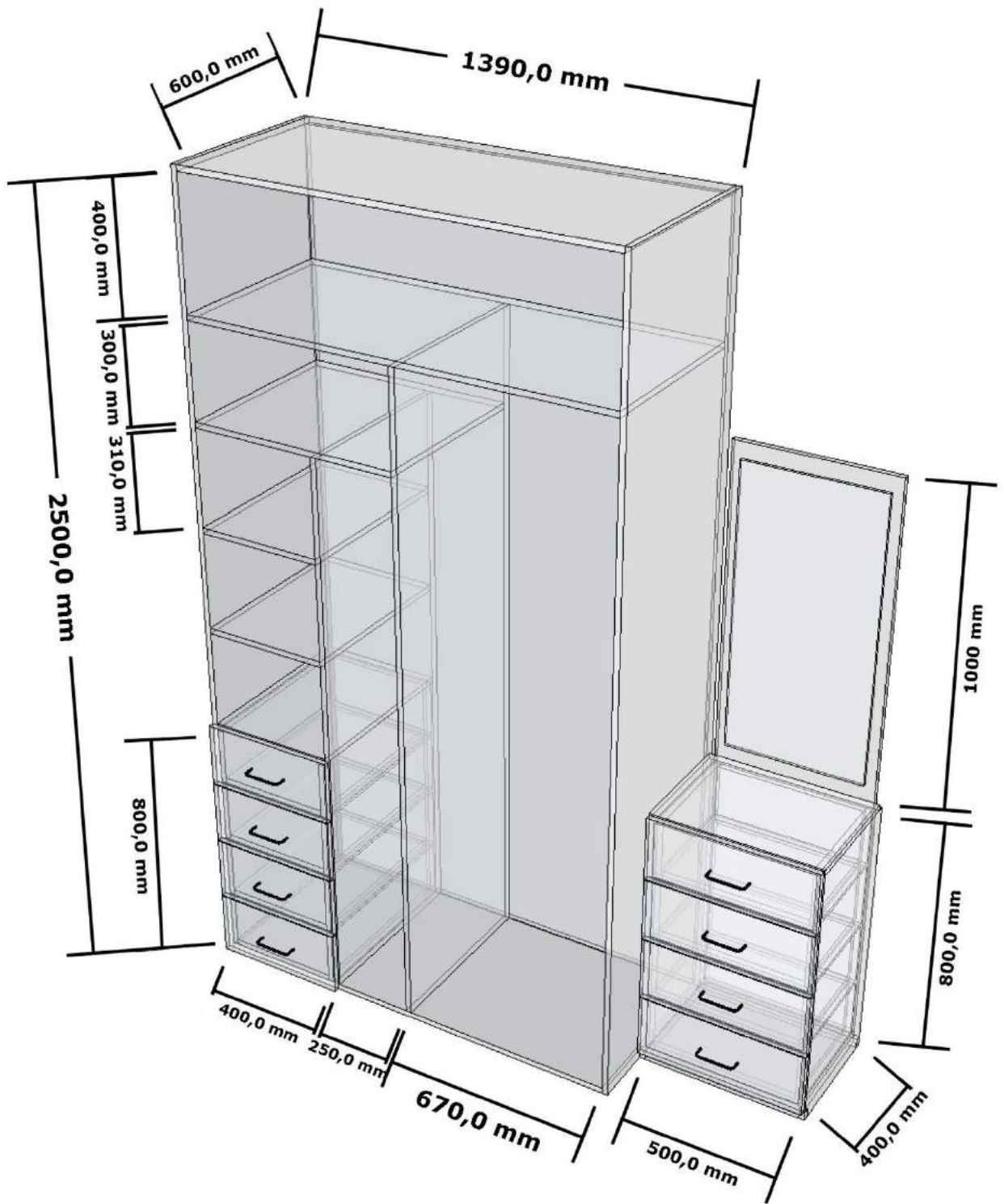

Num	Material	Referencia	Cantidad	Altura (mm)	Anchura (mm)	Espesor (mm)
1	MELA_BL, 18.00	Techo	1	1356.00	597.00	18.00
2	MELA_BL, 18.00	Suelo	1	1356.00	597.00	18.00
3	MELA_BL, 18.00	Lateral Derecho	1	2556.00	597.00	18.00
4	MELA_BL, 18.00	Lateral Izquierdo	1	2556.00	597.00	18.00
5	MELA_BL, 18.00	Trasera	1	2520.00	1356.00	18.00
6	MELA_BL, 18.00	Estante Fijo [1]	1	1356.00	579.00	18.00
7	MELA_BL, 18.00	Estante Fijo [2]	1	668.00	579.00	18.00
8	MELA_BL, 18.00	Estante Fijo [3]	1	400.00	579.00	18.00
9	MELA_BL, 18.00	Estante Fijo [4]	1	400.00	579.00	18.00
10	MELA_BL, 18.00	Estante Fijo [5]	1	400.00	579.00	18.00
11	MELA_BL, 18.00	División Vertical [1]	1	2102.00	579.00	18.00
12	MELA_BL, 18.00	División Vertical [2]	1	1784.00	579.00	18.00
13	MELA_BL, 18.00	Cajón 1 [1]_1	1	205.25	430.00	18.00
14	MELA_BL, 18.00	Cajón 1 [1]_2	1	205.25	430.00	18.00
15	MELA_BL, 18.00	Cajón 1 [1]_3	1	205.25	430.00	18.00
16	MELA_BL, 18.00	Cajón 1 [1]_4	1	205.25	430.00	18.00
17	MELA_BL, 18.00	Lateral Der Cajón 1 [1]_1	1	578.00	182.25	18.00
18	MELA_BL, 18.00	Lateral Der Cajón 1 [1]_2	1	578.00	197.25	18.00
19	MELA_BL, 18.00	Lateral Der Cajón 1 [1]_3	1	578.00	197.25	18.00
20	MELA_BL, 18.00	Lateral Der Cajón 1 [1]_4	1	578.00	182.25	18.00
21	MELA_BL, 18.00	Lateral Izq Cajón 1 [1]_1	1	578.00	182.25	18.00
22	MELA_BL, 18.00	Lateral Izq Cajón 1 [1]_2	1	578.00	197.25	18.00
23	MELA_BL, 18.00	Lateral Izq Cajón 1 [1]_3	1	578.00	197.25	18.00
24	MELA_BL, 18.00	Lateral Izq Cajón 1 [1]_4	1	578.00	182.25	18.00
25	MELA_BL, 18.00	Fondo Cajón 1 [1]_1	1	560.00	358.00	18.00
26	MELA_BL, 18.00	Fondo Cajón 1 [1]_2	1	560.00	358.00	18.00
27	MELA_BL, 18.00	Fondo Cajón 1 [1]_3	1	560.00	358.00	18.00
28	MELA_BL, 18.00	Fondo Cajón 1 [1]_4	1	560.00	358.00	18.00
29	MELA_BL, 18.00	Trasera Cajón 1 [1]_1	1	358.00	182.25	18.00
30	MELA_BL, 18.00	Trasera Cajón 1 [1]_2	1	358.00	197.25	18.00
31	MELA_BL, 18.00	Trasera Cajón 1 [1]_3	1	358.00	197.25	18.00
32	MELA_BL, 18.00	Trasera Cajón 1 [1]_4	1	358.00	182.25	18.00

Num	Material	Referencia	Cantidad	Altura (mm)	Anchura (mm)	Espesor (mm)
1	MELA_BL, 18.00	Suelo	1	500.00	397.00	18.00
2	MELA_BL, 18.00	Trasera	1	1818.00	500.00	18.00
3	MELA_BL, 18.00	Estante Fijo [1]	1	536.00	379.00	18.00
4	Espejo, 5.00	División Libre 1 [1]	1	900.00	436.00	5.00
5	MELA_BL, 18.00	División Vertical [1]	1	848.00	397.00	18.00
6	MELA_BL, 18.00	División Vertical [2]	1	848.00	397.00	18.00
7	MELA_BL, 18.00	Cajón 1 [1]_1	1	205.25	530.00	18.00
8	MELA_BL, 18.00	Cajón 1 [1]_2	1	205.25	530.00	18.00
9	MELA_BL, 18.00	Cajón 1 [1]_3	1	205.25	530.00	18.00
10	MELA_BL, 18.00	Cajón 1 [1]_4	1	205.25	530.00	18.00
11	MELA_BL, 18.00	Lateral Der Cajón 1 [1]_1	1	360.00	182.25	18.00
12	MELA_BL, 18.00	Lateral Der Cajón 1 [1]_2	1	360.00	197.25	18.00
13	MELA_BL, 18.00	Lateral Der Cajón 1 [1]_3	1	360.00	197.25	18.00
14	MELA_BL, 18.00	Lateral Der Cajón 1 [1]_4	1	360.00	182.25	18.00
15	MELA_BL, 18.00	Lateral Izq Cajón 1 [1]_1	1	360.00	182.25	18.00
16	MELA_BL, 18.00	Lateral Izq Cajón 1 [1]_2	1	360.00	197.25	18.00
17	MELA_BL, 18.00	Lateral Izq Cajón 1 [1]_3	1	360.00	197.25	18.00
18	MELA_BL, 18.00	Lateral Izq Cajón 1 [1]_4	1	360.00	182.25	18.00
19	MELA_BL, 18.00	Fondo Cajón 1 [1]_1	1	458.00	342.00	18.00
20	MELA_BL, 18.00	Fondo Cajón 1 [1]_2	1	458.00	342.00	18.00
21	MELA_BL, 18.00	Fondo Cajón 1 [1]_3	1	458.00	342.00	18.00
22	MELA_BL, 18.00	Fondo Cajón 1 [1]_4	1	458.00	342.00	18.00
23	MELA_BL, 18.00	Trasera Cajón 1 [1]_1	1	458.00	182.25	18.00
24	MELA_BL, 18.00	Trasera Cajón 1 [1]_2	1	458.00	197.25	18.00
25	MELA_BL, 18.00	Trasera Cajón 1 [1]_3	1	458.00	197.25	18.00
26	MELA_BL, 18.00	Trasera Cajón 1 [1]_4	1	458.00	182.25	18.00
27	MELA_BL, 18.00	Contra-Frente Cajón 1 [1]_1	1	494.00	182.25	18.00
28	MELA_BL, 18.00	Contra-Frente Cajón 1 [1]_2	1	494.00	197.25	18.00
29	MELA_BL, 18.00	Contra-Frente Cajón 1 [1]_3	1	494.00	197.25	18.00
30	MELA_BL, 18.00	Contra-Frente Cajón 1 [1]_4	1	494.00	182.25	18.00
31	MELA_BL, 18.00	Zócalo 1 [1]	1	536.00	30.00	18.00
32	MELA_BL, 18.00	Zócalo 1 [2]	1	536.00	30.00	18.00



# Mueble Moderno #08

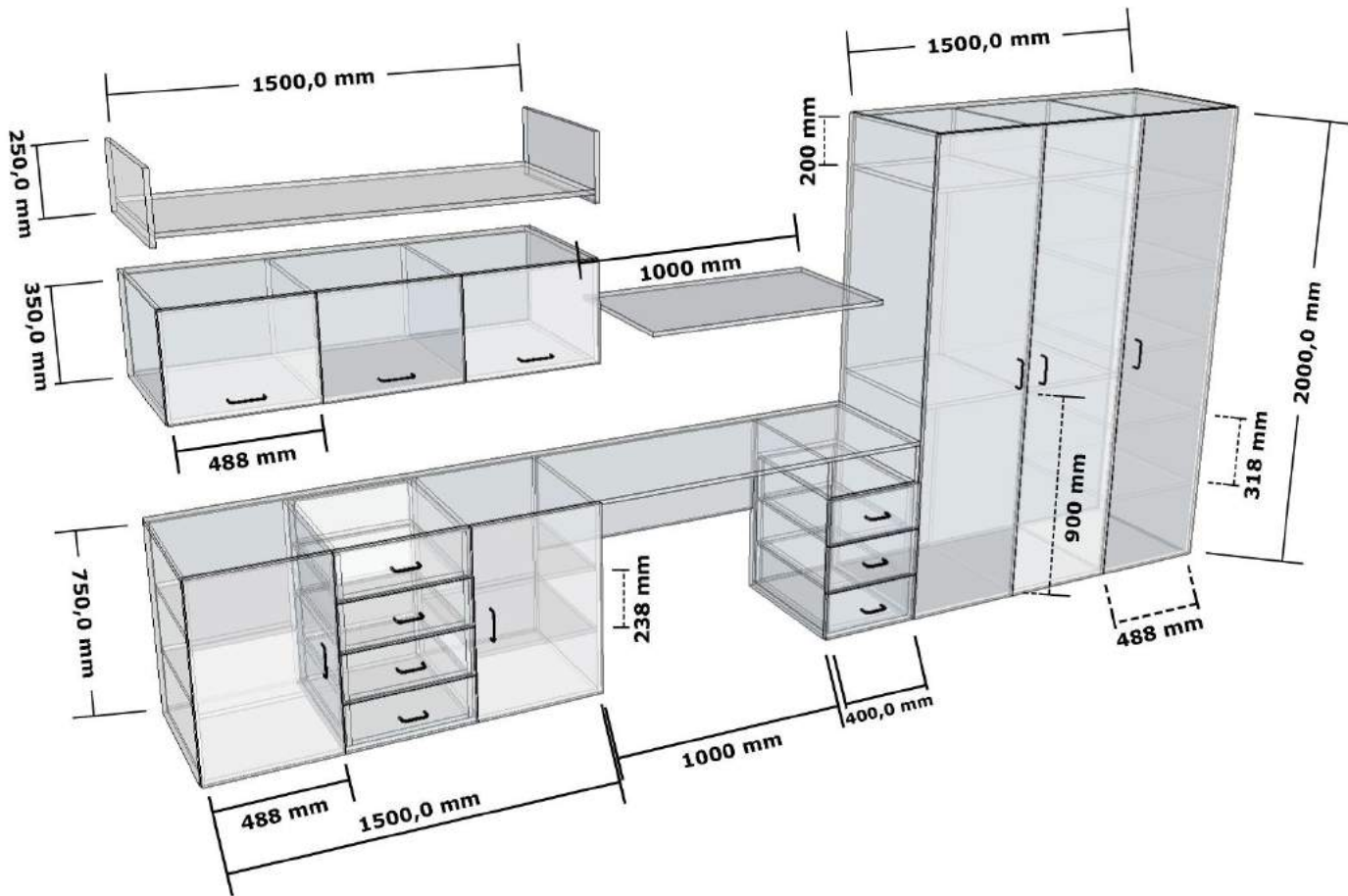
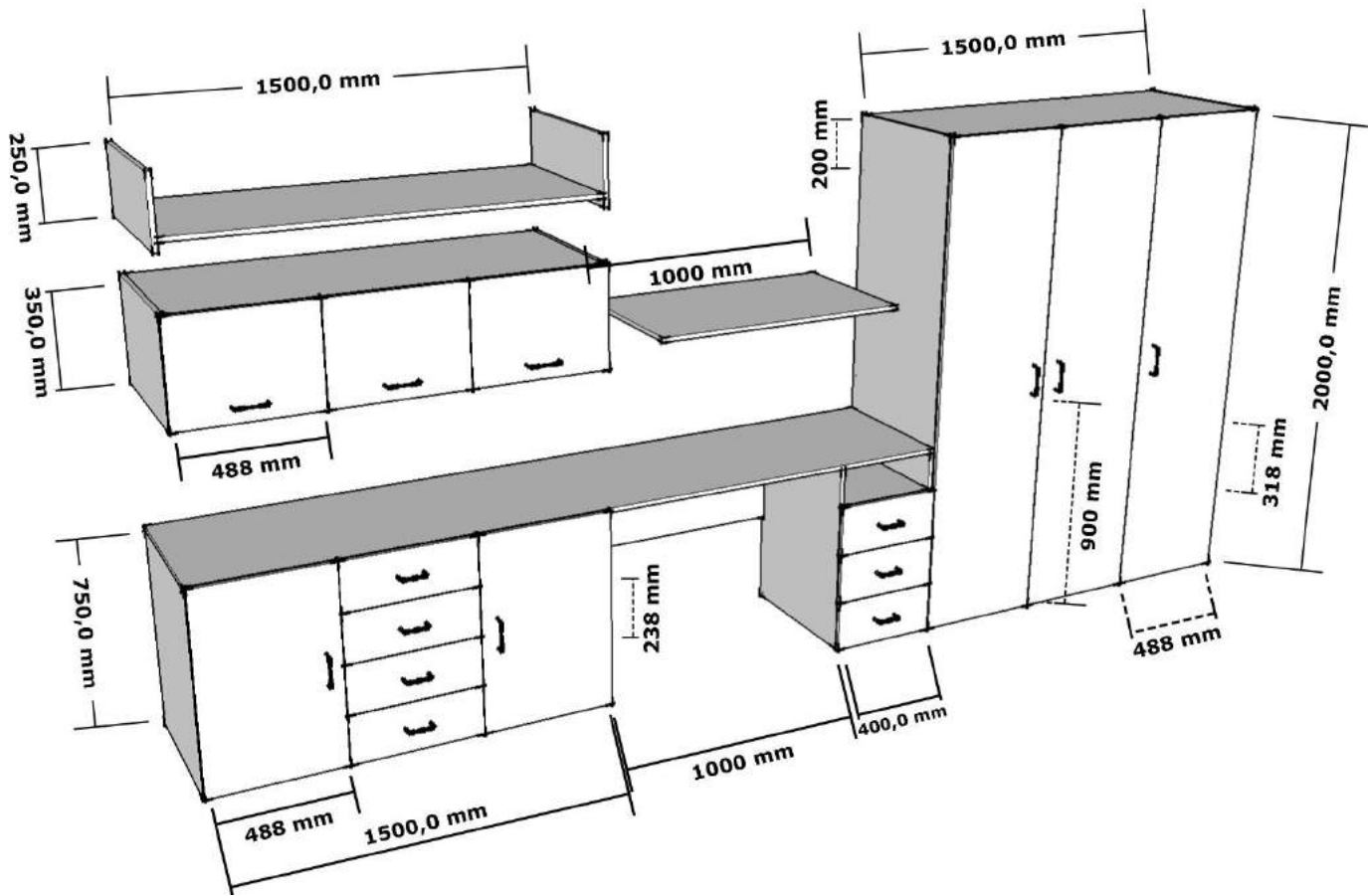

Num	Material	Referencia	Cantidad	Altura (mm)	Anchura (mm)	Espesor (mm)
1	MELA_BL, 18.00	Techo	1	2972.00	597.00	18.00
2	MELA_BL, 18.00	Lateral Derecho	1	768.00	597.00	18.00
3	MELA_BL, 18.00	Lateral Izquierdo	1	768.00	597.00	18.00
4	MELA_BL, 18.00	Estante Fijo [1]	1	1500.00	597.00	18.00
5	MELA_BL, 18.00	Estante Fijo [2]	1	488.00	579.00	18.00
6	MELA_BL, 18.00	Estante Fijo [3]	1	488.00	579.00	18.00
7	MELA_BL, 18.00	Estante Fijo [4]	1	488.00	579.00	18.00
8	MELA_BL, 18.00	Estante Fijo [5]	1	488.00	579.00	18.00
9	MELA_BL, 18.00	Estante Fijo [6]	1	400.00	597.00	18.00
10	MELA_BL, 18.00	Estante Fijo [7]	1	400.00	579.00	18.00
11	MELA_BL, 18.00	División Libre 1 [1]	1	1500.00	750.00	18.00
12	MELA_BL, 18.00	División Libre 1 [2]	1	1000.00	400.00	18.00
13	MELA_BL, 18.00	División Libre 1 [3]	1	750.00	400.00	18.00
14	MELA_BL, 18.00	División Vertical [1]	1	768.00	597.00	18.00
15	MELA_BL, 18.00	División Vertical [2]	1	750.00	579.00	18.00
16	MELA_BL, 18.00	División Vertical [3]	1	750.00	579.00	18.00
17	MELA_BL, 18.00	División Vertical [4]	1	768.00	597.00	18.00
18	MELA_BL, 18.00	Puerta 1 (unica) [1]	1	780.00	510.50	18.00
19	MELA_BL, 18.00	Puerta 1 (unica) [2]	1	780.00	510.50	18.00
20	MELA_BL, 18.00	Cajón 1 [1]_1	1	192.75	503.00	18.00
21	MELA_BL, 18.00	Cajón 1 [1]_2	1	192.75	503.00	18.00
22	MELA_BL, 18.00	Cajón 1 [1]_3	1	192.75	503.00	18.00
23	MELA_BL, 18.00	Cajón 1 [1]_4	1	192.75	503.00	18.00
24	MELA_BL, 18.00	Cajón 1 [2]_1	1	202.00	430.00	18.00
25	MELA_BL, 18.00	Cajón 1 [2]_2	1	202.00	430.00	18.00
26	MELA_BL, 18.00	Cajón 1 [2]_3	1	202.00	430.00	18.00
27	MELA_BL, 18.00	Lateral Der Cajón 1 [1]_1	1	578.00	169.75	18.00
28	MELA_BL, 18.00	Lateral Der Cajón 1 [1]_2	1	578.00	184.75	18.00
29	MELA_BL, 18.00	Lateral Der Cajón 1 [1]_3	1	578.00	184.75	18.00
30	MELA_BL, 18.00	Lateral Der Cajón 1 [1]_4	1	578.00	169.75	18.00
31	MELA_BL, 18.00	Lateral Der Cajón 1 [2]_1	1	560.00	179.00	18.00
32	MELA_BL, 18.00	Lateral Der Cajón 1 [2]_2	1	560.00	194.00	18.00
33	MELA_BL, 18.00	Lateral Der Cajón 1 [2]_3	1	560.00	179.00	18.00
34	MELA_BL, 18.00	Lateral Izq Cajón 1 [1]_1	1	578.00	169.75	18.00
35	MELA_BL, 18.00	Lateral Izq Cajón 1 [1]_2	1	578.00	184.75	18.00
36	MELA_BL, 18.00	Lateral Izq Cajón 1 [1]_3	1	578.00	184.75	18.00
37	MELA_BL, 18.00	Lateral Izq Cajón 1 [1]_4	1	578.00	169.75	18.00
38	MELA_BL, 18.00	Lateral Izq Cajón 1 [2]_1	1	560.00	179.00	18.00
39	MELA_BL, 18.00	Lateral Izq Cajón 1 [2]_2	1	560.00	194.00	18.00
40	MELA_BL, 18.00	Lateral Izq Cajón 1 [2]_3	1	560.00	179.00	18.00
41	MELA_BL, 18.00	Fondo Cajón 1 [1]_1	1	560.00	446.00	18.00
42	MELA_BL, 18.00	Fondo Cajón 1 [1]_2	1	560.00	446.00	18.00
43	MELA_BL, 18.00	Fondo Cajón 1 [1]_3	1	560.00	446.00	18.00
44	MELA_BL, 18.00	Fondo Cajón 1 [1]_4	1	560.00	446.00	18.00
45	MELA_BL, 18.00	Fondo Cajón 1 [2]_1	1	542.00	358.00	18.00
46	MELA_BL, 18.00	Fondo Cajón 1 [2]_2	1	542.00	358.00	18.00
47	MELA_BL, 18.00	Fondo Cajón 1 [2]_3	1	542.00	358.00	18.00
48	MELA_BL, 18.00	Trasera Cajón 1 [1]_1	1	446.00	169.75	18.00
49	MELA_BL, 18.00	Trasera Cajón 1 [1]_2	1	446.00	184.75	18.00
50	MELA_BL, 18.00	Trasera Cajón 1 [1]_3	1	446.00	184.75	18.00
51	MELA_BL, 18.00	Trasera Cajón 1 [1]_4	1	446.00	169.75	18.00
52	MELA_BL, 18.00	Trasera Cajón 1 [2]_1	1	358.00	179.00	18.00
53	MELA_BL, 18.00	Trasera Cajón 1 [2]_2	1	358.00	194.00	18.00
54	MELA_BL, 18.00	Trasera Cajón 1 [2]_3	1	358.00	179.00	18.00
55	MELA_BL, 18.00	Contra-Frente Cajón 1 [2]_1	1	394.00	179.00	18.00
56	MELA_BL, 18.00	Contra-Frente Cajón 1 [2]_2	1	394.00	194.00	18.00
57	MELA_BL, 18.00	Contra-Frente Cajón 1 [2]_3	1	394.00	179.00	18.00

Num	Material	Referencia	Cantidad	Altura (mm)	Anchura (mm)	Espesor (mm)
1	MELA_BL, 18.00	Techo	1	1500.00	597.00	18.00
2	MELA_BL, 18.00	Suelo	1	1500.00	597.00	18.00
3	MELA_BL, 18.00	Lateral Derecho	1	2036.00	597.00	18.00
4	MELA_BL, 18.00	Lateral Izquierdo	1	2036.00	597.00	18.00
5	MELA_BL, 18.00	Trasera	1	2000.00	1500.00	18.00
6	MELA_BL, 18.00	Estante Fijo [1]	1	488.00	579.00	18.00
7	MELA_BL, 18.00	Estante Fijo [2]	1	488.00	579.00	18.00
8	MELA_BL, 18.00	Estante Fijo [3]	1	488.00	579.00	18.00
9	MELA_BL, 18.00	Estante Fijo [4]	1	488.00	579.00	18.00
10	MELA_BL, 18.00	Estante Fijo [5]	1	488.00	579.00	18.00
11	MELA_BL, 18.00	Estante Fijo [6]	1	488.00	579.00	18.00
12	MELA_BL, 18.00	Estante Fijo [7]	1	488.00	579.00	18.00
13	MELA_BL, 18.00	Estante Fijo [8]	1	488.00	579.00	18.00
14	MELA_BL, 18.00	Estante Fijo [9]	1	488.00	579.00	18.00
15	MELA_BL, 18.00	División Vertical [1]	1	2000.00	579.00	18.00
16	MELA_BL, 18.00	División Vertical [2]	1	2000.00	579.00	18.00
17	MELA_BL, 18.00	Puerta 1 (unica) [1]	1	2030.00	510.50	18.00
18	MELA_BL, 18.00	Puerta 1 (unica) [2]	1	2030.00	503.00	18.00
19	MELA_BL, 18.00	Puerta 1 (unica) [3]	1	2030.00	510.50	18.00

Num	Material	Referencia	Cantidad	Altura (mm)	Anchura (mm)	Espesor (mm)
1	MELA_BL, 18.00	Techo	1	1500.00	597.00	18.00
2	MELA_BL, 18.00	Suelo	1	1500.00	597.00	18.00
3	MELA_BL, 18.00	Lateral Derecho	1	386.00	597.00	18.00
4	MELA_BL, 18.00	Lateral Izquierdo	1	386.00	597.00	18.00
5	MELA_BL, 18.00	Trasera	1	350.00	1500.00	18.00
6	MELA_BL, 18.00	División Vertical [1]	1	350.00	579.00	18.00
7	MELA_BL, 18.00	División Vertical [2]	1	350.00	579.00	18.00
8	MELA_BL, 18.00	Puerta 1 (unica) [1]	1	380.00	510.50	18.00
9	MELA_BL, 18.00	Puerta 1 (unica) [2]	1	380.00	503.00	18.00
10	MELA_BL, 18.00	Puerta 1 (unica) [3]	1	380.00	510.50	18.00

Num	Material	Referencia	Cantidad	Altura (mm)	Anchura (mm)	Espesor (mm)
1	MELA_BL, 18.00	Lateral Derecho	1	250.00	618.00	18.00
2	MELA_BL, 18.00	Lateral Izquierdo	1	250.00	618.00	18.00
3	MELA_BL, 18.00	Estante Fijo [1]	1	1500.00	618.00	18.00

Num	Material	Referencia	Cantidad	Altura (mm)	Anchura (mm)	Espesor (mm)
1	MELA_BL, 18.00	Suelo	1	1000.00	600.00	18.00

## Mueble Moderno #09

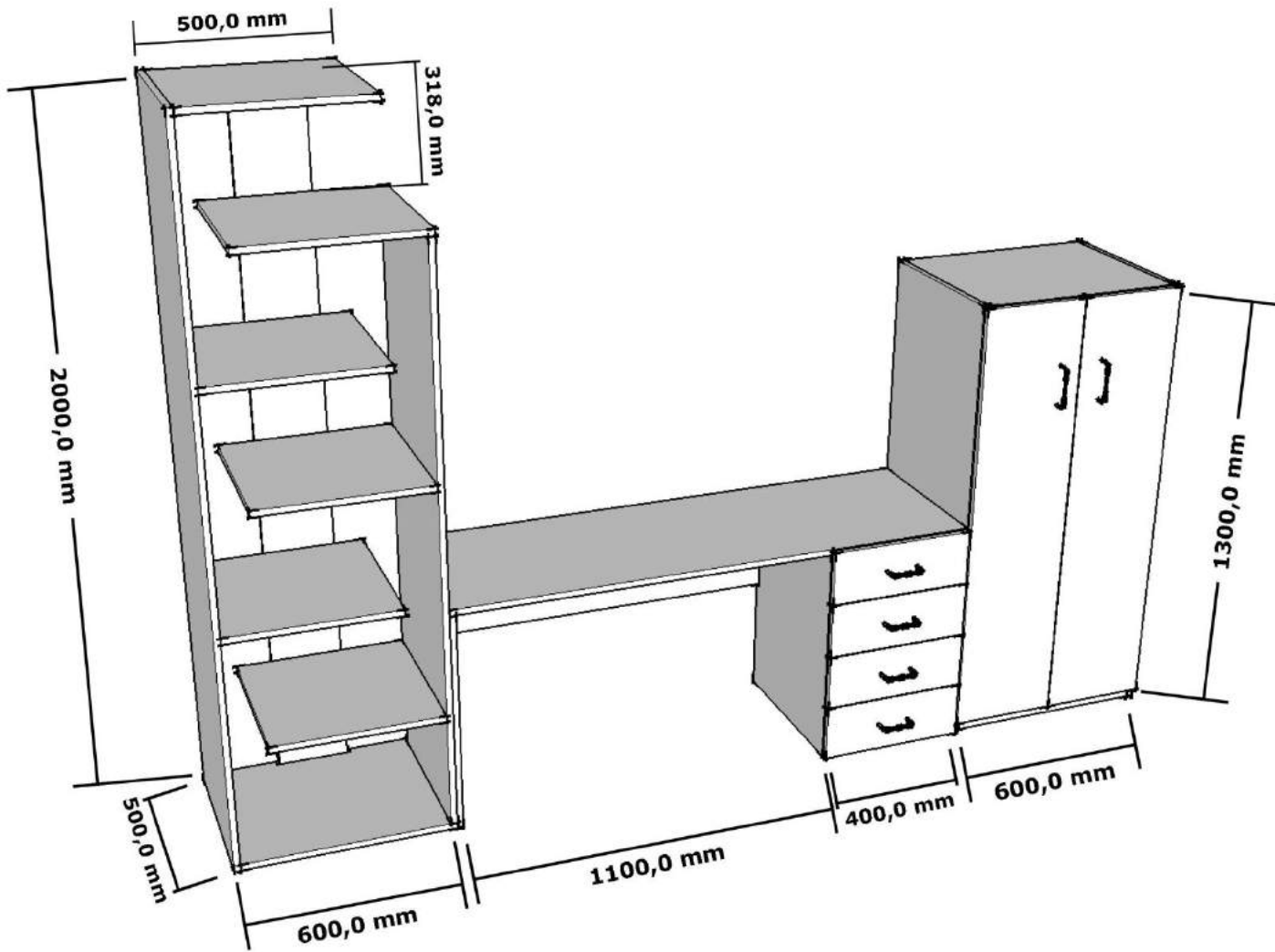

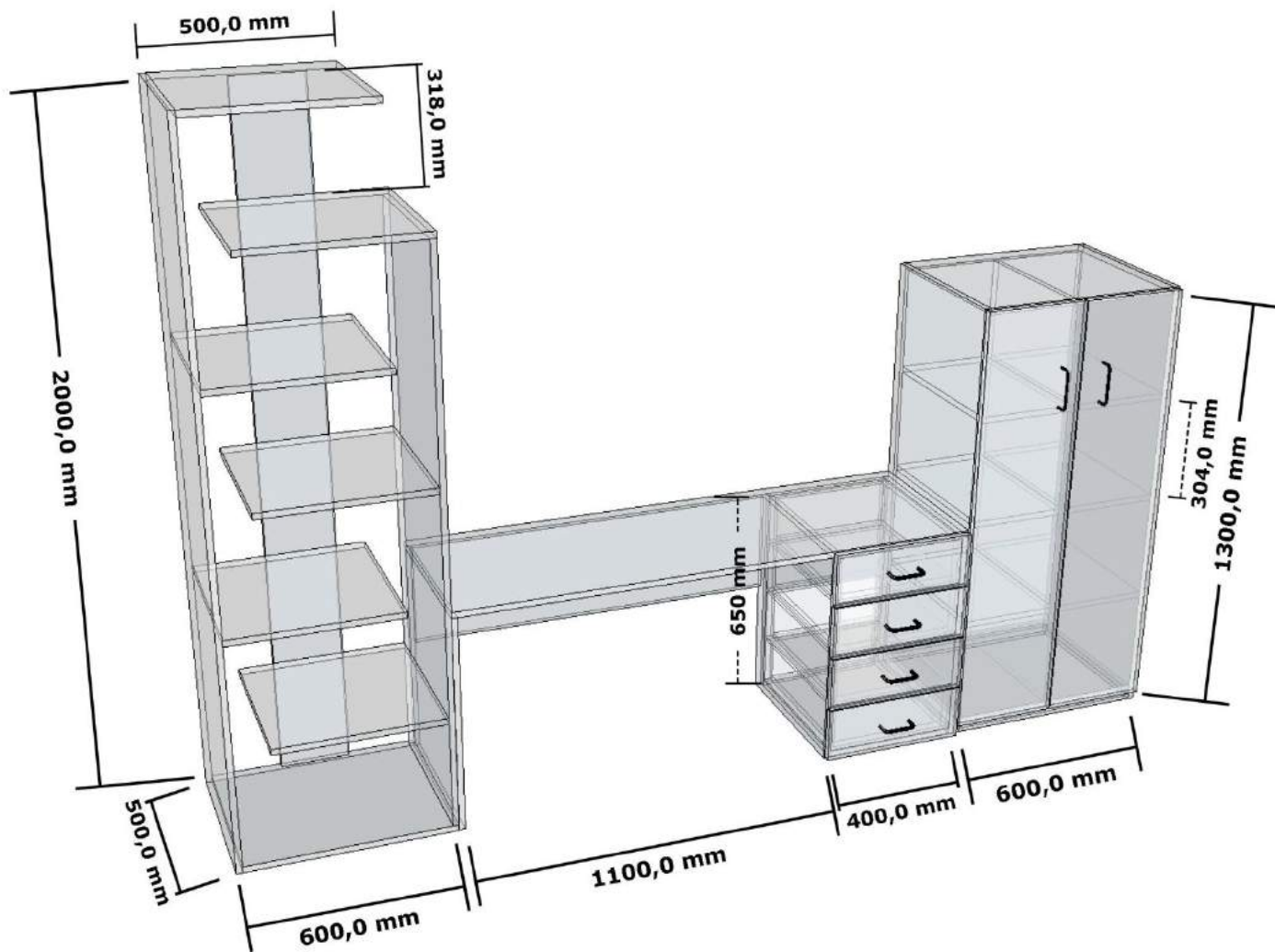

Num	Material	Referencia	Cantidad	Altura (mm)	Anchura (mm)	Espesor (mm)
1	MELA_BL, 18.00	Techo	1	482.00	500.00	18.00
2	MELA_BL, 18.00	Suelo	1	600.00	500.00	18.00
3	MELA_BL, 18.00	Lateral Izquierdo	1	2036.00	500.00	18.00
4	MELA_BL, 18.00	Estante Fijo [1]	1	500.00	482.00	18.00
5	MELA_BL, 18.00	Estante Fijo [2]	1	482.00	482.00	18.00
6	MELA_BL, 18.00	Estante Fijo [3]	1	482.00	482.00	18.00
7	MELA_BL, 18.00	Estante Fijo [4]	1	482.00	482.00	18.00
8	MELA_BL, 18.00	Estante Fijo [5]	1	482.00	482.00	18.00
9	MELA_BL, 18.00	División Libre 1 [1]	1	2000.00	200.00	18.00
10	MELA_BL, 18.00	División Vertical [1]	1	1664.00	500.00	18.00

Num	Material	Referencia	Cantidad	Altura (mm)	Anchura (mm)	Espesor (mm)
1	MELA_BL, 18.00	Techo	1	1554.00	497.00	18.00
2	MELA_BL, 18.00	Lateral Derecho	1	650.00	497.00	18.00
3	MELA_BL, 18.00	Lateral Izquierdo	1	650.00	497.00	18.00
4	MELA_BL, 18.00	División Libre 1 [1]	1	650.00	400.00	18.00
5	MELA_BL, 18.00	División Libre 1 [2]	1	479.00	400.00	18.00
6	MELA_BL, 18.00	División Libre 1 [3]	1	1100.00	300.00	18.00
7	MELA_BL, 18.00	División Vertical [1]	1	650.00	497.00	18.00
8	MELA_BL, 18.00	Cajón 1 [1]_1	1	163.25	430.00	18.00
9	MELA_BL, 18.00	Cajón 1 [1]_2	1	163.25	430.00	18.00
10	MELA_BL, 18.00	Cajón 1 [1]_3	1	163.25	430.00	18.00
11	MELA_BL, 18.00	Cajón 1 [1]_4	1	163.25	430.00	18.00
12	MELA_BL, 18.00	Lateral Der Cajón 1 [1]_1	1	460.00	140.25	18.00
13	MELA_BL, 18.00	Lateral Der Cajón 1 [1]_2	1	460.00	155.25	18.00
14	MELA_BL, 18.00	Lateral Der Cajón 1 [1]_3	1	460.00	155.25	18.00
15	MELA_BL, 18.00	Lateral Der Cajón 1 [1]_4	1	460.00	140.25	18.00
16	MELA_BL, 18.00	Lateral Izq Cajón 1 [1]_1	1	460.00	140.25	18.00
17	MELA_BL, 18.00	Lateral Izq Cajón 1 [1]_2	1	460.00	155.25	18.00
18	MELA_BL, 18.00	Lateral Izq Cajón 1 [1]_3	1	460.00	155.25	18.00
19	MELA_BL, 18.00	Lateral Izq Cajón 1 [1]_4	1	460.00	140.25	18.00
20	MELA_BL, 18.00	Fondo Cajón 1 [1]_1	1	442.00	358.00	18.00
21	MELA_BL, 18.00	Fondo Cajón 1 [1]_2	1	442.00	358.00	18.00
22	MELA_BL, 18.00	Fondo Cajón 1 [1]_3	1	442.00	358.00	18.00
23	MELA_BL, 18.00	Fondo Cajón 1 [1]_4	1	442.00	358.00	18.00
24	MELA_BL, 18.00	Trasera Cajón 1 [1]_1	1	358.00	140.25	18.00
25	MELA_BL, 18.00	Trasera Cajón 1 [1]_2	1	358.00	155.25	18.00
26	MELA_BL, 18.00	Trasera Cajón 1 [1]_3	1	358.00	155.25	18.00
27	MELA_BL, 18.00	Trasera Cajón 1 [1]_4	1	358.00	140.25	18.00
28	MELA_BL, 18.00	Contra-Frente Cajón 1 [1]_1	1	394.00	140.25	18.00
29	MELA_BL, 18.00	Contra-Frente Cajón 1 [1]_2	1	394.00	155.25	18.00
30	MELA_BL, 18.00	Contra-Frente Cajón 1 [1]_3	1	394.00	155.25	18.00
31	MELA_BL, 18.00	Contra-Frente Cajón 1 [1]_4	1	394.00	140.25	18.00

Num	Material	Referencia	Cantidad	Altura (mm)	Anchura (mm)	Espesor (mm)
1	MELA_BL, 18.00	Techo	1	600.00	497.00	18.00
2	MELA_BL, 18.00	Suelo	1	600.00	497.00	18.00
3	MELA_BL, 18.00	Lateral Derecho	1	1336.00	497.00	18.00
4	MELA_BL, 18.00	Lateral Izquierdo	1	1336.00	497.00	18.00
5	MELA_BL, 18.00	Trasera	1	1270.00	600.00	18.00
6	MELA_BL, 18.00	Estante Fijo [1]	1	291.00	479.00	18.00
7	MELA_BL, 18.00	Estante Fijo [2]	1	291.00	479.00	18.00
8	MELA_BL, 18.00	Estante Fijo [3]	1	291.00	479.00	18.00
9	MELA_BL, 18.00	Estante Fijo [4]	1	291.00	479.00	18.00
10	MELA_BL, 18.00	Estante Fijo [5]	1	291.00	479.00	18.00
11	MELA_BL, 18.00	Estante Fijo [6]	1	291.00	479.00	18.00
12	MELA_BL, 18.00	División Vertical [1]	1	1270.00	479.00	18.00
13	MELA_BL, 18.00	Puerta 1 (doble) [1]_1	1	1300.00	313.50	18.00
14	MELA_BL, 18.00	Puerta 1 (doble) [1]_2	1	1300.00	313.50	18.00
15	MELA_BL, 18.00	Zócalo 1 [1]	1	600.00	30.00	18.00
16	MELA_BL, 18.00	Zócalo 1 [2]	1	600.00	30.00	18.00

# Mueble Moderno #10

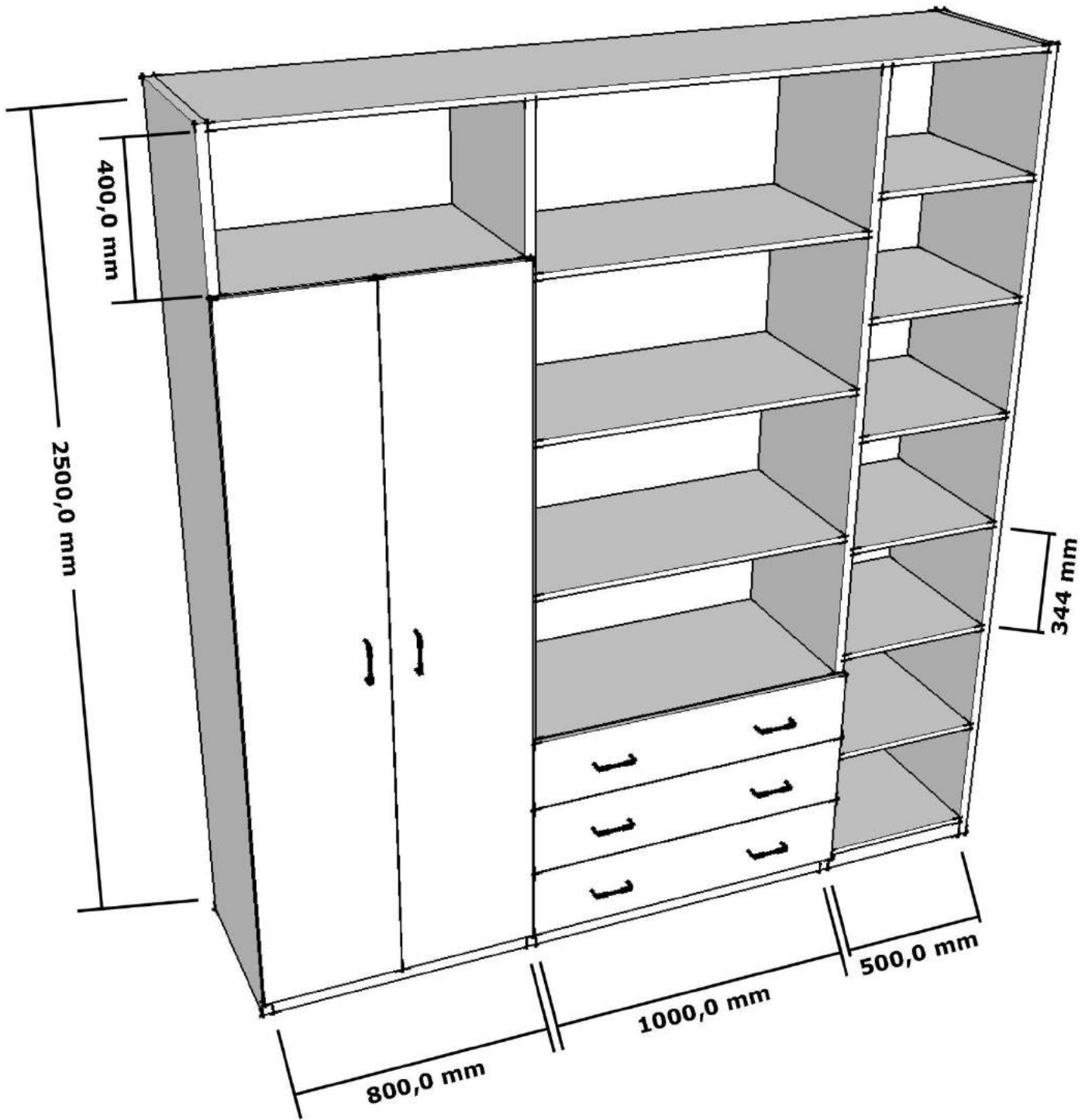

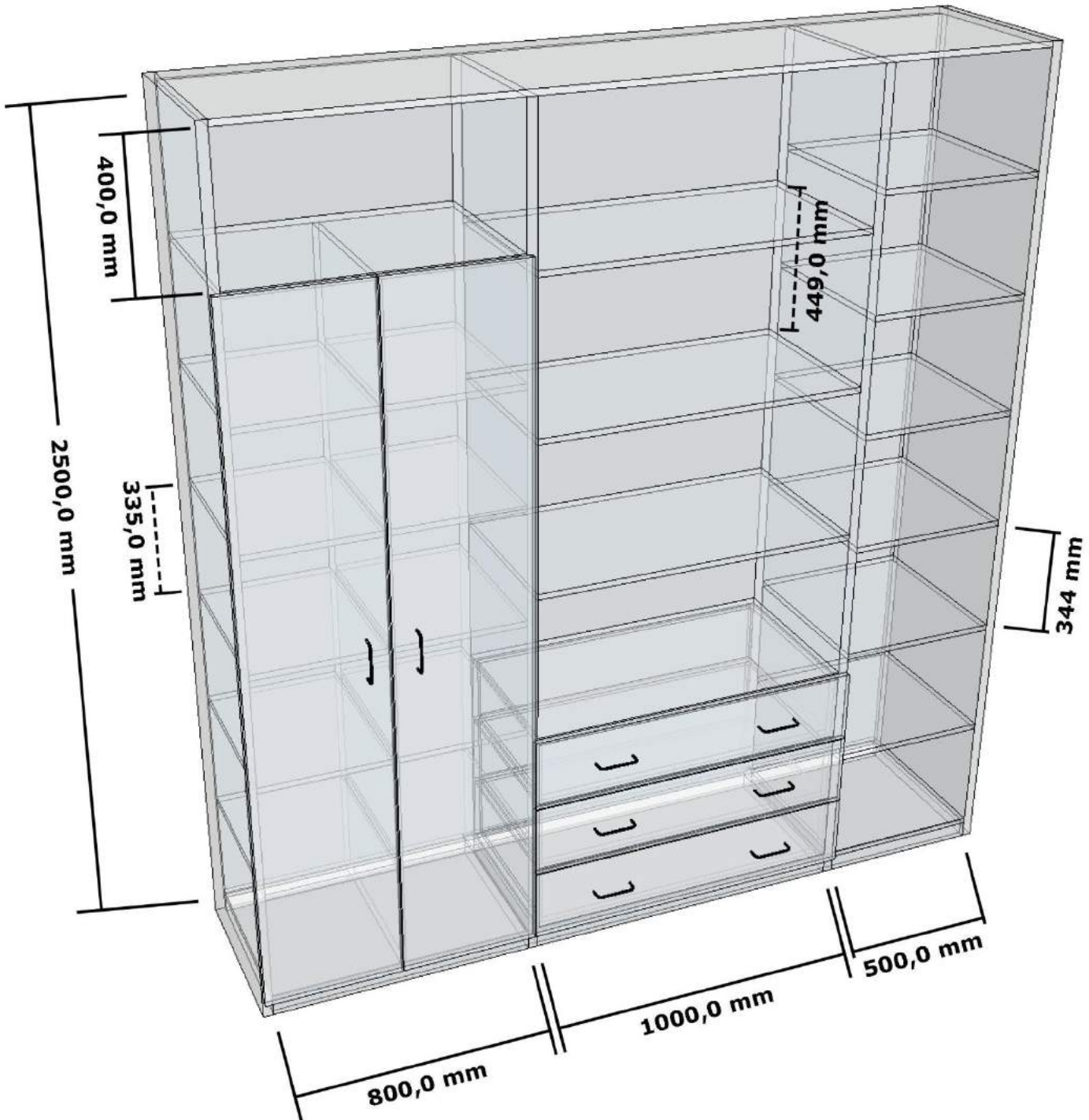



Num	Material	Referencia	Cantidad	Altura (mm)	Anchura (mm)	Espesor (mm)
1	MELA_BL, 18.00	Techo	1	2360.00	557.00	18.00
2	MELA_BL, 18.00	Suelo_1	1	800.00	557.00	18.00
3	MELA_BL, 18.00	Suelo_2	1	1000.00	557.00	18.00
4	MELA_BL, 18.00	Suelo_3	1	500.00	557.00	18.00
5	MELA_BL 30mm, 30.00	Lateral Derecho	1	2604.00	557.00	30.00
6	MELA_BL 30mm, 30.00	Lateral Izquierdo	1	2604.00	557.00	30.00
7	MELA_BL, 18.00	Trasera	1	2518.00	2360.00	18.00
8	MELA_BL, 18.00	Estante Fijo [1]	1	800.00	539.00	18.00
9	MELA_BL, 18.00	Estante Fijo [2]	1	391.00	539.00	18.00
10	MELA_BL, 18.00	Estante Fijo [3]	1	391.00	539.00	18.00
11	MELA_BL, 18.00	Estante Fijo [4]	1	391.00	539.00	18.00
12	MELA_BL, 18.00	Estante Fijo [5]	1	391.00	539.00	18.00
13	MELA_BL, 18.00	Estante Fijo [6]	1	391.00	539.00	18.00
14	MELA_BL, 18.00	Estante Fijo [7]	1	391.00	539.00	18.00
15	MELA_BL, 18.00	Estante Fijo [8]	1	391.00	539.00	18.00
16	MELA_BL, 18.00	Estante Fijo [9]	1	391.00	539.00	18.00
17	MELA_BL, 18.00	Estante Fijo [10]	1	391.00	539.00	18.00
18	MELA_BL, 18.00	Estante Fijo [11]	1	391.00	539.00	18.00
19	MELA_BL, 18.00	Estante Fijo [12]	1	1000.00	539.00	18.00
20	MELA_BL, 18.00	Estante Fijo [13]	1	1000.00	539.00	18.00
21	MELA_BL, 18.00	Estante Fijo [14]	1	1000.00	539.00	18.00
22	MELA_BL, 18.00	Estante Fijo [15]	1	1000.00	539.00	18.00
23	MELA_BL, 18.00	Estante Fijo [16]	1	500.00	539.00	18.00
24	MELA_BL, 18.00	Estante Fijo [17]	1	500.00	539.00	18.00
25	MELA_BL, 18.00	Estante Fijo [18]	1	500.00	539.00	18.00
26	MELA_BL, 18.00	Estante Fijo [19]	1	500.00	539.00	18.00
27	MELA_BL, 18.00	Estante Fijo [20]	1	500.00	539.00	18.00
28	MELA_BL, 18.00	Estante Fijo [21]	1	500.00	539.00	18.00
29	MELA_BL 30mm, 30.00	División Vertical [1]	1	2586.00	539.00	30.00
30	MELA_BL 30mm, 30.00	División Vertical [2]	1	2586.00	539.00	30.00
31	MELA_BL, 18.00	División Vertical [3]	1	2100.00	539.00	18.00
32	MELA_BL, 18.00	Puerta 1 (doble) [1]_1	1	2130.00	418.75	18.00
33	MELA_BL, 18.00	Puerta 1 (doble) [1]_2	1	2130.00	418.75	18.00
34	MELA_BL, 18.00	Cajón 1 [1]_1	1	224.67	1040.50	18.00
35	MELA_BL, 18.00	Cajón 1 [1]_2	1	224.67	1040.50	18.00
36	MELA_BL, 18.00	Cajón 1 [1]_3	1	224.67	1040.50	18.00
37	MELA_BL, 18.00	Lateral Der Cajón 1 [1]_1	1	520.00	201.67	18.00
38	MELA_BL, 18.00	Lateral Der Cajón 1 [1]_2	1	520.00	216.67	18.00
39	MELA_BL, 18.00	Lateral Der Cajón 1 [1]_3	1	520.00	201.67	18.00
40	MELA_BL, 18.00	Lateral Izq Cajón 1 [1]_1	1	520.00	201.67	18.00
41	MELA_BL, 18.00	Lateral Izq Cajón 1 [1]_2	1	520.00	216.67	18.00
42	MELA_BL, 18.00	Lateral Izq Cajón 1 [1]_3	1	520.00	201.67	18.00
43	MELA_BL, 18.00	Fondo Cajón 1 [1]_1	1	958.00	502.00	18.00
44	MELA_BL, 18.00	Fondo Cajón 1 [1]_2	1	958.00	502.00	18.00
45	MELA_BL, 18.00	Fondo Cajón 1 [1]_3	1	958.00	502.00	18.00
46	MELA_BL, 18.00	Trasera Cajón 1 [1]_1	1	958.00	201.67	18.00
47	MELA_BL, 18.00	Trasera Cajón 1 [1]_2	1	958.00	216.67	18.00
48	MELA_BL, 18.00	Trasera Cajón 1 [1]_3	1	958.00	201.67	18.00
49	MELA_BL, 18.00	Contra-Frente Cajón 1 [1]_1	1	994.00	201.67	18.00
50	MELA_BL, 18.00	Contra-Frente Cajón 1 [1]_2	1	994.00	216.67	18.00
51	MELA_BL, 18.00	Contra-Frente Cajón 1 [1]_3	1	994.00	201.67	18.00
52	MELA_BL, 18.00	Zócalo 1 [1]	1	2360.00	50.00	18.00
53	MELA_BL, 18.00	Zócalo 1 [2]	1	2360.00	50.00	18.00

# Mueble Moderno #11

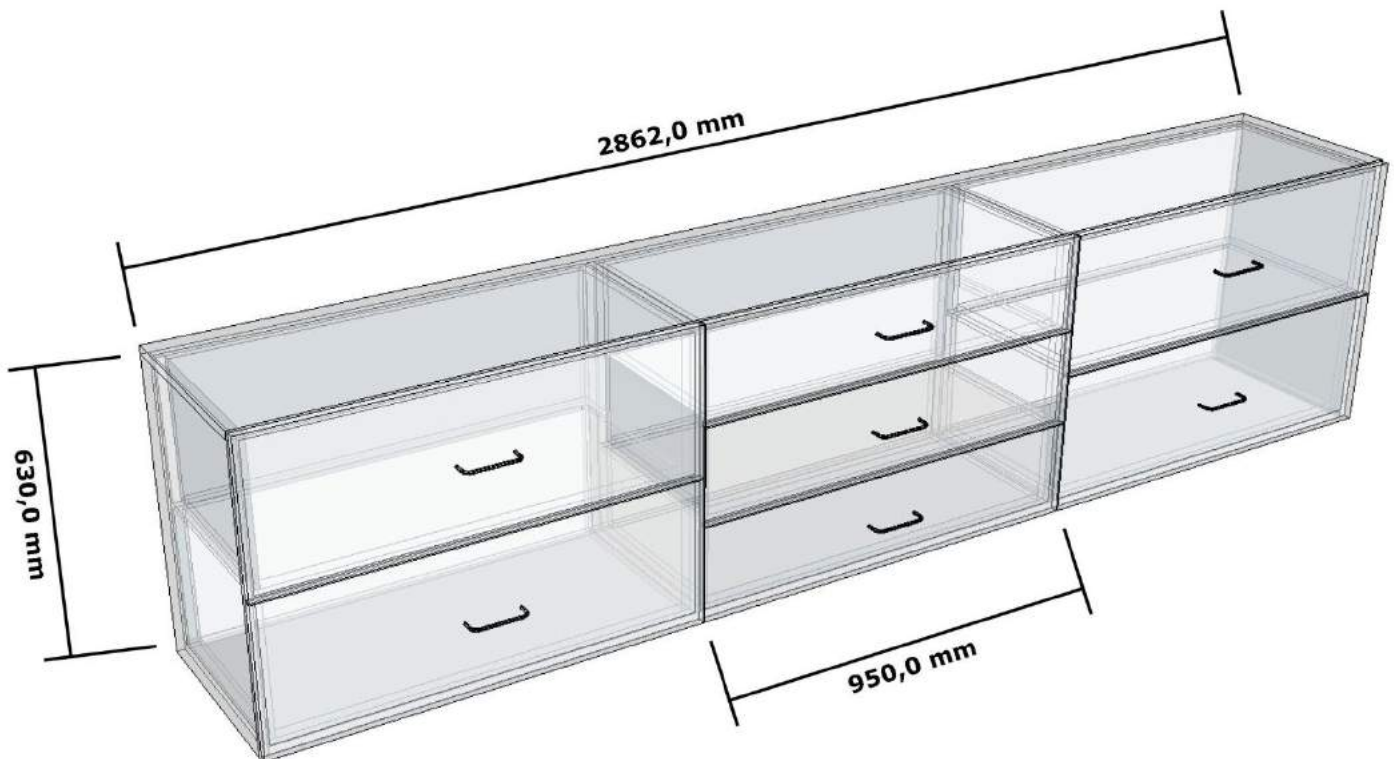
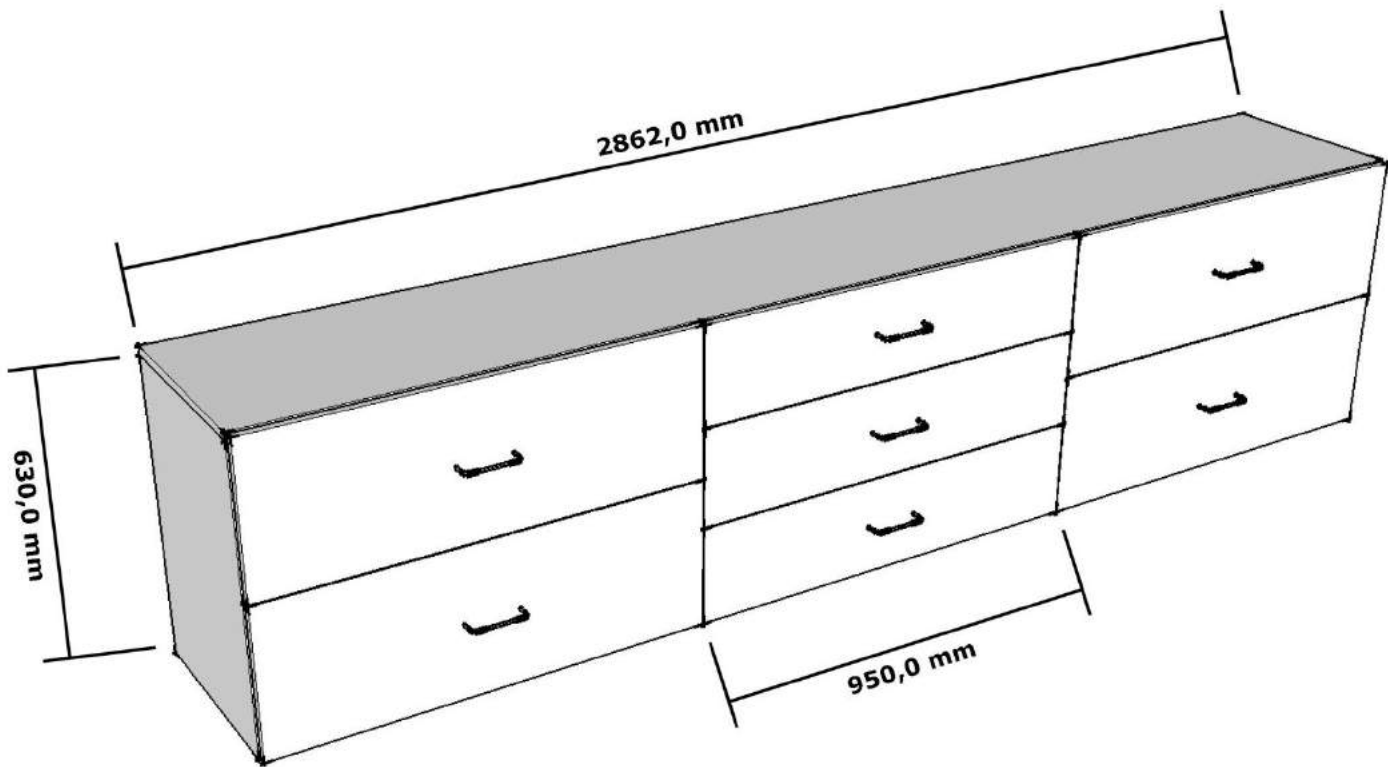

Num	Material	Referencia	Cantidad	Altura (mm)	Anchura (mm)	Espesor (mm)
1	MELA_BL, 18.00	Techo	1	2862.00	447.00	18.00
2	MELA_BL, 18.00	Suelo	1	2826.00	447.00	18.00
3	MELA_BL, 18.00	Lateral Derecho	1	648.00	447.00	18.00
4	MELA_BL, 18.00	Lateral Izquierdo	1	648.00	447.00	18.00
5	MELA_BL, 18.00	Trasera	1	600.00	2826.00	18.00
6	MELA_BL, 18.00	División Vertical [1]	1	600.00	429.00	18.00
7	MELA_BL, 18.00	División Vertical [2]	1	600.00	429.00	18.00
8	MELA_BL, 18.00	Cajón 1 [1]_1	1	313.50	952.50	18.00
9	MELA_BL, 18.00	Cajón 1 [1]_2	1	313.50	952.50	18.00
10	MELA_BL, 18.00	Cajón 1 [2]_1	1	208.00	945.00	18.00
11	MELA_BL, 18.00	Cajón 1 [2]_2	1	208.00	945.00	18.00
12	MELA_BL, 18.00	Cajón 1 [2]_3	1	208.00	945.00	18.00
13	MELA_BL, 18.00	Cajón 1 [3]_1	1	313.50	952.50	18.00
14	MELA_BL, 18.00	Cajón 1 [3]_2	1	313.50	952.50	18.00
15	MELA_BL, 18.00	Lateral Der Cajón 1 [1]_1	1	410.00	290.50	18.00
16	MELA_BL, 18.00	Lateral Der Cajón 1 [1]_2	1	410.00	290.50	18.00
17	MELA_BL, 18.00	Lateral Der Cajón 1 [2]_1	1	410.00	185.00	18.00
18	MELA_BL, 18.00	Lateral Der Cajón 1 [2]_2	1	410.00	200.00	18.00
19	MELA_BL, 18.00	Lateral Der Cajón 1 [2]_3	1	410.00	185.00	18.00
20	MELA_BL, 18.00	Lateral Der Cajón 1 [3]_1	1	410.00	290.50	18.00
21	MELA_BL, 18.00	Lateral Der Cajón 1 [3]_2	1	410.00	290.50	18.00
22	MELA_BL, 18.00	Lateral Izq Cajón 1 [1]_1	1	410.00	290.50	18.00
23	MELA_BL, 18.00	Lateral Izq Cajón 1 [1]_2	1	410.00	290.50	18.00
24	MELA_BL, 18.00	Lateral Izq Cajón 1 [2]_1	1	410.00	185.00	18.00
25	MELA_BL, 18.00	Lateral Izq Cajón 1 [2]_2	1	410.00	200.00	18.00
26	MELA_BL, 18.00	Lateral Izq Cajón 1 [2]_3	1	410.00	185.00	18.00
27	MELA_BL, 18.00	Lateral Izq Cajón 1 [3]_1	1	410.00	290.50	18.00
28	MELA_BL, 18.00	Lateral Izq Cajón 1 [3]_2	1	410.00	290.50	18.00
29	MELA_BL, 18.00	Fondo Cajón 1 [1]_1	1	888.00	392.00	18.00
30	MELA_BL, 18.00	Fondo Cajón 1 [1]_2	1	888.00	392.00	18.00
31	MELA_BL, 18.00	Fondo Cajón 1 [2]_1	1	888.00	392.00	18.00
32	MELA_BL, 18.00	Fondo Cajón 1 [2]_2	1	888.00	392.00	18.00
33	MELA_BL, 18.00	Fondo Cajón 1 [2]_3	1	888.00	392.00	18.00
34	MELA_BL, 18.00	Fondo Cajón 1 [3]_1	1	888.00	392.00	18.00
35	MELA_BL, 18.00	Fondo Cajón 1 [3]_2	1	888.00	392.00	18.00
36	MELA_BL, 18.00	Trasera Cajón 1 [1]_1	1	888.00	290.50	18.00
37	MELA_BL, 18.00	Trasera Cajón 1 [1]_2	1	888.00	290.50	18.00
38	MELA_BL, 18.00	Trasera Cajón 1 [2]_1	1	888.00	185.00	18.00
39	MELA_BL, 18.00	Trasera Cajón 1 [2]_2	1	888.00	200.00	18.00
40	MELA_BL, 18.00	Trasera Cajón 1 [2]_3	1	888.00	185.00	18.00
41	MELA_BL, 18.00	Trasera Cajón 1 [3]_1	1	888.00	290.50	18.00
42	MELA_BL, 18.00	Trasera Cajón 1 [3]_2	1	888.00	290.50	18.00
43	MELA_BL, 18.00	Contra-Frente Cajón 1 [1]_1	1	924.00	290.50	18.00
44	MELA_BL, 18.00	Contra-Frente Cajón 1 [1]_2	1	924.00	290.50	18.00
45	MELA_BL, 18.00	Contra-Frente Cajón 1 [2]_1	1	924.00	185.00	18.00
46	MELA_BL, 18.00	Contra-Frente Cajón 1 [2]_2	1	924.00	200.00	18.00
47	MELA_BL, 18.00	Contra-Frente Cajón 1 [2]_3	1	924.00	185.00	18.00
48	MELA_BL, 18.00	Contra-Frente Cajón 1 [3]_1	1	924.00	290.50	18.00
49	MELA_BL, 18.00	Contra-Frente Cajón 1 [3]_2	1	924.00	290.50	18.00
50	MELA_BL, 18.00	Zócalo 1 [1]	1	2826.00	30.00	18.00
51	MELA_BL, 18.00	Zócalo 1 [2]	1	2826.00	30.00	18.00

## Mueble Moderno #12

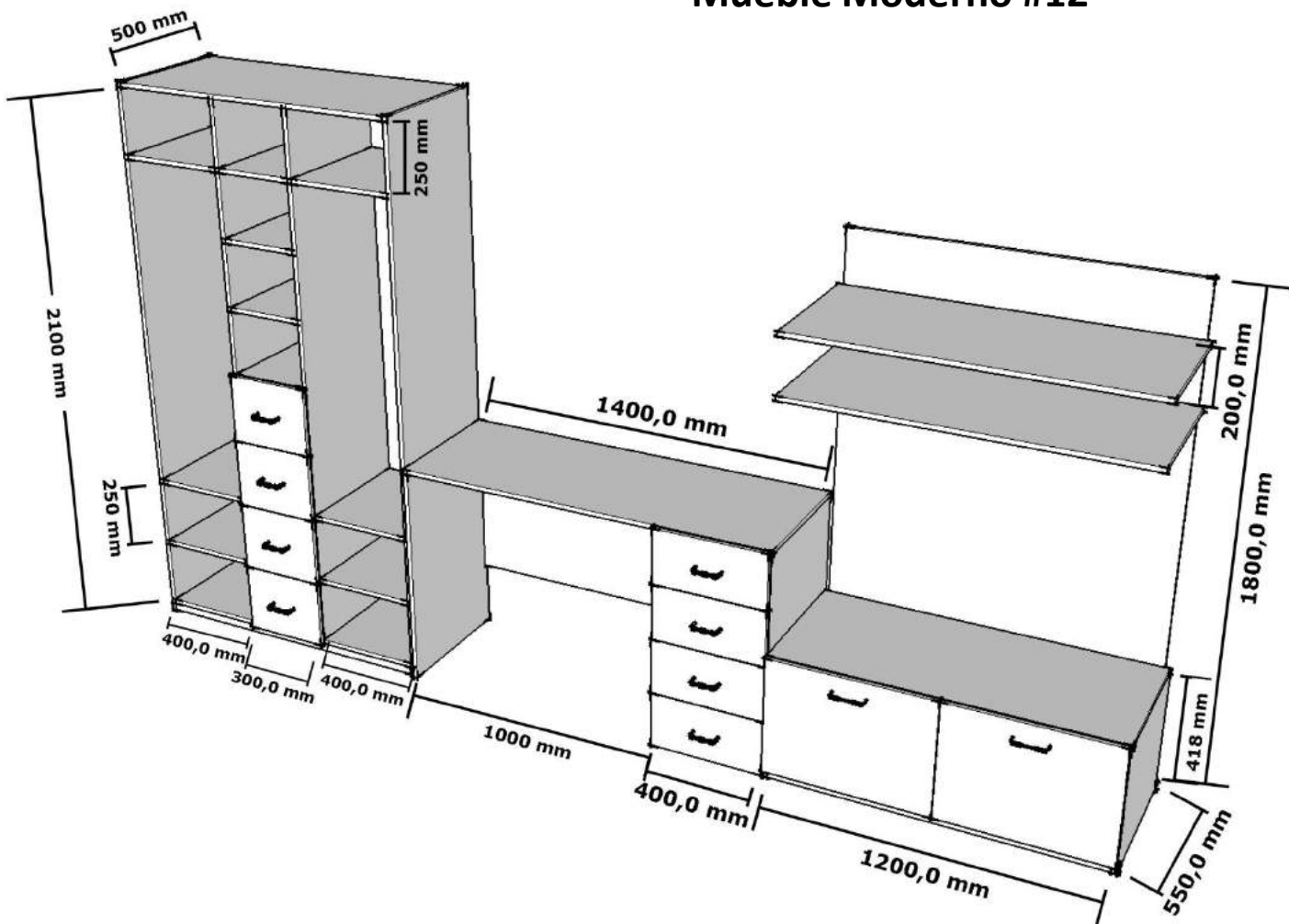

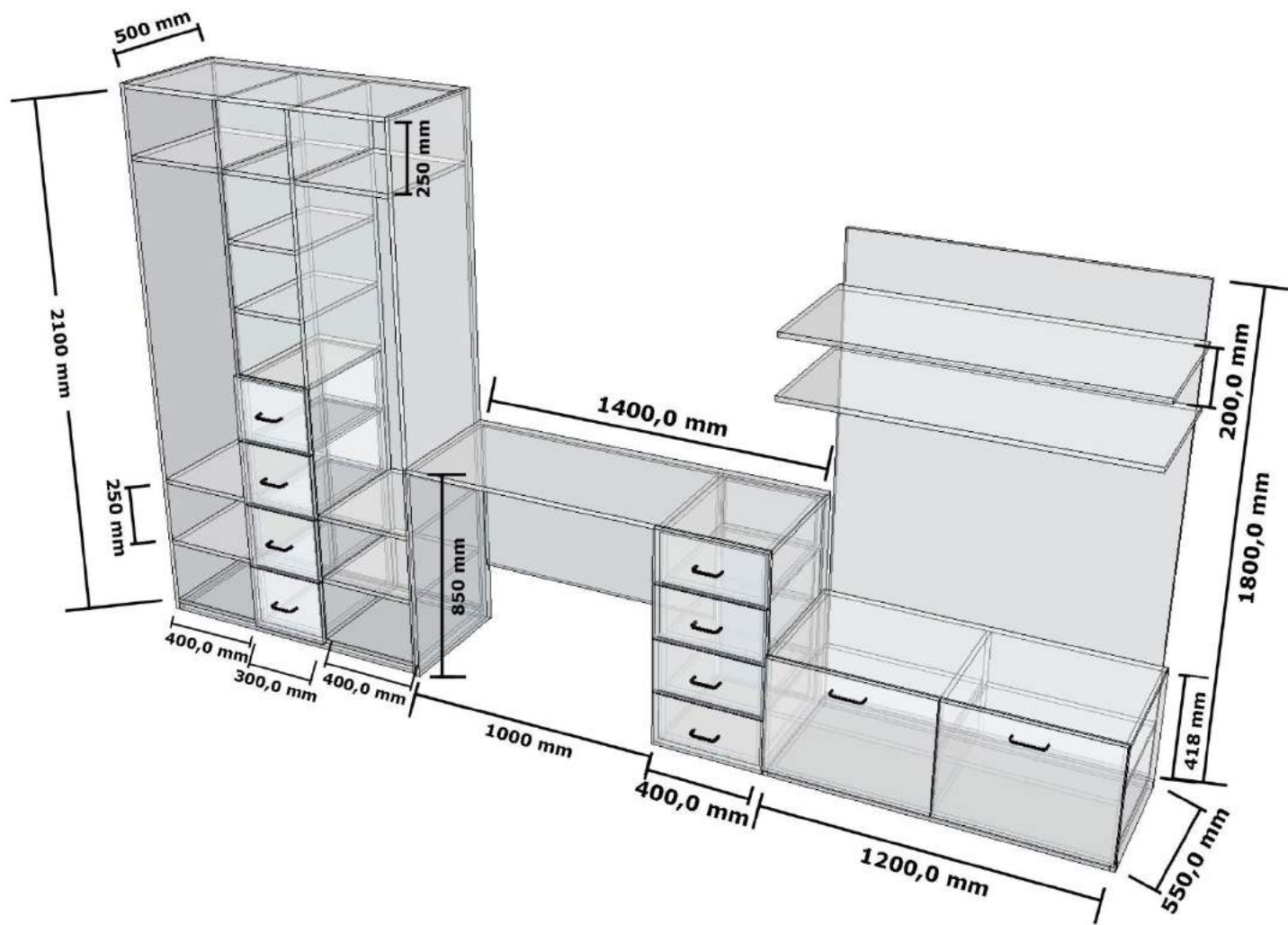

Num	Material	Referencia	Cantidad	Altura (mm)	Anchura (mm)	Espesor (mm)
1	MELA_BL, 18.00	Techo	1	1136.00	517.00	18.00
2	MELA_BL, 18.00	Suelo	1	1136.00	517.00	18.00
3	MELA_BL, 18.00	Lateral Derecho	1	2166.00	517.00	18.00
4	MELA_BL, 18.00	Lateral Izquierdo	1	2166.00	517.00	18.00
5	MELA_BL, 18.00	Trasera	1	2100.00	1136.00	18.00
6	MELA_BL, 18.00	Estante Fijo [1]	1	400.00	499.00	18.00
7	MELA_BL, 18.00	Estante Fijo [2]	1	400.00	499.00	18.00
8	MELA_BL, 18.00	Estante Fijo [3]	1	300.00	499.00	18.00
9	MELA_BL, 18.00	Estante Fijo [4]	1	400.00	499.00	18.00
10	MELA_BL, 18.00	Estante Fijo [5]	1	400.00	499.00	18.00
11	MELA_BL, 18.00	Estante Fijo [6]	1	400.00	499.00	18.00
12	MELA_BL, 18.00	Estante Fijo [7]	1	400.00	499.00	18.00
13	MELA_BL, 18.00	Estante Fijo [8]	1	300.00	499.00	18.00
14	MELA_BL, 18.00	Estante Fijo [9]	1	300.00	499.00	18.00
15	MELA_BL, 18.00	Estante Fijo [10]	1	300.00	499.00	18.00
16	MELA_BL, 18.00	División Vertical [1]	1	2100.00	499.00	18.00
17	MELA_BL, 18.00	División Vertical [2]	1	2100.00	499.00	18.00
18	MELA_BL, 18.00	Cajón 1 [1]_1	1	265.25	330.00	18.00
19	MELA_BL, 18.00	Cajón 1 [1]_2	1	265.25	330.00	18.00
20	MELA_BL, 18.00	Cajón 1 [1]_3	1	265.25	330.00	18.00
21	MELA_BL, 18.00	Cajón 1 [1]_4	1	265.25	330.00	18.00
22	MELA_BL, 18.00	Lateral Der Cajón 1 [1]_1	1	480.00	242.25	18.00
23	MELA_BL, 18.00	Lateral Der Cajón 1 [1]_2	1	480.00	257.25	18.00
24	MELA_BL, 18.00	Lateral Der Cajón 1 [1]_3	1	480.00	257.25	18.00
25	MELA_BL, 18.00	Lateral Der Cajón 1 [1]_4	1	480.00	242.25	18.00
26	MELA_BL, 18.00	Lateral Izq Cajón 1 [1]_1	1	480.00	242.25	18.00
27	MELA_BL, 18.00	Lateral Izq Cajón 1 [1]_2	1	480.00	257.25	18.00
28	MELA_BL, 18.00	Lateral Izq Cajón 1 [1]_3	1	480.00	257.25	18.00
29	MELA_BL, 18.00	Lateral Izq Cajón 1 [1]_4	1	480.00	242.25	18.00
30	MELA_BL, 18.00	Fondo Cajón 1 [1]_1	1	462.00	258.00	18.00
31	MELA_BL, 18.00	Fondo Cajón 1 [1]_2	1	462.00	258.00	18.00
32	MELA_BL, 18.00	Fondo Cajón 1 [1]_3	1	462.00	258.00	18.00
33	MELA_BL, 18.00	Fondo Cajón 1 [1]_4	1	462.00	258.00	18.00
34	MELA_BL, 18.00	Trasera Cajón 1 [1]_1	1	258.00	242.25	18.00
35	MELA_BL, 18.00	Trasera Cajón 1 [1]_2	1	258.00	257.25	18.00
36	MELA_BL, 18.00	Trasera Cajón 1 [1]_3	1	258.00	257.25	18.00
37	MELA_BL, 18.00	Trasera Cajón 1 [1]_4	1	258.00	242.25	18.00
38	MELA_BL, 18.00	Contra-Frente Cajón 1 [1]_1	1	294.00	242.25	18.00
39	MELA_BL, 18.00	Contra-Frente Cajón 1 [1]_2	1	294.00	257.25	18.00
40	MELA_BL, 18.00	Contra-Frente Cajón 1 [1]_3	1	294.00	257.25	18.00
41	MELA_BL, 18.00	Contra-Frente Cajón 1 [1]_4	1	294.00	242.25	18.00
42	MELA_BL, 18.00	Zócalo 1 [1]	1	1136.00	30.00	18.00
43	MELA_BL, 18.00	Zócalo 1 [2]	1	1136.00	30.00	18.00

Num	Material	Referencia	Cantidad	Altura (mm)	Anchura (mm)	Espesor (mm)
1	MELA_BL, 18.00	Techo	1	1454.00	529.00	18.00
2	MELA_BL, 18.00	Lateral Derecho	1	850.00	529.00	18.00
3	MELA_BL, 18.00	Lateral Izquierdo	1	850.00	529.00	18.00
4	MELA_BL, 18.00	Estante Fijo [1]	1	400.00	511.00	18.00
5	MELA_BL, 18.00	División Libre 1 [1]	1	850.00	400.00	18.00
6	MELA_BL, 18.00	División Libre 1 [2]	1	1000.00	600.00	18.00
7	MELA_BL, 18.00	División Vertical [1]	1	850.00	529.00	18.00
8	MELA_BL, 18.00	Cajón 1 [1]_1	1	213.25	430.00	18.00
9	MELA_BL, 18.00	Cajón 1 [1]_2	1	213.25	430.00	18.00
10	MELA_BL, 18.00	Cajón 1 [1]_3	1	213.25	430.00	18.00
11	MELA_BL, 18.00	Cajón 1 [1]_4	1	213.25	430.00	18.00
12	MELA_BL, 18.00	Lateral Der Cajón 1 [1]_1	1	492.00	190.25	18.00
13	MELA_BL, 18.00	Lateral Der Cajón 1 [1]_2	1	492.00	205.25	18.00
14	MELA_BL, 18.00	Lateral Der Cajón 1 [1]_3	1	492.00	205.25	18.00
15	MELA_BL, 18.00	Lateral Der Cajón 1 [1]_4	1	492.00	190.25	18.00
16	MELA_BL, 18.00	Lateral Izq Cajón 1 [1]_1	1	492.00	190.25	18.00
17	MELA_BL, 18.00	Lateral Izq Cajón 1 [1]_2	1	492.00	205.25	18.00
18	MELA_BL, 18.00	Lateral Izq Cajón 1 [1]_3	1	492.00	205.25	18.00
19	MELA_BL, 18.00	Lateral Izq Cajón 1 [1]_4	1	492.00	190.25	18.00
20	MELA_BL, 18.00	Fondo Cajón 1 [1]_1	1	474.00	358.00	18.00
21	MELA_BL, 18.00	Fondo Cajón 1 [1]_2	1	474.00	358.00	18.00
22	MELA_BL, 18.00	Fondo Cajón 1 [1]_3	1	474.00	358.00	18.00
23	MELA_BL, 18.00	Fondo Cajón 1 [1]_4	1	474.00	358.00	18.00
24	MELA_BL, 18.00	Trasera Cajón 1 [1]_1	1	358.00	190.25	18.00
25	MELA_BL, 18.00	Trasera Cajón 1 [1]_2	1	358.00	205.25	18.00
26	MELA_BL, 18.00	Trasera Cajón 1 [1]_3	1	358.00	205.25	18.00
27	MELA_BL, 18.00	Trasera Cajón 1 [1]_4	1	358.00	190.25	18.00
28	MELA_BL, 18.00	Contra-Frente Cajón 1 [1]_1	1	394.00	190.25	18.00
29	MELA_BL, 18.00	Contra-Frente Cajón 1 [1]_2	1	394.00	205.25	18.00
30	MELA_BL, 18.00	Contra-Frente Cajón 1 [1]_3	1	394.00	205.25	18.00
31	MELA_BL, 18.00	Contra-Frente Cajón 1 [1]_4	1	394.00	190.25	18.00

Num	Material	Referencia	Cantidad	Altura (mm)	Anchura (mm)	Espesor (mm)
1	MELA_BL, 18.00	Suelo	1	1200.00	547.00	18.00
2	MELA_BL, 18.00	Trasera	1	1800.00	1200.00	18.00
3	MELA_BL, 18.00	Estante Fijo [1]	1	1236.00	529.00	18.00
4	MELA_BL, 18.00	Estante Fijo [2]	1	591.00	529.00	18.00
5	MELA_BL, 18.00	Estante Fijo [3]	1	591.00	529.00	18.00
6	MELA_BL, 18.00	Estante Fijo [4]	1	1236.00	529.00	18.00
7	MELA_BL, 18.00	Estante Fijo [5]	1	1236.00	529.00	18.00
8	MELA_BL, 18.00	División Vertical [1]	1	466.00	547.00	18.00
9	MELA_BL, 18.00	División Vertical [2]	1	466.00	547.00	18.00
10	MELA_BL, 18.00	División Vertical [3]	1	418.00	529.00	18.00
11	MELA_BL, 18.00	Puerta 1 (unica) [1]	1	448.00	613.50	18.00
12	MELA_BL, 18.00	Puerta 1 (unica) [2]	1	448.00	613.50	18.00
13	MELA_BL, 18.00	Zócalo 1 [1]	1	1236.00	30.00	18.00
14	MELA_BL, 18.00	Zócalo 1 [2]	1	1236.00	30.00	18.00

# Mueble Moderno #13

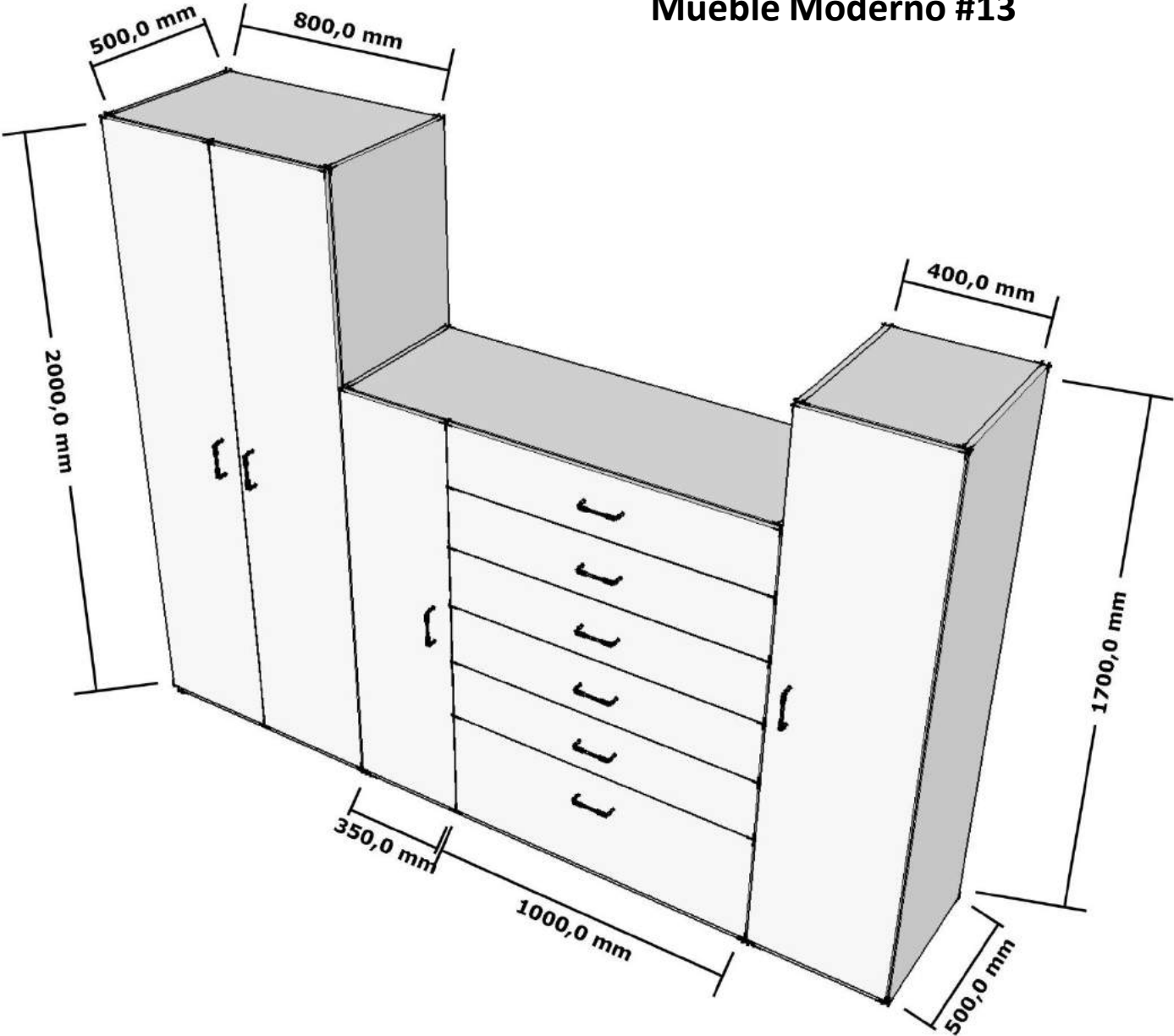



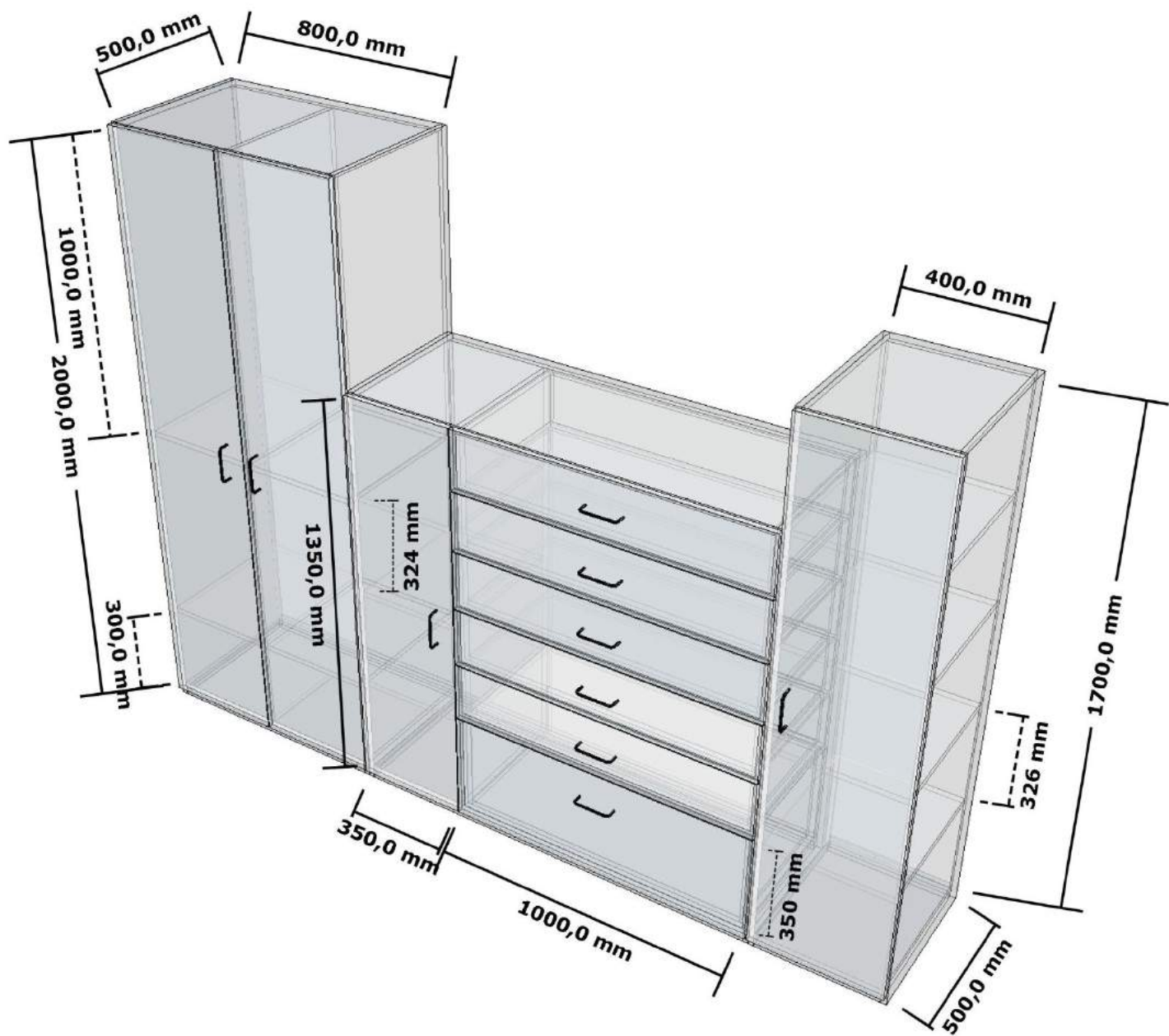

Num	Material	Referencia	Cantidad	Altura (mm)	Anchura (mm)	Espesor (mm)
1	MELA_BL, 18.00	Techo	1	800.00	518.00	18.00
2	MELA_BL, 18.00	Suelo	1	800.00	518.00	18.00
3	MELA_BL, 18.00	Lateral Derecho	1	2066.00	518.00	18.00
4	MELA_BL, 18.00	Lateral Izquierdo	1	2066.00	518.00	18.00
5	MELA_BL, 18.00	Trasera	1	2000.00	800.00	18.00
6	MELA_BL, 18.00	Estante Fijo [1]	1	391.00	500.00	18.00
7	MELA_BL, 18.00	Estante Fijo [2]	1	391.00	500.00	18.00
8	MELA_BL, 18.00	Estante Fijo [3]	1	391.00	500.00	18.00
9	MELA_BL, 18.00	Estante Fijo [4]	1	391.00	500.00	18.00
10	MELA_BL, 18.00	División Vertical [1]	1	2000.00	500.00	18.00
11	MELA_BL, 18.00	Puerta 1 (doble) [1]_1	1	2030.00	413.50	18.00
12	MELA_BL, 18.00	Puerta 1 (doble) [1]_2	1	2030.00	413.50	18.00
13	MELA_BL, 18.00	Zócalo 1 [1]	1	800.00	30.00	18.00
14	MELA_BL, 18.00	Zócalo 1 [2]	1	800.00	30.00	18.00

Num	Material	Referencia	Cantidad	Altura (mm)	Anchura (mm)	Espesor (mm)
1	MELA_BL, 18.00	Techo	1	1368.00	497.00	18.00
2	MELA_BL, 18.00	Suelo	1	1368.00	497.00	18.00
3	MELA_BL, 18.00	Lateral Derecho	1	1416.00	497.00	18.00
4	MELA_BL, 18.00	Lateral Izquierdo	1	1416.00	497.00	18.00
5	MELA_BL, 18.00	Trasera	1	1350.00	1368.00	18.00
6	MELA_BL, 18.00	Estante Fijo [1]	1	350.00	479.00	18.00
7	MELA_BL, 18.00	Estante Fijo [2]	1	350.00	479.00	18.00
8	MELA_BL, 18.00	Estante Fijo [3]	1	350.00	479.00	18.00
9	MELA_BL, 18.00	Estante Fijo [4]	1	1000.00	479.00	18.00
10	MELA_BL, 18.00	División Vertical [1]	1	1350.00	479.00	18.00
11	MELA_BL, 18.00	Puerta 1 (unica) [1]	1	1380.00	372.50	18.00
12	MELA_BL, 18.00	Cajón 1 [1]_1	1	198.50	1022.50	18.00
13	MELA_BL, 18.00	Cajón 1 [1]_2	1	198.50	1022.50	18.00
14	MELA_BL, 18.00	Cajón 1 [1]_3	1	198.50	1022.50	18.00
15	MELA_BL, 18.00	Cajón 1 [1]_4	1	198.50	1022.50	18.00
16	MELA_BL, 18.00	Cajón 1 [1]_5	1	198.50	1022.50	18.00
17	MELA_BL, 18.00	Cajón 1 [2]	1	372.50	1022.50	18.00
18	MELA_BL, 18.00	Lateral Der Cajón 1 [1]_1	1	460.00	175.50	18.00
19	MELA_BL, 18.00	Lateral Der Cajón 1 [1]_2	1	460.00	190.50	18.00
20	MELA_BL, 18.00	Lateral Der Cajón 1 [1]_3	1	460.00	190.50	18.00
21	MELA_BL, 18.00	Lateral Der Cajón 1 [1]_4	1	460.00	190.50	18.00
22	MELA_BL, 18.00	Lateral Der Cajón 1 [1]_5	1	460.00	183.00	18.00
23	MELA_BL, 18.00	Lateral Der Cajón 1 [2]	1	460.00	342.00	18.00
24	MELA_BL, 18.00	Lateral Izq Cajón 1 [1]_1	1	460.00	175.50	18.00
25	MELA_BL, 18.00	Lateral Izq Cajón 1 [1]_2	1	460.00	190.50	18.00
26	MELA_BL, 18.00	Lateral Izq Cajón 1 [1]_3	1	460.00	190.50	18.00
27	MELA_BL, 18.00	Lateral Izq Cajón 1 [1]_4	1	460.00	190.50	18.00
28	MELA_BL, 18.00	Lateral Izq Cajón 1 [1]_5	1	460.00	183.00	18.00
29	MELA_BL, 18.00	Lateral Izq Cajón 1 [2]	1	460.00	342.00	18.00
30	MELA_BL, 18.00	Fondo Cajón 1 [1]_1	1	958.00	442.00	18.00
31	MELA_BL, 18.00	Fondo Cajón 1 [1]_2	1	958.00	442.00	18.00
32	MELA_BL, 18.00	Fondo Cajón 1 [1]_3	1	958.00	442.00	18.00
33	MELA_BL, 18.00	Fondo Cajón 1 [1]_4	1	958.00	442.00	18.00
34	MELA_BL, 18.00	Fondo Cajón 1 [1]_5	1	958.00	442.00	18.00
35	MELA_BL, 18.00	Fondo Cajón 1 [2]	1	958.00	442.00	18.00
36	MELA_BL, 18.00	Trasera Cajón 1 [1]_1	1	958.00	175.50	18.00
37	MELA_BL, 18.00	Trasera Cajón 1 [1]_2	1	958.00	190.50	18.00
38	MELA_BL, 18.00	Trasera Cajón 1 [1]_3	1	958.00	190.50	18.00
39	MELA_BL, 18.00	Trasera Cajón 1 [1]_4	1	958.00	190.50	18.00
40	MELA_BL, 18.00	Trasera Cajón 1 [1]_5	1	958.00	183.00	18.00
41	MELA_BL, 18.00	Trasera Cajón 1 [2]	1	958.00	342.00	18.00
42	MELA_BL, 18.00	Contra-Frente Cajón 1 [1]_1	1	994.00	175.50	18.00
43	MELA_BL, 18.00	Contra-Frente Cajón 1 [1]_2	1	994.00	190.50	18.00
44	MELA_BL, 18.00	Contra-Frente Cajón 1 [1]_3	1	994.00	190.50	18.00
45	MELA_BL, 18.00	Contra-Frente Cajón 1 [1]_4	1	994.00	190.50	18.00
46	MELA_BL, 18.00	Contra-Frente Cajón 1 [1]_5	1	994.00	183.00	18.00
47	MELA_BL, 18.00	Contra-Frente Cajón 1 [2]	1	994.00	342.00	18.00
48	MELA_BL, 18.00	Zócalo 1 [1]	1	1368.00	30.00	18.00
49	MELA_BL, 18.00	Zócalo 1 [2]	1	1368.00	30.00	18.00

Num	Material	Referencia	Cantidad	Altura (mm)	Anchura (mm)	Espesor (mm)
1	MELA_BL, 18.00	Techo	1	400.00	518.00	18.00
2	MELA_BL, 18.00	Suelo	1	400.00	518.00	18.00
3	MELA_BL, 18.00	Lateral Derecho	1	1766.00	518.00	18.00
4	MELA_BL, 18.00	Lateral Izquierdo	1	1766.00	518.00	18.00
5	MELA_BL, 18.00	Trasera	1	1700.00	400.00	18.00
6	MELA_BL, 18.00	Estante Fijo [1]	1	400.00	500.00	18.00
7	MELA_BL, 18.00	Estante Fijo [2]	1	400.00	500.00	18.00
8	MELA_BL, 18.00	Estante Fijo [3]	1	400.00	500.00	18.00
9	MELA_BL, 18.00	Estante Fijo [4]	1	400.00	500.00	18.00
10	MELA_BL, 18.00	Puerta 1 (unica) [1]	1	1730.00	430.00	18.00
11	MELA_BL, 18.00	Zócalo 1 [1]	1	400.00	30.00	18.00
12	MELA_BL, 18.00	Zócalo 1 [2]	1	400.00	30.00	18.00

# Mueble Moderno #14

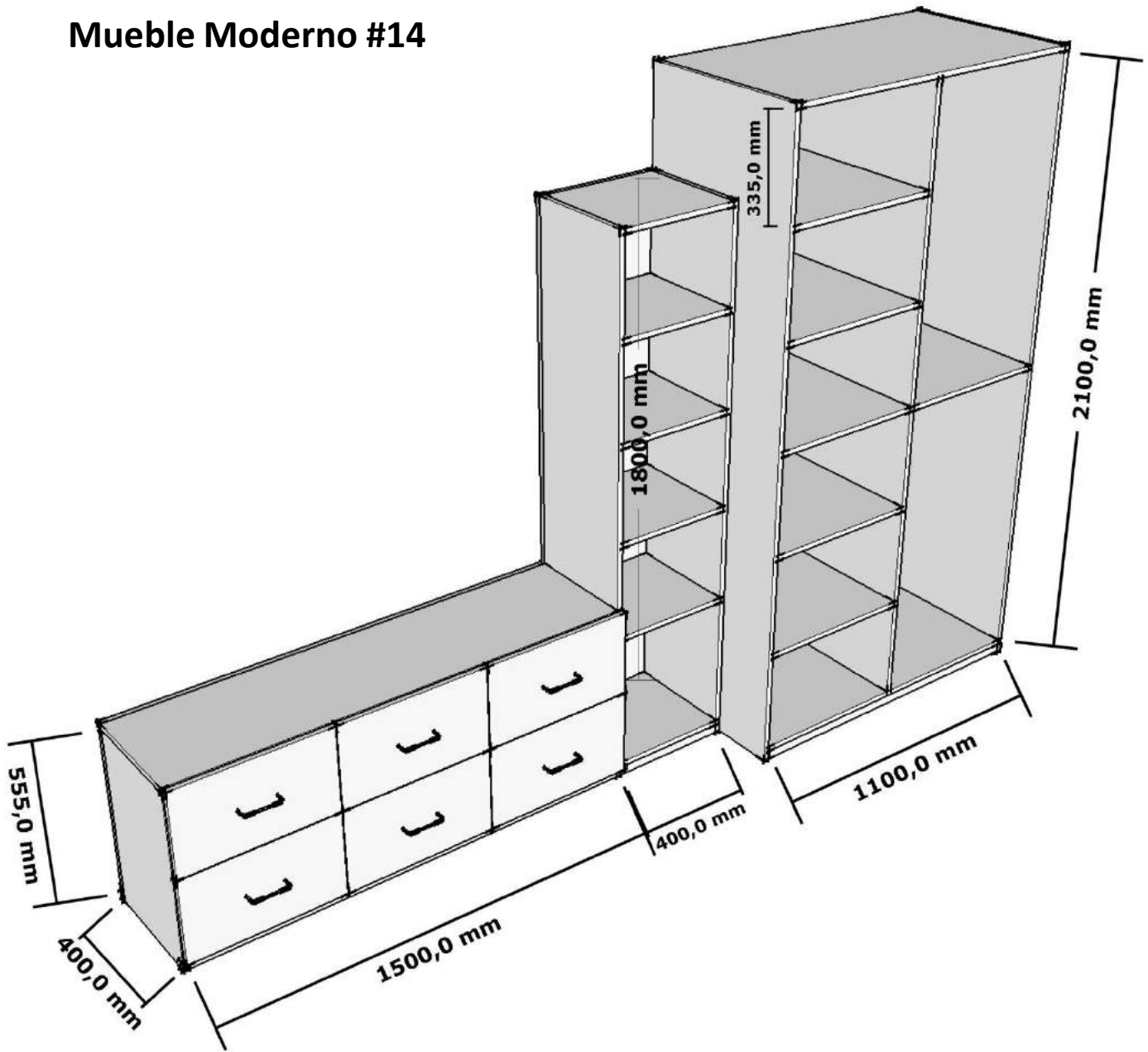

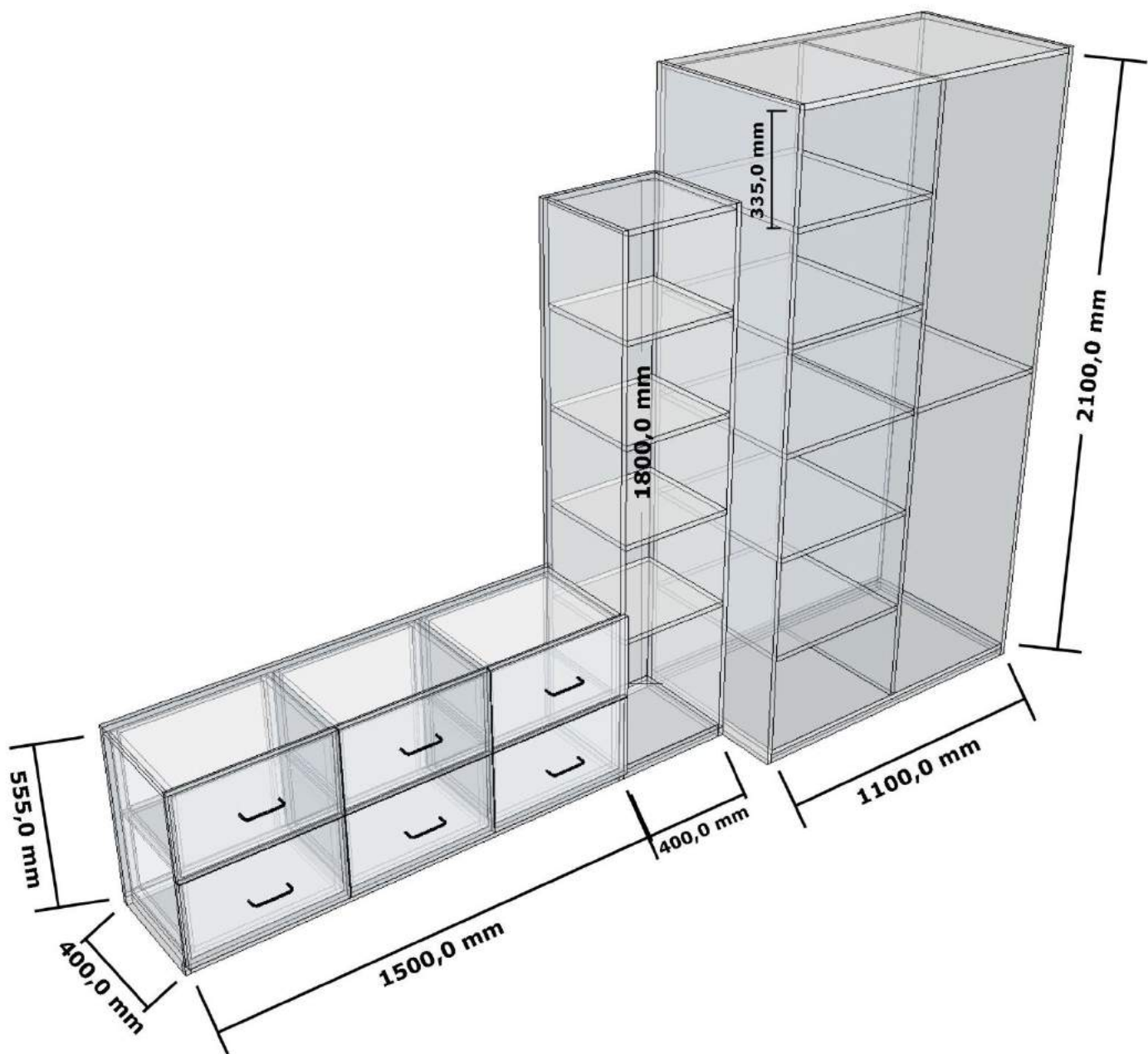

Num	Material	Referencia	Cantidad	Altura (mm)	Anchura (mm)	Espesor (mm)
1	MELA_BL, 18.00	Suelo_1	1	1500.00	379.00	18.00
2	MELA_BL, 18.00	Suelo_2	1	400.00	379.00	18.00
3	MELA_BL, 18.00	Estante Fijo [1]	1	1518.00	379.00	18.00
4	MELA_BL, 18.00	Estante Fijo [2]	1	400.00	379.00	18.00
5	MELA_BL, 18.00	Estante Fijo [3]	1	400.00	379.00	18.00
6	MELA_BL, 18.00	Estante Fijo [4]	1	400.00	379.00	18.00
7	MELA_BL, 18.00	Estante Fijo [5]	1	400.00	379.00	18.00
8	MELA_BL, 18.00	Estante Fijo [6]	1	400.00	379.00	18.00
9	MELA_BL, 18.00	División Libre 1 [1]	1	1536.00	586.00	18.00
10	MELA_BL, 18.00	División Libre 1 [2]	1	1836.00	436.00	18.00
11	MELA_BL, 18.00	División Vertical [1]	1	1866.00	379.00	18.00
12	MELA_BL, 18.00	División Vertical [2]	1	1866.00	379.00	18.00
13	MELA_BL, 18.00	División Vertical [3]	1	598.00	379.00	18.00
14	MELA_BL, 18.00	División Vertical [4]	1	550.00	379.00	18.00
15	MELA_BL, 18.00	División Vertical [5]	1	550.00	379.00	18.00
16	MELA_BL, 18.00	Cajón 1 [1]_1	1	288.50	510.50	18.00
17	MELA_BL, 18.00	Cajón 1 [1]_2	1	288.50	510.50	18.00
18	MELA_BL, 18.00	Cajón 1 [2]_1	1	288.50	503.00	18.00
19	MELA_BL, 18.00	Cajón 1 [2]_2	1	288.50	503.00	18.00
20	MELA_BL, 18.00	Cajón 1 [3]_1	1	288.50	510.50	18.00
21	MELA_BL, 18.00	Cajón 1 [3]_2	1	288.50	510.50	18.00
22	MELA_BL, 18.00	Lateral Der Cajón 1 [1]_1	1	360.00	265.50	18.00
23	MELA_BL, 18.00	Lateral Der Cajón 1 [1]_2	1	360.00	265.50	18.00
24	MELA_BL, 18.00	Lateral Der Cajón 1 [2]_1	1	360.00	265.50	18.00
25	MELA_BL, 18.00	Lateral Der Cajón 1 [2]_2	1	360.00	265.50	18.00
26	MELA_BL, 18.00	Lateral Der Cajón 1 [3]_1	1	360.00	265.50	18.00
27	MELA_BL, 18.00	Lateral Der Cajón 1 [3]_2	1	360.00	265.50	18.00
28	MELA_BL, 18.00	Lateral Izq Cajón 1 [1]_1	1	360.00	265.50	18.00
29	MELA_BL, 18.00	Lateral Izq Cajón 1 [1]_2	1	360.00	265.50	18.00
30	MELA_BL, 18.00	Lateral Izq Cajón 1 [2]_1	1	360.00	265.50	18.00
31	MELA_BL, 18.00	Lateral Izq Cajón 1 [2]_2	1	360.00	265.50	18.00
32	MELA_BL, 18.00	Lateral Izq Cajón 1 [3]_1	1	360.00	265.50	18.00
33	MELA_BL, 18.00	Lateral Izq Cajón 1 [3]_2	1	360.00	265.50	18.00
34	MELA_BL, 18.00	Fondo Cajón 1 [1]_1	1	446.00	342.00	18.00
35	MELA_BL, 18.00	Fondo Cajón 1 [1]_2	1	446.00	342.00	18.00
36	MELA_BL, 18.00	Fondo Cajón 1 [2]_1	1	446.00	342.00	18.00
37	MELA_BL, 18.00	Fondo Cajón 1 [2]_2	1	446.00	342.00	18.00
38	MELA_BL, 18.00	Fondo Cajón 1 [3]_1	1	446.00	342.00	18.00
39	MELA_BL, 18.00	Fondo Cajón 1 [3]_2	1	446.00	342.00	18.00
40	MELA_BL, 18.00	Trasera Cajón 1 [1]_1	1	446.00	265.50	18.00
41	MELA_BL, 18.00	Trasera Cajón 1 [1]_2	1	446.00	265.50	18.00
42	MELA_BL, 18.00	Trasera Cajón 1 [2]_1	1	446.00	265.50	18.00
43	MELA_BL, 18.00	Trasera Cajón 1 [2]_2	1	446.00	265.50	18.00
44	MELA_BL, 18.00	Trasera Cajón 1 [3]_1	1	446.00	265.50	18.00
45	MELA_BL, 18.00	Trasera Cajón 1 [3]_2	1	446.00	265.50	18.00
46	MELA_BL, 18.00	Contra-Frente Cajón 1 [1]_1	1	482.00	265.50	18.00
47	MELA_BL, 18.00	Contra-Frente Cajón 1 [1]_2	1	482.00	265.50	18.00
48	MELA_BL, 18.00	Contra-Frente Cajón 1 [2]_1	1	482.00	265.50	18.00
49	MELA_BL, 18.00	Contra-Frente Cajón 1 [2]_2	1	482.00	265.50	18.00
50	MELA_BL, 18.00	Contra-Frente Cajón 1 [3]_1	1	482.00	265.50	18.00
51	MELA_BL, 18.00	Contra-Frente Cajón 1 [3]_2	1	482.00	265.50	18.00
52	MELA_BL, 18.00	Zócalo 1 [1]	1	1954.00	30.00	18.00
53	MELA_BL, 18.00	Zócalo 1 [2]	1	1954.00	30.00	18.00

Num	Material	Referencia	Cantidad	Altura (mm)	Anchura (mm)	Espesor (mm)
1	MELA_BL, 18.00	Techo	1	1100.00	618.00	18.00
2	MELA_BL, 18.00	Suelo	1	1100.00	618.00	18.00
3	MELA_BL, 18.00	Lateral Derecho	1	2166.00	618.00	18.00
4	MELA_BL, 18.00	Lateral Izquierdo	1	2166.00	618.00	18.00
5	MELA_BL, 18.00	Trasera	1	2100.00	1100.00	18.00
6	MELA_BL, 18.00	Estante Fijo [1]	1	541.00	600.00	18.00
7	MELA_BL, 18.00	Estante Fijo [2]	1	541.00	600.00	18.00
8	MELA_BL, 18.00	Estante Fijo [3]	1	541.00	600.00	18.00
9	MELA_BL, 18.00	Estante Fijo [4]	1	541.00	600.00	18.00
10	MELA_BL, 18.00	Estante Fijo [5]	1	541.00	600.00	18.00
11	MELA_BL, 18.00	Estante Fijo [6]	1	541.00	600.00	18.00
12	MELA_BL, 18.00	División Vertical [1]	1	2100.00	600.00	18.00
13	MELA_BL, 18.00	Zócalo 1 [1]	1	1100.00	30.00	18.00
14	MELA_BL, 18.00	Zócalo 1 [2]	1	1100.00	30.00	18.00

# Mueble Moderno # 15

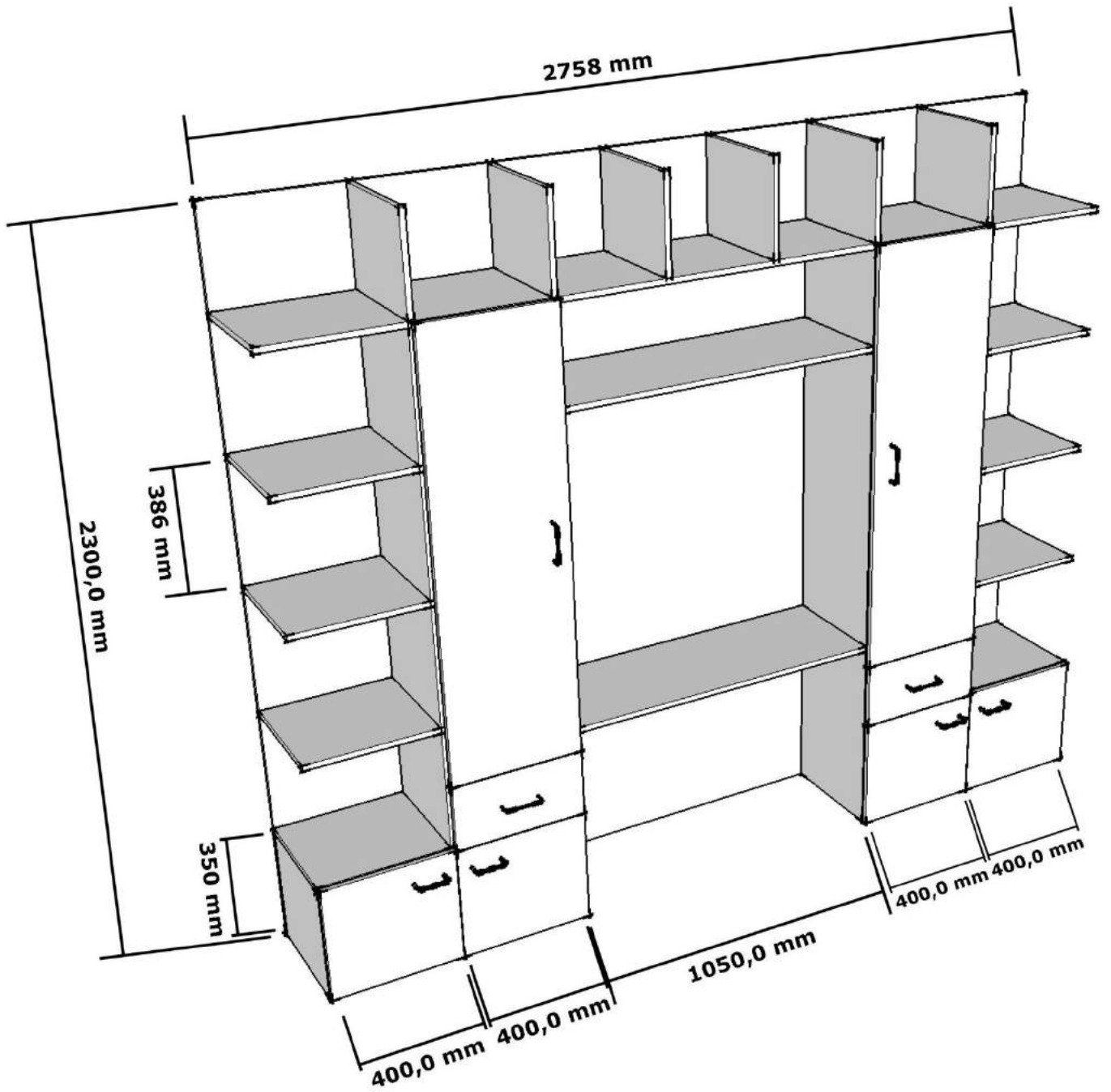



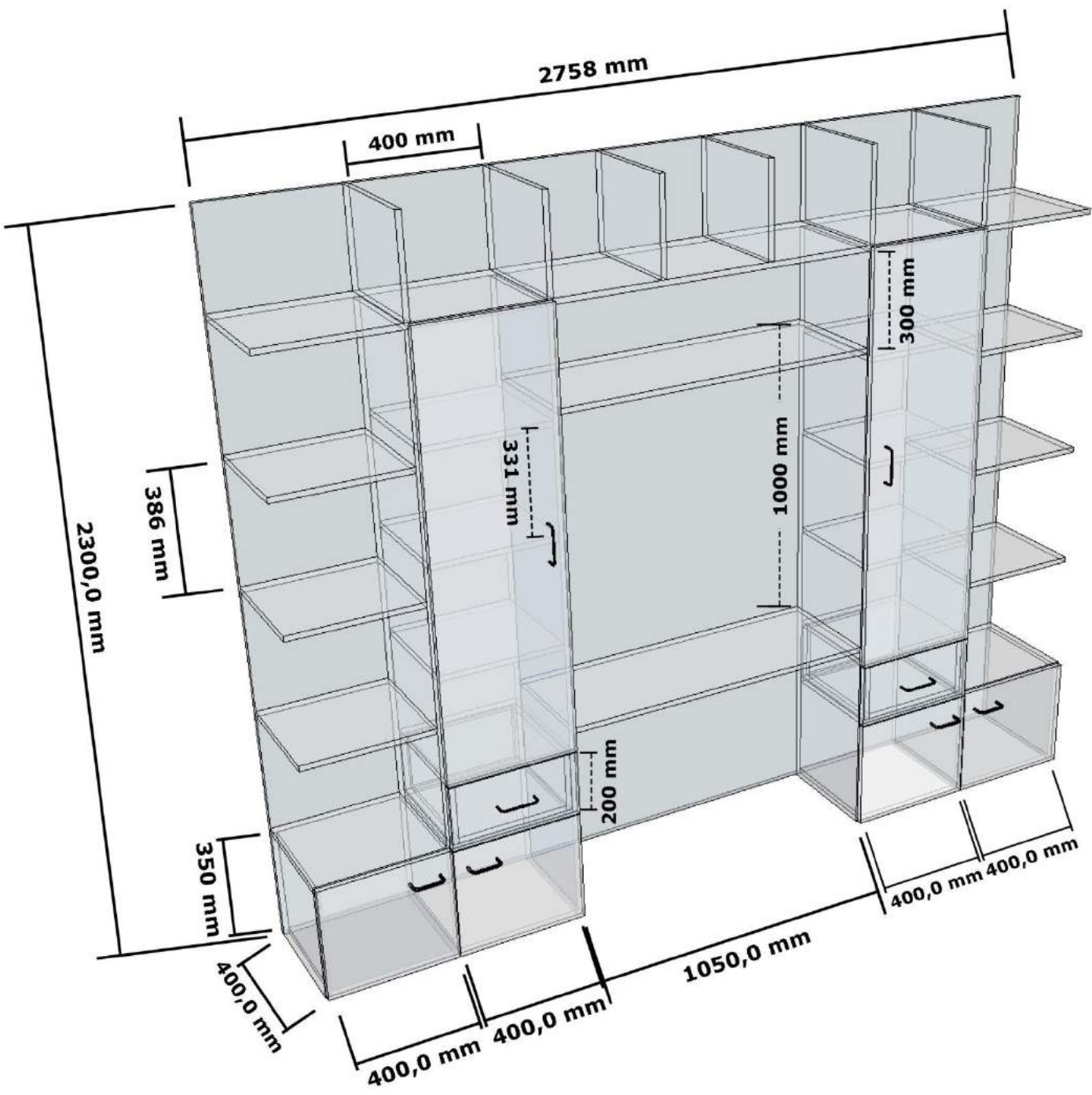

Num	Material	Referencia	Cantidad	Altura (mm)	Anchura (mm)	Espesor (mm)
1	MELA_BL, 18.00	Trasera	1	2300.00	2758.00	18.00
2	MELA_BL, 18.00	Estante Fijo [1]	1	2758.00	379.00	18.00
3	MELA_BL, 18.00	Estante Fijo [2]	1	418.00	379.00	18.00
4	MELA_BL, 18.00	Estante Fijo [3]	1	400.00	379.00	18.00
5	MELA_BL, 18.00	Estante Fijo [4]	1	400.00	379.00	18.00
6	MELA_BL, 18.00	Estante Fijo [5]	1	418.00	379.00	18.00
7	MELA_BL, 18.00	Estante Fijo [6]	1	418.00	379.00	18.00
8	MELA_BL, 18.00	Estante Fijo [7]	1	418.00	379.00	18.00
9	MELA_BL, 18.00	Estante Fijo [8]	1	418.00	379.00	18.00
10	MELA_BL, 18.00	Estante Fijo [9]	1	418.00	379.00	18.00
11	MELA_BL, 18.00	Estante Fijo [10]	1	418.00	379.00	18.00
12	MELA_BL, 18.00	Estante Fijo [11]	1	418.00	379.00	18.00
13	MELA_BL, 18.00	Estante Fijo [12]	1	1050.00	379.00	18.00
14	MELA_BL, 18.00	Estante Fijo [13]	1	400.00	379.00	18.00
15	MELA_BL, 18.00	Estante Fijo [14]	1	400.00	379.00	18.00
16	MELA_BL, 18.00	Estante Fijo [15]	1	400.00	379.00	18.00
17	MELA_BL, 18.00	Estante Fijo [16]	1	400.00	379.00	18.00
18	MELA_BL, 18.00	Estante Fijo [17]	1	400.00	379.00	18.00
19	MELA_BL, 18.00	Estante Fijo [18]	1	400.00	379.00	18.00
20	MELA_BL, 18.00	Estante Fijo [19]	1	400.00	379.00	18.00
21	MELA_BL, 18.00	Estante Fijo [20]	1	400.00	379.00	18.00
22	MELA_BL, 18.00	Estante Fijo [21]	1	1050.00	379.00	18.00
23	MELA_BL, 18.00	División Libre 1 [1]	1	379.00	368.00	18.00
24	MELA_BL, 18.00	División Libre 1 [2]	1	418.00	379.00	18.00
25	MELA_BL, 18.00	División Libre 1 [3]	1	418.00	379.00	18.00
26	MELA_BL, 18.00	División Libre 1 [4]	1	418.00	379.00	18.00
27	MELA_BL, 18.00	División Libre 1 [5]	1	418.00	379.00	18.00
28	MELA_BL, 18.00	División Libre 1 [6]	1	379.00	368.00	18.00
29	MELA_BL, 18.00	División Vertical [1]	1	1964.00	379.00	18.00
30	MELA_BL, 18.00	División Vertical [2]	1	1982.00	379.00	18.00
31	MELA_BL, 18.00	División Vertical [3]	1	1964.00	379.00	18.00
32	MELA_BL, 18.00	División Vertical [4]	1	1982.00	379.00	18.00
33	MELA_BL, 18.00	División Vertical [5]	1	300.00	379.00	18.00
34	MELA_BL, 18.00	División Vertical [6]	1	300.00	379.00	18.00
35	MELA_BL, 18.00	División Vertical [7]	1	300.00	379.00	18.00
36	MELA_BL, 18.00	División Vertical [8]	1	300.00	379.00	18.00
37	MELA_BL, 18.00	División Vertical [9]	1	300.00	379.00	18.00
38	MELA_BL, 18.00	División Vertical [10]	1	300.00	379.00	18.00
39	MELA_BL, 18.00	Puerta 1 (unica) [1]	1	1400.50	422.50	18.00
40	MELA_BL, 18.00	Puerta 1 (unica) [2]	1	1400.50	422.50	18.00
41	MELA_BL, 18.00	Puerta 1 (unica) [3]	1	380.00	422.50	18.00
42	MELA_BL, 18.00	Puerta 1 (unica) [4]	1	372.50	422.50	18.00
43	MELA_BL, 18.00	Puerta 1 (unica) [5]	1	372.50	422.50	18.00
44	MELA_BL, 18.00	Puerta 1 (unica) [6]	1	380.00	422.50	18.00
45	MELA_BL, 18.00	Cajón 1 [1]	1	215.00	422.50	18.00
46	MELA_BL, 18.00	Cajón 1 [2]	1	215.00	422.50	18.00
47	MELA_BL, 18.00	Lateral Der Cajón 1 [1]	1	378.00	192.00	18.00
48	MELA_BL, 18.00	Lateral Der Cajón 1 [2]	1	378.00	192.00	18.00
49	MELA_BL, 18.00	Lateral Izq Cajón 1 [1]	1	378.00	192.00	18.00
50	MELA_BL, 18.00	Lateral Izq Cajón 1 [2]	1	378.00	192.00	18.00
51	MELA_BL, 18.00	Fondo Cajón 1 [1]	1	360.00	358.00	18.00
52	MELA_BL, 18.00	Fondo Cajón 1 [2]	1	360.00	358.00	18.00
53	MELA_BL, 18.00	Trasera Cajón 1 [1]	1	358.00	192.00	18.00
54	MELA_BL, 18.00	Trasera Cajón 1 [2]	1	358.00	192.00	18.00

# Mueble Moderno #16

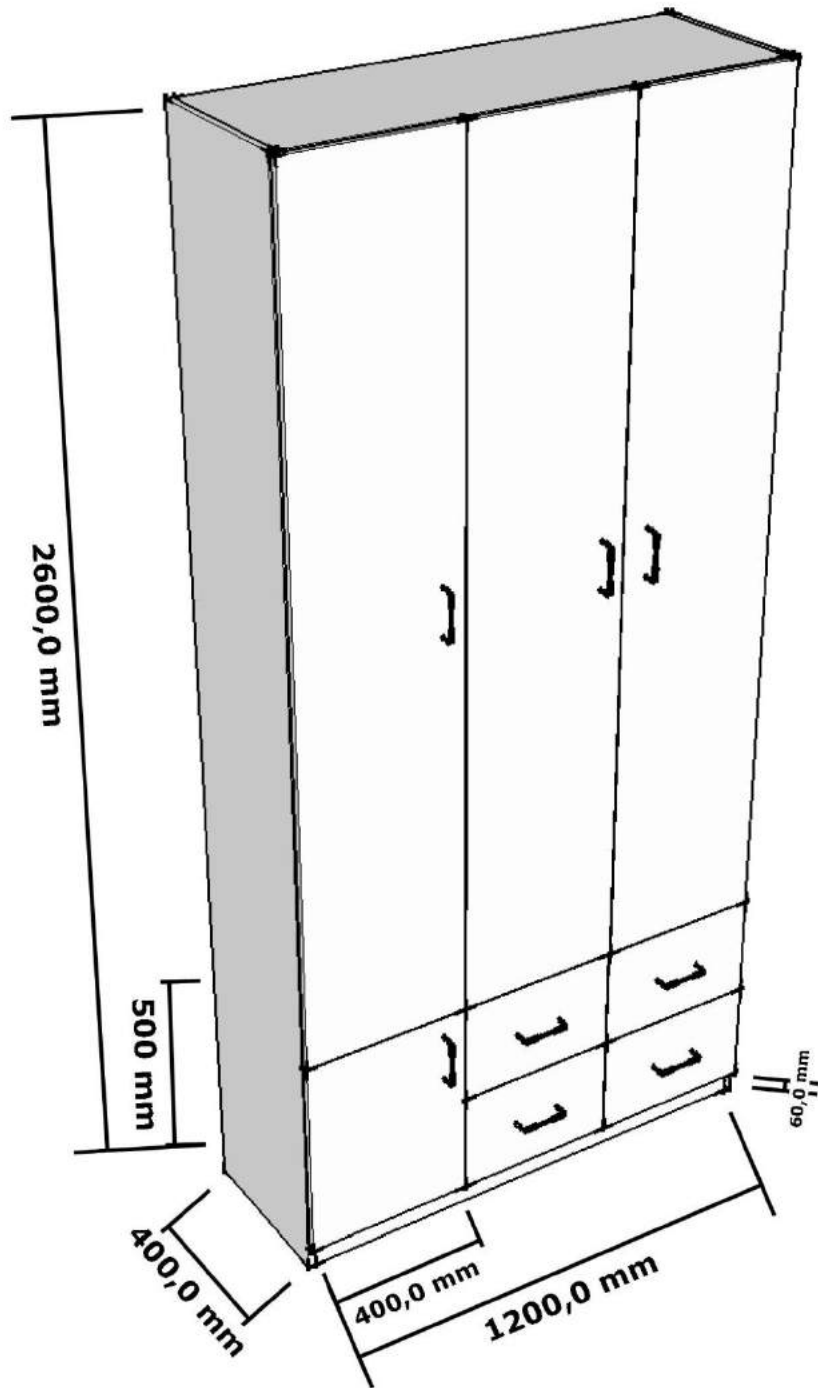

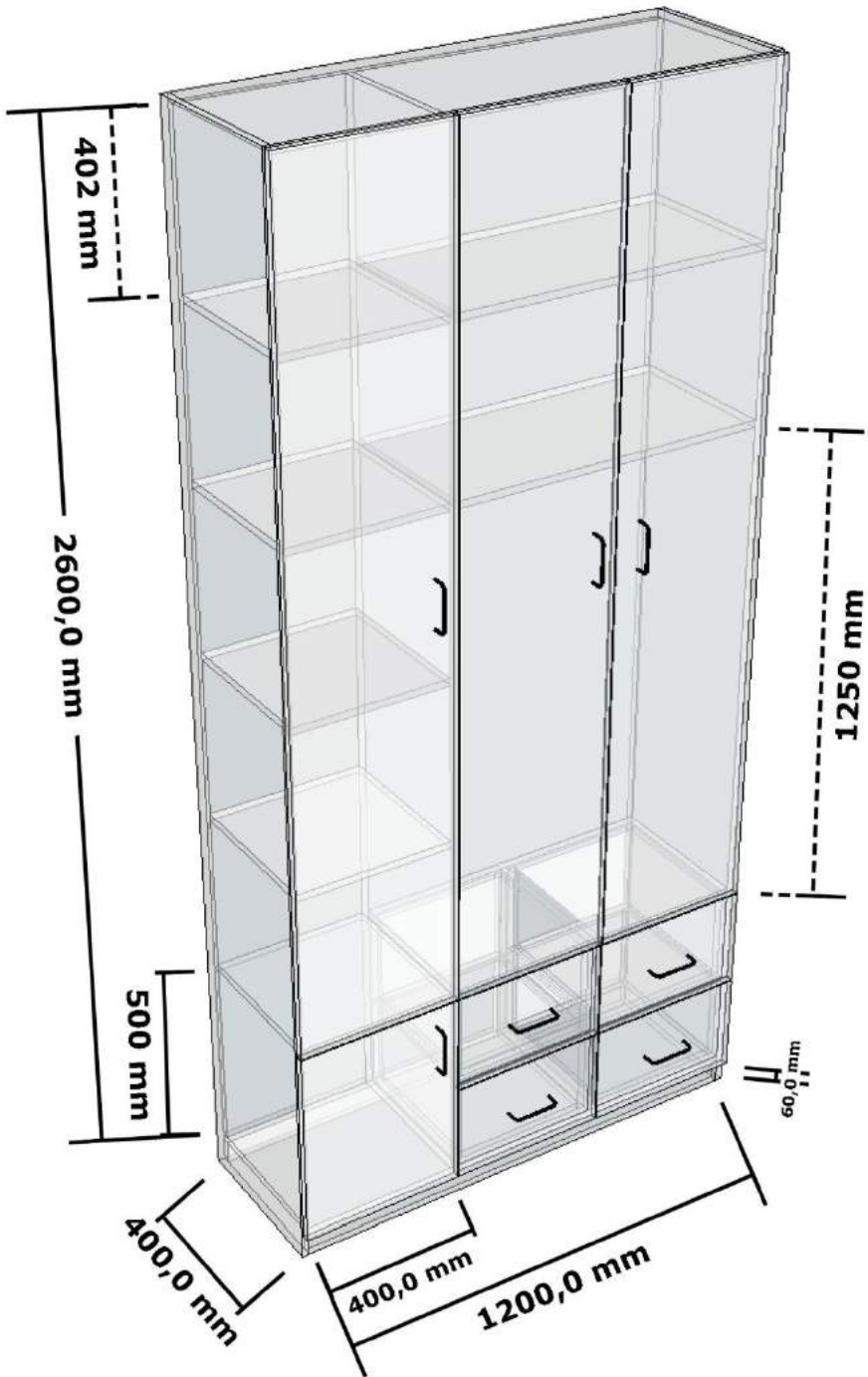

# Mueble Moderno #17

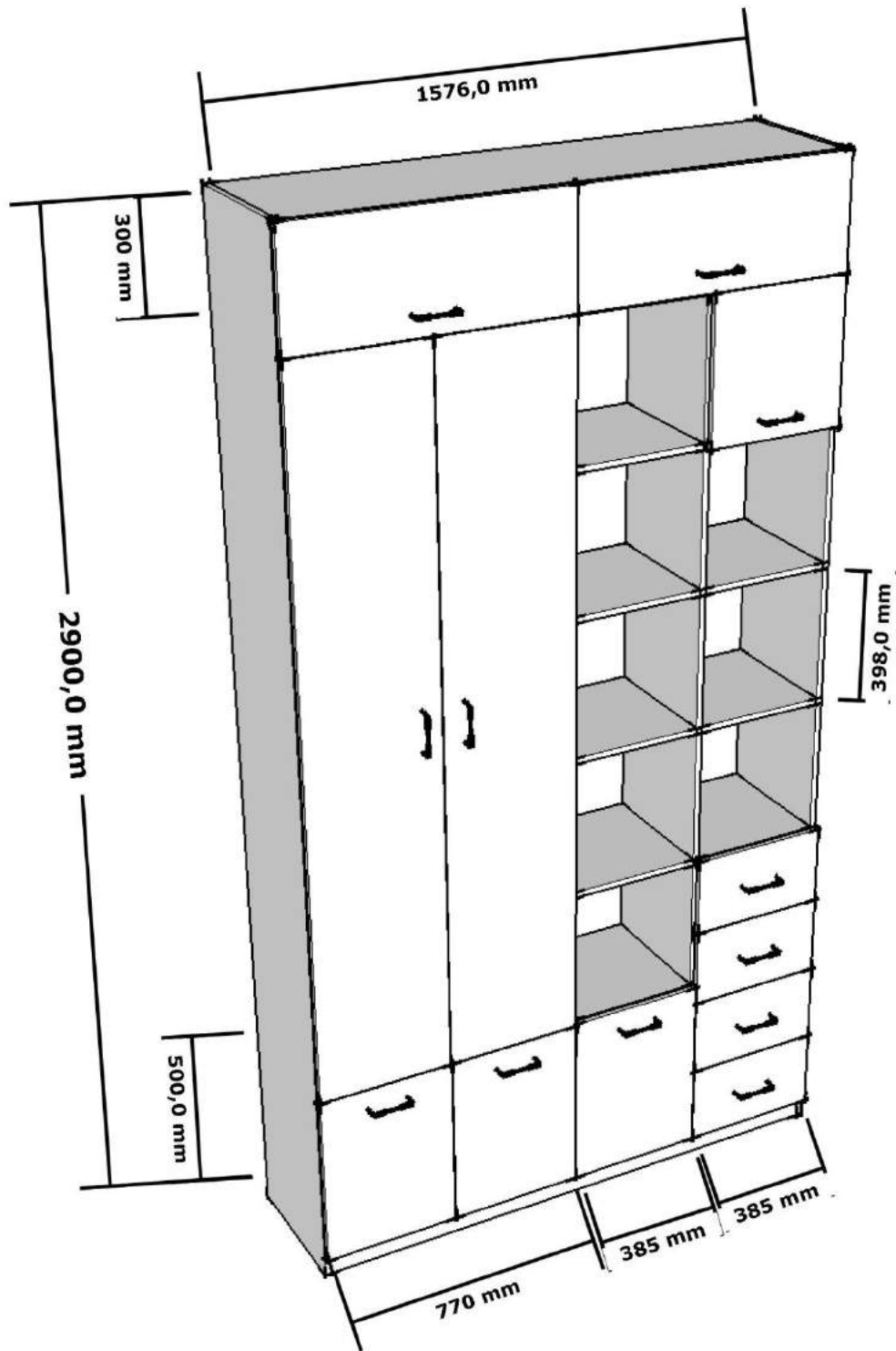

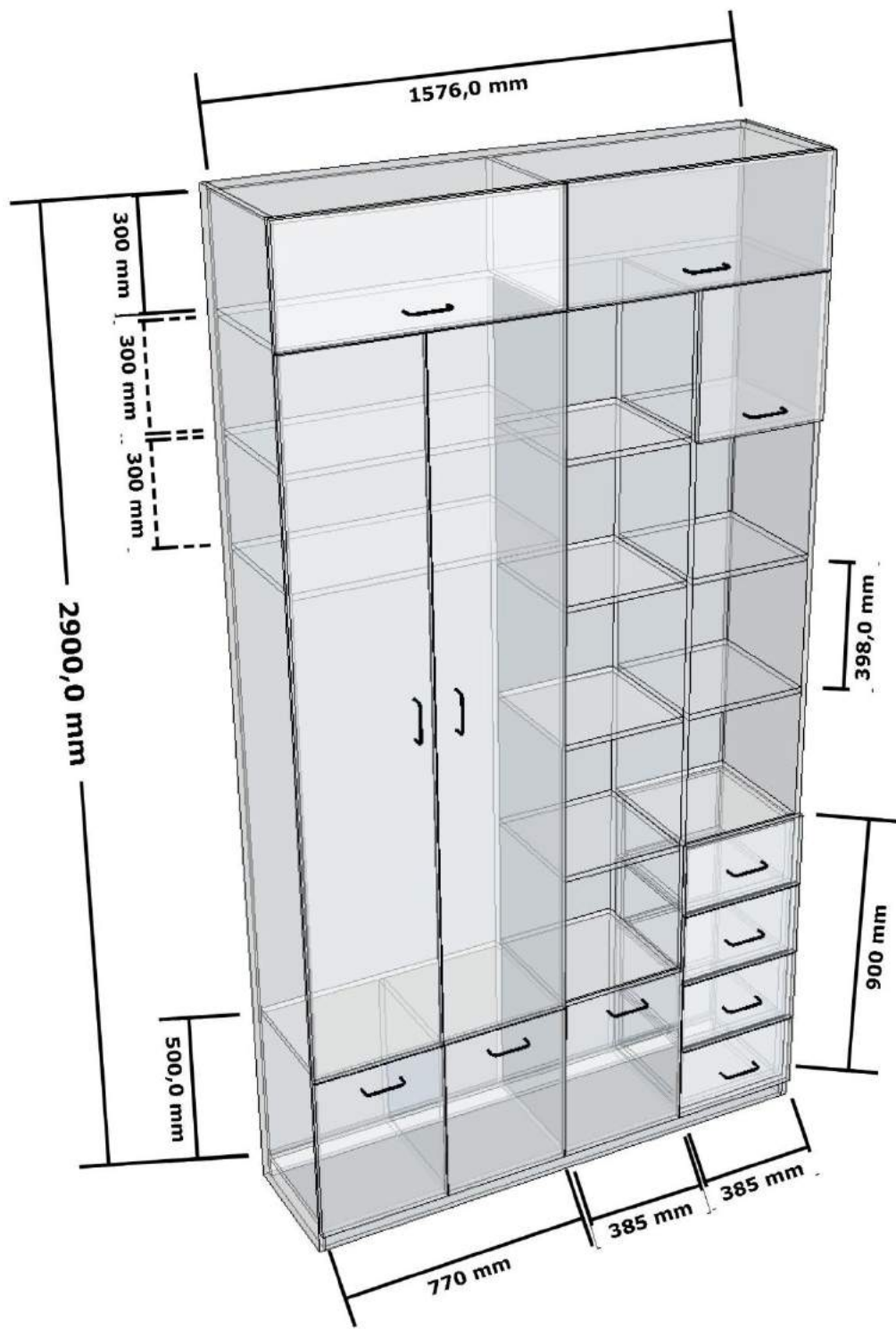

Num	Material	Referencia	Cantidad	Altura (mm)	Anchura (mm)	Espesor (mm)
1	MELA_BL, 18.00	Techo	1	1576.00	417.00	18.00
2	MELA_BL, 18.00	Suelo	1	1576.00	417.00	18.00
3	MELA_BL, 18.00	Lateral Derecho	1	2996.00	417.00	18.00
4	MELA_BL, 18.00	Lateral Izquierdo	1	2996.00	417.00	18.00
5	MELA_BL, 18.00	Trasera	1	2900.00	1576.00	18.00
6	MELA_BL, 18.00	Estante Fijo [1]	1	1576.00	399.00	18.00
7	MELA_BL, 18.00	Estante Fijo [2]	1	770.00	399.00	18.00
8	MELA_BL, 18.00	Estante Fijo [3]	1	385.00	399.00	18.00
9	MELA_BL, 18.00	Estante Fijo [4]	1	770.00	399.00	18.00
10	MELA_BL, 18.00	Estante Fijo [5]	1	770.00	399.00	18.00
11	MELA_BL, 18.00	Estante Fijo [6]	1	385.00	399.00	18.00
12	MELA_BL, 18.00	Estante Fijo [7]	1	385.00	399.00	18.00
13	MELA_BL, 18.00	Estante Fijo [8]	1	385.00	399.00	18.00
14	MELA_BL, 18.00	Estante Fijo [9]	1	385.00	399.00	18.00
15	MELA_BL, 18.00	Estante Fijo [10]	1	385.00	399.00	18.00
16	MELA_BL, 18.00	Estante Fijo [11]	1	385.00	399.00	18.00
17	MELA_BL, 18.00	Estante Fijo [12]	1	385.00	399.00	18.00
18	MELA_BL, 18.00	Estante Fijo [13]	1	385.00	399.00	18.00
19	MELA_BL, 18.00	División Vertical [1]	1	2582.00	399.00	18.00
20	MELA_BL, 18.00	División Vertical [2]	1	2582.00	399.00	18.00
21	MELA_BL, 18.00	División Vertical [3]	1	300.00	399.00	18.00
22	MELA_BL, 18.00	División Vertical [4]	1	500.00	399.00	18.00
23	MELA_BL, 18.00	Puerta 1 (unica) [1]	1	322.50	810.50	18.00
24	MELA_BL, 18.00	Puerta 1 (unica) [2]	1	322.50	792.50	18.00
25	MELA_BL, 18.00	Puerta 1 (unica) [3]	1	522.50	398.50	18.00
26	MELA_BL, 18.00	Puerta 1 (unica) [4]	1	522.50	391.00	18.00
27	MELA_BL, 18.00	Puerta 1 (unica) [5]	1	530.00	400.00	18.00
28	MELA_BL, 18.00	Puerta 1 (unica) [6]	1	420.50	407.50	18.00
29	MELA_BL, 18.00	Puerta 1 (doble) [1]_1	1	2079.00	394.75	18.00
30	MELA_BL, 18.00	Puerta 1 (doble) [1]_2	1	2079.00	394.75	18.00
31	MELA_BL, 18.00	Cajón 1 [1]_1	1	234.75	407.50	18.00
32	MELA_BL, 18.00	Cajón 1 [1]_2	1	234.75	407.50	18.00
33	MELA_BL, 18.00	Cajón 1 [1]_3	1	234.75	407.50	18.00
34	MELA_BL, 18.00	Cajón 1 [1]_4	1	234.75	407.50	18.00
35	MELA_BL, 18.00	Lateral Der Cajón 1 [1]_1	1	380.00	211.75	18.00
36	MELA_BL, 18.00	Lateral Der Cajón 1 [1]_2	1	380.00	226.75	18.00
37	MELA_BL, 18.00	Lateral Der Cajón 1 [1]_3	1	380.00	226.75	18.00
38	MELA_BL, 18.00	Lateral Der Cajón 1 [1]_4	1	380.00	211.75	18.00
39	MELA_BL, 18.00	Lateral Izq Cajón 1 [1]_1	1	380.00	211.75	18.00
40	MELA_BL, 18.00	Lateral Izq Cajón 1 [1]_2	1	380.00	226.75	18.00
41	MELA_BL, 18.00	Lateral Izq Cajón 1 [1]_3	1	380.00	226.75	18.00
42	MELA_BL, 18.00	Lateral Izq Cajón 1 [1]_4	1	380.00	211.75	18.00
43	MELA_BL, 18.00	Fondo Cajón 1 [1]_1	1	362.00	343.00	18.00
44	MELA_BL, 18.00	Fondo Cajón 1 [1]_2	1	362.00	343.00	18.00
45	MELA_BL, 18.00	Fondo Cajón 1 [1]_3	1	362.00	343.00	18.00
46	MELA_BL, 18.00	Fondo Cajón 1 [1]_4	1	362.00	343.00	18.00
47	MELA_BL, 18.00	Trasera Cajón 1 [1]_1	1	343.00	211.75	18.00
48	MELA_BL, 18.00	Trasera Cajón 1 [1]_2	1	343.00	226.75	18.00
49	MELA_BL, 18.00	Trasera Cajón 1 [1]_3	1	343.00	226.75	18.00
50	MELA_BL, 18.00	Trasera Cajón 1 [1]_4	1	343.00	211.75	18.00
51	MELA_BL, 18.00	Contra-Frente Cajón 1 [1]_1	1	379.00	211.75	18.00
52	MELA_BL, 18.00	Contra-Frente Cajón 1 [1]_2	1	379.00	226.75	18.00
53	MELA_BL, 18.00	Contra-Frente Cajón 1 [1]_3	1	379.00	226.75	18.00
54	MELA_BL, 18.00	Contra-Frente Cajón 1 [1]_4	1	379.00	211.75	18.00
55	MELA_BL, 18.00	Zócalo 1 [1]	1	1576.00	60.00	18.00
56	MELA_BL, 18.00	Zócalo 1 [2]	1	1576.00	60.00	18.00

# Mueble Moderno #18

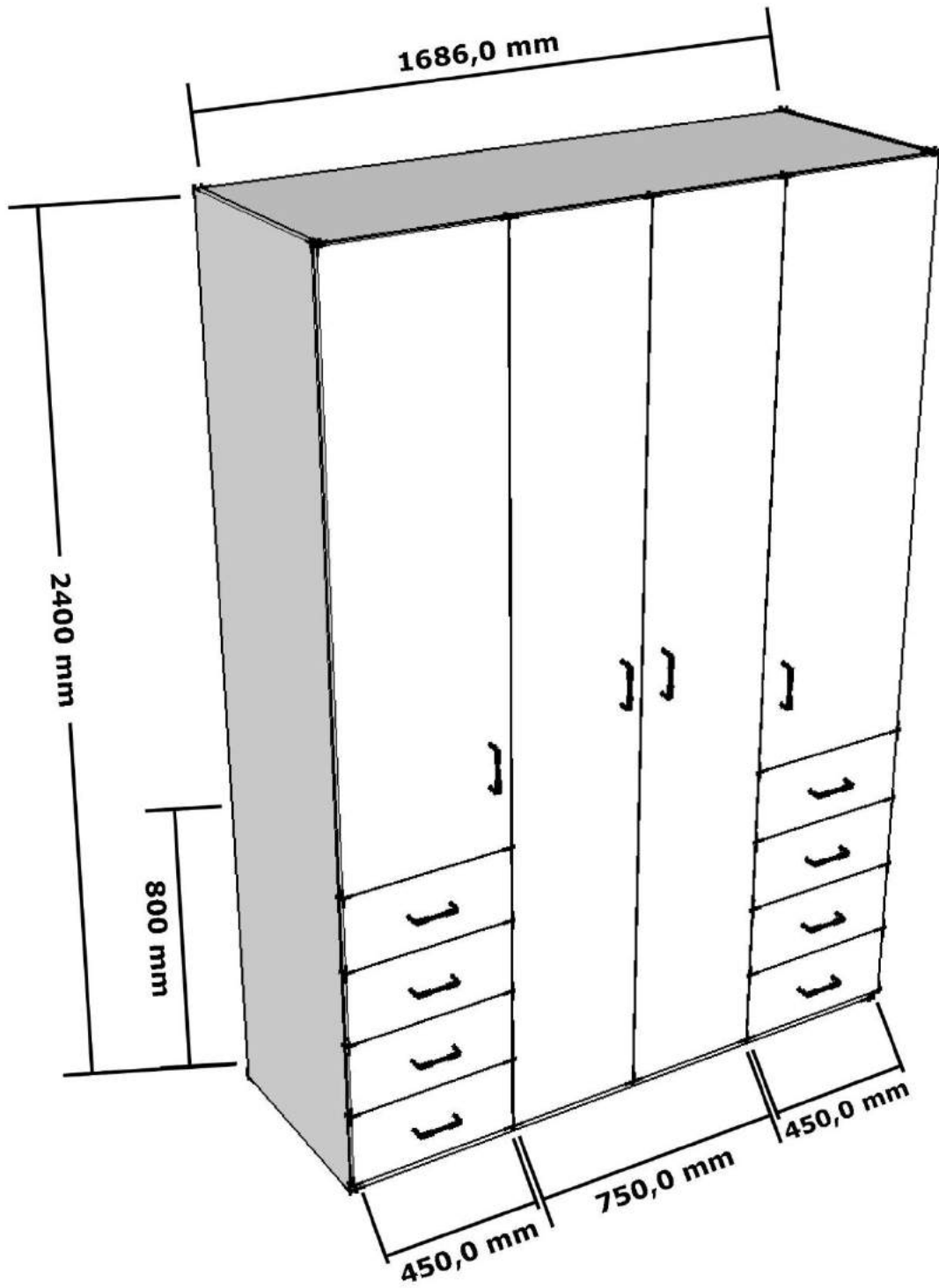



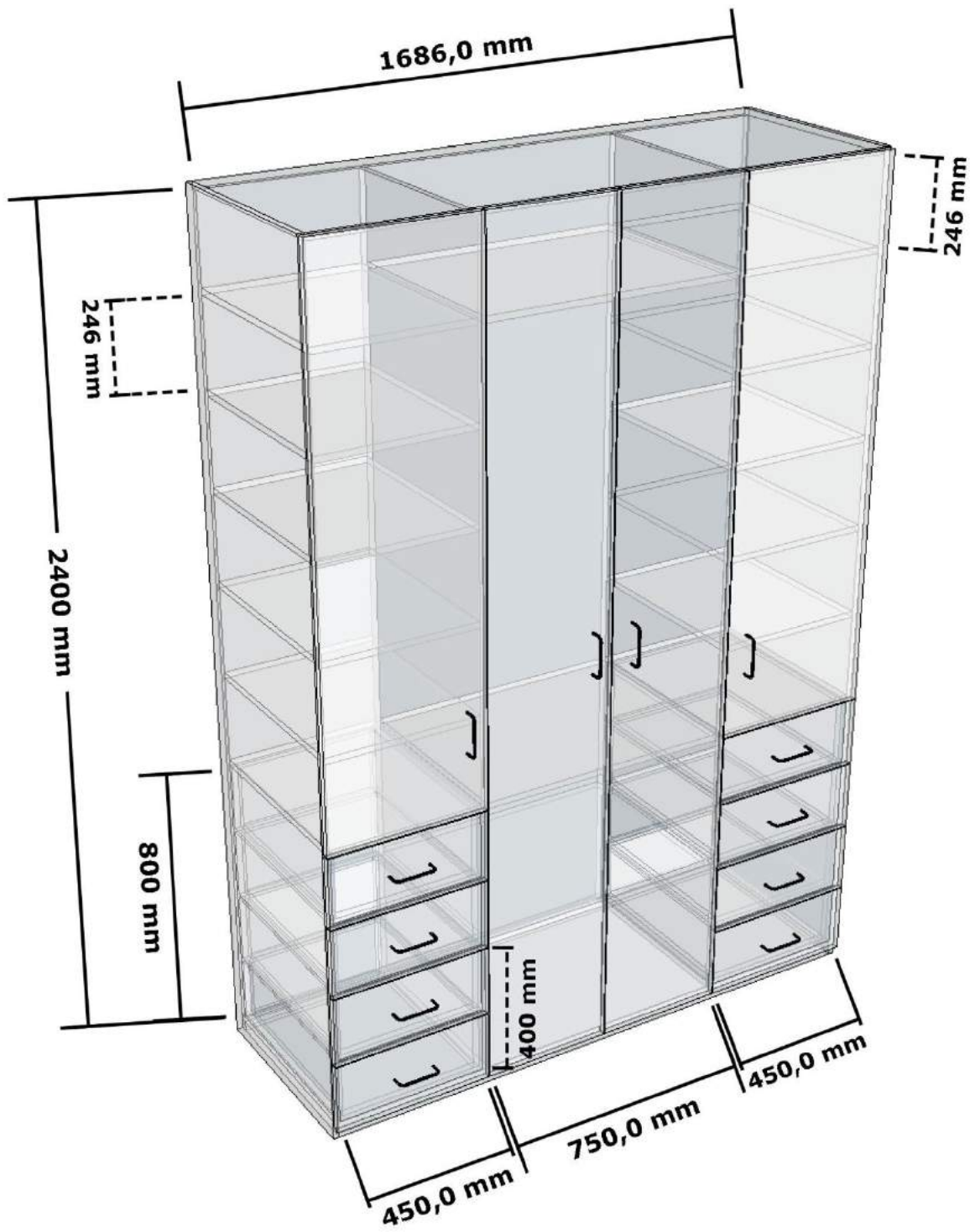

Num	Material	Referencia	Cantidad	Altura (mm)	Anchura (mm)	Espesor (mm)
1	MELA_BL, 18.00	Techo	1	1686.00	597.00	18.00
2	MELA_BL, 18.00	Suelo	1	1686.00	597.00	18.00
3	MELA_BL, 18.00	Lateral Derecho	1	2466.00	597.00	18.00
4	MELA_BL, 18.00	Lateral Izquierdo	1	2466.00	597.00	18.00
5	MELA_BL, 18.00	Trasera	1	2400.00	1686.00	18.00
6	MELA_BL, 18.00	Estante Fijo [1]	1	450.00	579.00	18.00
7	MELA_BL, 18.00	Estante Fijo [2]	1	450.00	579.00	18.00
8	MELA_BL, 18.00	Estante Fijo [3]	1	750.00	579.00	18.00
9	MELA_BL, 18.00	Estante Fijo [4]	1	750.00	579.00	18.00
10	MELA_BL, 18.00	Estante Fijo [5]	1	450.00	579.00	18.00
11	MELA_BL, 18.00	Estante Fijo [6]	1	450.00	579.00	18.00
12	MELA_BL, 18.00	Estante Fijo [7]	1	450.00	579.00	18.00
13	MELA_BL, 18.00	Estante Fijo [8]	1	450.00	579.00	18.00
14	MELA_BL, 18.00	Estante Fijo [9]	1	450.00	579.00	18.00
15	MELA_BL, 18.00	Estante Fijo [10]	1	450.00	579.00	18.00
16	MELA_BL, 18.00	Estante Fijo [11]	1	450.00	579.00	18.00
17	MELA_BL, 18.00	Estante Fijo [12]	1	450.00	579.00	18.00
18	MELA_BL, 18.00	Estante Fijo [13]	1	450.00	579.00	18.00
19	MELA_BL, 18.00	Estante Fijo [14]	1	450.00	579.00	18.00
20	MELA_BL, 18.00	Estante Fijo [15]	1	750.00	579.00	18.00
21	MELA_BL, 18.00	División Vertical [1]	1	2400.00	579.00	18.00
22	MELA_BL, 18.00	División Vertical [2]	1	2400.00	579.00	18.00
23	MELA_BL, 18.00	Puerta 1 (unica) [1]	1	1586.50	472.50	18.00
24	MELA_BL, 18.00	Puerta 1 (unica) [2]	1	1586.50	472.50	18.00
25	MELA_BL, 18.00	Puerta 1 (doble) [1]_1	1	2430.00	381.00	18.00
26	MELA_BL, 18.00	Puerta 1 (doble) [1]_2	1	2430.00	381.00	18.00
27	MELA_BL, 18.00	Cajón 1 [1]_1	1	207.88	472.50	18.00
28	MELA_BL, 18.00	Cajón 1 [1]_2	1	207.88	472.50	18.00
29	MELA_BL, 18.00	Cajón 1 [1]_3	1	207.88	472.50	18.00
30	MELA_BL, 18.00	Cajón 1 [1]_4	1	207.88	472.50	18.00
31	MELA_BL, 18.00	Cajón 1 [2]_1	1	207.88	472.50	18.00
32	MELA_BL, 18.00	Cajón 1 [2]_2	1	207.88	472.50	18.00
33	MELA_BL, 18.00	Cajón 1 [2]_3	1	207.88	472.50	18.00
34	MELA_BL, 18.00	Cajón 1 [2]_4	1	207.88	472.50	18.00
35	MELA_BL, 18.00	Lateral Der Cajón 1 [1]_1	1	560.00	192.38	18.00
36	MELA_BL, 18.00	Lateral Der Cajón 1 [1]_2	1	560.00	199.88	18.00
37	MELA_BL, 18.00	Lateral Der Cajón 1 [1]_3	1	560.00	199.88	18.00
38	MELA_BL, 18.00	Lateral Der Cajón 1 [1]_4	1	560.00	184.88	18.00
39	MELA_BL, 18.00	Lateral Der Cajón 1 [2]_1	1	560.00	192.38	18.00
40	MELA_BL, 18.00	Lateral Der Cajón 1 [2]_2	1	560.00	199.88	18.00
41	MELA_BL, 18.00	Lateral Der Cajón 1 [2]_3	1	560.00	199.88	18.00
42	MELA_BL, 18.00	Lateral Der Cajón 1 [2]_4	1	560.00	184.88	18.00
43	MELA_BL, 18.00	Lateral Izq Cajón 1 [1]_1	1	560.00	192.38	18.00
44	MELA_BL, 18.00	Lateral Izq Cajón 1 [1]_2	1	560.00	199.88	18.00
45	MELA_BL, 18.00	Lateral Izq Cajón 1 [1]_3	1	560.00	199.88	18.00
46	MELA_BL, 18.00	Lateral Izq Cajón 1 [1]_4	1	560.00	184.88	18.00
47	MELA_BL, 18.00	Lateral Izq Cajón 1 [2]_1	1	560.00	192.38	18.00
48	MELA_BL, 18.00	Lateral Izq Cajón 1 [2]_2	1	560.00	199.88	18.00
49	MELA_BL, 18.00	Lateral Izq Cajón 1 [2]_3	1	560.00	199.88	18.00
50	MELA_BL, 18.00	Lateral Izq Cajón 1 [2]_4	1	560.00	184.88	18.00

51	MELA_BL, 18.00	Fondo Cajón 1 [1]_1	1	542.00	408.00	18.00
52	MELA_BL, 18.00	Fondo Cajón 1 [1]_2	1	542.00	408.00	18.00
53	MELA_BL, 18.00	Fondo Cajón 1 [1]_3	1	542.00	408.00	18.00
54	MELA_BL, 18.00	Fondo Cajón 1 [1]_4	1	542.00	408.00	18.00
55	MELA_BL, 18.00	Fondo Cajón 1 [2]_1	1	542.00	408.00	18.00
56	MELA_BL, 18.00	Fondo Cajón 1 [2]_2	1	542.00	408.00	18.00
57	MELA_BL, 18.00	Fondo Cajón 1 [2]_3	1	542.00	408.00	18.00
58	MELA_BL, 18.00	Fondo Cajón 1 [2]_4	1	542.00	408.00	18.00
59	MELA_BL, 18.00	Trasera Cajón 1 [1]_1	1	408.00	192.38	18.00
60	MELA_BL, 18.00	Trasera Cajón 1 [1]_2	1	408.00	199.88	18.00
61	MELA_BL, 18.00	Trasera Cajón 1 [1]_3	1	408.00	199.88	18.00
62	MELA_BL, 18.00	Trasera Cajón 1 [1]_4	1	408.00	184.88	18.00
63	MELA_BL, 18.00	Trasera Cajón 1 [2]_1	1	408.00	192.38	18.00
64	MELA_BL, 18.00	Trasera Cajón 1 [2]_2	1	408.00	199.88	18.00
65	MELA_BL, 18.00	Trasera Cajón 1 [2]_3	1	408.00	199.88	18.00
66	MELA_BL, 18.00	Trasera Cajón 1 [2]_4	1	408.00	184.88	18.00
67	MELA_BL, 18.00	Contra-Frente Cajón 1 [1]_1	1	444.00	192.38	18.00
68	MELA_BL, 18.00	Contra-Frente Cajón 1 [1]_2	1	444.00	199.88	18.00
69	MELA_BL, 18.00	Contra-Frente Cajón 1 [1]_3	1	444.00	199.88	18.00
70	MELA_BL, 18.00	Contra-Frente Cajón 1 [1]_4	1	444.00	184.88	18.00
71	MELA_BL, 18.00	Contra-Frente Cajón 1 [2]_1	1	444.00	192.38	18.00
72	MELA_BL, 18.00	Contra-Frente Cajón 1 [2]_2	1	444.00	199.88	18.00
73	MELA_BL, 18.00	Contra-Frente Cajón 1 [2]_3	1	444.00	199.88	18.00
74	MELA_BL, 18.00	Contra-Frente Cajón 1 [2]_4	1	444.00	184.88	18.00
75	MELA_BL, 18.00	Zócalo 1 [1]	1	1686.00	30.00	18.00
76	MELA_BL, 18.00	Zócalo 1 [2]	1	1686.00	30.00	18.00

## Mueble Moderno #19

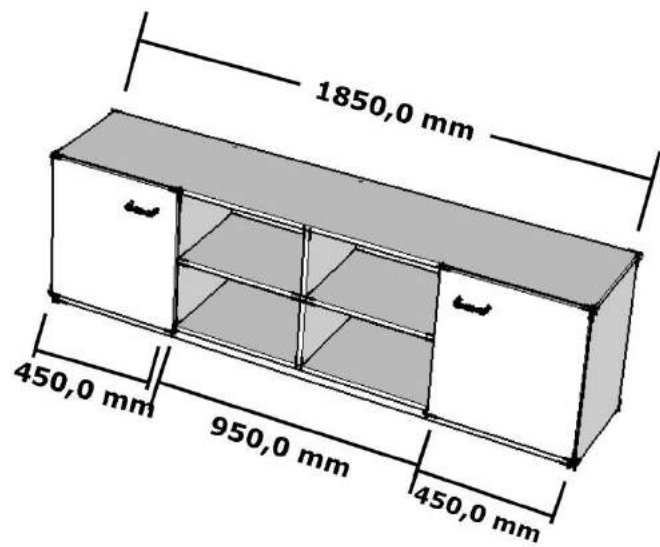
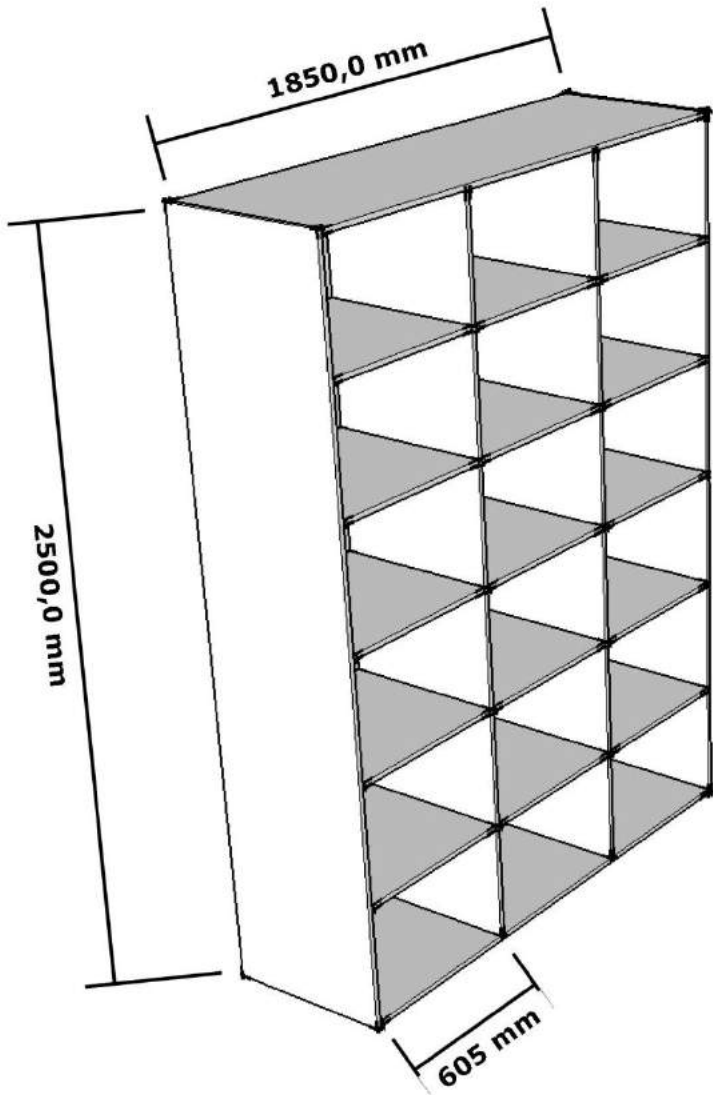

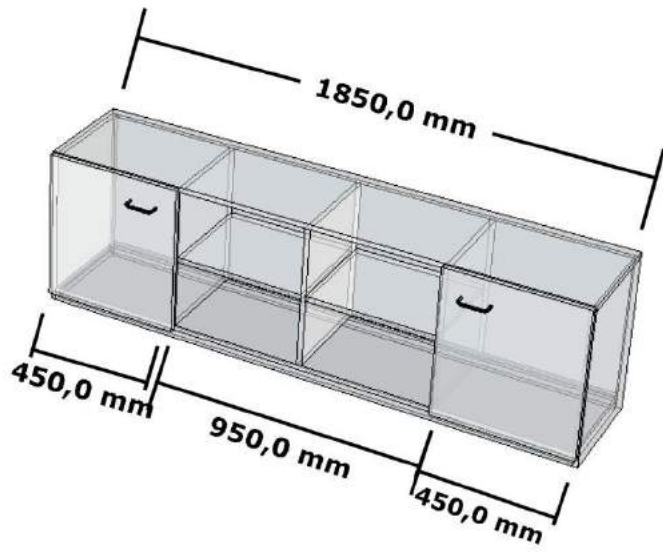
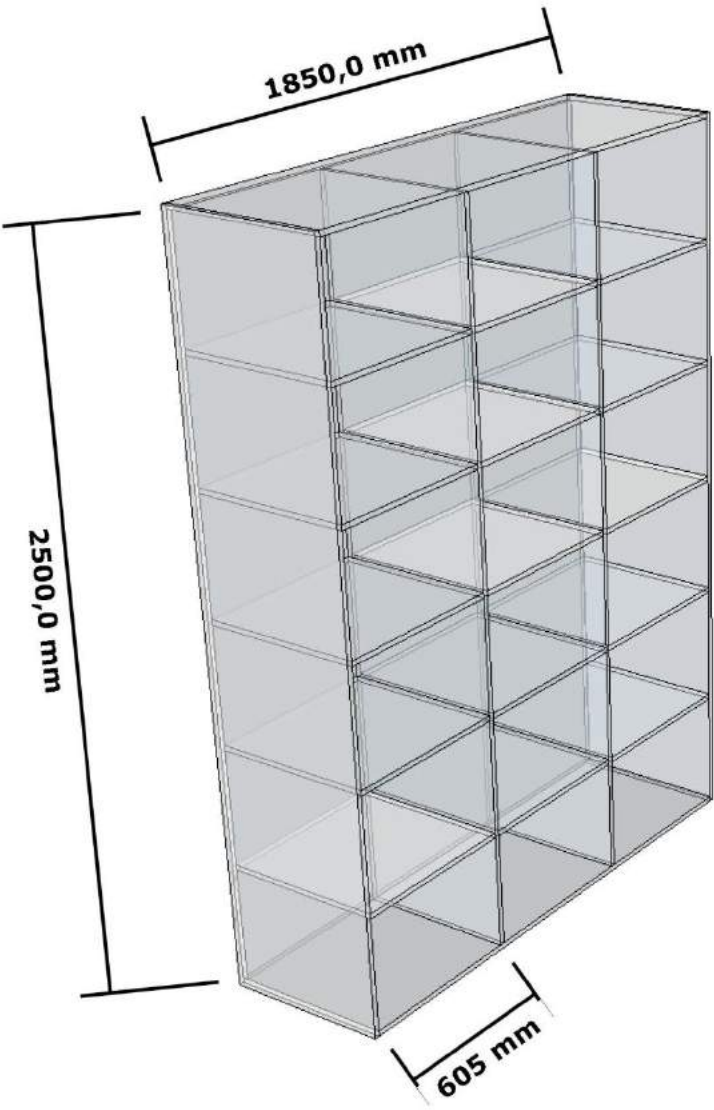

Num	Material	Referencia	Cantidad	Altura (mm)	Anchura (mm)	Espesor (mm)
1	MELA_BL, 18.00	Techo	1	1850.00	568.00	18.00
2	MELA_BL, 18.00	Suelo	1	1850.00	568.00	18.00
3	MELA_BL, 18.00	Lateral Derecho	1	2536.00	568.00	18.00
4	MELA_BL, 18.00	Lateral Izquierdo	1	2536.00	568.00	18.00
5	MELA_BL, 18.00	Trasera	1	2500.00	1850.00	18.00
6	MELA_BL, 18.00	Estante Fijo [1]	1	604.67	550.00	18.00
7	MELA_BL, 18.00	Estante Fijo [2]	1	604.67	550.00	18.00
8	MELA_BL, 18.00	Estante Fijo [3]	1	604.67	550.00	18.00
9	MELA_BL, 18.00	Estante Fijo [4]	1	604.67	550.00	18.00
10	MELA_BL, 18.00	Estante Fijo [5]	1	604.67	550.00	18.00
11	MELA_BL, 18.00	Estante Fijo [6]	1	604.67	550.00	18.00
12	MELA_BL, 18.00	Estante Fijo [7]	1	604.67	550.00	18.00
13	MELA_BL, 18.00	Estante Fijo [8]	1	604.67	550.00	18.00
14	MELA_BL, 18.00	Estante Fijo [9]	1	604.67	550.00	18.00
15	MELA_BL, 18.00	Estante Fijo [10]	1	604.67	550.00	18.00
16	MELA_BL, 18.00	Estante Fijo [11]	1	604.67	550.00	18.00
17	MELA_BL, 18.00	Estante Fijo [12]	1	604.67	550.00	18.00
18	MELA_BL, 18.00	Estante Fijo [13]	1	604.67	550.00	18.00
19	MELA_BL, 18.00	Estante Fijo [14]	1	604.67	550.00	18.00
20	MELA_BL, 18.00	Estante Fijo [15]	1	604.67	550.00	18.00
21	MELA_BL, 18.00	División Vertical [1]	1	2500.00	550.00	18.00
22	MELA_BL, 18.00	División Vertical [2]	1	2500.00	550.00	18.00

Num	Material	Referencia	Cantidad	Altura (mm)	Anchura (mm)	Espesor (mm)
1	MELA_BL, 18.00	Techo	1	1886.00	397.00	18.00
2	MELA_BL, 18.00	Suelo	1	1850.00	397.00	18.00
3	MELA_BL, 18.00	Lateral Derecho	1	548.00	397.00	18.00
4	MELA_BL, 18.00	Lateral Izquierdo	1	548.00	397.00	18.00
5	MELA_BL, 18.00	Trasera	1	500.00	1850.00	18.00
6	MELA_BL, 18.00	Estante Fijo [1]	1	449.00	379.00	18.00
7	MELA_BL, 18.00	Estante Fijo [2]	1	449.00	379.00	18.00
8	MELA_BL, 18.00	División Vertical [1]	1	500.00	379.00	18.00
9	MELA_BL, 18.00	División Vertical [2]	1	500.00	379.00	18.00
10	MELA_BL, 18.00	División Vertical [3]	1	500.00	379.00	18.00
11	MELA_BL, 18.00	Puerta 1 (unica) [1]	1	530.00	479.00	18.00
12	MELA_BL, 18.00	Puerta 1 (unica) [2]	1	530.00	479.00	18.00
13	MELA_BL, 18.00	Zócalo 1 [1]	1	1850.00	30.00	18.00
14	MELA_BL, 18.00	Zócalo 1 [2]	1	1850.00	30.00	18.00

# Mueble Moderno #20

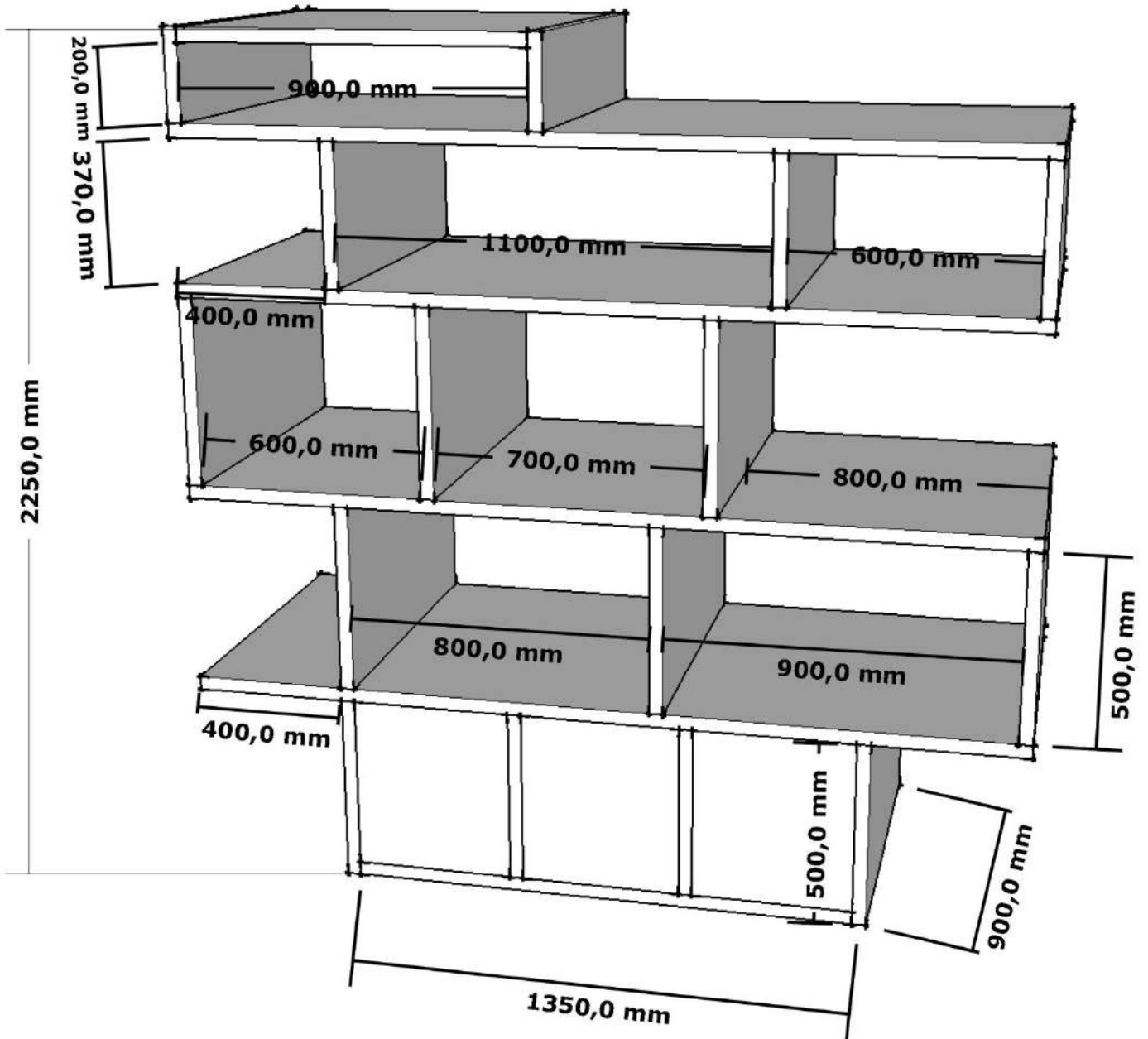

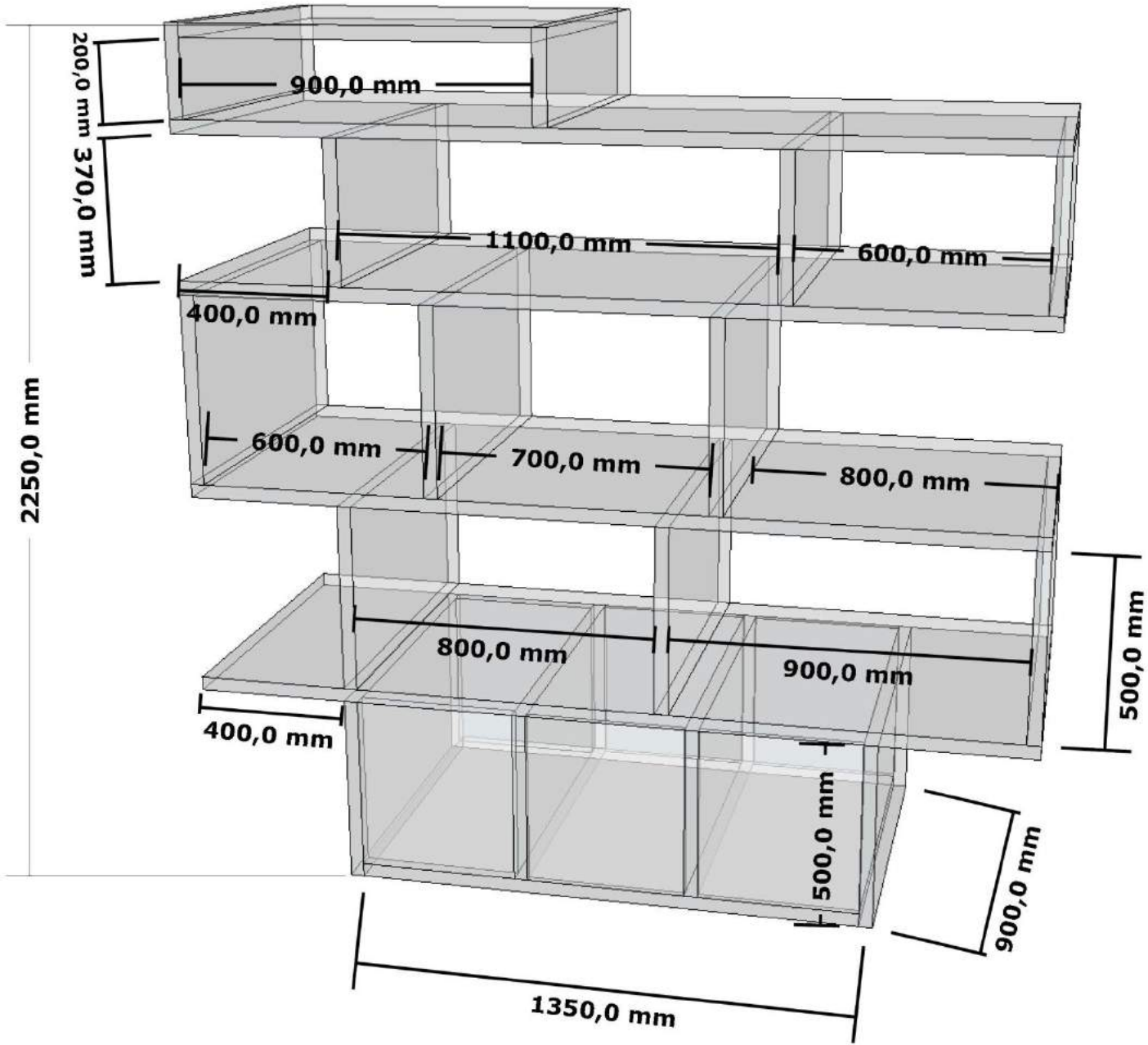



Num	Material	Referencia	Cantidad	Altura (mm)	Anchura (mm)	Espesor (mm)
1	MELA_BL 36MM, 36.00	Estante Fijo [1]	1	2208.00	900.00	36.00
2	MELA_BL 36MM, 36.00	Estante Fijo [2]	1	2208.00	900.00	36.00
3	MELA_BL 36MM, 36.00	Estante Fijo [3]	1	2208.00	900.00	36.00
4	MELA_BL 36MM, 36.00	Estante Fijo [4]	1	2208.00	900.00	36.00
5	MELA_BL 36MM, 36.00	Estante Fijo [5]	1	900.00	900.00	36.00
6	MELA_BL 36MM, 36.00	División Libre 1 [1]	1	1336.00	900.00	36.00
7	MELA_BL 36MM, 36.00	División Libre 1 [2]	1	464.00	421.33	36.00
8	MELA_BL 36MM, 36.00	División Libre 1 [3]	1	464.00	421.33	36.00
9	MELA_BL, 18.00	División Libre 1 [4]	1	464.00	421.33	18.00
10	MELA_BL, 18.00	División Libre 1 [5]	1	464.00	421.33	18.00
11	MELA_BL, 18.00	División Libre 1 [6]	1	464.00	421.33	18.00
12	MELA_BL, 18.00	División Libre 1 [7]	1	464.00	421.33	18.00
13	MELA_BL 36MM, 36.00	División Vertical [1]	1	500.00	900.00	36.00
14	MELA_BL 36MM, 36.00	División Vertical [2]	1	500.00	900.00	36.00
15	MELA_BL 36MM, 36.00	División Vertical [3]	1	464.00	900.00	36.00
16	MELA_BL 36MM, 36.00	División Vertical [4]	1	464.00	900.00	36.00
17	MELA_BL 36MM, 36.00	División Vertical [5]	1	500.00	900.00	36.00
18	MELA_BL 36MM, 36.00	División Vertical [6]	1	500.00	900.00	36.00
19	MELA_BL 36MM, 36.00	División Vertical [7]	1	500.00	900.00	36.00
20	MELA_BL 36MM, 36.00	División Vertical [8]	1	500.00	900.00	36.00
21	MELA_BL 36MM, 36.00	División Vertical [9]	1	500.00	900.00	36.00
22	MELA_BL 36MM, 36.00	División Vertical [10]	1	500.00	900.00	36.00
23	MELA_BL 36MM, 36.00	División Vertical [11]	1	370.00	900.00	36.00
24	MELA_BL 36MM, 36.00	División Vertical [12]	1	370.00	900.00	36.00
25	MELA_BL 36MM, 36.00	División Vertical [13]	1	370.00	900.00	36.00
26	MELA_BL 36MM, 36.00	División Vertical [14]	1	236.00	900.00	36.00
27	MELA_BL 36MM, 36.00	División Vertical [15]	1	236.00	900.00	36.00

# Mueble Moderno #21

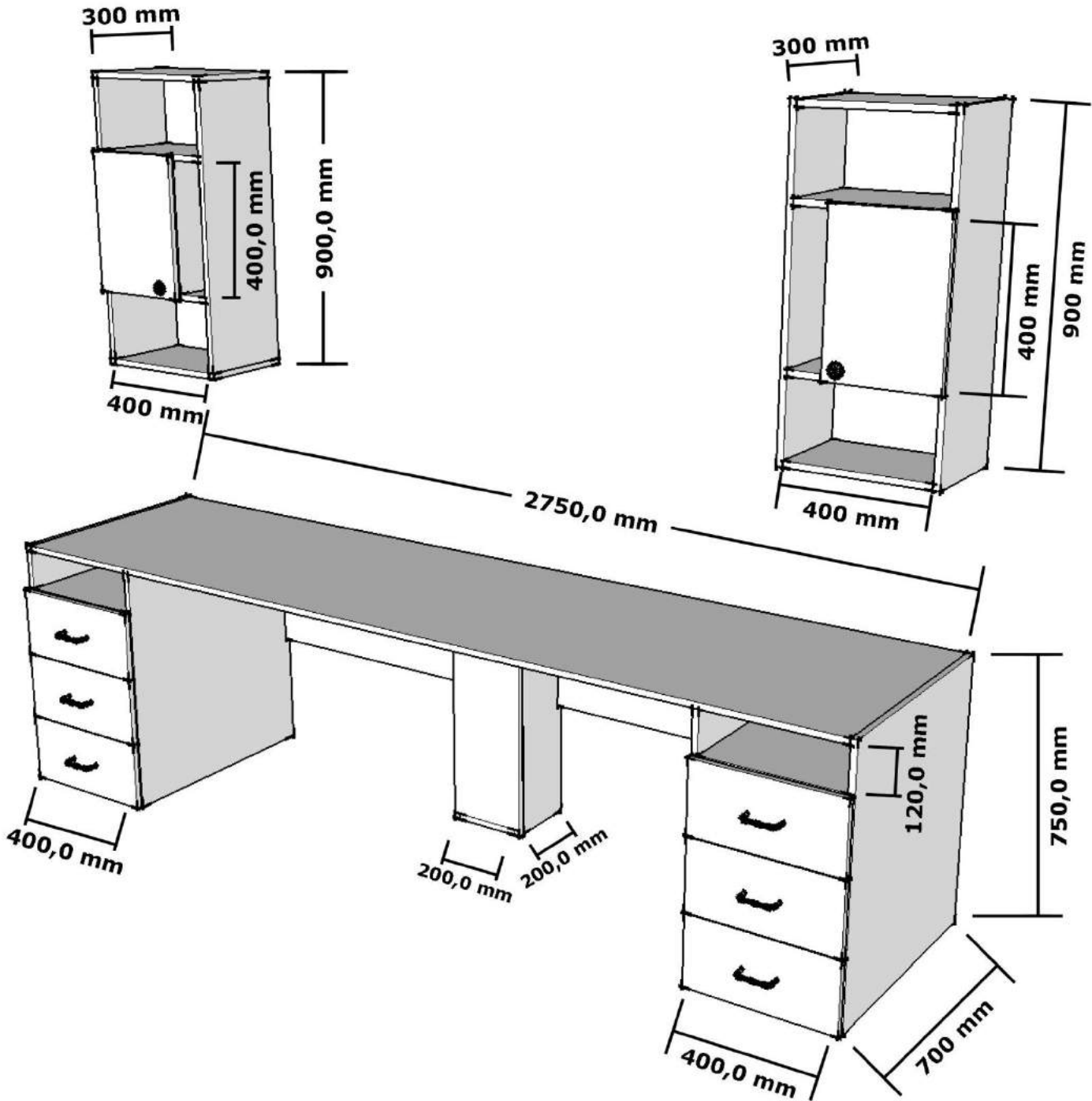

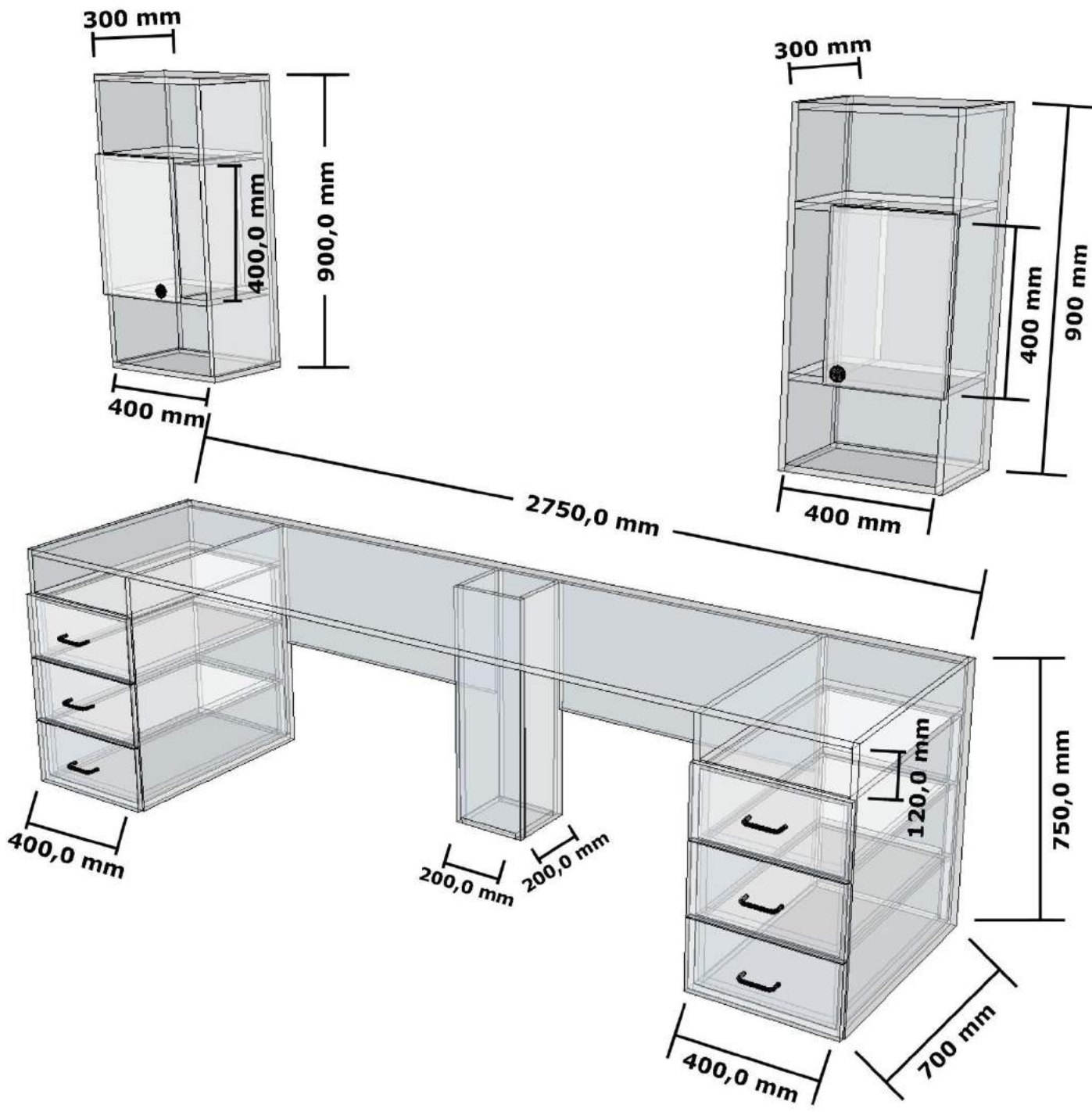

Num	Material	Referencia	Cantidad	Altura (mm)	Anchura (mm)	Espesor (mm)
1	MELA_BL, 18.00	Techo	1	2750.00	697.00	18.00
2	MELA_BL, 18.00	Lateral Derecho	1	768.00	697.00	18.00
3	MELA_BL, 18.00	Lateral Izquierdo	1	768.00	697.00	18.00
4	MELA_BL, 18.00	Estante Fijo [1]	1	400.00	697.00	18.00
5	MELA_BL, 18.00	Estante Fijo [2]	1	400.00	679.00	18.00
6	MELA_BL, 18.00	Estante Fijo [3]	1	400.00	697.00	18.00
7	MELA_BL, 18.00	Estante Fijo [4]	1	400.00	679.00	18.00
8	MELA_BL, 18.00	División Libre 1 [1]	1	732.00	400.00	18.00
9	MELA_BL, 18.00	División Libre 1 [2]	1	732.00	400.00	18.00
10	MELA_BL, 18.00	División Libre 1 [3]	1	750.00	200.00	18.00
11	MELA_BL, 18.00	División Libre 1 [4]	1	750.00	236.00	18.00
12	MELA_BL, 18.00	División Libre 1 [5]	1	200.00	196.00	18.00
13	MELA_BL, 18.00	División Libre 1 [6]	1	839.00	400.00	18.00
14	MELA_BL, 18.00	División Libre 1 [7]	1	839.00	400.00	18.00
15	MELA_BL, 18.00	División Vertical [1]	1	750.00	697.00	18.00
16	MELA_BL, 18.00	División Vertical [2]	1	750.00	697.00	18.00
17	MELA_BL, 18.00	División Vertical [3]	1	750.00	200.00	18.00
18	MELA_BL, 18.00	División Vertical [4]	1	750.00	200.00	18.00
19	MELA_BL, 18.00	Cajón 1 [1]_1	1	206.00	430.00	18.00
20	MELA_BL, 18.00	Cajón 1 [1]_2	1	206.00	430.00	18.00
21	MELA_BL, 18.00	Cajón 1 [1]_3	1	206.00	430.00	18.00
22	MELA_BL, 18.00	Cajón 1 [2]_1	1	206.00	430.00	18.00
23	MELA_BL, 18.00	Cajón 1 [2]_2	1	206.00	430.00	18.00
24	MELA_BL, 18.00	Cajón 1 [2]_3	1	206.00	430.00	18.00
25	MELA_BL, 18.00	Lateral Der Cajón 1 [1]_1	1	660.00	183.00	18.00
26	MELA_BL, 18.00	Lateral Der Cajón 1 [1]_2	1	660.00	198.00	18.00
27	MELA_BL, 18.00	Lateral Der Cajón 1 [1]_3	1	660.00	183.00	18.00
28	MELA_BL, 18.00	Lateral Der Cajón 1 [2]_1	1	660.00	183.00	18.00
29	MELA_BL, 18.00	Lateral Der Cajón 1 [2]_2	1	660.00	198.00	18.00
30	MELA_BL, 18.00	Lateral Der Cajón 1 [2]_3	1	660.00	183.00	18.00
31	MELA_BL, 18.00	Lateral Izq Cajón 1 [1]_1	1	660.00	183.00	18.00
32	MELA_BL, 18.00	Lateral Izq Cajón 1 [1]_2	1	660.00	198.00	18.00
33	MELA_BL, 18.00	Lateral Izq Cajón 1 [1]_3	1	660.00	183.00	18.00
34	MELA_BL, 18.00	Lateral Izq Cajón 1 [2]_1	1	660.00	183.00	18.00
35	MELA_BL, 18.00	Lateral Izq Cajón 1 [2]_2	1	660.00	198.00	18.00
36	MELA_BL, 18.00	Lateral Izq Cajón 1 [2]_3	1	660.00	183.00	18.00
37	MELA_BL, 18.00	Fondo Cajón 1 [1]_1	1	642.00	358.00	18.00
38	MELA_BL, 18.00	Fondo Cajón 1 [1]_2	1	642.00	358.00	18.00
39	MELA_BL, 18.00	Fondo Cajón 1 [1]_3	1	642.00	358.00	18.00
40	MELA_BL, 18.00	Fondo Cajón 1 [2]_1	1	642.00	358.00	18.00
41	MELA_BL, 18.00	Fondo Cajón 1 [2]_2	1	642.00	358.00	18.00
42	MELA_BL, 18.00	Fondo Cajón 1 [2]_3	1	642.00	358.00	18.00
43	MELA_BL, 18.00	Trasera Cajón 1 [1]_1	1	358.00	183.00	18.00
44	MELA_BL, 18.00	Trasera Cajón 1 [1]_2	1	358.00	198.00	18.00
45	MELA_BL, 18.00	Trasera Cajón 1 [1]_3	1	358.00	183.00	18.00
46	MELA_BL, 18.00	Trasera Cajón 1 [2]_1	1	358.00	183.00	18.00
47	MELA_BL, 18.00	Trasera Cajón 1 [2]_2	1	358.00	198.00	18.00
48	MELA_BL, 18.00	Trasera Cajón 1 [2]_3	1	358.00	183.00	18.00
49	MELA_BL, 18.00	Contra-Frente Cajón 1 [1]_1	1	394.00	183.00	18.00
50	MELA_BL, 18.00	Contra-Frente Cajón 1 [1]_2	1	394.00	198.00	18.00
51	MELA_BL, 18.00	Contra-Frente Cajón 1 [1]_3	1	394.00	183.00	18.00
52	MELA_BL, 18.00	Contra-Frente Cajón 1 [2]_1	1	394.00	183.00	18.00
53	MELA_BL, 18.00	Contra-Frente Cajón 1 [2]_2	1	394.00	198.00	18.00
54	MELA_BL, 18.00	Contra-Frente Cajón 1 [2]_3	1	394.00	183.00	18.00

Num	Material	Referencia	Cantidad	Altura (mm)	Anchura (mm)	Espesor (mm)
1	MELA_BL, 18.00	Techo	1	436.00	297.00	18.00
2	MELA_BL, 18.00	Suelo	1	436.00	297.00	18.00
3	MELA_BL, 18.00	Lateral Derecho	1	864.00	297.00	18.00
4	MELA_BL, 18.00	Lateral Izquierdo	1	864.00	297.00	18.00
5	MELA_BL, 18.00	Trasera	1	864.00	400.00	18.00
6	MELA_BL, 18.00	Estante Fijo [1]	1	400.00	279.00	18.00
7	MELA_BL, 18.00	Estante Fijo [2]	1	400.00	279.00	18.00
8	MELA_BL, 18.00	División Vertical [1]	1	400.00	279.00	18.00
9	MELA_BL, 18.00	Puerta 1 (unica) [1]	1	430.00	312.00	18.00

Num	Material	Referencia	Cantidad	Altura (mm)	Anchura (mm)	Espesor (mm)
1	MELA_BL, 18.00	Techo	1	400.00	297.00	18.00
2	MELA_BL, 18.00	Suelo	1	400.00	297.00	18.00
3	MELA_BL, 18.00	Lateral Derecho	1	900.00	297.00	18.00
4	MELA_BL, 18.00	Lateral Izquierdo	1	900.00	297.00	18.00
5	MELA_BL, 18.00	Trasera	1	864.00	400.00	18.00
6	MELA_BL, 18.00	Estante Fijo [1]	1	400.00	279.00	18.00
7	MELA_BL, 18.00	Estante Fijo [2]	1	400.00	279.00	18.00
8	MELA_BL, 18.00	División Vertical [1]	1	400.00	279.00	18.00
9	MELA_BL, 18.00	Puerta 1 (unica) [1]	1	430.00	312.00	18.00

# Mueble Moderno #22

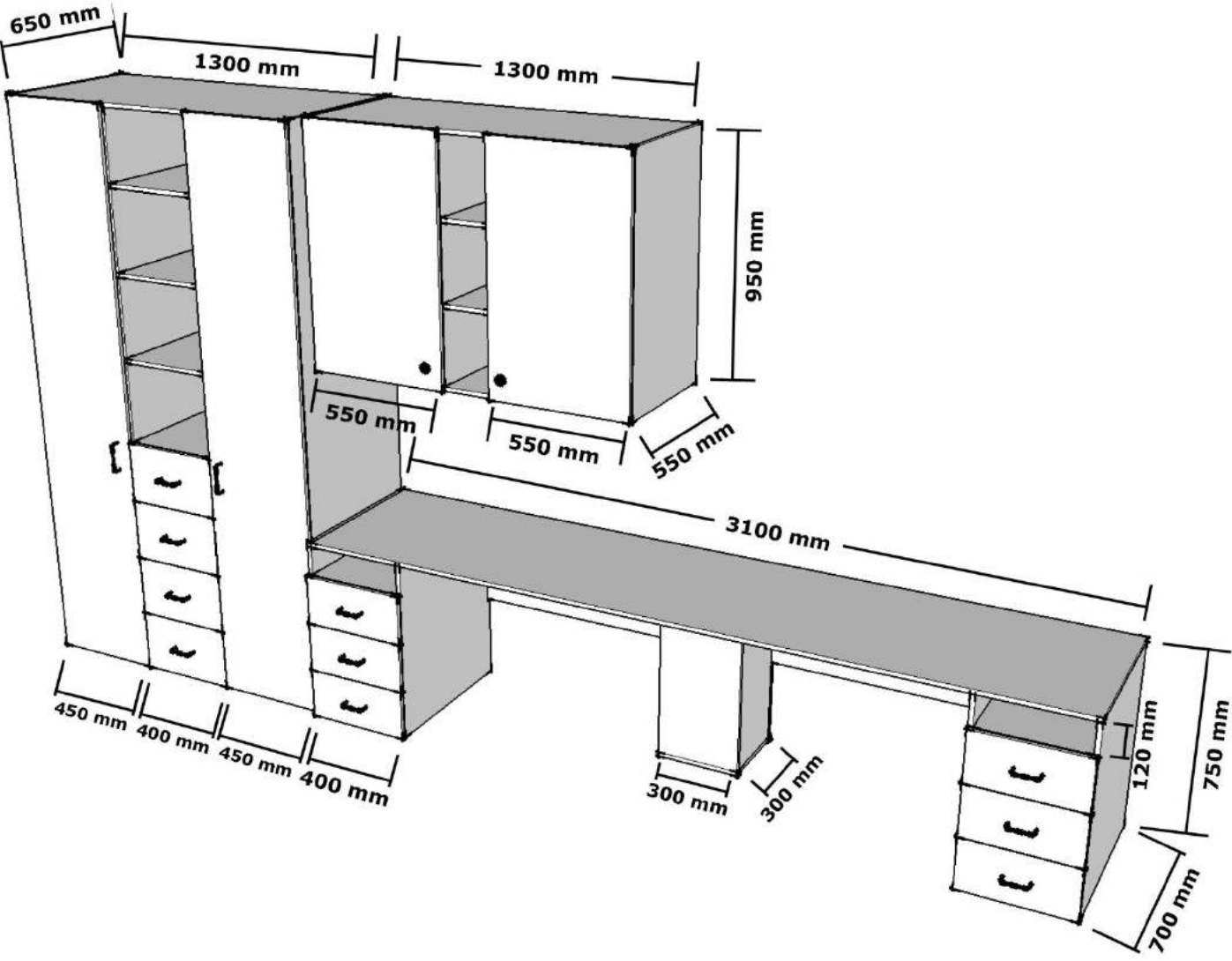

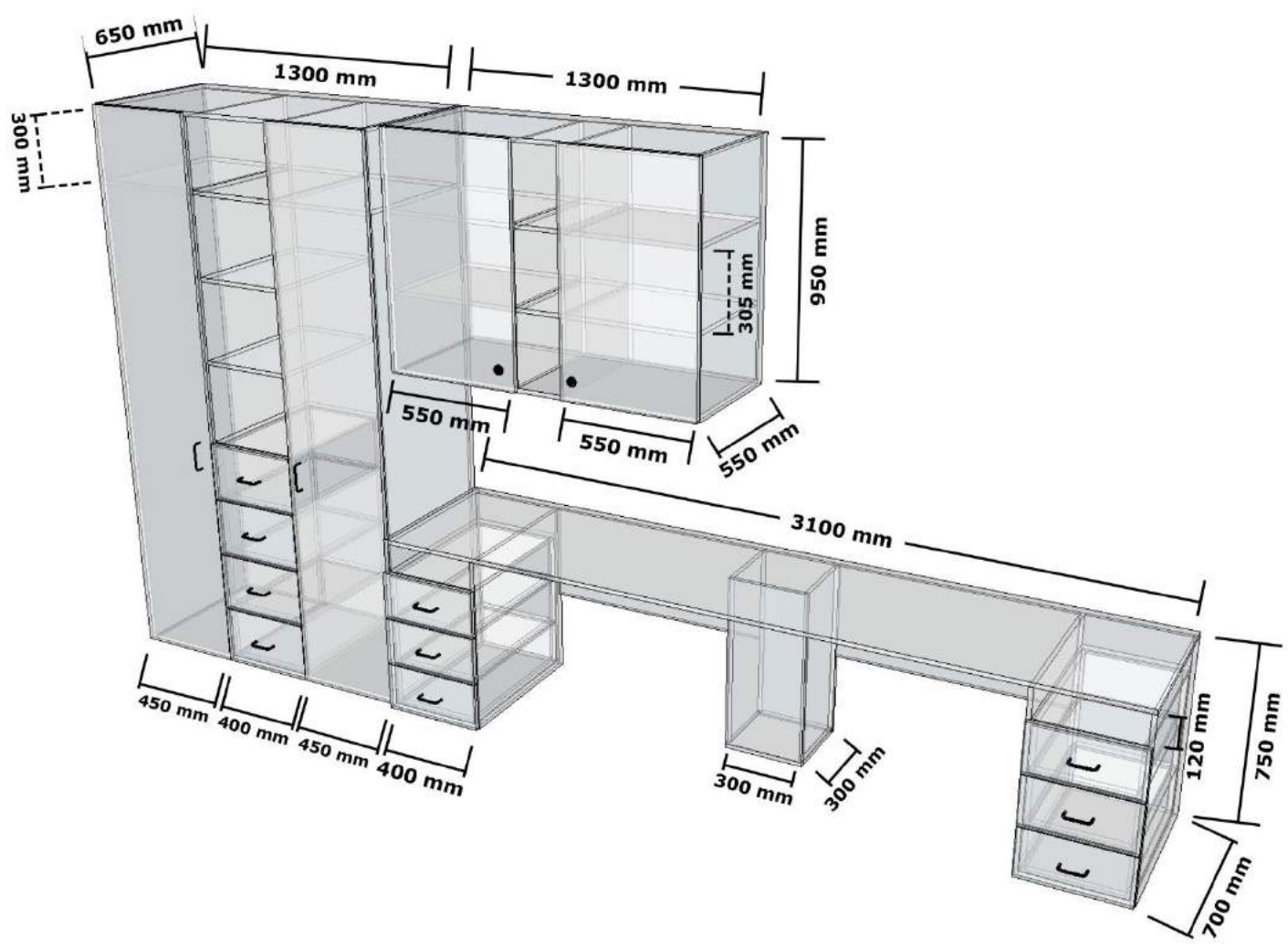

Num	Material	Referencia	Cantidad	Altura (mm)	Anchura (mm)	Espesor (mm)
1	MELA_BL, 18.00	Techo	1	1336.00	647.00	18.00
2	MELA_BL, 18.00	Suelo	1	1336.00	647.00	18.00
3	MELA_BL, 18.00	Lateral Derecho	1	2436.00	647.00	18.00
4	MELA_BL, 18.00	Lateral Izquierdo	1	2436.00	647.00	18.00
5	MELA_BL, 18.00	Trasera	1	2400.00	1336.00	18.00
6	MELA_BL, 18.00	Estante Fijo [1]	1	400.00	629.00	18.00
7	MELA_BL, 18.00	Estante Fijo [2]	1	450.00	629.00	18.00
8	MELA_BL, 18.00	Estante Fijo [3]	1	400.00	629.00	18.00
9	MELA_BL, 18.00	Estante Fijo [4]	1	450.00	629.00	18.00
10	MELA_BL, 18.00	Estante Fijo [5]	1	400.00	629.00	18.00
11	MELA_BL, 18.00	Estante Fijo [6]	1	400.00	629.00	18.00
12	MELA_BL, 18.00	División Vertical [1]	1	2400.00	629.00	18.00
13	MELA_BL, 18.00	División Vertical [2]	1	2400.00	629.00	18.00
14	MELA_BL, 18.00	Puerta 1 (unica) [1]	1	2430.00	472.50	18.00
15	MELA_BL, 18.00	Puerta 1 (unica) [2]	1	2430.00	472.50	18.00
16	MELA_BL, 18.00	Cajón 1 [1]_1	1	255.25	415.00	18.00
17	MELA_BL, 18.00	Cajón 1 [1]_2	1	255.25	415.00	18.00
18	MELA_BL, 18.00	Cajón 1 [1]_3	1	255.25	415.00	18.00
19	MELA_BL, 18.00	Cajón 1 [1]_4	1	255.25	415.00	18.00
20	MELA_BL, 18.00	Lateral Der Cajón 1 [1]_1	1	610.00	232.25	18.00
21	MELA_BL, 18.00	Lateral Der Cajón 1 [1]_2	1	610.00	247.25	18.00
22	MELA_BL, 18.00	Lateral Der Cajón 1 [1]_3	1	610.00	247.25	18.00
23	MELA_BL, 18.00	Lateral Der Cajón 1 [1]_4	1	610.00	232.25	18.00
24	MELA_BL, 18.00	Lateral Izq Cajón 1 [1]_1	1	610.00	232.25	18.00
25	MELA_BL, 18.00	Lateral Izq Cajón 1 [1]_2	1	610.00	247.25	18.00
26	MELA_BL, 18.00	Lateral Izq Cajón 1 [1]_3	1	610.00	247.25	18.00
27	MELA_BL, 18.00	Lateral Izq Cajón 1 [1]_4	1	610.00	232.25	18.00
28	MELA_BL, 18.00	Fondo Cajón 1 [1]_1	1	592.00	358.00	18.00
29	MELA_BL, 18.00	Fondo Cajón 1 [1]_2	1	592.00	358.00	18.00
30	MELA_BL, 18.00	Fondo Cajón 1 [1]_3	1	592.00	358.00	18.00
31	MELA_BL, 18.00	Fondo Cajón 1 [1]_4	1	592.00	358.00	18.00
32	MELA_BL, 18.00	Trasera Cajón 1 [1]_1	1	358.00	232.25	18.00
33	MELA_BL, 18.00	Trasera Cajón 1 [1]_2	1	358.00	247.25	18.00
34	MELA_BL, 18.00	Trasera Cajón 1 [1]_3	1	358.00	247.25	18.00
35	MELA_BL, 18.00	Trasera Cajón 1 [1]_4	1	358.00	232.25	18.00
36	MELA_BL, 18.00	Contra-Frente Cajón 1 [1]_1	1	394.00	232.25	18.00
37	MELA_BL, 18.00	Contra-Frente Cajón 1 [1]_2	1	394.00	247.25	18.00
38	MELA_BL, 18.00	Contra-Frente Cajón 1 [1]_3	1	394.00	247.25	18.00
39	MELA_BL, 18.00	Contra-Frente Cajón 1 [1]_4	1	394.00	232.25	18.00



Num	Material	Referencia	Cantidad	Altura (mm)	Anchura (mm)	Espesor (mm)
1	MELA_BL, 18.00	Techo	1	3118.00	679.00	18.00
2	MELA_BL, 18.00	Lateral Derecho	1	750.00	679.00	18.00
3	MELA_BL, 18.00	Lateral Izquierdo	1	768.00	679.00	18.00
4	MELA_BL, 18.00	Estante Fijo [1]	1	400.00	679.00	18.00
5	MELA_BL, 18.00	Estante Fijo [2]	1	400.00	661.00	18.00
6	MELA_BL, 18.00	Estante Fijo [3]	1	400.00	679.00	18.00
7	MELA_BL, 18.00	Estante Fijo [4]	1	400.00	661.00	18.00
8	MELA_BL, 18.00	División Libre 1 [1]	1	732.00	400.00	18.00
9	MELA_BL, 18.00	División Libre 1 [2]	1	732.00	400.00	18.00
10	MELA_BL, 18.00	División Libre 1 [3]	1	750.00	336.00	18.00
11	MELA_BL, 18.00	División Libre 1 [4]	1	750.00	336.00	18.00
12	MELA_BL, 18.00	División Libre 1 [5]	1	336.00	329.00	18.00
13	MELA_BL, 18.00	División Libre 1 [6]	1	964.00	400.00	18.00
14	MELA_BL, 18.00	División Libre 1 [7]	1	964.00	400.00	18.00
15	MELA_BL, 18.00	División Vertical [1]	1	750.00	679.00	18.00
16	MELA_BL, 18.00	División Vertical [2]	1	750.00	679.00	18.00
17	MELA_BL, 18.00	División Vertical [3]	1	732.00	300.00	18.00
18	MELA_BL, 18.00	División Vertical [4]	1	732.00	300.00	18.00
19	MELA_BL, 18.00	Cajón 1 [1]_1	1	206.00	430.00	18.00
20	MELA_BL, 18.00	Cajón 1 [1]_2	1	206.00	430.00	18.00
21	MELA_BL, 18.00	Cajón 1 [1]_3	1	206.00	430.00	18.00
22	MELA_BL, 18.00	Cajón 1 [2]_1	1	206.00	430.00	18.00
23	MELA_BL, 18.00	Cajón 1 [2]_2	1	206.00	430.00	18.00
24	MELA_BL, 18.00	Cajón 1 [2]_3	1	206.00	430.00	18.00
25	MELA_BL, 18.00	Lateral Der Cajón 1 [1]_1	1	642.00	183.00	18.00
26	MELA_BL, 18.00	Lateral Der Cajón 1 [1]_2	1	642.00	198.00	18.00
27	MELA_BL, 18.00	Lateral Der Cajón 1 [1]_3	1	642.00	183.00	18.00
28	MELA_BL, 18.00	Lateral Der Cajón 1 [2]_1	1	642.00	183.00	18.00
29	MELA_BL, 18.00	Lateral Der Cajón 1 [2]_2	1	642.00	198.00	18.00
30	MELA_BL, 18.00	Lateral Der Cajón 1 [2]_3	1	642.00	183.00	18.00
31	MELA_BL, 18.00	Lateral Izq Cajón 1 [1]_1	1	642.00	183.00	18.00
32	MELA_BL, 18.00	Lateral Izq Cajón 1 [1]_2	1	642.00	198.00	18.00
33	MELA_BL, 18.00	Lateral Izq Cajón 1 [1]_3	1	642.00	183.00	18.00
34	MELA_BL, 18.00	Lateral Izq Cajón 1 [2]_1	1	642.00	183.00	18.00
35	MELA_BL, 18.00	Lateral Izq Cajón 1 [2]_2	1	642.00	198.00	18.00
36	MELA_BL, 18.00	Lateral Izq Cajón 1 [2]_3	1	642.00	183.00	18.00
37	MELA_BL, 18.00	Fondo Cajón 1 [1]_1	1	624.00	358.00	18.00
38	MELA_BL, 18.00	Fondo Cajón 1 [1]_2	1	624.00	358.00	18.00
39	MELA_BL, 18.00	Fondo Cajón 1 [1]_3	1	624.00	358.00	18.00
40	MELA_BL, 18.00	Fondo Cajón 1 [2]_1	1	624.00	358.00	18.00
41	MELA_BL, 18.00	Fondo Cajón 1 [2]_2	1	624.00	358.00	18.00
42	MELA_BL, 18.00	Fondo Cajón 1 [2]_3	1	624.00	358.00	18.00
43	MELA_BL, 18.00	Trasera Cajón 1 [1]_1	1	358.00	183.00	18.00
44	MELA_BL, 18.00	Trasera Cajón 1 [1]_2	1	358.00	198.00	18.00
45	MELA_BL, 18.00	Trasera Cajón 1 [1]_3	1	358.00	183.00	18.00
46	MELA_BL, 18.00	Trasera Cajón 1 [2]_1	1	358.00	183.00	18.00
47	MELA_BL, 18.00	Trasera Cajón 1 [2]_2	1	358.00	198.00	18.00
48	MELA_BL, 18.00	Trasera Cajón 1 [2]_3	1	358.00	183.00	18.00
49	MELA_BL, 18.00	Contra-Frente Cajón 1 [1]_1	1	394.00	183.00	18.00
50	MELA_BL, 18.00	Contra-Frente Cajón 1 [1]_2	1	394.00	198.00	18.00
51	MELA_BL, 18.00	Contra-Frente Cajón 1 [1]_3	1	394.00	183.00	18.00
52	MELA_BL, 18.00	Contra-Frente Cajón 1 [2]_1	1	394.00	183.00	18.00
53	MELA_BL, 18.00	Contra-Frente Cajón 1 [2]_2	1	394.00	198.00	18.00
54	MELA_BL, 18.00	Contra-Frente Cajón 1 [2]_3	1	394.00	183.00	18.00

Num	Material	Referencia	Cantidad	Altura (mm)	Anchura (mm)	Espesor (mm)
1	MELA_BL, 18.00	Techo	1	1336.00	547.00	18.00
2	MELA_BL, 18.00	Suelo	1	1336.00	547.00	18.00
3	MELA_BL, 18.00	Lateral Derecho	1	986.00	547.00	18.00
4	MELA_BL, 18.00	Lateral Izquierdo	1	986.00	547.00	18.00
5	MELA_BL, 18.00	Trasera	1	950.00	1336.00	18.00
6	MELA_BL, 18.00	Estante Fijo [1]	1	550.00	529.00	18.00
7	MELA_BL, 18.00	Estante Fijo [2]	1	550.00	529.00	18.00
8	MELA_BL, 18.00	Estante Fijo [3]	1	550.00	529.00	18.00
9	MELA_BL, 18.00	Estante Fijo [4]	1	550.00	529.00	18.00
10	MELA_BL, 18.00	Estante Fijo [5]	1	200.00	529.00	18.00
11	MELA_BL, 18.00	Estante Fijo [6]	1	200.00	529.00	18.00
12	MELA_BL, 18.00	División Vertical [1]	1	950.00	529.00	18.00
13	MELA_BL, 18.00	División Vertical [2]	1	950.00	529.00	18.00
14	MELA_BL, 18.00	Puerta 1 (unica) [1]	1	980.00	580.00	18.00
15	MELA_BL, 18.00	Puerta 1 (unica) [2]	1	980.00	580.00	18.00

# Mueble Moderno #23

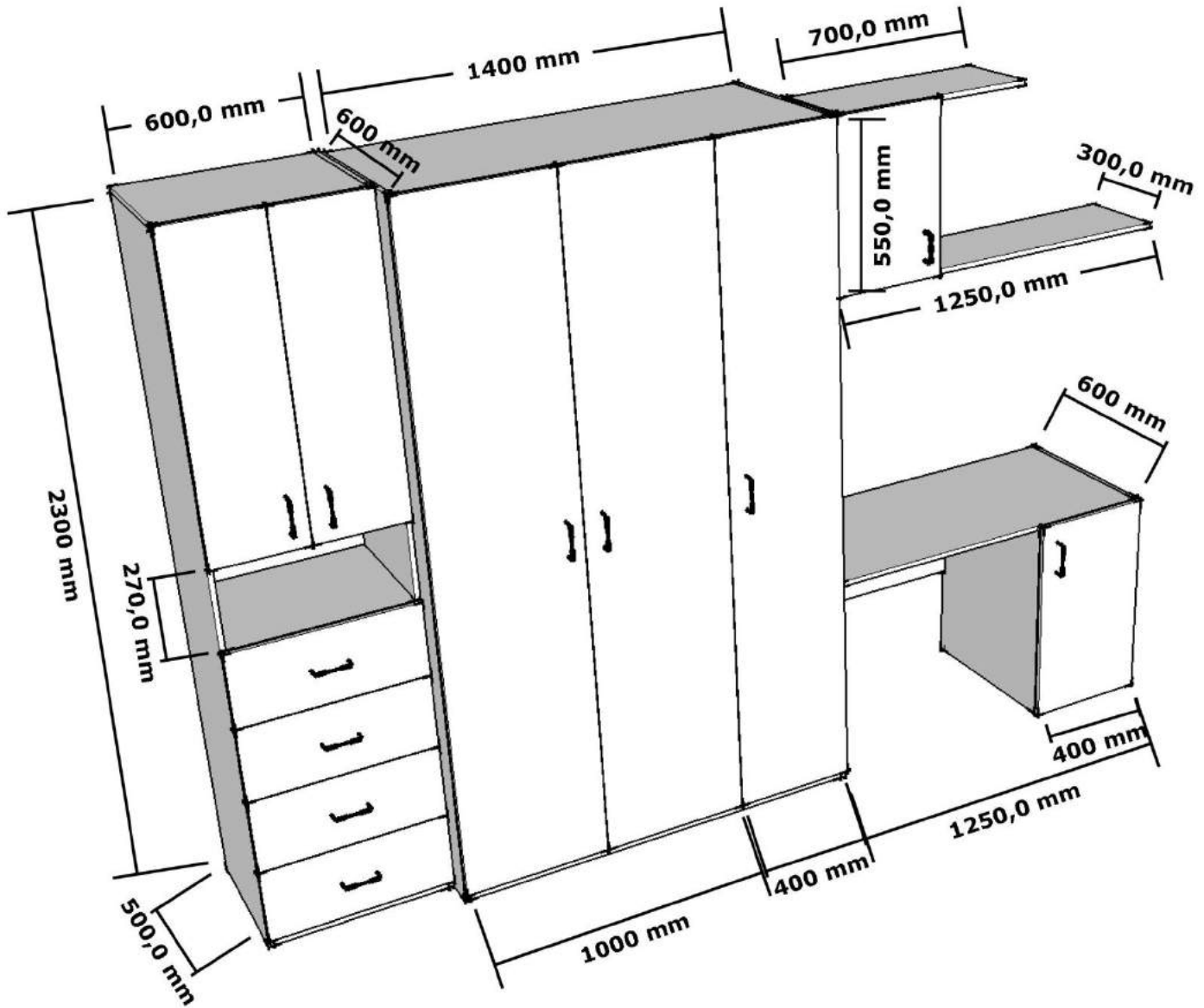

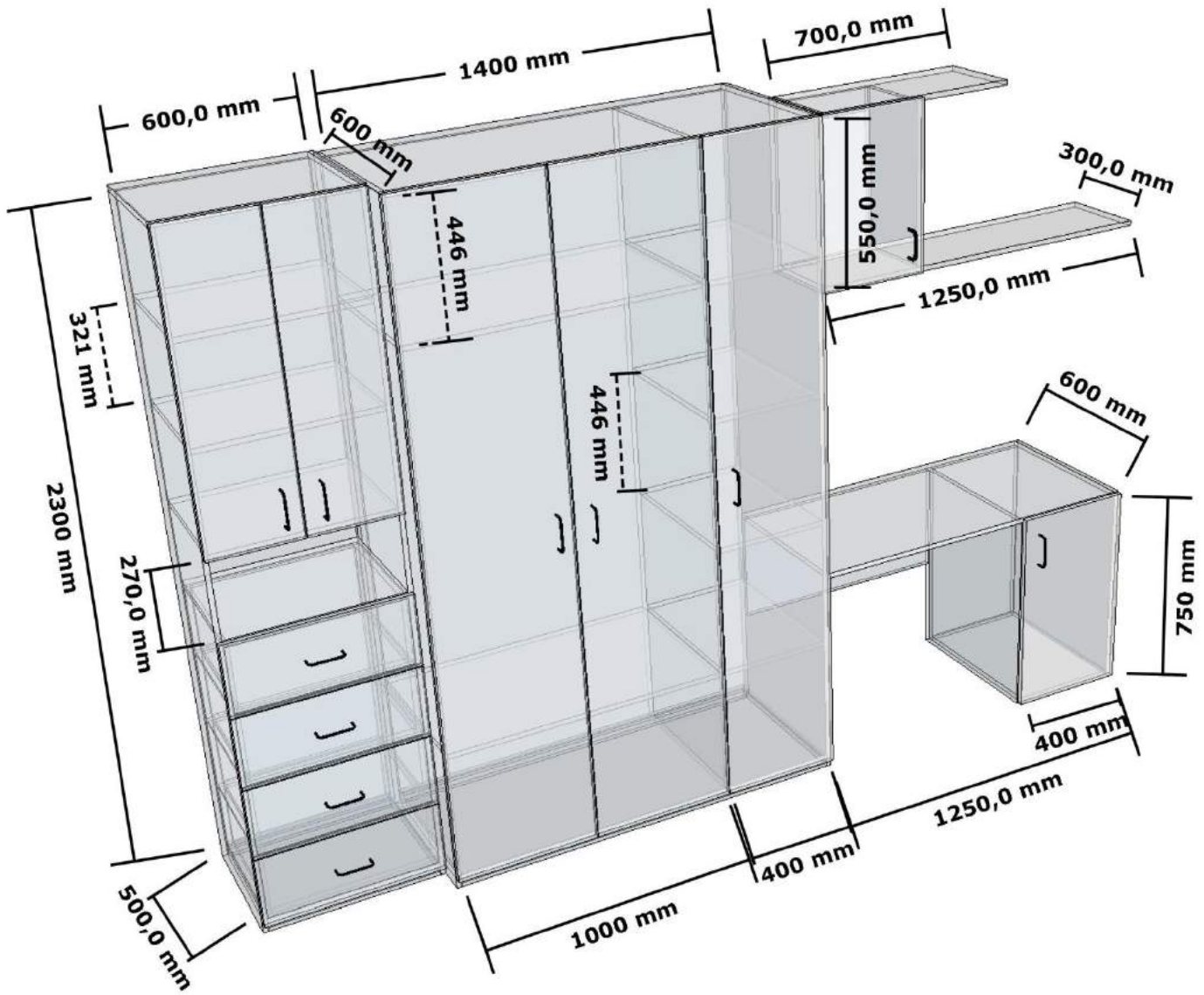

Num	Material	Referencia	Cantidad	Altura (mm)	Anchura (mm)	Espesor (mm)
1	MELA_BL, 18.00	Techo	1	618.00	497.00	18.00
2	MELA_BL, 18.00	Suelo	1	600.00	497.00	18.00
3	MELA_BL, 18.00	Lateral Derecho	1	2372.00	497.00	18.00
4	MELA_BL, 18.00	Lateral Izquierdo	1	2354.00	497.00	18.00
5	MELA_BL, 18.00	Trasera	1	2306.00	600.00	18.00
6	MELA_BL, 18.00	Estante Fijo [1]	1	600.00	479.00	18.00
7	MELA_BL, 18.00	Estante Fijo [2]	1	600.00	479.00	18.00
8	MELA_BL, 18.00	Estante Fijo [3]	1	600.00	479.00	18.00
9	MELA_BL, 18.00	Estante Fijo [4]	1	600.00	479.00	18.00
10	MELA_BL, 18.00	Puerta 1 (doble) [1]_1	1	1030.00	313.50	18.00
11	MELA_BL, 18.00	Puerta 1 (doble) [1]_2	1	1030.00	313.50	18.00
12	MELA_BL, 18.00	Cajón 1 [1]_1	1	255.25	630.00	18.00
13	MELA_BL, 18.00	Cajón 1 [1]_2	1	255.25	630.00	18.00
14	MELA_BL, 18.00	Cajón 1 [1]_3	1	255.25	630.00	18.00
15	MELA_BL, 18.00	Cajón 1 [1]_4	1	255.25	630.00	18.00
16	MELA_BL, 18.00	Lateral Der Cajón 1 [1]_1	1	460.00	232.25	18.00
17	MELA_BL, 18.00	Lateral Der Cajón 1 [1]_2	1	460.00	247.25	18.00
18	MELA_BL, 18.00	Lateral Der Cajón 1 [1]_3	1	460.00	247.25	18.00
19	MELA_BL, 18.00	Lateral Der Cajón 1 [1]_4	1	460.00	232.25	18.00
20	MELA_BL, 18.00	Lateral Izq Cajón 1 [1]_1	1	460.00	232.25	18.00
21	MELA_BL, 18.00	Lateral Izq Cajón 1 [1]_2	1	460.00	247.25	18.00
22	MELA_BL, 18.00	Lateral Izq Cajón 1 [1]_3	1	460.00	247.25	18.00
23	MELA_BL, 18.00	Lateral Izq Cajón 1 [1]_4	1	460.00	232.25	18.00
24	MELA_BL, 18.00	Fondo Cajón 1 [1]_1	1	558.00	442.00	18.00
25	MELA_BL, 18.00	Fondo Cajón 1 [1]_2	1	558.00	442.00	18.00
26	MELA_BL, 18.00	Fondo Cajón 1 [1]_3	1	558.00	442.00	18.00
27	MELA_BL, 18.00	Fondo Cajón 1 [1]_4	1	558.00	442.00	18.00
28	MELA_BL, 18.00	Trasera Cajón 1 [1]_1	1	558.00	232.25	18.00
29	MELA_BL, 18.00	Trasera Cajón 1 [1]_2	1	558.00	247.25	18.00
30	MELA_BL, 18.00	Trasera Cajón 1 [1]_3	1	558.00	247.25	18.00
31	MELA_BL, 18.00	Trasera Cajón 1 [1]_4	1	558.00	232.25	18.00
32	MELA_BL, 18.00	Contra-Frente Cajón 1 [1]_1	1	594.00	232.25	18.00
33	MELA_BL, 18.00	Contra-Frente Cajón 1 [1]_2	1	594.00	247.25	18.00
34	MELA_BL, 18.00	Contra-Frente Cajón 1 [1]_3	1	594.00	247.25	18.00
35	MELA_BL, 18.00	Contra-Frente Cajón 1 [1]_4	1	594.00	232.25	18.00
36	MELA_BL, 18.00	Zócalo 1 [1]	1	600.00	30.00	18.00
37	MELA_BL, 18.00	Zócalo 1 [2]	1	600.00	30.00	18.00

Num	Material	Referencia	Cantidad	Altura (mm)	Anchura (mm)	Espesor (mm)
1	MELA_BL, 18.00	Techo	1	1418.00	597.00	18.00
2	MELA_BL, 18.00	Suelo	1	1418.00	597.00	18.00
3	MELA_BL, 18.00	Lateral Derecho	1	2366.00	597.00	18.00
4	MELA_BL, 18.00	Lateral Izquierdo	1	2366.00	597.00	18.00
5	MELA_BL, 18.00	Trasera	1	2300.00	1418.00	18.00
6	MELA_BL, 18.00	Estante Fijo [1]	1	400.00	579.00	18.00
7	MELA_BL, 18.00	Estante Fijo [2]	1	400.00	579.00	18.00
8	MELA_BL, 18.00	Estante Fijo [3]	1	400.00	579.00	18.00
9	MELA_BL, 18.00	Estante Fijo [4]	1	400.00	579.00	18.00
10	MELA_BL, 18.00	Estante Fijo [5]	1	1000.00	579.00	18.00
11	MELA_BL, 18.00	Estante Fijo [6]	1	1000.00	579.00	18.00
12	MELA_BL, 18.00	División Vertical [1]	1	2300.00	579.00	18.00
13	MELA_BL, 18.00	Puerta 1 (unica) [1]	1	2330.00	422.50	18.00
14	MELA_BL, 18.00	Puerta 1 (doble) [1]_1	1	2330.00	509.75	18.00
15	MELA_BL, 18.00	Puerta 1 (doble) [1]_2	1	2330.00	509.75	18.00
16	MELA_BL, 18.00	Zócalo 1 [1]	1	1418.00	30.00	18.00
17	MELA_BL, 18.00	Zócalo 1 [2]	1	1418.00	30.00	18.00

Num	Material	Referencia	Cantidad	Altura (mm)	Anchura (mm)	Espesor (mm)
1	MELA_BL, 18.00	Techo	1	1258.00	597.00	18.00
2	MELA_BL, 18.00	Lateral Derecho	1	750.00	597.00	18.00
3	MELA_BL, 18.00	División Libre 1 [1]	1	750.00	400.00	18.00
4	MELA_BL, 18.00	División Libre 1 [2]	1	579.00	400.00	18.00
5	MELA_BL, 18.00	División Libre 1 [3]	1	822.00	400.00	18.00
6	MELA_BL, 18.00	División Vertical [1]	1	750.00	597.00	18.00
7	MELA_BL, 18.00	Puerta 1 (unica) [1]	1	762.00	430.00	18.00

Num	Material	Referencia	Cantidad	Altura (mm)	Anchura (mm)	Espesor (mm)
1	MELA_BL, 18.00	Lateral Izquierdo	1	586.00	300.00	18.00
2	MELA_BL, 18.00	Estante Fijo [1]	1	1240.00	300.00	18.00
3	MELA_BL, 18.00	Estante Fijo [2]	1	700.00	300.00	18.00
4	MELA_BL, 18.00	División Libre 1 [1]	1	550.00	350.00	18.00
5	MELA_BL, 18.00	División Vertical [1]	1	550.00	300.00	18.00
6	MELA_BL, 18.00	Puerta 1 (unica) [1]	1	580.00	380.00	18.00

## Mueble Moderno #24

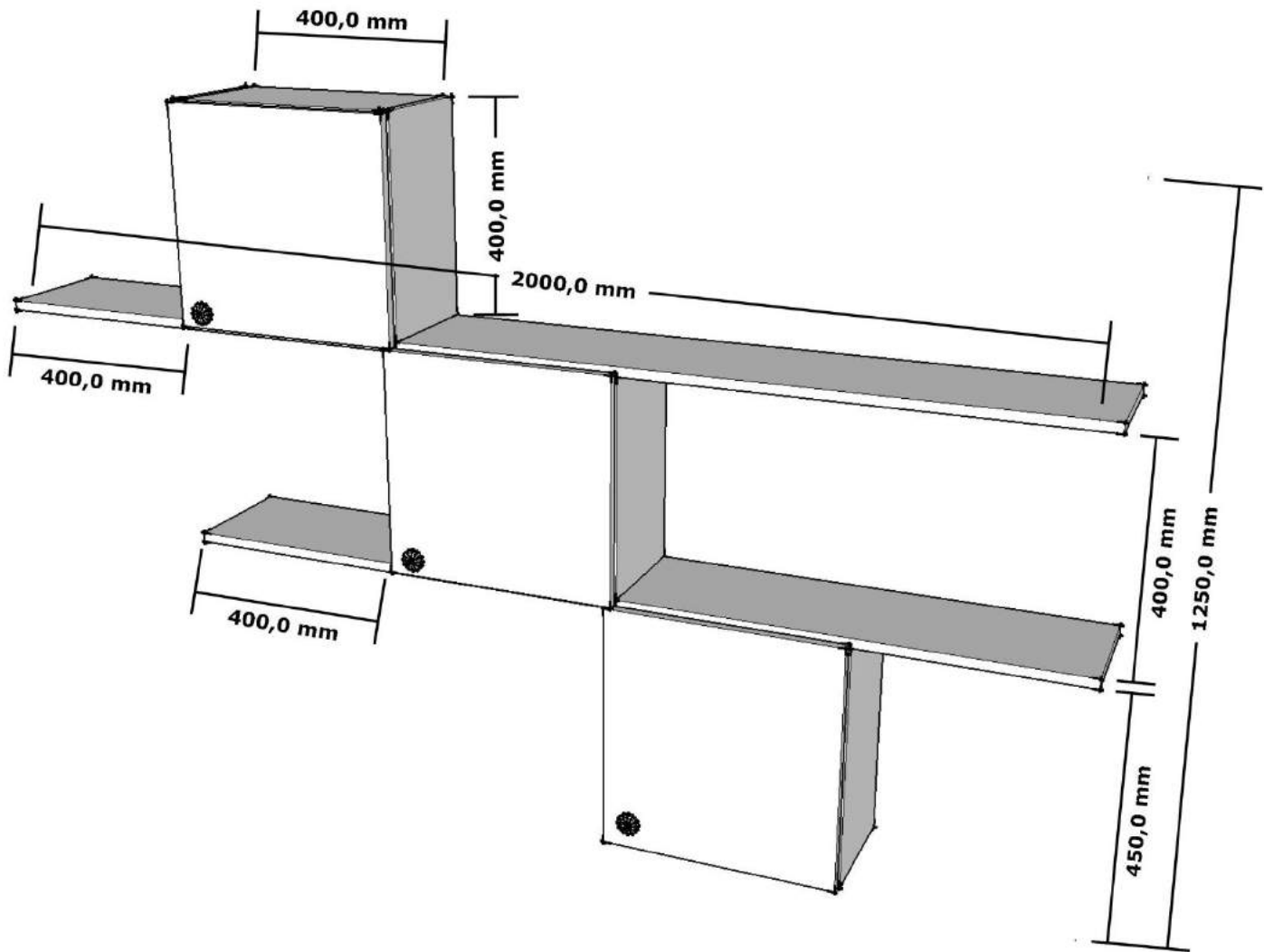

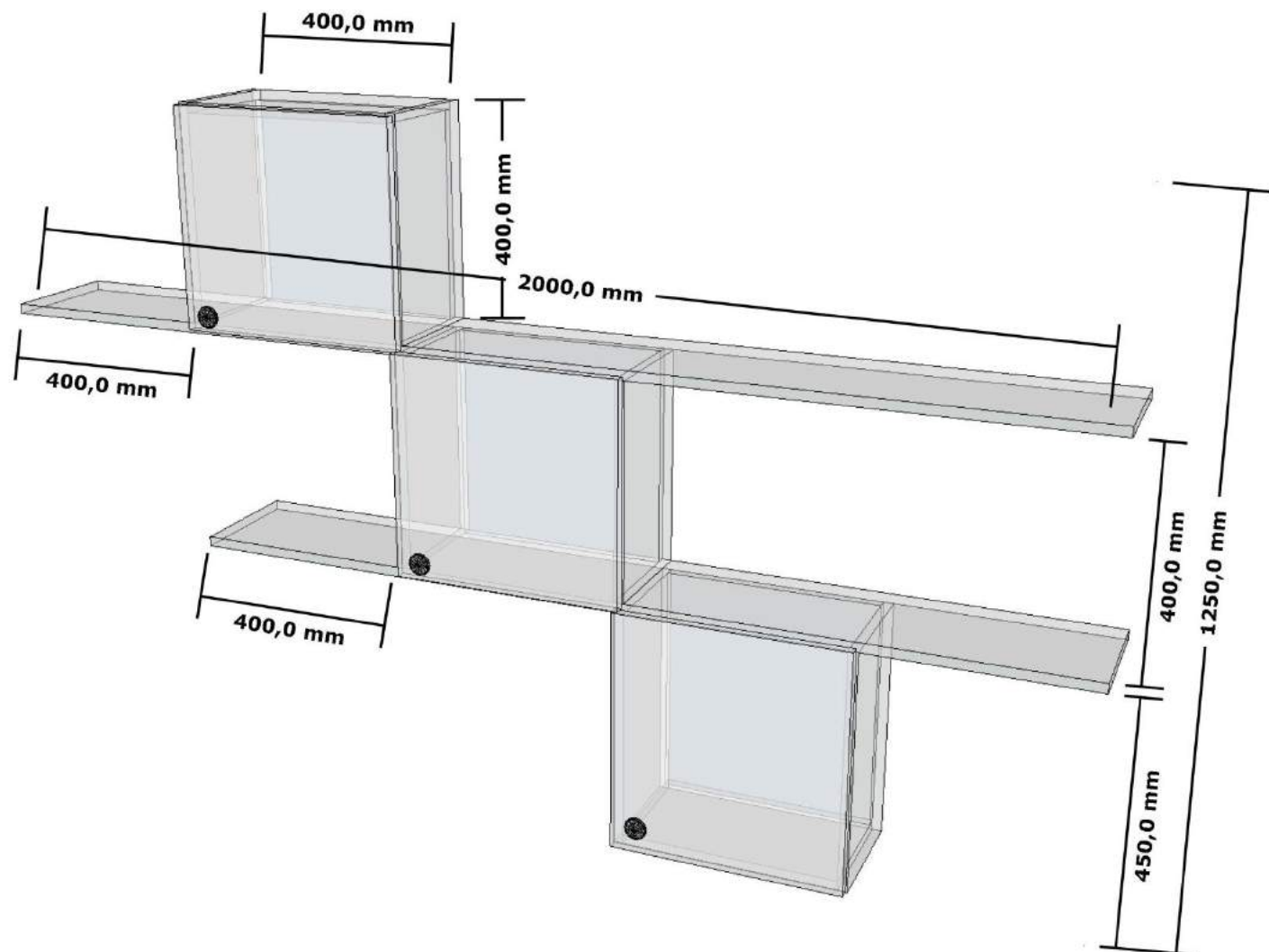

Num	Material	Referencia	Cantidad	Altura (mm)	Anchura (mm)	Espesor (mm)
1	MELA_BL, 18.00	Estante Fijo [1]	1	1672.00	229.00	18.00
2	MELA_BL, 18.00	Estante Fijo [2]	1	2072.00	229.00	18.00
3	MELA_BL, 18.00	Estante Fijo [3]	1	400.00	229.00	18.00
4	MELA_BL, 18.00	División Libre 1 [1]	1	400.00	229.00	18.00
5	MELA_BL, 18.00	División Libre 1 [2]	1	432.00	400.00	18.00
6	MELA_BL, 18.00	División Libre 1 [3]	1	400.00	400.00	18.00
7	MELA_BL, 18.00	División Libre 1 [4]	1	400.00	382.00	18.00
8	MELA_BL, 18.00	División Vertical [1]	1	450.00	229.00	18.00
9	MELA_BL, 18.00	División Vertical [2]	1	450.00	229.00	18.00
10	MELA_BL, 18.00	División Vertical [3]	1	400.00	229.00	18.00
11	MELA_BL, 18.00	División Vertical [4]	1	400.00	229.00	18.00
12	MELA_BL, 18.00	División Vertical [5]	1	400.00	229.00	18.00
13	MELA_BL, 18.00	División Vertical [6]	1	400.00	229.00	18.00
14	MELA_BL, 18.00	Puerta 1 (unica) [1]	1	404.50	430.00	18.00
15	MELA_BL, 18.00	Puerta 1 (unica) [2]	1	415.00	430.00	18.00
16	MELA_BL, 18.00	Puerta 1 (unica) [3]	1	454.50	430.00	18.00



# Mueble Moderno #25

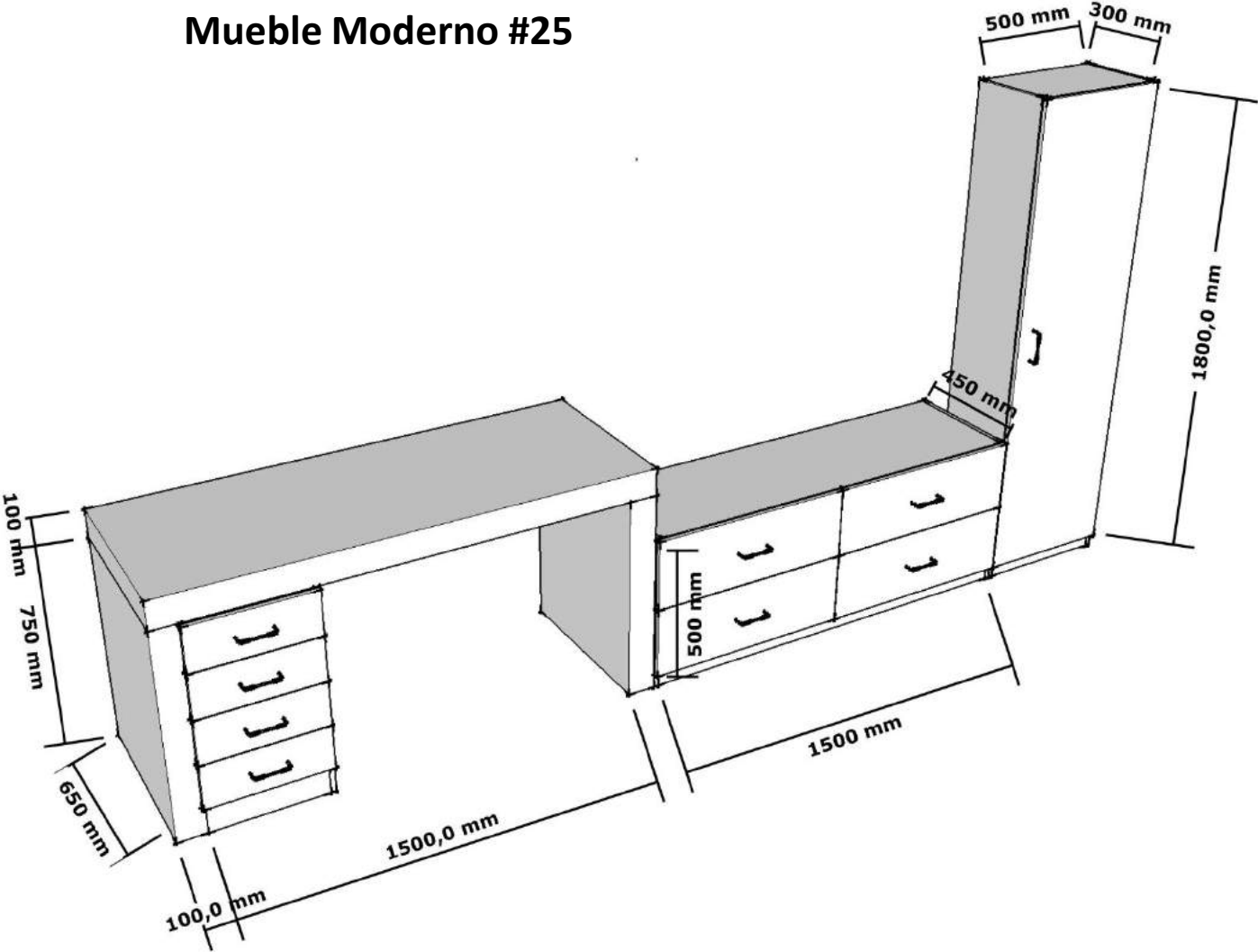

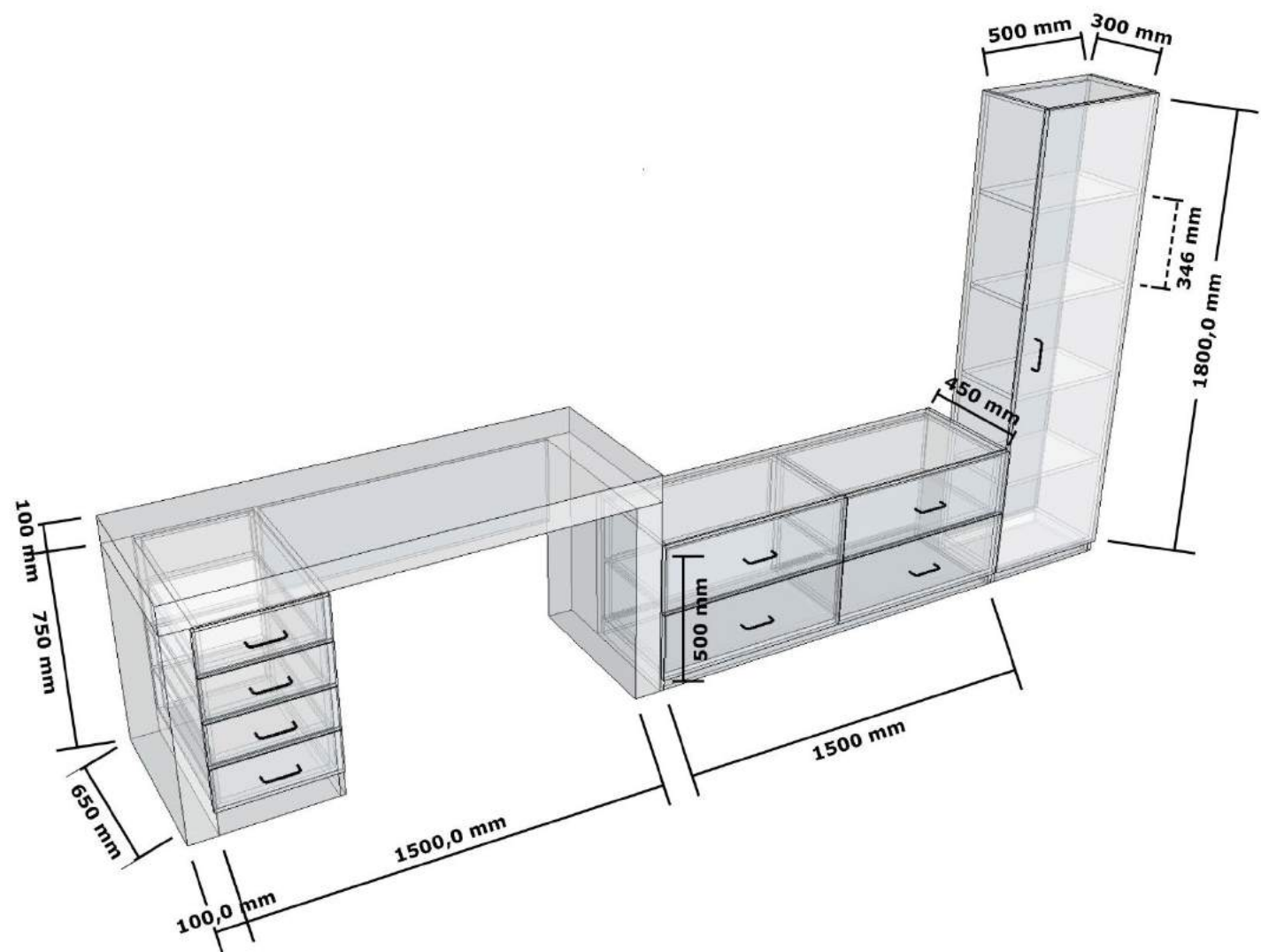

Num	Material	Referencia	Cantidad	Altura (mm)	Anchura (mm)	Espesor (mm)
1	Mela_BL 100MM, 100.00	Techo	1	1700.00	647.00	100.00
2	Mela_BL 100MM, 100.00	Lateral Derecho	1	750.00	647.00	100.00
3	Mela_BL 100MM, 100.00	Lateral Izquierdo	1	750.00	647.00	100.00
4	Mela_BL 100MM, 100.00	División Libre 1 [1]	1	647.00	400.00	100.00
5	MELA_BL, 18.00	División Libre 1 [2]	1	650.00	400.00	18.00
6	MELA_BL, 18.00	División Libre 1 [3]	1	1082.00	330.00	18.00
7	MELA_BL, 18.00	División Vertical [1]	1	750.00	647.00	18.00
8	MELA_BL, 18.00	Cajón 1 [1]_1	1	158.75	425.00	18.00
9	MELA_BL, 18.00	Cajón 1 [1]_2	1	158.75	425.00	18.00
10	MELA_BL, 18.00	Cajón 1 [1]_3	1	158.75	425.00	18.00
11	MELA_BL, 18.00	Cajón 1 [1]_4	1	158.75	425.00	18.00
12	MELA_BL, 18.00	Lateral Der Cajón 1 [1]_1	1	610.00	153.75	18.00
13	MELA_BL, 18.00	Lateral Der Cajón 1 [1]_2	1	610.00	150.75	18.00
14	MELA_BL, 18.00	Lateral Der Cajón 1 [1]_3	1	610.00	150.75	18.00
15	MELA_BL, 18.00	Lateral Der Cajón 1 [1]_4	1	610.00	153.75	18.00
16	MELA_BL, 18.00	Lateral Izq Cajón 1 [1]_1	1	610.00	153.75	18.00
17	MELA_BL, 18.00	Lateral Izq Cajón 1 [1]_2	1	610.00	150.75	18.00
18	MELA_BL, 18.00	Lateral Izq Cajón 1 [1]_3	1	610.00	150.75	18.00
19	MELA_BL, 18.00	Lateral Izq Cajón 1 [1]_4	1	610.00	153.75	18.00
20	MELA_BL, 18.00	Fondo Cajón 1 [1]_1	1	592.00	358.00	18.00
21	MELA_BL, 18.00	Fondo Cajón 1 [1]_2	1	592.00	358.00	18.00
22	MELA_BL, 18.00	Fondo Cajón 1 [1]_3	1	592.00	358.00	18.00
23	MELA_BL, 18.00	Fondo Cajón 1 [1]_4	1	592.00	358.00	18.00
24	MELA_BL, 18.00	Trasera Cajón 1 [1]_1	1	358.00	153.75	18.00
25	MELA_BL, 18.00	Trasera Cajón 1 [1]_2	1	358.00	150.75	18.00
26	MELA_BL, 18.00	Trasera Cajón 1 [1]_3	1	358.00	150.75	18.00
27	MELA_BL, 18.00	Trasera Cajón 1 [1]_4	1	358.00	153.75	18.00
28	MELA_BL, 18.00	Contra-Frente Cajón 1 [1]_1	1	394.00	153.75	18.00
29	MELA_BL, 18.00	Contra-Frente Cajón 1 [1]_2	1	394.00	150.75	18.00
30	MELA_BL, 18.00	Contra-Frente Cajón 1 [1]_3	1	394.00	150.75	18.00
31	MELA_BL, 18.00	Contra-Frente Cajón 1 [1]_4	1	394.00	153.75	18.00

Num	Material	Referencia	Cantidad	Altura (mm)	Anchura (mm)	Espesor (mm)
1	MELA_BL, 18.00	Techo	1	1500.00	447.00	18.00
2	MELA_BL, 18.00	Suelo	1	1500.00	447.00	18.00
3	MELA_BL, 18.00	Lateral Derecho	1	586.00	447.00	18.00
4	MELA_BL, 18.00	Lateral Izquierdo	1	586.00	447.00	18.00
5	MELA_BL, 18.00	Trasera	1	500.00	1500.00	18.00
6	MELA_BL, 18.00	División Vertical [1]	1	500.00	429.00	18.00
7	MELA_BL, 18.00	Cajón 1 [1]_1	1	263.50	763.50	18.00
8	MELA_BL, 18.00	Cajón 1 [1]_2	1	263.50	763.50	18.00
9	MELA_BL, 18.00	Cajón 1 [2]_1	1	263.50	763.50	18.00
10	MELA_BL, 18.00	Cajón 1 [2]_2	1	263.50	763.50	18.00
11	MELA_BL, 18.00	Lateral Der Cajón 1 [1]_1	1	410.00	240.50	18.00
12	MELA_BL, 18.00	Lateral Der Cajón 1 [1]_2	1	410.00	240.50	18.00
13	MELA_BL, 18.00	Lateral Der Cajón 1 [2]_1	1	410.00	240.50	18.00
14	MELA_BL, 18.00	Lateral Der Cajón 1 [2]_2	1	410.00	240.50	18.00
15	MELA_BL, 18.00	Lateral Izq Cajón 1 [1]_1	1	410.00	240.50	18.00
16	MELA_BL, 18.00	Lateral Izq Cajón 1 [1]_2	1	410.00	240.50	18.00
17	MELA_BL, 18.00	Lateral Izq Cajón 1 [2]_1	1	410.00	240.50	18.00
18	MELA_BL, 18.00	Lateral Izq Cajón 1 [2]_2	1	410.00	240.50	18.00
19	MELA_BL, 18.00	Fondo Cajón 1 [1]_1	1	699.00	392.00	18.00
20	MELA_BL, 18.00	Fondo Cajón 1 [1]_2	1	699.00	392.00	18.00
21	MELA_BL, 18.00	Fondo Cajón 1 [2]_1	1	699.00	392.00	18.00
22	MELA_BL, 18.00	Fondo Cajón 1 [2]_2	1	699.00	392.00	18.00
23	MELA_BL, 18.00	Trasera Cajón 1 [1]_1	1	699.00	240.50	18.00
24	MELA_BL, 18.00	Trasera Cajón 1 [1]_2	1	699.00	240.50	18.00
25	MELA_BL, 18.00	Trasera Cajón 1 [2]_1	1	699.00	240.50	18.00
26	MELA_BL, 18.00	Trasera Cajón 1 [2]_2	1	699.00	240.50	18.00
27	MELA_BL, 18.00	Contra-Frente Cajón 1 [1]_1	1	735.00	240.50	18.00
28	MELA_BL, 18.00	Contra-Frente Cajón 1 [1]_2	1	735.00	240.50	18.00
29	MELA_BL, 18.00	Contra-Frente Cajón 1 [2]_1	1	735.00	240.50	18.00
30	MELA_BL, 18.00	Contra-Frente Cajón 1 [2]_2	1	735.00	240.50	18.00
31	MELA_BL, 18.00	Zócalo 1 [1]	1	1500.00	50.00	18.00
32	MELA_BL, 18.00	Zócalo 1 [2]	1	1500.00	50.00	18.00

Num	Material	Referencia	Cantidad	Altura (mm)	Anchura (mm)	Espesor (mm)
1	MELA_BL, 18.00	Techo	1	500.00	318.00	18.00
2	MELA_BL, 18.00	Suelo	1	500.00	318.00	18.00
3	MELA_BL, 18.00	Lateral Derecho	1	1886.00	318.00	18.00
4	MELA_BL, 18.00	Lateral Izquierdo	1	1886.00	318.00	18.00
5	MELA_BL, 18.00	Trasera	1	1800.00	500.00	18.00
6	MELA_BL, 18.00	Estante Fijo [1]	1	500.00	300.00	18.00
7	MELA_BL, 18.00	Estante Fijo [2]	1	500.00	300.00	18.00
8	MELA_BL, 18.00	Estante Fijo [3]	1	500.00	300.00	18.00
9	MELA_BL, 18.00	Estante Fijo [4]	1	500.00	300.00	18.00
10	MELA_BL, 18.00	Puerta 1 (unica) [1]	1	1830.00	530.00	18.00
11	MELA_BL, 18.00	Zócalo 1 [1]	1	500.00	50.00	18.00
12	MELA_BL, 18.00	Zócalo 1 [2]	1	500.00	50.00	18.00

# Mueble Moderno #26

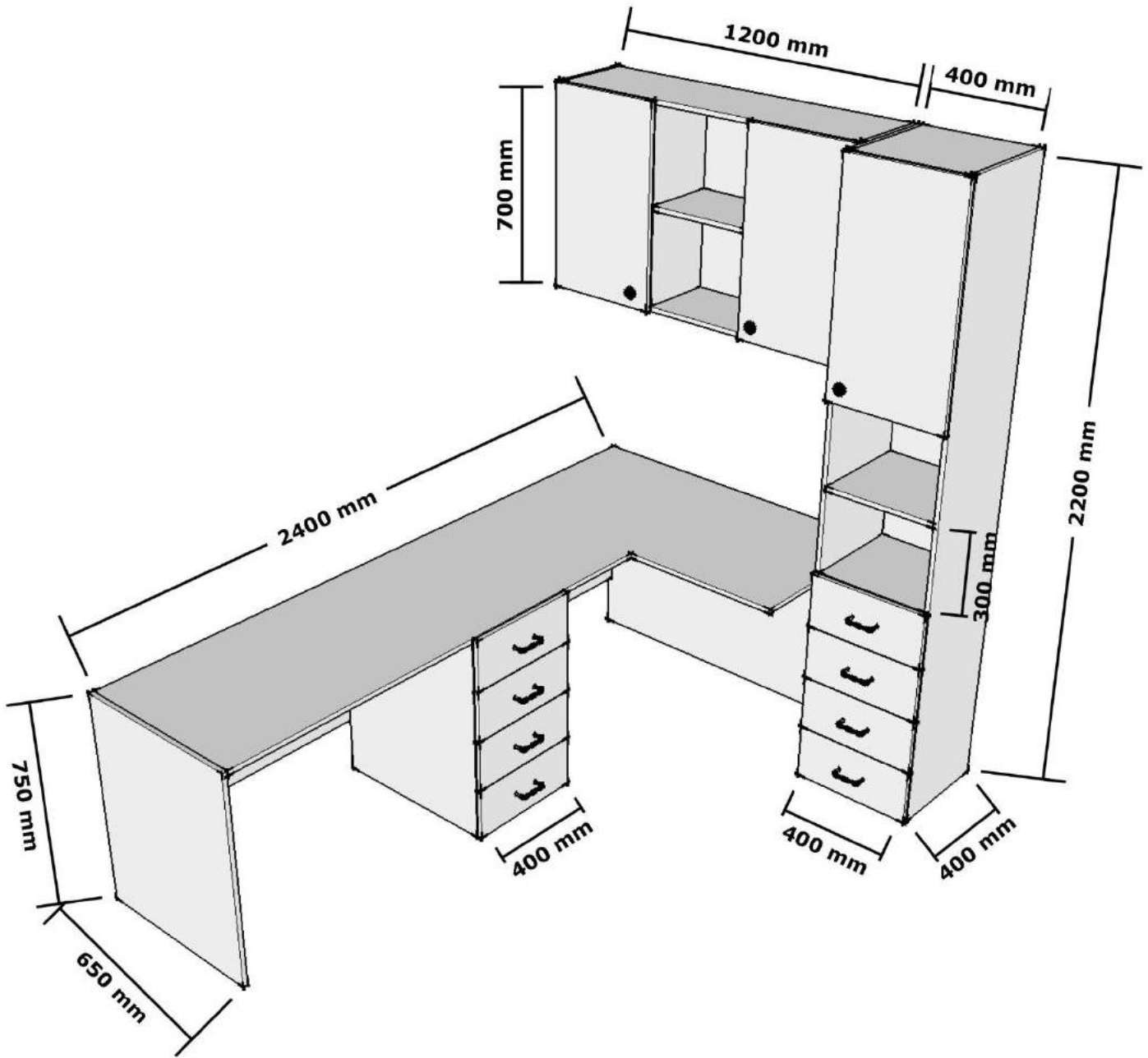

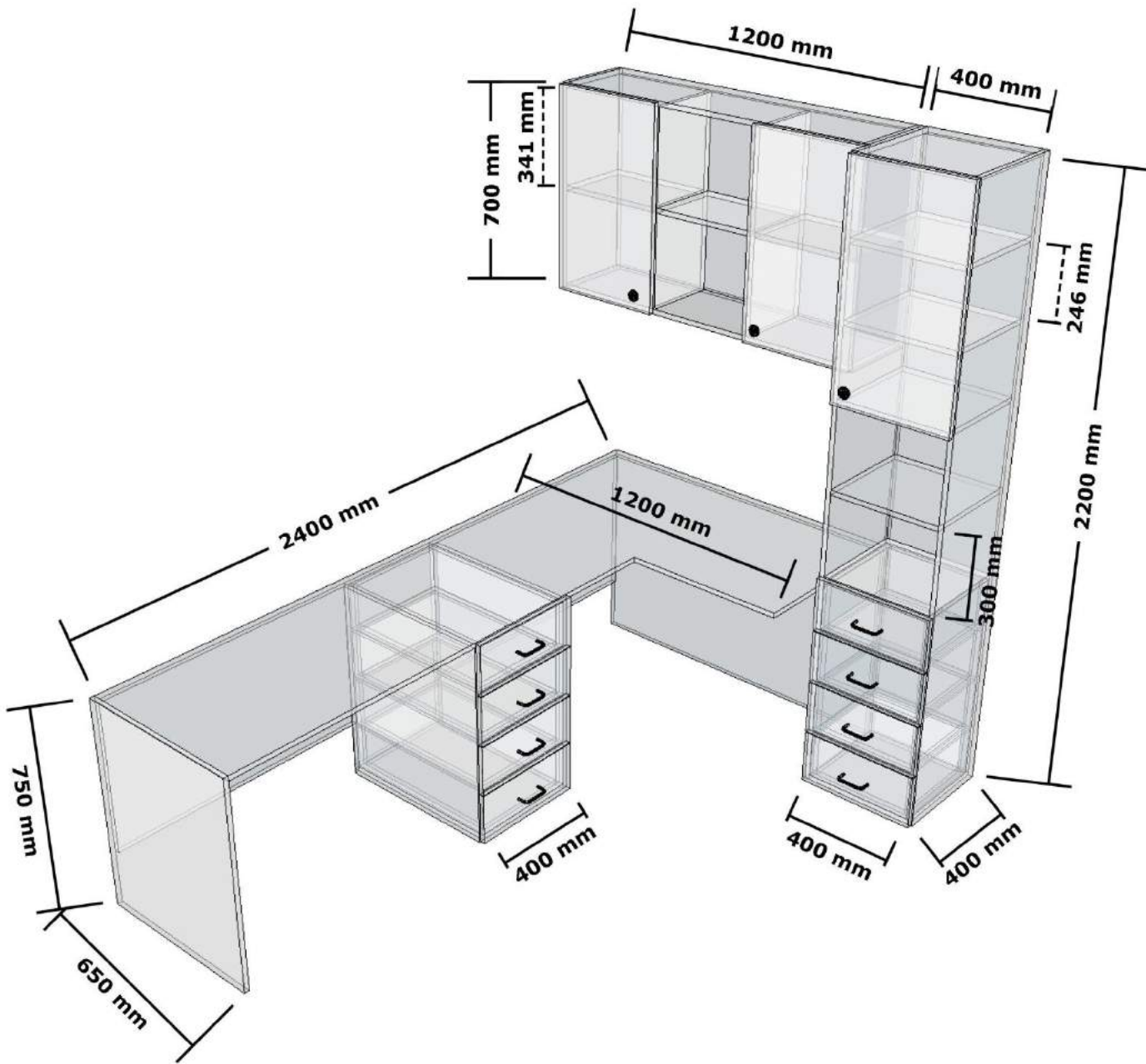

Num	Material	Referencia	Cantidad	Altura (mm)	Anchura (mm)	Espesor (mm)
1	MELA_BL, 18.00	Techo	1	2418.00	1218.00	18.00
2	MELA_BL, 18.00	Lateral Izquierdo	1	768.00	629.00	18.00
3	MELA_BL, 18.00	Trasera Derecha	1	750.00	1218.00	18.00
4	MELA_BL, 18.00	División Libre 1 [1]	1	629.00	400.00	18.00
5	MELA_BL, 18.00	División Libre 1 [2]	1	732.00	400.00	18.00
6	MELA_BL, 18.00	División Libre 1 [3]	1	1000.00	550.00	18.00
7	MELA_BL, 18.00	División Libre 1 [4]	1	1000.00	550.00	18.00
8	MELA_BL, 18.00	División Vertical [1]	1	750.00	611.00	18.00
9	MELA_BL, 18.00	División Vertical [2]	1	750.00	611.00	18.00
10	MELA_BL, 18.00	Cajón 1 [1]_1	1	188.25	430.00	18.00
11	MELA_BL, 18.00	Cajón 1 [1]_2	1	188.25	430.00	18.00
12	MELA_BL, 18.00	Cajón 1 [1]_3	1	188.25	430.00	18.00
13	MELA_BL, 18.00	Cajón 1 [1]_4	1	188.25	430.00	18.00
14	MELA_BL, 18.00	Lateral Der Cajón 1 [1]_1	1	592.00	165.25	18.00
15	MELA_BL, 18.00	Lateral Der Cajón 1 [1]_2	1	592.00	180.25	18.00
16	MELA_BL, 18.00	Lateral Der Cajón 1 [1]_3	1	592.00	180.25	18.00
17	MELA_BL, 18.00	Lateral Der Cajón 1 [1]_4	1	592.00	165.25	18.00
18	MELA_BL, 18.00	Lateral Izq Cajón 1 [1]_1	1	592.00	165.25	18.00
19	MELA_BL, 18.00	Lateral Izq Cajón 1 [1]_2	1	592.00	180.25	18.00
20	MELA_BL, 18.00	Lateral Izq Cajón 1 [1]_3	1	592.00	180.25	18.00
21	MELA_BL, 18.00	Lateral Izq Cajón 1 [1]_4	1	592.00	165.25	18.00
22	MELA_BL, 18.00	Fondo Cajón 1 [1]_1	1	574.00	358.00	18.00
23	MELA_BL, 18.00	Fondo Cajón 1 [1]_2	1	574.00	358.00	18.00
24	MELA_BL, 18.00	Fondo Cajón 1 [1]_3	1	574.00	358.00	18.00
25	MELA_BL, 18.00	Fondo Cajón 1 [1]_4	1	574.00	358.00	18.00
26	MELA_BL, 18.00	Trasera Cajón 1 [1]_1	1	358.00	165.25	18.00
27	MELA_BL, 18.00	Trasera Cajón 1 [1]_2	1	358.00	180.25	18.00
28	MELA_BL, 18.00	Trasera Cajón 1 [1]_3	1	358.00	180.25	18.00
29	MELA_BL, 18.00	Trasera Cajón 1 [1]_4	1	358.00	165.25	18.00
30	MELA_BL, 18.00	Contra-Frente Cajón 1 [1]_1	1	394.00	165.25	18.00
31	MELA_BL, 18.00	Contra-Frente Cajón 1 [1]_2	1	394.00	180.25	18.00
32	MELA_BL, 18.00	Contra-Frente Cajón 1 [1]_3	1	394.00	180.25	18.00
33	MELA_BL, 18.00	Contra-Frente Cajón 1 [1]_4	1	394.00	165.25	18.00

Num	Material	Referencia	Cantidad	Altura (mm)	Anchura (mm)	Espesor (mm)
1	MELA_BL, 18.00	Techo	1	400.00	397.00	18.00
2	MELA_BL, 18.00	Suelo	1	400.00	397.00	18.00
3	MELA_BL, 18.00	Lateral Derecho	1	2236.00	397.00	18.00
4	MELA_BL, 18.00	Lateral Izquierdo	1	2236.00	397.00	18.00
5	MELA_BL, 18.00	Trasera	1	2200.00	400.00	18.00
6	MELA_BL, 18.00	Estante Fijo [1]	1	400.00	379.00	18.00
7	MELA_BL, 18.00	Estante Fijo [2]	1	400.00	379.00	18.00
8	MELA_BL, 18.00	Estante Fijo [3]	1	400.00	379.00	18.00
9	MELA_BL, 18.00	Estante Fijo [4]	1	400.00	379.00	18.00
10	MELA_BL, 18.00	Estante Fijo [5]	1	400.00	379.00	18.00
11	MELA_BL, 18.00	Puerta 1 (unica) [1]	1	803.00	430.00	18.00
12	MELA_BL, 18.00	Cajón 1 [1]_1	1	198.50	430.00	18.00
13	MELA_BL, 18.00	Cajón 1 [1]_2	1	198.50	430.00	18.00
14	MELA_BL, 18.00	Cajón 1 [1]_3	1	198.50	430.00	18.00
15	MELA_BL, 18.00	Cajón 1 [1]_4	1	198.50	430.00	18.00
16	MELA_BL, 18.00	Lateral Der Cajón 1 [1]_1	1	360.00	175.50	18.00
17	MELA_BL, 18.00	Lateral Der Cajón 1 [1]_2	1	360.00	190.50	18.00
18	MELA_BL, 18.00	Lateral Der Cajón 1 [1]_3	1	360.00	190.50	18.00
19	MELA_BL, 18.00	Lateral Der Cajón 1 [1]_4	1	360.00	175.50	18.00
20	MELA_BL, 18.00	Lateral Izq Cajón 1 [1]_1	1	360.00	175.50	18.00
21	MELA_BL, 18.00	Lateral Izq Cajón 1 [1]_2	1	360.00	190.50	18.00
22	MELA_BL, 18.00	Lateral Izq Cajón 1 [1]_3	1	360.00	190.50	18.00
23	MELA_BL, 18.00	Lateral Izq Cajón 1 [1]_4	1	360.00	175.50	18.00
24	MELA_BL, 18.00	Fondo Cajón 1 [1]_1	1	358.00	342.00	18.00
25	MELA_BL, 18.00	Fondo Cajón 1 [1]_2	1	358.00	342.00	18.00
26	MELA_BL, 18.00	Fondo Cajón 1 [1]_3	1	358.00	342.00	18.00
27	MELA_BL, 18.00	Fondo Cajón 1 [1]_4	1	358.00	342.00	18.00
28	MELA_BL, 18.00	Trasera Cajón 1 [1]_1	1	358.00	175.50	18.00
29	MELA_BL, 18.00	Trasera Cajón 1 [1]_2	1	358.00	190.50	18.00
30	MELA_BL, 18.00	Trasera Cajón 1 [1]_3	1	358.00	190.50	18.00
31	MELA_BL, 18.00	Trasera Cajón 1 [1]_4	1	358.00	175.50	18.00
32	MELA_BL, 18.00	Contra-Frente Cajón 1 [1]_1	1	394.00	175.50	18.00
33	MELA_BL, 18.00	Contra-Frente Cajón 1 [1]_2	1	394.00	190.50	18.00
34	MELA_BL, 18.00	Contra-Frente Cajón 1 [1]_3	1	394.00	190.50	18.00
35	MELA_BL, 18.00	Contra-Frente Cajón 1 [1]_4	1	394.00	175.50	18.00

Num	Material	Referencia	Cantidad	Altura (mm)	Anchura (mm)	Espesor (mm)
1	MELA_BL, 18.00	Techo	1	1200.00	297.00	18.00
2	MELA_BL, 18.00	Suelo	1	1200.00	297.00	18.00
3	MELA_BL, 18.00	Lateral Derecho	1	736.00	297.00	18.00
4	MELA_BL, 18.00	Lateral Izquierdo	1	736.00	297.00	18.00
5	MELA_BL, 18.00	Trasera	1	700.00	1200.00	18.00
6	MELA_BL, 18.00	Estante Fijo [1]	1	388.00	279.00	18.00
7	MELA_BL, 18.00	Estante Fijo [2]	1	388.00	279.00	18.00
8	MELA_BL, 18.00	Estante Fijo [3]	1	388.00	279.00	18.00
9	MELA_BL, 18.00	División Vertical [1]	1	700.00	279.00	18.00
10	MELA_BL, 18.00	División Vertical [2]	1	700.00	279.00	18.00
11	MELA_BL, 18.00	Puerta 1 (unica) [1]	1	730.00	418.00	18.00
12	MELA_BL, 18.00	Puerta 1 (unica) [2]	1	730.00	418.00	18.00



# Mueble Moderno #27

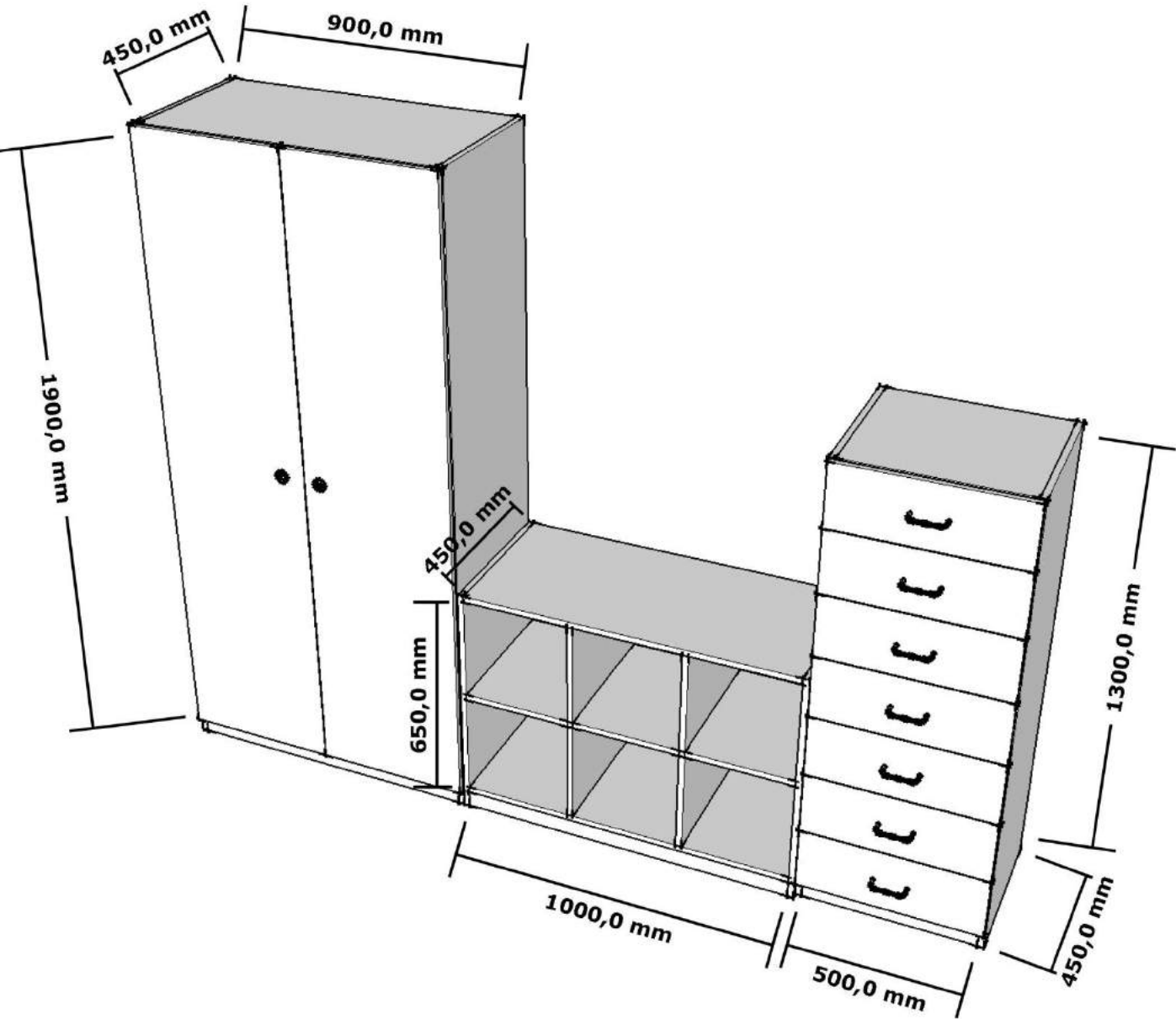

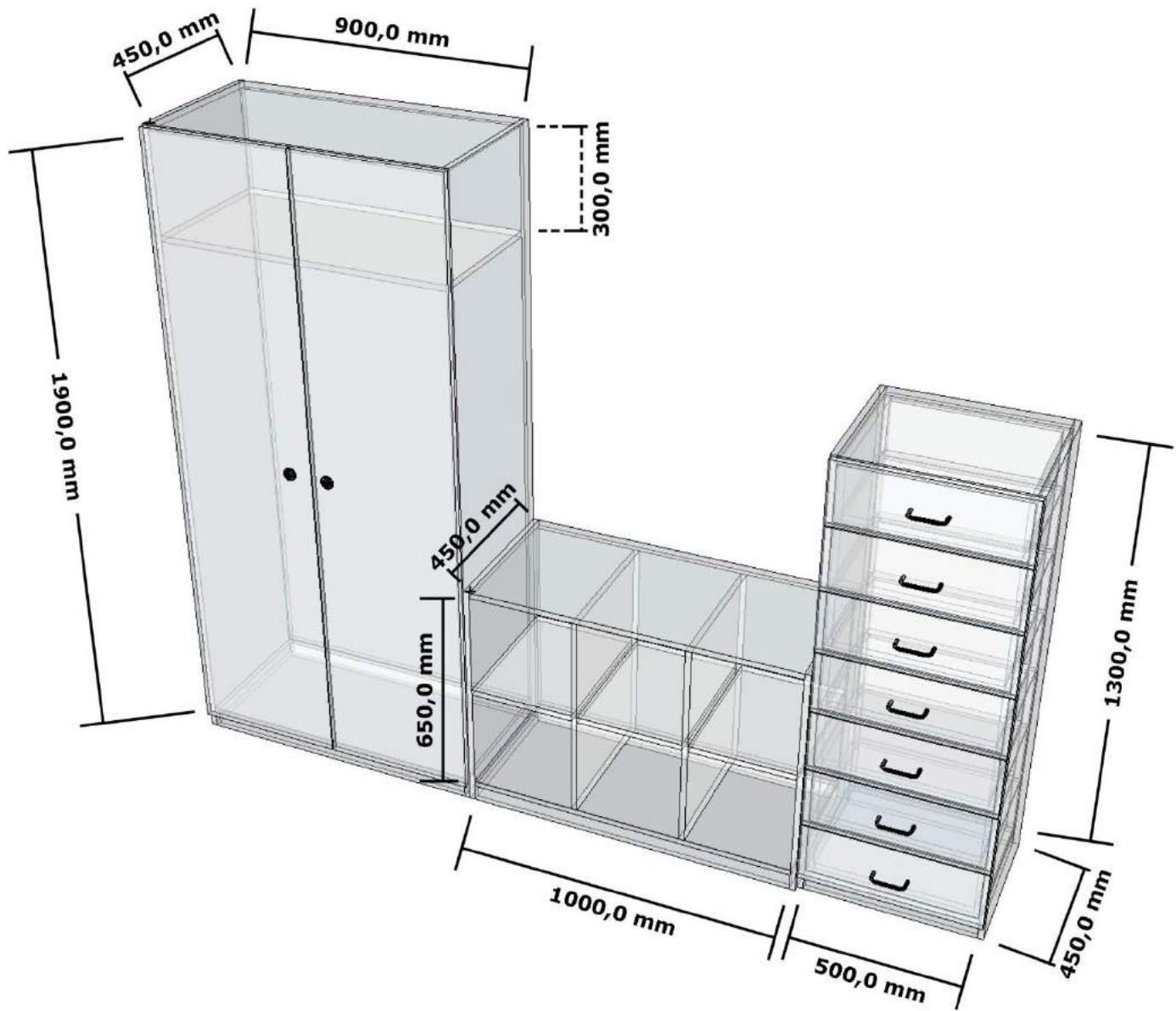

Num	Material	Referencia	Cantidad	Altura (mm)	Anchura (mm)	Espesor (mm)
1	MELA_BL, 18.00	Techo	1	900.00	468.00	18.00
2	MELA_BL, 18.00	Suelo	1	900.00	468.00	18.00
3	MELA_BL, 18.00	Lateral Derecho	1	1986.00	468.00	18.00
4	MELA_BL, 18.00	Lateral Izquierdo	1	1986.00	468.00	18.00
5	MELA_BL, 18.00	Trasera	1	1900.00	900.00	18.00
6	MELA_BL, 18.00	Estante Fijo [1]	1	900.00	450.00	18.00
7	MELA_BL, 18.00	Puerta 1 (doble) [1]_1	1	1930.00	463.50	18.00
8	MELA_BL, 18.00	Puerta 1 (doble) [1]_2	1	1930.00	463.50	18.00
9	MELA_BL, 18.00	Zócalo 1 [1]	1	900.00	50.00	18.00
10	MELA_BL, 18.00	Zócalo 1 [2]	1	900.00	50.00	18.00

Num	Material	Referencia	Cantidad	Altura (mm)	Anchura (mm)	Espesor (mm)
1	MELA_BL, 18.00	Techo	1	1000.00	468.00	18.00
2	MELA_BL, 18.00	Suelo	1	1000.00	468.00	18.00
3	MELA_BL, 18.00	Lateral Derecho	1	736.00	468.00	18.00
4	MELA_BL, 18.00	Lateral Izquierdo	1	736.00	468.00	18.00
5	MELA_BL, 18.00	Trasera	1	650.00	1000.00	18.00
6	MELA_BL, 18.00	Estante Fijo [1]	1	321.33	450.00	18.00
7	MELA_BL, 18.00	Estante Fijo [2]	1	321.33	450.00	18.00
8	MELA_BL, 18.00	Estante Fijo [3]	1	321.33	450.00	18.00
9	MELA_BL, 18.00	División Vertical [1]	1	650.00	450.00	18.00
10	MELA_BL, 18.00	División Vertical [2]	1	650.00	450.00	18.00
11	MELA_BL, 18.00	Zócalo 1 [1]	1	1000.00	50.00	18.00
12	MELA_BL, 18.00	Zócalo 1 [2]	1	1000.00	50.00	18.00

Num	Material	Referencia	Cantidad	Altura (mm)	Anchura (mm)	Espesor (mm)
1	MELA_BL, 18.00	Techo	1	500.00	450.00	18.00
2	MELA_BL, 18.00	Suelo	1	500.00	450.00	18.00
3	MELA_BL, 18.00	Lateral Derecho	1	1386.00	450.00	18.00
4	MELA_BL, 18.00	Lateral Izquierdo	1	1386.00	450.00	18.00
5	MELA_BL, 18.00	Trasera	1	1300.00	500.00	18.00
6	MELA_BL, 18.00	Cajón 1 [1]_1	1	187.43	530.00	18.00
7	MELA_BL, 18.00	Cajón 1 [1]_2	1	187.43	530.00	18.00
8	MELA_BL, 18.00	Cajón 1 [1]_3	1	187.43	530.00	18.00
9	MELA_BL, 18.00	Cajón 1 [1]_4	1	187.43	530.00	18.00
10	MELA_BL, 18.00	Cajón 1 [1]_5	1	187.43	530.00	18.00
11	MELA_BL, 18.00	Cajón 1 [1]_6	1	187.43	530.00	18.00
12	MELA_BL, 18.00	Cajón 1 [1]_7	1	187.43	530.00	18.00
13	MELA_BL, 18.00	Lateral Der Cajón 1 [1]_1	1	413.00	164.43	18.00
14	MELA_BL, 18.00	Lateral Der Cajón 1 [1]_2	1	413.00	179.43	18.00
15	MELA_BL, 18.00	Lateral Der Cajón 1 [1]_3	1	413.00	179.43	18.00
16	MELA_BL, 18.00	Lateral Der Cajón 1 [1]_4	1	413.00	179.43	18.00
17	MELA_BL, 18.00	Lateral Der Cajón 1 [1]_5	1	413.00	179.43	18.00
18	MELA_BL, 18.00	Lateral Der Cajón 1 [1]_6	1	413.00	179.43	18.00
19	MELA_BL, 18.00	Lateral Der Cajón 1 [1]_7	1	413.00	164.43	18.00
20	MELA_BL, 18.00	Lateral Izq Cajón 1 [1]_1	1	413.00	164.43	18.00
21	MELA_BL, 18.00	Lateral Izq Cajón 1 [1]_2	1	413.00	179.43	18.00
22	MELA_BL, 18.00	Lateral Izq Cajón 1 [1]_3	1	413.00	179.43	18.00
23	MELA_BL, 18.00	Lateral Izq Cajón 1 [1]_4	1	413.00	179.43	18.00
24	MELA_BL, 18.00	Lateral Izq Cajón 1 [1]_5	1	413.00	179.43	18.00
25	MELA_BL, 18.00	Lateral Izq Cajón 1 [1]_6	1	413.00	179.43	18.00
26	MELA_BL, 18.00	Lateral Izq Cajón 1 [1]_7	1	413.00	164.43	18.00
27	MELA_BL, 18.00	Fondo Cajón 1 [1]_1	1	458.00	395.00	18.00
28	MELA_BL, 18.00	Fondo Cajón 1 [1]_2	1	458.00	395.00	18.00
29	MELA_BL, 18.00	Fondo Cajón 1 [1]_3	1	458.00	395.00	18.00
30	MELA_BL, 18.00	Fondo Cajón 1 [1]_4	1	458.00	395.00	18.00
31	MELA_BL, 18.00	Fondo Cajón 1 [1]_5	1	458.00	395.00	18.00
32	MELA_BL, 18.00	Fondo Cajón 1 [1]_6	1	458.00	395.00	18.00
33	MELA_BL, 18.00	Fondo Cajón 1 [1]_7	1	458.00	395.00	18.00
34	MELA_BL, 18.00	Trasera Cajón 1 [1]_1	1	458.00	164.43	18.00
35	MELA_BL, 18.00	Trasera Cajón 1 [1]_2	1	458.00	179.43	18.00
36	MELA_BL, 18.00	Trasera Cajón 1 [1]_3	1	458.00	179.43	18.00
37	MELA_BL, 18.00	Trasera Cajón 1 [1]_4	1	458.00	179.43	18.00
38	MELA_BL, 18.00	Trasera Cajón 1 [1]_5	1	458.00	179.43	18.00
39	MELA_BL, 18.00	Trasera Cajón 1 [1]_6	1	458.00	179.43	18.00
40	MELA_BL, 18.00	Trasera Cajón 1 [1]_7	1	458.00	164.43	18.00
41	MELA_BL, 18.00	Contra-Frente Cajón 1 [1]_1	1	494.00	164.43	18.00
42	MELA_BL, 18.00	Contra-Frente Cajón 1 [1]_2	1	494.00	179.43	18.00
43	MELA_BL, 18.00	Contra-Frente Cajón 1 [1]_3	1	494.00	179.43	18.00
44	MELA_BL, 18.00	Contra-Frente Cajón 1 [1]_4	1	494.00	179.43	18.00
45	MELA_BL, 18.00	Contra-Frente Cajón 1 [1]_5	1	494.00	179.43	18.00
46	MELA_BL, 18.00	Contra-Frente Cajón 1 [1]_6	1	494.00	179.43	18.00
47	MELA_BL, 18.00	Contra-Frente Cajón 1 [1]_7	1	494.00	164.43	18.00
48	MELA_BL, 18.00	Zócalo 1 [1]	1	500.00	50.00	18.00
49	MELA_BL, 18.00	Zócalo 1 [2]	1	500.00	50.00	18.00

# Mueble Moderno #28

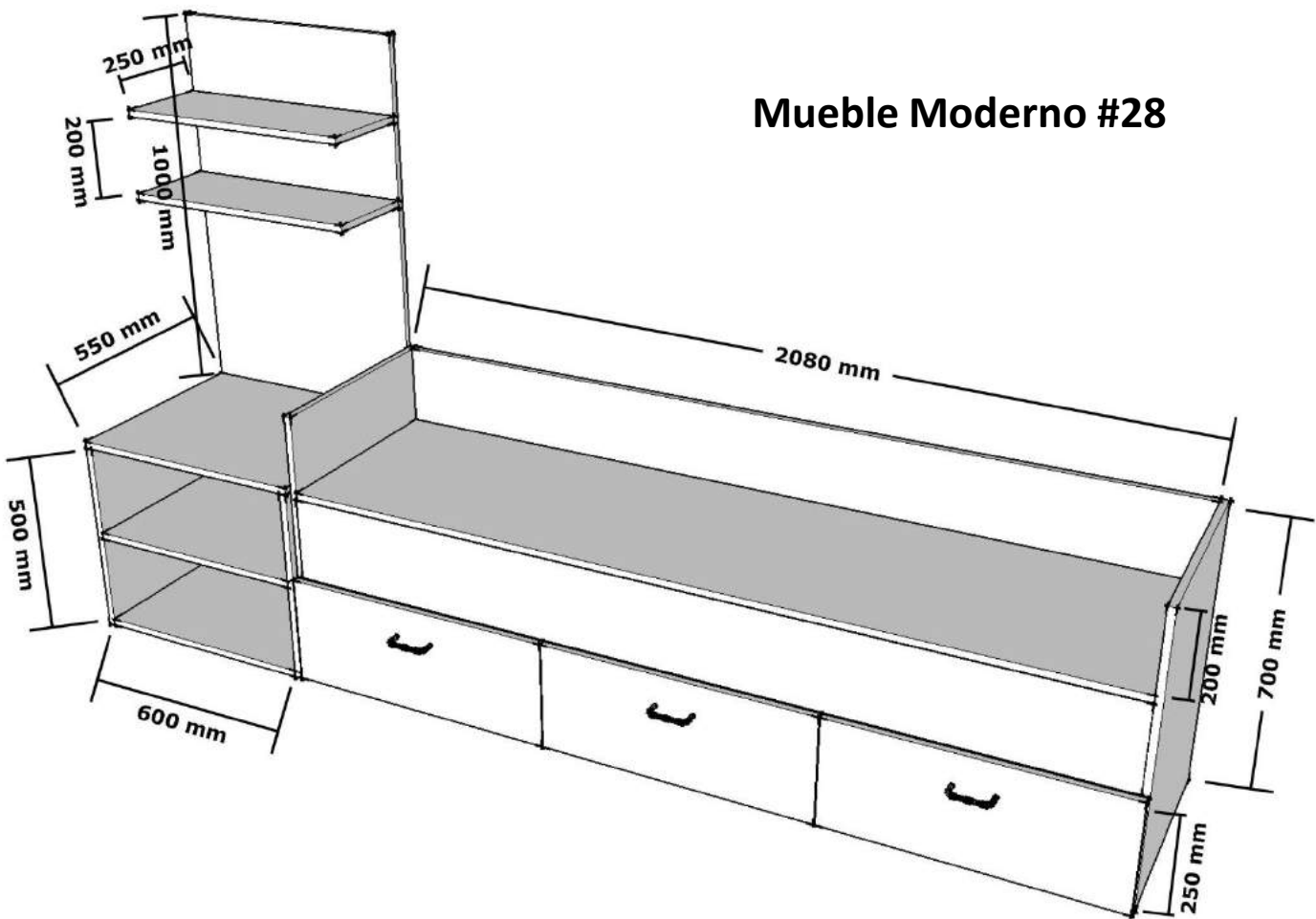

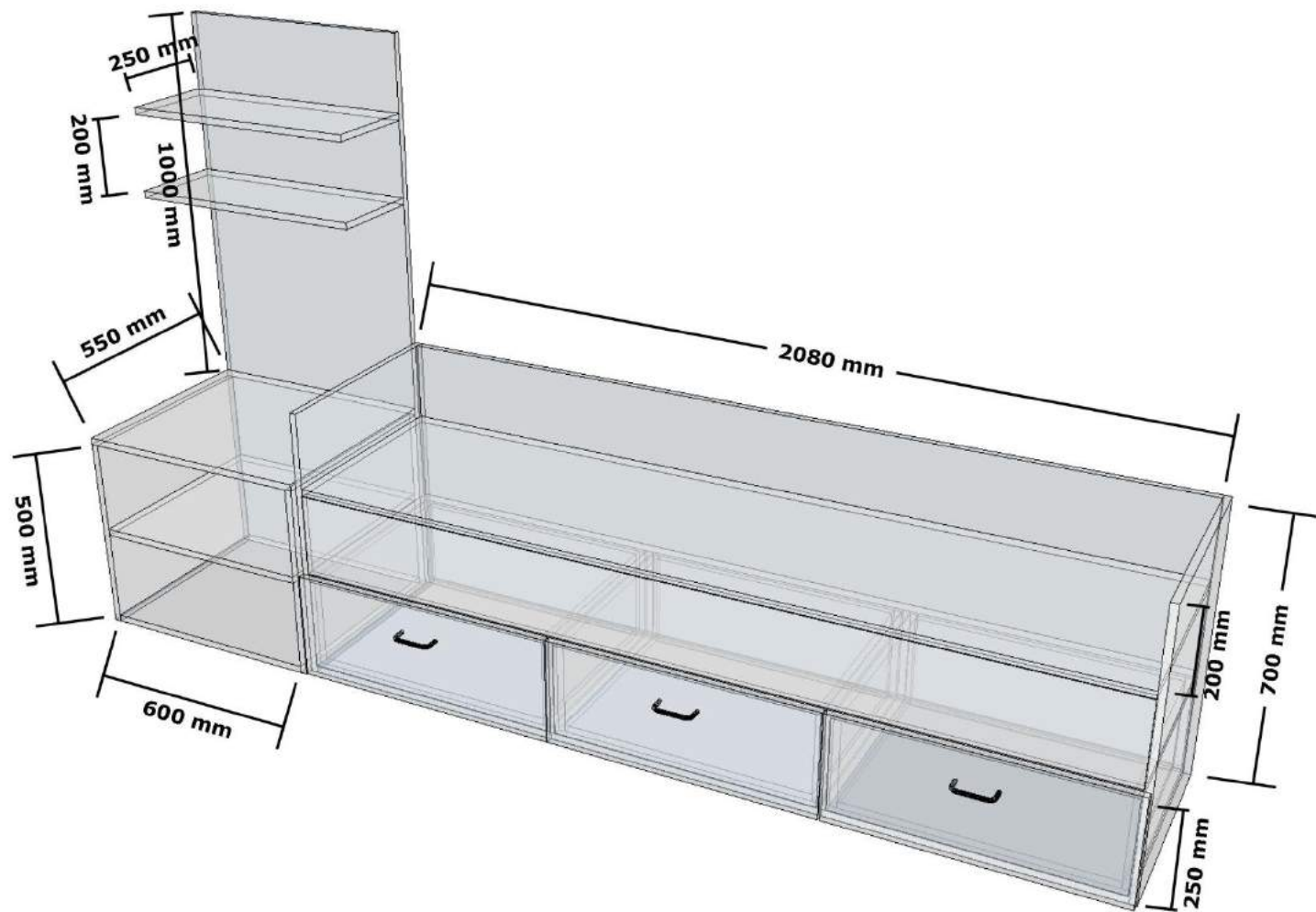

Num	Material	Referencia	Cantidad	Altura (mm)	Anchura (mm)	Espesor (mm)
1	MELA_BL, 18.00	Suelo	1	600.00	550.00	18.00
2	MELA_BL, 18.00	Trasera	1	1536.00	636.00	18.00
3	MELA_BL, 18.00	Estante Fijo [1]	1	636.00	550.00	18.00
4	MELA_BL, 18.00	Estante Fijo [2]	1	600.00	550.00	18.00
5	MELA_BL, 18.00	Estante Fijo [3]	1	636.00	250.00	18.00
6	MELA_BL, 18.00	Estante Fijo [4]	1	636.00	250.00	18.00
7	MELA_BL, 18.00	División Vertical [1]	1	518.00	550.00	18.00
8	MELA_BL, 18.00	División Vertical [2]	1	518.00	550.00	18.00

Num	Material	Referencia	Cantidad	Altura (mm)	Anchura (mm)	Espesor (mm)
1	MELA_BL, 18.00	Suelo	1	2080.00	547.00	18.00
2	MELA_BL, 18.00	Lateral Derecho	1	718.00	547.00	18.00
3	MELA_BL, 18.00	Lateral Izquierdo	1	718.00	547.00	18.00
4	MELA_BL, 18.00	Trasera	1	700.00	2080.00	18.00
5	MELA_BL, 18.00	Estante Fijo [1]	1	2080.00	529.00	18.00
6	MELA_BL, 18.00	Estante Fijo [2]	1	2080.00	529.00	18.00
7	MELA_BL, 18.00	División Libre 1 [1]	1	2080.00	214.00	18.00
8	MELA_BL, 18.00	División Vertical [1]	1	250.00	529.00	18.00
9	MELA_BL, 18.00	División Vertical [2]	1	250.00	529.00	18.00
10	MELA_BL, 18.00	Cajón 1 [1]	1	280.00	703.83	18.00
11	MELA_BL, 18.00	Cajón 1 [2]	1	280.00	696.33	18.00
12	MELA_BL, 18.00	Cajón 1 [3]	1	280.00	703.83	18.00
13	MELA_BL, 18.00	Lateral Der Cajón 1 [1]	1	510.00	242.00	18.00
14	MELA_BL, 18.00	Lateral Der Cajón 1 [2]	1	510.00	242.00	18.00
15	MELA_BL, 18.00	Lateral Der Cajón 1 [3]	1	510.00	242.00	18.00
16	MELA_BL, 18.00	Lateral Izq Cajón 1 [1]	1	510.00	242.00	18.00
17	MELA_BL, 18.00	Lateral Izq Cajón 1 [2]	1	510.00	242.00	18.00
18	MELA_BL, 18.00	Lateral Izq Cajón 1 [3]	1	510.00	242.00	18.00
19	MELA_BL, 18.00	Fondo Cajón 1 [1]	1	639.33	492.00	18.00
20	MELA_BL, 18.00	Fondo Cajón 1 [2]	1	639.33	492.00	18.00
21	MELA_BL, 18.00	Fondo Cajón 1 [3]	1	639.33	492.00	18.00
22	MELA_BL, 18.00	Trasera Cajón 1 [1]	1	639.33	242.00	18.00
23	MELA_BL, 18.00	Trasera Cajón 1 [2]	1	639.33	242.00	18.00
24	MELA_BL, 18.00	Trasera Cajón 1 [3]	1	639.33	242.00	18.00
25	MELA_BL, 18.00	Contra-Frente Cajón 1 [1]	1	675.33	242.00	18.00
26	MELA_BL, 18.00	Contra-Frente Cajón 1 [2]	1	675.33	242.00	18.00
27	MELA_BL, 18.00	Contra-Frente Cajón 1 [3]	1	675.33	242.00	18.00

# Mueble Moderno #29

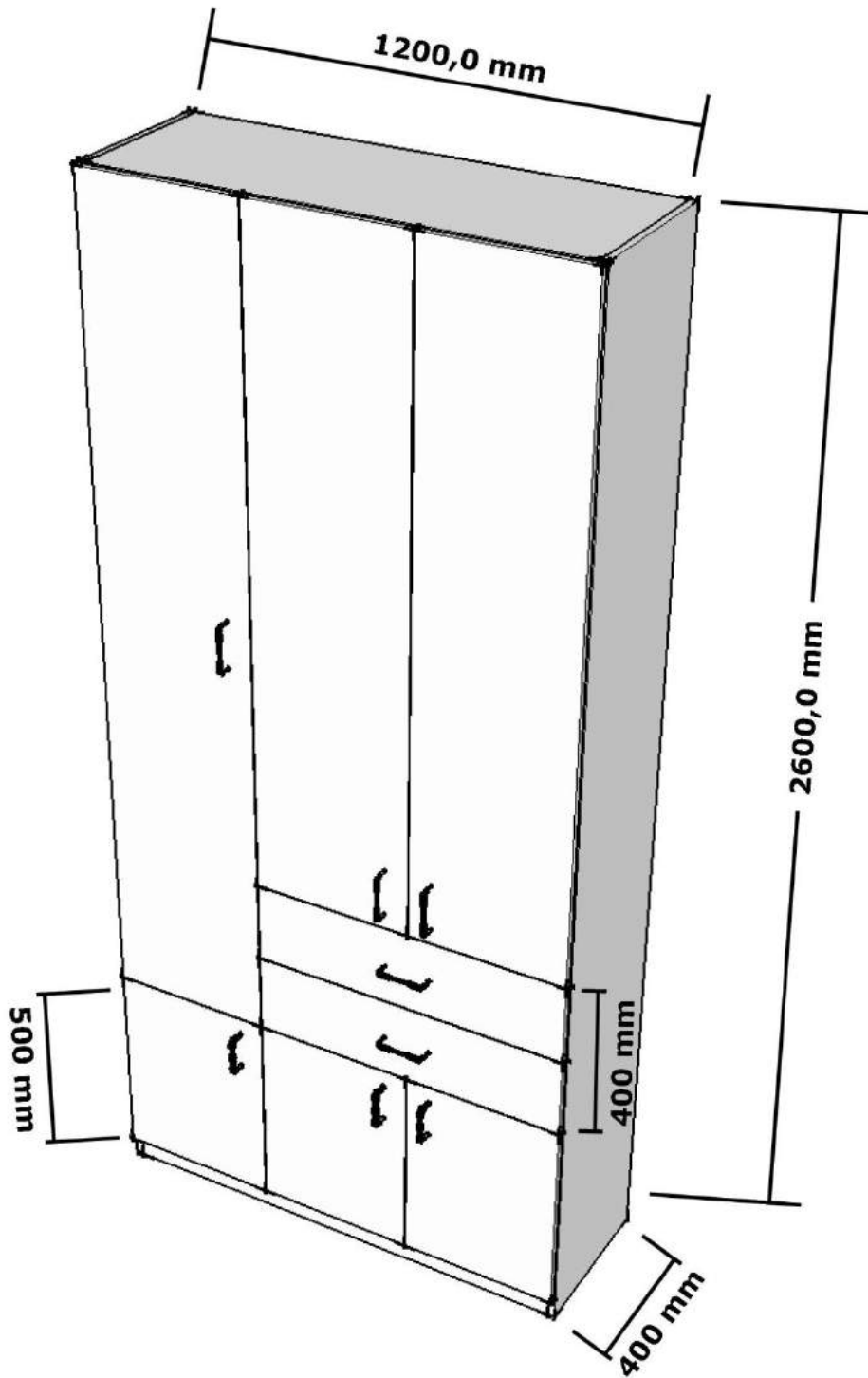



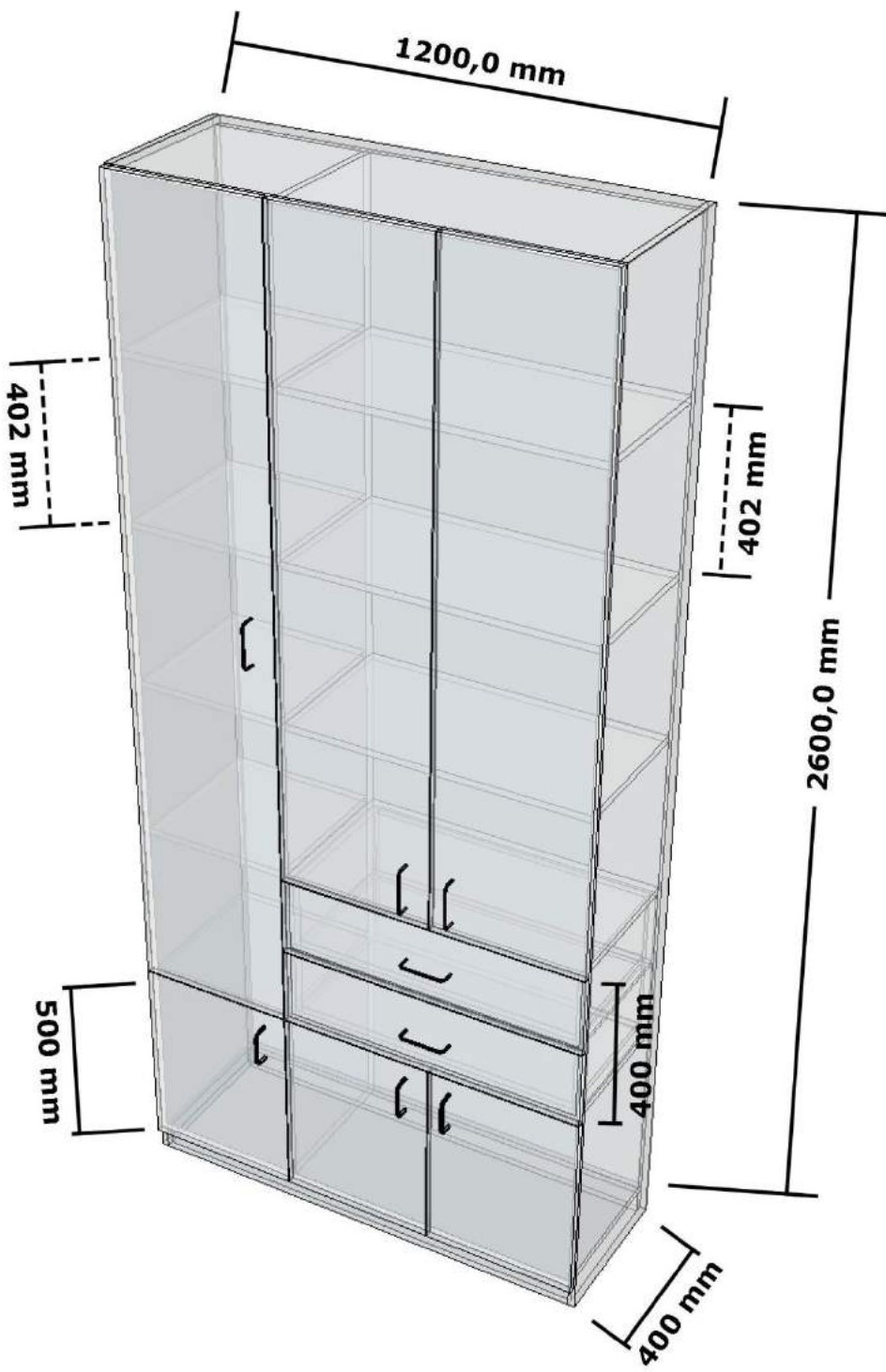

Num	Material	Referencia	Cantidad	Altura (mm)	Anchura (mm)	Espesor (mm)
1	MELA_BL, 18.00	Techo	1	1200.00	417.00	18.00
2	MELA_BL, 18.00	Suelo	1	1200.00	417.00	18.00
3	MELA_BL, 18.00	Lateral Derecho	1	2696.00	417.00	18.00
4	MELA_BL, 18.00	Lateral Izquierdo	1	2696.00	417.00	18.00
5	MELA_BL, 18.00	Trasera	1	2600.00	1200.00	18.00
6	MELA_BL, 18.00	Estante Fijo [1]	1	388.00	399.00	18.00
7	MELA_BL, 18.00	Estante Fijo [2]	1	388.00	399.00	18.00
8	MELA_BL, 18.00	Estante Fijo [3]	1	388.00	399.00	18.00
9	MELA_BL, 18.00	Estante Fijo [4]	1	388.00	399.00	18.00
10	MELA_BL, 18.00	Estante Fijo [5]	1	388.00	399.00	18.00
11	MELA_BL, 18.00	Estante Fijo [6]	1	794.00	399.00	18.00
12	MELA_BL, 18.00	Estante Fijo [7]	1	794.00	399.00	18.00
13	MELA_BL, 18.00	Estante Fijo [8]	1	794.00	399.00	18.00
14	MELA_BL, 18.00	Estante Fijo [9]	1	794.00	399.00	18.00
15	MELA_BL, 18.00	Estante Fijo [10]	1	794.00	399.00	18.00
16	MELA_BL, 18.00	División Vertical [1]	1	2600.00	399.00	18.00
17	MELA_BL, 18.00	Puerta 1 (unica) [1]	1	2104.50	410.50	18.00
18	MELA_BL, 18.00	Puerta 1 (unica) [2]	1	522.50	410.50	18.00
19	MELA_BL, 18.00	Puerta 1 (doble) [1]_1	1	522.50	406.75	18.00
20	MELA_BL, 18.00	Puerta 1 (doble) [1]_2	1	522.50	406.75	18.00
21	MELA_BL, 18.00	Puerta 1 (doble) [2]_1	1	1686.50	406.75	18.00
22	MELA_BL, 18.00	Puerta 1 (doble) [2]_2	1	1686.50	406.75	18.00
23	MELA_BL, 18.00	Cajón 1 [1]_1	1	206.00	816.50	18.00
24	MELA_BL, 18.00	Cajón 1 [1]_2	1	206.00	816.50	18.00
25	MELA_BL, 18.00	Lateral Der Cajón 1 [1]_1	1	380.00	190.50	18.00
26	MELA_BL, 18.00	Lateral Der Cajón 1 [1]_2	1	380.00	190.50	18.00
27	MELA_BL, 18.00	Lateral Izq Cajón 1 [1]_1	1	380.00	190.50	18.00
28	MELA_BL, 18.00	Lateral Izq Cajón 1 [1]_2	1	380.00	190.50	18.00
29	MELA_BL, 18.00	Fondo Cajón 1 [1]_1	1	752.00	362.00	18.00
30	MELA_BL, 18.00	Fondo Cajón 1 [1]_2	1	752.00	362.00	18.00
31	MELA_BL, 18.00	Trasera Cajón 1 [1]_1	1	752.00	190.50	18.00
32	MELA_BL, 18.00	Trasera Cajón 1 [1]_2	1	752.00	190.50	18.00
33	MELA_BL, 18.00	Contra-Frente Cajón 1 [1]_1	1	788.00	190.50	18.00
34	MELA_BL, 18.00	Contra-Frente Cajón 1 [1]_2	1	788.00	190.50	18.00
35	MELA_BL, 18.00	Zócalo 1 [1]	1	1200.00	60.00	18.00
36	MELA_BL, 18.00	Zócalo 1 [2]	1	1200.00	60.00	18.00

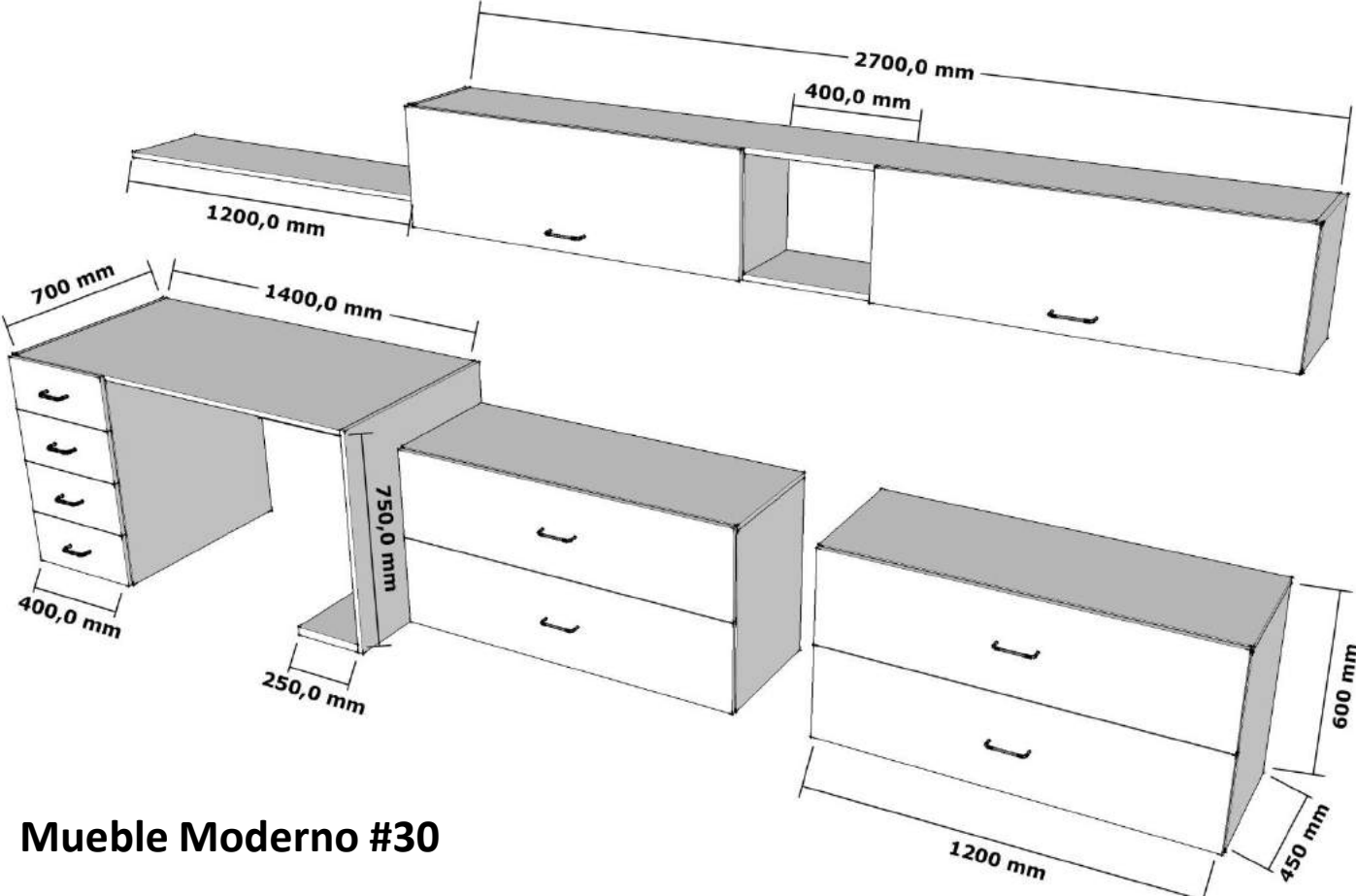

**Mueble Moderno #30**

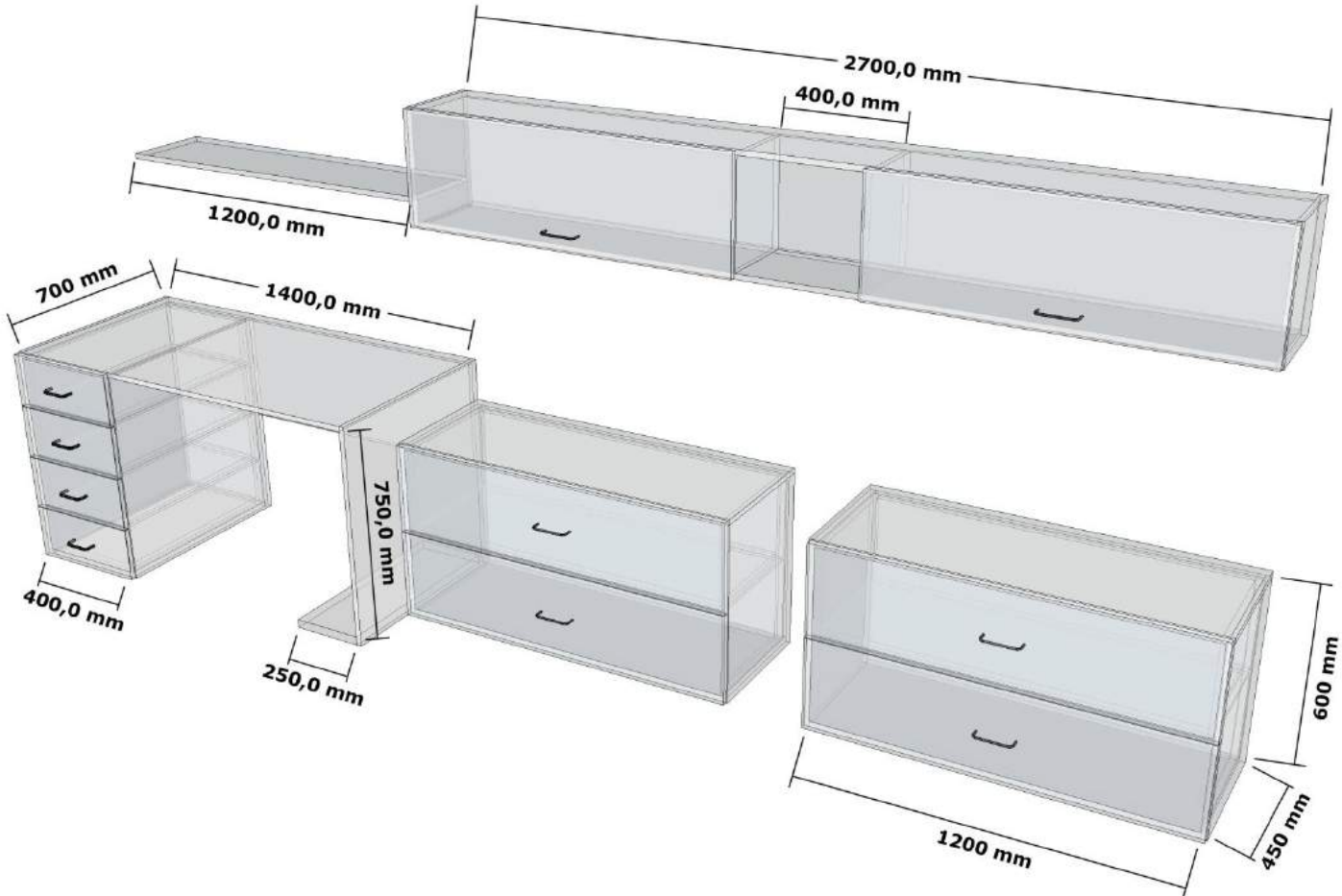

Num	Material	Referencia	Cantidad	Altura (mm)	Anchura (mm)	Espesor (mm)
1	MELA_BL, 18.00	Techo	1	1418.00	718.00	18.00
2	MELA_BL, 18.00	Lateral Derecho	1	786.00	718.00	18.00
3	MELA_BL, 18.00	Lateral Izquierdo	1	786.00	718.00	18.00
4	MELA_BL, 18.00	División Libre 1 [1]	1	768.00	400.00	18.00
5	MELA_BL, 18.00	División Libre 1 [2]	1	700.00	400.00	18.00
6	MELA_BL, 18.00	División Libre 1 [3]	1	1000.00	378.00	18.00
7	MELA_BL 30mm, 30.00	División Libre 1 [4]	1	700.00	250.00	30.00
8	MELA_BL, 18.00	División Vertical [1]	1	768.00	718.00	18.00
9	MELA_BL, 18.00	Cajón 1 [1]_1	1	192.75	430.00	18.00
10	MELA_BL, 18.00	Cajón 1 [1]_2	1	192.75	430.00	18.00
11	MELA_BL, 18.00	Cajón 1 [1]_3	1	192.75	430.00	18.00
12	MELA_BL, 18.00	Cajón 1 [1]_4	1	192.75	430.00	18.00
13	MELA_BL, 18.00	Lateral Der Cajón 1 [1]_1	1	681.00	169.75	18.00
14	MELA_BL, 18.00	Lateral Der Cajón 1 [1]_2	1	681.00	184.75	18.00
15	MELA_BL, 18.00	Lateral Der Cajón 1 [1]_3	1	681.00	184.75	18.00
16	MELA_BL, 18.00	Lateral Der Cajón 1 [1]_4	1	681.00	169.75	18.00
17	MELA_BL, 18.00	Lateral Izq Cajón 1 [1]_1	1	681.00	169.75	18.00
18	MELA_BL, 18.00	Lateral Izq Cajón 1 [1]_2	1	681.00	184.75	18.00
19	MELA_BL, 18.00	Lateral Izq Cajón 1 [1]_3	1	681.00	184.75	18.00
20	MELA_BL, 18.00	Lateral Izq Cajón 1 [1]_4	1	681.00	169.75	18.00
21	MELA_BL, 18.00	Fondo Cajón 1 [1]_1	1	663.00	358.00	18.00
22	MELA_BL, 18.00	Fondo Cajón 1 [1]_2	1	663.00	358.00	18.00
23	MELA_BL, 18.00	Fondo Cajón 1 [1]_3	1	663.00	358.00	18.00
24	MELA_BL, 18.00	Fondo Cajón 1 [1]_4	1	663.00	358.00	18.00
25	MELA_BL, 18.00	Trasera Cajón 1 [1]_1	1	358.00	169.75	18.00
26	MELA_BL, 18.00	Trasera Cajón 1 [1]_2	1	358.00	184.75	18.00
27	MELA_BL, 18.00	Trasera Cajón 1 [1]_3	1	358.00	184.75	18.00
28	MELA_BL, 18.00	Trasera Cajón 1 [1]_4	1	358.00	169.75	18.00
29	MELA_BL, 18.00	Contra-Frente Cajón 1 [1]_1	1	394.00	169.75	18.00
30	MELA_BL, 18.00	Contra-Frente Cajón 1 [1]_2	1	394.00	184.75	18.00
31	MELA_BL, 18.00	Contra-Frente Cajón 1 [1]_3	1	394.00	184.75	18.00
32	MELA_BL, 18.00	Contra-Frente Cajón 1 [1]_4	1	394.00	169.75	18.00

Num	Material	Referencia	Cantidad	Altura (mm)	Anchura (mm)	Espesor (mm)
1	MELA_BL, 18.00	Techo	1	1236.00	447.00	18.00
2	MELA_BL, 18.00	Suelo	1	1200.00	447.00	18.00
3	MELA_BL, 18.00	Lateral Derecho	1	618.00	447.00	18.00
4	MELA_BL, 18.00	Lateral Izquierdo	1	618.00	447.00	18.00
5	MELA_BL, 18.00	Trasera	1	600.00	1200.00	18.00
6	MELA_BL, 18.00	Cajón 1 [1]_1	1	313.50	1230.00	18.00
7	MELA_BL, 18.00	Cajón 1 [1]_2	1	313.50	1230.00	18.00
8	MELA_BL, 18.00	Lateral Der Cajón 1 [1]_1	1	410.00	290.50	18.00
9	MELA_BL, 18.00	Lateral Der Cajón 1 [1]_2	1	410.00	290.50	18.00
10	MELA_BL, 18.00	Lateral Izq Cajón 1 [1]_1	1	410.00	290.50	18.00
11	MELA_BL, 18.00	Lateral Izq Cajón 1 [1]_2	1	410.00	290.50	18.00
12	MELA_BL, 18.00	Fondo Cajón 1 [1]_1	1	1158.00	392.00	18.00
13	MELA_BL, 18.00	Fondo Cajón 1 [1]_2	1	1158.00	392.00	18.00
14	MELA_BL, 18.00	Trasera Cajón 1 [1]_1	1	1158.00	290.50	18.00
15	MELA_BL, 18.00	Trasera Cajón 1 [1]_2	1	1158.00	290.50	18.00
16	MELA_BL, 18.00	Contra-Frente Cajón 1 [1]_1	1	1194.00	290.50	18.00
17	MELA_BL, 18.00	Contra-Frente Cajón 1 [1]_2	1	1194.00	290.50	18.00

Num	Material	Referencia	Cantidad	Altura (mm)	Anchura (mm)	Espesor (mm)
1	MELA_BL, 18.00	Techo	1	2700.00	297.00	18.00
2	MELA_BL, 18.00	Suelo	1	2700.00	297.00	18.00
3	MELA_BL, 18.00	Lateral Derecho	1	386.00	297.00	18.00
4	MELA_BL, 18.00	Lateral Izquierdo	1	386.00	297.00	18.00
5	MELA_BL, 18.00	Trasera	1	350.00	2700.00	18.00
6	MELA_BL, 18.00	División Vertical [1]	1	350.00	279.00	18.00
7	MELA_BL, 18.00	División Vertical [2]	1	350.00	279.00	18.00
8	MELA_BL, 18.00	Puerta 1 (unica) [1]	1	380.00	1162.00	18.00
9	MELA_BL, 18.00	Puerta 1 (unica) [2]	1	380.00	1162.00	18.00

Num	Material	Referencia	Cantidad	Altura (mm)	Anchura (mm)	Espesor (mm)
1	MELA_BL, 18.00	Suelo	1	1200.00	300.00	18.00