

Version No.			

ROLL NUMBER						



0	0	0	0
1	1	1	1
2	2	2	2
3	3	3	3
4	4	4	4
5	5	5	5
6	6	6	6
7	7	7	7
8	8	8	8
9	9	9	9

0	0	0	0	0	0	0
1	1	1	1	1	1	1
2	2	2	2	2	2	2
3	3	3	3	3	3	3
4	4	4	4	4	4	4
5	5	5	5	5	5	5
6	6	6	6	6	6	6
7	7	7	7	7	7	7
8	8	8	8	8	8	8
9	9	9	9	9	9	9

Answer Sheet No. _____

Sign. of Candidate _____

Sign. of Invigilator _____

BIOLOGY HSSC-II

SECTION – A (Marks 17)

Time allowed: 25 Minutes

Section – A is compulsory. All parts of this section are to be answered on this page and handed over to the Centre Superintendent. Deleting/overwriting is not allowed. **Do not use lead pencil.**

Q.1 Fill the relevant bubble for each part. All parts carry one mark.

1. The area in lungs where blood vessels and airways pass in and out is called:
- | | |
|--------------------------------------|----------------------------------|
| A. Pelvis <input type="radio"/> | B. Hilum <input type="radio"/> |
| C. Mediastinum <input type="radio"/> | D. Fissure <input type="radio"/> |

2. Antidiuretic hormone promotes the retention of water by stimulating the:
- | |
|---|
| A. Active transport of water <input type="radio"/> |
| B. Active transport of chloride <input type="radio"/> |
| C. Active transport of sodium <input type="radio"/> |
| D. Permeability of collecting duct to water <input type="radio"/> |

3. Vasa recta is the cluster of capillaries present in the nephron of human beings. It is derived from “X” and surrounds “Y”, where “X” are arterioles and “Y” are tube like structures. Which one of the following correctly identifies “X” and “Y”?

	X	Y	
A	Efferent arterioles	Proximal convoluted tubule	<input type="radio"/>
B	Afferent arterioles	Proximal convoluted tubule	<input type="radio"/>
C	Efferent arterioles	Loop of Henle	<input type="radio"/>
D	Afferent arterioles	Loop of Henle	<input type="radio"/>

4. During human embryonic development, first site of RBC formation is:
- | | |
|------------------------------------|-------------------------------------|
| A. Yolk sac <input type="radio"/> | B. Allantois <input type="radio"/> |
| C. Notochord <input type="radio"/> | D. Blastocyst <input type="radio"/> |
5. Some animals like fiddler crab, busiest during the time of either dawn or dusk or both are called:
- | | |
|--|--|
| A. Diurnal animals <input type="radio"/> | B. Nocturnal animals <input type="radio"/> |
| C. Crepuscular animals <input type="radio"/> | D. Circadian animals <input type="radio"/> |
6. The best way to prevent tetanus is to take:
- | | |
|-------------------------------------|---------------------------------------|
| A. Antibiotic <input type="radio"/> | B. Pain killers <input type="radio"/> |
| C. Vaccine <input type="radio"/> | D. Sedatives <input type="radio"/> |

7. The ability to remove wrong nucleotides if it is added mistakenly is called:
 A. Degeneracy B. Splicing
 C. Proofreading D. Primosome
8. Secondary sewage treatment is mainly due to:
 A. Mechanical processes B. Biological processes
 C. Physical processes D. Chemical processes
9. Autonomic functions of body such as heartbeat, blood pressure and respiration are controlled by:
 A. Cerebellum B. Pons
 C. Medulla D. Thalamus
10. Which tRNA can bind at mRNA codon UGA?
 A. tRNA with anticodon ACU B. tRNA with anticodon ACT
 C. tRNA with anticodon TGA D. tRNA with anticodon TCU
11. The given diagram shows a simple reflex arc. Which labelled part has neuron cell bodies and nonmyelinated parts of nerve fibre?

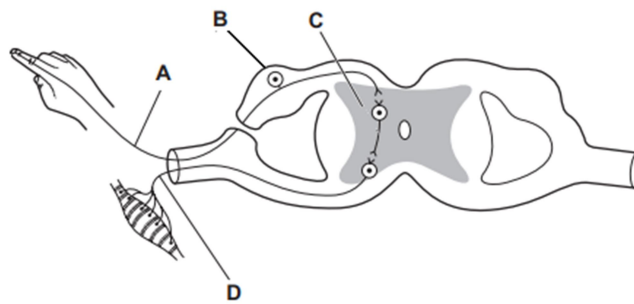

12. Which one is **NOT** related to insulin?
 A. It promotes glycogenesis.
 B. It inhibits gluconeogenesis.
 C. It's under secretion causes glycosuria.
 D. It's under secretion causes hypoglycemia.
13. I. Globular proteins
 II. Thin thread-like structures
 III. Wound around actin filaments
 The feature(s) which describes tropomyosin is/are:
 A. I only B. III only
 C. II and III D. I and III
14. Which one of the following recombinant DNA technology tool is incorrectly paired with its use?
 A. Restriction endonuclease ----- production of RFLP
 B. DNA ligase ----- production of sticky ends in restriction fragments
 C. Reverse transcriptase ----- production of cDNA
 D. PCR ----- gene amplification
15. What are phenotypes of parents of a colour blind son and non-carrier daughter with normal colour vision?

	Father	Mother
A.	Carrier	Normal
B.	Colour blind	Carrier
C.	Normal	Carrier
D.	Normal	Colour blind

-

16. Which one of the following is the palindromic sequence?

- A. GATC B. GGTT
C. CGAT D. TTCC

17. The diagram shows an aquatic food web.

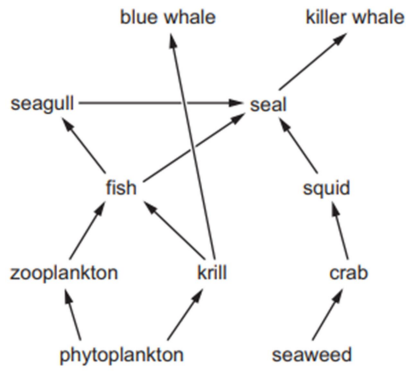

Which one of the following statement is correct?

- A. There are two producers and three herbivores.
B. There are two primary consumers and two secondary consumers.
C. There are three producers and two primary consumers.
D. There are two herbivores and two tertiary consumers.



Federal Board HSSC-II Examination
Biology Model Question Paper
(Curriculum 2006)

Time allowed: 2:35 hours

Total Marks: 68

Note: Answer any fourteen parts from Section 'B' and attempt any two questions from Section 'C' on the separately provided answer book. Write your answers neatly and legibly.

SECTION – B (Marks 42)

Q.2 Attempt any **FOURTEEN** parts from the following. All parts carry equal marks.

(14 × 3 = 42)

- i. What are osmoregulators? How do they adapt in fresh water? Give example.
- ii. Name cranial and facial bones with paired and unpaired classification.
- iii. List the roles of the components of limbic system in human brain.
- iv. What are the different types of hormones on the basis of their chemical nature?
- v. What are the characteristics (symptoms) of different types of hypothyroidism?
- vi. Define latent learning and explain with example.
- vii. Define miscarriage? What are the possible causes of miscarriage?
- viii. What are the drawbacks of Lamarckism that lead to rejection of this theory of evolution?
- ix. Differentiate between convergent and divergent evolution with example.
- x. Describe Hamburger phenomenon.
- xi. Discuss the hormonal control of male reproductive system.
- xii. Why is Sanger's method of gene sequencing called chain termination method?
- xiii. How does dominance differ from epistasis? Give an example to clear the difference.
- xiv. Explain erythroblastosis foetalis. Give its prevention and management.
- xv. Gene expression is a strictly regulated process. How is gene expression regulated positively or negatively?
- xvi. Nuclear power is one of the important sources of energy especially in developed countries. How nuclear power generation and management may be disadvantageous?
- xvii. Given figure shows structures in human thorax. Identify parts labelled A, B and C and describe their roles.

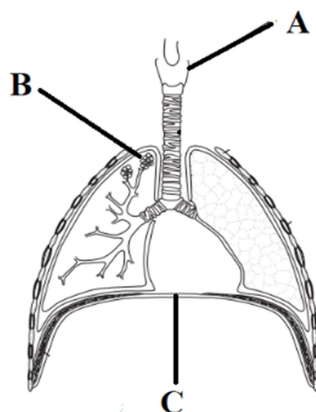

xviii. The menstrual cycle is coordinated by hormones secreted by the pituitary gland and hormones secreted by the ovaries. Figure shows some of the events that occur during the menstrual cycle.

H	FSH is secreted by the pituitary gland
J	oestrogen stimulates repair and growth of the lining of the uterus
K	one or more follicles start to develop in an ovary
L	ovulation occurs
M	oestrogen is secreted by follicle cells
N	LH is secreted by the pituitary gland
O	oestrogen inhibits secretion of FSH

a. Put the steps (labelled H, J, K, L, M, N, O) into the correct sequence in the following table: (2)

--	--	--	--	--	--	--

b. Name the ovulating follicle and what happens to this follicle after ovulation? (1)

xix. After kidney failure, dialysis is performed. The given figure shows how blood, fresh and used dialysis fluid move through a dialysis machine. The composition of the dialysis fluid changes as it passes through the dialysis machine.

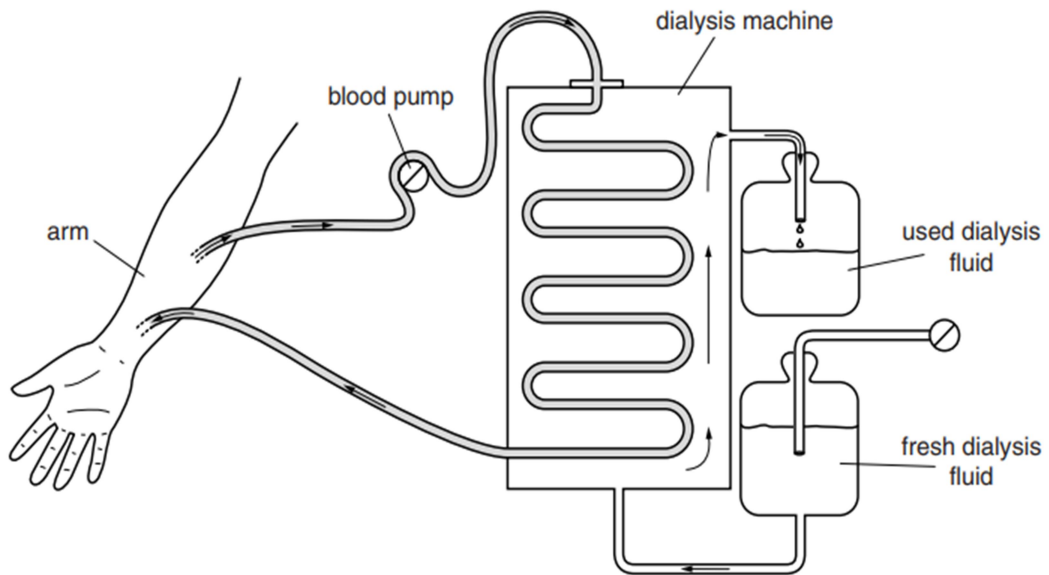

a. Redraw and complete the table using words “low”, “high”, “same” or “none” to show how concentration of each substance changes in the dialysis fluid and blood. (2)

Substance	Concentration of substance in			
	Blood before Dialysis	Fresh dialysis fluid	Used Dialysis fluid	Blood after Dialysis
Glucose	Low			
Salts	High			
Urea	High			
Toxin	High			

b. Why is the blood pump used during dialysis? (1)

- xx. The given figure shows the inheritance of Duchene muscular dystrophy, which is X-linked recessive disorder.

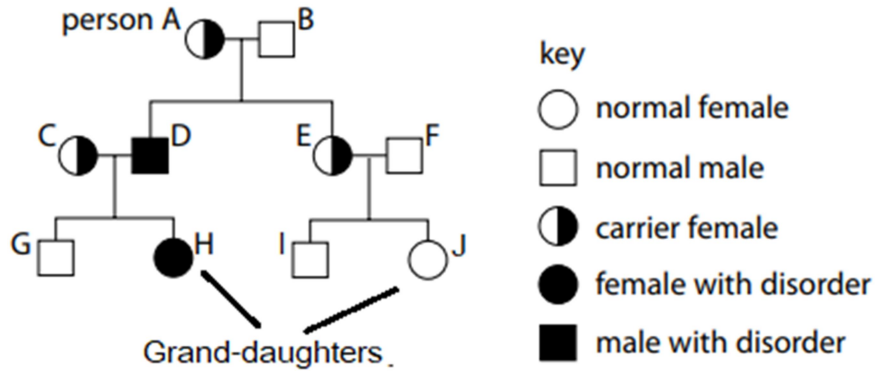

Describe why grand-daughter “H” of person “A” is affected with this disorder whereas grand-daughter “J” of the same person “A” is normal?

SECTION – C (Marks 26)

Note: Attempt any **TWO** questions. All questions carry equal marks. (2×13 = 26)

- Q.3** a. Describe and sketch sliding filament model of a skeletal muscle fibre. (4+2)
 b. Draw and describe different steps of Nitrogen Cycle in detail. (3+4)

- Q.4** a. Given figure is a flow diagram showing how insulin is produced using genetic engineering.

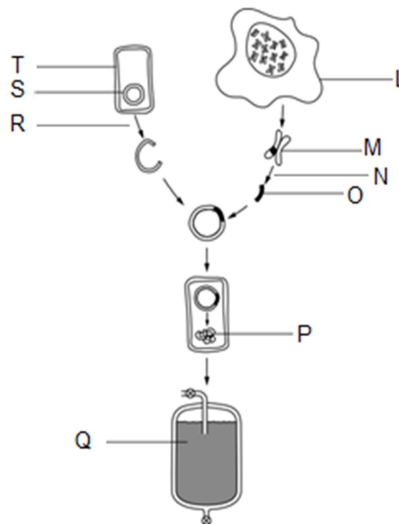

- i. Define and describe the steps involved in recombinant DNA technology. (3)
 ii. At which step/s restriction endonuclease enzyme was used in this process? Why is this enzyme named so? (1.5)
 iii. Complete Table as completed in first row. (2.5)

Letter from figure	Name	Description
M	chromosomes	threads of DNA found in the nucleus
		section of DNA removed from human cell
	plasmid	
		type of cell that is genetically engineered
		specific chain of amino acids coded by the section of DNA removed from the human cell
	fermenter	

- b. What are the factors involved in the establishment and maintenance of resting membrane potential in a neuron? Show diagrammatically as well. (4+2)

- Q.5** a. Discuss Hershey and Chase experiments. What was concluded from these experiments? Draw labelled diagram. (3+2+2)
- b. The given figure shows placenta connecting foetus to uterine wall.

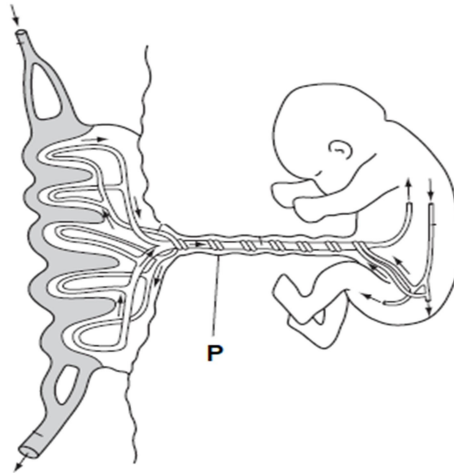

- i. Describe the structure, purpose and development of placenta along with its hormonal role during pregnancy. (4)
- ii. Name the structure labelled as "P". What is its role and what happens to it after birth of baby. (2)

* * * * *

BIOLOGY HSSC-II
Model Question Paper SLOs
(Curriculum 2006)

SECTION – A

Q.1 Fill the relevant bubble for each part. All parts carry one mark.

1. Describe the structural features and functions of the components of human respiratory system.
2. Explain that concentration of urine is regulated by counter current and hormonal mechanisms.
3. Explain the structure, types and functions of autonomic nervous system.
4. Describe the events of development in human in terms of first, second and third trimesters.
5. Explain through examples, the biological rhythms.
6. Describe the role of vaccines in preventing polio, measles, hepatitis and tetanus.
7. Describe the events of the process of DNA replication.
8. Explain the role of microbes in household food processing, industrial production, sewage treatment and energy generation.
9. Explain the detailed structure of nephron.
10. Differentiate between the terms genetic code and codon.
11. Differentiate between myelinated and non-myelinated neurons.
12. Locate the following endocrine glands in human body; pituitary, thyroid, parathyroid, pancreas, adrenal, gonads.
13. Explain the ultra structure of the skeletal muscles.
14. Describe the techniques of gene cloning through recombinant DNA technology.
15. Critically analyze the inheritance of Haemophilia, colour blindness and muscular dystrophy.
16. Explain the role of restriction endonucleases and DNA ligases in gene cloning.
17. Explain the flow of energy in successive trophic levels.

SECTION – B

Q.2 Attempt any **FOURTEEN** parts from the following. All parts carry equal marks.

(14 × 3 = 42)

- i. Differentiate between osmoconformers and osmoregulators.
- ii. List the bones of appendicular and axial skeleton of man.
- iii. Explain briefly the functions of major divisions of brain.
- iv. Describe the chemical nature of hormones and correlate it with important hormones.
- v. Outline the major functions of the hormones of above mentioned glands and also relate the problems associated with the imbalance of these hormones.
- vi. Describe instrumental conditioning (trial and error learning) by narrating the work of skinner on rats learning. Describe latent learning, through the example of a rat in a maze with no reward.
- vii. Define miscarriage and state its causes. Relate miscarriage with abortion.
- viii. State the drawbacks in Lamarckism.

- ix. Differentiate between convergent and divergent evolution on the basis of inheritance of the homologous and analogous structures.
- x. Describe the transport of oxygen and carbon dioxide through blood.
- xi. Explain the principal reproductive hormones of human male and explain their role in the maintenance and functioning of reproductive system.
- xii. Explain the Maxam / Gilbert procedure and the Sanger-Coulson method of DNA sequencing.
- xiii. Explain the terms; polygenic and epistasis.
- xiv. Explain Erythroblastosis foetalis in the light of antigen-antibody reaction. Suggest measures to counter the problem of Erythroblastosis foetalis before it occurs.
- xv. Describe the negative control of gene expression by repressor proteins. Describe the positive control of gene expression by activator proteins.
- xvi. State the problems of using nuclear power.
- xvii. Describe the structural features and functions of the components of human respiratory system.
- xviii. Describe the menstrual cycle emphasizing the role of hormones.
- xix. Explain in detail the mechanism and problems related to dialysis.
- xx. Critically analyze the inheritance of Haemophilia, colour blindness and muscular dystrophy.

SECTION – C (Marks 26)

Note: Attempt any **TWO** questions. All questions carry equal marks. (2×13 = 26)

- Q.3**
- a. Explain the sliding filaments model of muscle contraction.
 - b. Describe nitrogen cycle in detail. Define the terms of nitrogen-fixation, nitrification, de-nitrification and ammonification.
- Q.4**
- a. Define gene cloning and state the steps in gene cloning. The techniques of gene cloning through recombinant DNA technology. Explain the role of restriction endonucleases and DNA ligases in gene cloning. Describe the selection and isolation of the gene of interest. Explain the properties and the role of vectors in recombinant technology. State the steps for the integration of DNA insert into the vectors. Briefly state the technique applied for the selection of the vectors that take up the DNA of interest.
 - b. Name the factors responsible for the resting membrane potential of neuron.
- Q.5**
- a. Narrate the experimental work of Griffith and Hershey-Chase, which proved that DNA is the hereditary material.
 - b. Describe the structural details of placenta and umbilical cord.

* * * * *

BIOLOGY HSSC II

Table of Specifications

Assessment Objectives	Unit 14: Respiration	Unit 15: Homeostasis	Unit 16: Support and Movement	Unit 17: Nervous Coordination	Unit 18: Chemical Coordination	Unit 19: Behaviour	Unit 20: Reproduction	Unit 21: Development and aging	Unit 22: Inheritance	Unit 23: Chromosome and DNA	Unit 24: Evolution	Unit 25: Man and his Environment	Unit 26: Biotechnology	Unit 27: Biology and Human Welfare	Total Marks	%age
K (Knowledge)	Q1(1) 1	Q1(2) 1 Q2(i) 3	Q2(ii) 3	Q1(3) 1 Q2(iii) 3	Q2(iv) 3 Q2(v) 3	Q1(5) 1 Q2(vi) 3	Q2(vii) 3	Q1(4) 1		Q1(7) 1	Q2(viii) 3 Q2(ix) 3			Q1(6) 1 Q1(8) 1	35	30.2%
U (Understanding)	Q2(x) 3	Q1(9) 1	Q3(a) 6	Q1(11) 1 Q4(b) 6	Q1(12) 1		Q2(xi) 3		Q2(xiii) 3 Q2(xiv) 3	Q1(10) 1 Q2(xv) 3 Q5(a) 7		Q2(xvi) 3 Q3(b) 7	Q2(xii) 3 Q4(a) 7		58	50%
A (Application)	Q2(xvii) 3	Q2(xix) 3	Q1(13) 1				Q2(xviii) 3	Q5(b) 6	Q1(15) 1 Q2(xx) 3			Q1(17) 1	Q1(14) 1 Q1(16) 1		23	19.8%
Total Marks	7	8	10	11	7	4	9	7	10	12	6	12	11	2	116	

KEY:

1(1)(01)

Question No (Part No.) (Allocated Marks)