

CAPTAIN'S INSTRUMENT PANEL

Jul 24/85

BR-9
05.20.1

7A

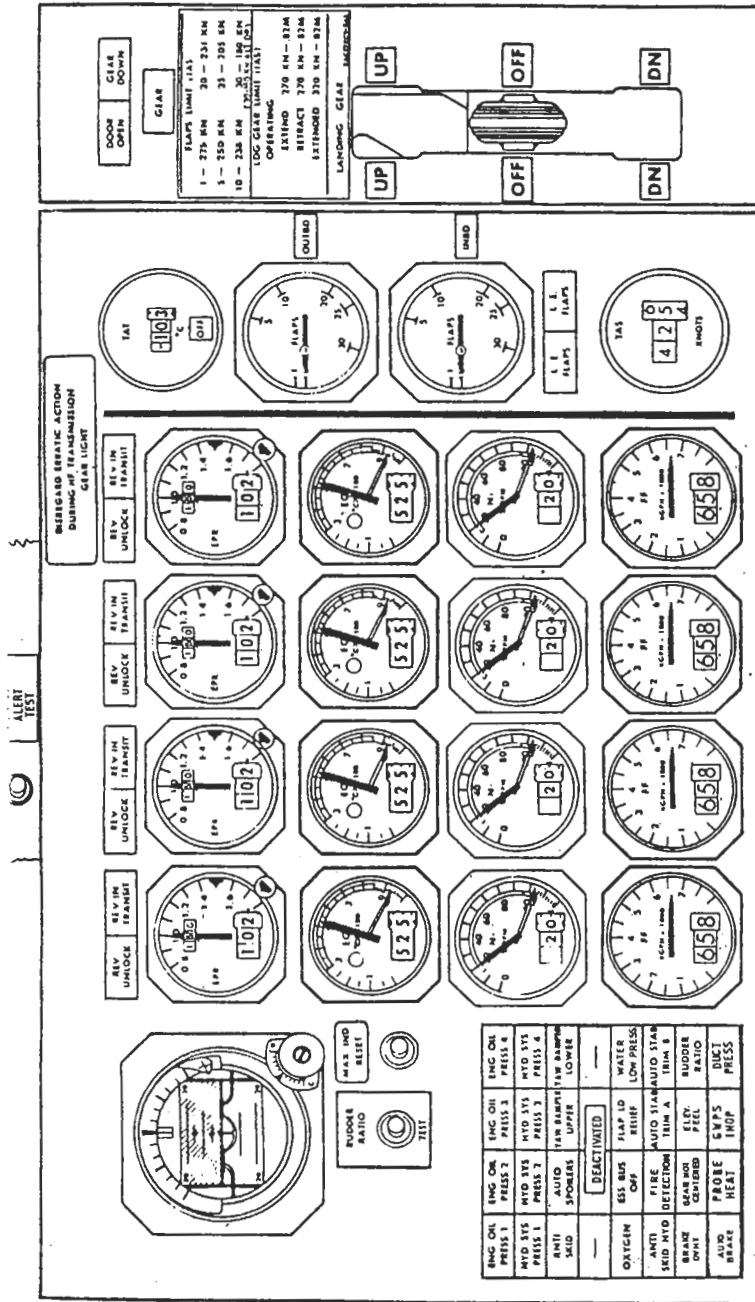

PILOTS' CENTRE INSTRUMENT PANEL

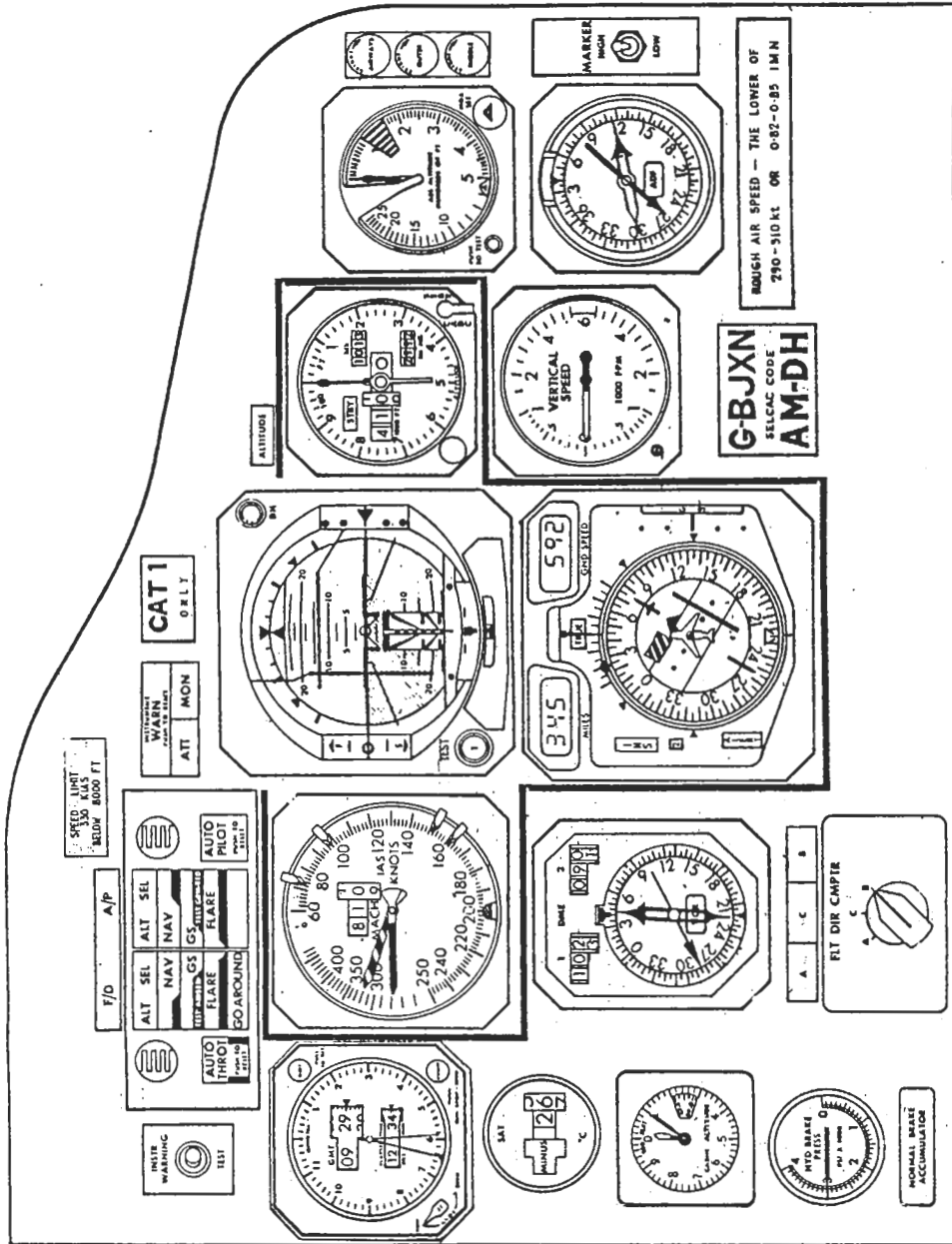

FIRST OFFICER'S INSTRUMENT PANEL

AIRPLANE GENERAL
COCKPIT PANELS

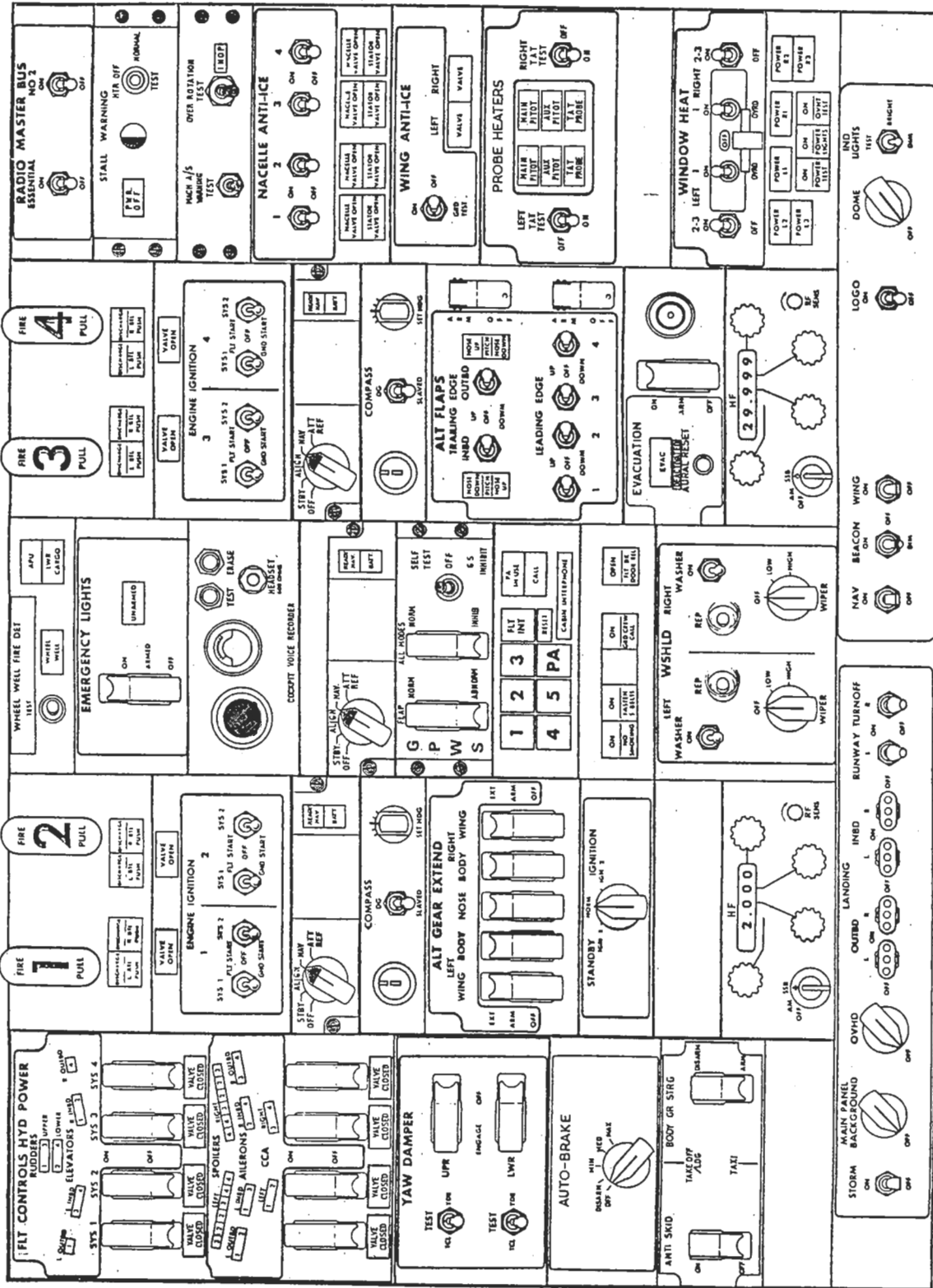

PILOTS' OVERHEAD PANEL

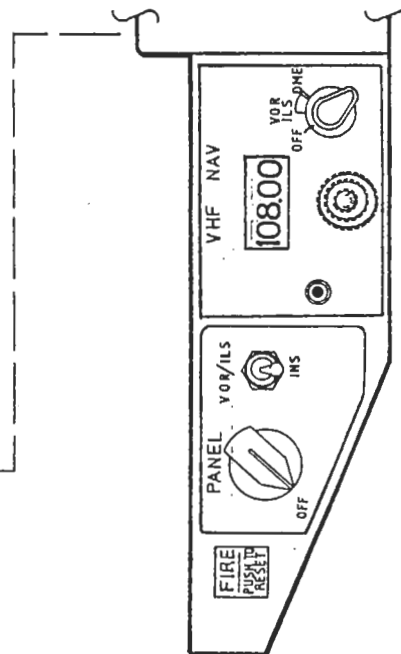
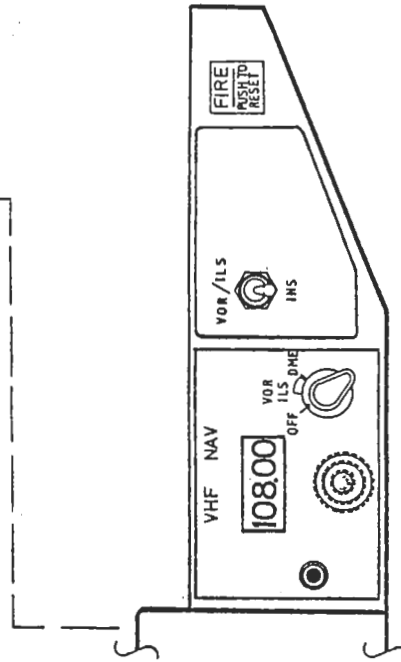
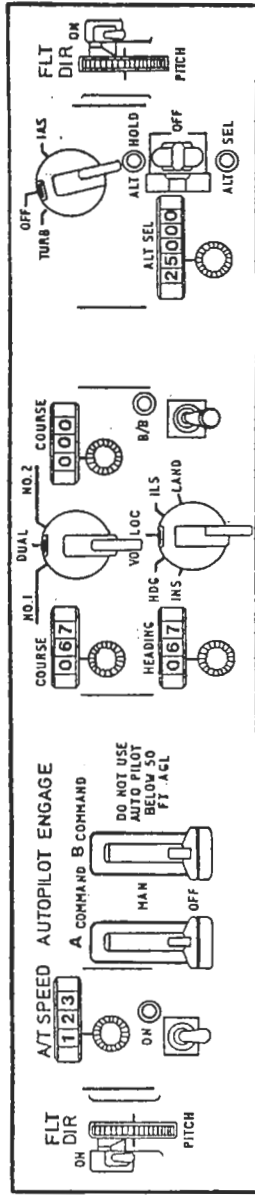

PILOTS' LIGHTSHIELD

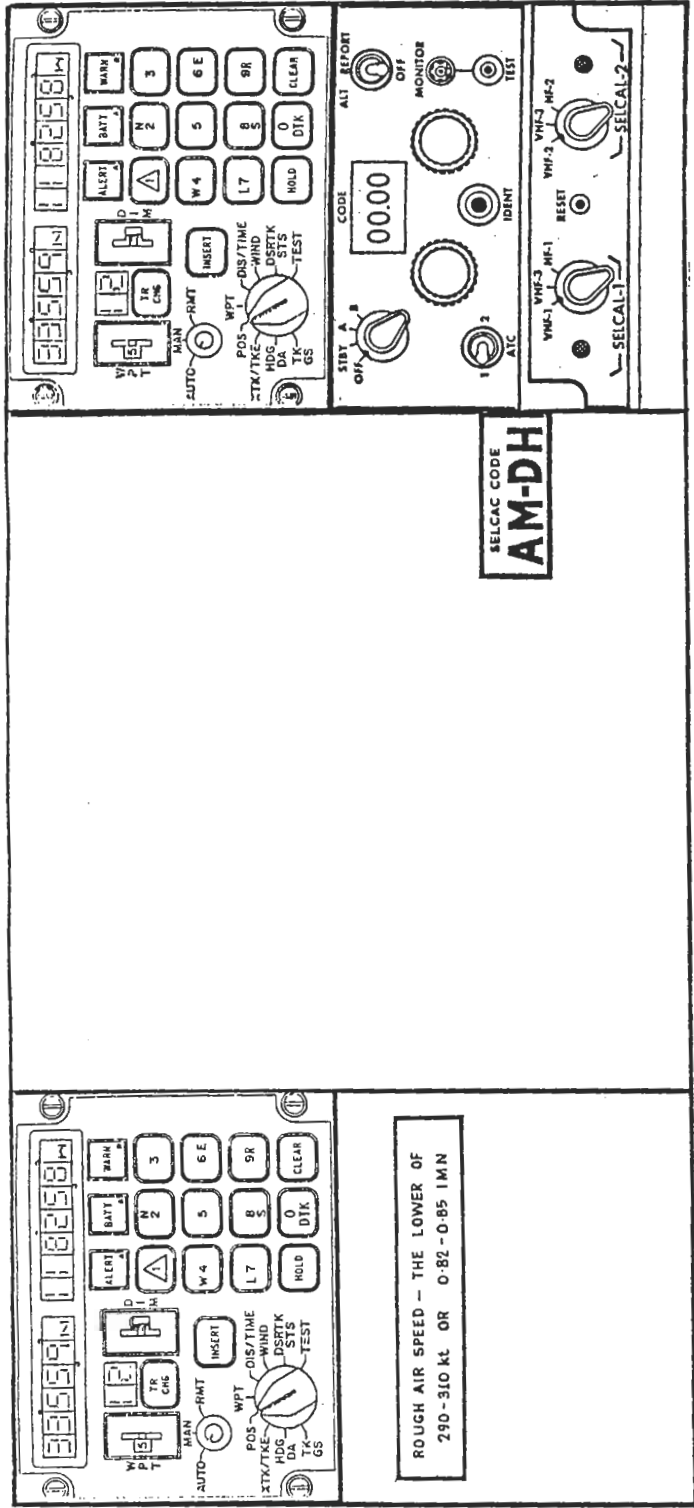

FORWARD ELECTRONICS PANEL

BR-9
05.20.6

Jul 24/85

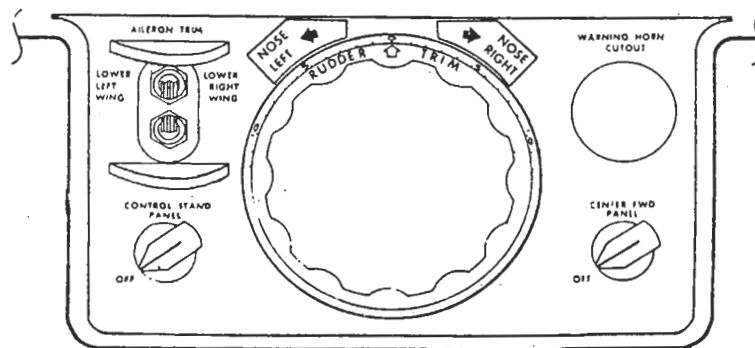
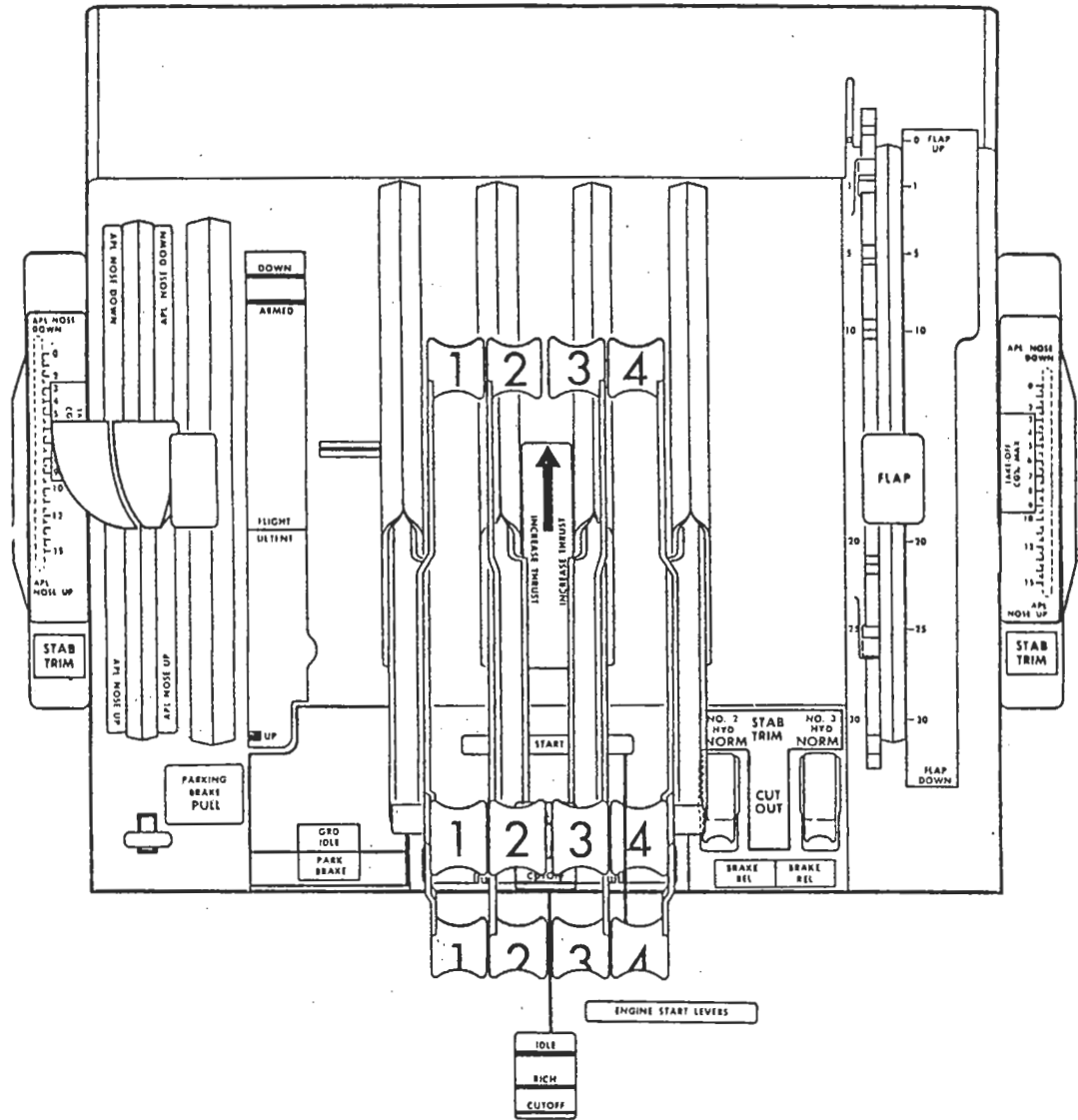

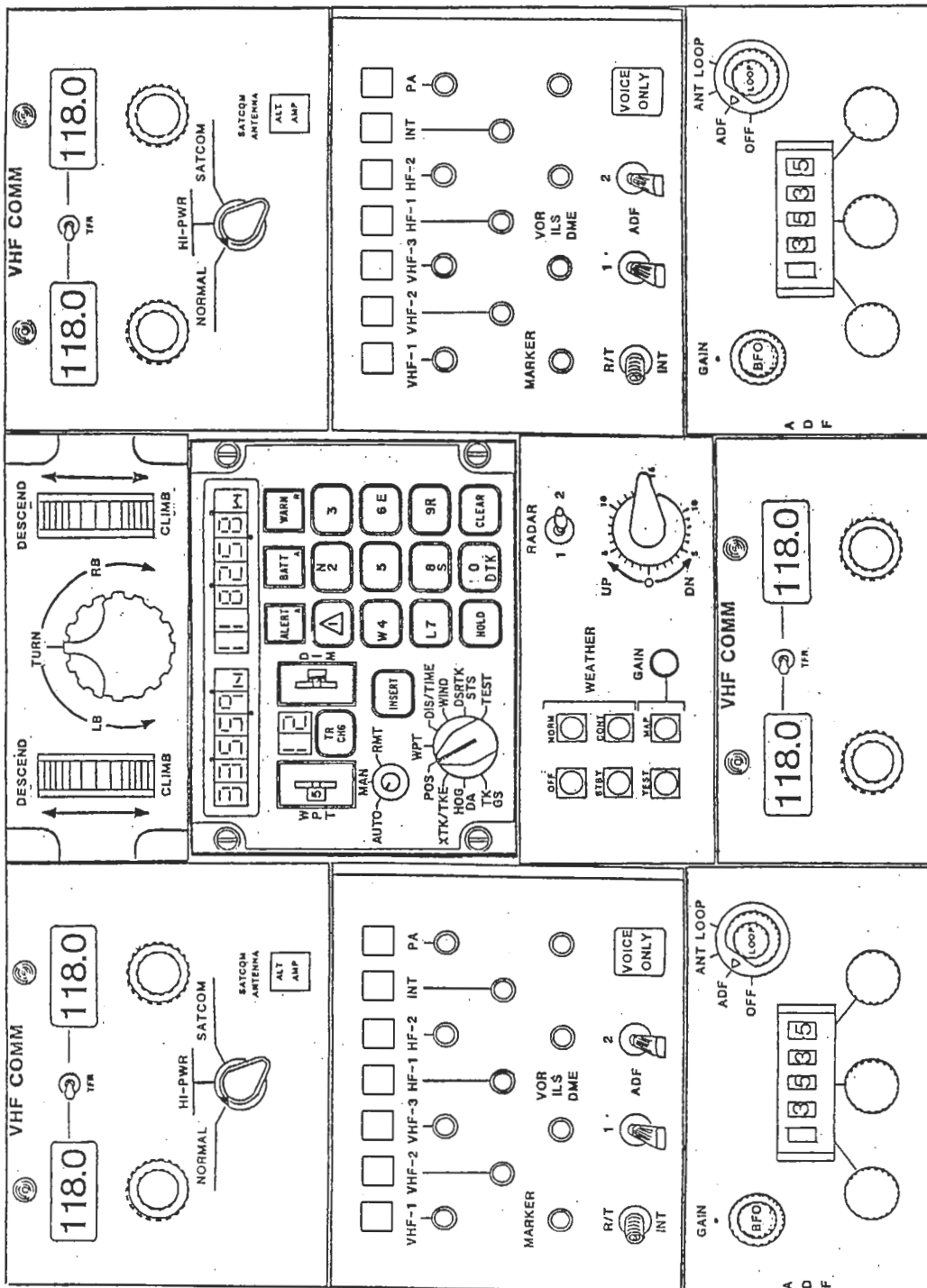

AFT ELECTRONICS PANEL

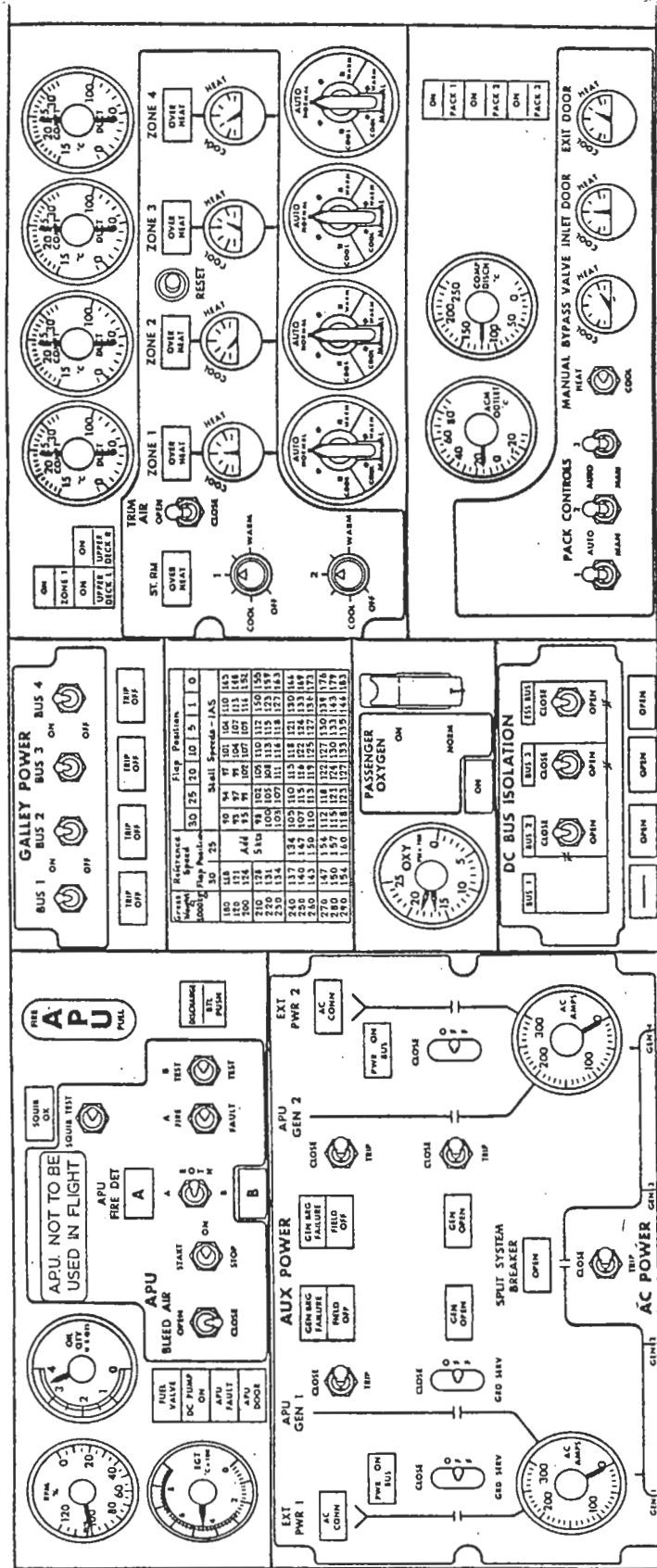

FLIGHT ENGINEER'S INSTRUMENT PANEL
PART UPPER PANEL LEFT

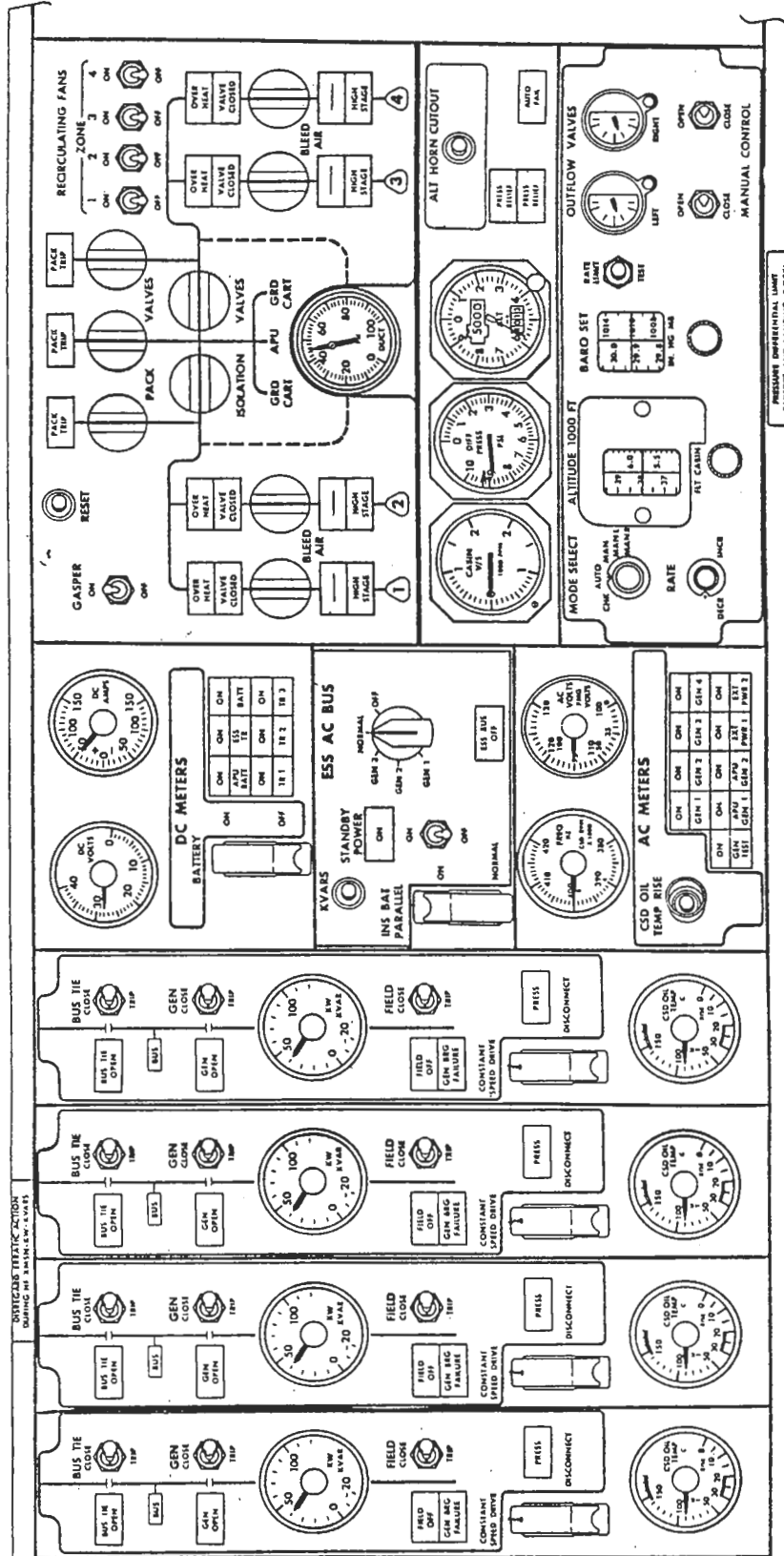

BR-9
05.20.10

FLIGHT ENGINEER'S INSTRUMENT PANEL
PART UPPER PANEL - LEFT

Jul 24/85

7A

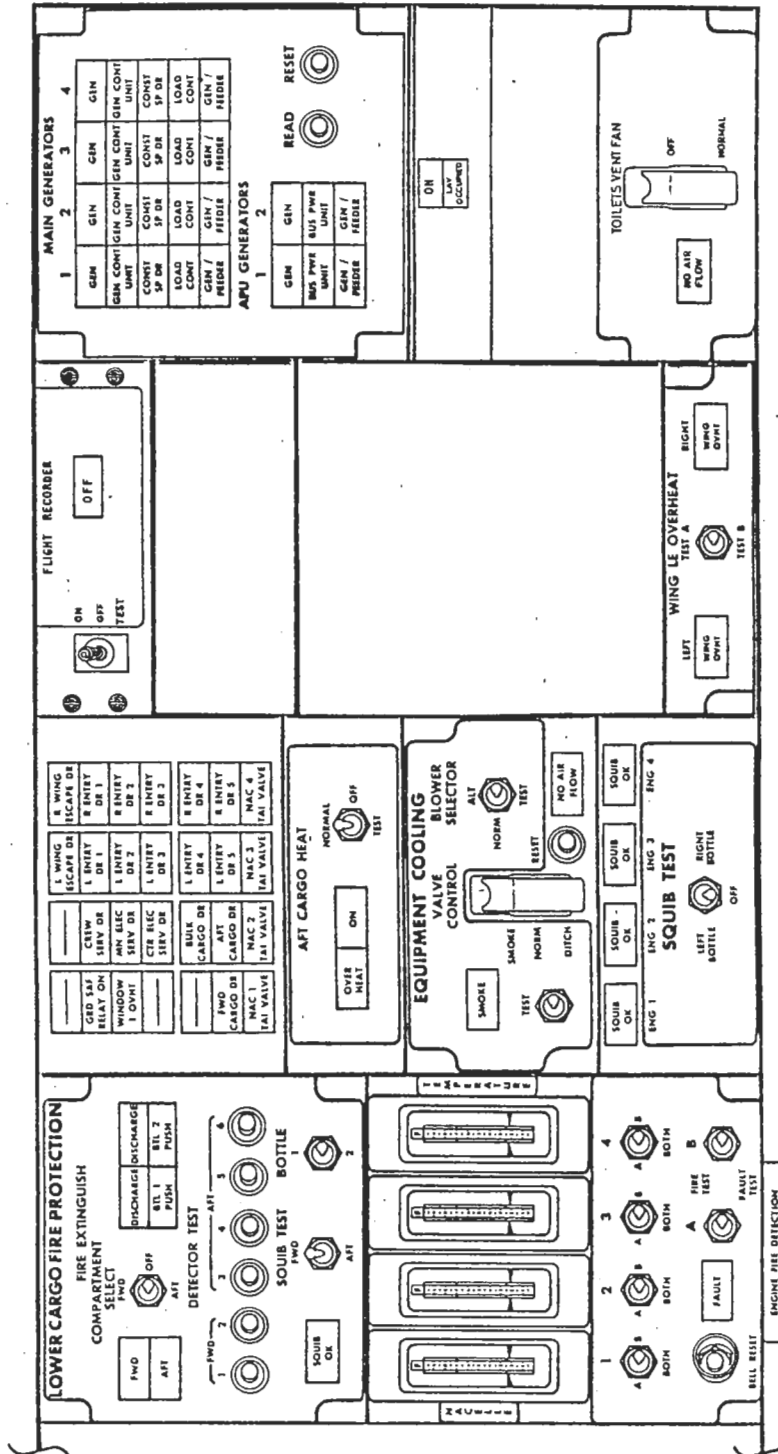

FLIGHT ENGINEER'S INSTRUMENT PANEL
PART UPPER PANEL - RIGHT

Jul 24/85

7A

BR-9
05.20.11

AIRPLANE GENERAL
COCKPIT PANELS

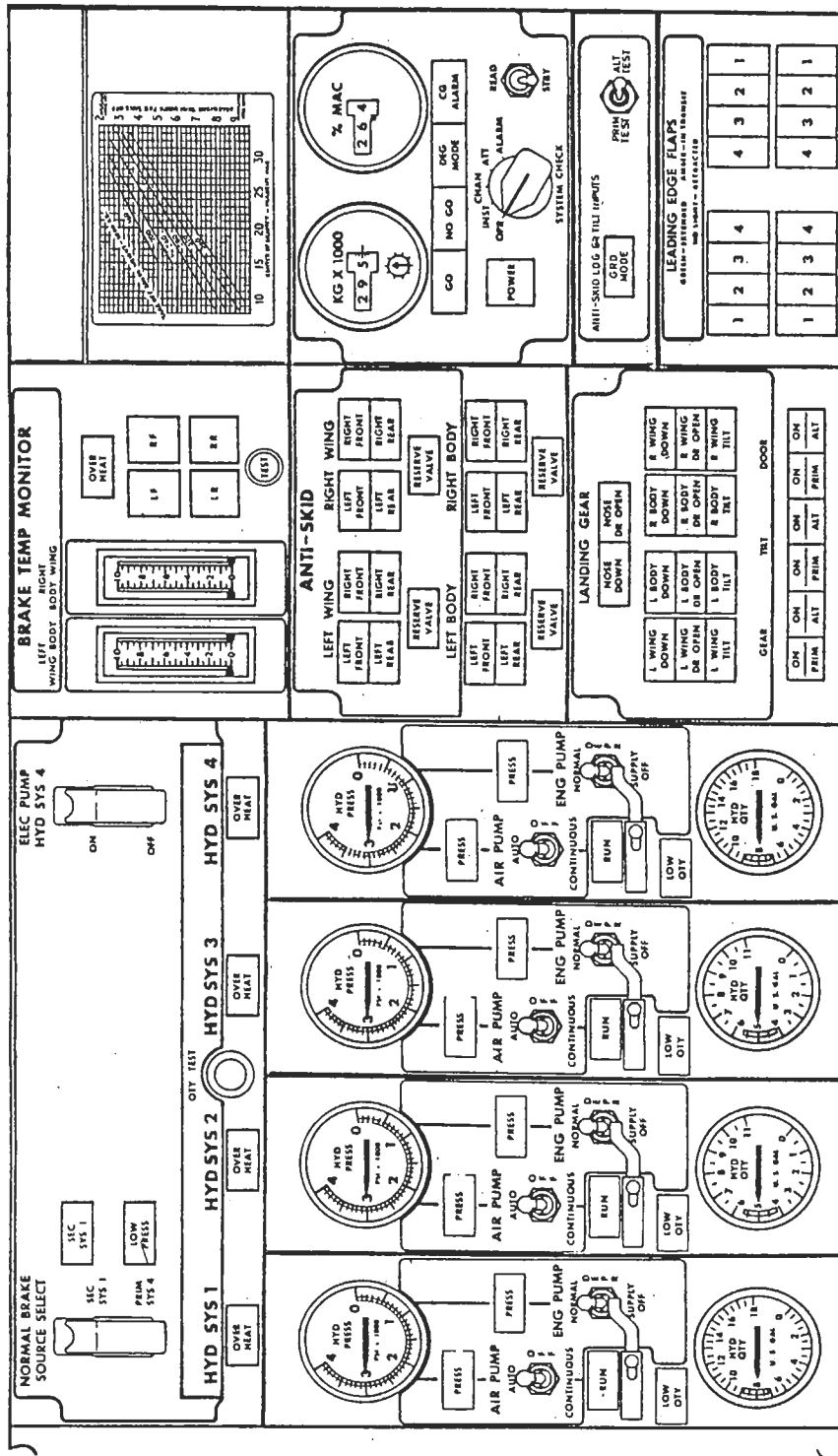

FLIGHT ENGINEER'S INSTRUMENT PANEL
PART UPPER PANEL - RIGHT

BR-9
05.20.12

7A

Jul 24/85

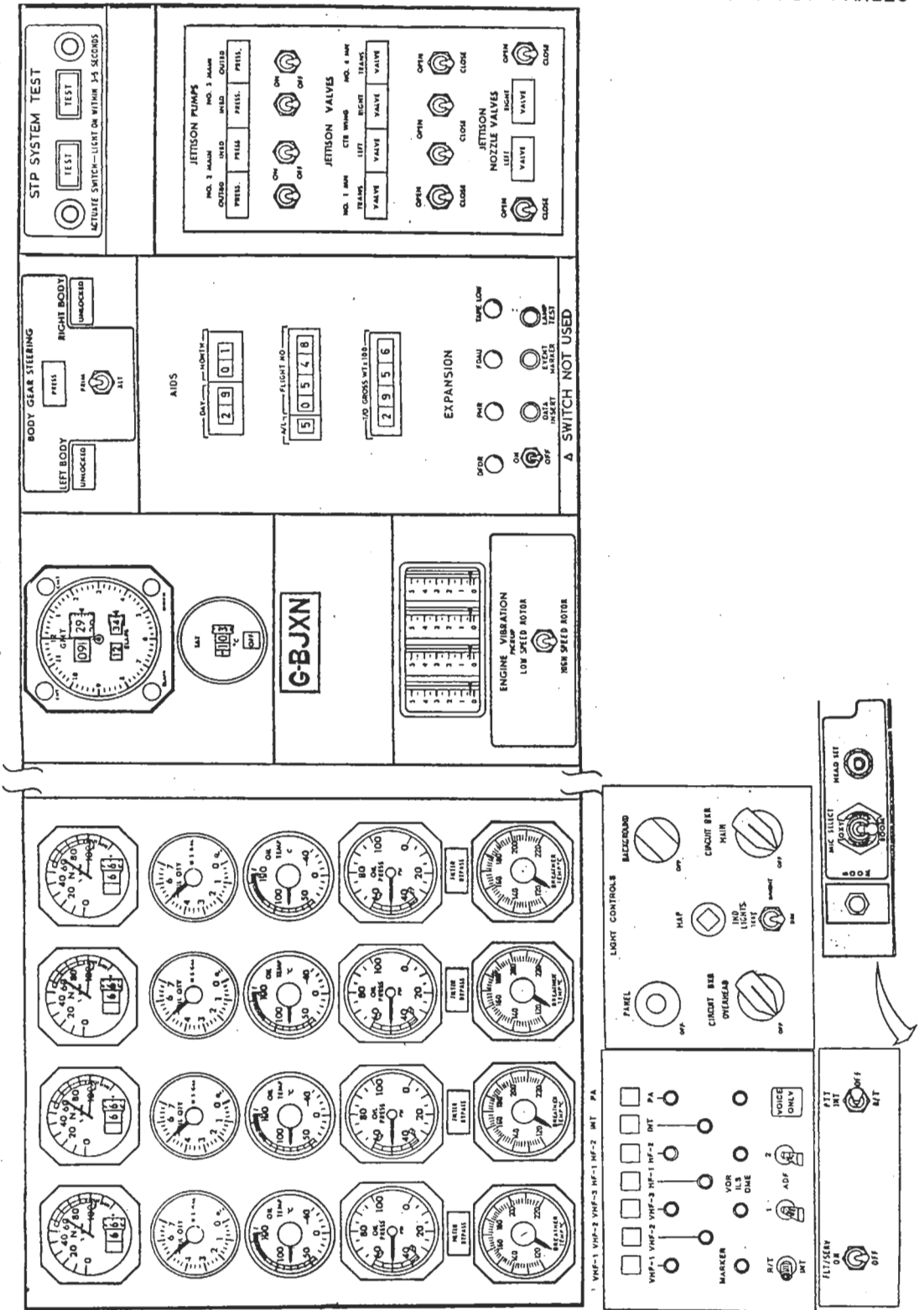

FLIGHT ENGINEER'S INSTRUMENT PANEL
LEFT AND RIGHT

Jul 24/85

7A

BR-9
05.20.13

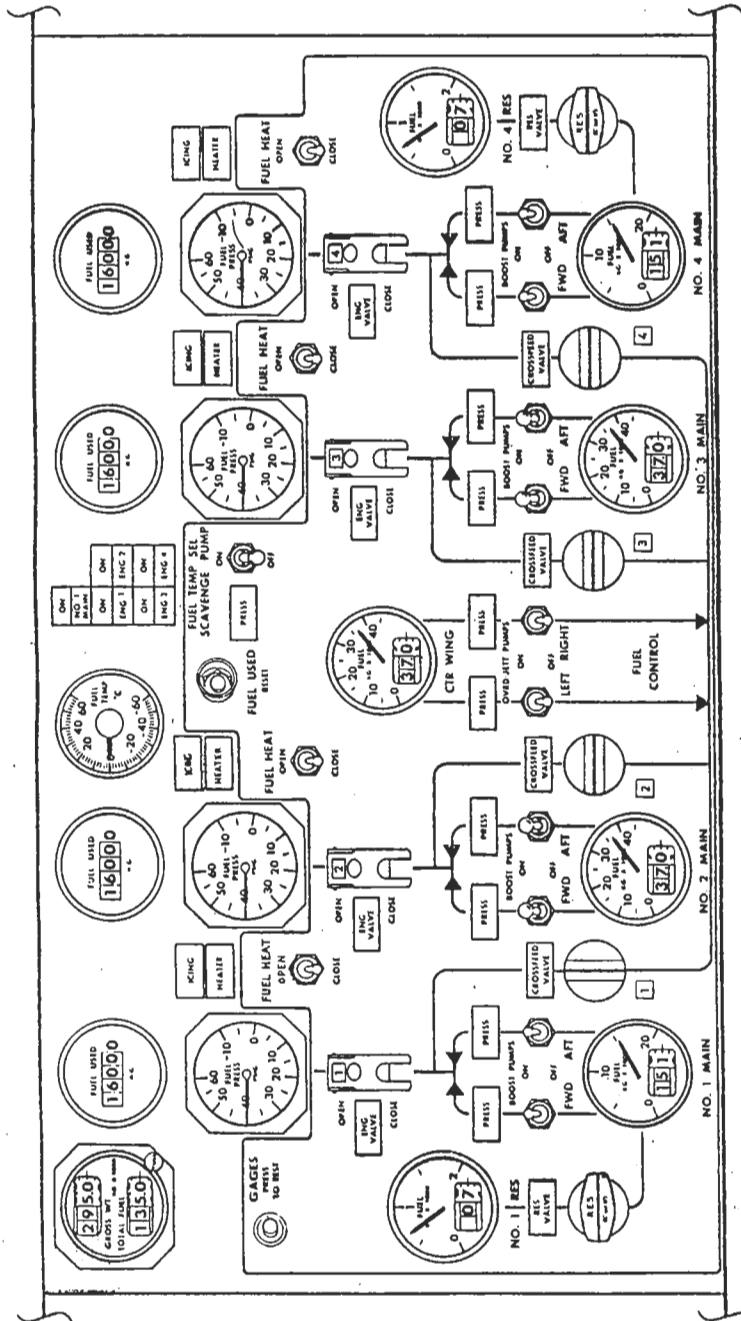

FLIGHT ENGINEER'S INSTRUMENT PANEL
LOWER PANEL CENTRE

BR-9
05.20.14

7A

Jul 24/85

AIRPLANE GENERAL
COCKPIT PANELS

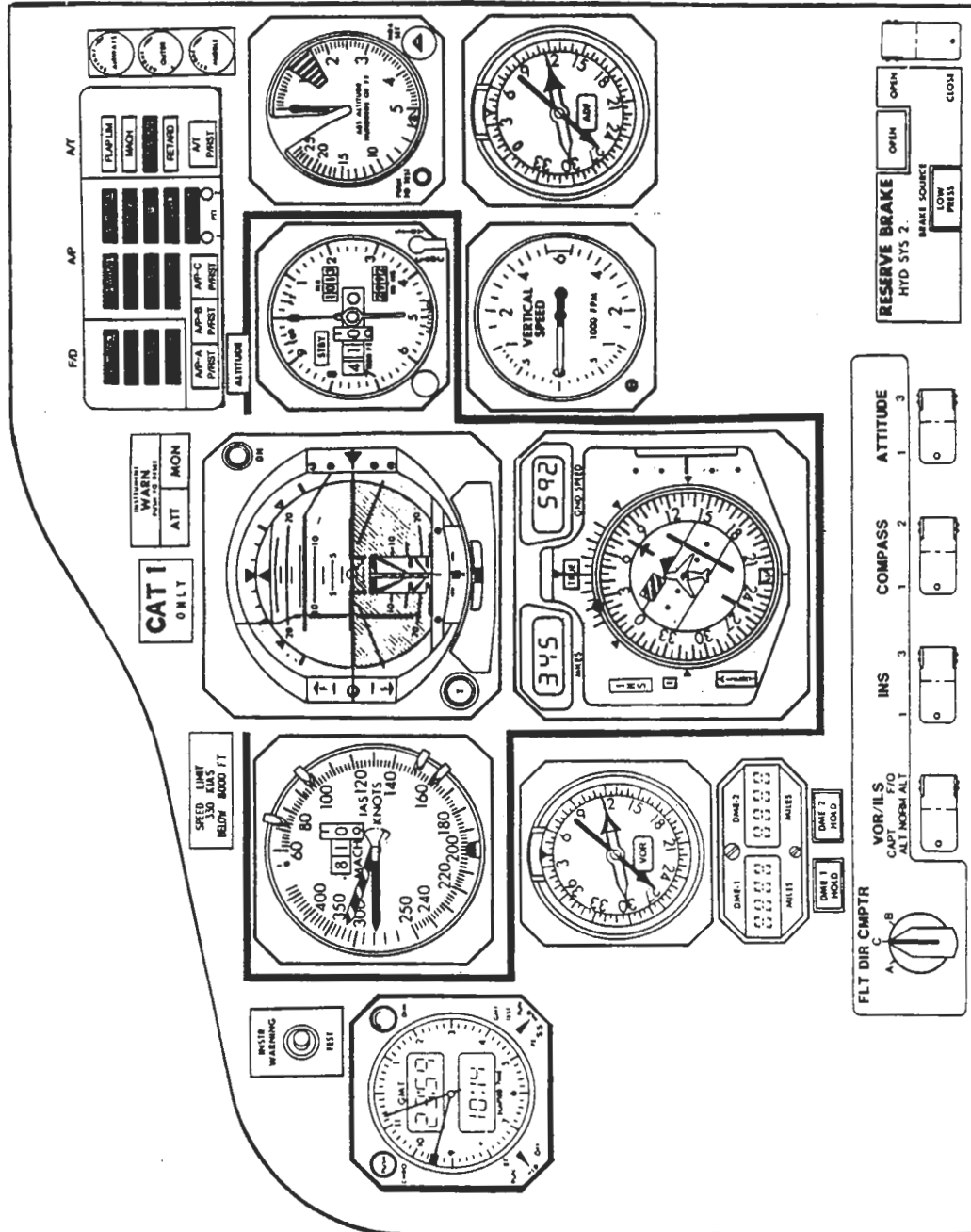

CAPTAINS' INSTRUMENT PANEL

CF6

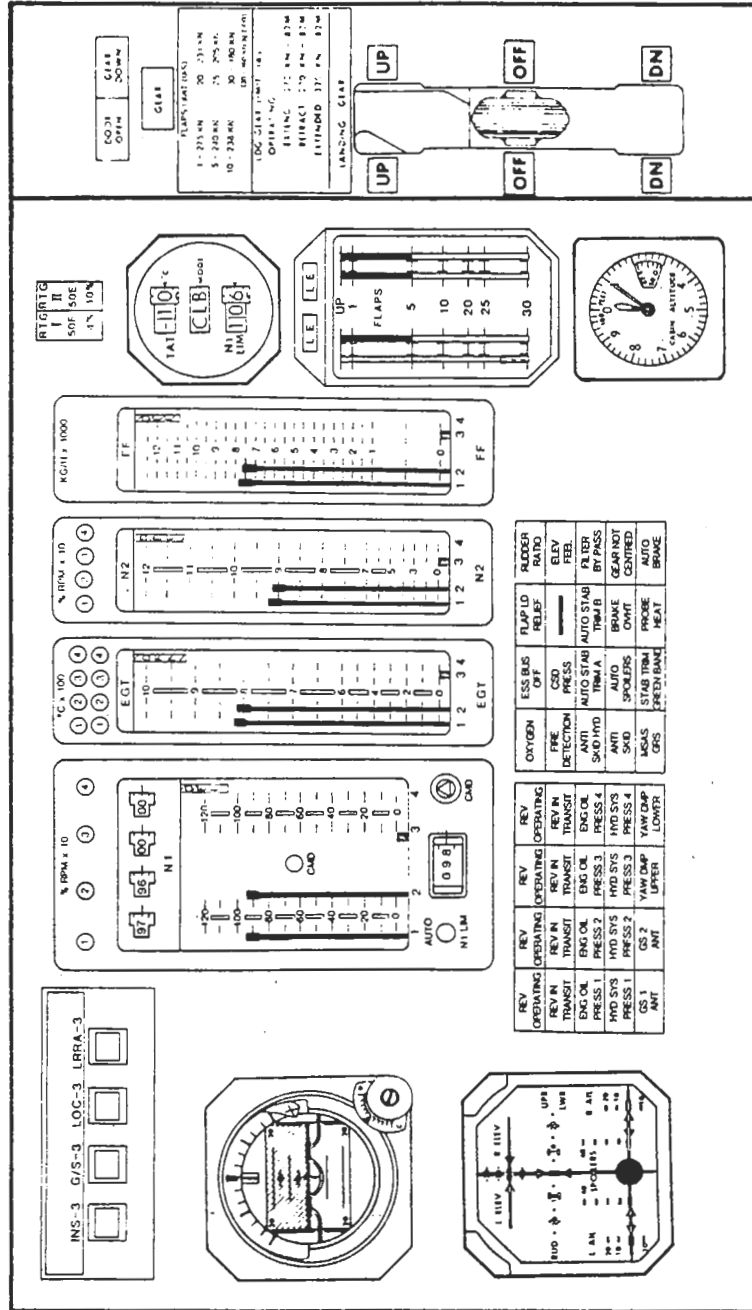

PILOTS' CENTRE INSTRUMENT PANEL

BR-9
05.20.14B

CF6

Jul 24/85

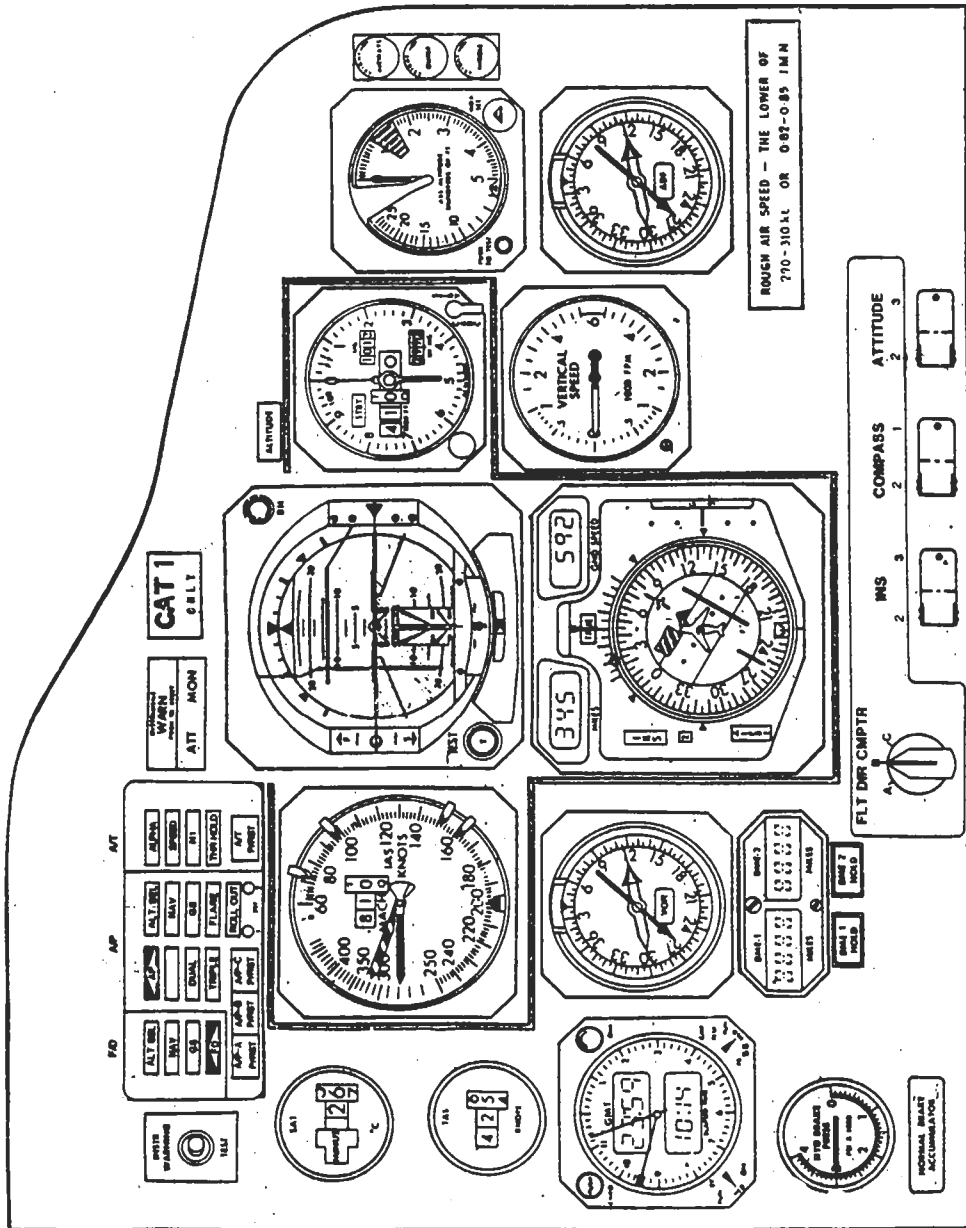

FIRST OFFICERS' INSTRUMENT PANEL

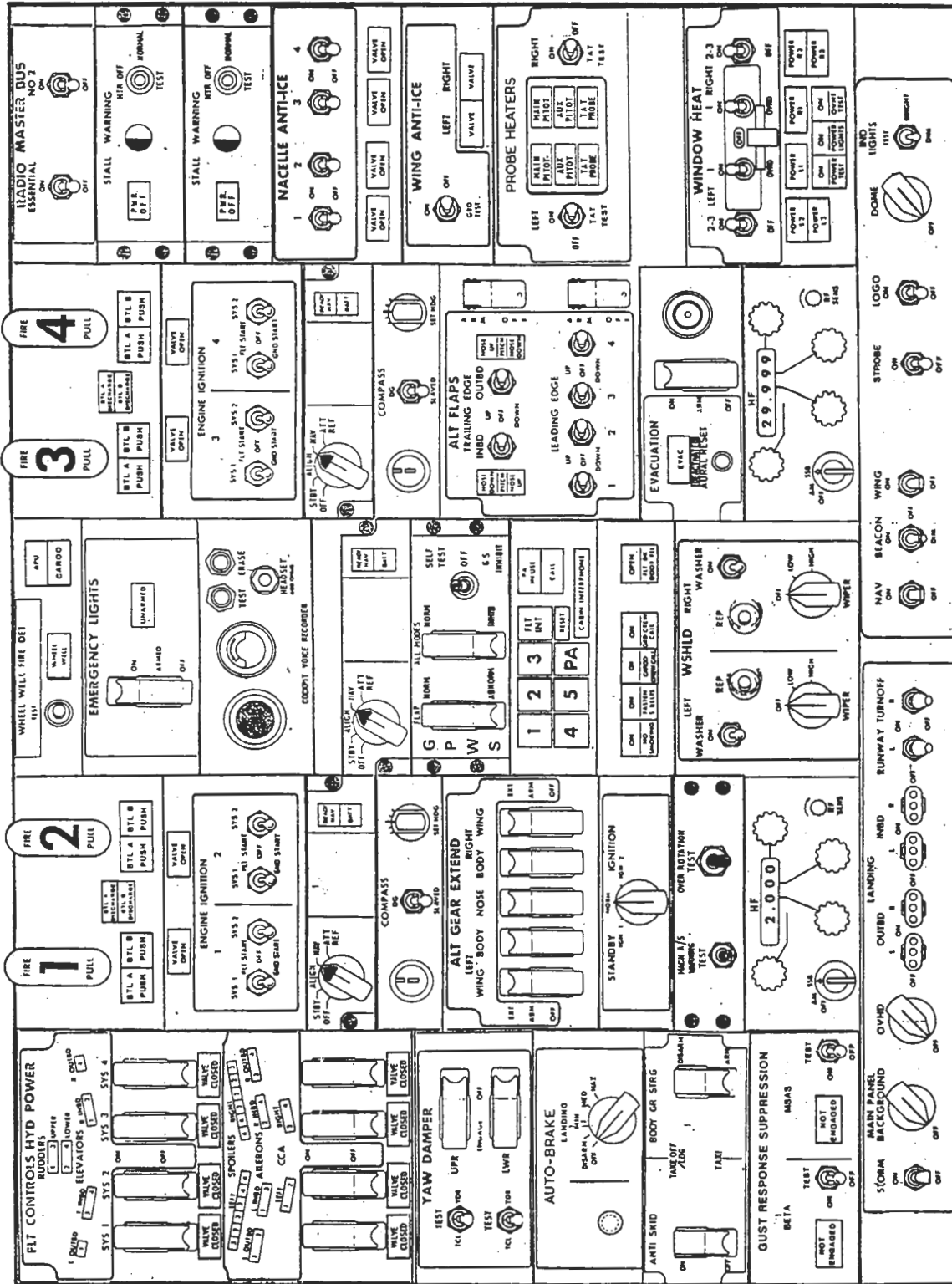

BR-9
05.20.14D

PILOTS' OVERHEAD PANEL

Jul 24/85

CF6

AIRPLANE GENERAL
COCKPIT PANELS

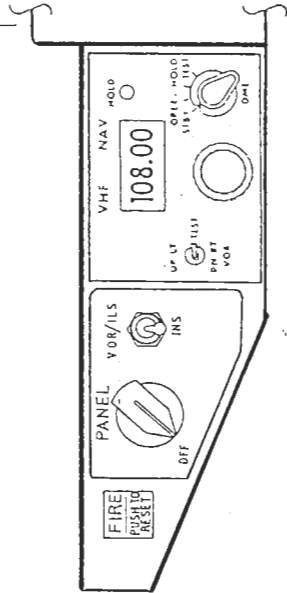
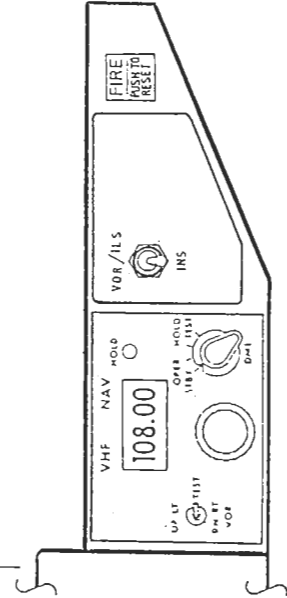
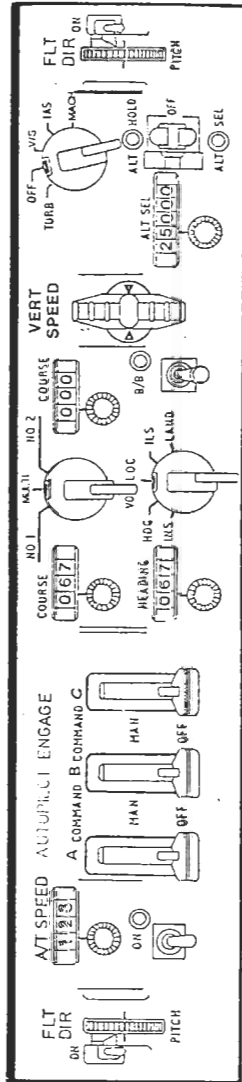

PILOTS' LIGHTSHIELD

AIRPLANE GENERAL
COCKPIT PANELS

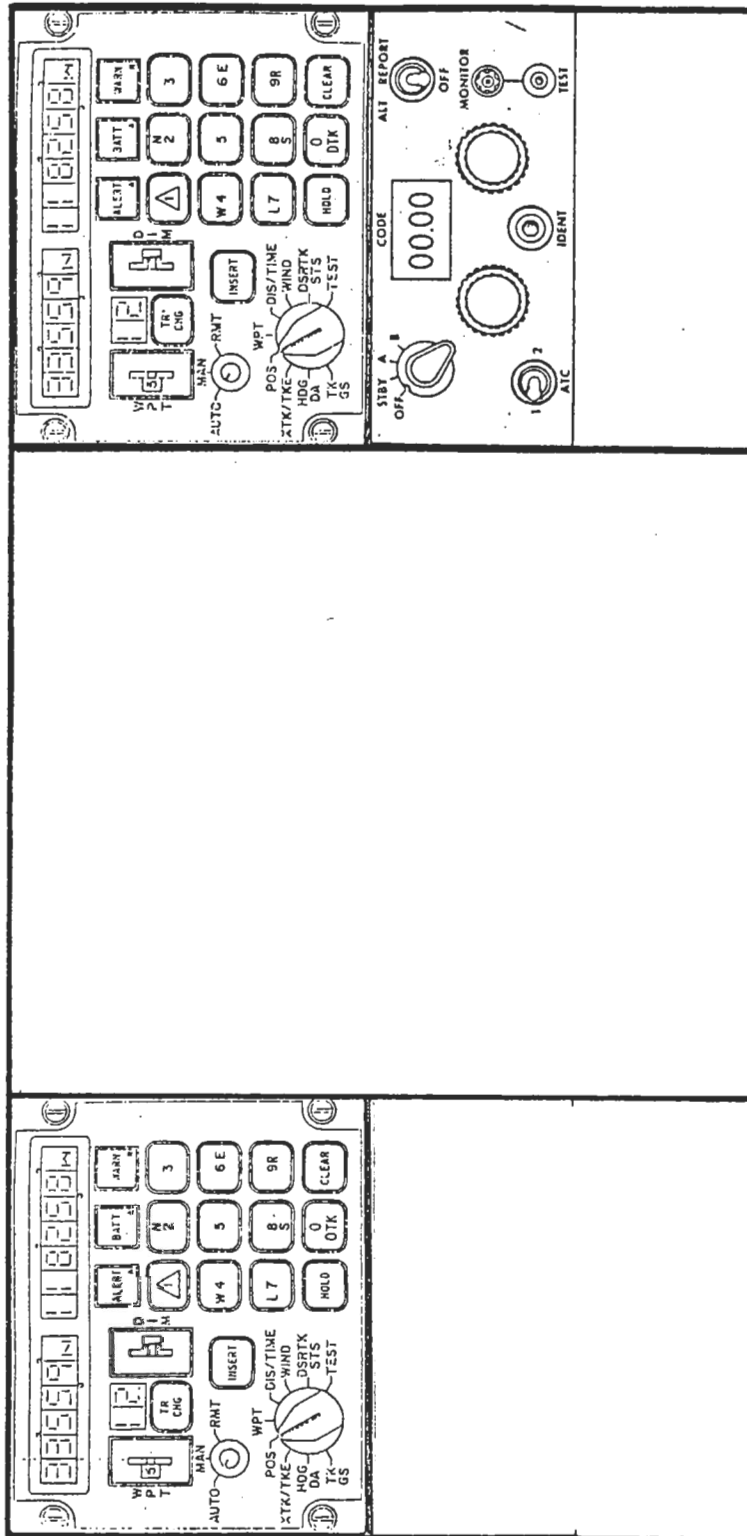

FORWARD ELECTRONICS PANEL

BR-9
05.20.14F

CF6

Jul 24/85

AIRPLANE GENERAL
COCKPIT PANELS

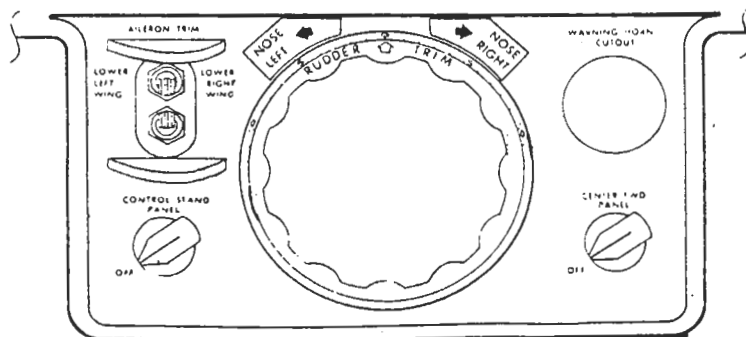
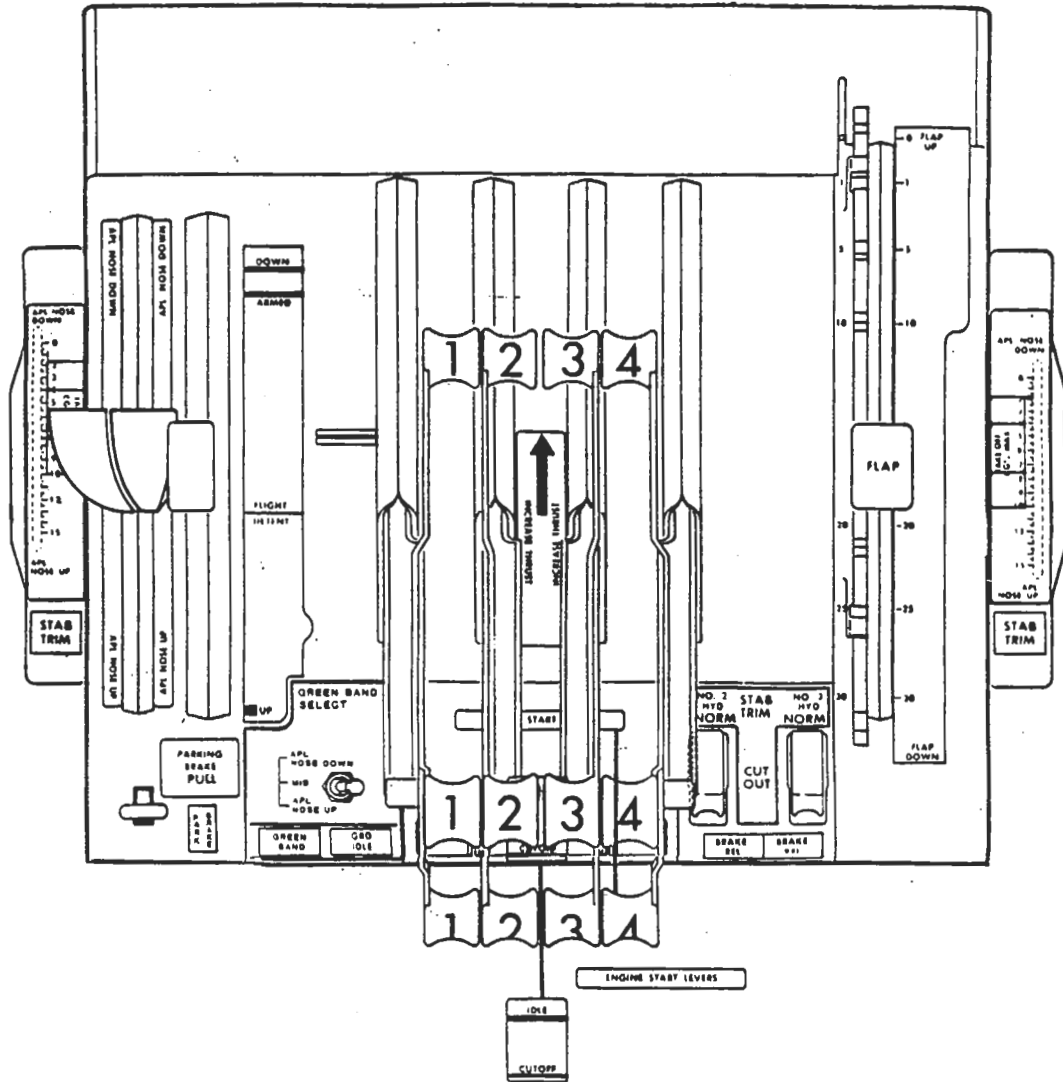

AIRPLANE GENERAL,
COCKPIT PANELS

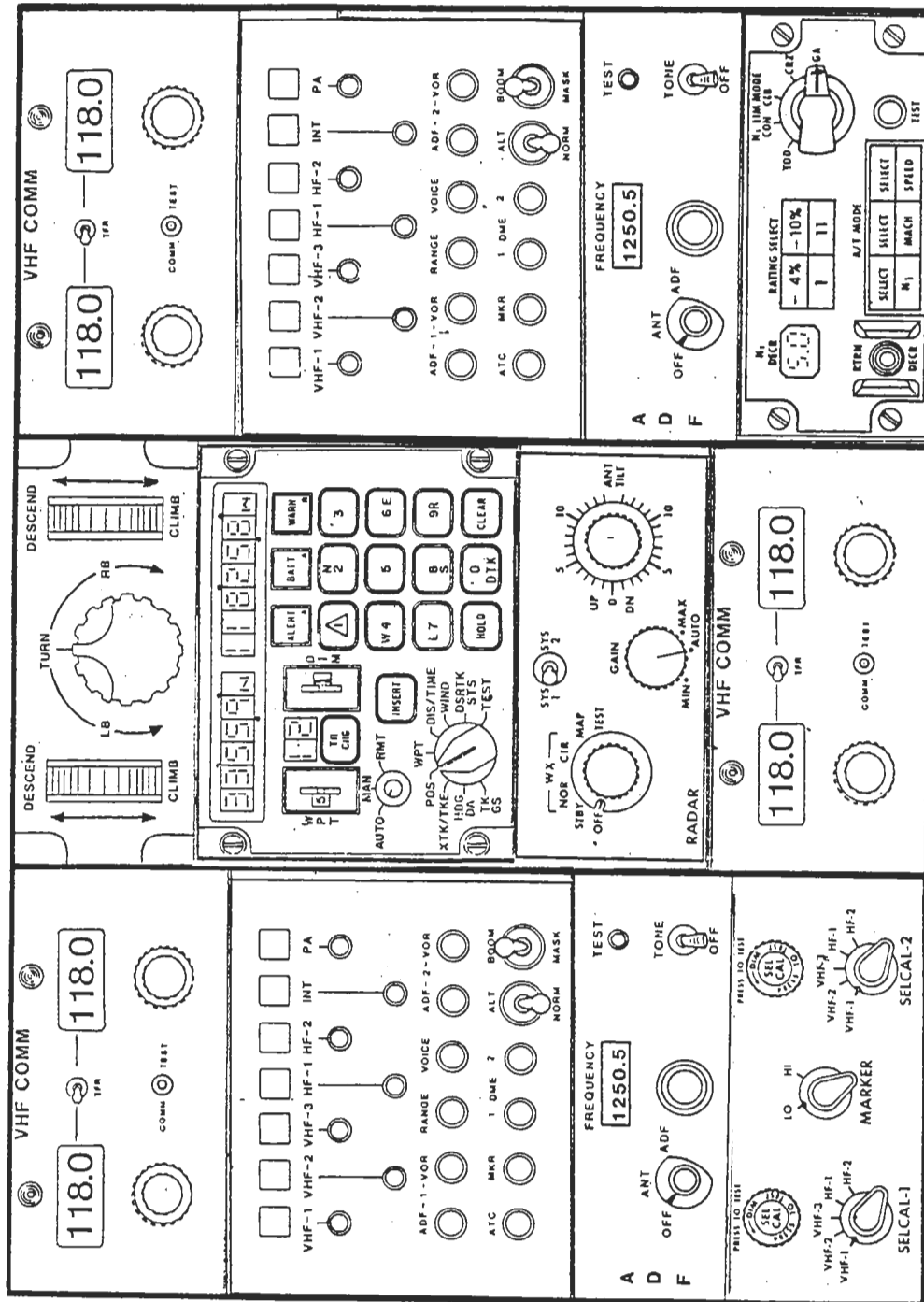

AFT ELECTRONICS PANEL

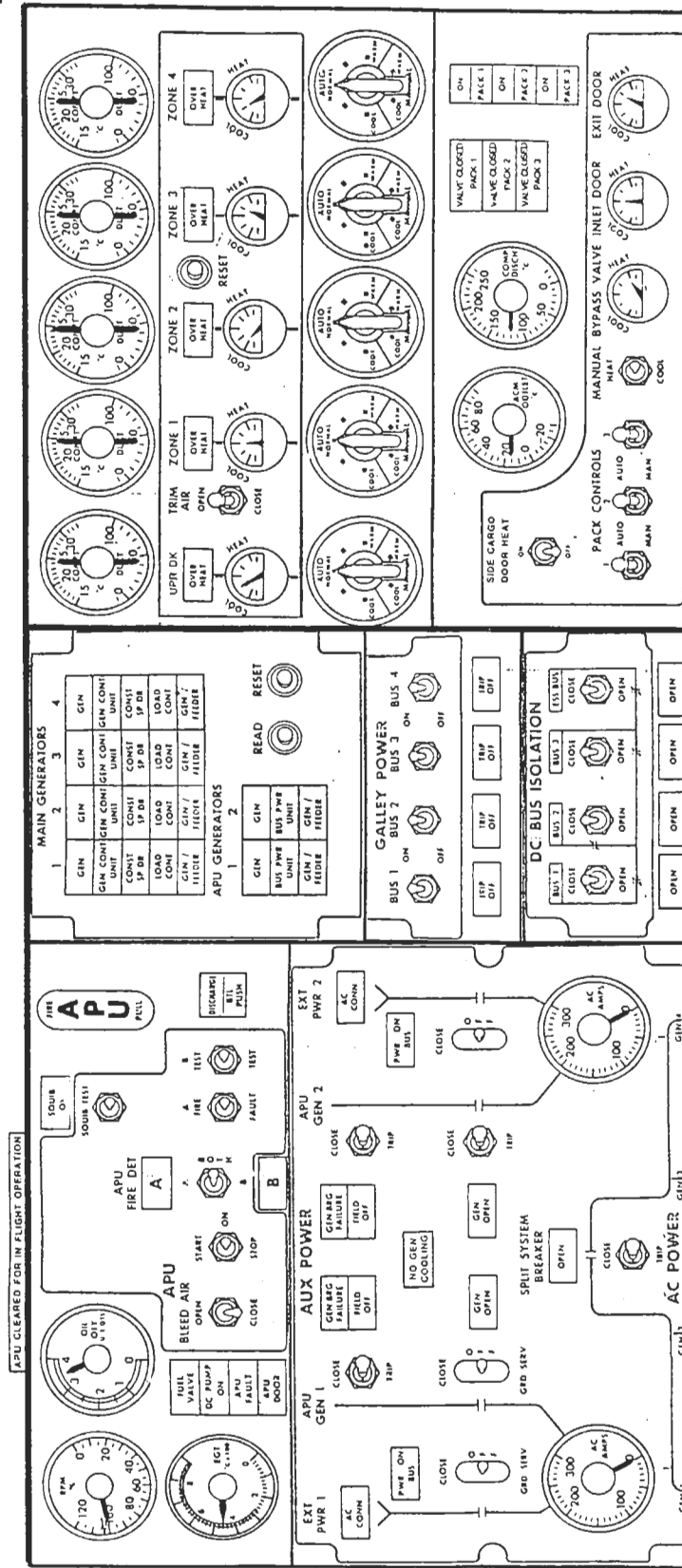

FLIGHT ENGINEERS' INSTRUMENT PANEL

PART UPPER PANEL LEFT

AIRPLANE GENERAL
COCKPIT PANELS

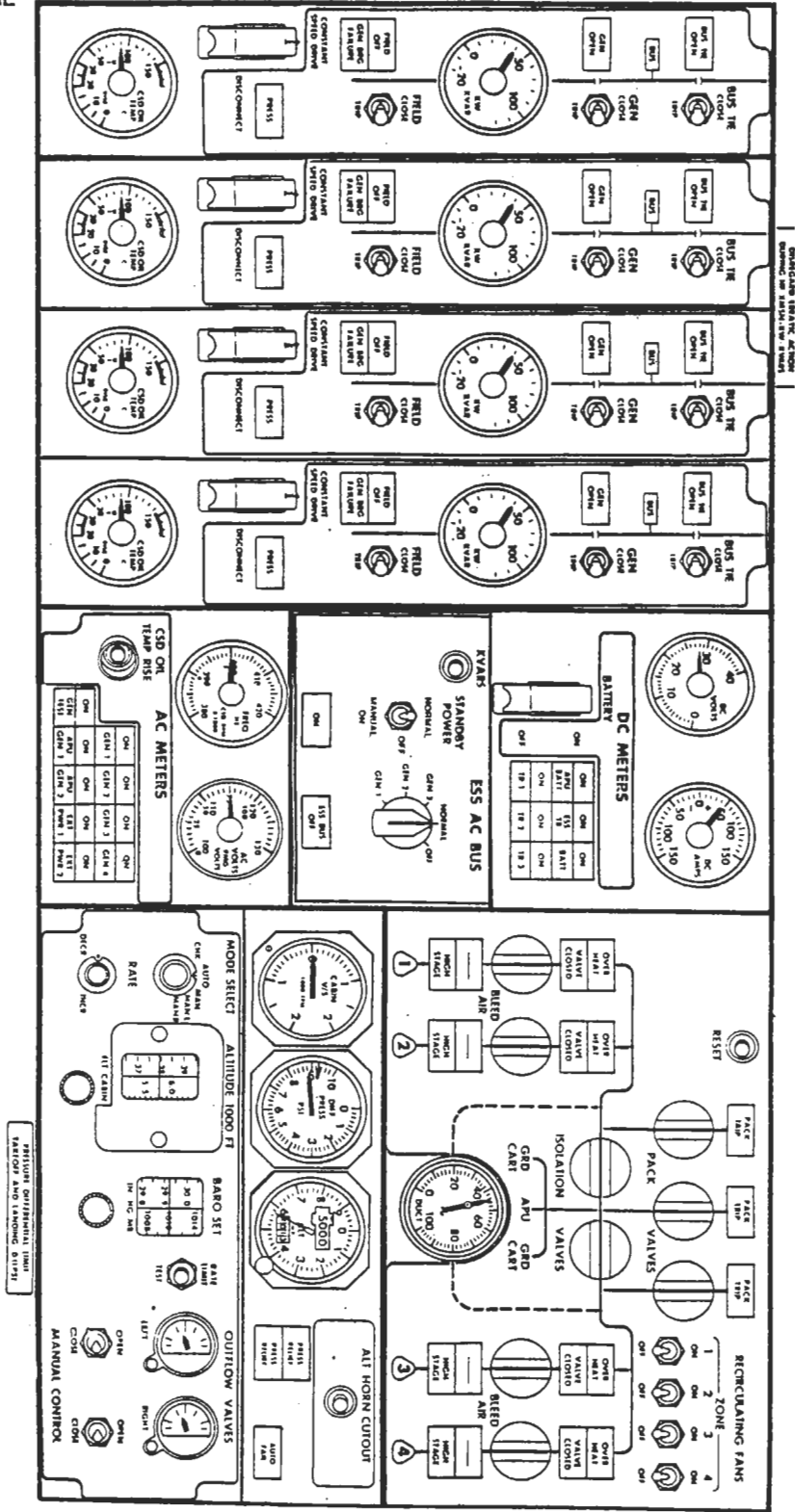

FLIGHT ENGINEERS' INSTRUMENT PANEL

PART UPPER PANEL LEFT

BR-9
05.20.14J

Jul 24/85

CF6

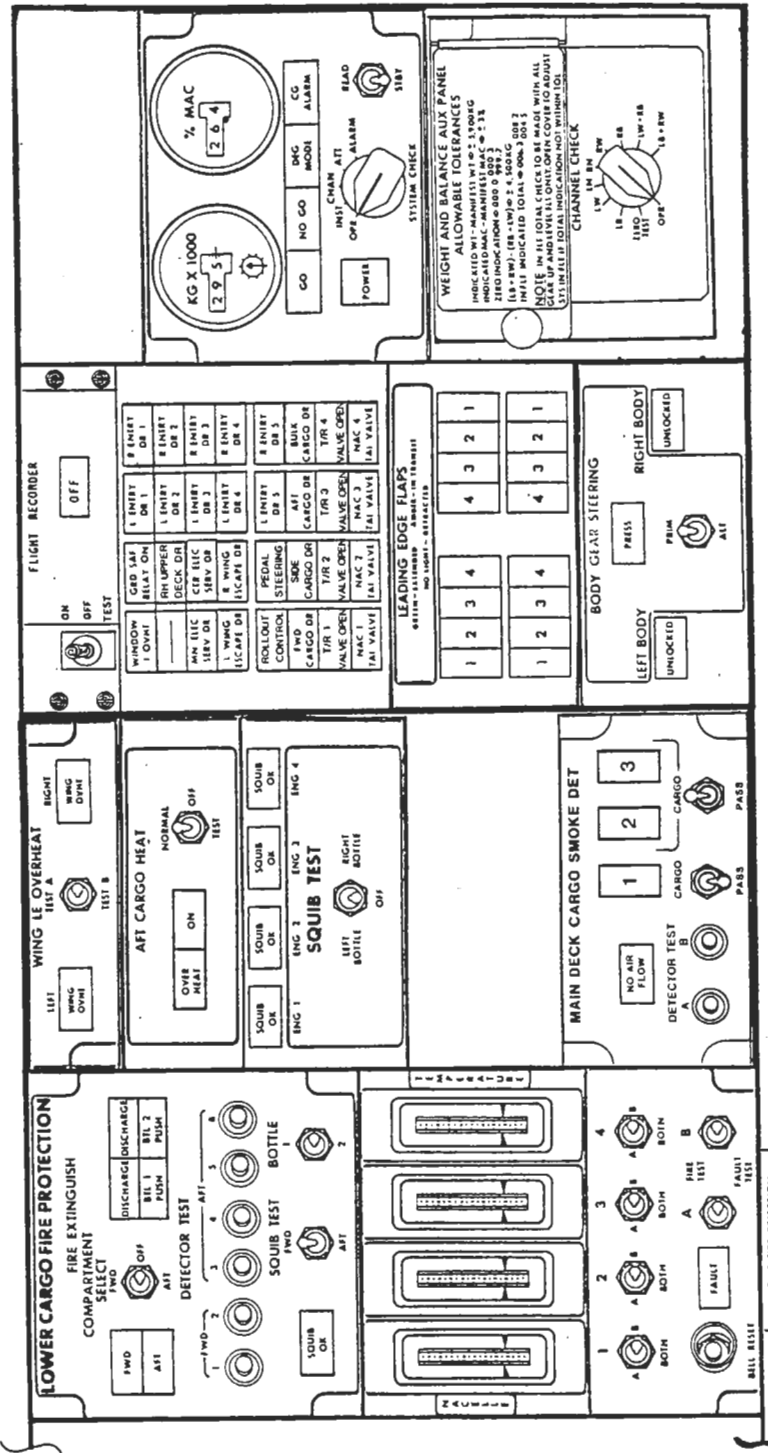

FLIGHT ENGINEERS' INSTRUMENT PANEL

PART UPPER PANEL RIGHT

CF6

AIRPLANE GENERAL
COCKPIT PANELS

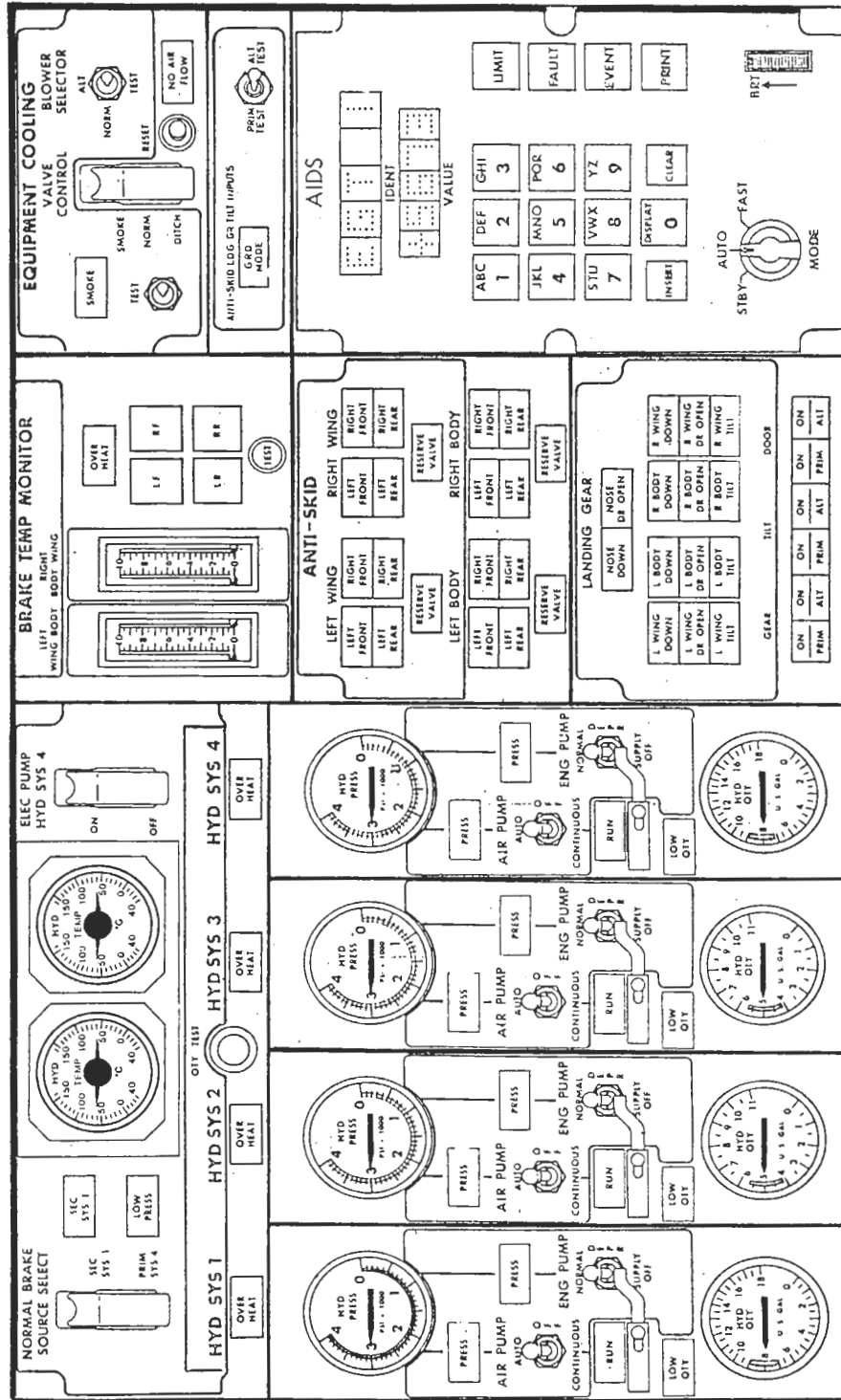

FLIGHT ENGINEERS' INSTRUMENT PANEL

PART UPPER PANEL RIGHT

BR-9
05.20.14L

CF6

Jul 24/85

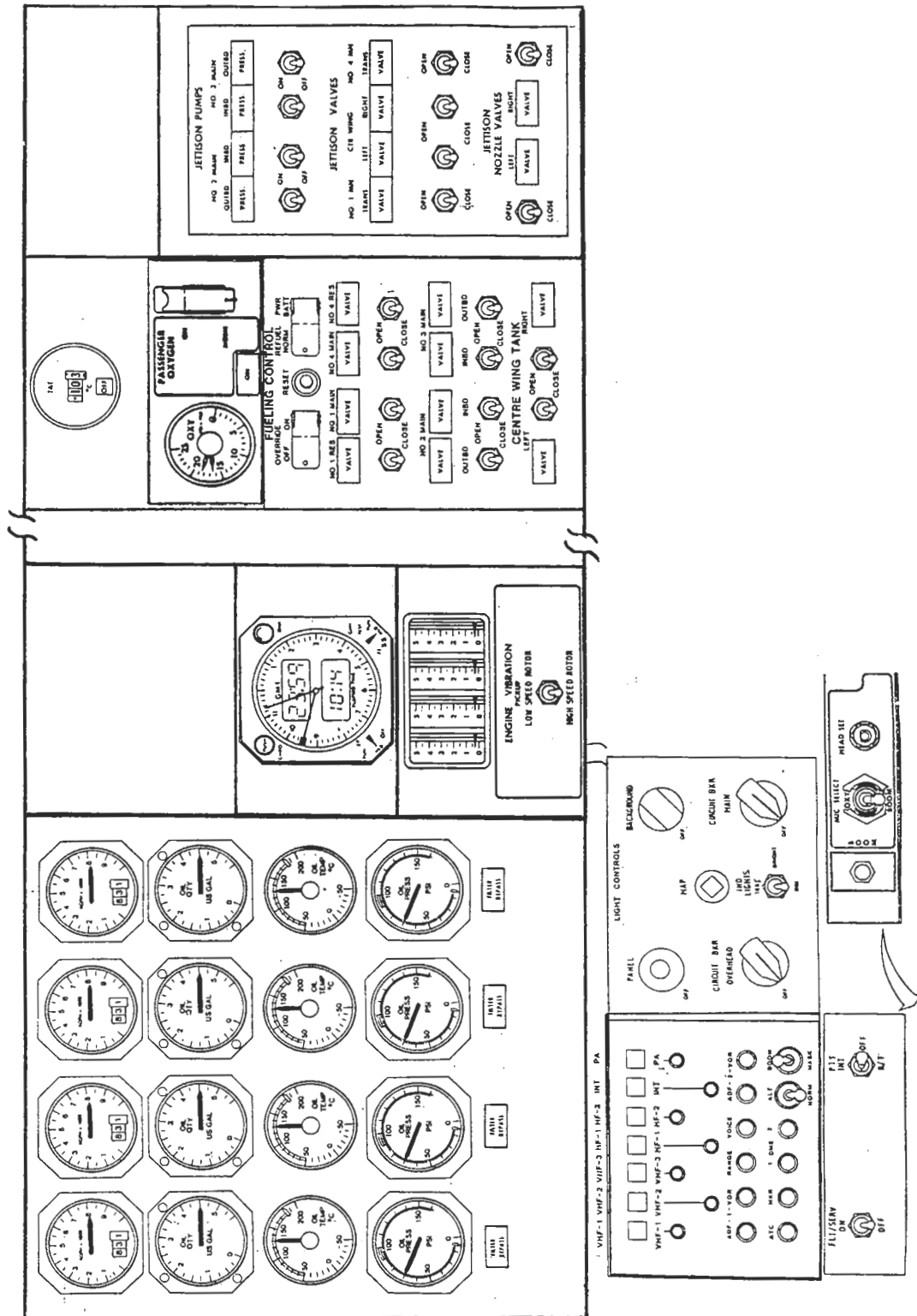

FLIGHT ENGINEERS' INSTRUMENT PANEL

LOWER LEFT AND RIGHT

Jul 24/85

BR-9
05.20.14M

CF6

AIRPLANE GENERAL
COCKPIT PANELS

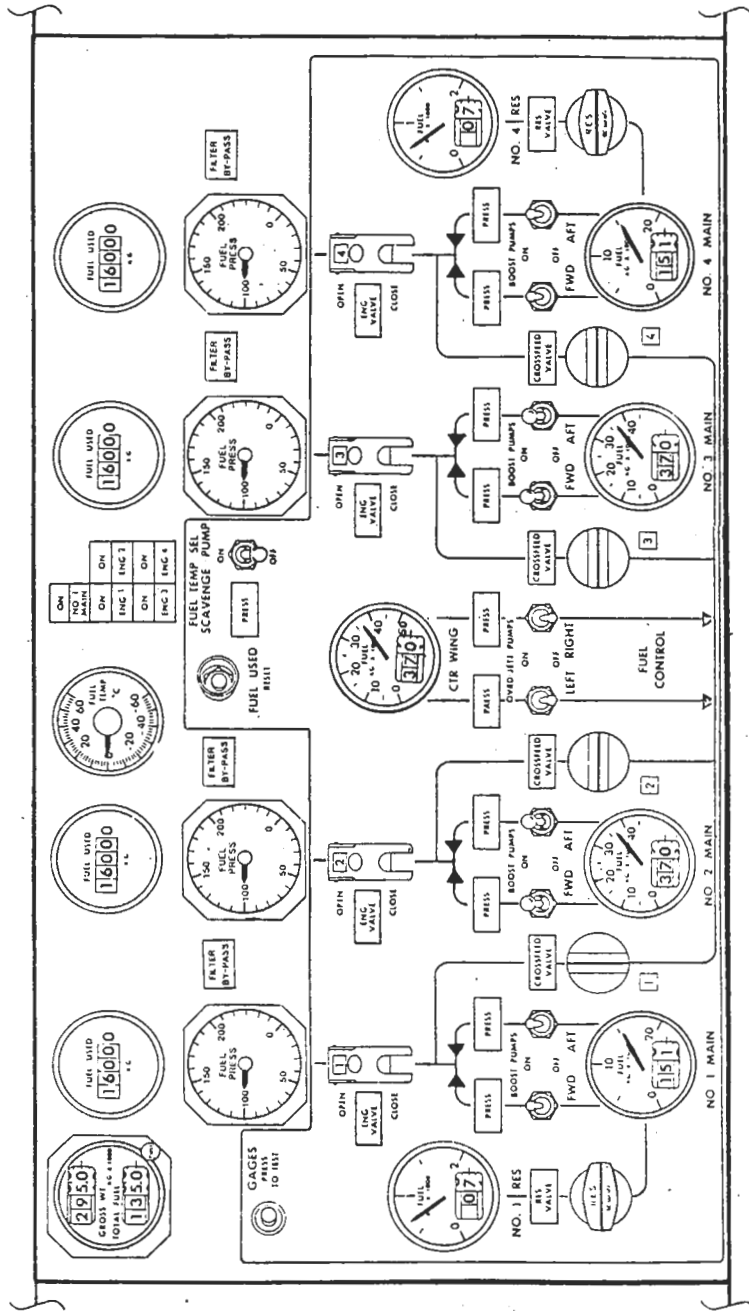

FLIGHT ENGINEERS' INSTRUMENT PANEL

LOWER PANEL CENTRE

BR-9
05.20.14N

CF6

Jul 24/85

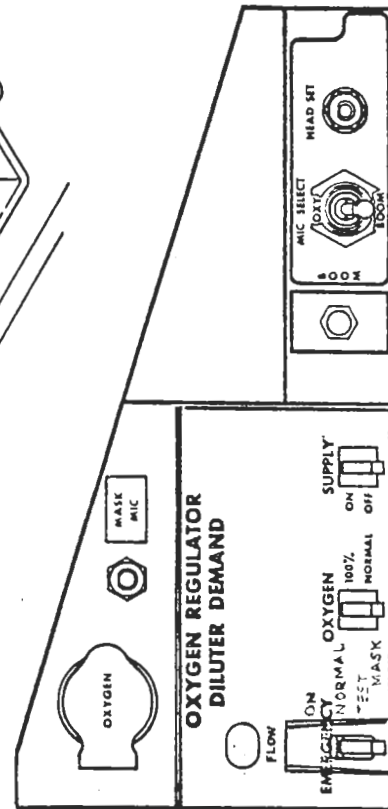
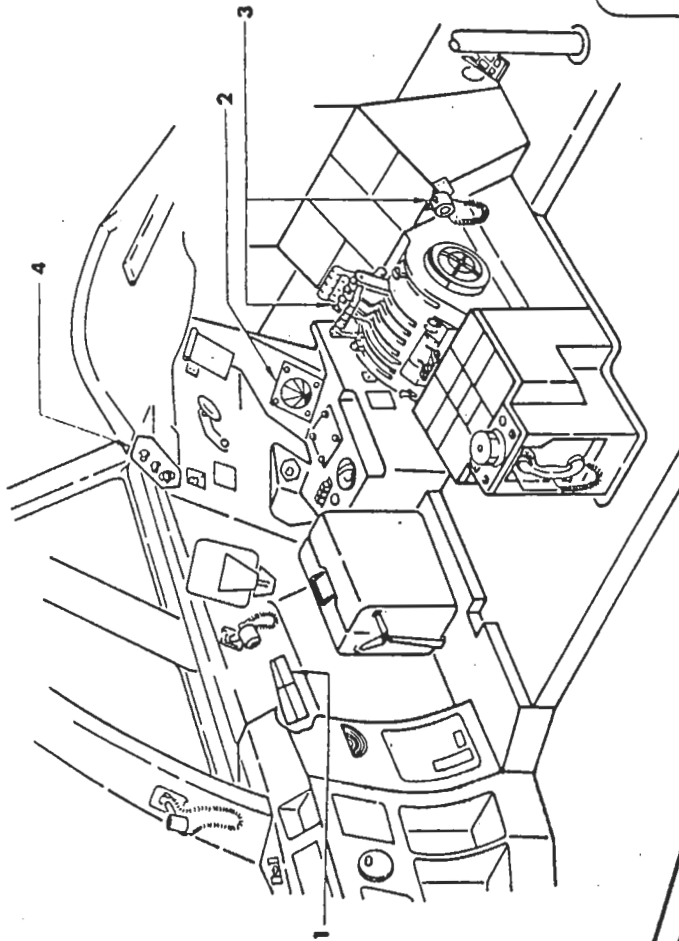
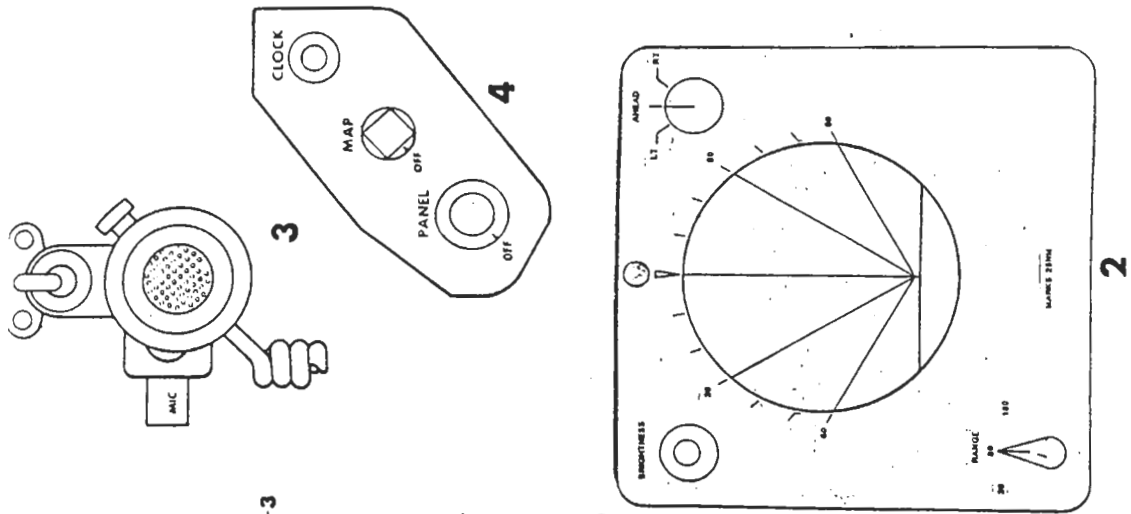

CAPTAIN'S AUXILIARY PANEL

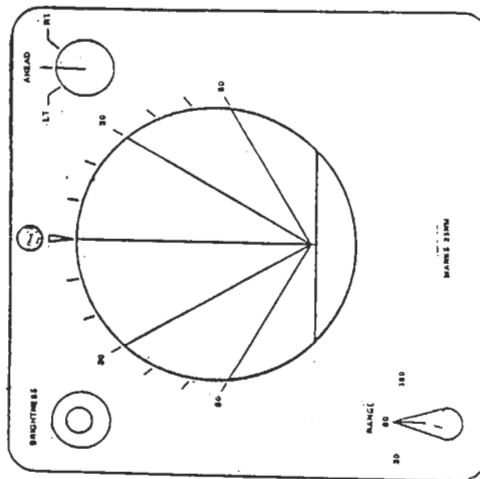
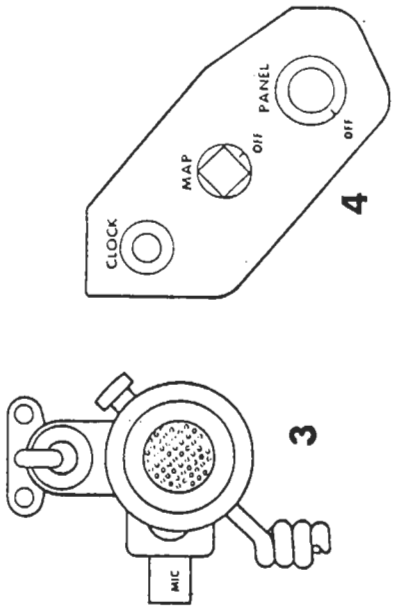
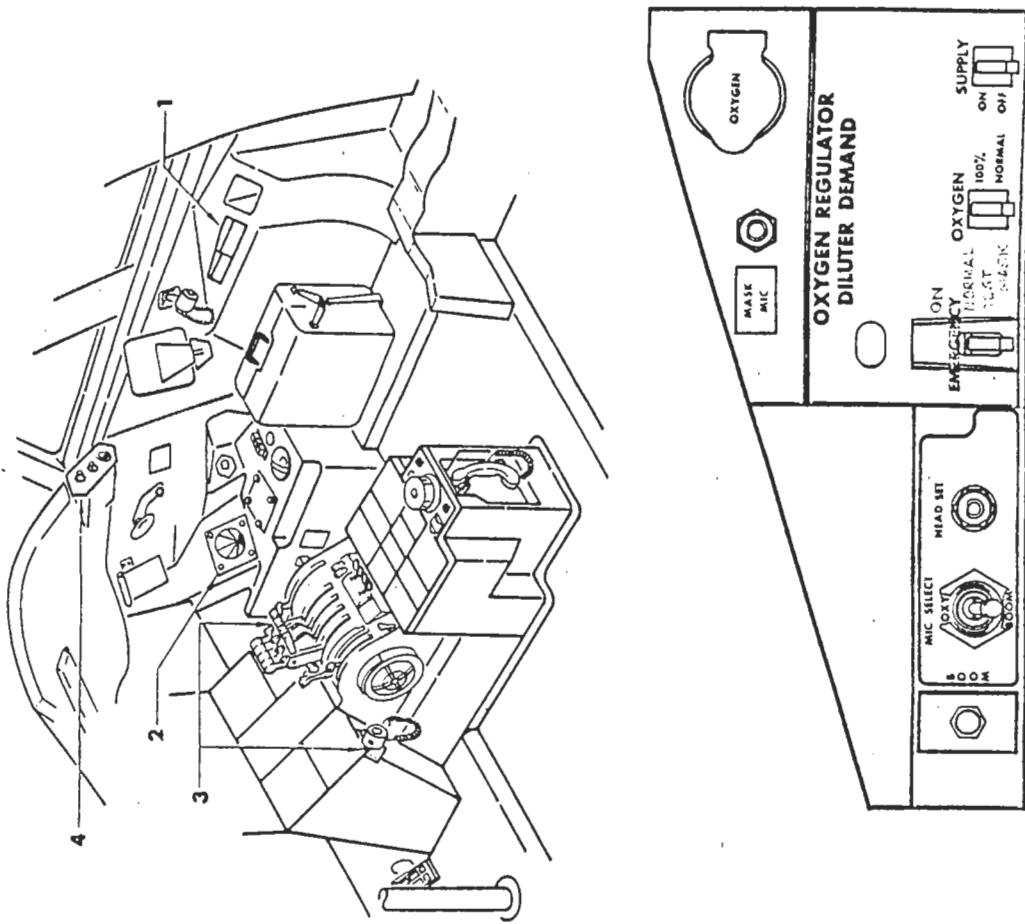

- | | |
|-------------------------------------|---|
| P1 - CAPTAIN'S INSTRUMENT | P12 - ELECTRICAL CIRCUIT BREAKER |
| P2 - PILOT'S CENTRE INSTRUMENT | P13 - SECOND OBSERVER'S |
| P3 - FIRST OFFICER'S INSTRUMENT | P21 - CAPTAIN'S AUXILIARY - AFT |
| P4 - FLIGHT ENGINEER'S INSTRUMENT | P33 - PILOTS' LANDING GEAR |
| P5 - PILOTS' OVERHEAD | P43 - STANDBY COMPASS |
| P7 - ELECTRONIC CIRCUIT BREAKER | P44 - CAPTAIN'S AUXILIARY - LOWER |
| P8 - CONTROL STAND ELECTRONIC - AFT | P45 - FIRST OFFICER'S AUXILIARY - LOWER |
| P9 - CONTROL STAND ELECTRONIC - FWD | P72 - MAIN INSTRUMENT LIGHTSHIELD |
| P10 - PILOTS' LIGHTSHIELD | |
| P11 - FIRST OBSERVER'S | |
- 1
- FAIL OPERATIONAL BUS CIRCUIT BREAKERS

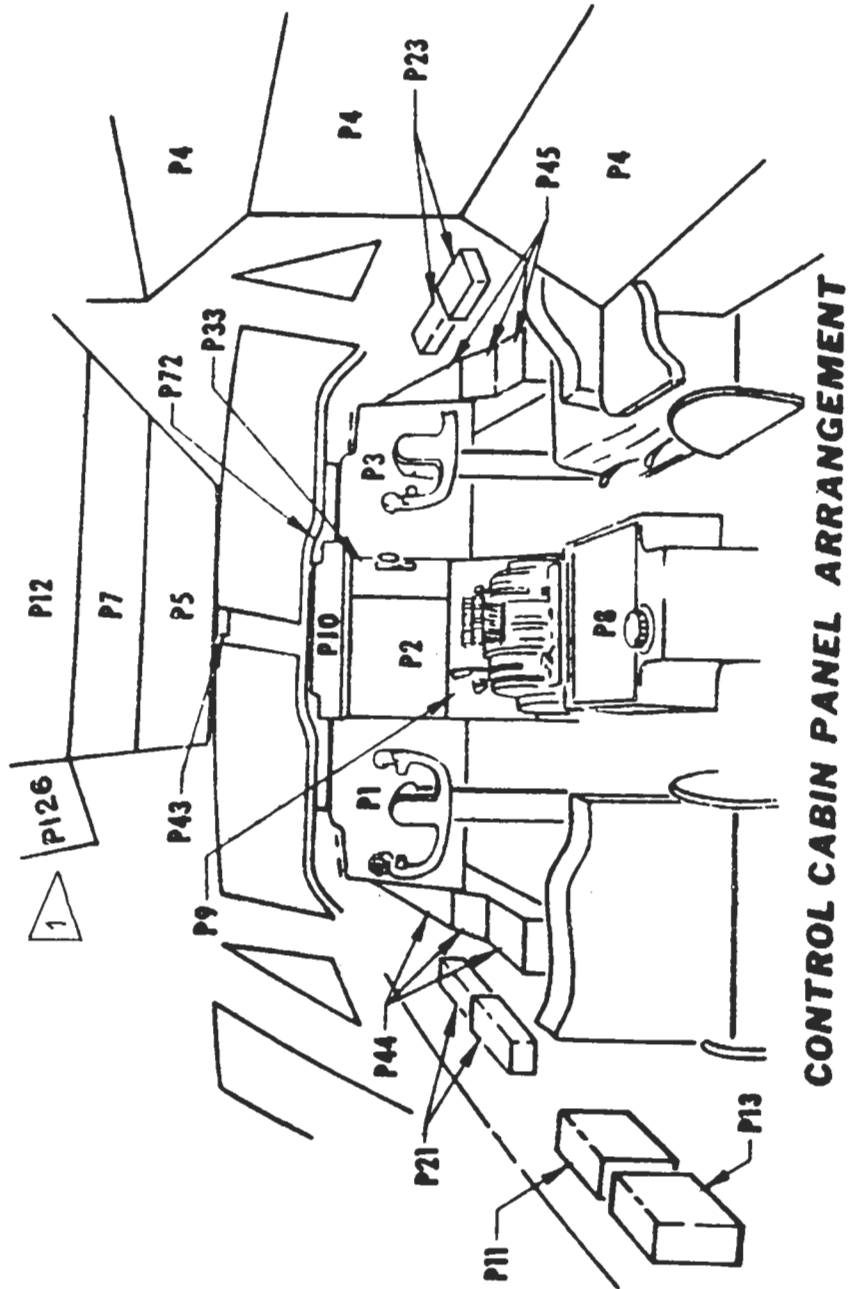

CONTROL CABIN PANEL ARRANGEMENT

AIRPLANE GENERAL
COCKPIT PANELS

- E10 - UPPER EQUIPMENT CENTRE - RIGHT
- P4 - FLIGHT ENGINEER'S UPPER/MIDDLE/LOWER INSTRUMENTS
- P6 - MAIN POWER UPPER/MIDDLE/LOWER/AFT OUTBOARD
- P52 - CONTROL CABIN EQUIPMENT PANEL

**FLIGHT ENGINEER'S
PANELS & EQUIPMENT**

