

zone v

SIMPLIFY YOUR SMARTPHONE™

Quick Start Guide

The Zone V case and software has been designed for the Samsung Galaxy A3 2016.

Please refer to your Samsung Quick Start Guide and User Manual for detailed information on your Samsung device. Please note you may incur additional charges for accessing the internet from your device.

The Zone V product box contains the following items:

- Case with a square grip and loop grip options
- POLAR:MAG[®] USB cable
- Headset jack adapter
- Software voucher
- Quick Start Guide
- Warranty

Case layout

FRONT

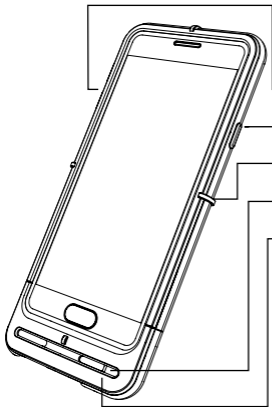

Volume key

Power key

Tactile markers

Loud speaker

Microphone

BACK

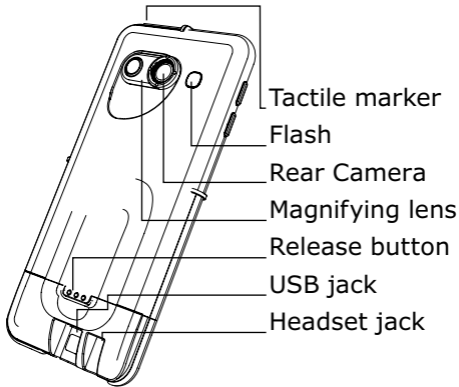

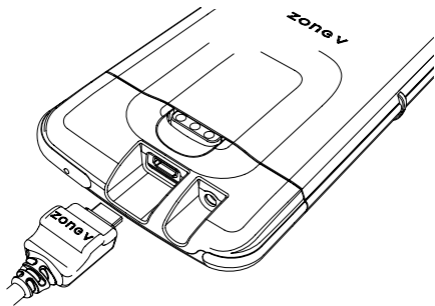

POLAR:MAG® USB cable

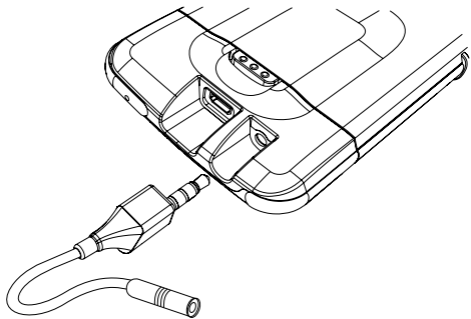

Headset jack adapter

Tips on how to interact with your Samsung device

When using a smartphone, there are a number of actions known as gestures that you need to familiarise yourself with to aid in your use and enjoyment of your Samsung device.



Tap your devices screen to enter an application, complete an action, activating an on/off switch or entering letters using the keyboard.



When accessing the S.O.S. app from your devices locked screen, **double tap** ⊕ to enter the application.

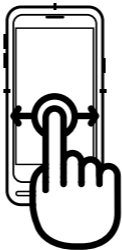

Using your index finger **swipe** to the left or right such as when using the Gallery.



When in standard, light or dark mode, place one finger on the screen and move your finger up and down the screen to **scroll** through a list of information.

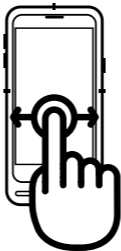

Using your index finger **tap and drag** the icon in the direction of the arrows such as when answering or rejecting a call.

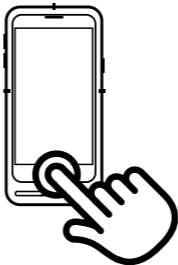

Press your devices home button to return to the home screen from any application.



The **home screen** of the Zone V software is colour coded and split into zones throughout the user interface.

Battery

Network

Widgets

Applications

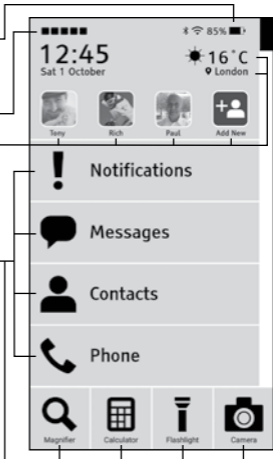

Battery: Indicates the remaining charge on your Samsung devices battery.

Network: Indicates the strength of your service providers signal.

Widgets: Are information items that are found on the home screen and can turned on or off. Examples: clock, date, weather, location and quick contacts.

Applications: Items listed on the home screen which when tapped take you to a specific function.

Installing the SIM

Please refer to your Samsung Quick Start Guide and User Manual for detailed information on installing your SIM card into your Samsung device.

Inserting your device into the Zone V case

The case comes with a square grip or loop grip which are interchangeable.

To detach the grip from the main body of the case, depress the release button on the back and pull the detachable grip towards you.

You are now ready to slide your Samsung device into the case. To attach the grip, align with the bottom of your device and gently slide it into the main case and push together until you hear an audible click.

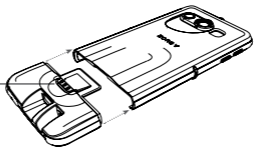

Release button

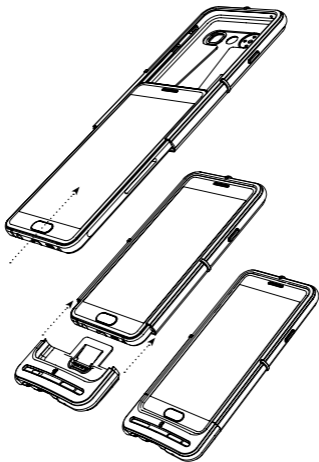

Zone V easy charging USB cable

The Zone V POLAR:MAG® USB cable has a small magnet incorporated into the design to enable easy connection to the USB jack on your Samsung device. The magnet prevents the cable being plugged in upside down.

Insert the large end of the cable into your Samsung USB power adapter and the smaller end of the cable with the Zone V logo into the USB jack on your Samsung device.

Place the Samsung USB power adapter ensuring the appropriate adapter for your country has been selected into your power source. Your phone

is now ready to be charged.

Please refer to your Samsung Quick Start Guide and User Manual for detailed information on charging the battery on your Samsung device.

Zone V headset jack adapter

Insert the Samsung headset into the adapter and then into your devices headset jack.

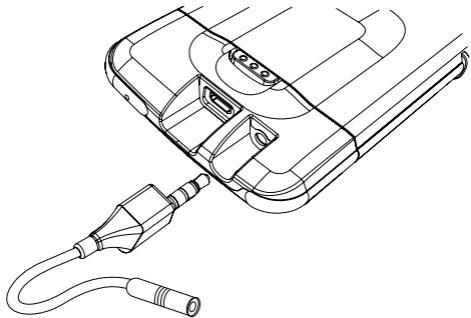

Transferring data from your previous device

Please refer to your Samsung Quick Start Guide and User Manual for detailed information on how to transfer data from your previous device to your Samsung device.

Setting up and connecting to a Wi-Fi network to access the internet

From the home screen:

-
- 1.** Scroll down to Settings
 - 2.** Tap Settings
 - 3.** Under Connections, tap the Wi-Fi on/off switch to the on position to activate

- 4.** Tap Wi-Fi to access the Wi-Fi network list
- 5.** Tap your selected network
- 6.** Enter the password if applicable
- 7.** Tap done on the keyboard
- 8.** Tap connect

Please note you may incur additional charges for accessing the internet from your Samsung device.

Selecting a visual profile

The Zone V software offers three visual profiles which have each been designed to give optimal contrast and clarity.

The profiles are Standard, Light and Dark.

*For a detailed description of
each profile, please refer to the
Zone V User Manual,
**zonev.com/
support#documentation***

From the home screen:



.....

- 1.** Scroll down to Settings
- 2.** Tap Settings
- 3.** Scroll down to Device
- 4.** Tap Visual profiles
- 5.** Tap your preferred profile:
Standard (the default), Light
or Dark
- 6.** Tap back

To make a voice call

From the home screen to make a call:

.....

- 1.** Scroll down to Phone
- 2.** Tap Phone
- 3.** Tap in your chosen number
- 4.** Tap the green phone icon  to connect your call
- 5.** Tap the orange end call icon  to end your call

To answer a voice call

From the call screen:

.....

1. Tap answer from the pop up which appears at the top of your device screen

If your device's screen is locked:

.....

1. Drag the green icon  to the right to accept the call

To reject a call

From the call screen:

.....

1. Tap reject, from the pop up which appears at the top of your device screen

If your device's screen is locked:

.....

1. Drag the orange icon  to the left to reject the call

Creating a contact manually

From the home screen:

-
- 1.** Tap Contacts
 - 2.** Tap Add new
 - 3.** Tap Add name
 - 4.** Enter the name and tap Done
 - 5.** Tap Phone numbers
 - 6.** Tap Home and change the description if required. Enter your new text and tap Done

- 7.** Tap Add phone number, enter the number and tap OK
- 8.** Tap OK to return to the contact list

The new contact added notification will appear on the device screen to confirm your new contact has been successfully added.

Please refer to the Zone V User Manual for detailed information on editing contacts, creating a contact from your notifications and call lists,

zonev.com/

support#documentation

How to activate and use the magnifier

When using the magnifier

application, it is recommended you hold the device approx. 3 cm away from the item you are viewing to gain the best magnification results.

From the back of the case:

-
- 1.** Rotate the magnification lens on the back of the case to cover the camera lens







From the home screen:

.....

- 1.** Tap the magnifier icon  on the bottom left of the home screen
- 2.** Hold the device 3cm above the item you are viewing

Note: allow time for the auto-focus function to maximise the image quality

- 3.** Tap  to increase the magnification
- 4.** Tap  to decrease the magnification
- 5.** Tap invert  to invert the colour of the image
- 6.** Tap  to activate the torch in low lighting conditions

Zone V user manual and video tutorials

*To access the full user manual and video tutorials, please visit **zonev.com/support#documentation***

RoHS & WEEE

The Zone V product complies to RoHS 2011/65/EU and WEEE

2012/19/EU directives.

CE Declaration of conformity

The Zone V POLAR:MAG® USB cable and headset jack adapter complies to the Electromagnetic Compatibility 2014/30/EU directive.

To view the conformance certificates, please visit
zonev.com/conformance

Recycling



Disposal of product

Electronic accessories such as the POLAR:MAG® USB cable and the headset jack adapter should not be disposed of with household waste. Please refer to your local re-cycling centre for collection facilities.

Copyright and patents

Copyright © 2016 Zone V Limited. All rights reserved. No part of this document can be reproduced in any form or by any means without prior written permission of Zone V Limited. Zone V Limited reserves the right to revise this document without prior notice. US patent application No. 14/408,190;

further patents pending.
Registered designs pending.

Trademarks

Zone V, simplify Your
Smartphone, Communicate
Your Way and State of the Art
Simplicity are trademarks of
Zone V Limited. POLAR:MAG®
is a registered trademark of
Zone V Limited. SAMSUNG

and the SAMSUNG logo are registered trademarks of Samsung Electronics. Bluetooth® is a registered trademark of Bluetooth SIG, Inc. Wi-Fi® is a registered trademark of the Wi-Fi Alliance. All other trademarks and copyrights are the property of their respective owners.

www.zonev.com

400-004-003 y3