

COCKPIT LOCATIONS

- P 1 - C/M-1 instrument panel
- P 2 - Center instrument panel
- P 3 - C/M-2 instrument panel
- P 4 - C/M-3 instrument panel
- P 5 - Pilots' overhead panel
- P 6 - Main power circuit breaker panel
- P 7 - Overhead circuit breaker panel
- P 8 - Pilots' control stand (aft)
- P 9 - Pilots' control stand (fwd)
- P 10 - Pilots' lightshield

- P 11 - First observer's panel
- P 12 - Overhead circuit breaker panel
- P 13 - Second observer's panel
- P 21 - C/M-1 auxiliary panel (aft)
- P 23 - C/M-2 auxiliary panel (aft)
- P 33 - Pilots' landing gear panel
- P 43 - Standby compass panel
- P 44 - C/M-1 auxiliary panel (lwr)
- P 45 - C/M-2 auxiliary panel (lwr)
- P 126 - Overhead lightplate and circuit breaker panel

C/M-1 INSTRUMENT PANEL (P 1)

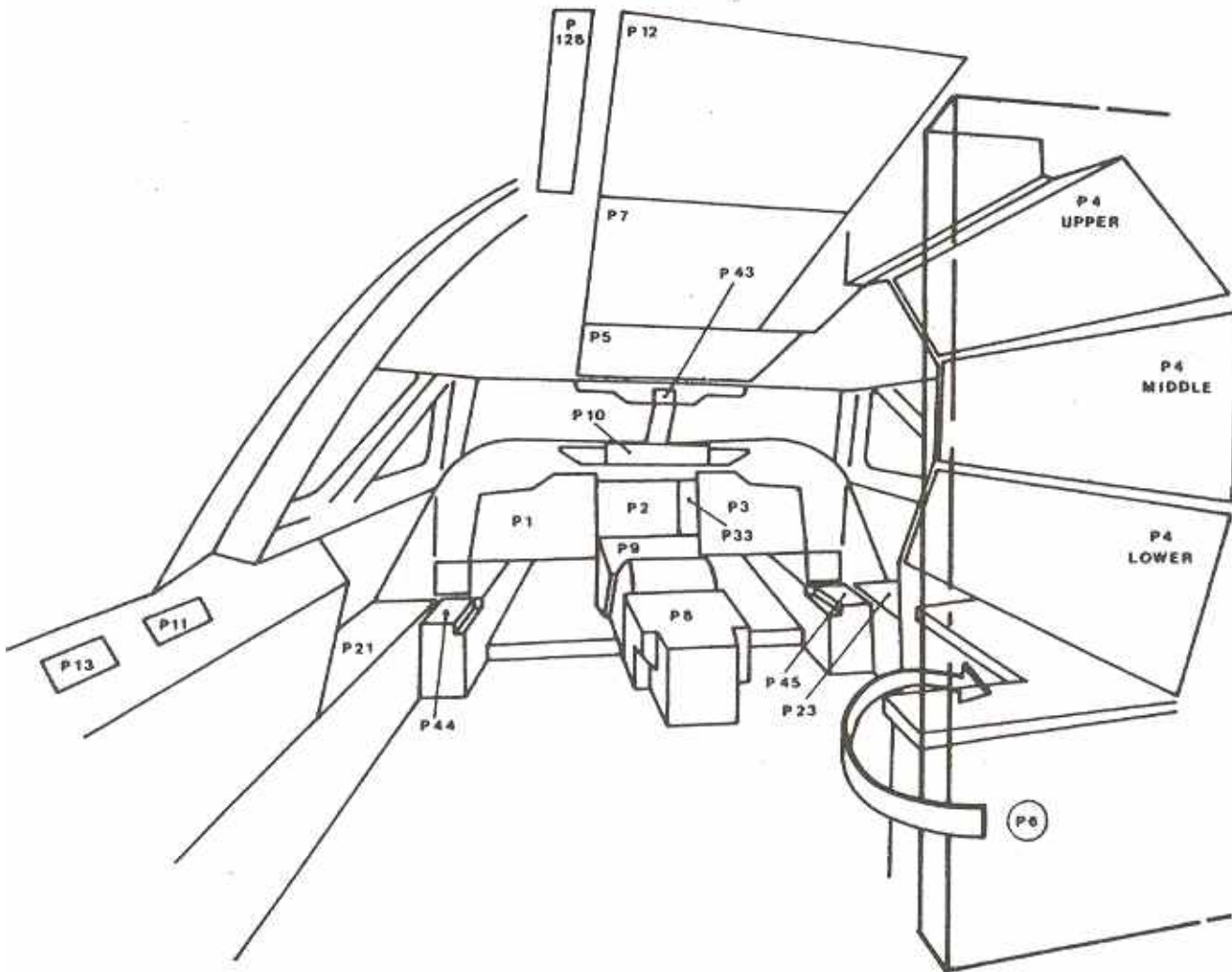
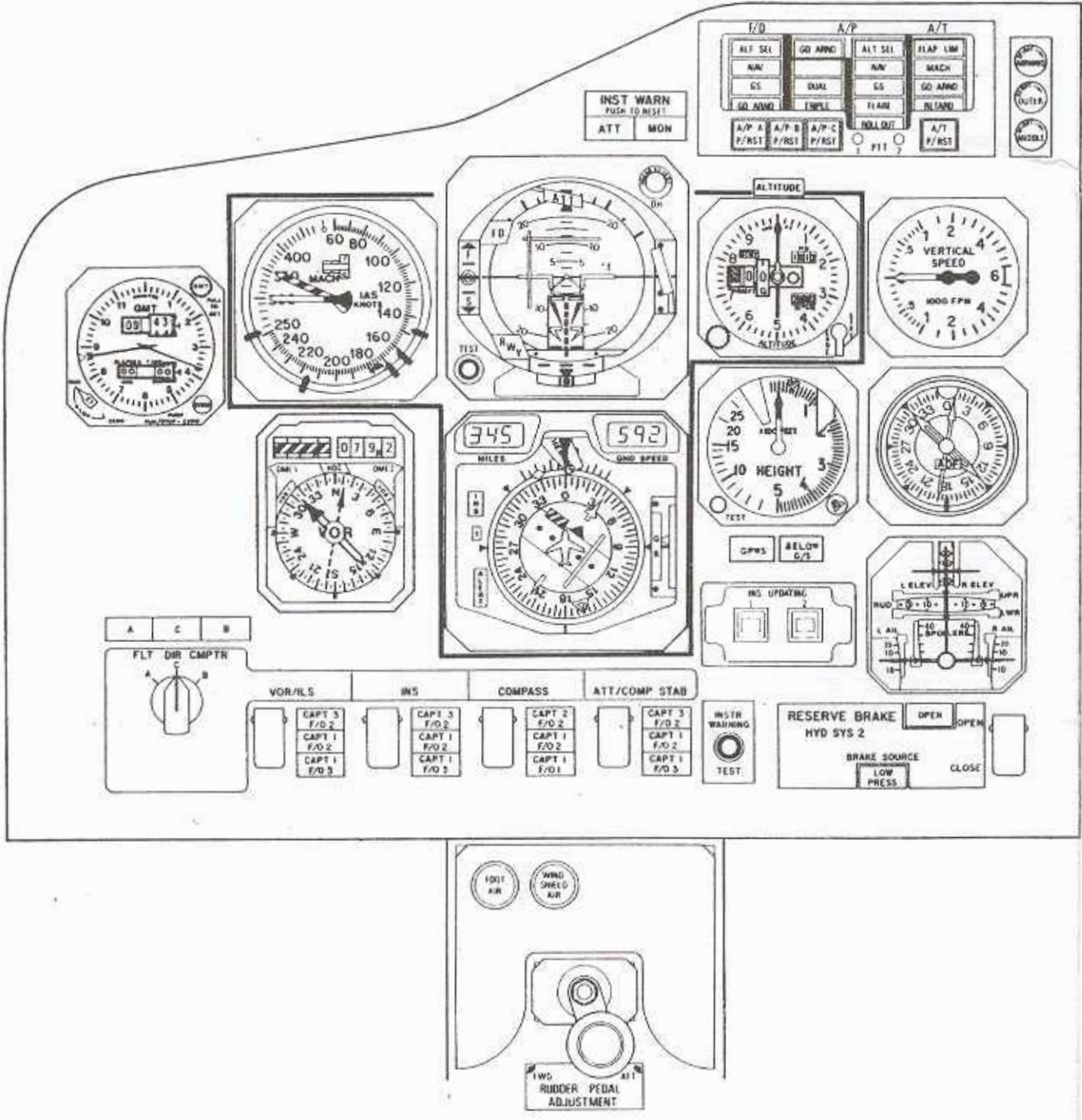

CENTER INSTRUMENT PANEL (P 2/P 33) AND PILOTS' LIGHTSHIELD (P 10)
PILOTS' LIGHTSHIELD (P 10)

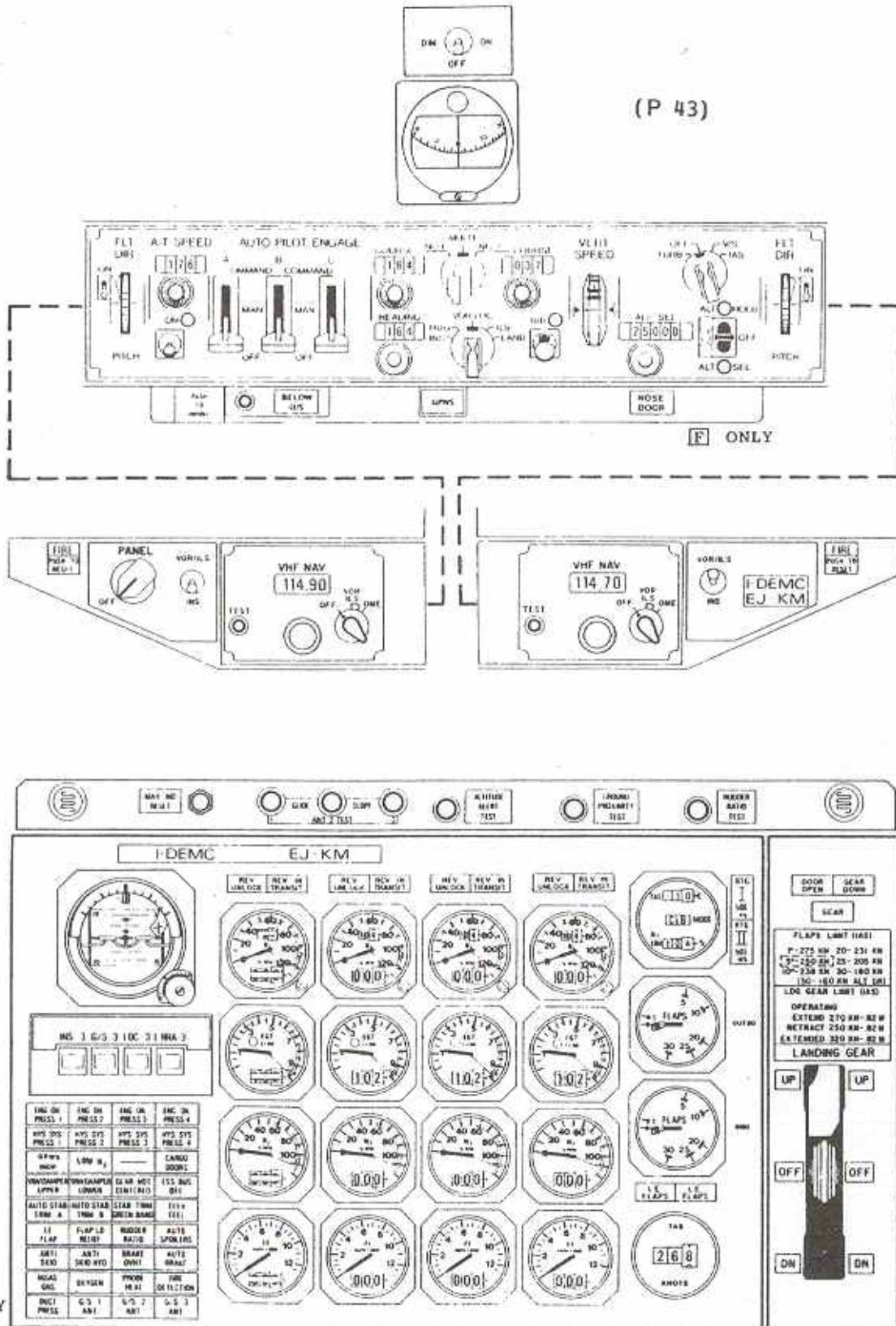

CENTER INSTRUMENT PANEL (P 2/P 33)

C/M-2 INSTRUMENT PANEL (P 3)

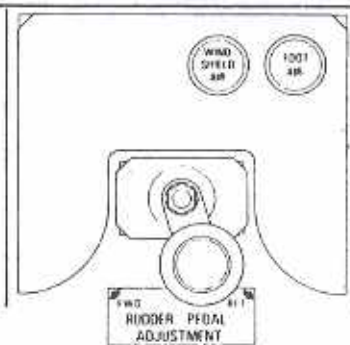
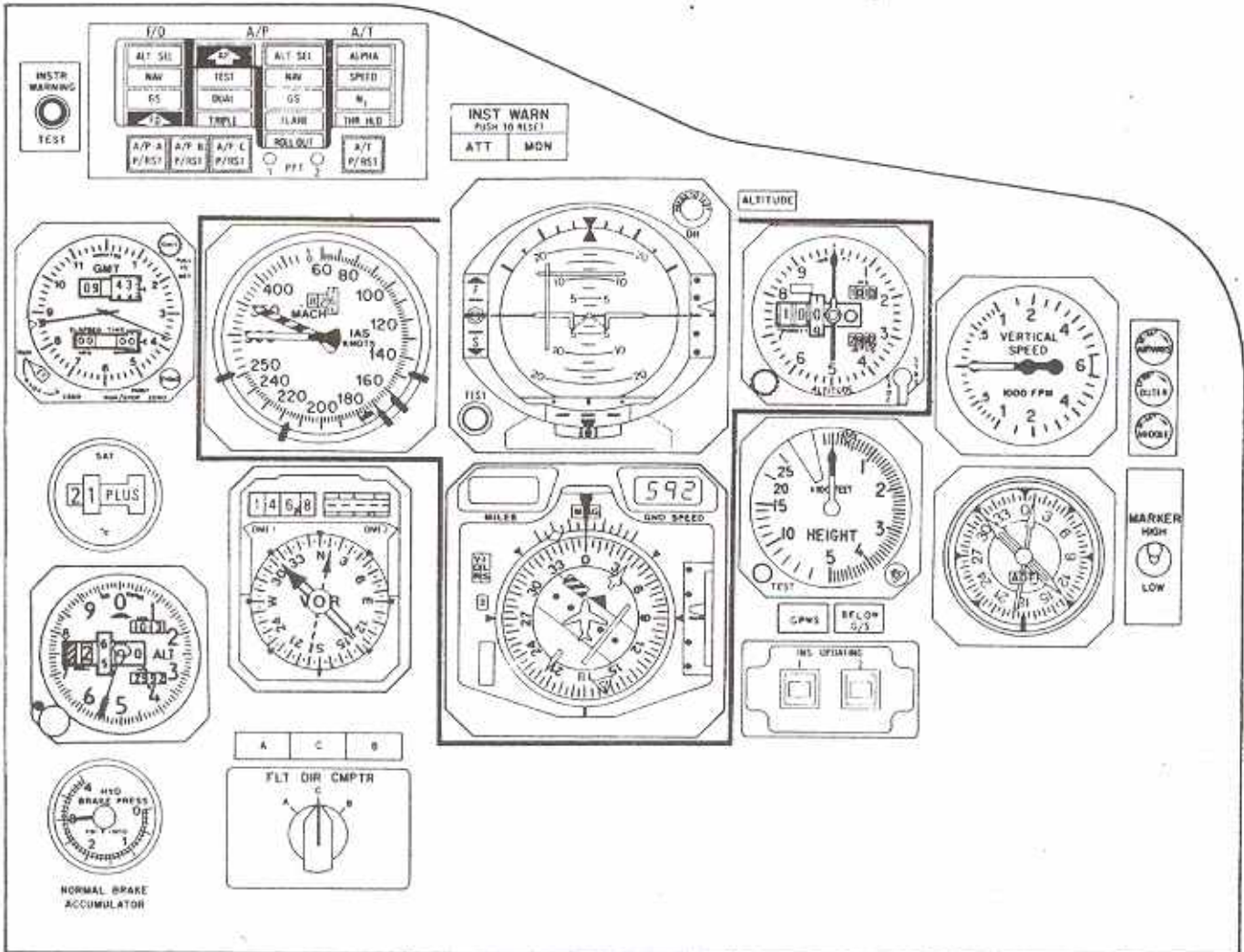

PILOTS' OVERHEAD PANEL (P 5)

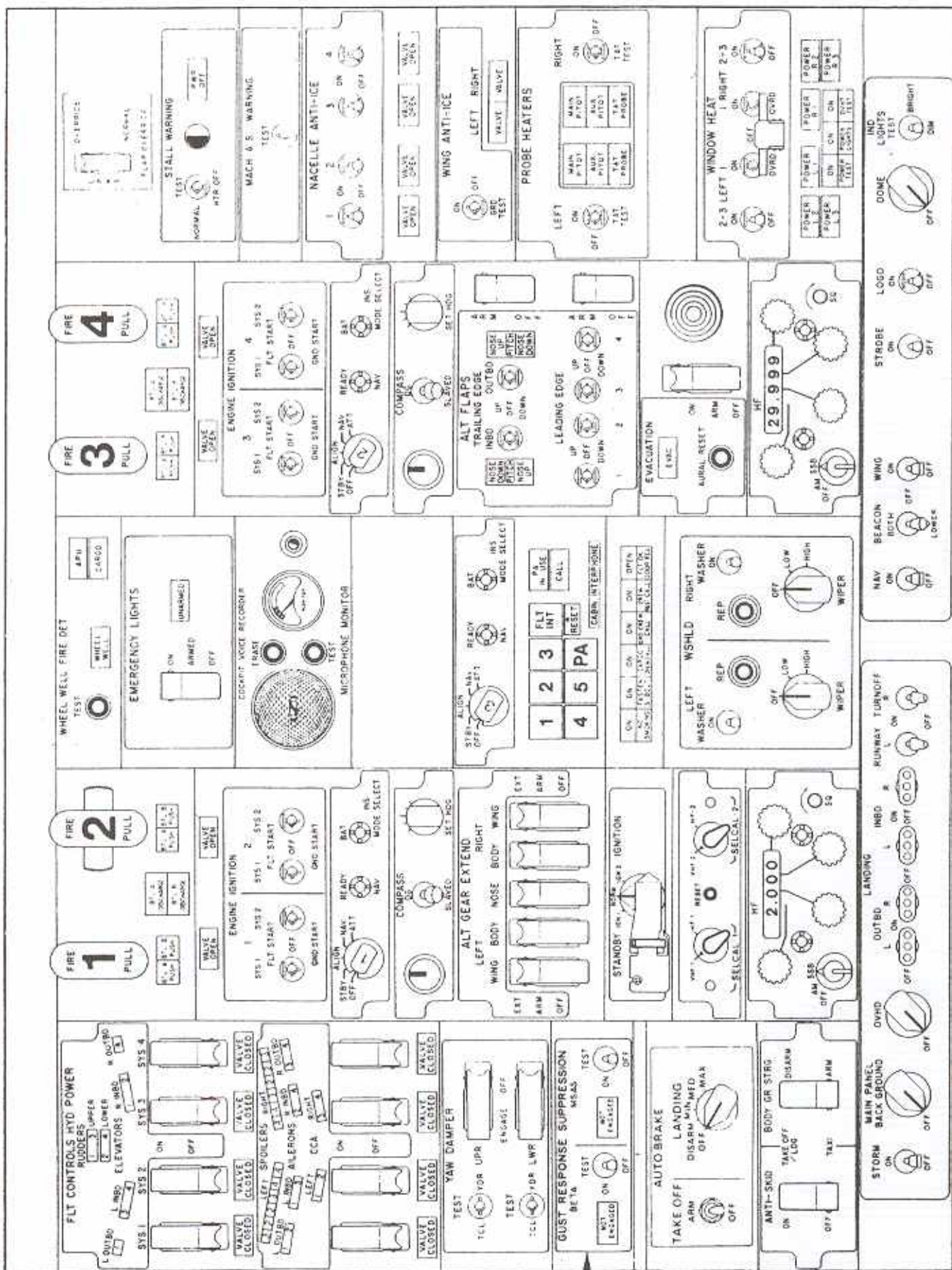

P
ONLY

PILOTS' OVERHEAD PANEL (P 5)

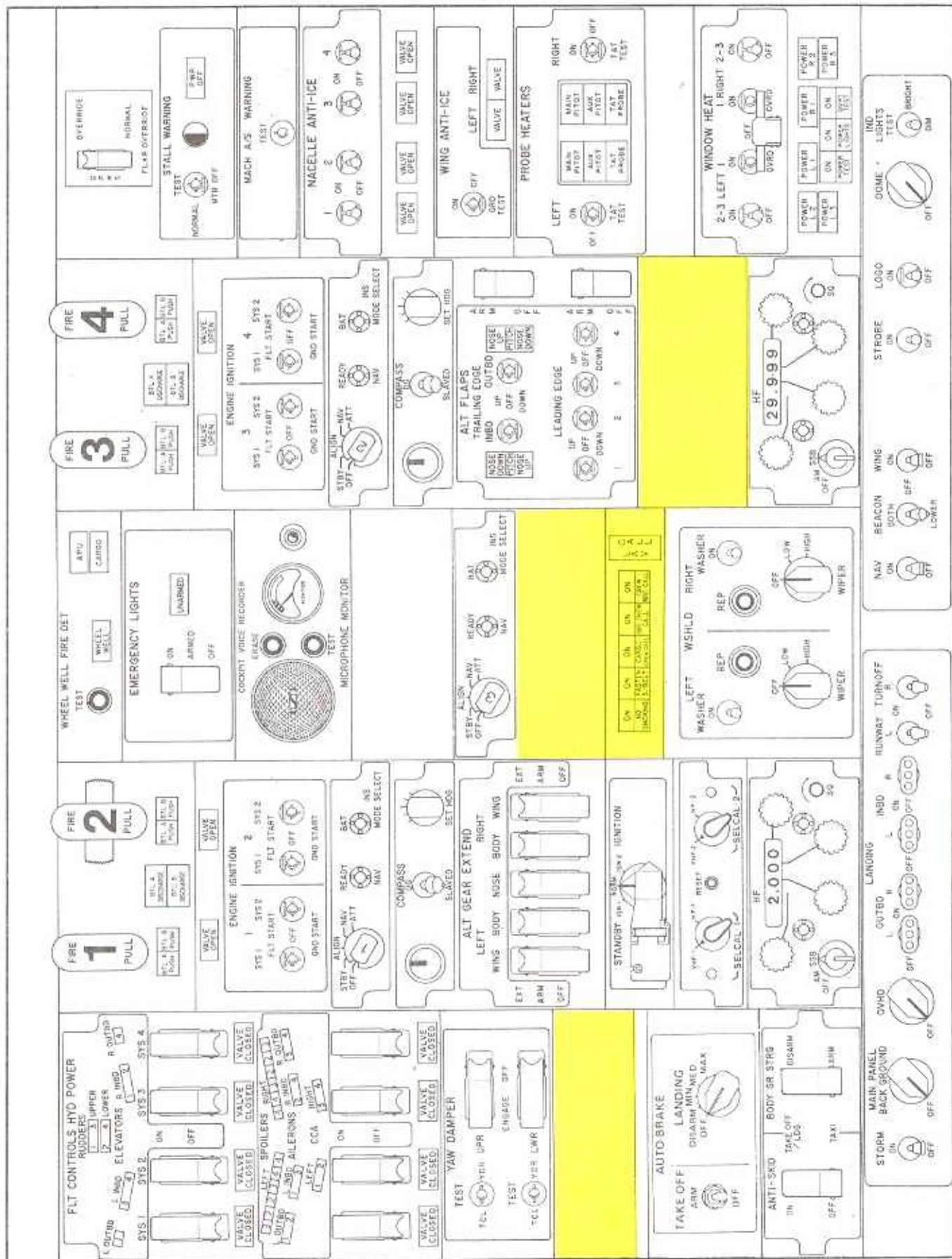

PILOTS' CONTROL STAND (P 8/P 9)

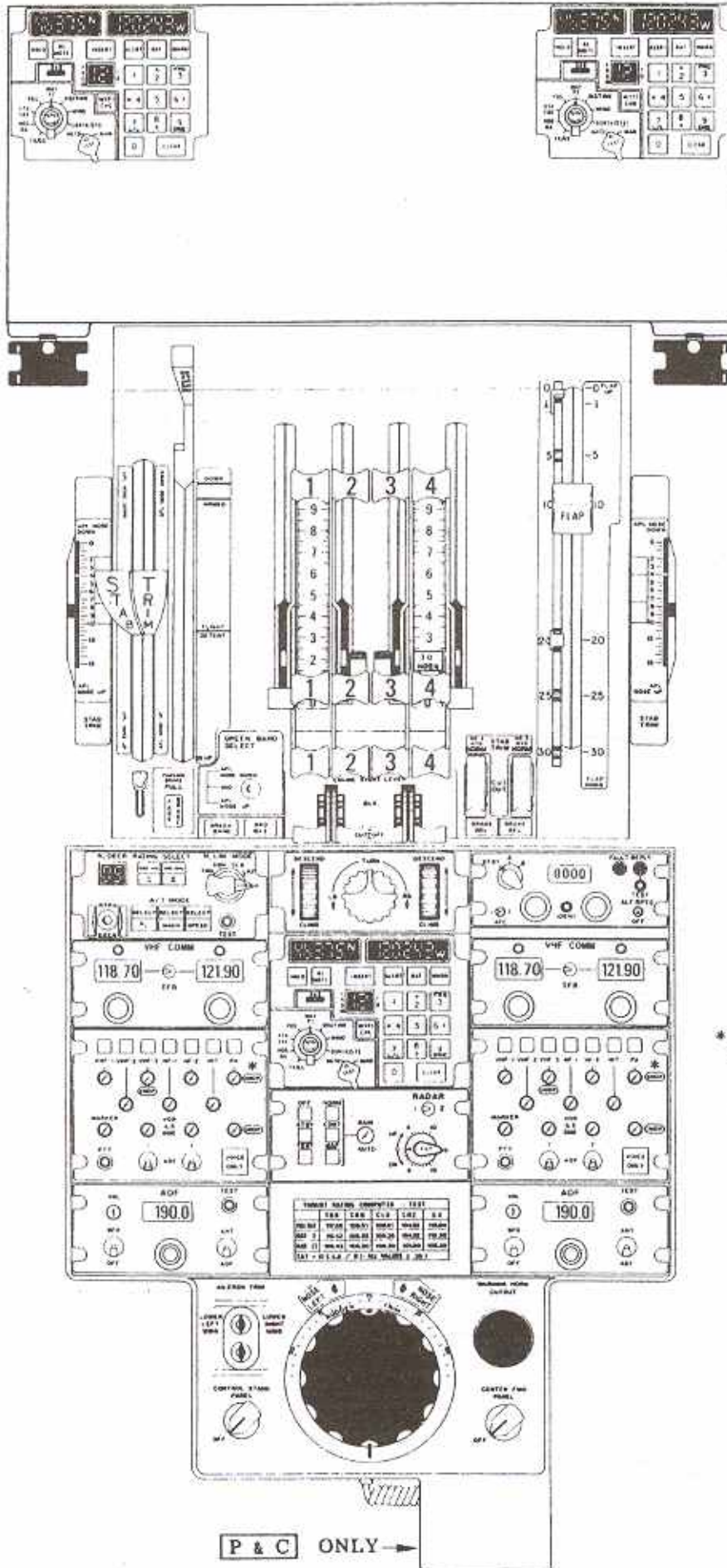

P 9
FWD

P 8
AFT

PILOTS' AUXILIARY PANELS (P 21/P 23)

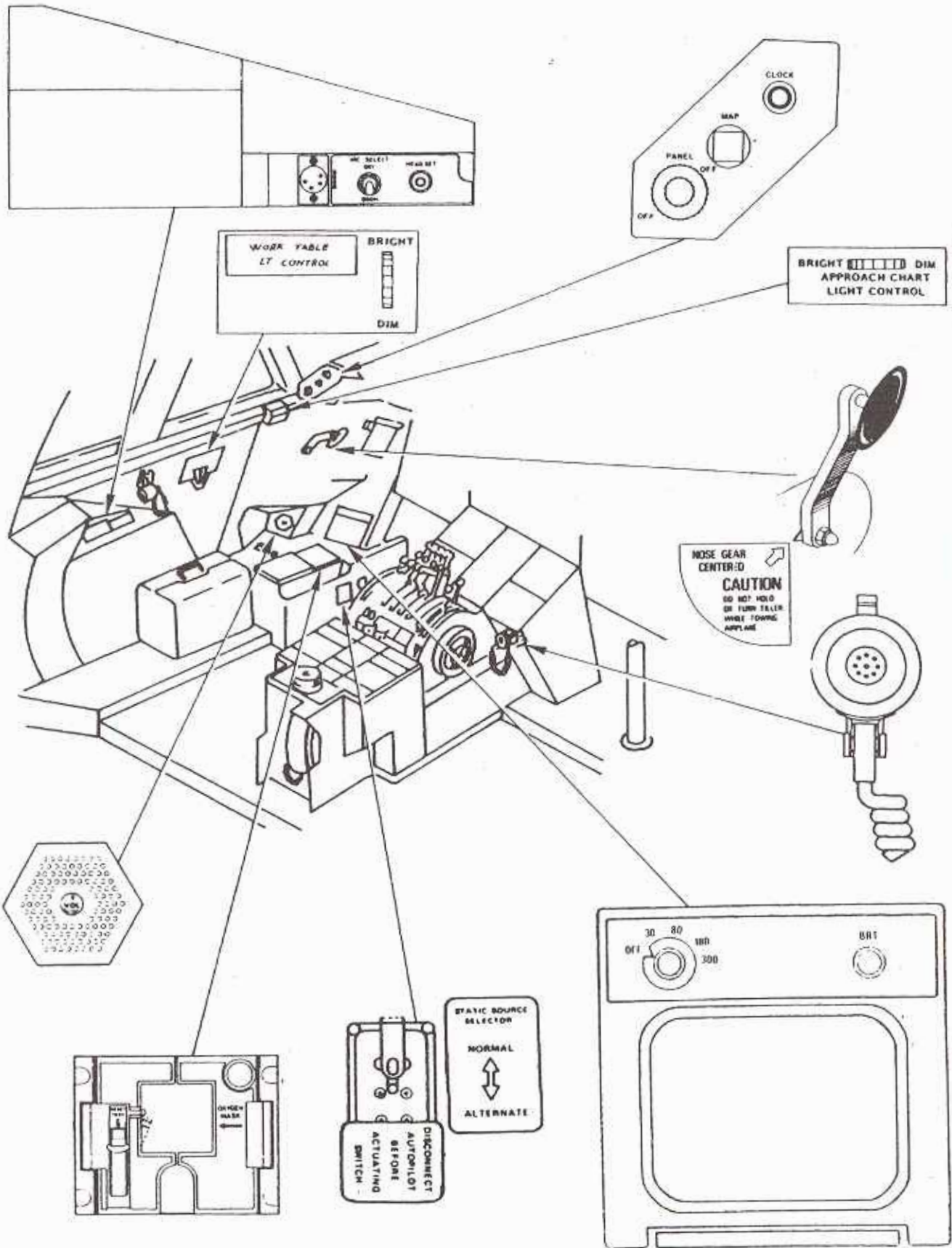

C/M-3 INSTRUMENT PANEL (P4)

UPPER

MIDDLE

LOWER

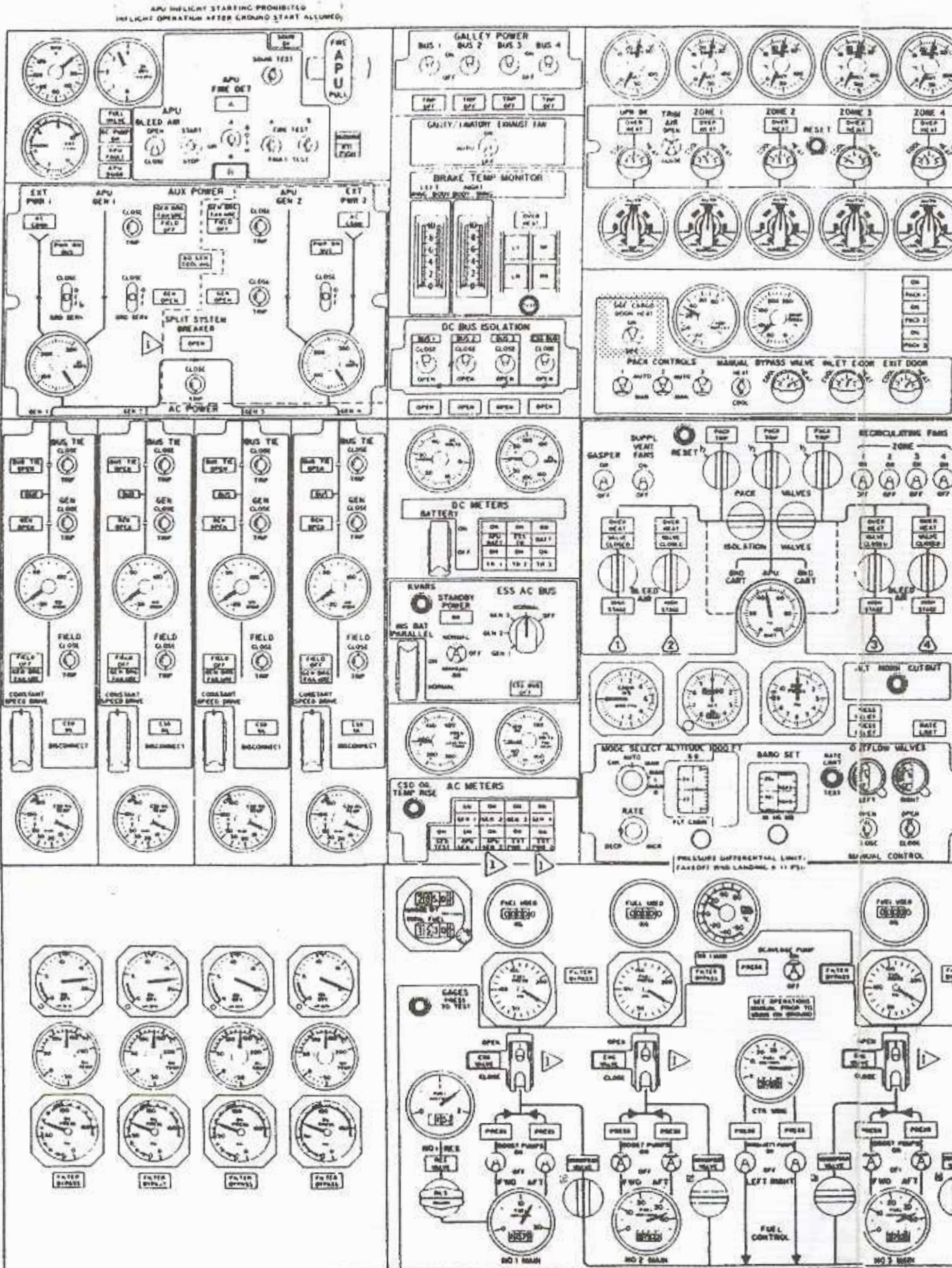

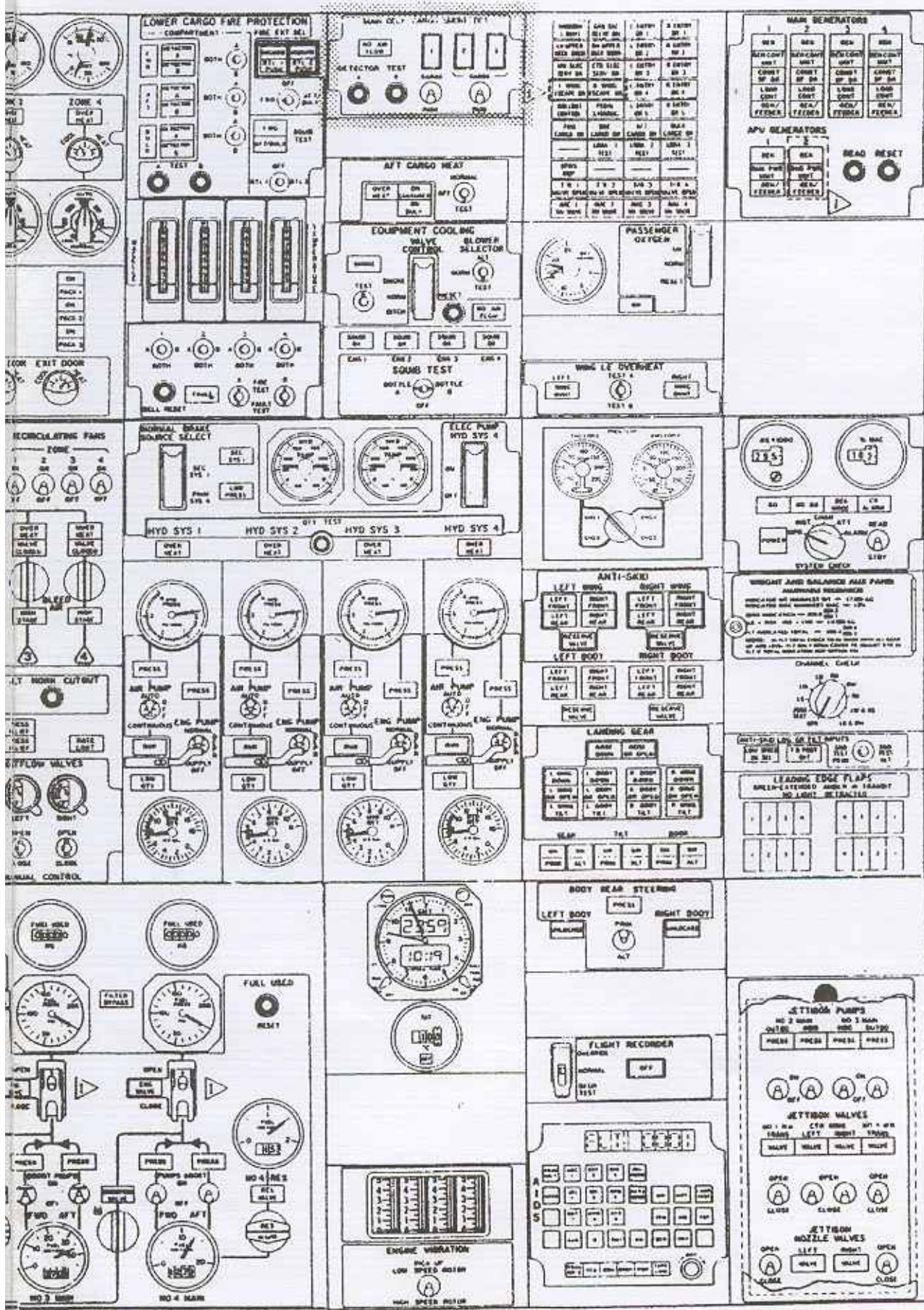

C/M-3 INSTRUMENT PANEL (P4)

APU INFLIGHT STARTING PROHIBITED
INFLIGHT OPERATION AFTER GROUND START ALLOWED

UPPER

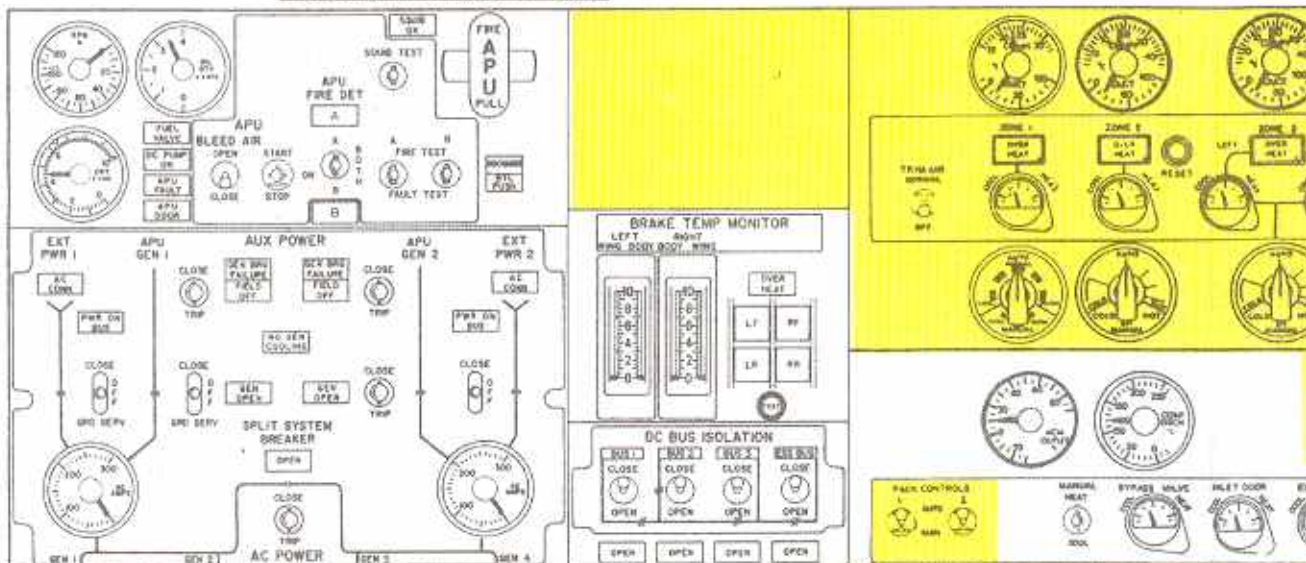

MIDDLE

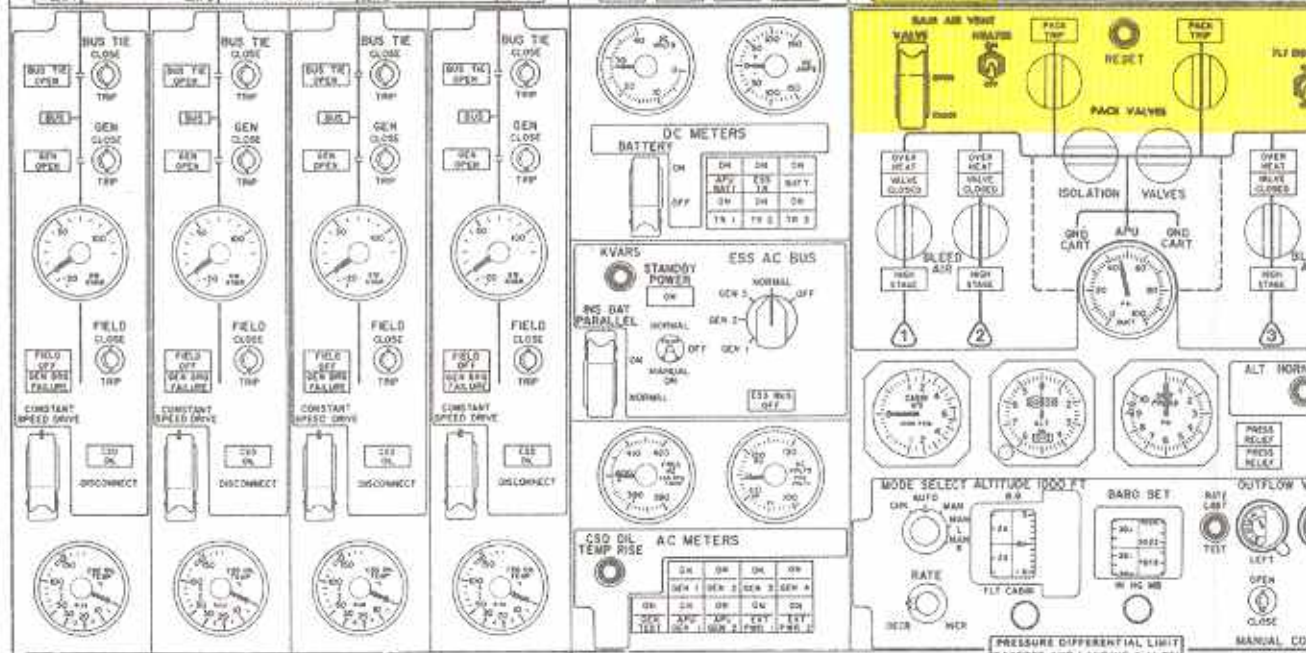

LOWER

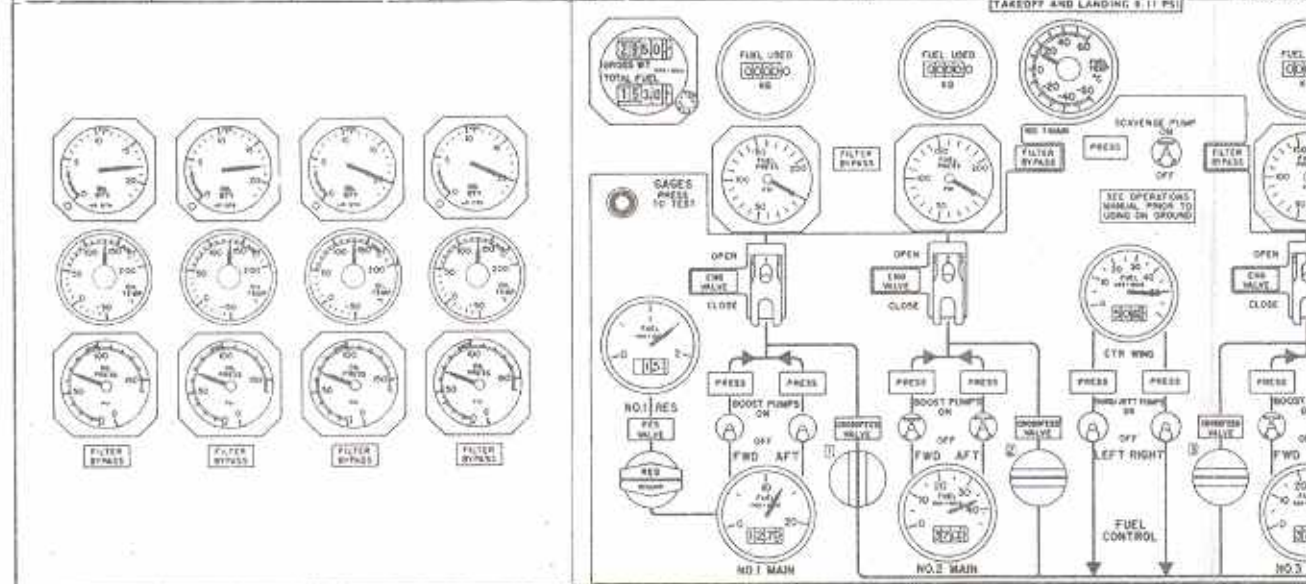

LOWER CARGO SMOKE DET

MAIN DECK CARGO SMOKE DET

FWD CARGO HEAT

EQUIPMENT COOLING VALVE CONTROL

APU GENERATORS

NOSE DOOR

HYD SYS 1-4

ANTI-SKID

LEADING GEAR

BODY GEAR STEERING

FUEL USED

ENGINE VIBRATION

FLIGHT RECORDER

JETTISON PUMPS

JETTISON VALVES

JETTISON NOZZLE VALVES

APU GENERATORS

NOSE DOOR

HYD SYS 1-4

ANTI-SKID

LEADING GEAR

BODY GEAR STEERING

FUEL USED

ENGINE VIBRATION

FLIGHT RECORDER

JETTISON PUMPS

JETTISON VALVES

JETTISON NOZZLE VALVES

APU GENERATORS

NOSE DOOR

HYD SYS 1-4

ANTI-SKID

LEADING GEAR

BODY GEAR STEERING

FUEL USED

ENGINE VIBRATION

FLIGHT RECORDER

JETTISON PUMPS

JETTISON VALVES

JETTISON NOZZLE VALVES

APU GENERATORS

NOSE DOOR

HYD SYS 1-4

ANTI-SKID

LEADING GEAR

BODY GEAR STEERING

FUEL USED

ENGINE VIBRATION

FLIGHT RECORDER

JETTISON PUMPS

JETTISON VALVES

JETTISON NOZZLE VALVES

APU GENERATORS

NOSE DOOR

HYD SYS 1-4

ANTI-SKID

LEADING GEAR

BODY GEAR STEERING

FUEL USED

ENGINE VIBRATION

FLIGHT RECORDER

JETTISON PUMPS

JETTISON VALVES

JETTISON NOZZLE VALVES

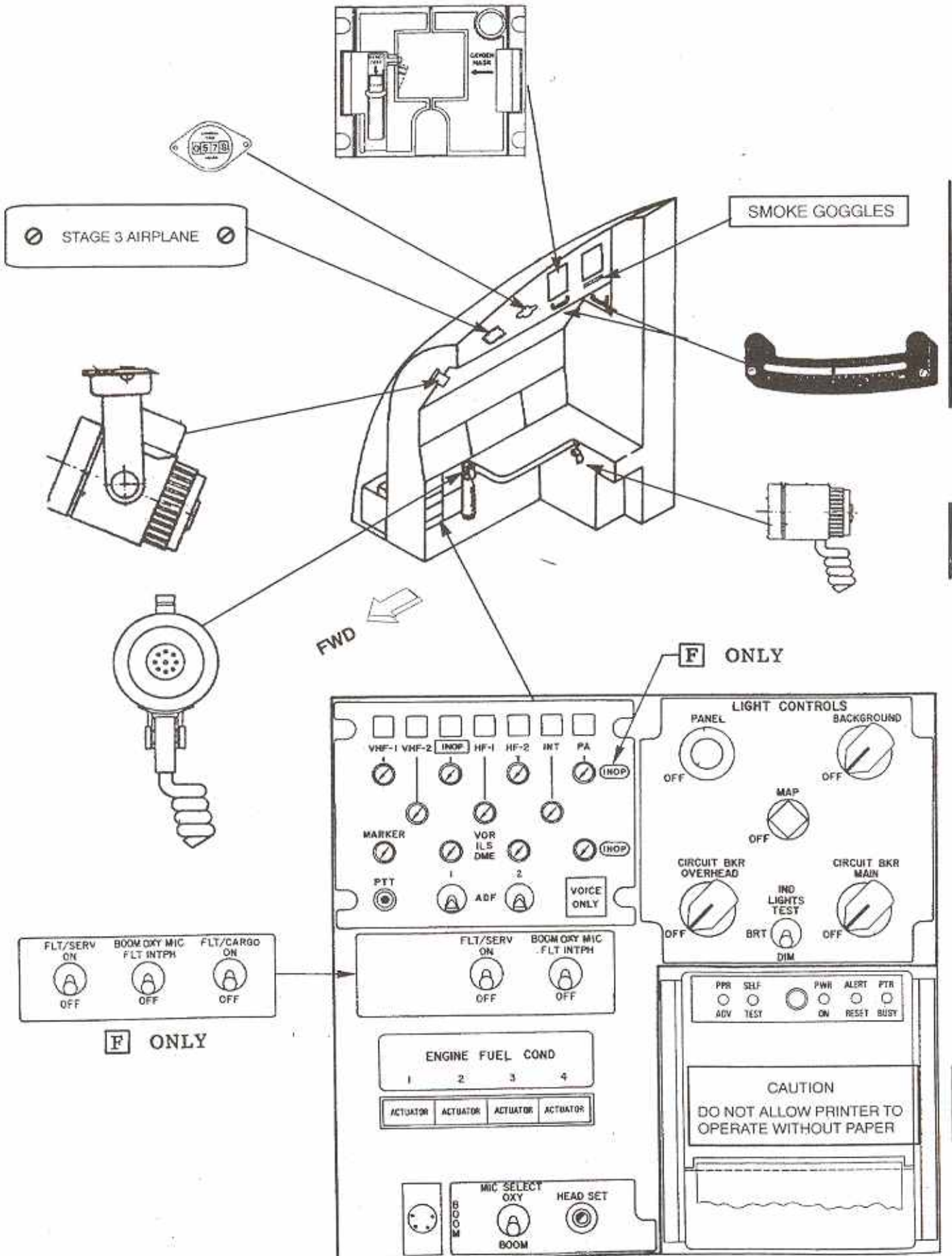

OBSERVERS' PANELS (P 11/P 13)

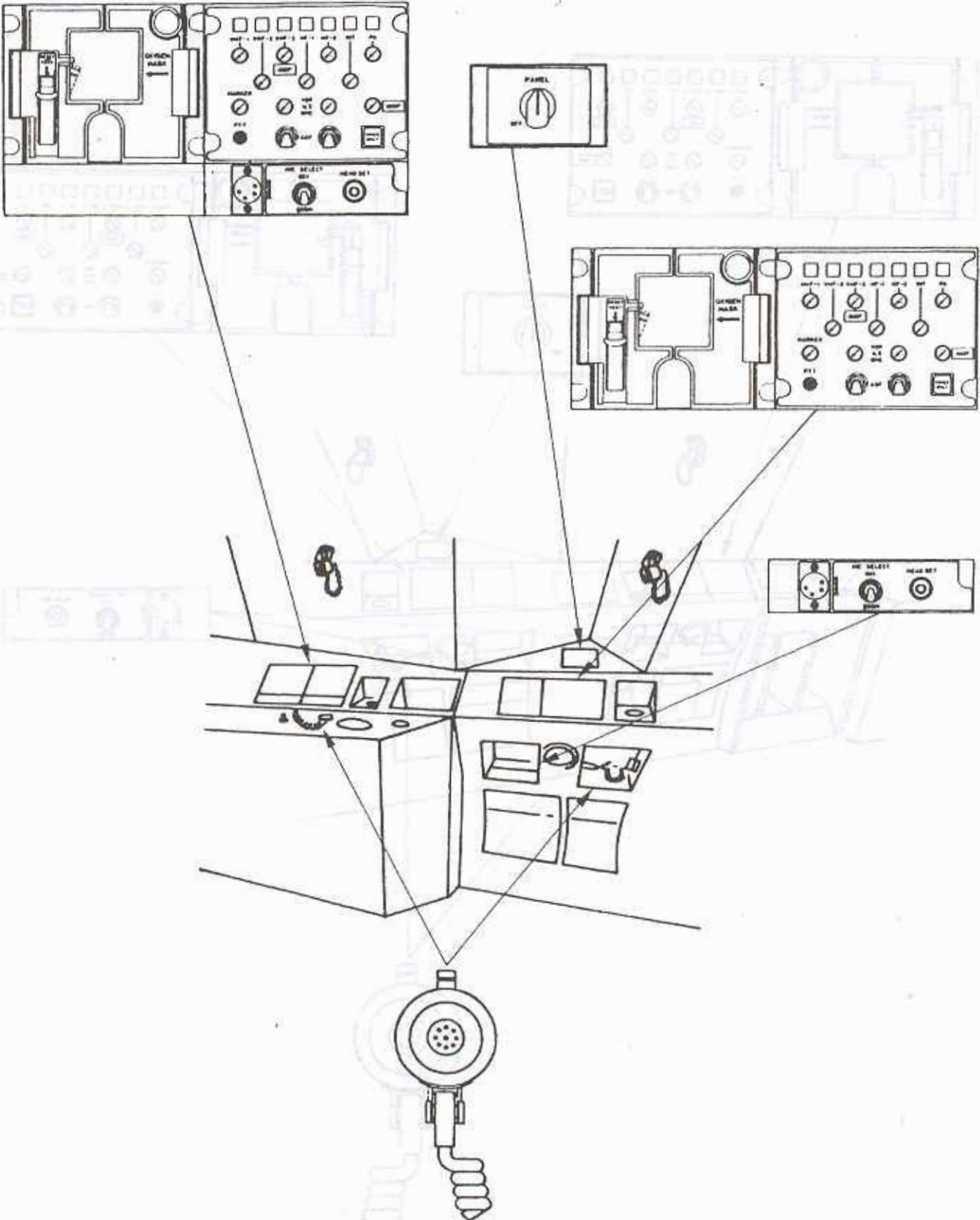

OBSERVERS' PANELS (P 11/P 13)

