

374102

Model	Colour/Farbe/Couleur	
374102	050	white/weiss/blanc
374102	072	folkestone grey/grau/gris

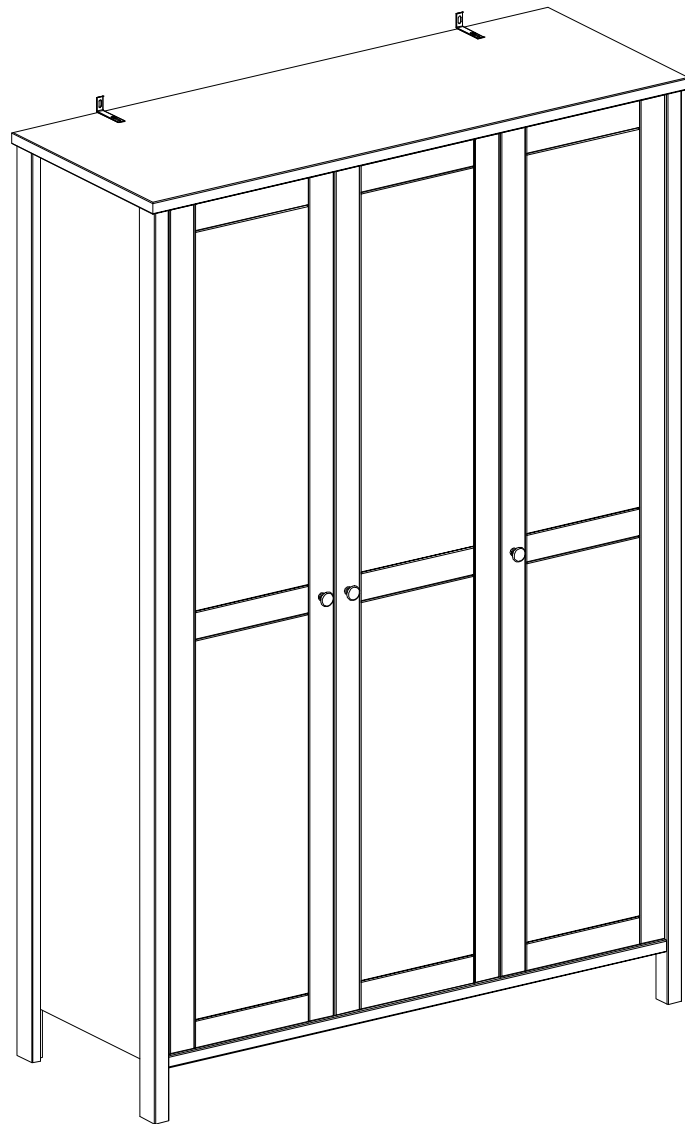

Dimensions

width: 129 cm

depth: 49,6 cm

height: 195 cm

D: Aufbauanleitung
F: Instructions de montage
I: Istruzioni di montaggio
E: Instrucciones de montaje
GB: Assembly Instructions
DK: Samlevejledning

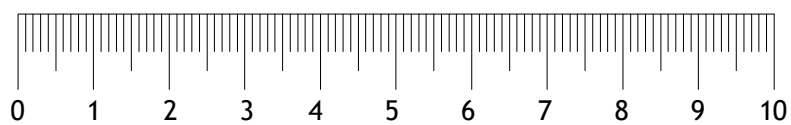
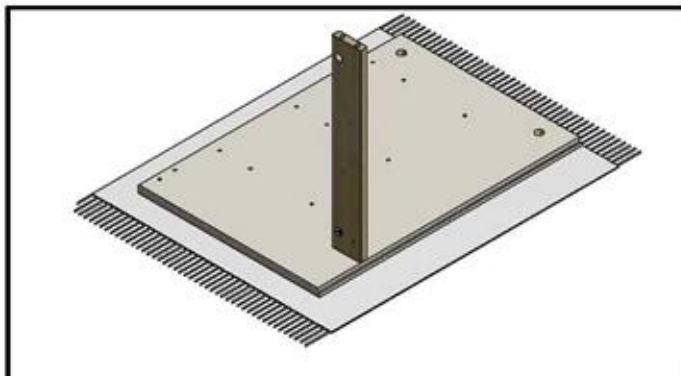
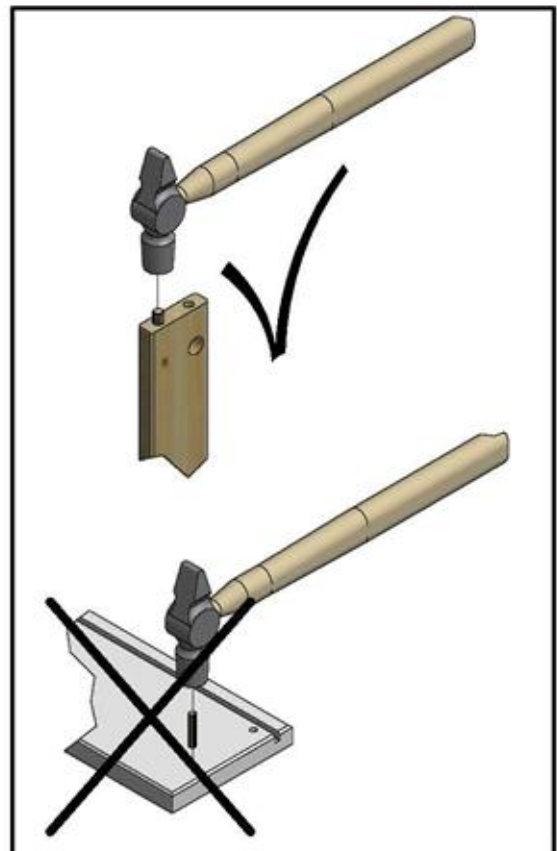
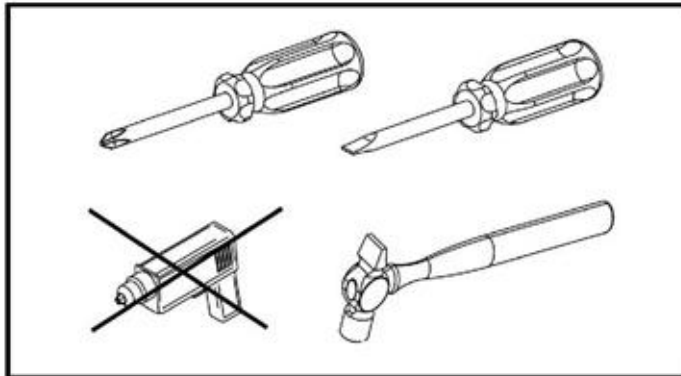
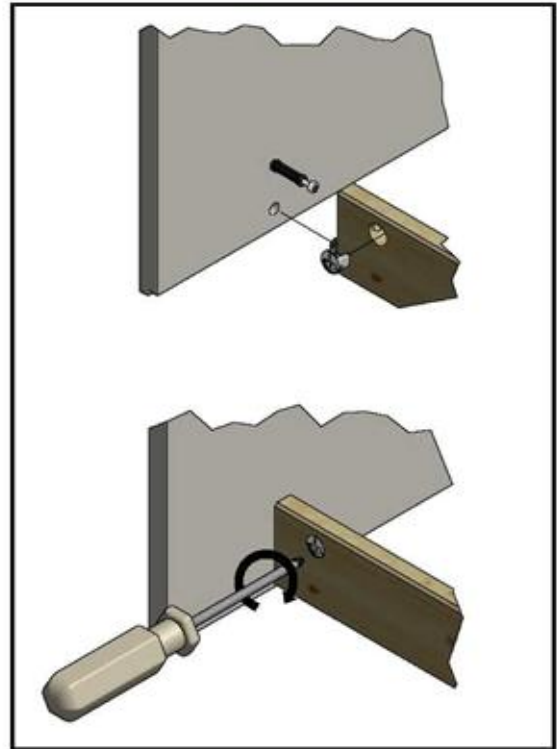
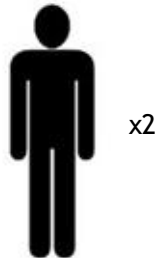
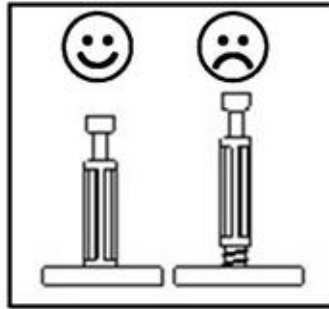

DE:**Bewahren Sie diese Hinweise gut auf.**

Bei Nachbestellung von Neuteilen nutzen Sie bitte die Nummer auf den Deckblättern, die sich auf die korrekte Farbe bezieht, sowie die artikelnummer auf Seite 5.

Da möbel aus Naturholz ständigen Klima- und Feuchtigkeitsschwankungen ausgesetzt sind, können vereinzelt Veränderungen in der Oberfläche auftreten wie z.B. Haarrisse oder Farbveränderungen. Generell nimmt im Laufe der Zeit die Helligkeit ab und die Farbsättigung zu - das Holz dunkelt nach.

Die genannten Veränderungen sind bei einem Natur-Rohstoff wie Holz ein normaler Prozess.

Pflegehinweise für geölte Möbel aus Naturholz:

Die Oberfläche Ihres neuen Möbelstücks ist mit rein biologischem Öl behandelt. Um diesen natürlichen, geölten Glanz zu bewahren, empfehlen wir eine gelegentliche Nachbehandlung mit geeignetem Möbelöl. Da durch die Art der Oberflächenbehandlung evtl. Rückstände des Naturöls zurückbleiben können, empfehlen wir Ihnen, die Möbel mit einem fusselfreien Tuch abzureiben. Das Tuch nach Gebrauch trocknen lassen und erst dann entsorgen.

Pflegehinweise für naturbelassene/gelackte Möbel aus Naturholz:

Die Oberfläche lässt sich am besten mit einem mässig feuchten Tuch säubern.

Achtung: Ätzende oder Lösungsmittelhaltige Reinigungsmittel oder Politur dürfen **nicht** verwendet werden:

Pflegehinweise für Möbel aus Plattenwerkstoffen:

Verwenden Sie zur Pflege Ihres Möbels aus Plattenwerkstoffen am besten ein weiches, nicht fuselndes Tuch oder ein Ledertuch. Wischen Sie die Oberflächen leicht feucht ab.

FR:**Conservez bien cette notice.**

Si de nouvelles pièces sont à commander, utilisez le numéro présent en première page indiquant le bon coloris ainsi que le numéro d'article en page 5. Comme le meuble en bois naturel est soumis aux variations permanentes du climat et de l'humidité, il se peut que quelques modifications surviennent sur la surface, comme par exemple de fines fissures ou des décolorations. En règle générale, au cours du temps, la clarté du bois diminue et son intensité de couleur augmente - le bois devient foncé.

Les modifications susnommées sont un processus normal des naturelles comme le bois.

Instructions de soin pour les meubles huilés en bois naturel.

La surface de votre nouveau meuble est traitée avec de l'huile purement biologique. Pour conserver le brillant de ce meuble huilé, nous recommandons de faire un traitement occasionnel avec de l'huile à meuble.

Comme le type de traitement de surface peut éventuellement laisser des résidus d'huile naturelle, nous vous recommandons de frotter le meuble avec un chiffon non pelucheux. Après l'utilisation, laissez sécher le chiffon et ensuite le jeter.

Instructions de soin pour les meubles naturels/peints en bois naturel.

La surface se nettoie de préférence avec un chiffon légèrement humide.

Attention: Les détergents agressifs ou à teneur en solvant ou les produits de polissage **ne doivent pas** être utilisés.

Cocsignes de soin pour les meubles avec des plaques en dérivé du bois.

Pour l'entretien de votre meuble en plaques en dérivé du bois, utilisez de préférence un chiffon doux non pelucheux ou une peau de chamois. Essayez la surface légèrement humide.

IT:**Conservare bene le presenti istruzioni.**

Per effettuare l'ordine di parti nuove, utilizzare il numero presente nelle prime pagine, che indica il colore corretto, e il numero dell'articolo a pagina 5.

Dato che i mobili in legno naturale sono esposti al continuo variare del clima e dell'umidità, è probabile che in superficie insorgano mutamenti quali crepe capillari o cambiamenti di colore. Generalmente con passar del tempo diminuisce la chiarezza e aumenta la saturazione del colore - il legno si scurisce.

I citati mutamenti sono un normale processo dei materiali naturali, quali appunto il legno.

Istruzioni sulla cura dei mobili in legno naturale oliato.

La superficie di questo vostro nuovo mobile è trattata con olio puramente biologico. Per mantenere la naturale lucentezza oliata, vi consigliamo di ripetere il trattamento con un adeguato olio per mobili. Dato che per via del trattamento superficiale possono eventualmente residuarsi tracce di prodotto, vi consigliamo di strofinare i mobili con un panno che non lascia peli. Fate asciugare il panno usato prima di smaltirlo.

Istruzioni sulla cura dei mobili in legno naturale non trattato/verniciato.

Il modo migliore di pulire la superficie è usare un panno moderatamente umido.

Attenzione: Non utilizzare lucidi per mobili oppure detergenti abrasivi o a base di solventi.

Istruzioni sulla cura dei mobili in materiali pannellati.

Per la cura dei mobili in materiali pannellati si consiglia di usare un panno morbido, che non lascia peli, o un panno di pelle. Passare il panno leggermente umido sulle superfici.

ES:**Guarde estas notas en un lugar seguro.**

En caso de volver a solicitar nuevas piezas, use el número que aparece en las primeras páginas y que hace referencia al color correcto y al número de artículo de la página 5.

Puesto que los muebles de madera natural están permanentemente expuestos a las fluctuaciones meteorológicas y de humedad, en algunos casos pueden producirse cambios en la superficie (p. ej. fisuras capilares o cambios en el color). En general, con el paso del tiempo el brillo se reduce y la saturación del color aumenta, es decir, la madera se oscurece.

Los cambios mencionados son normales en materias primas naturales como la madera.

Notas para el cuidado de muebles de madera natural decapados o tratados con aceite:

La superficie del mueble ha sido tratada con aceite orgánico puro. Recomendamos realizar más adelante y de forma ocasional un tratamiento con un aceite adecuado para muebles, de esta manera conservará tanto su lustre natural como el decapado o tratamiento con aceite. Como pueden quedar residuos de aceite, recomendamos frotar con un trapo que no suelte pelusa. A continuación, deje que el trapo se seque completamente antes de eliminarlo.

Notas para el cuidado de muebles de madera natural no tratados ni pintados:

Lo más adecuado para limpiar la superficie es usar un trapo ligeramente húmedo.

Atención: no utilizar limpiadores corrosivos ni que contengan disolventes o abrillantadores.

Notas para el cuidado de muebles hechos con material de panel:

Recomendamos usar un trapo suave que no suelte pelusas o una gamuza. A continuación, frote las superficies con un trapo o una gamuza ligeramente humedecidos.

GB:**Keep these notes in a safe place.**

In case of ordering new parts, use the number on the front page, that refers to the correct colour and the item number on page 5. Since natural wood furniture are permanently exposed to climate and humidity fluctuations, changes to the surface may occur (e.g. hair cracks or changes in color) in some cases. In general, brightness decreases and colour saturation increases in the course of time - the wood darkens. The changes mentioned above are normal for natural raw materials such as wood.

Care notes for oiled furniture made of natural wood:

The surface of your new piece of furniture has been treated with pure organic oil. We recommend an occasional after treatment with suitable furniture oil to preserve this natural, oiled gloss. Since some residue of natural oil may remain on the furniture due to the surface treatment method, we recommend to rub off the furniture with a lint-free cloth. After use, let the cloth dry completely before disposal.

Care notes for untreated/painted furniture made of natural wood:

Using a moderately damp cloth is the most suitable method for cleaning the surface.

Attention: Corrosive cleaners containing solvents or polish must **not** be used.

Care notes for furniture made of panel materials:

We recommend using a soft, lint-free cloth or chamois for conditioning your piece of furniture made of panel materials. Wipe off the surfaces with a slightly damp cloth or chamois.

DK:**Opbevar disse noter på et sikkert sted.**

I tilfælde af genbestilling af nye dele, bruges det nummer på forsiden, der refererer til den rigtige farve og varenummeret på side 5.

Da møbler af naturtræ konstant er udsat for klimaets og luftfugtighedens forandringer kan ændringer, i nogle tilfælde, forekomme i overfladen, (f.eks hårfine revner eller ændringer i farve). Generelt, så ændre lysstyrke og farvemætning sig med tiden - træ bliver mørkere. De ændringer, der er nævnt ovenfor, er helt normale for naturmateriale som træ.

Pleje noter til olierede møbler lavet af naturtræ:

Overfladen af dit nye møbel er behandlet med olie. Vi anbefaler en lejlighedsvis efterbehandling med passende møbelolie for at bevare det naturlige olierede udseende. Da der kan forekomme rester af olie, efter påføring, anbefales det efterfølgende, at aftørre møblet med en fnugfri klud.

Efter brug, lad kluden tørre helt inden bortskaffelse.

Pleje noter for ubehandlede/malede møbler lavet af naturtræ:

Brug en let fugtig klud til aftøring er den ubehandlede/malede møbel.

OBS: Ætsende rengøringsmidler, der indeholder opløsningsmidler eller polish må **ikke** anvendes.

Pleje noter til møbler lavet af pladematerialer:

Det anbefales at møbler af plademateriale aftøres med en blød, let fugtig fnugfri klud eller et vaskeskind.

SV:**Håll dessa anteckningar på ett säkert ställe.**

Vid beställning av nya delar, använd numret på framsidan, som refererar till rätt färg och artikelnumme på sidan 5.

Eftersom naturliga trä möbler är permanent utsatta för klimat- och fuktighetsfluktuationer kan förändringar i ytan förekommer (t.ex. håsprickor eller färgförändringar) i vissa fall. I allmänhet minskar ljusstyrkan och färgmättnad ökar med tiden - träet mörkar.

De ovan angivna förändringarna är normala för naturliga råvaror som trä.

Skötselavvisningar för oljemålningar av naturligt trä:

Ytan på din nya möbel har behandlats med ren organisk olja. Vi rekommenderar en tillfällig efter behandling med lämplig möbelolja för att bevara denna naturliga oljade glans. Eftersom vissa rester av naturlig olja kan förbli på möblerna på grund av ytbehandlingsmetoden rekommenderar vi att gnida av möblerna med en luddfri trasa.

Efter användning, låt trasan torka helt före bortskaffande.

Skötselavvisningar för obehandlade / målade möbler av naturligt trä:

Att använda en måttlig fuktig trasa är den lämpligaste metoden för rengöring av ytan.

OBS: Frätande rengöringsmedel som innehåller lösningsmedel eller polermedel får inte användas.



Skötselavvisningar för möbler av skivmaterial:

Vi rekommenderar att du använder en mjuk, luddfri trasa eller liknande för att konditionera din möbel gjord av skivmaterial.

Torka av ytorna med en lätt fuktig trasa eller mudd.

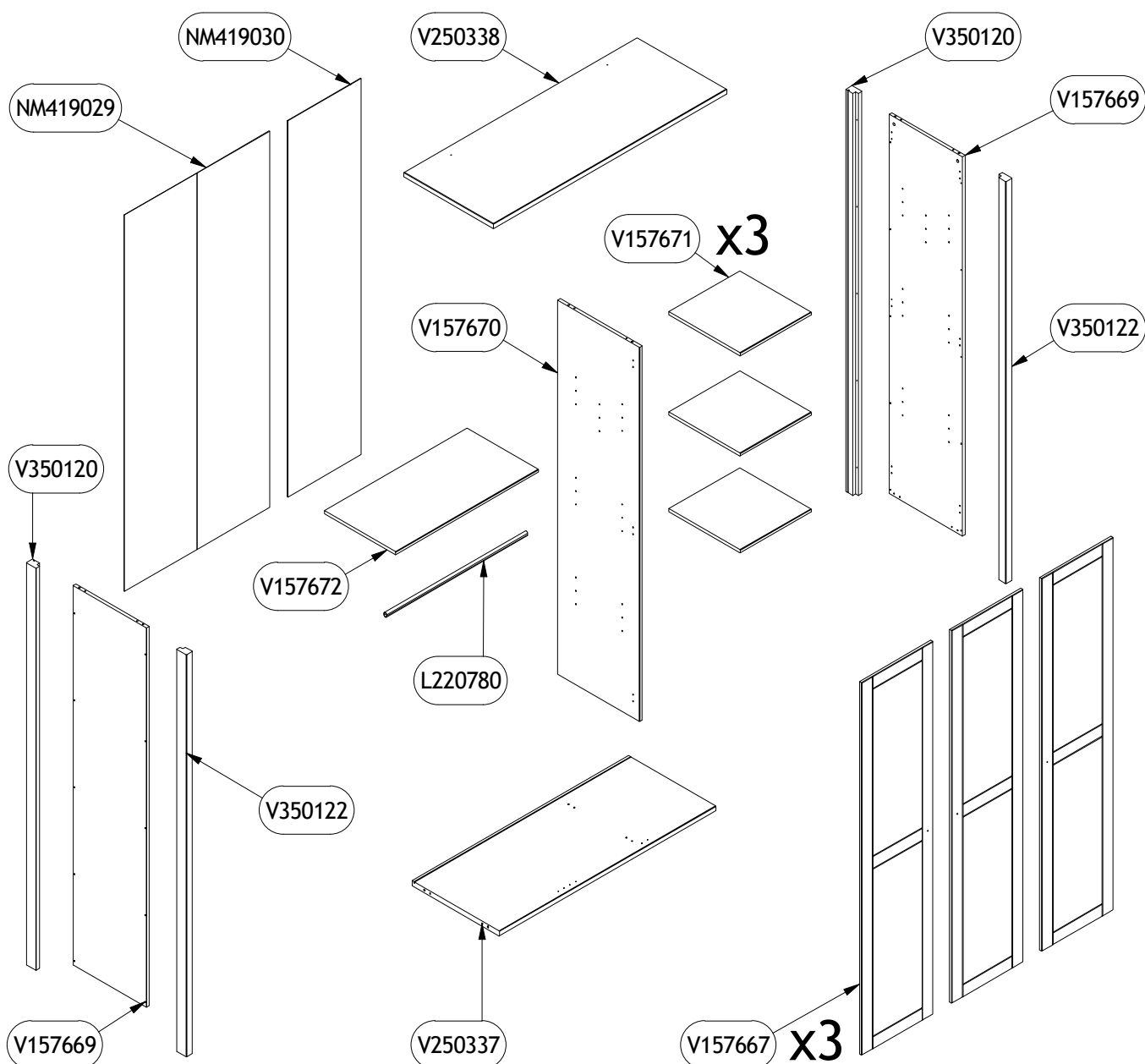
PARTS LIST					
QTY	PART NUMBER	DESCRIPTION	LÆNGDE	BREDDE	TYKKELSE
2	V350122	Forben	1925	55	35 mm
2	V350120	Bagben	1925	55	35 mm
1	V250338	Topplade	1290	496	25 mm
1	V250337	BUND	1197	483	25 mm
1	V157672	Hylde	790	395	15 mm
3	V157671	Hylde	392	395	15 mm
1	V157670	M. Side	1790	453	15 mm
2	V157669	Side	1816	406	15 mm
3	V157667	Låge	1784	395	15 mm
1	NM419030	Bagbkl. HDF	1801	405	2,5
1	NM419029	Foldebagbkl. HDF	1801	803	2,5
1	L220780	BØJLESTANG	780 mm		

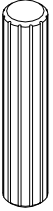

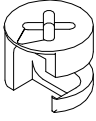
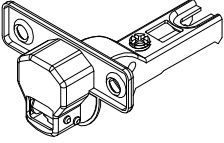
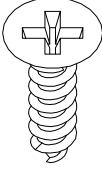
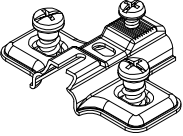
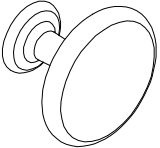
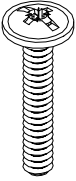
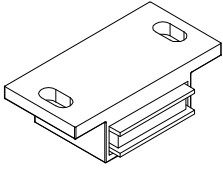
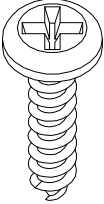
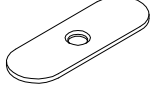
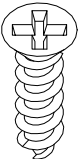
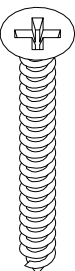
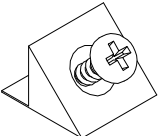
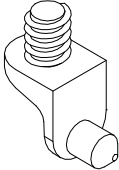
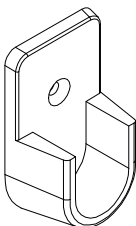
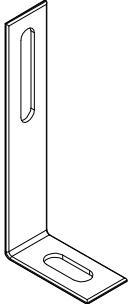
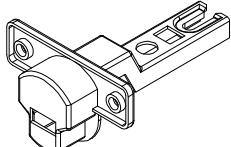
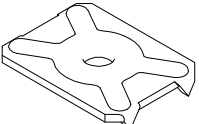
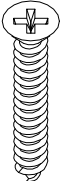
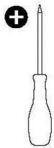
BA10400 x 12 ø6x30 mm	BA10602 x 12 5x34/8 mm	BA10597 x 12 ø12x10 mm	BA10524 x 6 ø26/10,5 mm	BA10120 x 18 ø3,5x12 mm	BA10532 x 9 0 mm/37 mm
					
BA10501 x 3 ø30x23,5 mm	BA10223 x 3 M4x22 mm	BA10708 x 6 41x20 mm	BA10112 x 14 ø3,5x16 mm	BA10709 x 6 35x12 mm	BA10102 x 8 ø3,0x12 mm
					
BA10070 x 20 ø3,5x30 mm	BA10833 x 14 15x15x10 mm	BA10856 x 16 14x10x14 mm	BA10731 x 2 15x22 mm	BA14685 x 2 76x15x31 mm	BA10508 x 3 ø26/10,5 mm
					
BA10837 x 6 19x14 Ø3	BA10108 x 6 Ø3x20 mm Ø5				
					

1

BA10400 x 2 BA10602 x 2 BA10856 x 2 BA10731 x 1 BA10102 x 1 BA10532 x 3 BA10070 x 10
ø6x30 mm ø5x34/8 mm 14x10x14 mm 15x22 mm ø3,0x12 mm 0 mm/37 mm ø3,5x30 mm

374102

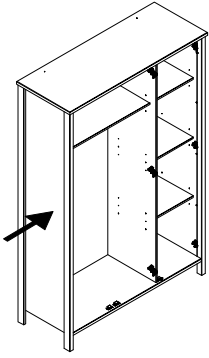
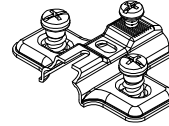
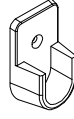
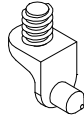
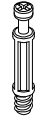
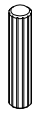

BA10102

BA10731

BA10602

V157669

BA10856

BA10532

OBS!

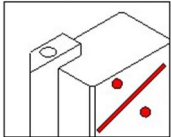
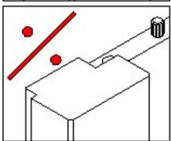
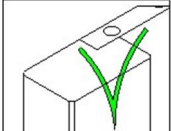

BA10400

V350120

V350122

BA10070

2

BA10400 x 2 BA10602 x 2 BA10856 x 6 BA10532 x 3 BA10070 x 10
ø6x30 mm ø5x34/8 mm 14x10x14 mm 0 mm/37 mm ø3,5x30 mm



374102

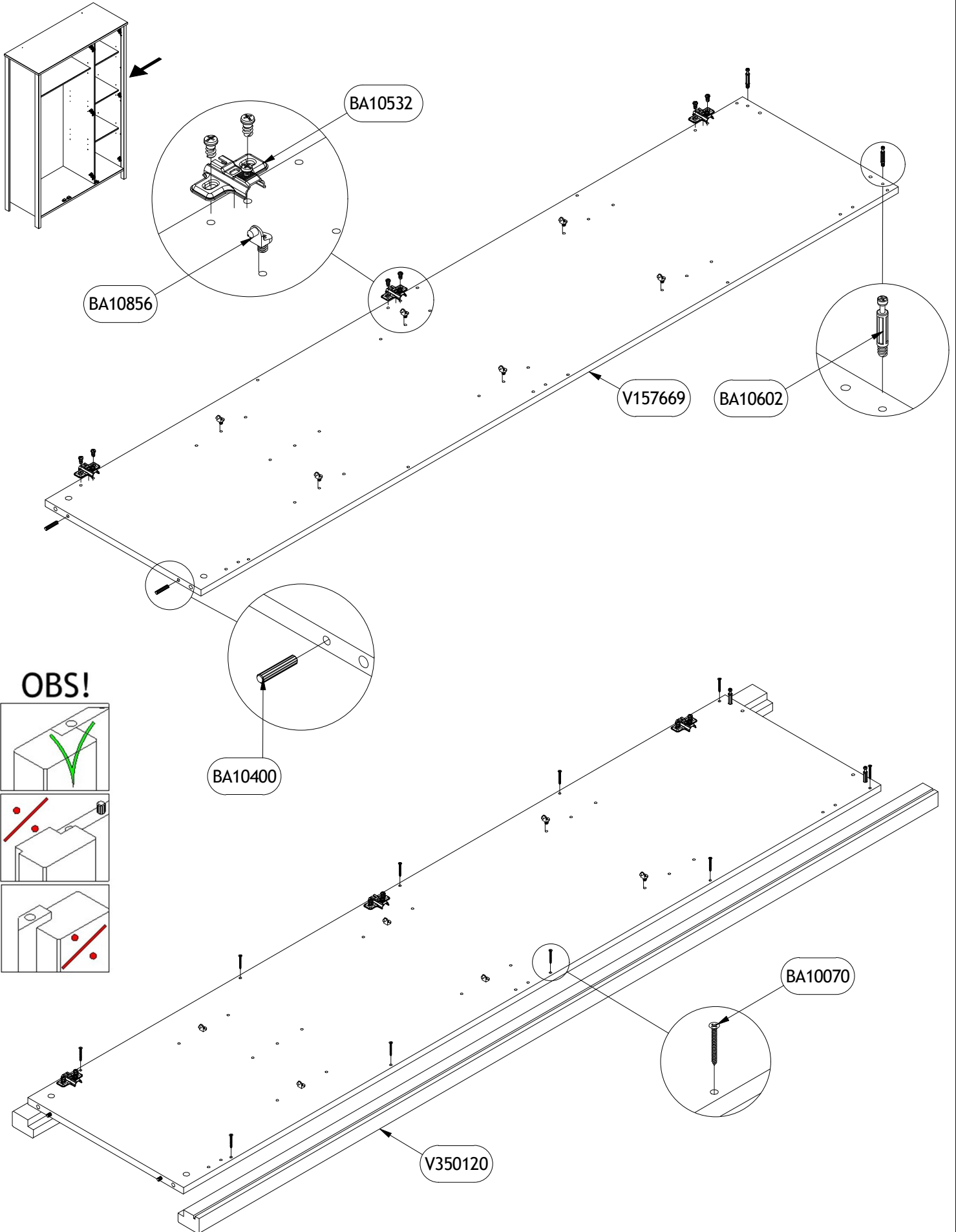
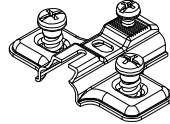
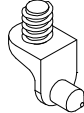
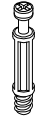
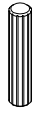

3

BA10602 x 6 BA10708 x 3 BA10112 x 6
ø5x34/8 mm 41x20 mm ø3,5x16 mm



374102

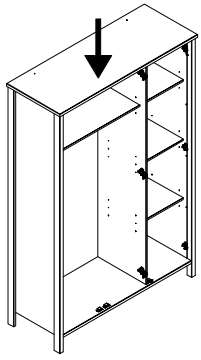
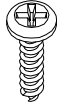
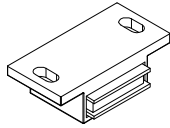
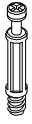

BA10602

V250338

BA10112

BA10708

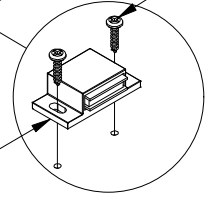
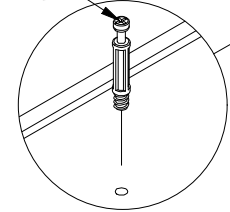

4

BA10400 x 4 BA10708 x 3 BA10112 x 6 BA10602 x 2
ø6x30 mm 41x20 mm ø3,5x16 mm ø5x34/8 mm

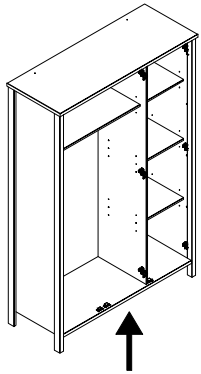
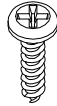
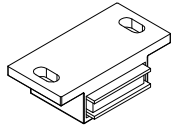
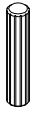
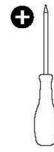

BA10602

V250337

BA10112

BA10708

BA10400

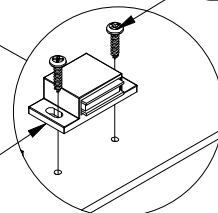
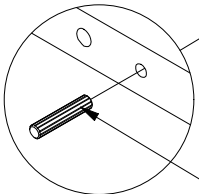
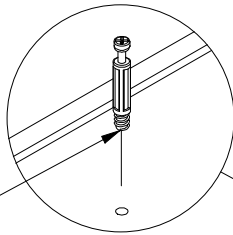

5

BA10400 x 4 BA10856 x 8 BA10532 x 3 BA10731 x 1 BA10102 x 1
ø6x30 mm 14x10x14 mm 0 mm/37 mm 15x22 mm ø3,0x12 mm

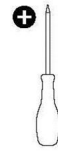

374102

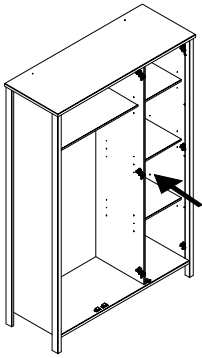
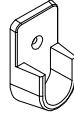
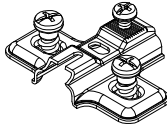
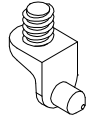
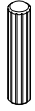

BA10856

V157670

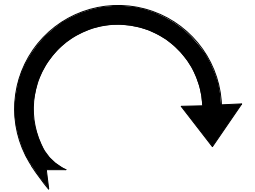

BA10400

BA10856

BA10102

BA10731

BA10532

6

BA10597 x 2
ø12x10 mm

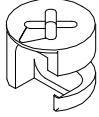

374102

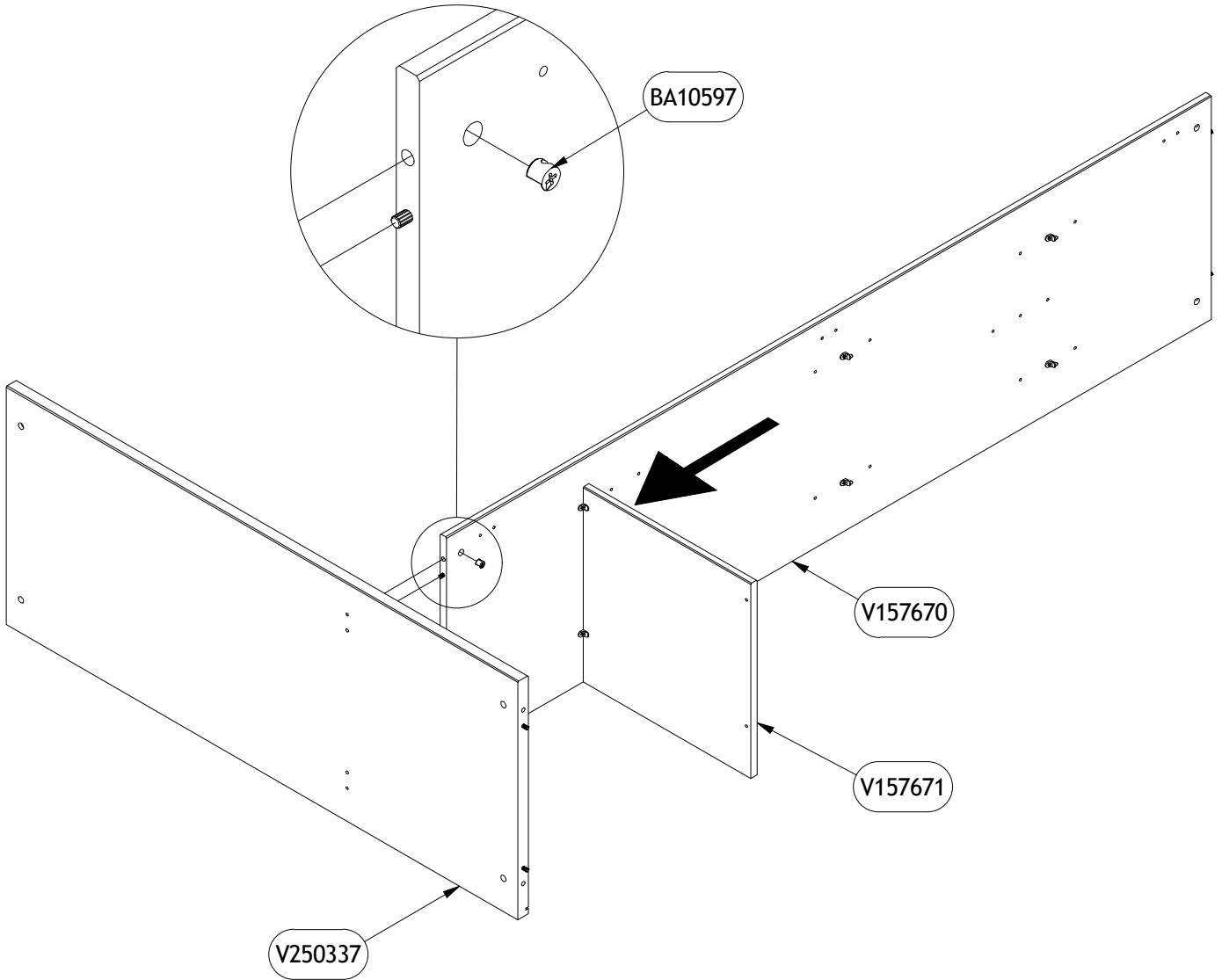
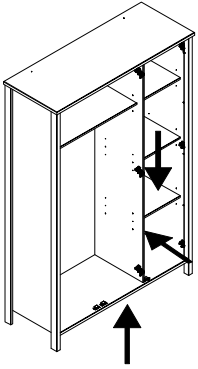

7

BA10597 x 4
ø12x10,2 mm



374102

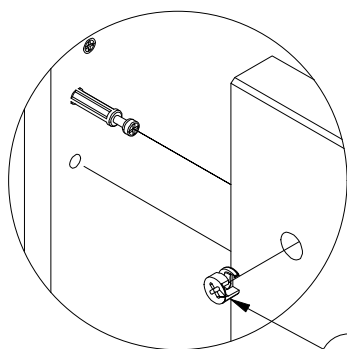
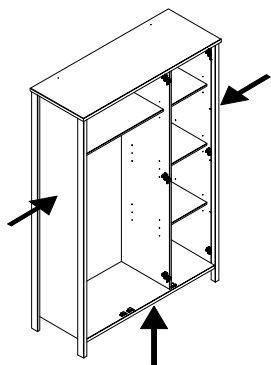

V250337

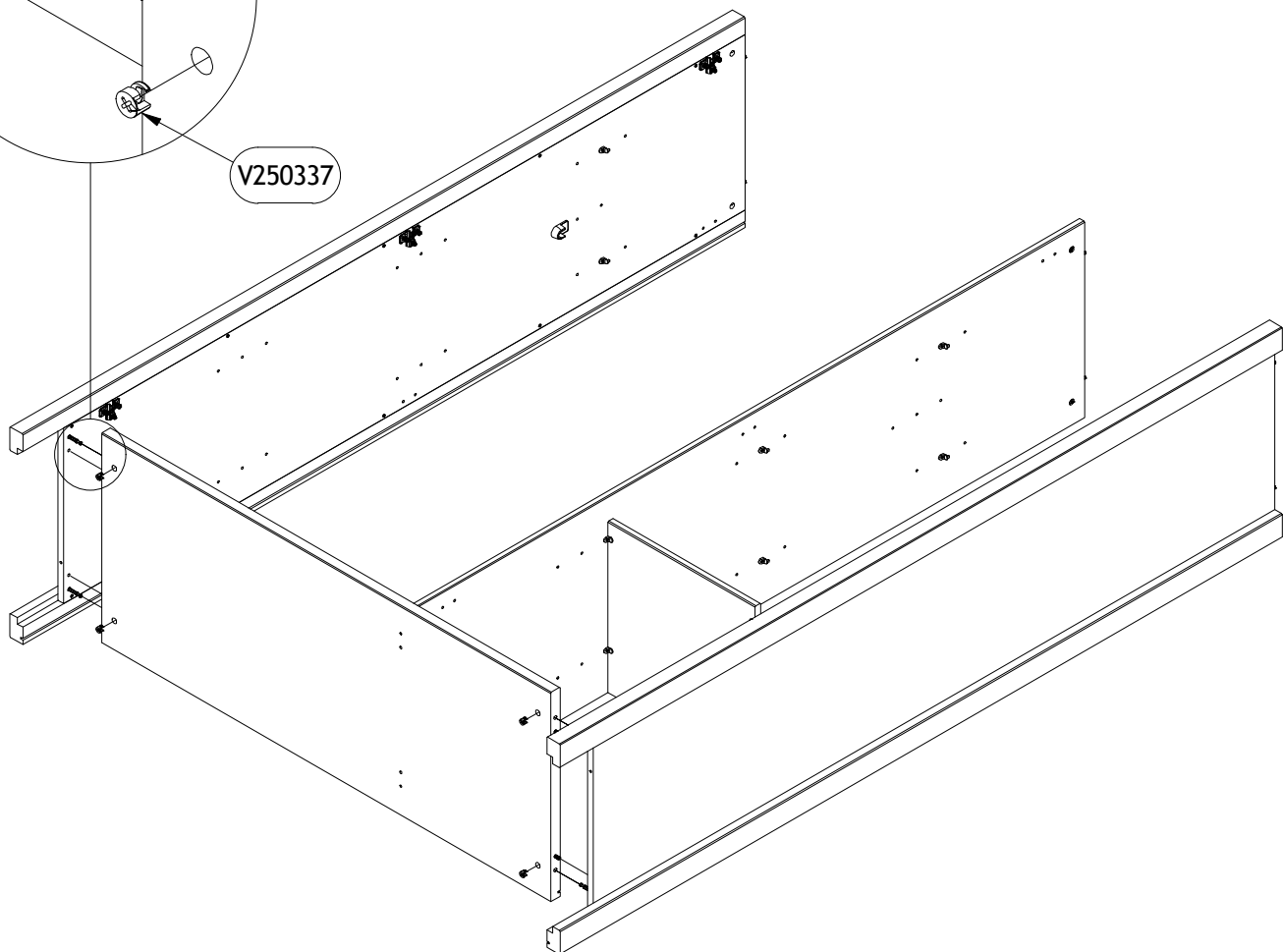

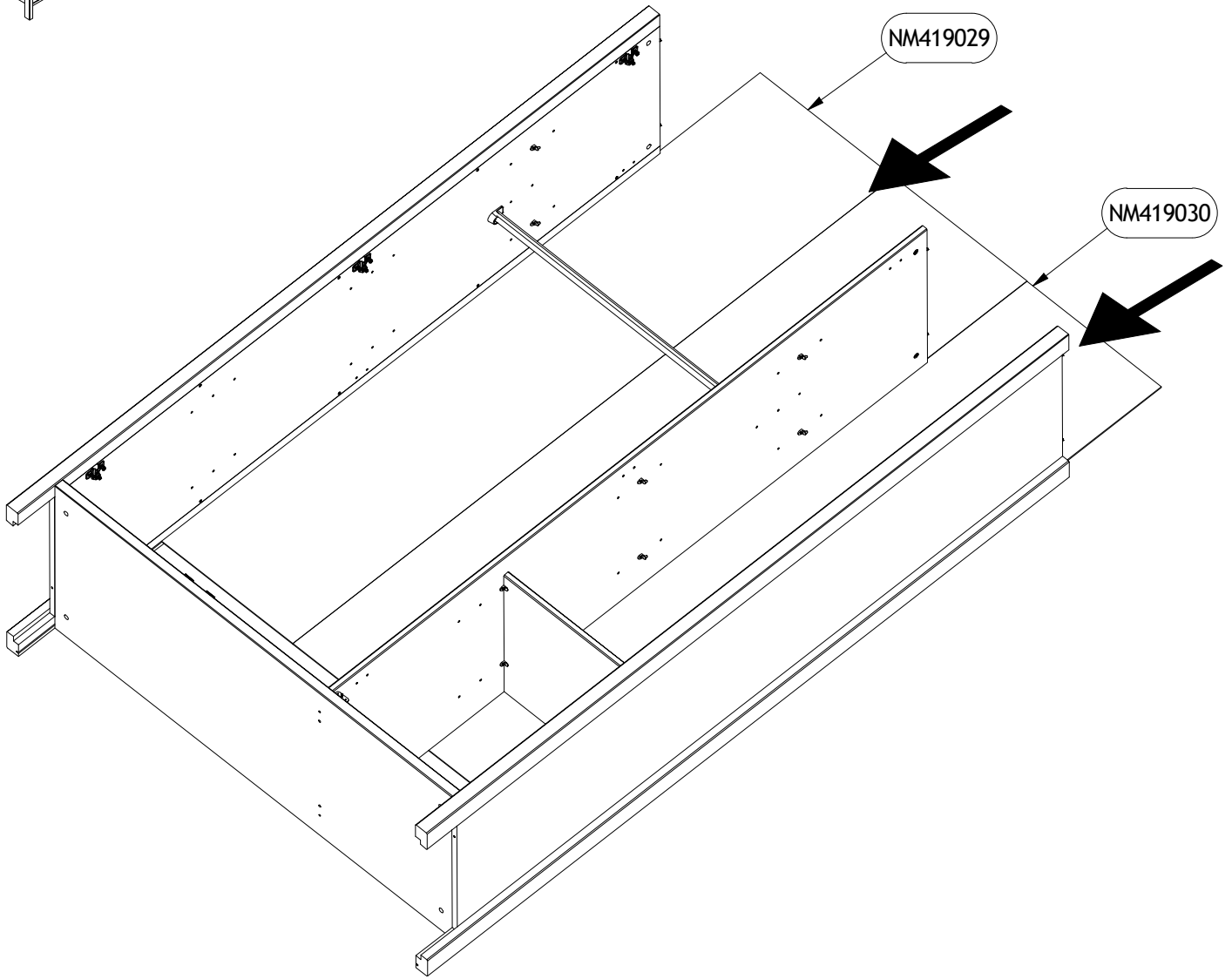
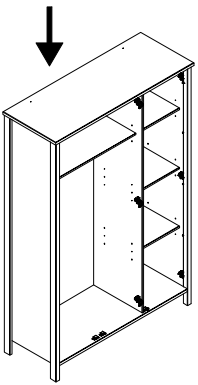

9

BA10597 x 6
ø12x10,2 mm

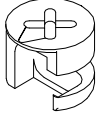

374102

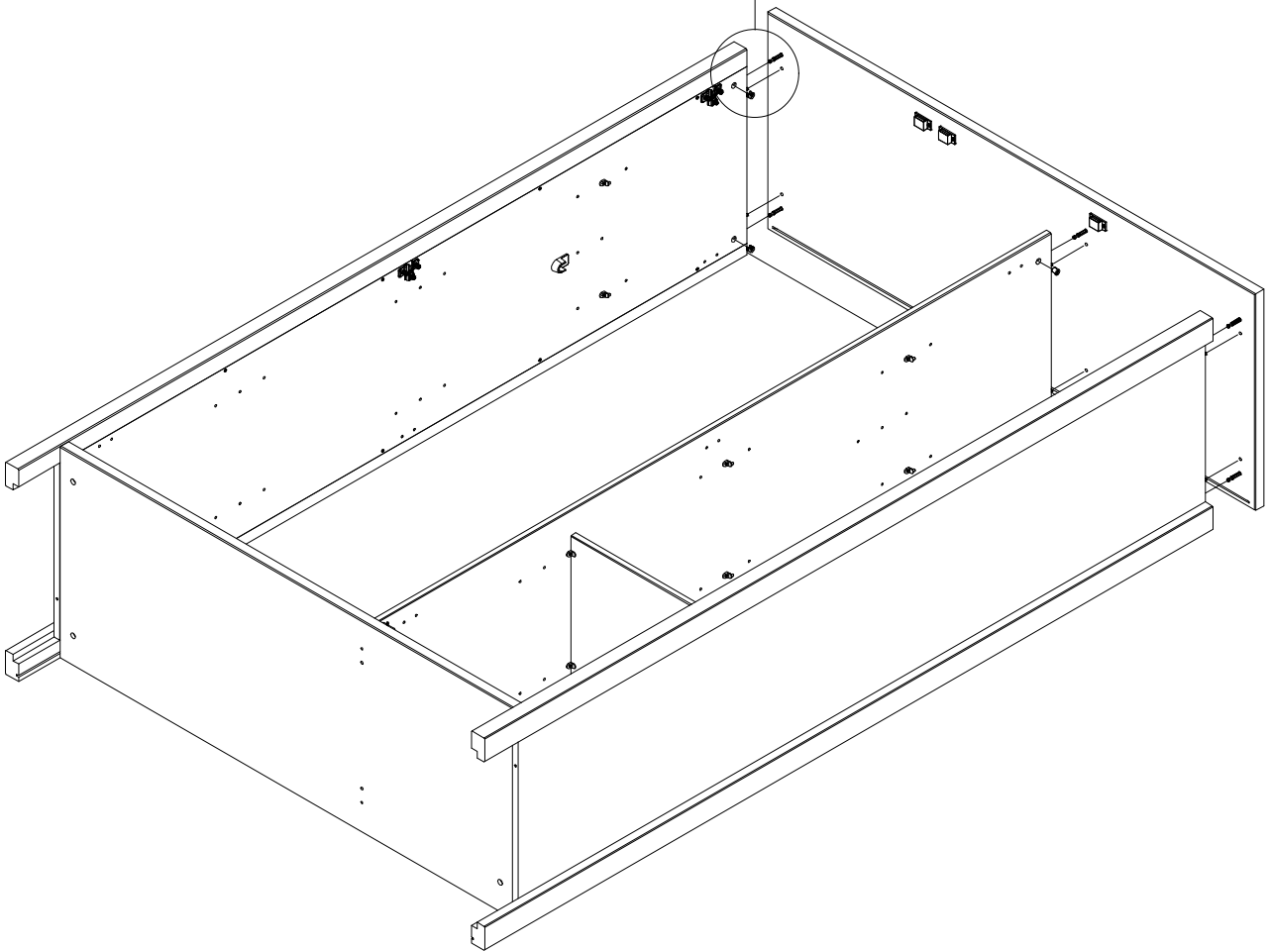
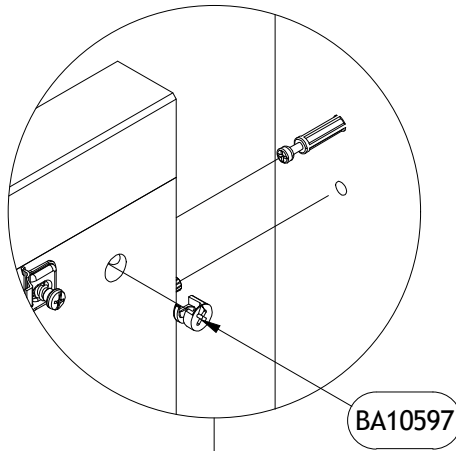
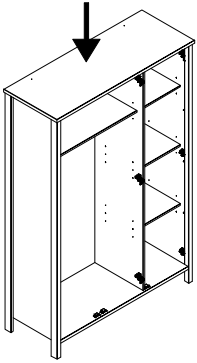

10

BA10833 x 14
15x15x10 mm

BA10837 x 6
19x14 mm

BA10108 x 6
Ø3x20 mm Ø5



374102

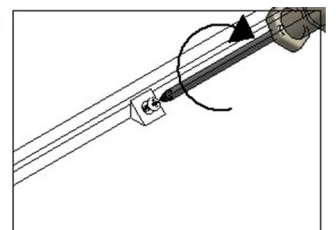
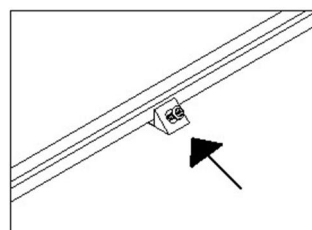
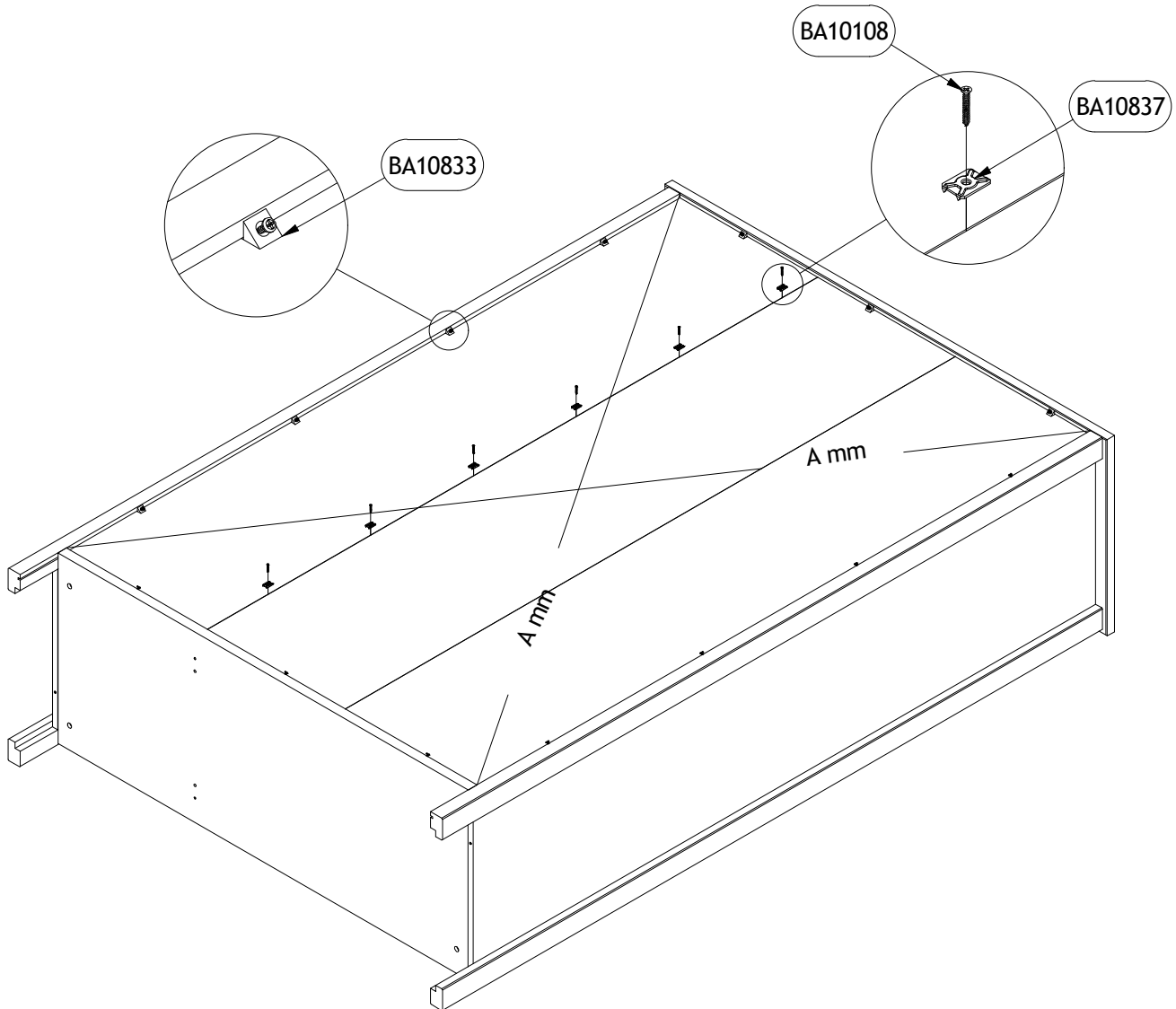
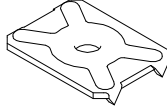
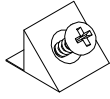

11

BA14685 x 2
76x15x31 mm

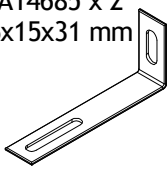

BA10112 x 2
ø3,5x16 mm



374102

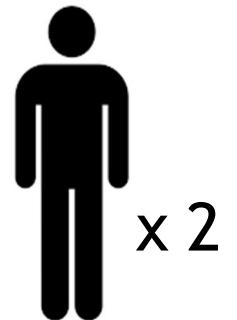
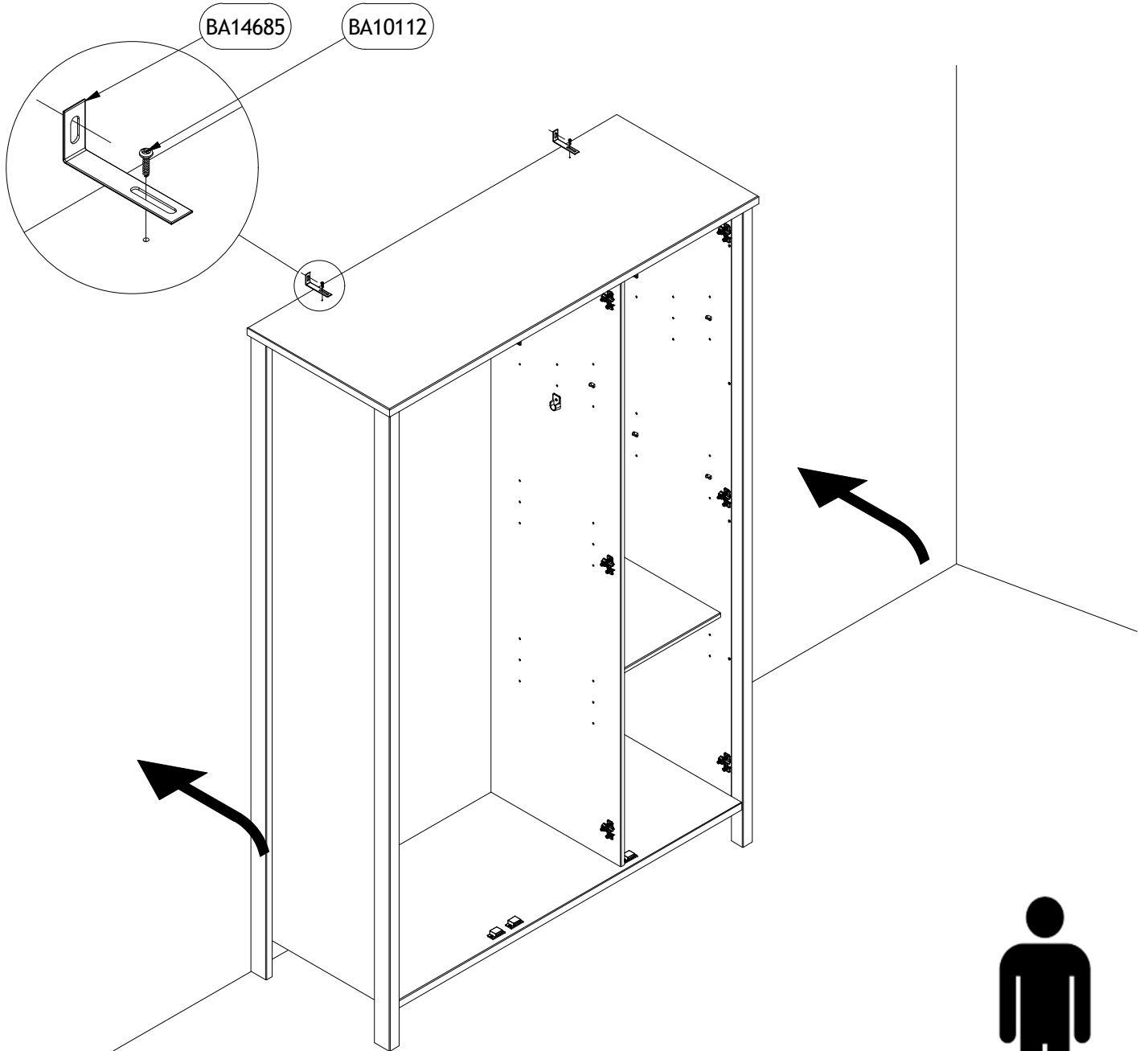

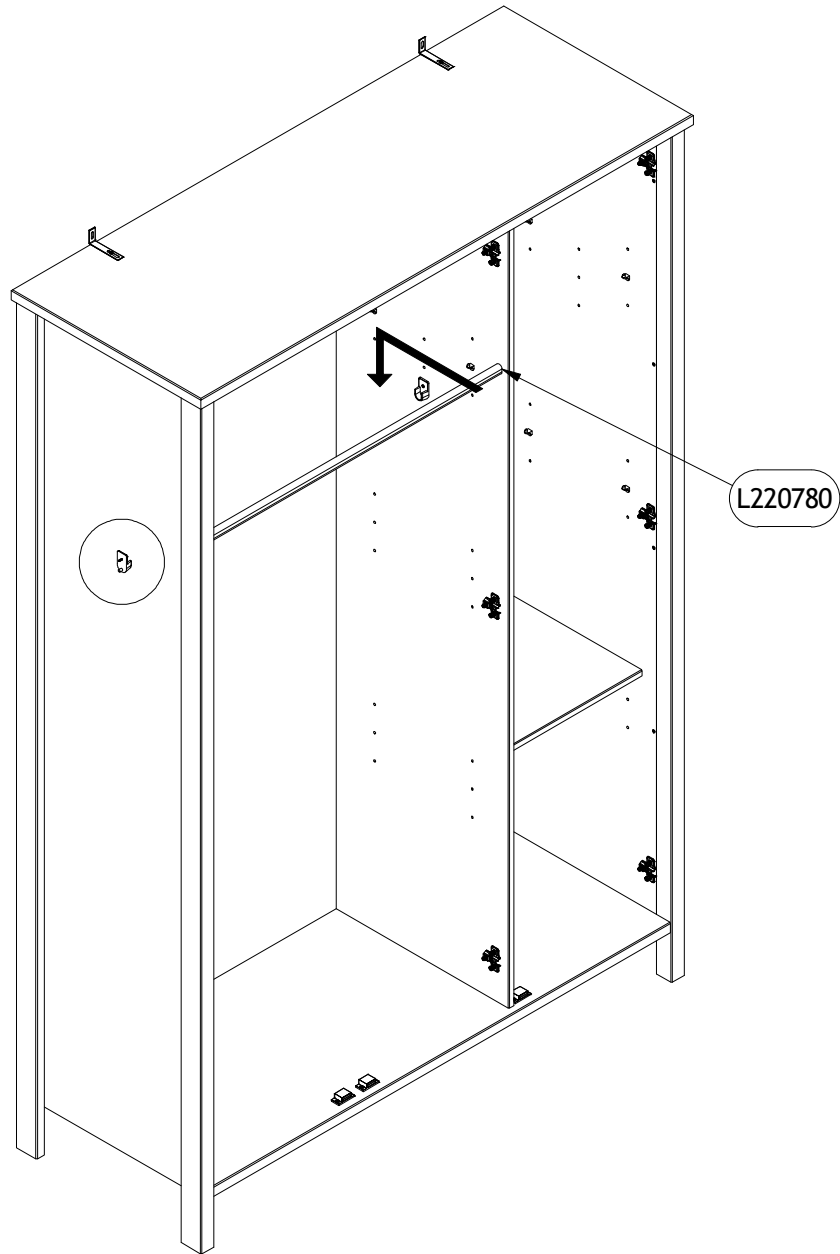

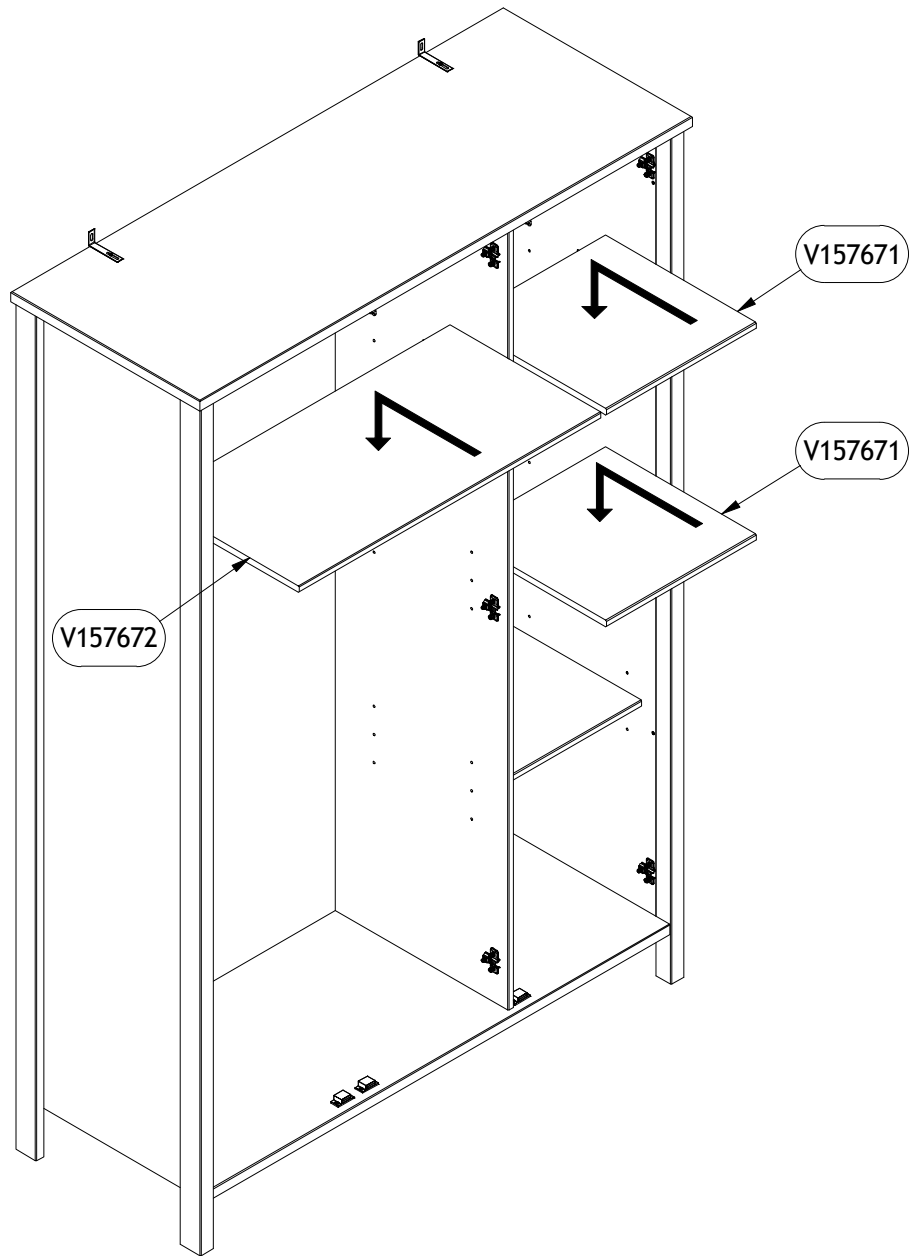

14

BA10524 x 6 BA10120 x 12 BA10709 x 4 BA10102 x 4
ø26/10,5 mm ø3,5x12 mm 35x12 mm ø3,0x12 mm

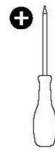
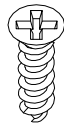
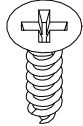
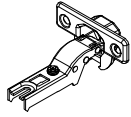

374102

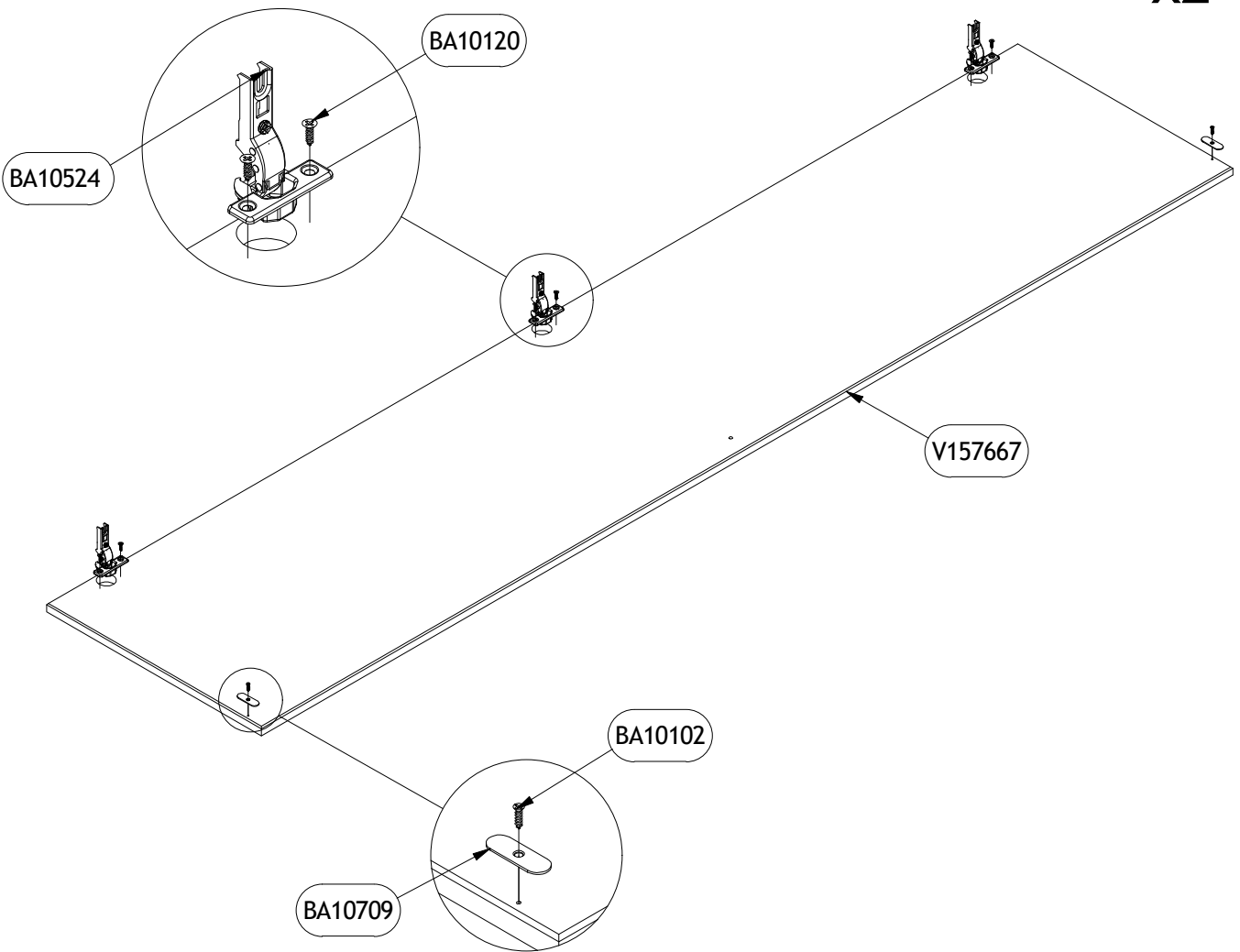
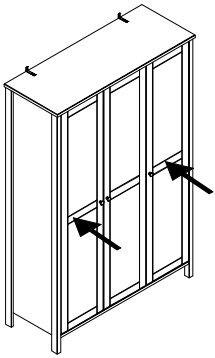

15

BA10508 x 3
ø26/10,5 mm

BA10120 x 6
ø3,5x12 mm

BA10709 x 2
35x12 mm

BA10102 x 2
ø3,0x12 mm



374102

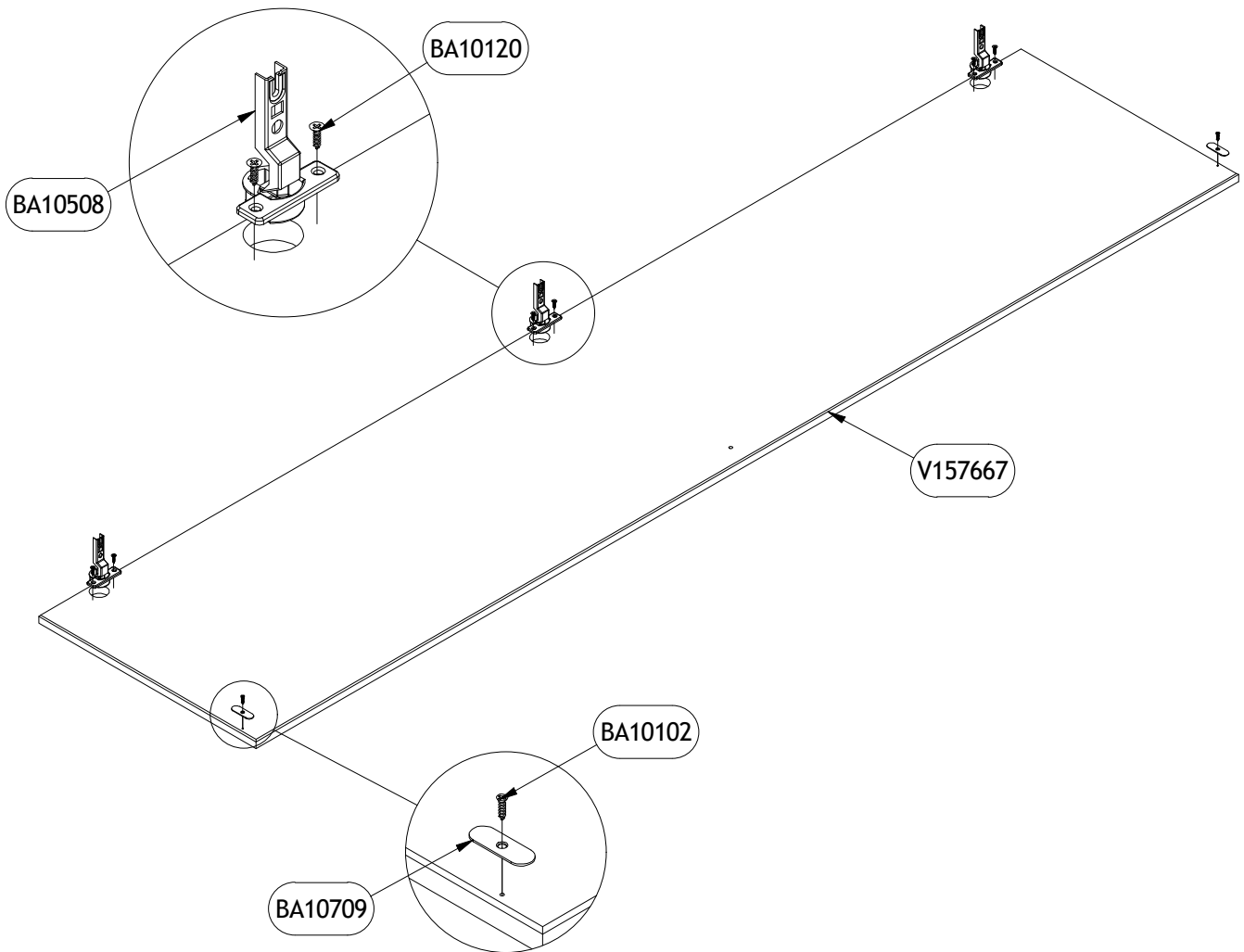
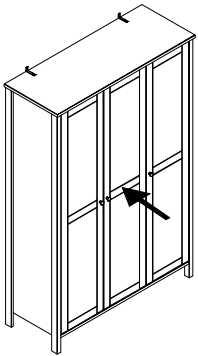
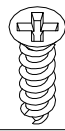
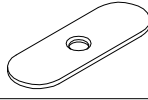
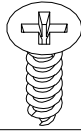
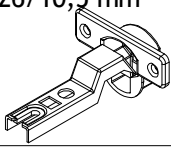

16

BA10501 x 3 BA10223 x 3
ø30x23,5 mm M4x22 mm

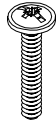

374102

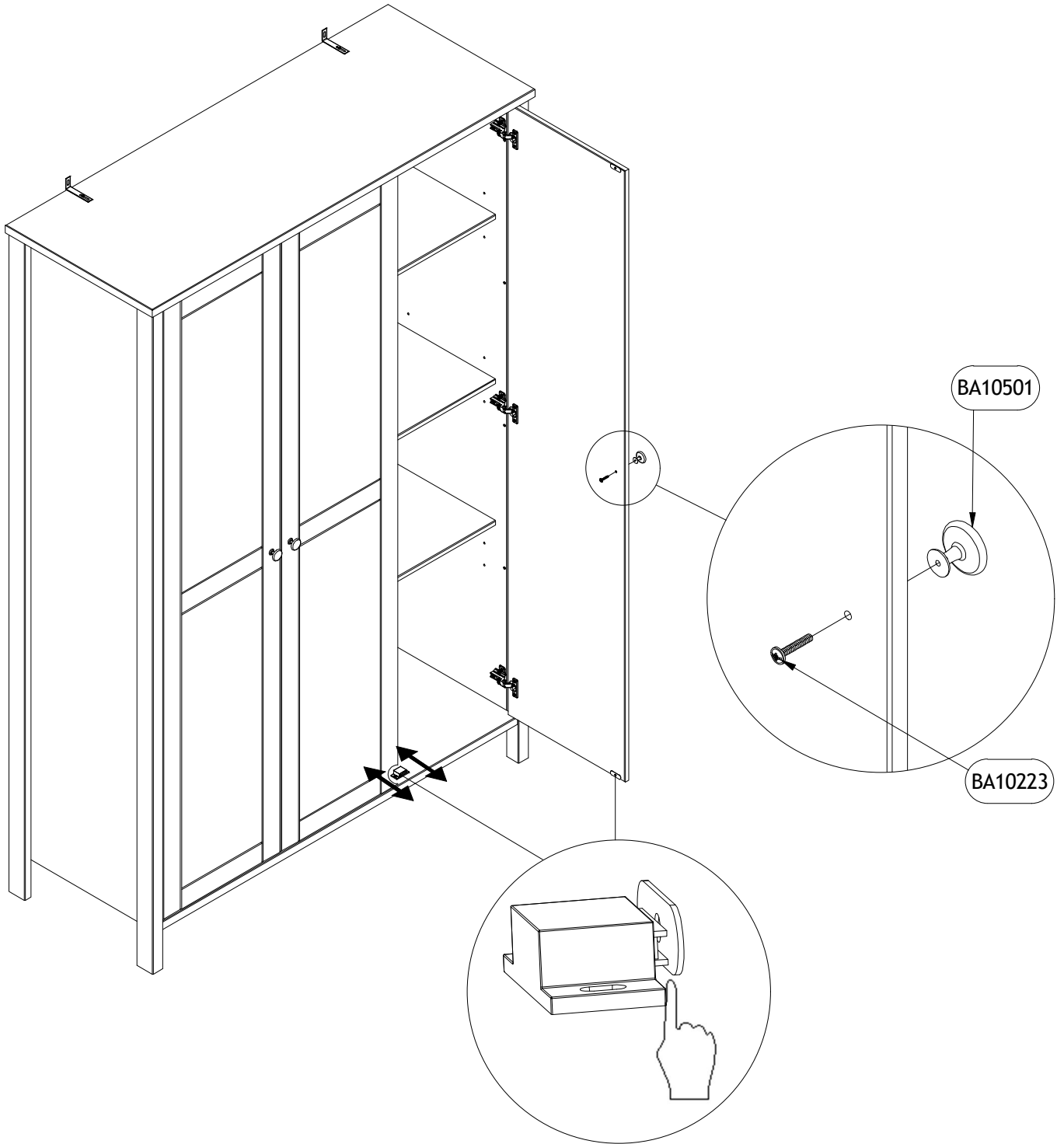

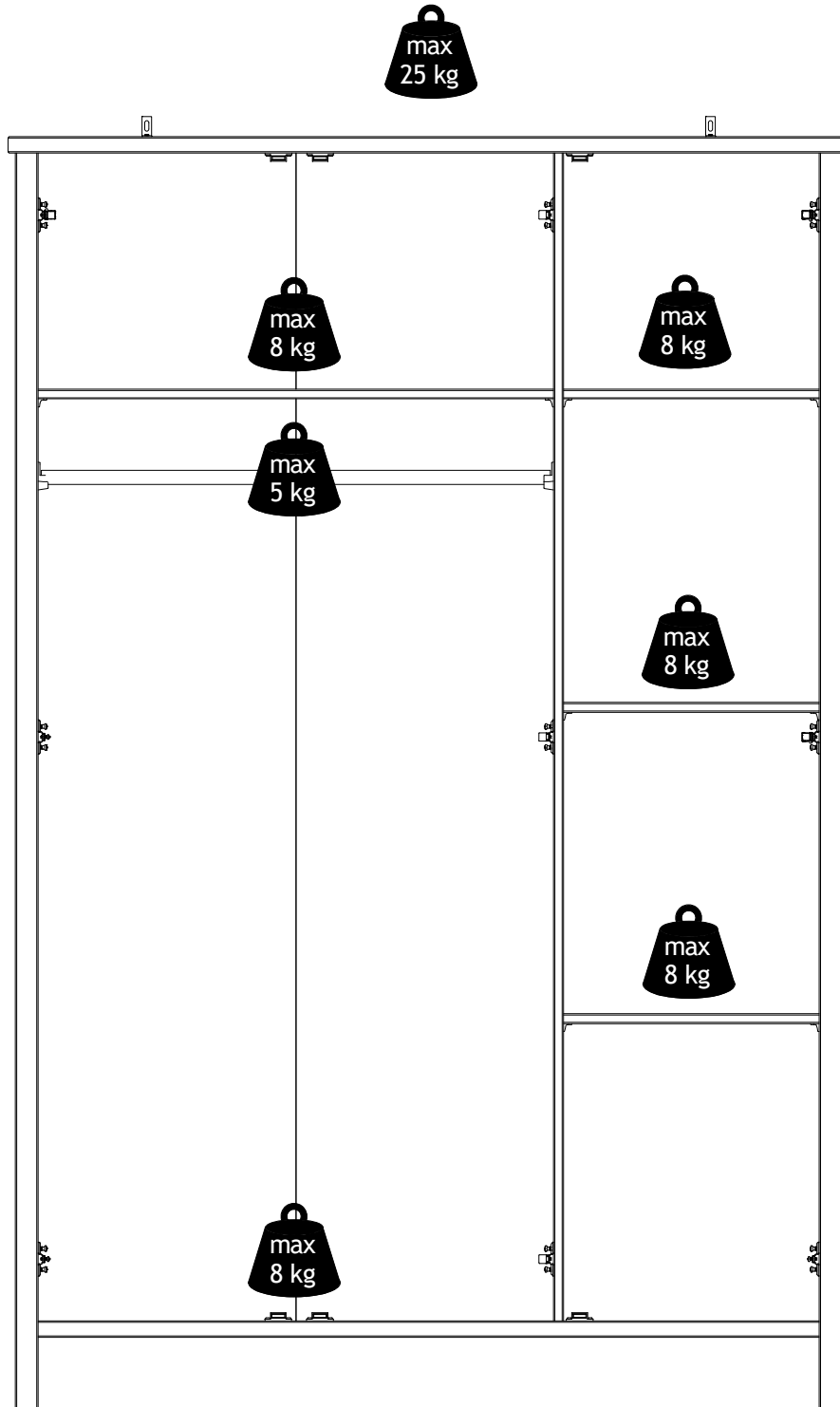

Wall Mounting & Fixings

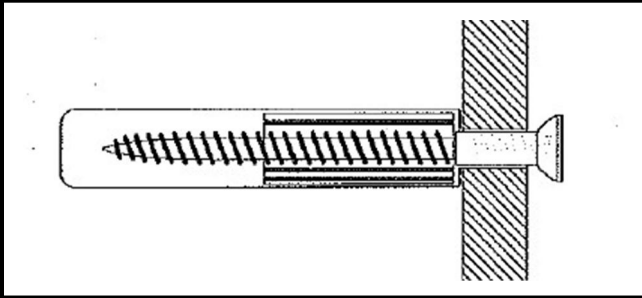

Important:

When drilling into walls always check that there are no hidden wires or pipes ect. Make sure that the screws and wall plugs being used are suitable for supporting your unit. Consult a qualified tradesperson if you are unsure.

HINTS:

- 1) General Rule  Always use a larger screw and a wall plug if you are not sure.
- 2) Ensure you use the recommended drill bit to match the wall plug and hole size.
- 3) Ensure you drill the hole horizontally, do not force the drill or enlarge the hole.
- 4) Take extra care when drilling high walls, ceilings and ceramic tiles. Ensure the plug is fitting below the ceramic tile to avoid splitting or cracking.
- 5) Ensure wall plugs are well fitted and are a tight fit in the drilled hole.

Types of walls

You can use one of the following types of wall plug if your walls are made of brick, breeze block, concrete, stone, wood or plaster board.

No. 1 "Standard" Wall Plug General Wall Materials.

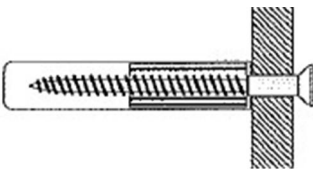

These come in various sizes and are made from plastic or sometimes wood fiber.

No. 2 "General Purpose" Wall Plug Aerated/Breeze Block.

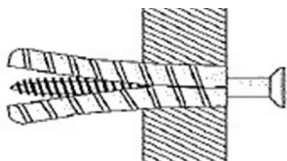

General aerated blocks should not be used to support heavy loads, use a specialist fitting in this case. For light loads, a General Purpose Plug can be used.

No. 3 "Shield Anchor" Wall Plug Heavy loads.

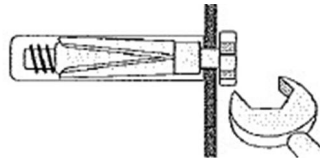

For use with heavier loads such as TV & HiFi Speakers and Satellite Dishes etc.

No. 4 "Cavity Fixing" Wall Plug.

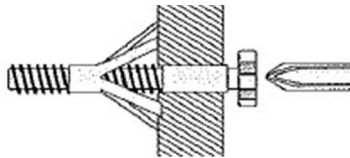

For use with plaster board partitions or hollow wooden doors.

No. 5 "Cavity Fixing Heavy Duty" Wall Plug.

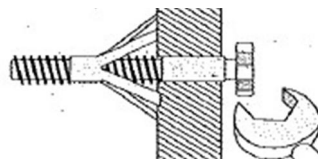

For use when fitting or supporting heavy loads such as shelving, wall cabinets, coat racks.

No. 6 "Hammer Fixing" Wall plug.

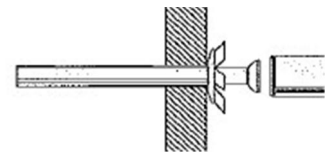

For use with walls stuck with plaster board. The hammer fixing allows it to be fixed to the wall rather than the plaster board. Always check the fixing is secure to the retaining wall.

Care & Maintenance



SAFETY

Always check the fitting and location to ensure your safety in and around the home.

Care & Maintenance



FITTING

From time to time check the fitting to ensure the wall plugs or screws do not become loose.