

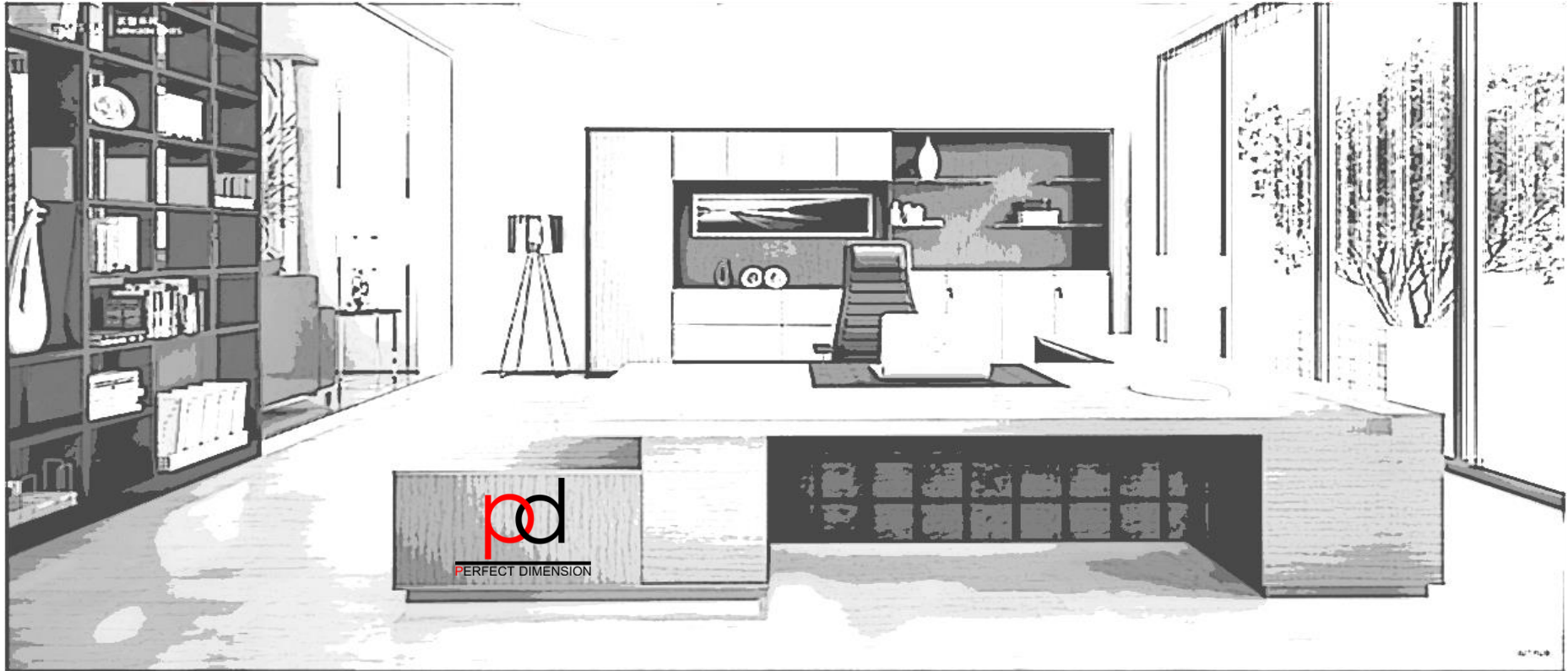

Office furniture

PERFECT DIMENSION
PERFECT DIMENSION



www.p-dimension.com



www.facebook.com/nasef.perfect.dimension

Office furniture

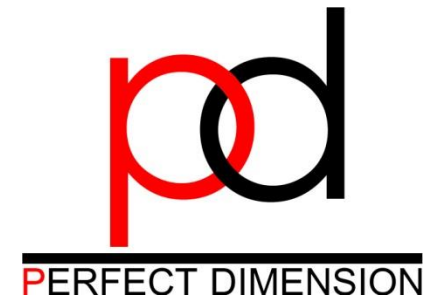

About us

Our company has been newly founded in 2008. We are specialized in the manufacturing of office and home furniture as well as designing different furnishing plans according to our customer's needs and taste. We depend on our highly qualified group. The value of our company is based on the testimony of the customers that have been dealt with already. We strive to update and develop our products to meet the required advancement and high level.



www.p-dimension.com.com

www.facebook.com/nasef.perfect.dimension



Our Products

Meeting Table

Manager Desk

CABINETS

WORK STATION

Senior Desk

SOFA

Partition

CHAIR

Laboratory

Counter

corian

DOORS

Projects

Cladding



Office furniture

Manager

EXECUTIVE

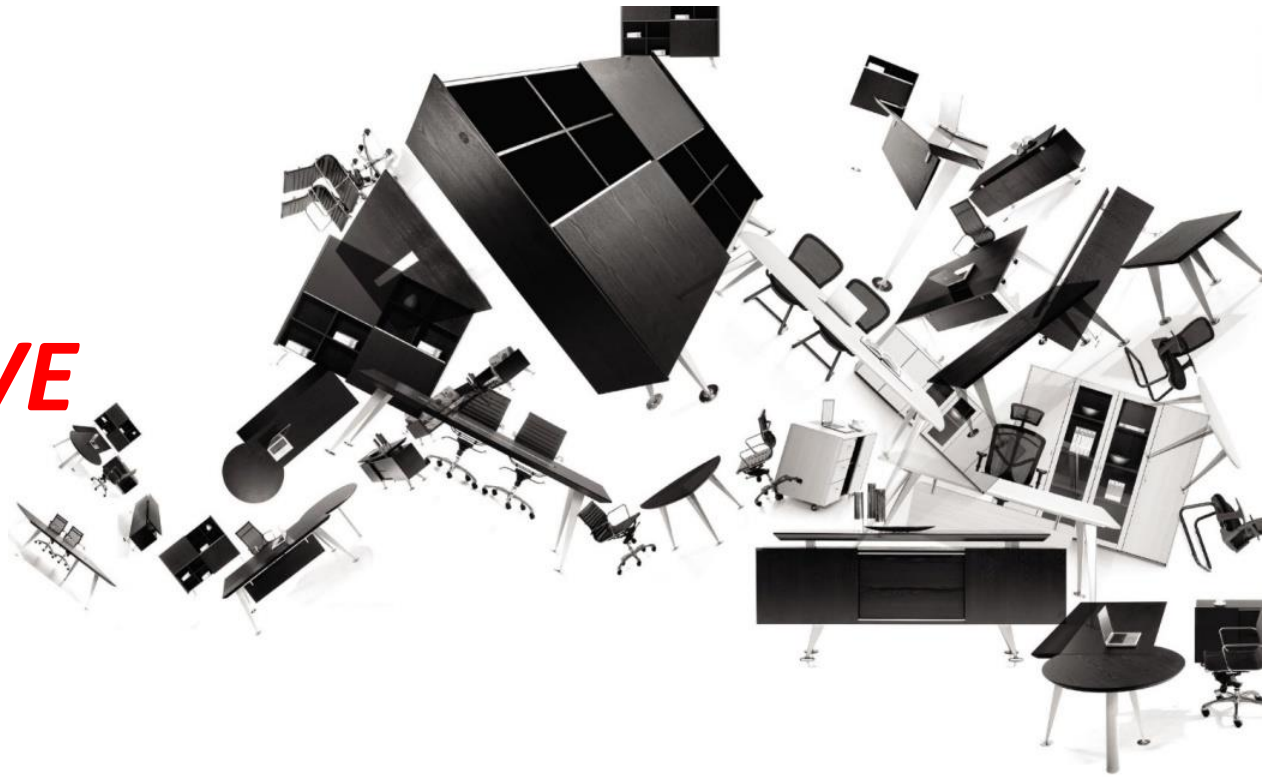

www.p-dimension.com



www.facebook.com/nasef.perfect.dimension

Manager Desk



CODE
PD250



CODE
PD 260



www.p-dimension.com



www.facebook.com/nasef.perfect.dimension

Manager Desk



CODE
OMIGA LINE 2

Office furniture

CODE
OMIGA LINE 1

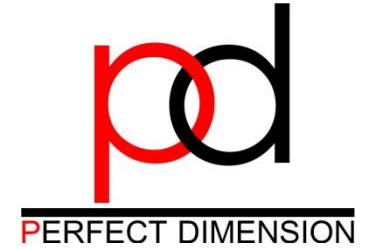

www.p-dimension.com



www.facebook.com/nasef.perfect.dimension

Manager Desk



CODE
LEXUS 1

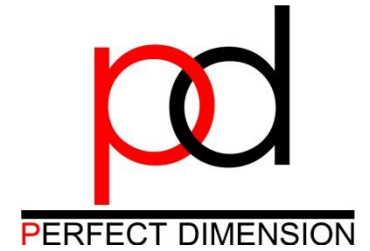

CODE
LEXUS 2



www.p-dimension.com



www.facebook.com/nasef.perfect.dimension

Manager Desk



Office furniture

CODE
MASTER LINE

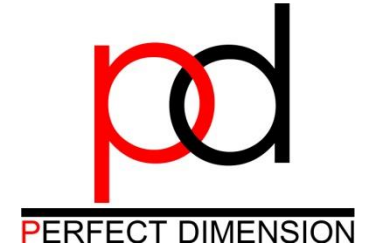

CODE
EASY LINE



www.p-dimension.com



www.facebook.com/nasef.perfect.dimension

Manager Desk



CODE
ALFA LINE

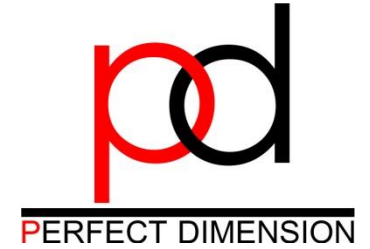

CODE
VOCO MR



www.p-dimension.com



www.facebook.com/nasef.perfect.dimension

Manager Desk



CODE 240

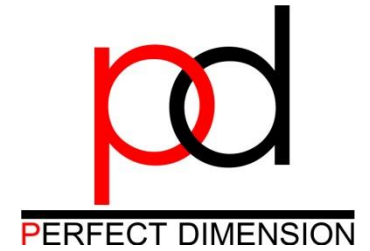

CODE
MARIO



www.p-dimension.com



www.facebook.com/nasef.perfect.dimension

Manager Desk

Office furniture



CODE
MA-0102



www.p-dimension.com



www.facebook.com/nasef.perfect.dimension

Manager Desk

Office furniture



CODE
MA-190



Manufactured from M.D.F covered
LPL -HPLthe structure base is from
wooden from same colors.
The Desk Dimensions is
(180:220)*90*75 c.m and contains
Side desk



www.p-dimension.com



www.facebook.com/nasef.perfect.dimension

Manager Desk

Office furniture



CODE
MA-0103

Manufactured from M.D.F covered LPL -HPL the structure base is from wooden from same colors. The Desk Dimensions is (240)*90*75 c.m and contains Side desk



www.p-dimension.com



www.facebook.com/nasef.perfect.dimension

Manager Desk

Office furniture



CODE
MA-1002



Manufactured from M.D.F covered LPL -HPL the structure base is from wooden from same colors.
The Desk Dimensions is (240)*90*75 c.m and contains Side desk



www.p-dimension.com



www.facebook.com/nasef.perfect.dimension

Manager Desk

Office furniture



CODE
MA-201



Manufactured from M.D.F covered LPL -HPLthe structure base is from wooden from same colors.

The Desk Dimensions is (240)*90*75 c.m and contains Side desk



www.p-dimension.com



www.facebook.com/nasef.perfect.dimension

Manager Desk

Office furniture



CODE
MA-10

Manufactured from M.D.F covered LPL
-HPL the structure base is from wooden
from same colors.
The Desk Dimensions is
(180:220)*90*75 c.m and contains Side
desk



www.p-dimension.com



www.facebook.com/nasef.perfect.dimension



Manager Desk

Office furniture



CODE
MA-7



Dimension is (180:200) x80x75 cm
Desk Provided with Drawer unit &
Side table .
Top is made of black modern glass.



CODE
MA-8

JO-1010B (分左右)
(2200x1800x760) P5400
(2000x1800x760) P5200 ★



www.p-dimension.com



www.facebook.com/nasef.perfect.dimension

Manager Desk

Office furniture



pd
PERFECT DIMENSION



Manufactured from M.D.F covered LPL -HPL the structure base is from wooden from same colors.
The Desk Dimensions is (180:220)*90*75 c.m and contains Side desk



www.p-dimension.com



www.facebook.com/nasef.perfect.dimension

Manager Desk

Office furniture



CODE
MA-19

Manufactured from M.D.F covered LPL -HPL the structure base is from wooden from same colors. The Desk Dimensions is (180:220)*90*75 c.m and contains Side desk



CODE
MA-18

pd
PERFECT DIMENSION



www.p-dimension.com



www.facebook.com/nasef.perfect.dimension

Manager Desk

Office furniture



www.p-dimension.com



www.facebook.com/nasef.perfect.dimension

pd
PERFECT DIMENSION

Manager Desk

Office furniture



CODE
MA-16



CODE
MA-15

Manufactured from M.D.F covered LPL -HPLthe structure base is from wooden from same colors.
The Desk Dimensions is (180:220)*90*75 c.m and contains Side desk



www.p-dimension.com



www.facebook.com/nasef.perfect.dimension

pd
PERFECT DIMENSION

Manager Desk



CODE
MA-14

Office furniture



CODE
MA-13



www.p-dimension.com



www.facebook.com/nasef.perfect.dimension

pd
PERFECT DIMENSION

Manager Desk

Office furniture



CODE
MA-0103



www.p-dimension.com



www.facebook.com/nasef.perfect.dimension

pd
PERFECT DIMENSION

Manager Desk

Office furniture

The Desk Dimensions is 210*80*75 c.m or 180*80*75 c.m and contains drawer & Side table .
Side table including c.p.u holder , one hanged door & 3 drawer.



pd
PERFECT DIMENSION

CODE
MA 24

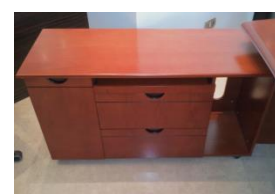

www.p-dimension.com



www.facebook.com/nasef.perfect.dimension

Manager Desk

Office furniture



Manufactured from M.D.F covered
LPL -HPL the structure base is from
wooden from same colors.
The Desk Dimensions is
(180:220)*90*75 c.m and contains
Side desk



www.p-dimension.com



www.facebook.com/nasef.perfect.dimension

Manager Desk

Office furniture



CODE
MA-202



Manufactured from M.D.F covered LPL -HPL the structure base is from wooden from same colors.

The Desk Dimensions is (240)*90*75 c.m and contains Side desk



www.p-dimension.com



www.facebook.com/nasef.perfect.dimension



Office furniture

Senior Desk

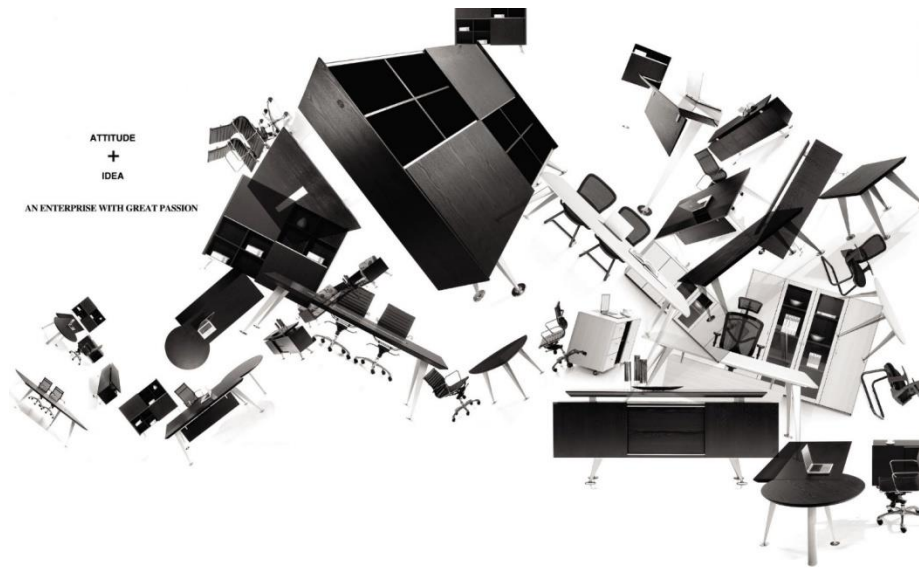

www.p-dimension.com



www.facebook.com/nasef.perfect.dimension

Senior Desk



PD VOCO S



Pd VOCOR



www.p-dimension.com



www.facebook.com/nasef.perfect.dimension

Senior Desk



PD ALFA W



PD ALFA M



www.p-dimension.com



www.facebook.com/nasef.perfect.dimension

Senior Desk



PD CYPER

Office furniture



PD DELAT

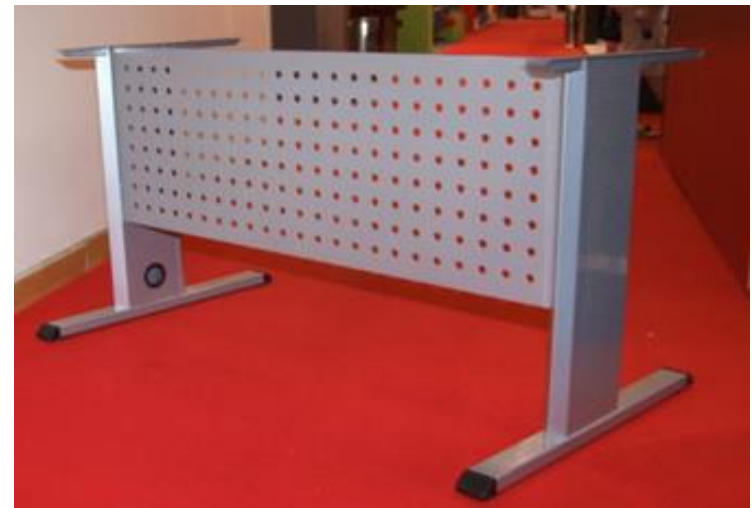

www.p-dimension.com



www.facebook.com/nasef.perfect.dimension

Senior Desk



PD LIGHT S



PD LIGHT R



www.p-dimension.com



www.facebook.com/nasef.perfect.dimension

Senior Desk



Office furniture

PD NEW 1



PD NEW 2



www.p-dimension.com



www.facebook.com/nasef.perfect.dimension

Senior Desk

Office furniture



NEW SHARK

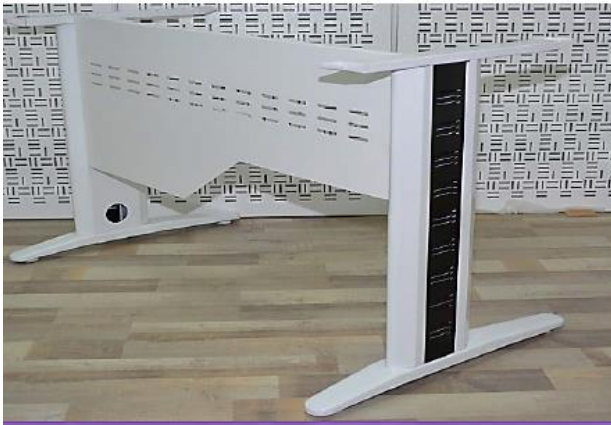

CODE
VA-27



pd

PERFECT DIMENSION



www.p-dimension.com



www.facebook.com/nasef.perfect.dimension

Senior Desk



Office furniture

CODE
VA-44



pd
PERFECT DIMENSION

BOX TYPE SYSTEM



CODE
VA-55



www.p-dimension.com



www.facebook.com/nasef.perfect.dimension

Senior Desk



Office furniture



CREATIVE

CODE
VA-64



www.p-dimension.com



www.facebook.com/nasef.perfect.dimension

Senior Desk

Office furniture

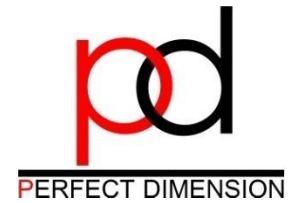
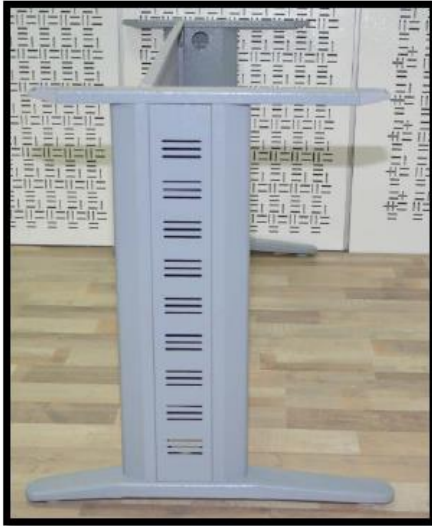

CODE
VA-92



SHARK



www.p-dimension.com



www.facebook.com/nasef.perfect.dimension

Senior Desk

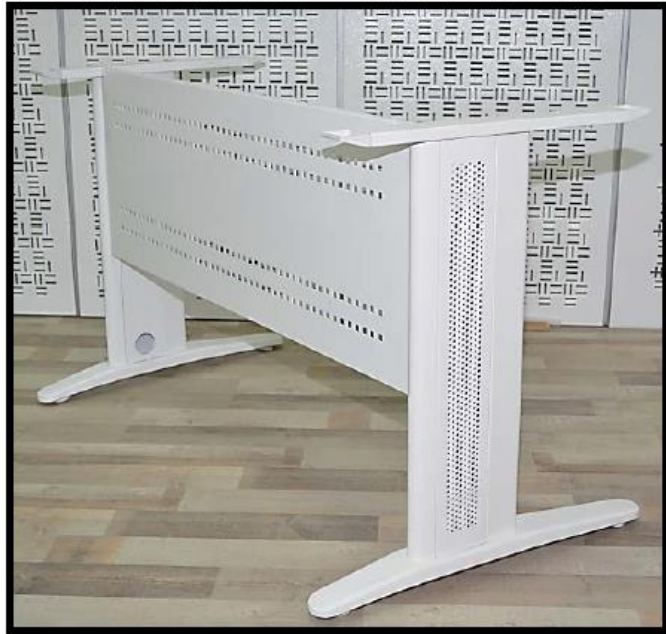

Office furniture



CODE
VA-52

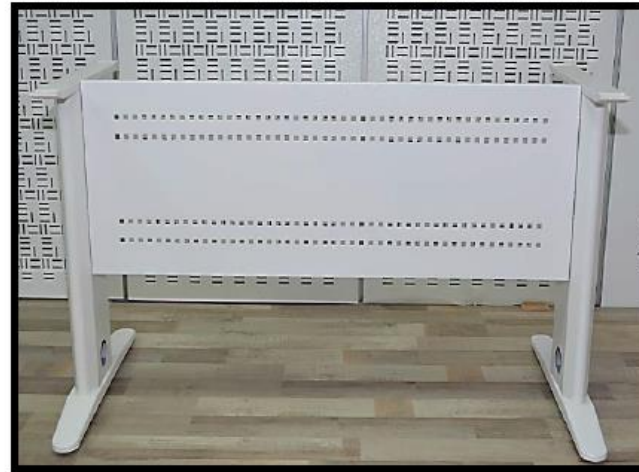

CLASSIC



www.p-dimension.com



www.facebook.com/nasef.perfect.dimension

Senior Desk



Office furniture

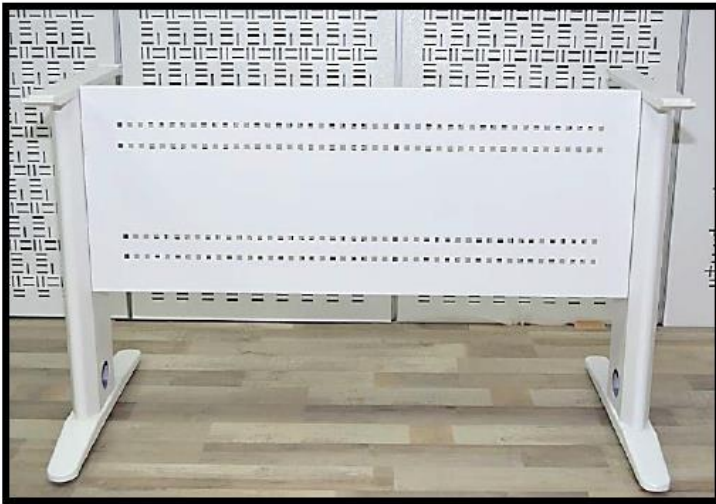

CODE
VA-42

LIGHT V



www.p-dimension.com



www.facebook.com/nasef.perfect.dimension

Senior Desk

Office furniture

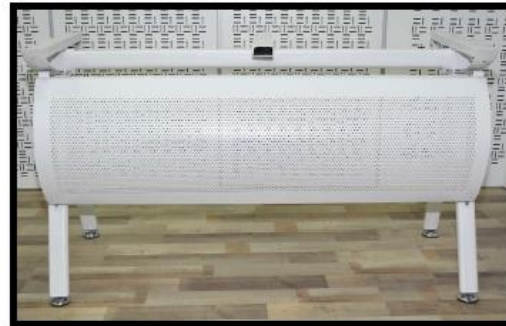

CODE
VA-10



ROUND



www.p-dimension.com



www.facebook.com/nasef.perfect.dimension

Senior Desk

Office furniture

BETA LINE



www.p-dimension.com



www.facebook.com/nasef.perfect.dimension

Senior Desk



Office furniture

CHEEB LINE



www.p-dimension.com



www.facebook.com/nasef.perfect.dimension

Senior Desk

Office furniture



CODE MA 1010



www.p-dimension.com



www.facebook.com/nasef.perfect.dimension

Senior Desk



CODE : ELE200



Office furniture

MDF desk top-thickness:25 mm
 alu. Frame,with cable box
 coating steel panel-under top
 main talbe:W180X D90X H750
 side talbe:W900*D500*H750CODE : ELE100
 Square meeting table with metal legs
 cabinets six doors glass & wood , same color of
 desk & panel, holed on metal cube

CODE
SE 25



CODE : ELE-MT200

CODE
SE 26

RIADCO 27

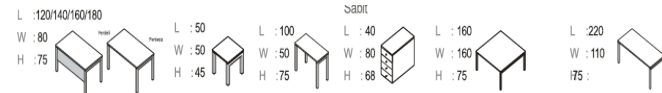

www.p-dimension.com

www.facebook.com/nasef.perfect.dimension

Senior Desk

Office furniture



CODE
SE 27



www.p-dimension.com



www.facebook.com/nasef.perfect.dimension

Senior Desk

Office furniture



CODE
SE 070

Dimensions L -140-160-180 CM.



CODE
SE 071



CODE
SE 072



www.p-dimension.com



www.facebook.com/nasef.perfect.dimension

Senior Desk

Office furniture



www.p-dimension.com



www.facebook.com/nasef.perfect.dimension

Senior Desk

Office furniture



www.p-dimension.com



www.facebook.com/nasef.perfect.dimension

Senior Desk

Office furniture



CODE
SE 080

Dimensions L -140-160-180 CM.



www.p-dimension.com



www.facebook.com/nasef.perfect.dimension

COFFEE TABLE

Office furniture



CODE
C.T 19



CODE
C.T 18



CODE
C.T 17



CODE
C.T 22



CODE
C.T 21



CODE
C.T 20



CODE
C.T 26



CODE
C.T 25



CODE
C.T 24



CODE
C.T 23



www.p-dimension.com



www.facebook.com/nasef.perfect.dimension

CABINETS

Office furniture



www.p-dimension.com



www.facebook.com/nasef.perfect.dimension

Office furniture

CABINETS



PERFECT DIMENSION

CODE
CAB 31

CODE
CAB 32

CODE
CAB 28



CAB1



CODE
CAB 30



CODE
CAB 29



www.p-dimension.com



www.facebook.com/nasef.perfect.dimension

CABINETS

Office furniture



CABL12



CAB13



CAB14



CAB15



PERFECT DIMENSION



CABL1



CABL2



CABL3



CABL4



CAB21



CAB22



CAB23



www.p-dimension.com



www.facebook.com/nasef.perfect.dimension

CABINETS

Office furniture



CODE
CAB 212



CODE
CAB 211



CODE
CAB 210



CODE
CAB 215



CODE
CAB 2014



CODE
CAB 213



www.p-dimension.com



www.facebook.com/nasef.perfect.dimension

CABINETS

Office furniture



CAB.919



CAB.920



CAB.921



CAB.922

CABINET.

ALL SIZE

IMPORTED HANDEL.



CAB.923



CAB.924



CAB.925



CAB.926



www.p-dimension.com



www.facebook.com/nasef.perfect.dimension

CABINETS

Office furniture



CODE
CAB 202



www.p-dimension.com



www.facebook.com/nasef.perfect.dimension

PERFECT DIMENSION

CABINETS

Office furniture



CODE
CAB 2111



CODE
CAB 203



www.p-dimension.com



www.facebook.com/nasef.perfect.dimension

CABINETS

Office furniture



CODE
CAB 205



CODE
CAB 204



www.p-dimension.com



www.facebook.com/nasef.perfect.dimension

CABINETS

Office furniture

CABINET.
ALL SIZE
New P.V.C
Design,,,,,,,,



CAB.91



CAB.92

All Cabinet designed from M.D.F wood with 18mm thickness.
The layer witchs put of the wood can be L.P.L or H.P.L,
The hanging door can be glass and wood door.
The glass door thickness 5mm.
The all cabinet have a central lock.
The cabinets handle is from metal.
The pedestal drawer is install in telescoped accessories.



CAB.93



CAB.94



CAB.95



www.p-dimension.com



www.facebook.com/nasef.perfect.dimension

CABINETS

Office furniture



www.p-dimension.com



www.facebook.com/nasef.perfect.dimension

pd
PERFECT DIMENSION



Meeting Table

Office furniture

Meeting Table



CODE
ME 35



CODE
ME 34



www.p-dimension.com



www.facebook.com/nasef.perfect.dimension

Office furniture

Meeting Table

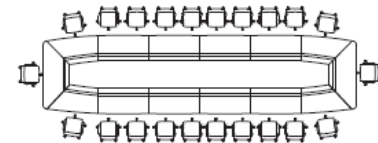
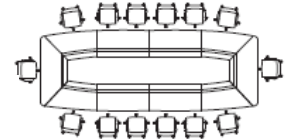
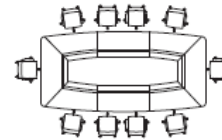
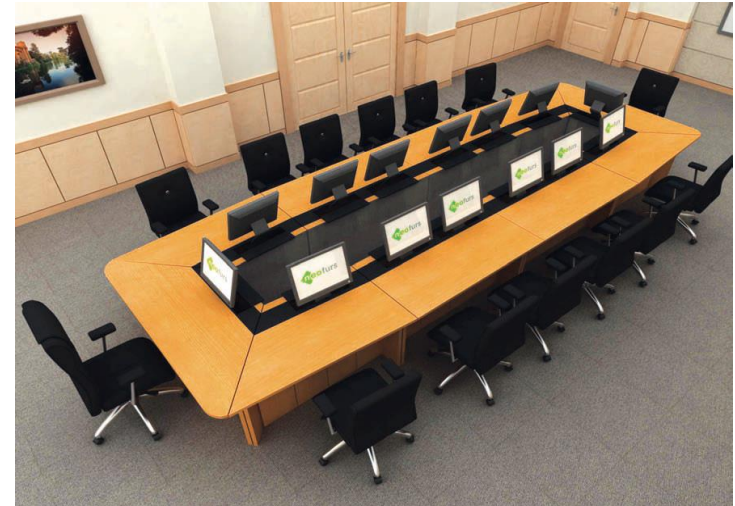
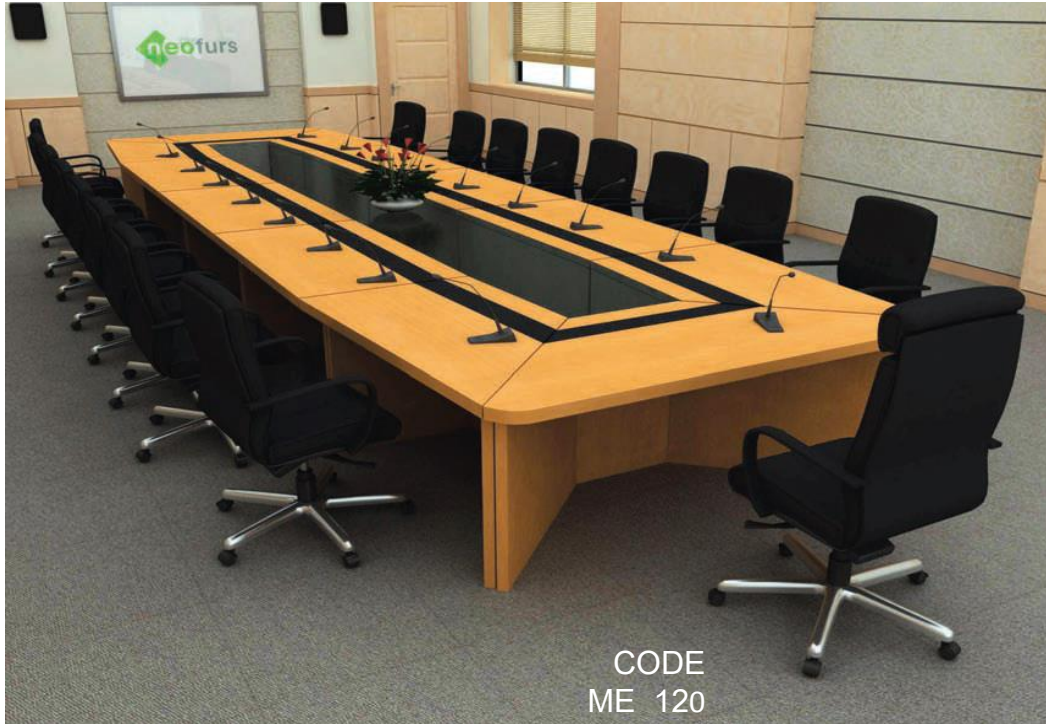

www.p-dimension.com



www.facebook.com/nasef.perfect.dimension

Office furniture

Meeting Table

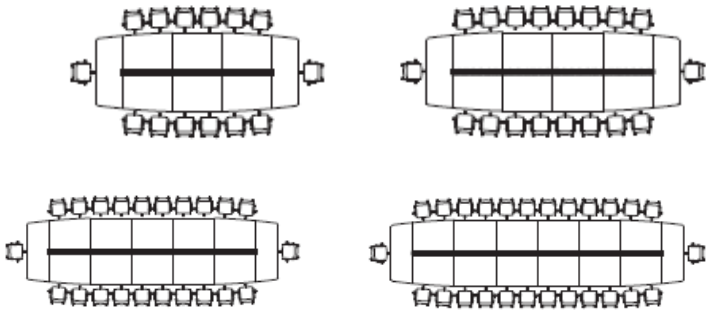

www.p-dimension.com



www.facebook.com/nasef.perfect.dimension

Office furniture

Meeting Table



CODE
ME 42

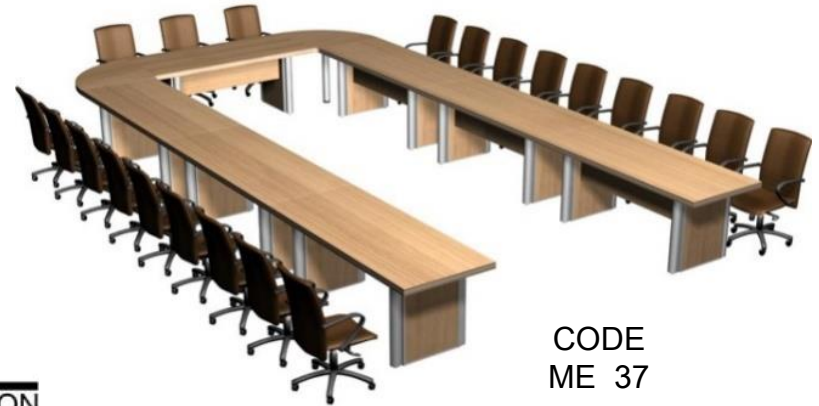

CODE
ME 37



CODE
ME 41



www.p-dimension.com



www.facebook.com/nasef.perfect.dimension

Office furniture

Meeting Table



CREATIVE SPACE

The "HC7" series creates a forward looking creative space with a cutting edge design and excellent functionality. You can choose between 2 colors, white or natural. You can choose to create the conference room that you desire



CODE
ME 38



www.p-dimension.com



www.facebook.com/nasef.perfect.dimension

Office furniture

Meeting Table



CODE
ME 45



CODE
ME 46



www.p-dimension.com



www.facebook.com/nasef.perfect.dimension

Office furniture

Meeting Table



CODE
MT 1100



CODE
MT 1000



www.p-dimension.com



www.facebook.com/nasef.perfect.dimension

Office furniture

Meeting Table



www.p-dimension.com



www.facebook.com/nasef.perfect.dimension

Office furniture

Meeting Table



www.p-dimension.com



www.facebook.com/nasef.perfect.dimension

Office furniture

Meeting Table



www.p-dimension.com



www.facebook.com/nasef.perfect.dimension

Office furniture

Meeting Table



CODE
ME 303

CREATIVE SPACE

The "HC/" series creates a forward looking creative space with a cutting edge design and excellent functionality. You can choose between 2 colors, white or natural. You can choose to create the conference room that you desire



www.p-dimension.com



www.facebook.com/nasef.perfect.dimension

Office furniture

Meeting Table

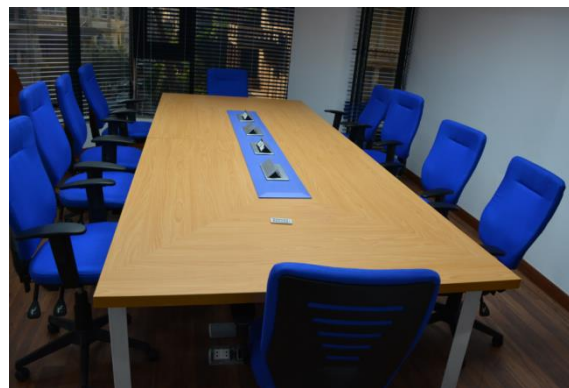

www.p-dimension.com



www.facebook.com/nasef.perfect.dimension

WORK STATION

Office furniture

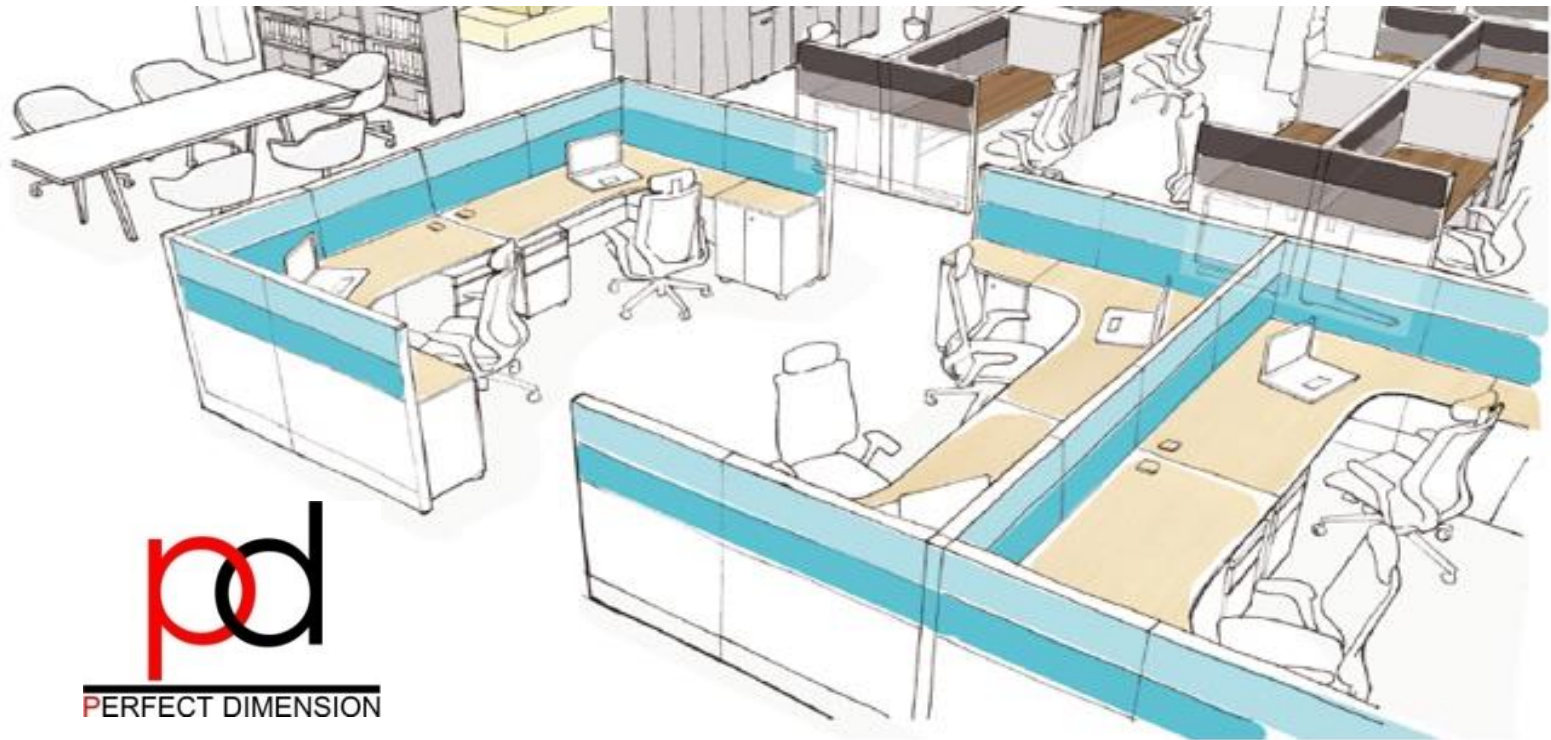

Light WORK SYSTEM



www.p-dimension.com



www.facebook.com/nasef.perfect.dimension

WORK STATION



PERFECT DIMENSION

Office furniture

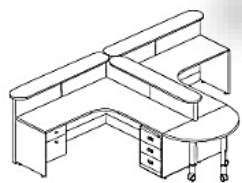

Reception's workstation



120° workstation

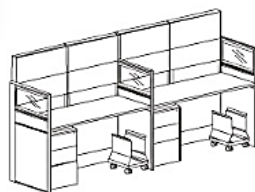

Call center

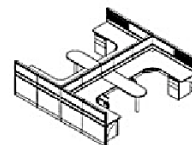

750-WS4-03

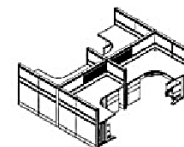

750-WS4-04

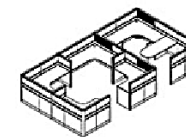

750-WS5-02

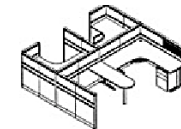

750-WS3-02

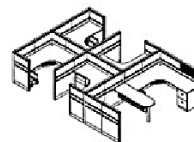

750-WS5-03

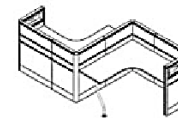

750-WS2-03

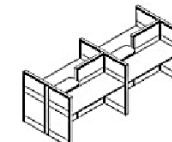

750-WS4-05

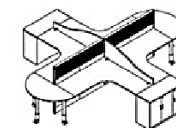

750-WS4-06

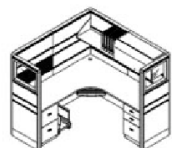

750-WS1-03

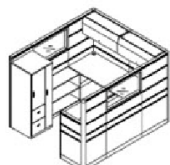

750-WS1-04

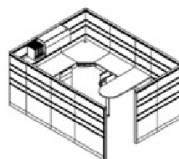

750-WS1-05

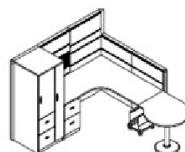

750-WS1-06

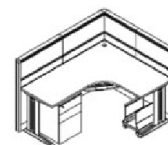

750-WS1-01

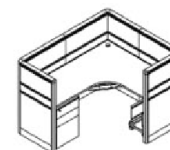

750-WS1-02

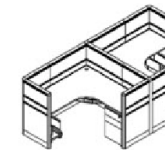

750-WS2-01

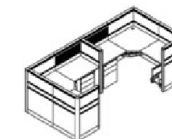

750-WS2-02

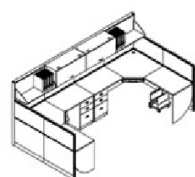

750-WS2-04
(T&W connection)

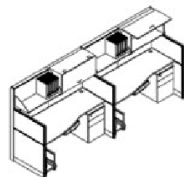

750-WS2-05
(T&W connection)

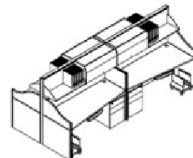

750-WS4-07
(T&W connection)

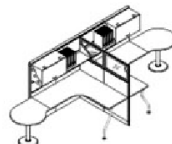

750-WS2-06
(T&W connection)



750-WS3-01

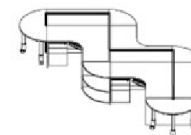

750-WS5-01

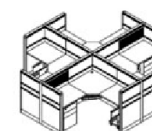

750-WS4-01

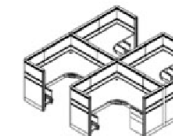

750-WS4-02



www.p-dimension.com



www.facebook.com/nasef.perfect.dimension

WORK STATION

Office furniture

Light WORK SYSTEM

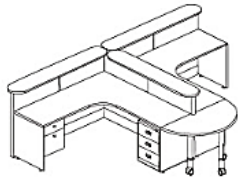

Reception's workstation



120° workstation

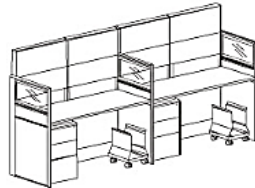

Call center

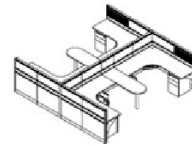

750-WS4-03

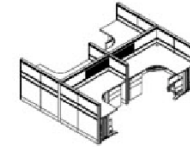

750-WS4-04

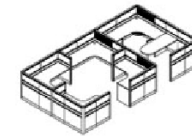

750-WS5-02

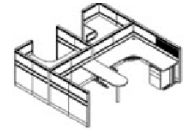

750-WS3-02

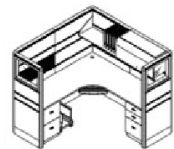

750-WS1-03

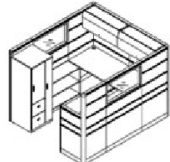

750-WS1-04

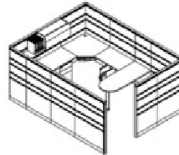

750-WS1-05

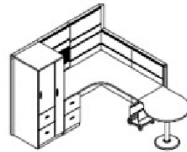

750-WS1-06

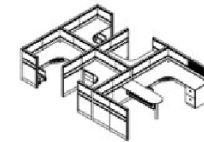

750-WS5-03

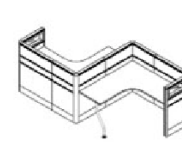

750-WS2-03

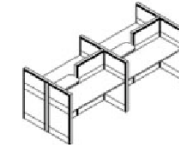

750-WS4-05

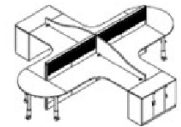

750-WS4-06

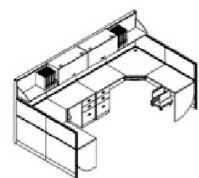

750-WS2-04
(T&W connection)

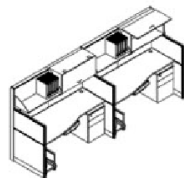

750-WS2-05
(T&W connection)

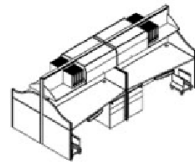

750-WS4-07
(T&W connection)

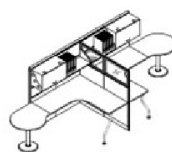

750-WS2-06
(T&W connection)

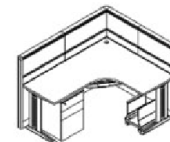

750-WS1-01

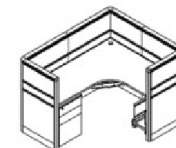

750-WS1-02

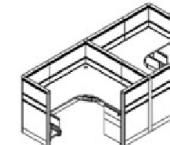

750-WS2-01

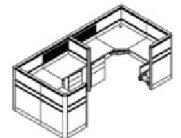

750-WS2-02



750-WS3-01

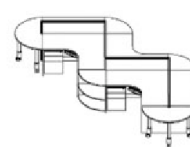

750-WS5-01

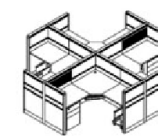

750-WS4-01

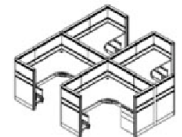

750-WS4-02



www.p-dimension.com



www.facebook.com/nasef.perfect.dimension



PERFECT DIMENSION

WORK STATION

Office furniture

Desktop

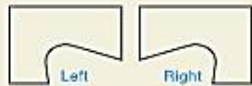

Light WORK SYSTEM



- | | A | B | C | D | H |
|------------|-------|------------------------|---|---|---|
| PHD 141206 | (R/L) | (1400x1200x600x600x25) | | | |
| PHD 161208 | (R/L) | (1600x1200x800x600x25) | | | |
| PHD 161206 | (R/L) | (1600x1200x600x600x25) | | | |
| PHD 181208 | (R/L) | (1800x1200x800x600x25) | | | |
| PHD 181206 | (R/L) | (1800x1200x600x600x25) | | | |

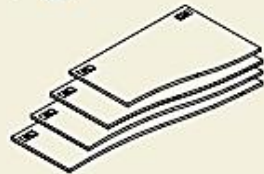

- | | |
|-----------|-------------------|
| PHD 120 C | (1200x800x800x25) |
| PHD 140 C | (1400x800x800x25) |
| PHD 160 C | (1600x800x800x25) |
| PHD 180 C | (1800x800x800x25) |

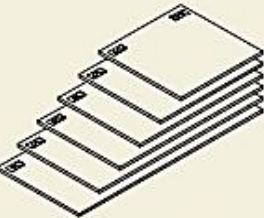

- | | |
|----------|---------------|
| MKPD 080 | (800x800x25) |
| MKPD 100 | (1000x800x25) |
| MKPD 120 | (1200x800x25) |
| MKPD 140 | (1400x800x25) |
| MKPD 160 | (1600x800x25) |
| MKPD 180 | (1800x800x25) |

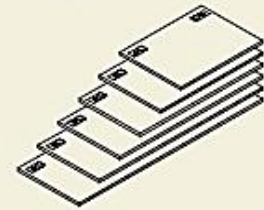

- | | |
|-----------|---------------|
| MKPSD 080 | (800x600x25) |
| MKPSD 100 | (1000x600x25) |
| MKPSD 120 | (1200x600x25) |
| MKPSD 140 | (1400x600x25) |

1200mmW x 600mmD Left - 1800mmW x 600mmD Right - 710mm Height

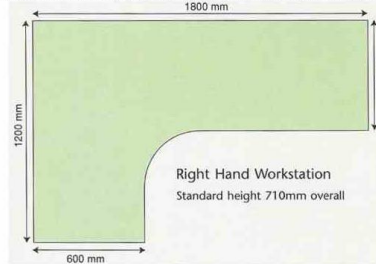

Glass Window

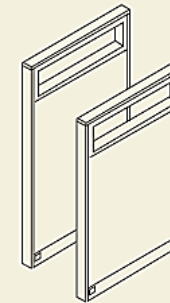

- | | |
|------------|---------------|
| MKPOG 0603 | (600x300x80) |
| MKPOG 0803 | (800x300x80) |
| MKPOG 1003 | (1000x300x80) |
| MKPOG 1203 | (1200x300x80) |

- | | |
|------------|---------------|
| MKPOG 0606 | (600x600x80) |
| MKPOG 0806 | (800x600x80) |
| MKPOG 1006 | (1000x600x80) |
| MKPOG 1206 | (1200x600x80) |

Workstation A

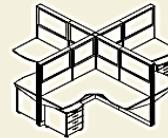

- | | | |
|------------------|---------|--------------|
| Partition | 4 MKPOG | 0618 |
| Partition X-Post | 1 MKPXP | 18 |
| End Bar | 4 MKPBE | 18 |
| Hanging Desktop | 4 PHD | 141408 (R/L) |
| Drawer | 4 MKDW | 303 |

Workstation B

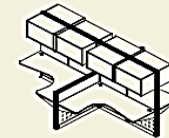

- | | | |
|------------------|---------|--------------|
| Partition | 4 MKPO | 0618 |
| Partition X-Post | 2 MKPO | 1210 |
| End Bar | 1 MKPXP | 18 |
| | 2 MKPBE | 18 |
| | 2 MKPBE | 10 |
| | 2 MKPBE | 08 |
| Hanging Desktop | 4 PHD | 161208 (R/L) |
| Hanging Storage | 8 MKPST | 060 |

One Panel System

Fabric & Wood Panel

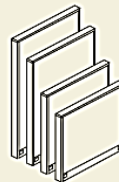

- | | |
|-----------|----------------|
| MKPO 0610 | (600x1000x80) |
| MKPO 0810 | (800x1000x80) |
| MKPO 1010 | (1000x1000x80) |
| MKPO 1210 | (1200x1000x80) |
| MKPO 0612 | (600x1200x80) |
| MKPO 0812 | (800x1200x80) |
| MKPO 1012 | (1000x1200x80) |
| MKPO 1212 | (1200x1200x80) |
| MKPO 0615 | (600x1500x80) |
| MKPO 0815 | (800x1500x80) |
| MKPO 1015 | (1000x1500x80) |
| MKPO 1215 | (1200x1500x80) |
| MKPO 0618 | (600x1800x80) |
| MKPO 0818 | (800x1800x80) |
| MKPO 1018 | (1000x1800x80) |
| MKPO 1218 | (1200x1800x80) |

Glass Window



- | | |
|------------|---------------|
| MKPOG 0603 | (600x300x80) |
| MKPOG 0803 | (800x300x80) |
| MKPOG 1003 | (1000x300x80) |
| MKPOG 1203 | (1200x300x80) |
| MKPOG 0606 | (600x600x80) |
| MKPOG 0806 | (800x600x80) |
| MKPOG 1006 | (1000x600x80) |
| MKPOG 1206 | (1200x600x80) |

T-Post



- | | |
|-----------|----------|
| MKPOTP 10 | (H:1000) |
| MKPOTP 12 | (H:1200) |
| MKPOTP 15 | (H:1500) |
| MKPOTP 18 | (H:1800) |

X-Post



- | | |
|-----------|----------|
| MKPOXP 10 | (H:1000) |
| MKPOXP 12 | (H:1200) |
| MKPOXP 15 | (H:1500) |
| MKPOXP 18 | (H:1800) |

L-Post



- | | |
|-----------|----------|
| MKPOLP 10 | (H:1000) |
| MKPOLP 12 | (H:1200) |
| MKPOLP 15 | (H:1500) |
| MKPOLP 18 | (H:1800) |

End Bar



- | | |
|----------|----------|
| MKPOE 10 | (H:1000) |
| MKPOE 12 | (H:1200) |
| MKPOE 15 | (H:1500) |
| MKPOE 18 | (H:1800) |



www.p-dimension.com



www.facebook.com/nasef.perfect.dimension

WORK STATION

Office furniture

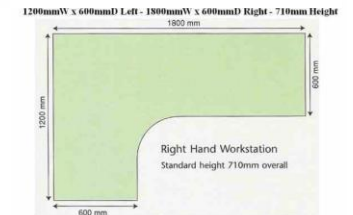
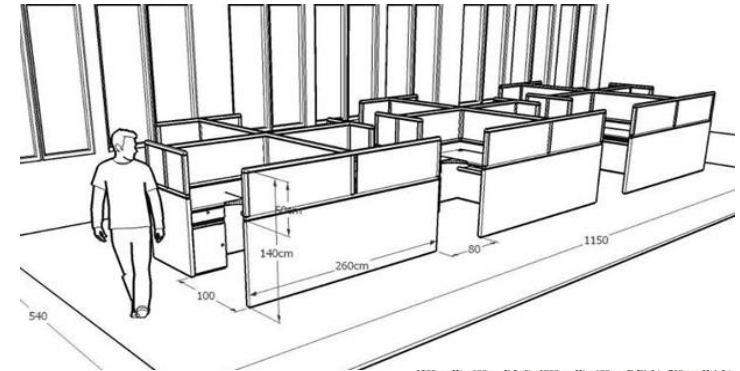

**The Light system is modern work station.
The 3.5cm the thickness of the light system section.
The Electric & data pass in the external taupe to be easy maintains**



www.p-dimension.com

www.facebook.com/nasef.perfect.dimension

WORK STATION



Office furniture



Light system

PERFECT DIMENSION



www.p-dimension.com



www.facebook.com/nasef.perfect.dimension

WORK STATION

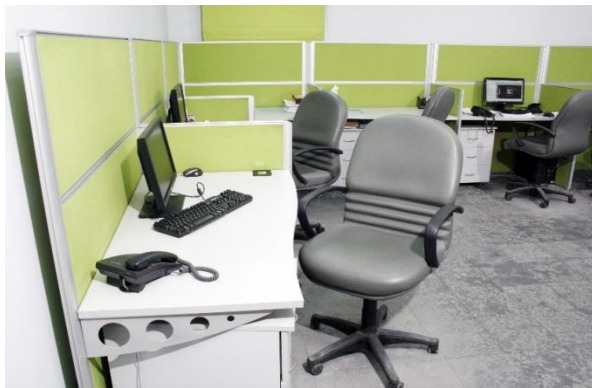

Office furniture

WORK STATION

Light system



**The Light system is modern work station.
The 3.5c.m the thickness of the light system
section.
The Electric & data pass in the external
taupe to be easy maintains**



www.p-dimension.com



www.facebook.com/nasef.perfect.dimension

WORK STATION



Office furniture

AT WORK SYSTEM

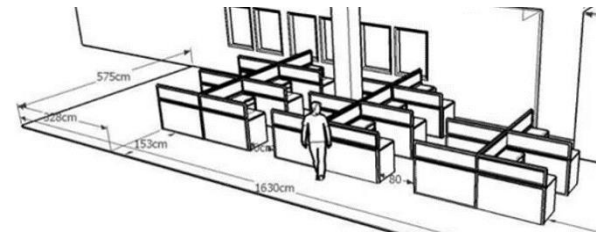

**The at Work system easy to work.
The electric and data pass in the internal
section 9.5 partition.
The at work system design in all
dimensions.**



WORK STATION

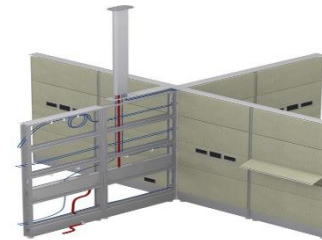

www.p-dimension.com



www.facebook.com/nasef.perfect.dimension

WORK STATION

Office furniture

Light WORK SYSTEM

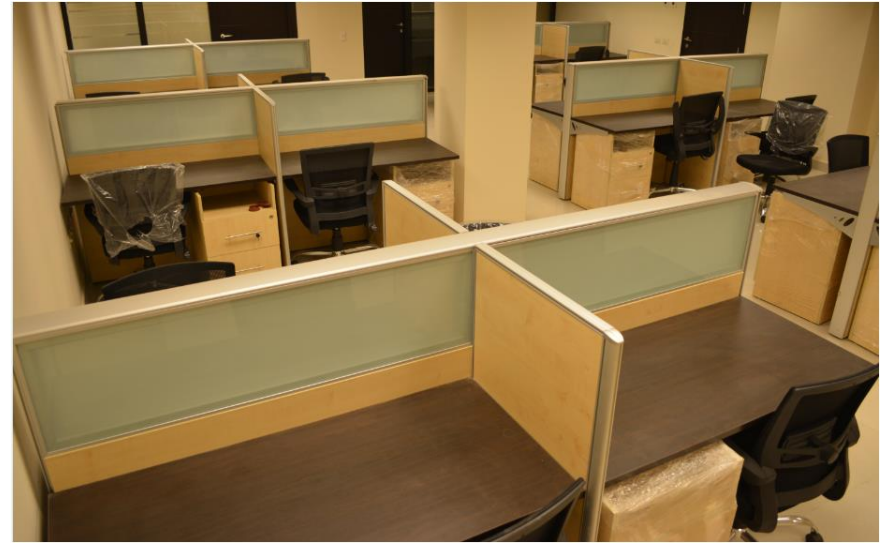

The Light WORK SYSTEM
easy to work.
The electric and data pass
in the internal section 9.5
partition.
The Light WORK SYSTEM
design in all dimensions.



www.p-dimension.com



www.facebook.com/nasef.perfect.dimension

WORK STATION



Office furniture



Light WORK SYSTEM



**The Light WORK SYSTEM
easy to work.
The electric and data
pass in the internal
section 9.5 partition.
The Light WORK SYSTEM
design in all
dimensions.**



www.p-dimension.com



www.facebook.com/nasef.perfect.dimension

WORK STATION

Office furniture

Light WORK SYSTEM

**The Light WORK SYSTEM
easy to work.
The electric and data pass
in the internal section 9.5
partition.
The Light WORK SYSTEM
design in all dimensions.**



www.p-dimension.com



www.facebook.com/nasef.perfect.dimension

WORK STATION

Light WORK SYSTEM



The **Light WORK SYSTEM**
easy to work.
The electric and data pass
in the internal section 9.5
partition.
The Light WORK SYSTEM
design in all dimensions.



Office furniture



www.p-dimension.com



www.facebook.com/nasef.perfect.dimension

WORK STATION

Office furniture

Light WORK SYSTEM

The **Light WORK SYSTEM**

easy to work.

The electric and data pass
in the internal section 9.5
partition.

The **Light WORK SYSTEM**

design in all dimensions. **PERFECT DIMENSION**



www.p-dimension.com



www.facebook.com/nasef.perfect.dimension

WORK STATION

Office furniture

Light WORK SYSTEM



www.p-dimension.com



www.facebook.com/nasef.perfect.dimension

WORK STATION

The at Work system easy to work.
The electric and data pass in the internal section 9.5 partition.
The at work system design in all dimensions.



Office furniture

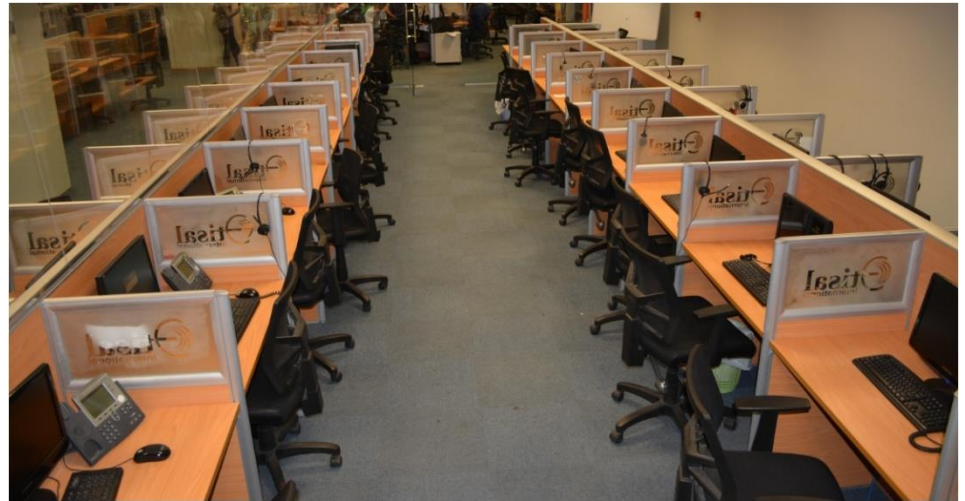

www.p-dimension.com



www.facebook.com/nasef.perfect.dimension

WORK STATION



Light WORK SYSTEM



Office furniture

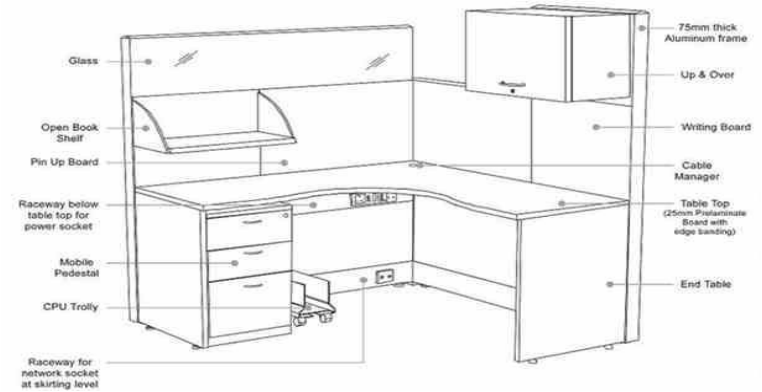

**The at Work system easy to work.
The electric and data pass in the internal section 9.5 partition.
The at work system design in all dimensions.**



www.p-dimension.com



www.facebook.com/nasef.perfect.dimension

WORK STATION

Office furniture

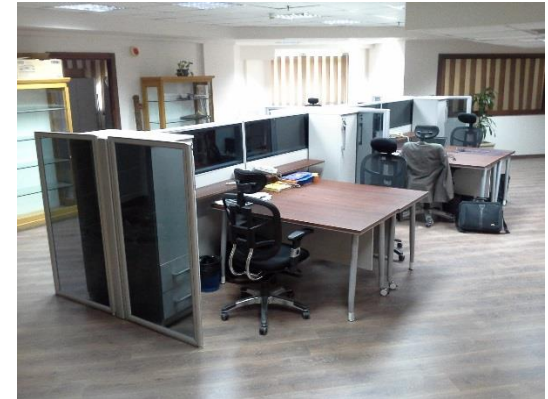

Light WORK SYSTEM

The at Work system easy to work.
The electric and data pass in the internal section 9.5 partition.
The at work system design in all dimensions.

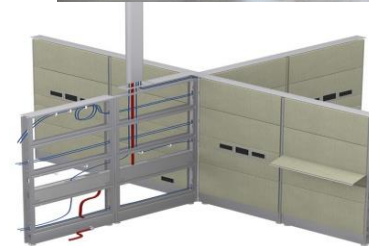

www.p-dimension.com



www.facebook.com/nasef.perfect.dimension

WORK STATION

Office furniture

BOX TYPE SYSTEM



www.p-dimension.com



www.facebook.com/nasef.perfect.dimension

WORK STATION



Office furniture



BOX TYPE SYSTEM

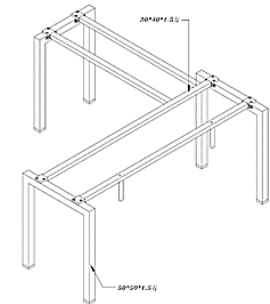
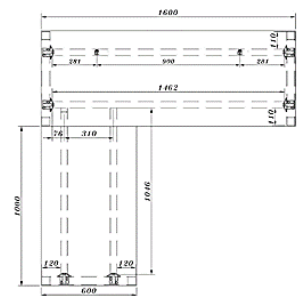
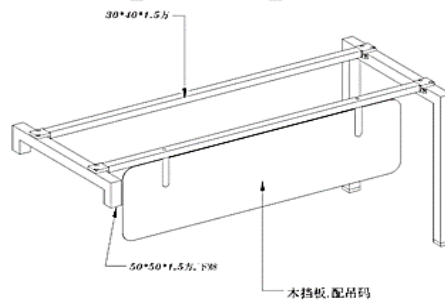
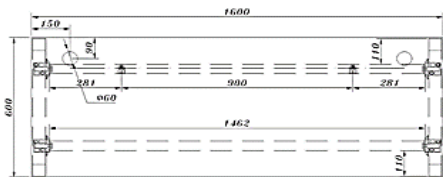
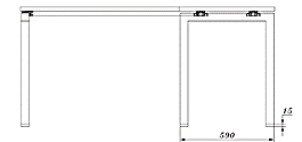
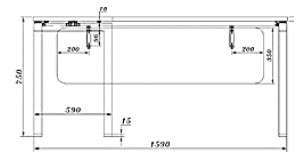
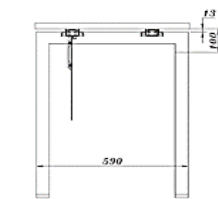
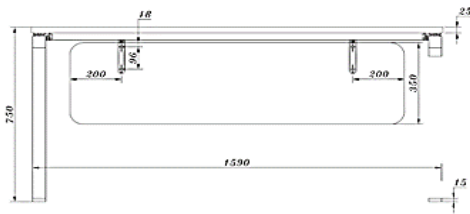

www.p-dimension.com

www.facebook.com/nasef.perfect.dimension

WORK STATION

Office furniture

BOX TYPE SYSTEM



www.p-dimension.com



www.facebook.com/nasef.perfect.dimension

pd
PERFECT DIMENSION

WORK STATION

Office furniture



BOX TYPE SYSTEM



www.p-dimension.com



www.facebook.com/nasef.perfect.dimension

WORK STATION

Office furniture

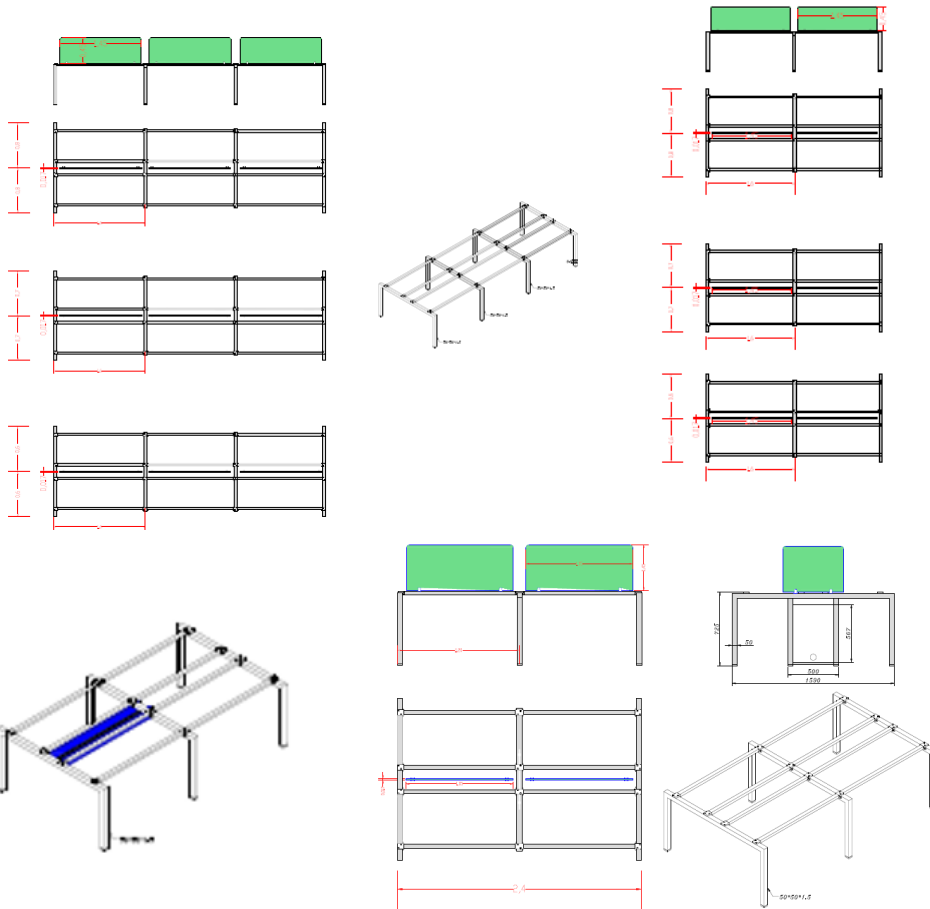

BOX TYPE SYSTEM

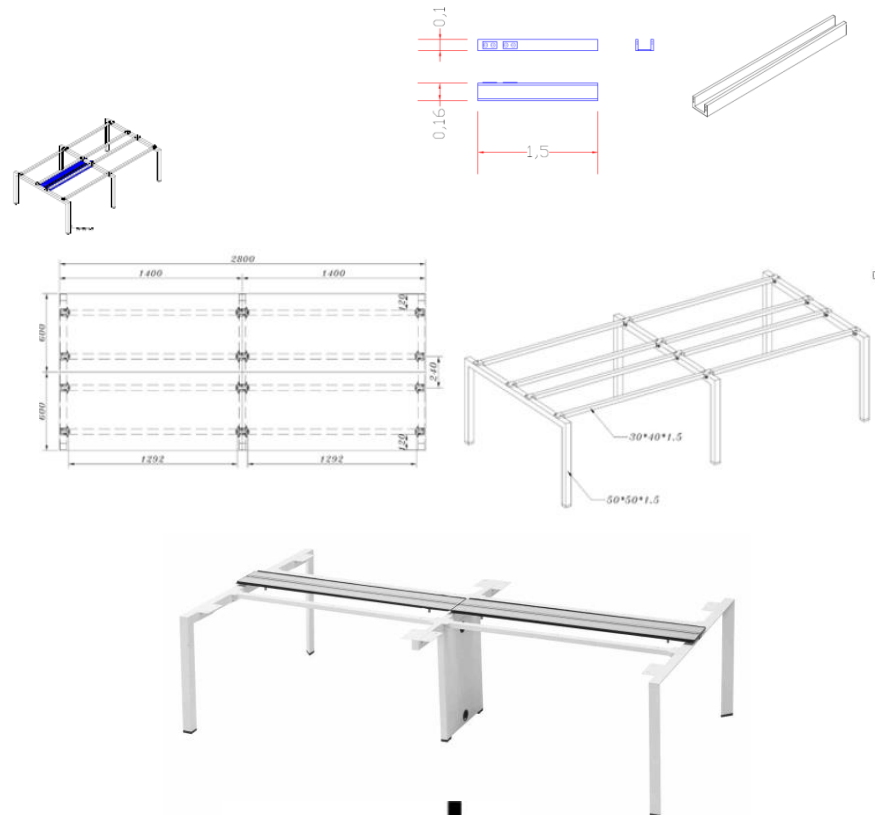

www.p-dimension.com



www.facebook.com/nasef.perfect.dimension



WORK STATION

Office furniture

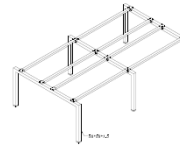
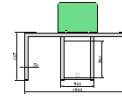
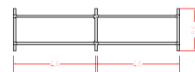
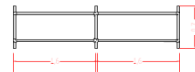
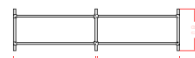
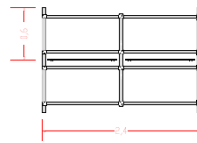
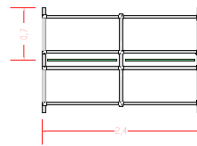
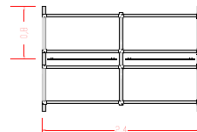
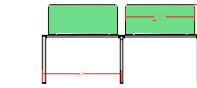
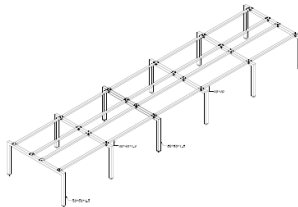
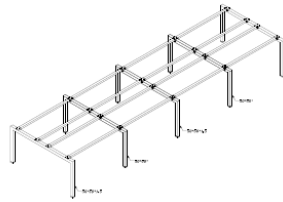
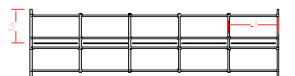
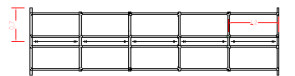
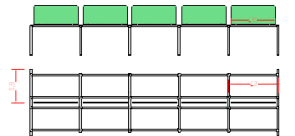
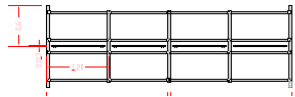
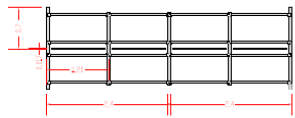
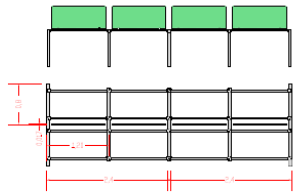

BOX TYPE SYSTEM

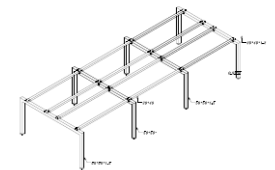
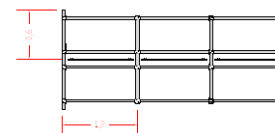
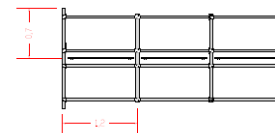
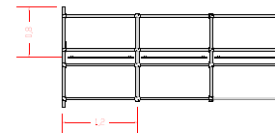
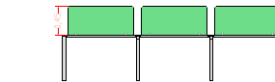

www.p-dimension.com



www.facebook.com/nasef.perfect.dimension

WORK STATION

Office furniture

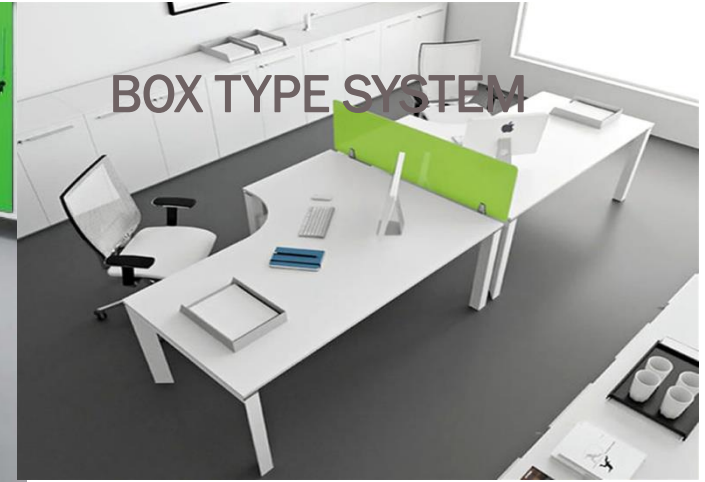

www.p-dimension.com



www.facebook.com/nasef.perfect.dimension



WORK STATION



Office furniture



www.p-dimension.com



www.facebook.com/nasef.perfect.dimension

BOX TYPE SYSTEM

WORK STATION



Office furniture

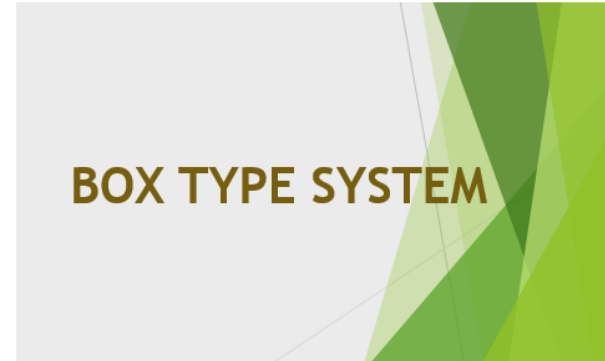

www.p-dimension.com



www.facebook.com/nasef.perfect.dimension

WORK STATION

Office furniture



The modern system is easy to work. The electric and data pass in the internal section 9.5 partition. The at work system design in all dimensions.



www.p-dimension.com



www.facebook.com/nasef.perfect.dimension

WORK STATION

Office furniture



BOX TYPE SYSTEM



www.p-dimension.com



www.facebook.com/nasef.perfect.dimension

WORK STATION

Office furniture



BOX TYPE SYSTEM



www.p-dimension.com



www.facebook.com/nasef.perfect.dimension



WORK STATION

Office furniture



WOOD SYSTEM



www.p-dimension.com



www.facebook.com/nasef.perfect.dimension



WORK STATION

Office furniture



WOOD SYSTEM



www.p-dimension.com



www.facebook.com/nasef.perfect.dimension

WORK STATION

Office furniture



WOOD SYSTEM



www.p-dimension.com



www.facebook.com/nasef.perfect.dimension

WORK STATION

Office furniture



WOOD SYSTEM



www.p-dimension.com



www.facebook.com/nasef.perfect.dimension

WORK STATION

Office furniture

WOOD SYSTEM



www.p-dimension.com



www.facebook.com/nasef.perfect.dimension

WORK STATION

Office furniture



WOOD SYSTEM



www.p-dimension.com



www.facebook.com/nasef.perfect.dimension

WORK STATION

WOOD SYSTEM

Office furniture

DESIGN GO



www.p-dimension.com



www.facebook.com/nasef.perfect.dimension

WORK STATION

Office furniture

WOOD SYSTEM



www.p-dimension.com



www.facebook.com/nasef.perfect.dimension

WORK STATION



WOOD SYSTEM



Office furniture



www.p-dimension.com



www.facebook.com/nasef.perfect.dimension

WORK STATION

Office furniture



WOOD SYSTEM



www.p-dimension.com.com



www.facebook.com/nasef.perfect.dimension

WORK STATION

Office furniture



www.p-dimension.com



www.facebook.com/nasef.perfect.dimension



WORK STATION

Office furniture

WOOD SYSTEM



www.p-dimension.com



www.facebook.com/nasef.perfect.dimension

Partition



**The Partitions system easy to work .
The electric and data pass in the internal section.
The At work system design in all dimensions .**

Office furniture

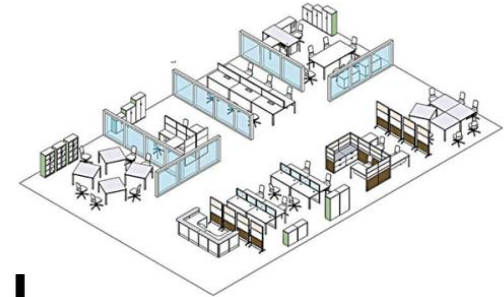

www.p-dimension.com



www.facebook.com/nasef.perfect.dimension

Partition

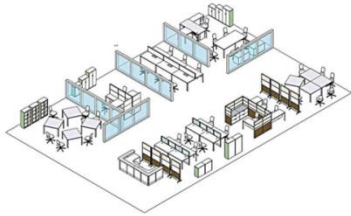

Office furniture

MATERIALS

1 - THE SECTION MANUFACTURED FROM ALUMINUM THICK 9.5 C.M AND PAINTED ELECTRO STATIC POWDER. CONNECTION INSTALL IN THE CEILING TO SUPPORT THE SECTION (FIGURE 1).



Figure 1

2- CONNECTION INSTALL IN THE CURVED WAY (FIGURE2).

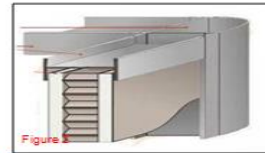

Figure 2

3- CONNECTION INSTALL IN THE BEGGING OF THE WALL TO ADDRESS THE TENDENCIES OF THE WALL (FIGURE3).



Figure 3

4- WE CAN PUT THE CURTAINS BETWEEN THE DOUBLE GLASS (FIGURE4).

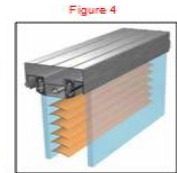

Figure 4

Partition System



The Partitions system easy to work .
The electric and data pass in the internal section.
The At work system design in all dimensions .



www.p-dimension.com



www.facebook.com/nasef.perfect.dimension

Partition



Office furniture



Partition System

**The Partitions system easy to work.
The electric and data pass in the internal
section.
The At work system design in all dimensions.**

MATERIALS

1- THE SECTION MANUFACTURED FROM ALUMINUM THICK 0.5 CM AND PAINTED ELECTRO STATIC POWDER. CONNECTION INSTALL IN THE CEILING TO SUPPORT THE SECTION (FIGURE 1).



2- CONNECTION INSTALL IN THE CURVED WAY (FIGURE 2).



3- CONNECTION INSTALL IN THE BEGGING OF THE WALL TO ADDRESS THE TENDENCIES OF THE WALL (FIGURE 3).

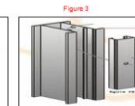

4- WE CAN PUT THE CURTAINS BETWEEN THE DOUBLE GLASS (FIGURE 4).

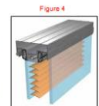

Partition System



www.p-dimension.com



www.facebook.com/nasef.perfect.dimension

Partition

Office furniture



Partition System

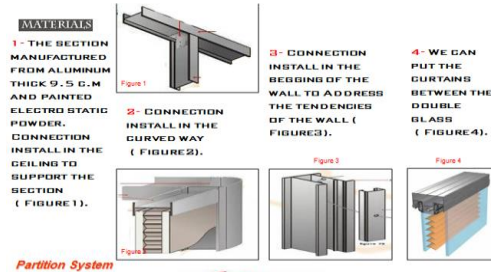

**The Partitions system easy to work.
The electric and data pass in the internal section.
The At work system design in all dimensions.**



www.p-dimension.com



www.facebook.com/nasef.perfect.dimension

Partition

Office furniture



**The Partitions system easy to work.
The electric and data pass in the internal section.
The At work system design in all dimensions.**



www.p-dimension.com



www.facebook.com/nasef.perfect.dimension

Couter



Reception Units

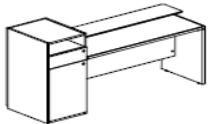

ADA Main Shell
Left/Right

W

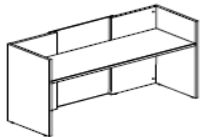

Main Shell

R W

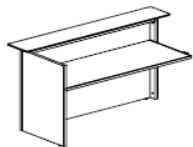

Return with
Transaction Surface
Left/Right

W

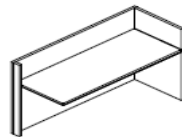

Return
Left/Right

R W

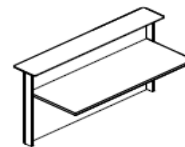

Bridge with
Transaction Surface

R W

You can dream

**& our employee can
design.....**

**& our factory can manufactured
any design.....**

Dreams with us can be facts.....

Counter

Office furniture



CA1



CA2



CA3



www.p-dimension.com



www.facebook.com/nasef.perfect.dimension

Counter

Office furniture



COU1



COU2



COU4

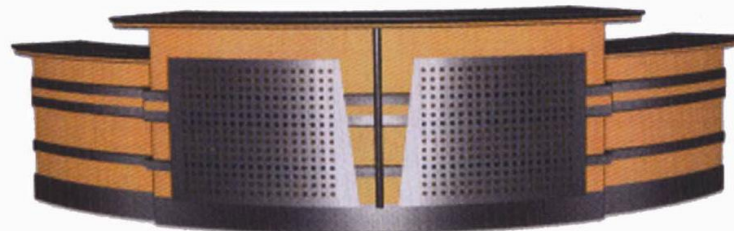

COU3



www.p-dimension.com



www.facebook.com/nasef.perfect.dimension

Counter

Office furniture



COU5



PERFECT DIMENSION



COU W2



COU W1



www.p-dimension.com



www.facebook.com/nasef.perfect.dimension

Counter

Office furniture



COU W3



COU M2



COU M1



www.p-dimension.com



www.facebook.com/nasef.perfect.dimension

Counter

Office furniture



www.p-dimension.com



www.facebook.com/nasef.perfect.dimension

Counter

Office furniture



CODE
ME 2222



www.p-dimension.com



www.facebook.com/nasef.perfect.dimension



PERFECT DIMENSION

Counter

Office furniture



CODE
ME 210



www.p-dimension.com



www.facebook.com/nasef.perfect.dimension

Counter

Office furniture



CODE
ME 2014



18

19



www.p-dimension.com



www.facebook.com/nasef.perfect.dimension

Counter

Office furniture



CODE
ME 2012



www.p-dimension.com



www.facebook.com/nasef.perfect.dimension

Counter



Office furniture



www.p-dimension.com



www.facebook.com/nasef.perfect.dimension



Counter



Office furniture



www.p-dimension.com



www.facebook.com/nasef.perfect.dimension



Counter



You can dream
&our employee can design.....
&our factory can manufactured any design.....
Dreams with us can be facts,....

Office furniture



www.p-dimension.com



www.facebook.com/nasef.perfect.dimension



Counter



Office furniture



**You can dream
.....
&our employee
can design.....
&our factory can
manufactured
any design.....
Dreams with us
can be facts,,,,**



www.p-dimension.com



www.facebook.com/nasef.perfect.dimension

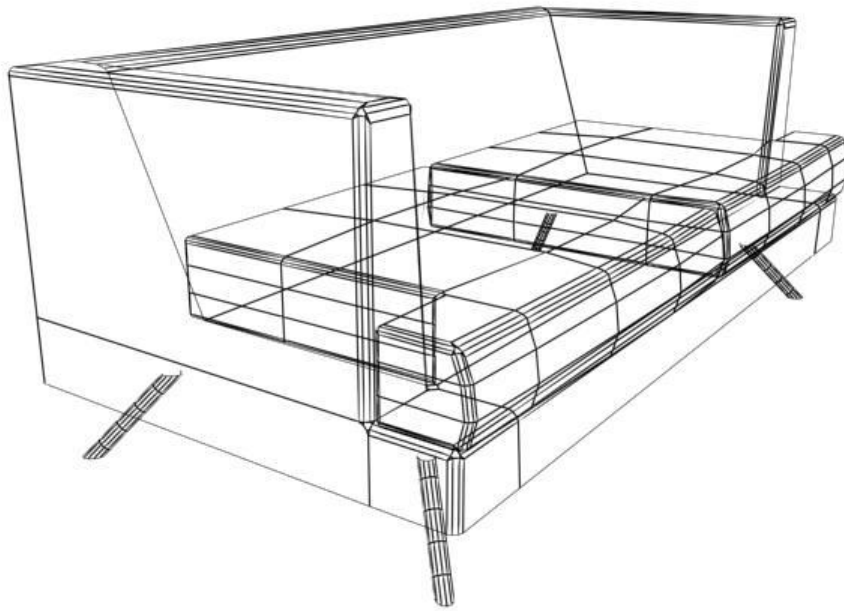

SOFA

.....*LIVE IN Work*.....

Sofa

Office furniture



A NEW CLASSICAL AND SIMPLE FASHION SOFA

SET: 3S + 1S + 1S

SET: 2S + 1S + 1S

SET: 3S + 2S + 1S

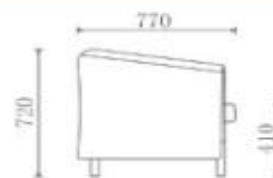
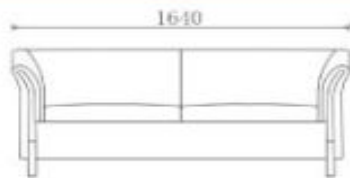

SO. 06



www.p-dimension.com



www.facebook.com/nasef.perfect.dimension



PERFECT DIMENSION

Sofa

Office furniture



SO. 08



A NEW CLASSICAL AND SIMPLE FASHION SOFA

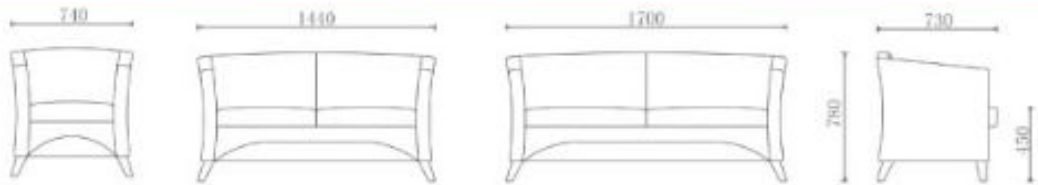

www.p-dimension.com



www.facebook.com/nasef.perfect.dimension



Sofa

Office furniture



SHESTER



GALAXY



www.p-dimension.com



www.facebook.com/nasef.perfect.dimension



PERFECT DIMENSION

Sofa



VENTY



PETRO



MOON

Office furniture



www.p-dimension.com



www.facebook.com/nasef.perfect.dimension



Sofa

Office furniture



www.p-dimension.com



www.facebook.com/nasef.perfect.dimension

Sofa

Office furniture



ISIS



FIRST



www.p-dimension.com



www.facebook.com/nasef.perfect.dimension

Sofa

Office furniture



PD 107



www.p-dimension.com



www.facebook.com/nasef.perfect.dimension



Sofa

Office furniture



PD
105



www.p-dimension.com



www.facebook.com/nasef.perfect.dimension



PERFECT DIMENSION

Sofa

Office furniture

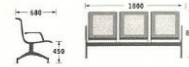

www.p-dimension.com



www.facebook.com/nasef.perfect.dimension

CHAIR

RELAX OFFICE SPACE

NEOCE office chairs, with their ergonomic design, durability and comfort, are made from the best quality materials and take the standard of office chairs to the next level. They come in various models with unequalled functions, adjustable support for individual users, and breathable materials.

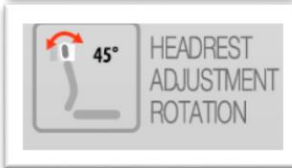
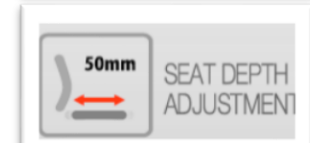
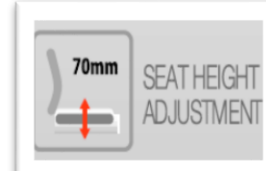
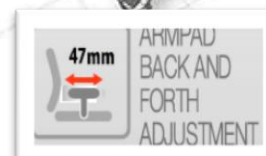
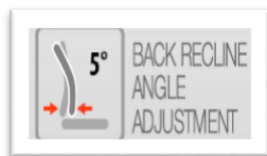

CHAIR

Office furniture



PD 505



PD 504



PD 505U



RELAX

OFFICE SPACE

NEOCE office chairs, with their ergonomic design, durability and comfort, are made from the best quality materials and take the standard of office chairs to the next level. They come in various models with unequalled functions, adjustable support for individual users, and breathable materials.



www.p-dimension.com



www.facebook.com/nasef.perfect.dimension

CHAIR

Office furniture



PD 903



PD 902



PD 902U



www.p-dimension.com



www.facebook.com/nasef.perfect.dimension

CHAIR

Office furniture



PD 202



PD 201



PD 201U



CHAIR

Office furniture



PD 212



PD 211



PD 211W



www.p-dimension.com



www.facebook.com/nasef.perfect.dimension

CHAIR

Office furniture



PD 997



PD 996



PD 996W



www.p-dimension.com



www.facebook.com/nasef.perfect.dimension

CHAIR

Office furniture



PD 708



PD 707



PD 707U



www.p-dimension.com



www.facebook.com/nasef.perfect.dimension

CHAIR

Office furniture



PD 101U



PD 101



PD 102



PD 404U



PD 404



PD 303U



PD 303



www.p-dimension.com



www.facebook.com/nasef.perfect.dimension

CHAIR

Office furniture



PD 881



PD 867



PD 851



PD 883T



www.p-dimension.com



www.facebook.com/nasef.perfect.dimension

CHAIR

Office furniture



CHN105



CH106A



CHP101



CHN107



CHN103



www.p-dimension.com



www.facebook.com/nasef.perfect.dimension

CHAIR

Office furniture



CH 112 A



CH 112 C



CH 110 A



CH 110 C



www.p-dimension.com



www.facebook.com/nasef.perfect.dimension

CHAIR



Office furniture



Ch.2H



Ch.1H

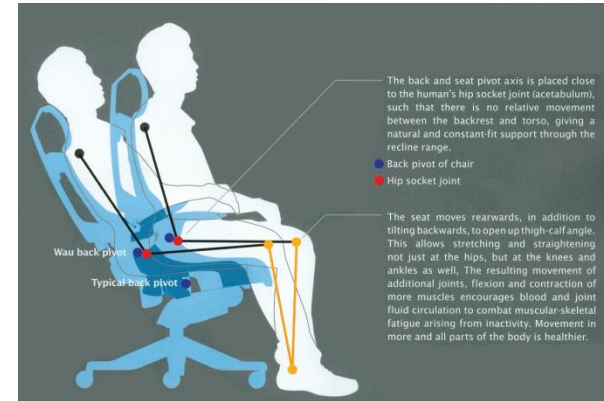

You have a comfort,,,



www.p-dimension.com



www.facebook.com/nasef.perfect.dimension

CHAIR

Office furniture



CH.302H



RELAX OFFICE SPACE

NEOCE office chairs, with their ergonomic design, durability and comfort, are made from the best quality materials and take the standard of office chairs to the next level. They come in various models with unequalled functions, adjustable support for individual users, and breathable materials.

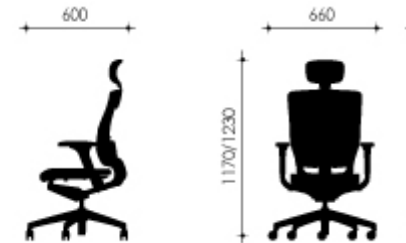

www.p-dimension.com



www.facebook.com/nasef.perfect.dimension

CHAIR

Office furniture



The backpiece tilts in different directions according to body movements.
SYNCHRONIZED TILTING



www.p-dimension.com



www.facebook.com/nasef.perfect.dimension

CHAIR

Office furniture



CH22 V



CH.21 w



CH.20 H

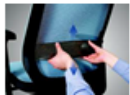

The adjustable lumbar support provides adequate support for the back, allowing users to raise or lower it up to 40mm according to their posture and work style.
LUMBAR SUPPORT

RELAXOFFICE SPACE

NEOCE office chairs, with their ergonomic design, durability and comfort, are made from the best quality materials and take the standard of office chairs to the next level. They come in various models with unequalled functions, adjustable support for individual users, and breathable materials.



The backpiece tilts in different directions according to body movements.
SYNCHRONIZED TILTING



www.p-dimension.com



www.facebook.com/nasef.perfect.dimension

CHAIR

Office furniture



CH.55 H



The adjustable lumbar support provides adequate support for the back, allowing users to raise or lower it up to 40mm according to their posture and work style.
LUMBAR SUPPORT



CH.60 H



CH.61 w



CH.61 V



CH.55 w



CH.55 V



www.p-dimension.com



www.facebook.com/nasef.perfect.dimension

CHAIR



CH.101 V



CH.100 W



CH.102 H

**RELAX
OFFICE SPACE**
NEOCE office chairs, with their ergonomic design, durability and comfort, are made from the best quality materials and take the standard of office chairs to the next level. They come in various models with unequalled functions, adjustable support for individual users, and breathable materials.



PERFECT DIMENSION



www.p-dimension.com



www.facebook.com/nasef.perfect.dimension

CHAIR

Office furniture



CH.300 H



CH.301 W



CH.302 V

**RELAX
OFFICE SPACE**

NEOCE office chairs, with their ergonomic design, durability and comfort, are made from the best quality materials and take the standard of office chairs to the next level. They come in various models with unequalled functions, adjustable support for individual users, and breathable materials.



www.p-dimension.com



www.facebook.com/nasef.perfect.dimension



PERFECT DIMENSION

CHAIR

Office furniture



CH.700 H



CH.701 W



CH.702 V



CH.703 V



www.p-dimension.com



www.facebook.com/nasef.perfect.dimension

CHAIR



Office furniture



CH.1 C



www.p-dimension.com



www.facebook.com/nasef.perfect.dimension

CHAIR

Office furniture



PD50



www.p-dimension.com



www.facebook.com/nasef.perfect.dimension



Doors

Office furniture



| | |
|----------------------|--------------|
| Wood Type | M,D,F |
| Veneer Type | H,P,L |
| Colors | 52 Colors |
| Dimensions | 80 x 220 C.M |
| Delivery Time | 5 To 10 Day |



| | |
|----------------------|--------------|
| Wood Type | M,D,F |
| Veneer Type | H,P,L |
| Colors | 52 Colors |
| Dimensions | 80 x 220 C.M |
| Delivery Time | 5 To 10 Day |



| | |
|----------------------|--------------|
| Wood Type | M,D,F |
| Veneer Type | H,P,L |
| Colors | 52 Colors |
| Dimensions | 80 x 220 C.M |
| Delivery Time | 5 To 10 Day |



www.p-dimension.com



www.facebook.com/nasef.perfect.dimension



PERFECT DIMENSION

Doors



Office furniture



www.p-dimension.com



www.facebook.com/nasef.perfect.dimension

pd
PERFECT DIMENSION

CORIAN

Office furniture



KITCHEN



BATHROOM



FURNITURE



MESAS DE CORIAN

60X 60 CMS
60 DIAMETRO



www.p-dimension.com



www.facebook.com/nasef.perfect.dimension

CORIAN

Office furniture

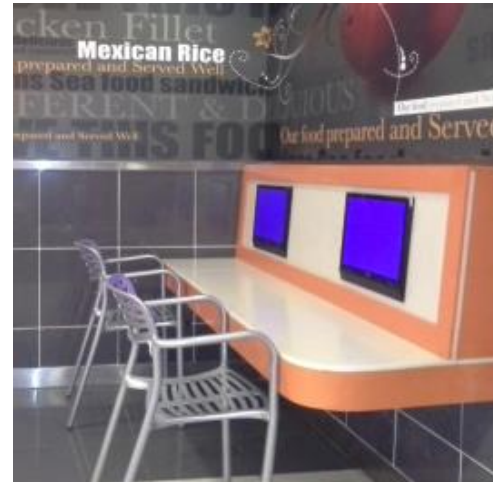

www.p-dimension.com



www.facebook.com/nasef.perfect.dimension

COMPACT

Office furniture

High Pressure Compact Laminate Bathroom Partition

Specifications

Toilet Cubicle

- 1- Made of High Quality Material, Latest designs and manufacturing techniques for many years of service
- 2- Doors with Proper installation allow lifting up and then swing in Or out for emergency access.
- 3- Finish is resistant to wear, fading and Scuffing
- 4- Easily Cleaned with mild Soap solution and Wiped dry
- 5- Available in overhead/head rail braced style, Floor Mounted Style, Floor to ceiling style and ceiling hung styles



www.p-dimension.com



www.facebook.com/nasef.perfect.dimension



Cladding

Office furniture



www.p-dimension.com



www.facebook.com/nasef.perfect.dimension



Cladding

Office furniture



We can use metal structure to install the cladding or wood structure.
The cladding wood layer can be L.P.L or H.P.L or Natural veneer.
We can manufacture stripes design or curved design just dream



www.p-dimension.com



www.facebook.com/nasef.perfect.dimension

Laboratory furniture

Wood Laboratory Furniture –Base and Wall Cabinets

Functional, durable, and stylish is the only way to describe LOC Scientifics' Wood Laboratory Furniture. These cabinets are constructed with $\frac{3}{4}$ " seven or five ply veneer with continuous ends. The door and drawer fronts have a full $\frac{3}{4}$ " board with oak veneer on two sides and $\frac{3}{8}$ " offset lip on vertical edges. Combine these features with the attractive vertical match of wood grain on the lab cabinet fronts and you will have a lab to be proud of for years to come.



www.p-dimension.com

www.facebook.com/nasef.perfect.dimension

Laboratory furniture



www.p-dimension.com



www.facebook.com/nasef.perfect.dimension



PERFECT DIMENSION

Laboratory furniture



www.p-dimension.com



www.facebook.com/nasef.perfect.dimension



Projects

Office furniture



www.p-dimension.com



www.facebook.com/nasef.perfect.dimension



Projects

Office furniture



www.p-dimension.com



www.facebook.com/nasef.perfect.dimension



Projects



Office furniture



www.p-dimension.com



www.facebook.com/nasef.perfect.dimension

Projects



Office furniture



www.p-dimension.com



www.facebook.com/nasef.perfect.dimension

Projects

Office furniture



www.p-dimension.com



www.facebook.com/nasef.perfect.dimension



Projects



Office furniture



www.p-dimension.com



www.facebook.com/nasef.perfect.dimension

Projects



Office furniture



www.p-dimension.com



www.facebook.com/nasef.perfect.dimension

Projects



Office furniture



www.p-dimension.com



www.facebook.com/nasef.perfect.dimension

Projects



Office furniture



PERFECT DIMENSION



www.p-dimension.com



www.facebook.com/nasef.perfect.dimension

Projects

Office furniture

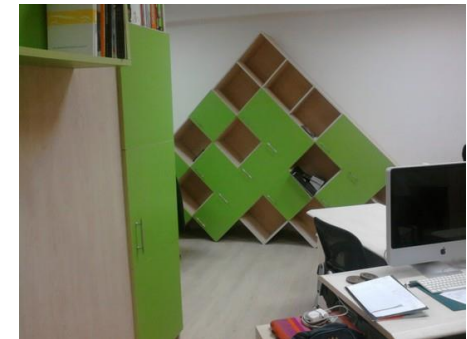

www.p-dimension.com



www.facebook.com/nasef.perfect.dimension



Projects

Office furniture



www.p-dimension.com



www.facebook.com/nasef.perfect.dimension

Projects

Office furniture



www.p-dimension.com



www.facebook.com/nasef.perfect.dimension

Projects

Office furniture



www.p-dimension.com



www.facebook.com/nasef.perfect.dimension

Projects

Office furniture



www.p-dimension.com



www.facebook.com/nasef.perfect.dimension

Projects

Office furniture



www.p-dimension.com



www.facebook.com/nasef.perfect.dimension

Thank you for your interest

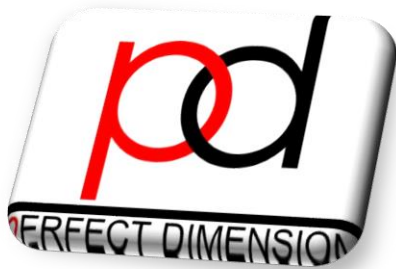

Administration Address :

1090 Elmoqattam st., Elmoqattam - Cairo - Egypt

Tel / fax : (202) 28467432 Tel : (202) 28467013

Mobile : (202) 010 251 8600

E-mail : info@p-dimension.com

Factory Address :

1 ELgamaa Elmasrya st., Moasasa El Zaka Cairo - Egypt

Tel / fax : (202) 2699 4106

www.p-dimension.com

www.facebook.com/nasef.perfect.dimension