

RVH8262

TOPMOUNT KITCHEN SINK

RUVATI[®]
SPECIFICATION SHEET

MATERIAL

True 16 Gauge Thickness
Premium T304 Grade Stainless Steel
18/10 Chromium/Nickel Content
Commercial Brushed Finish



FEATURES

- Heavy duty sound guard padding and undercoating
- Built-in glass rinser with drying rack
- Single-Tier Ledge for Accessories

IN THE BOX



Basket Strainer
[RVA1025]

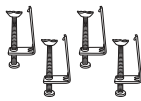

Mounting Clips
[RVA11042]



Flex Hose
[RVA11025]

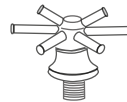

Sprayer Assembly
[RVA11026]

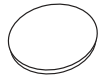

Drain Cover
[RVA1035]



Cut-out
Template

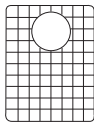

Rinse Grid
[RVA68210]

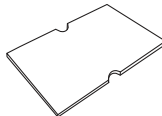

Cutting Board
[RVA1210]

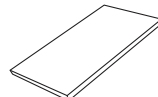

Cutting Board
[RVA1242]

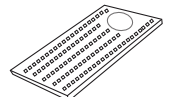

Drainer Grate
[RVA11027]

NOMINAL DIMENSIONS

Exterior: 22" (wide) x 20" (front-to-back)
Interior Bowl: 13" x 14-5/8" (left), 7" x 14-5/8" (right)
Bowl Depth: 10"
Minimum Cabinet Size: 24" wide
Drain Hole Size: 3½"

Installation Type:

Topmount

Inside Corners:

Rounded

Drain Location:

Rear Center

RUVATI USA

www.ruvati.com

Phone: 1.855.478.8284
Email: support@ruvati.com

OPTIONAL ACCESSORIES (SOLD SEPARATELY)



Deep Basket
Disposal Flange
[RVA1049ST]

DIMENSIONS

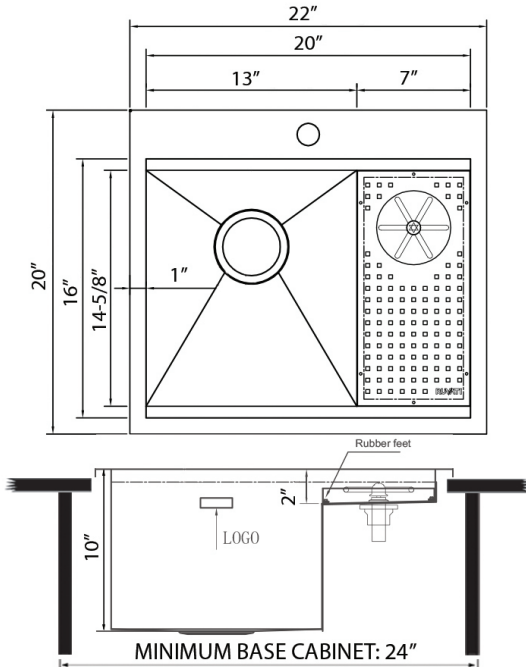

Register your product at www.ruvati.com/register.