

# **Handouts**

**BIO301-Essentials of Genetics**

**Virtual University of Pakistan**

## Lesson 1

### What is Genetics?

Genetics is the study of genes, heredity and variation.

It is considered as a field of Biology.

The principles of heredity were explained by Gregor Mendel in 1866.

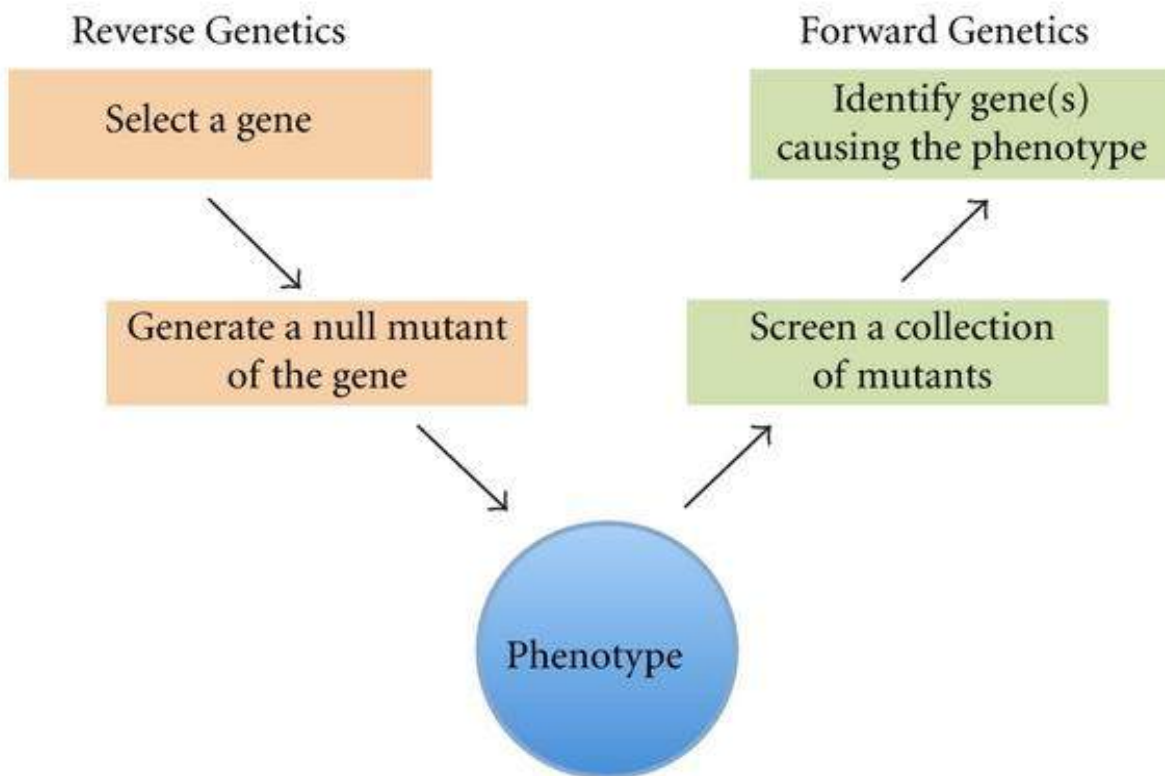

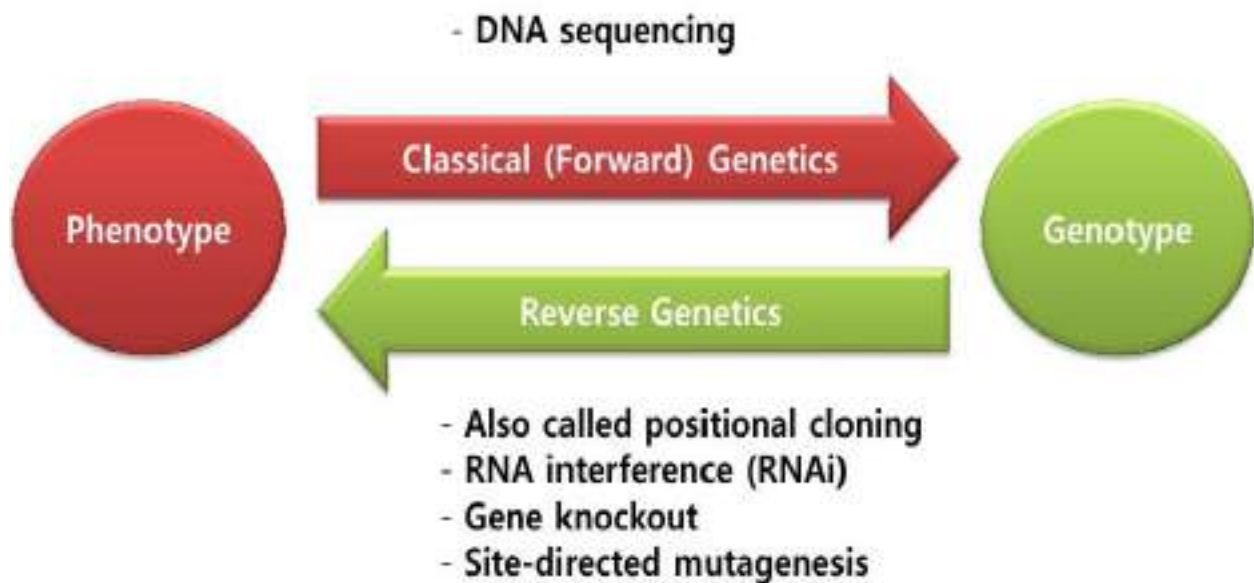

Gregor Mendel used garden pea as experimental plant for formulating the laws of heredity, following were the properties of garden pea

- Seed in a variety of shapes and colors.
- Self, cross pollinate.
- Takes up little space.
- Short generation time
- Produces many offspring.

## Lesson 2

### Sub Types of Genetics

There are four sub disciplines of genetics which are as follows, although some of the Geneticist classify Genetics in many sub disciplines

- Transmission (Classical) Genetics
- Population Genetics
- Quantitative Genetics
- Molecular Genetics

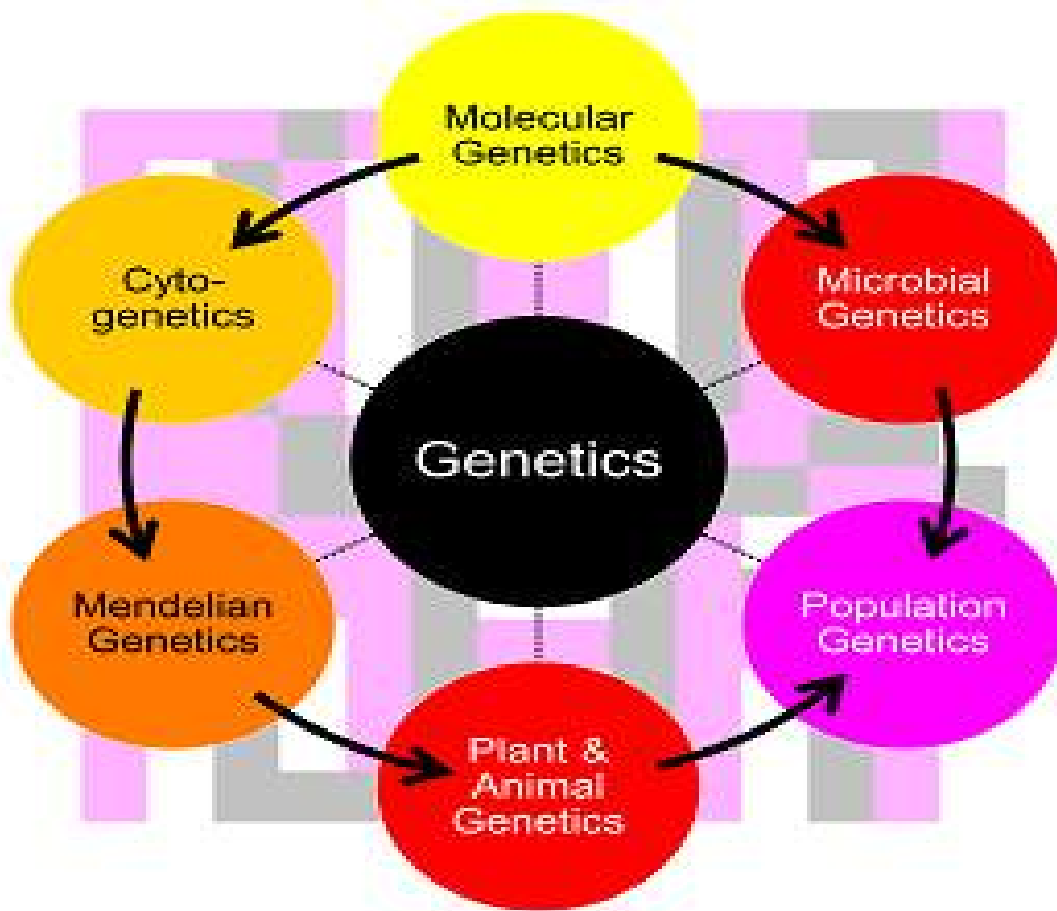

Historically, transmission genetics developed first, followed by population genetics, quantitative genetics and finally molecular genetics.

- Transmission or classical genetics deals with movement of genes and genetic traits from parents to offspring. Mendel's Laws. It also deals with genetic recombinations.
- Population genetics is the study of traits in a group of population. In this type of genetics we study heredity in groups for traits determined by one or a few genes.
- Quantitative genetics is the study of group hereditary for traits determined by many genes simultaneously such as skin color, height, eye color etc
- Molecular genetics this branch of genetics deals with the molecular structure and function of genes.

## Lesson 3

### Common Genetics Terminologies

What is Character: A heritable feature (skin color, height etc).

What is Trait: variant for a character (i.e. brown, black, white etc).

What is True-breed: all offspring of same variety.

➤ Different generations of a cross can be

P generation (parents)

F1 generation (1st filial generation)

F2 generation (2nd filial generation)

➤ Pure Cross: A cross between a true breed plant/animal with another true breeds plant/animal is called pure cross

True breeding X True breeding

WW X ww

➤ Hybrid Cross:

F1 generation X F1 generation

Ww X Ww

➤ Genotype and Phenotype: Genetic make-up of an organism is called Genotype while physical appearance of an organism is called Phenotype.

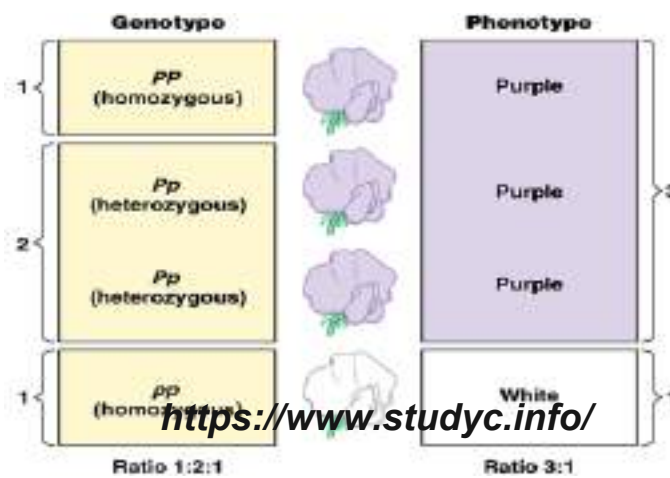

- Dominant and Recessive: when one characteristic expresses itself over the other i.e. round over wrinkled was dominant in Gregor Mendel experiments while the trait that does not show through in the first generation is called as recessive trait i.e. wrinkled.

## Lesson 4

### Mendel s' law of dominance

**Mendel s' law of dominance** describes that in a cross of parents, that are pure for contrasting traits, only one form of the trait will appear in the next generation. In the monohybrid cross, one version will be disappeared

#### Example:

Cross of two true-breeding plants. First plant is with purple color flowers while second is with white color flowers. During F1 generation, all plants will be with purple color flowers. It can be concluded that purple color dominant to white.

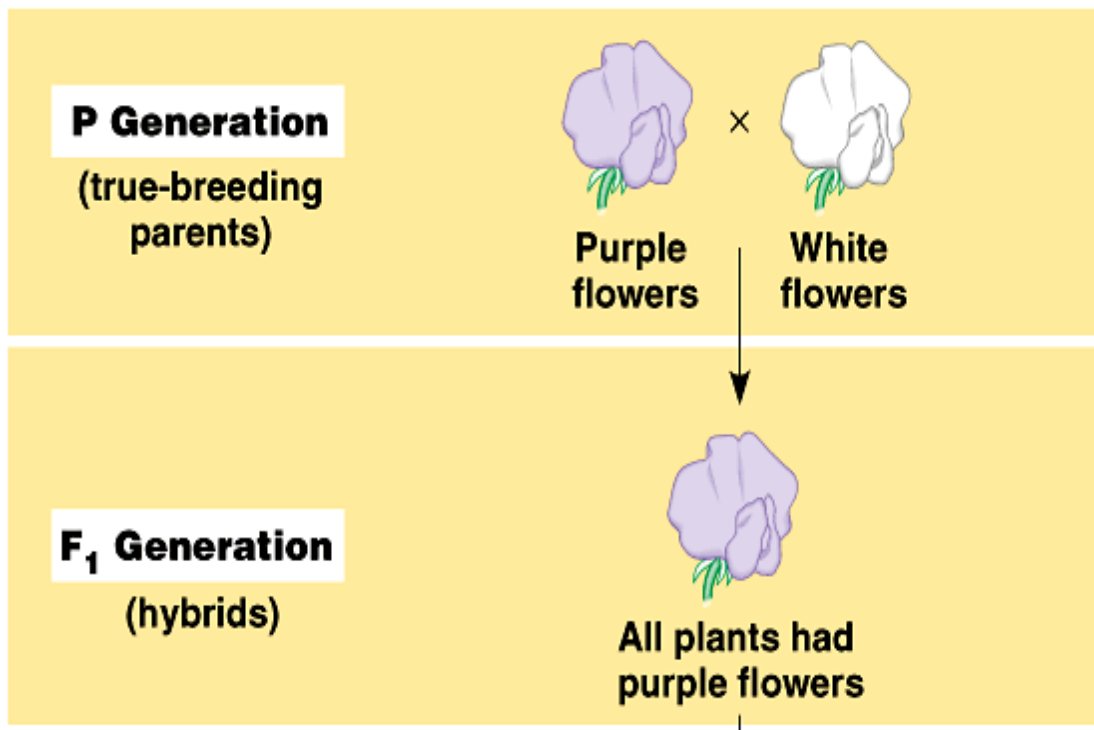

It can concluded that hybrids will show dominant phenotype



Example:

PP = purple      pp = white      Pp = purple

### Law of dominance and current model of inheritance

Plants of F<sub>1</sub> generation were interbred which produced F<sub>2</sub> plants. Lost-trait was re-appeared that was the formulation of the current model of inheritance.

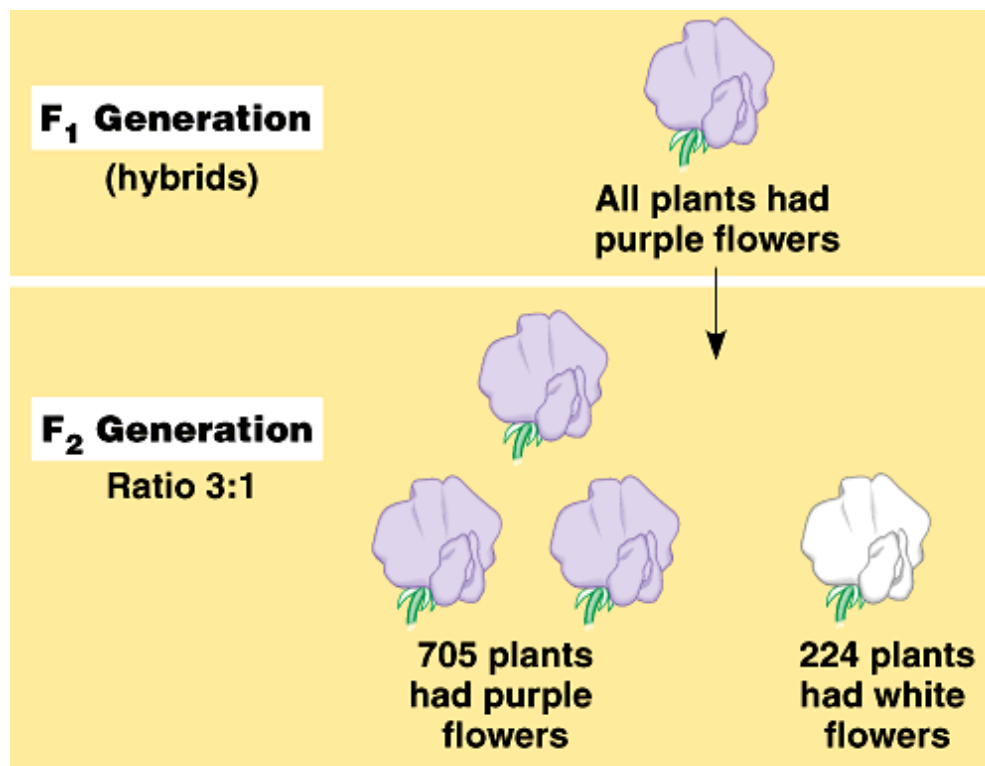

Every gene has two alleles that can code for a trait. One allele is dominant while other allele is recessive. The gene for a particular inherited character resides at a specific locus (position) on homologous chromosome. For each character, an organism inherits two alleles, one from each of the parent.

## Lesson 5

### Monohybrid cross and Dihybrid cross

Cross-fertilization of true-breeding plants which are different in just one character is called as monohybrid cross. With monohybrid cross, Mendel determined the segregation of alleles at single gene locus.

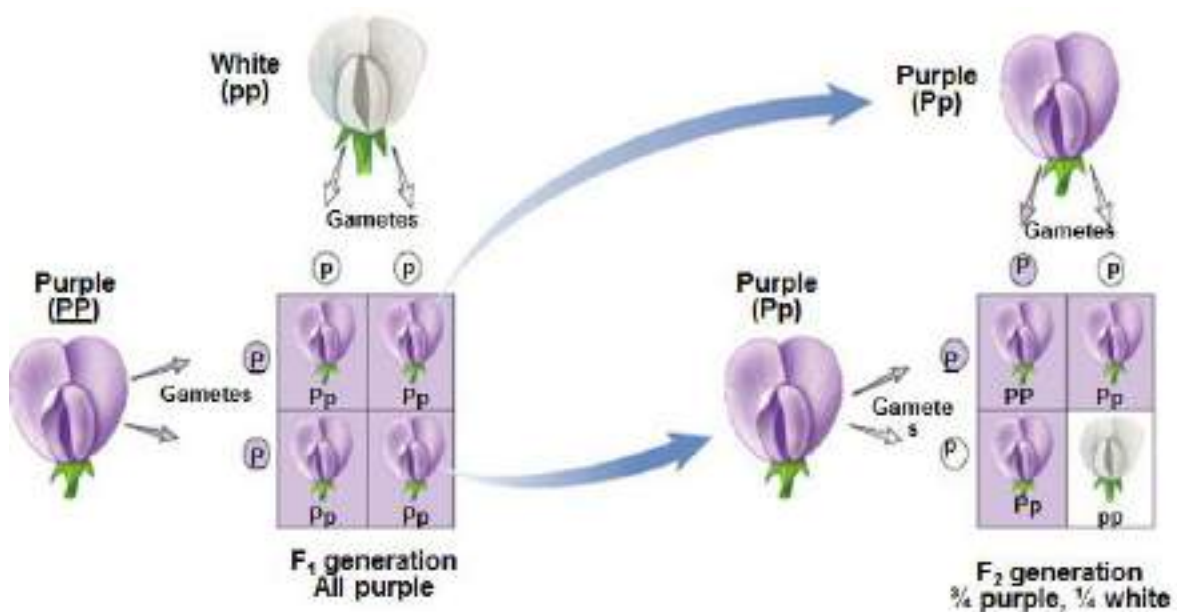

Dihybrid cross determines that alleles at two different gene loci segregate dependently or independently. Segregation is dependent or independent ?

#### Example:

Seed shape is controlled by one gene while seed color is controlled by a different gene. Mendel crossed two pure-breeding plants: one with round/yellow seeds, other with green/wrinkled seeds.

Dependent segregation: Alleles at the two gene loci segregate together, and are transmitted as a unit.

Independent assortment: Alleles at the two gene loci segregate independently, and are not transmitted as a unit. Plants producing gametes with different allele combinations.

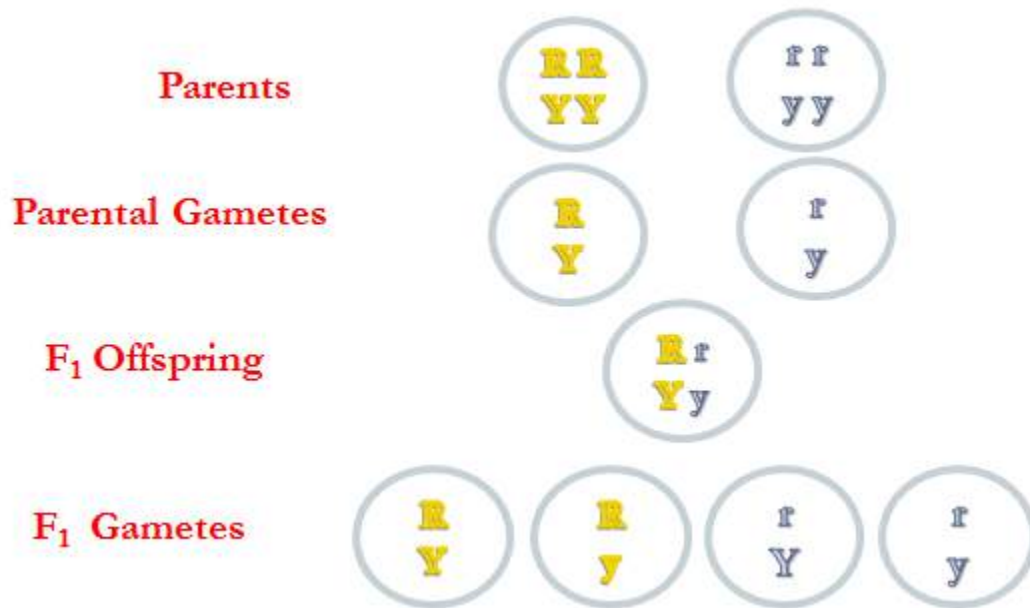

### Independent assortment

How are two characters transmitted from parents to offspring, if they are away from each other or on different chromosomes? They will transmit

- As a package?

- Independently?

Answer:

independently

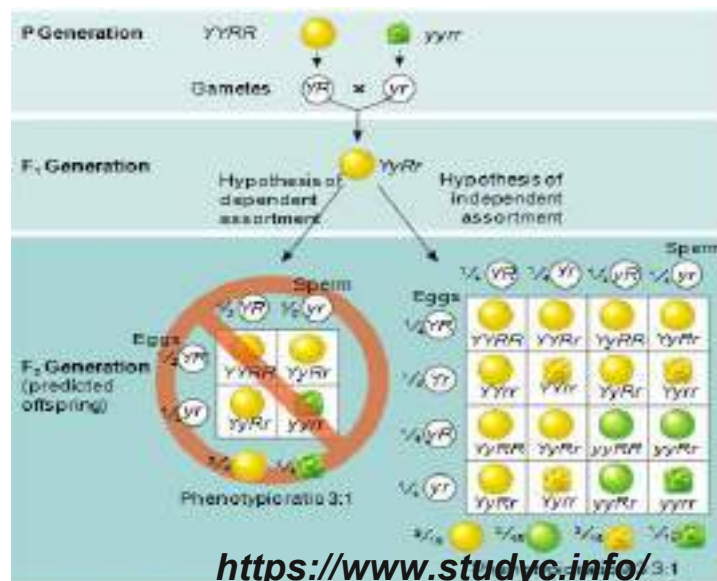

## Lesson 6

### Law of Segregation

During the formation of gametes, the two alleles responsible for a trait separate from each other. Alleles are then "recombined" during the process of fertilization.

#### Example 1

During a cross, gametes of each parent first segregate. Then, gametes combine to give new genotype. Resulting phenotype will be according to genotype.

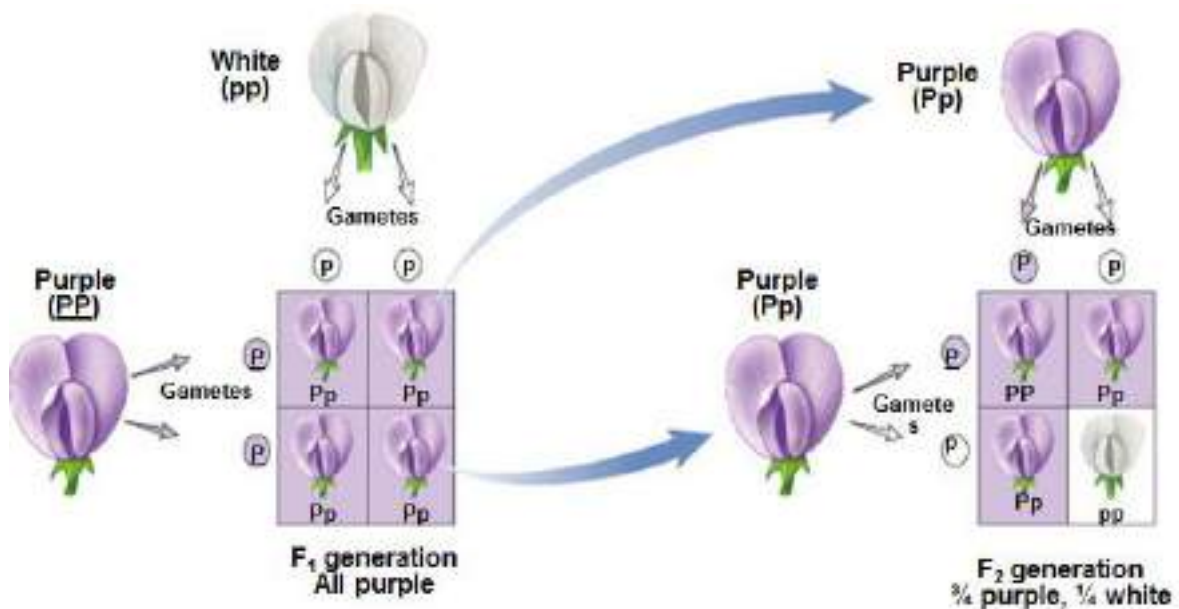

**Example 2:** Gametes formation, where alleles separate.

During fertilization, re-unite.

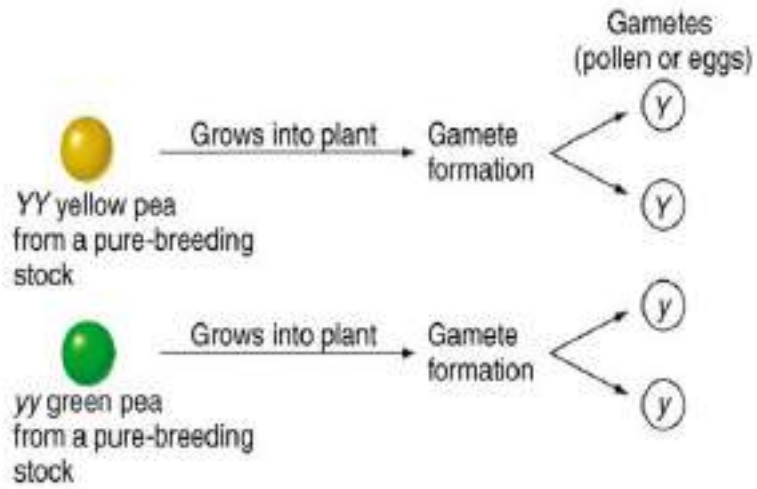

gametes

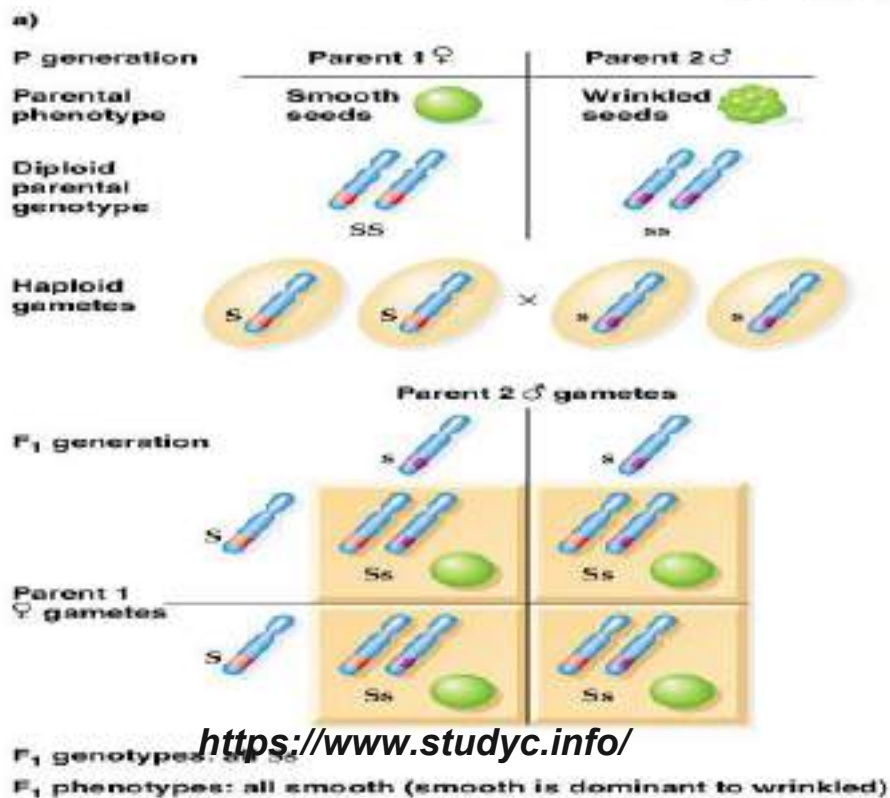
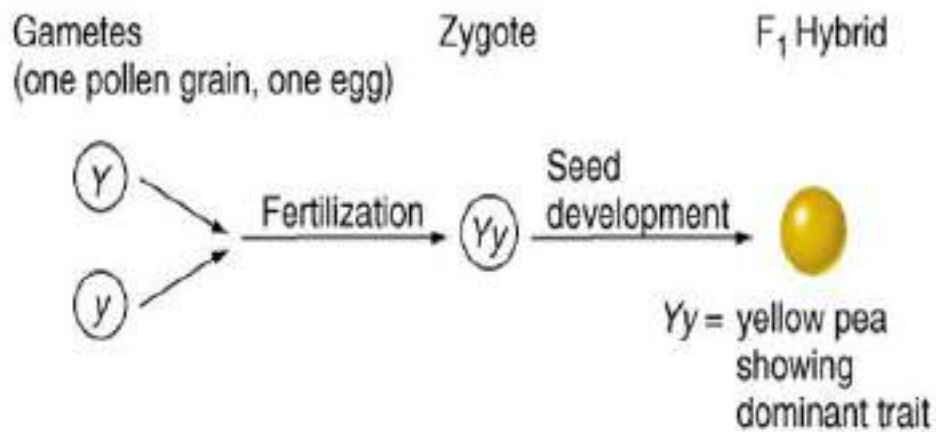

Modern Concept of Segregation states that every gene has two alleles that can code for a trait. Alleles separate during gametogenesis and reunite during fertilization.

## Lesson 7

### Mendel's Law of Independent Assortment

Alleles for different traits are distributed to sex cells independently of one another. Traits are transmitted to offspring independently of one another.

**Example:** Dihybrid cross, true-breeding plants for two traits. For example, a plant that had green pod color and yellow seed color was cross-pollinated with a plant that had yellow pod color and green seeds. The traits for green pod color (GG) and yellow seed color (YY) are dominant. Yellow pod color (gg) and green seed color (yy) are recessive. F1 plants heterozygous GgYy

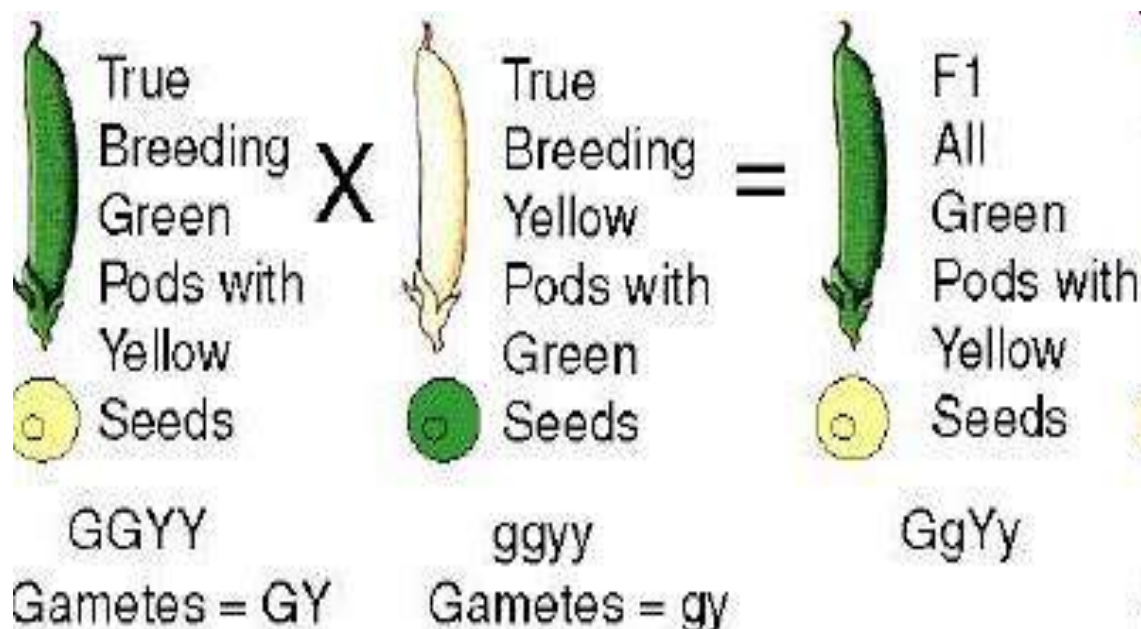

After observing the results of dihybrid cross, Mendel allowed all of the F1 plants to self-pollinate. He referred to these offspring as F2 generation. Mendel noticed a 9:3:3:1 ratio.

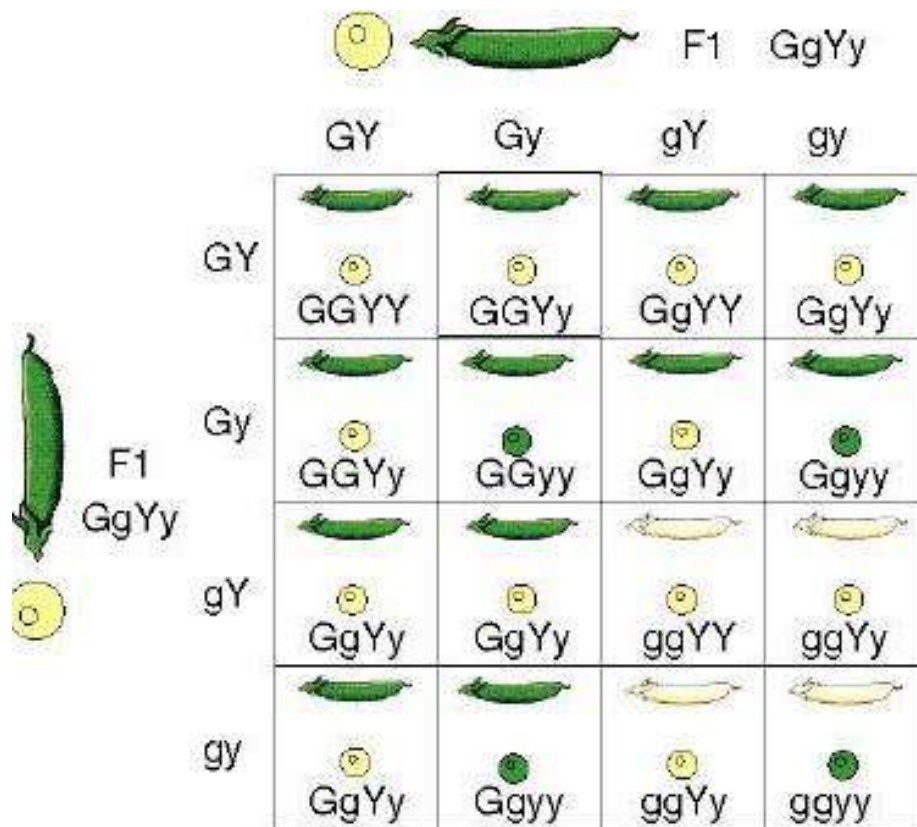

The results support the hypothesis of independent assortment. The alleles for seed color and seed shape sort into gametes independently of each other.

### **Modern Concept of Law of Independent Assortment**



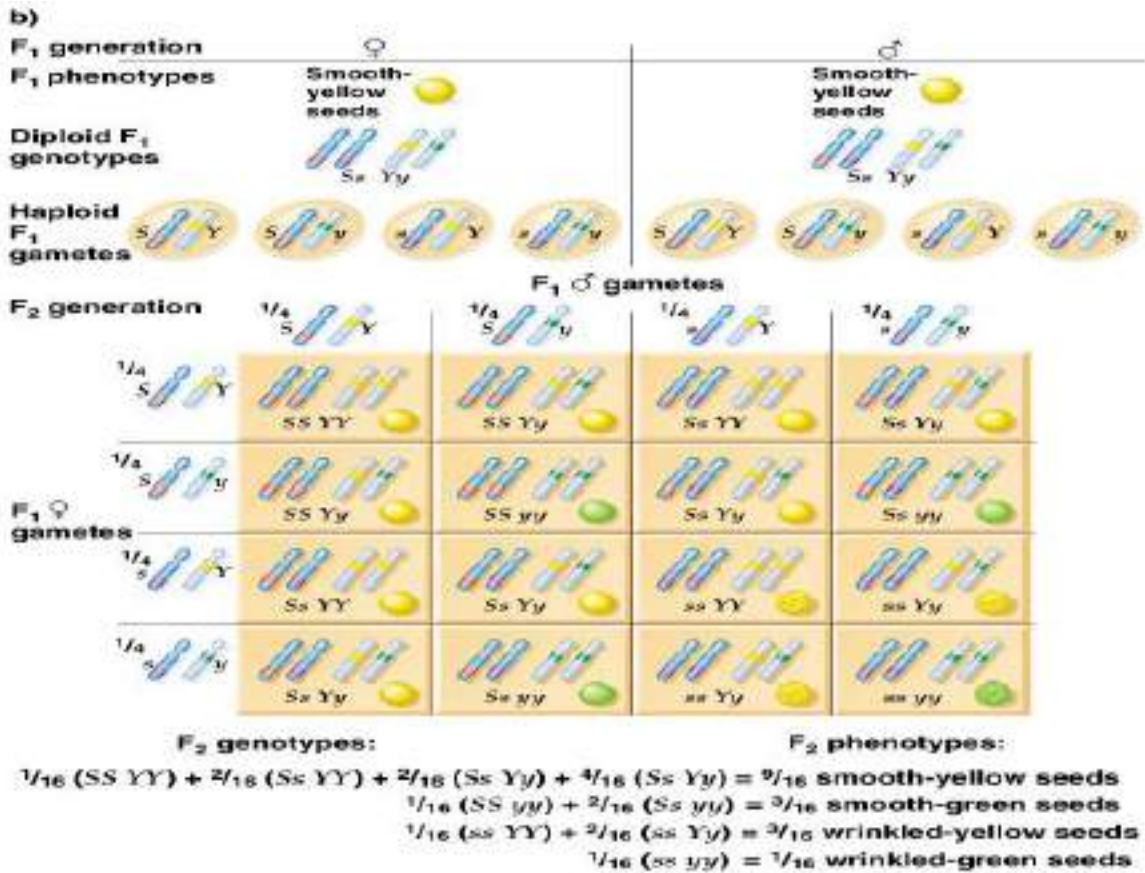

## Lesson 8

Modern Genetics Concepts

- Chromosomes and Gene (s)
- Mendelian Genetics and Non-Mendelian Genetics
- Genotypes and Phenotypes
- Mutations and Polymorphism

What is chromosome: Genetic material in cells is organized into chromosomes. Prokaryotes generally have one circular chromosome. Eukaryotes - linear chromosomes in their nuclei.

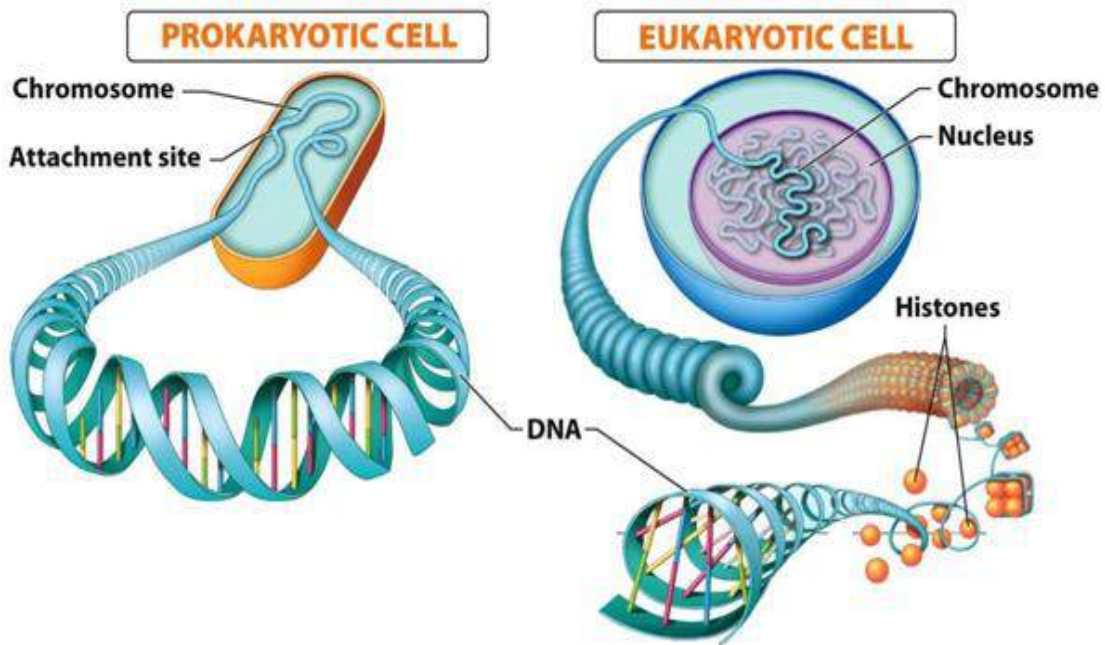

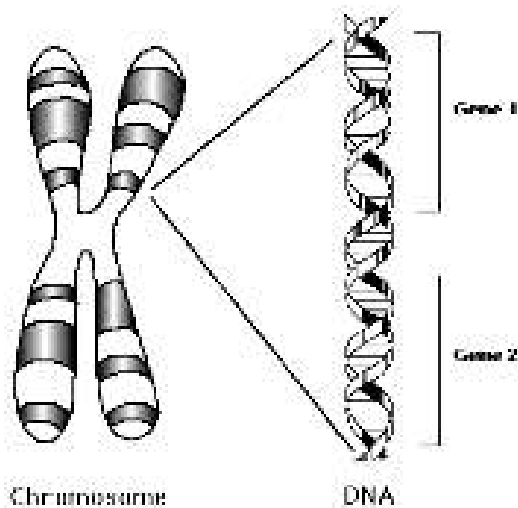

**What is gene** : A heredity unit on chromosomes.





**Mendelian genetics:** Mendelian genetics - genes that obey Mendel's laws. Most genes follow a Mendelian pattern of inheritance, However, there are many that don't.

**Non-Mendelian genetics:** Patterns of inheritance that deviate from a Mendelian pattern. Linkage - Non-Mendelian. Maternal effect, epigenetic inheritance, Mitochondrial inheritance etc.

**Genotype and phenotype:** Genetic make-up of an organism while physical appearance of a organism.

Genotype	Phenotype
<b>EE</b> Homozygous dominant	Detached Earlobes 
<b>Ee</b> Heterozygous	Detached Earlobes 
<b>ee</b> Homozygous recessive	Attached Earlobes 

<b>Phenotype= Blue Eyes</b>	<b>Phenotype=Brown Eyes</b>
	
<b>Genotype=bb</b>	<b>Genotype = Bb or BB</b>

**What is mutation:** Indicate "a change" while in other disciplines it is used to indicate "a disease-causing change". Mutations may be harmful, beneficial, may have no effect.

## Lesson 9

**Importance of Genetics:** Genetics is important to everyone

All patients

Family history

Medical history

Scientists

**Characteristic of our genetic data**

Genetic information is Personal, Permanent and Predictive

**Genetics helps us in many ways**

Diagnostics and treatments

Predictive, we can do planning

Screening (newborn, selected population, carriers)

Pharmacogenetic (individualized medicine)

**Long term effects of genetics**

Insurance

Employment

Disability

Medical care

Lifestyle, Family/children

**Genetics and evolution:** Genetics helps us to understand the process of evolution.

## **Lesson 10**

## **What is Heredity?**

- Transmission of traits from parents to offspring.
- Is transmission blending or particulate.

## **Is inheritance blending or particulate**

- Till 19th century ...biologists believed, it was blending.
- Problematic, new genetic variations would quickly be diluted, not passed onward.

## **Blending hypothesis**

- According to blending hypothesis, genetic material of the parents mixes during fertilization.
- Blue and yellow paints blend to make green paint.

## **Particulate hypothesis**

- According to particulate hypothesis, parents pass on distinct heritable units.
- Those distinct heritable units are now called as genes.

## **Particulate inheritance**

- Mendel showed characters, or what we now call alleles, were inherited unchanged.
- Pattern of inheritance of these characters gave us the first definition of a gene.

## **Mendel and particulate inheritance**

- Mendelian inheritance patterns involve genes that obey Mendel's laws. Most genes follow a Mendelian pattern of inheritance, However, there are many that don't.

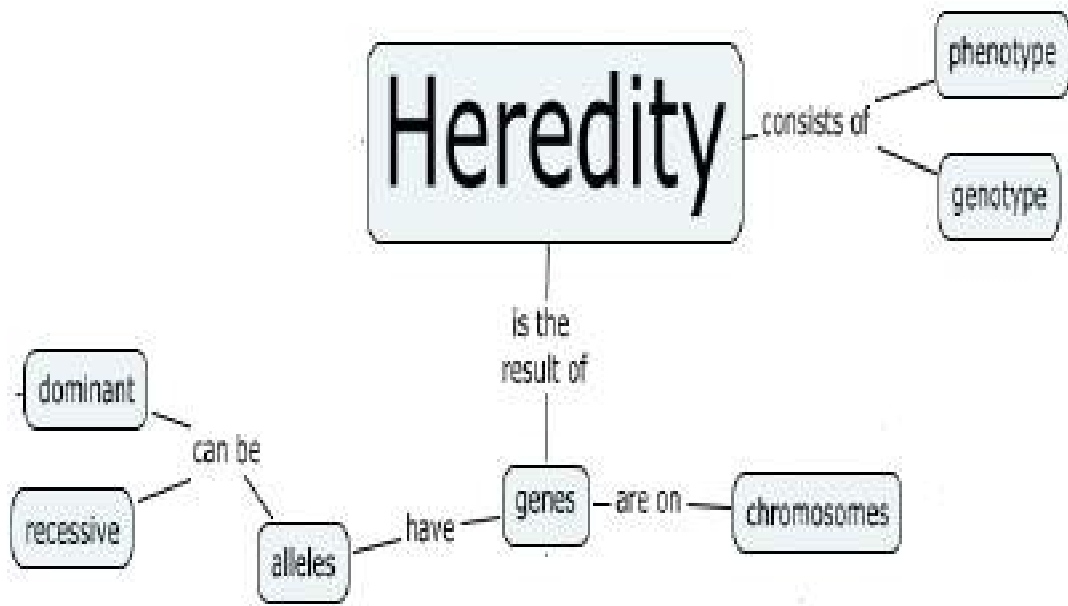

## Heredity

- Heredity is transmission of traits from parents to offspring.
- Transmission is particulate.

## Lesson 11

### Concept of variation

- Differences can be seen in individuals of the same species, such as height, weight, color etc.
- Differences due to influence of genotype and environment.

### Example: snail shells

- Their color, presence/absence of bands, number of bands etc



## Tiger moths

- These tiger moths are from the same family. What variations can you see ?



### Example - tiger moths

- Uppermost moth larger;
- Dark bands on abdomen differ in numbers and thickness;
- Patterns of forewings are quite different from each other;
- Number, shape distribution of black spots on hind wings.



## Variation In humans

- You will already be familiar with many of the variations between individuals - humans (*Homo sapiens*).

### Examples:

- Variations in skin color
- Variation in hair color
- Variation in hair curliness
- Variation in eye color
- Variation in sex



## Conclusion

- It can be concluded that variation can be seen among individuals of the same species. It can be due to genetic makeup, environment, or by a combination of both.

## Lesson 12

### Genetic and acquired variation

#### What is Inherited Variations?

- Inherited variations result from the activity of genes.
- Genetically controlled and cannot be altered.
- Blood groups, finger prints and sex etc.

#### Acquired Variation

- Acquired variation result from an individual's activities or nutrition or from environment conditions during a lifetime.

#### Acquired Variation

- Acquired characteristics can not be inherited. Language, obesity, athletic skills etc

**Example: Apples** - different position on same tree

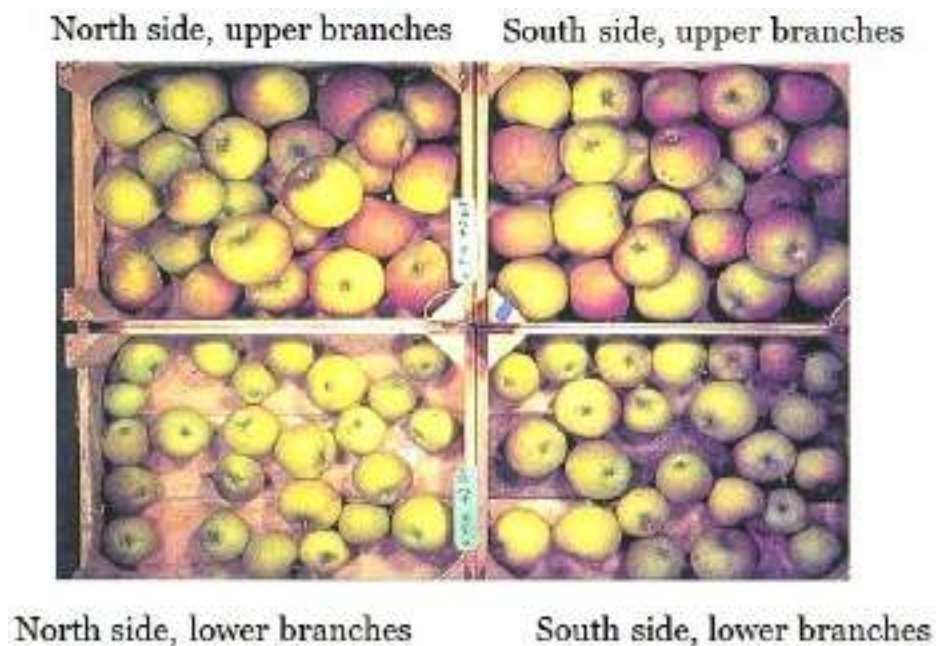

### **Acquired variation**

- The differences between the apples are acquired during the growing season.
- The differences will not be inherited.

### **Why this variation**

- Environmental conditions caused the differences in size of the apples ?
- The upper branches more sunlight than lower branches.

### **Variation by genetic and environment**

- Many variations - both genetic and environmental.
- Height depend on what genes you inherit and the amount of food you get.

### **Conclusion**

- Variation can be seen among individuals of same species.
- It can be due to genetic makeup, environment or by combination of both.

## Lesson 13

**Types of variation:** Two types of Variation

- Discontinuous Variation
- Continuous Variation

### Discontinuous Variation

Discontinuous variations are entirely genetically controlled.

They cannot be altered by external conditions. Blood group, color blind, dwarfism are genetically controlled.

### Graph for discontinuous

- Discontinuous variation in blood group. The figures ...not to fit a smooth curve.

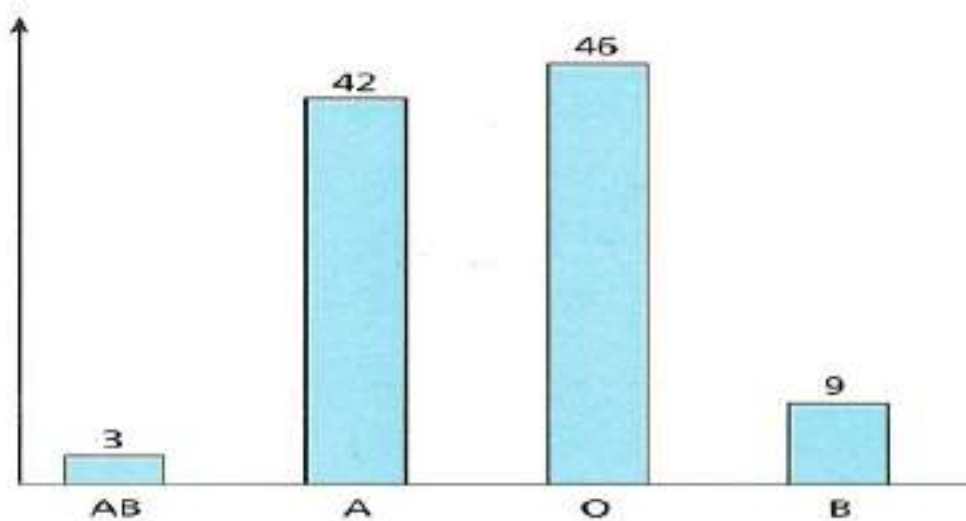

## Continuous variation

Continuous variation describes the situation in which there are many intermediates between the extremes. Shade of hair color between black and blond.



Hair color is continuous variation

### Several pair of genes involved

- The genome AA BB CC DD -black hair while the genome aa bb cc dd - blond hair.
- Genomes AaBbCcDd or AABbCCdd or aaBBccDd and all the other possible combinations –intermediate.

### Factors - continuous Variation

- Continuous variation occurs –when controlled by the genes and the environment.
- Height depend on the genes and on the amount of food you eat during your growing.

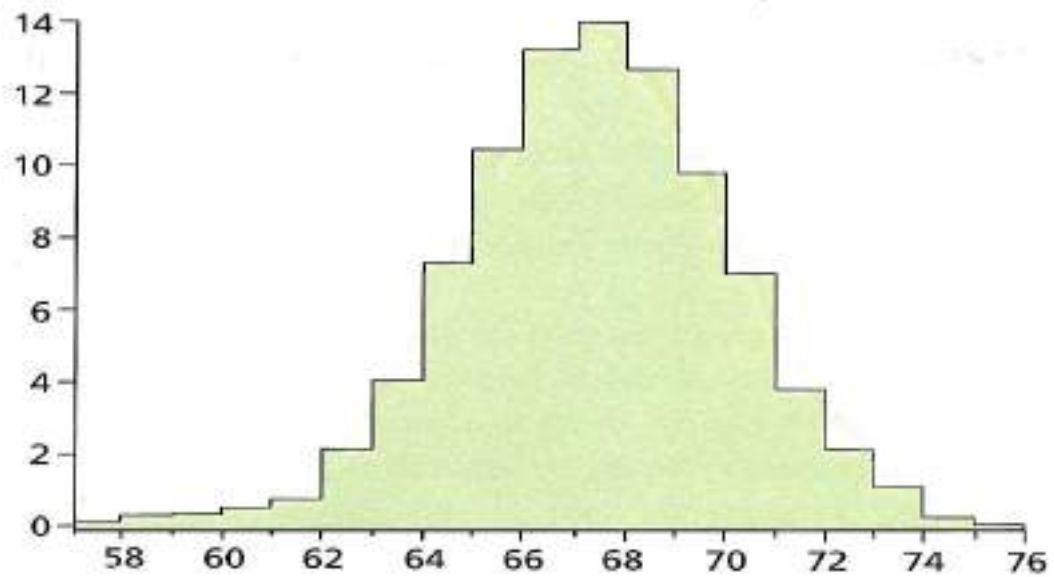

Graph-continuous Variation - Smooth curve graph - height



#### Continuous Variation

- No distinct categories
- Tends to be quantitative
- Controlled by a lot of genes
- Strongly influenced by the environment

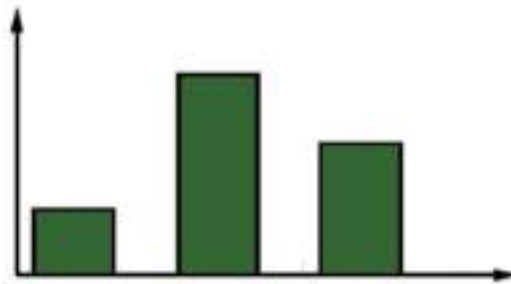

#### Discontinuous Variation

- Distinct categories
- Tends to be qualitative
- Controlled by a few genes
- Unaffected by the environment

# Lesson 14

## Source of variation

### Causes of Variation

- Genetic causes of variation
- Environmental causes of variation

### Genetic causes of variation

- Meiosis
- Sexual reproduction
- Mutations

### Environmental causes of variation

- Nutrients
- Drugs
- Temperature
- Physical training

<b>GENETIC CAUSES OF VARIATION</b>	<b>ENVIRONMENTAL CAUSES</b>
<b>Meiosis – here pairs of chromosomes exchange genes &amp; split from each other producing gametes which are not identical</b>	<b>Nutrients – the food we eat &amp; minerals available to plants</b>
<b>Sexual reproduction – allows for recombination of genetic material from each parent in new ways in the zygote</b>	<b>Drugs – e.g. thalidomide was given to pregnant women in 1960s caused deformities</b>
<b>Mutations – these are random mistakes in the replication of DNA which make the new DNA slightly different to the original</b>	<b>Temperature – affects the rate of enzyme-controlled rxns, e.g. plants grown in warm conditions show faster rates of photosynthesis hence grow faster and better than those in colder environments</b>
	<b>Physical training – when you use muscles you increase their size &amp; power e.g. athletes develop strong muscles as they train for their sport</b>

## **Conclusion**

- Variation from genetic causes are inherited from parents to offspring.
- Inherited variation - raw material for natural selection.
- Variations from environmental causes are not inherited.
- Variations that result from acquired characteristics are not acted upon by natural selection & thus do not affect evolution.



## Lesson 15

### Heredity and variation in Mendel s' work

#### Heredity in Mendel Work

- Gregor Mendel – inheritance how characteristics were passed ...generation.
- Pure-breeding plants e.g. tall plants produced only tall offspring & purple flowered plants produced only purple.
- There was a clear indication of heredity and variation in his work.

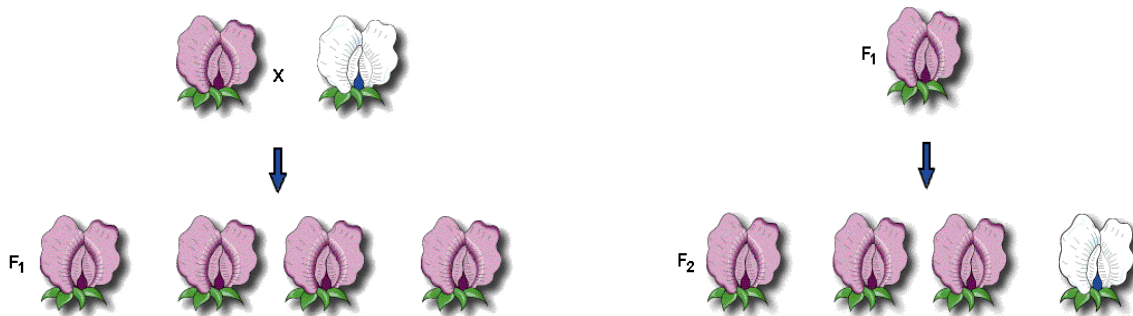

Both heredity and variation may be seen

- Variation is widespread in nature.
- Variation is inherited according to genetic laws and not solely by chance.

## Lesson 16

### Mendelian and Non-Mendelian inheritance

#### Mendelian inheritance

- Gregor Mendel's model of inheritance describes
- Each trait is controlled by a single gene.
- Each gene has two alleles.
- A clear dominant-recessive relationship between alleles.
- Mendelian inheritance involve the genes that obey Mendel's laws: Law of dominance Law of segregation Law of independent assortment.

#### Mendelian inheritance

- Phenotypes will obey patterns;
- Autosomal dominant
- Autosomal recessive
- X-linked etc.

#### Non-Mendelian inheritance

- Pattern of inheritance that deviate from Mendelian pattern of inheritance is called as Non-Mendelian inheritance.
- Those genes that do not follow principles of heredity formulated by Gregor Mendel.

#### Examples of Non-Mendelian inheritance

- Mitochondrial inheritance
- Genomic (parental) imprinting
- Incomplete dominance
- Co-dominance
- Multiple alleles
- Epigenetics

## **Lesson 17**

### **Conclusions of Mendelian inheritance**

#### **Mendelian inheritance**

- Mendel's conclusions were based on three laws:
- Law of Dominance
- Law of Segregation
- Law of Independent Assortment

#### **Conclusion- law of dominance**

- Cross of true-breeding strains resemble only one of the parents.
- Smooth seeds (S) are completely dominant to wrinkled seeds (s)

#### **Conclusion - Law of segregation**

- Two members of a gene pair segregate (separate) from each other during the formation of gametes.

#### **Conclusion-Law of independent assortment**

- Alleles for different traits assort independently of one another.
- Genes on different chromosomes independently behave.

## Lesson 18

### Exceptions to Mendelian inheritance

### Exceptions to Mendelian inheritance

- Incomplete dominance
- Codominance
- Multiple alleles
- Polygenic traits
- Epistasis
- Pleiotropy
- Environmental effects on gene expression
- Linkage
- Sex linkage

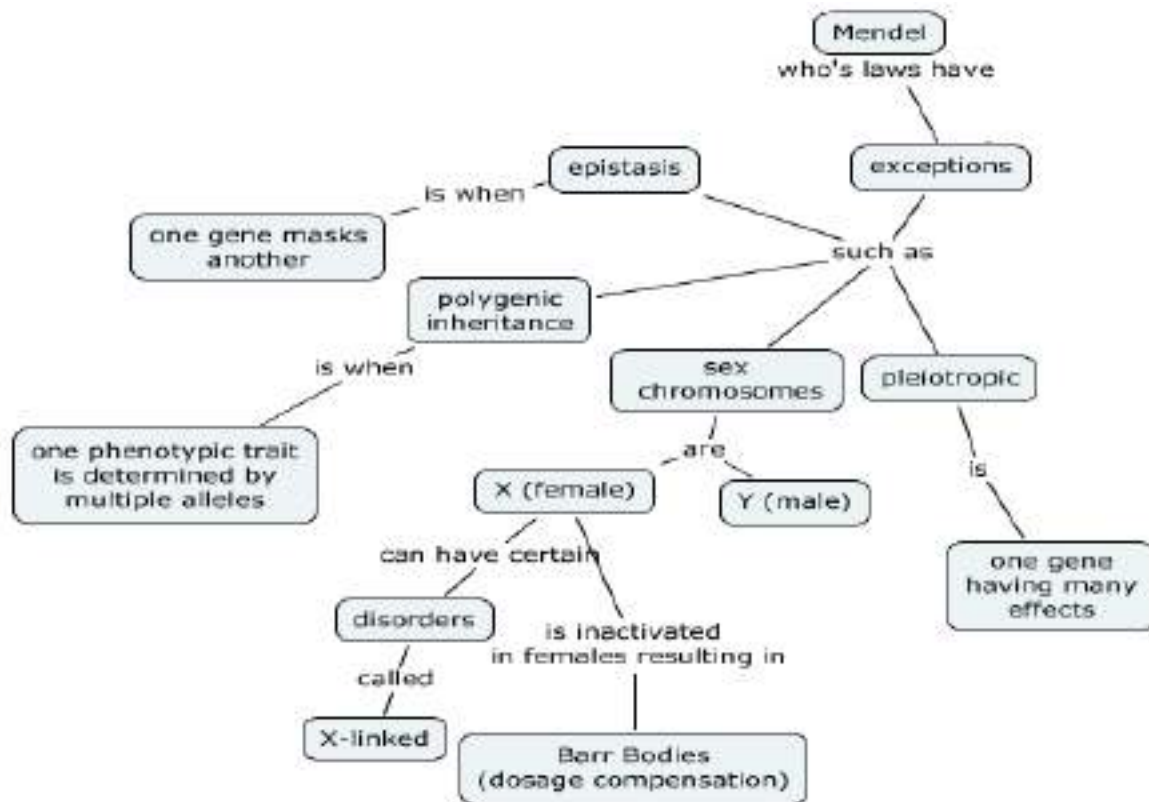

## Lesson 19

### Incomplete dominance

- Some alleles for a gene are not completely dominant.
- An intermediate phenotype – between two extremes.
- None of the allele is dominant.

### Incomplete dominance

- As none of the alleles is dominant. As a result of a cross, a “new” phenotype appears that is a blend of both alleles.

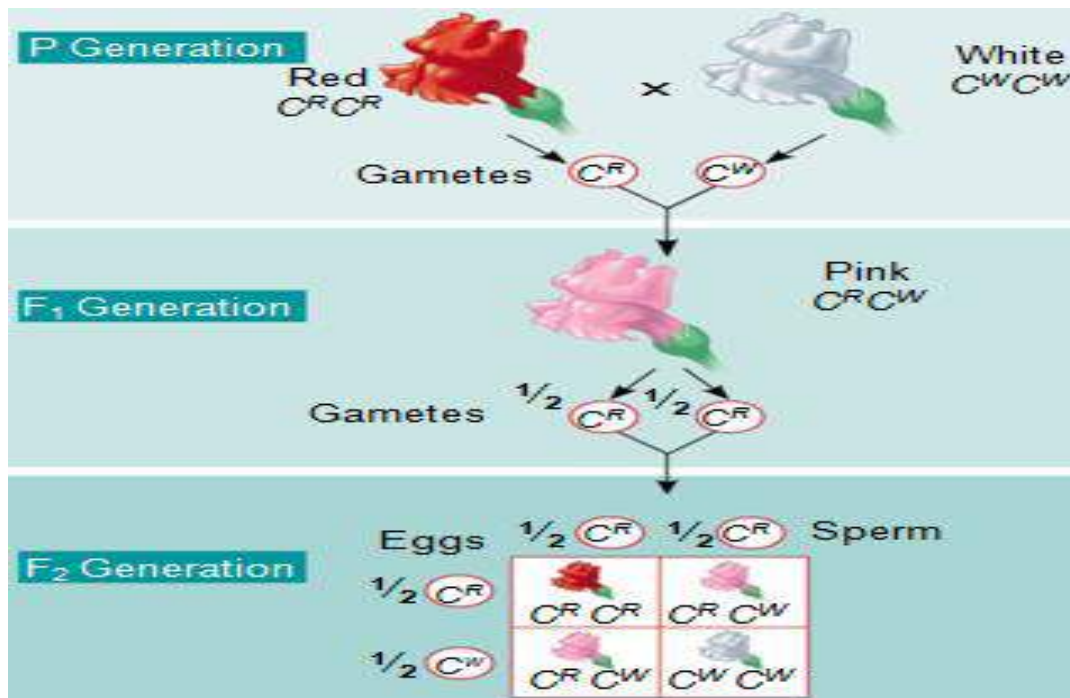

Example: Japanese 4 o'clock flowers

### Genotypes of Japanese 4 o'clock plant

- Red flower plant genotype = **RR**
- White flower plant genotype = **WW**
- Pink flower plant genotype = **RW**

Incomplete dominance is a situation in which neither allele is dominant.





- New phenotype appears.
- New phenotype is blend of both alleles.

## Lesson 20

### Co-dominance

- A situation, when both alleles appear in the phenotype.
- Neither allele is dominant.
- Both alleles are expressed in a heterozygous individuals.
- Parallel behavior of both allele.

### Example 1 : Blood group

Genotype	Phenotype (Blood Group)	Red Blood Cells
$I^A I^A$ or $I^A i$	A	
$I^B I^B$ or $I^B i$	B	
$I^A I^B$	AB	
$ii$	O	

## Example 2: Roan cattle inheritance

- Roan color in cattle appears as a mix of red and white colors.

$cr cr$  = **red hairs**

$cw cw$  = **white hairs**

$cr cw$  = **roan coat**



## Roan cattle inheritance

- Roan color in cattle appears as a mix of red and white.

## Example 3: Appaloosa horse

- Gray horse dominant to white horse.
- Heterozygous is appaloosa –a white horse with gray spots.



- A situation, when both alleles appear in the phenotype and neither of the alleles is dominant.



## Lesson 21

### Polygenic traits

- Most traits are not controlled by a single gene locus, but by the combined interaction of many gene loci.
- These traits are called polygenic traits.

### Example: Humans Height

- Graph for continuous variation

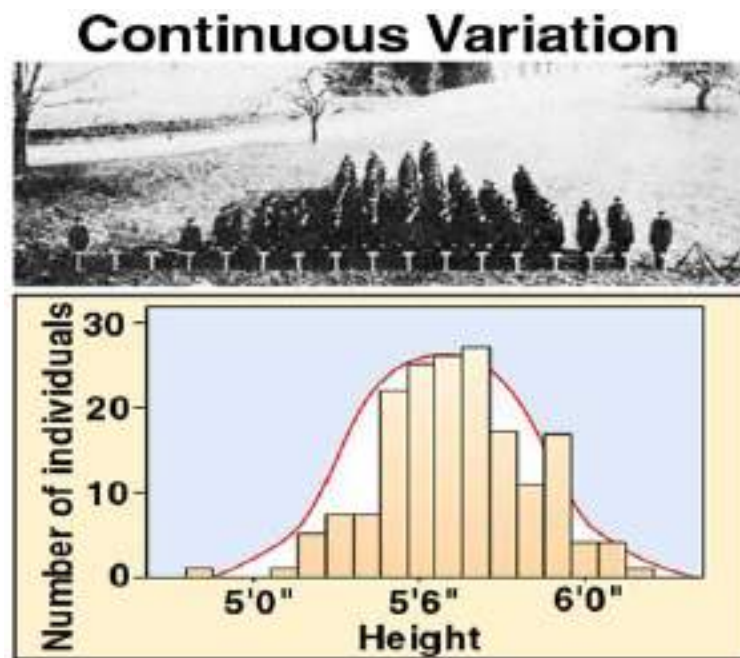

**Example: Humans eyes color is controlled by many genes.**

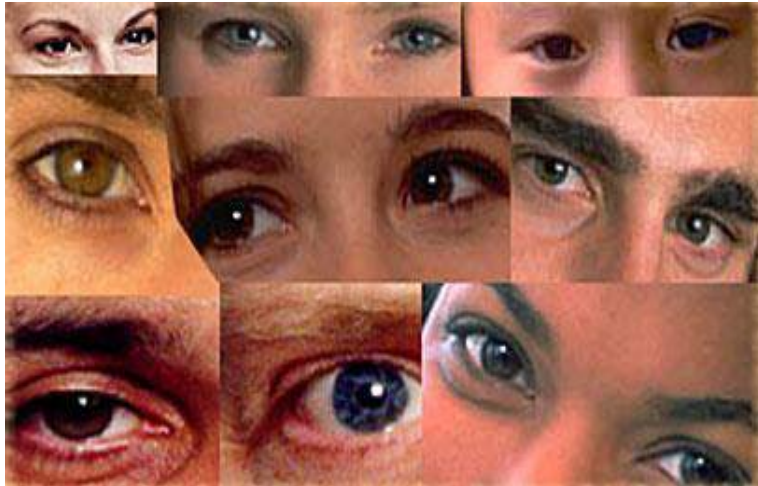

### **Pigmentations in humans**

- Qualitative traits usually indicate polygenic inheritance; effect from two/more genes.
- Skin color pigmentation in humans is controlled by at least three separately inherited genes.

### **Pigmentation in humans**

- Controlled by three genes.

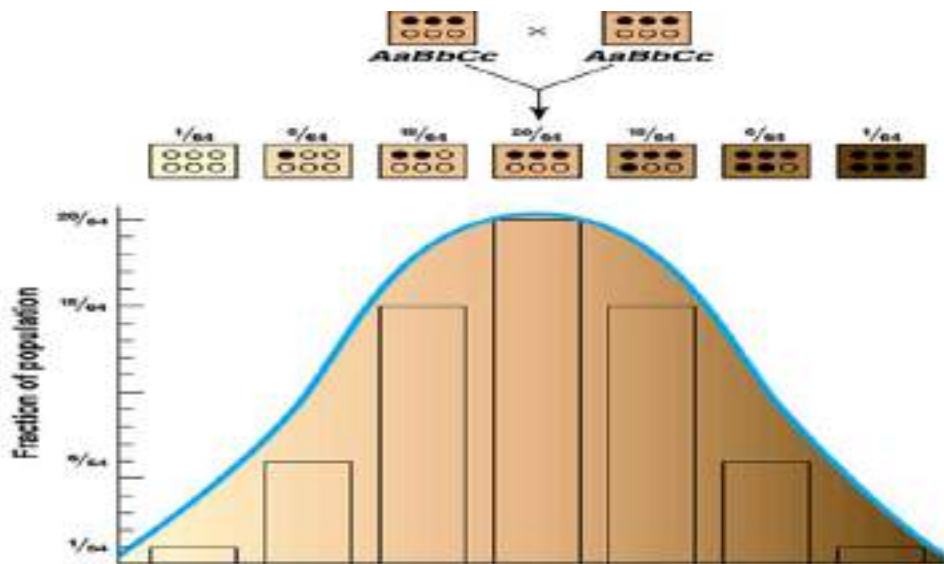

## Conclusion

- Polygenic traits are those traits which are controlled by additive effect of many genes.
  - Qualitative traits are usually polygenic in nature.

## Lesson 22

### Epistasis

- Alleles at one gene locus can hide or prevent expression of alleles at second gene locus.
- Labrador retrievers one gene locus affects coat color by controlling pigment eumelanin deposited in the fur.

### Example

- A dominant allele B for black, recessive allele b brown coat, a second gene (e) locus controls eumelanin deposited in fur.
- Dogs homozygous recessive at this locus (ee) will have yellow fur no matter which alleles are at first locus.

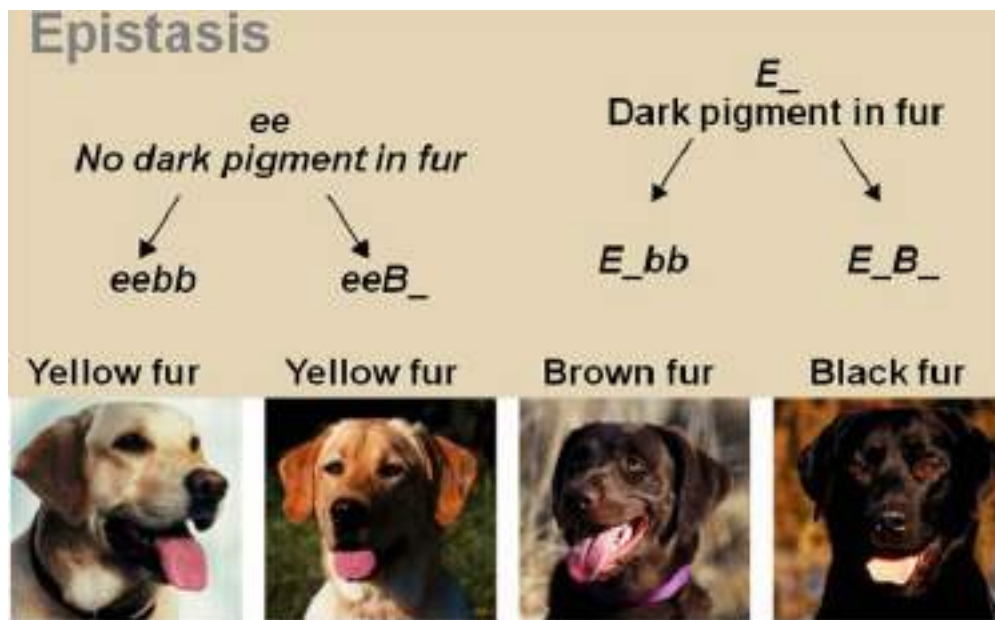

### Example: Epistasis in horses fur

- Horse coloration involves 2 or more gene pairings.
- EE or Ee is for black.
- ee is for red (sorrel).
- Other genes can add effects to base colors.
- Bay is AA, Ee – black with agouti gene;
- Buckskin is AA, EE, CcrC – bay with cremello gene,
- Dun is AA, Ee, Dd – bay with dun gene;
- Palomino is ee, CcrC – sorrel with cremello gene.

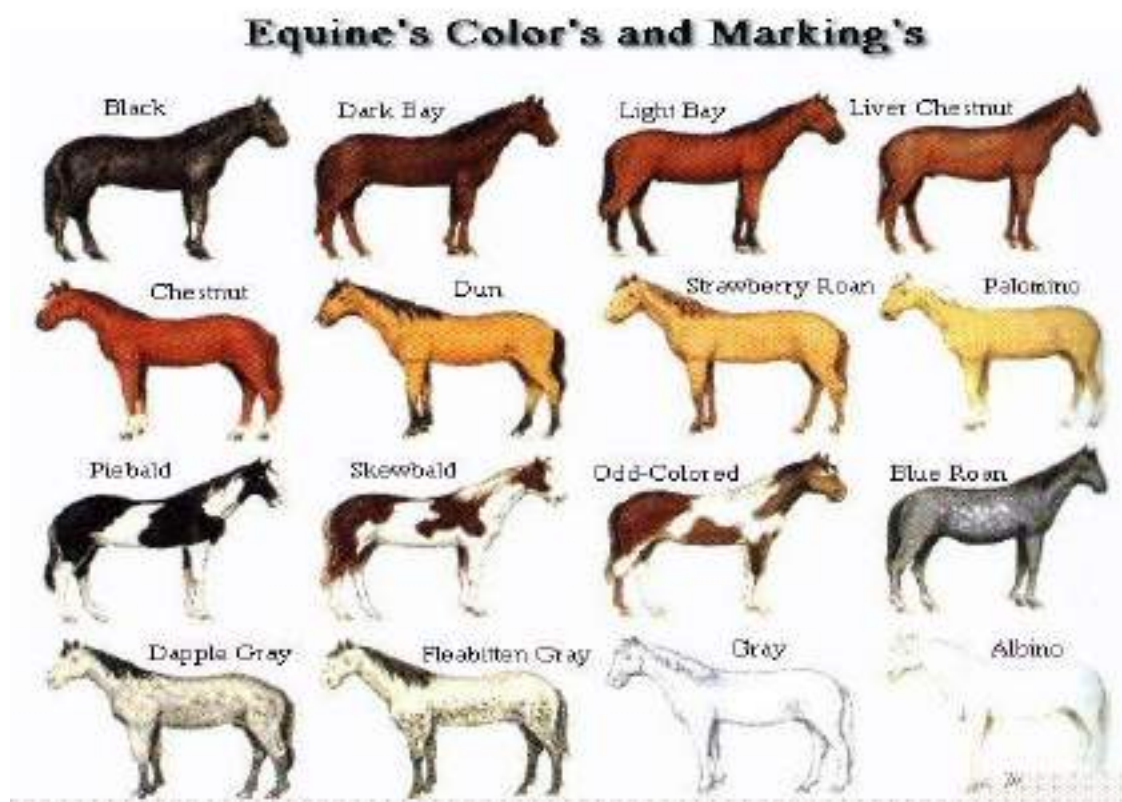

Alleles at one gene locus can hide or prevent expression of alleles at second gene locus is called as epistasis.

## Lesson 23

### Pleiotropy

- The ability of a gene to affect an organism in many ways is called pleiotropy.
- Pleiotropy refers to an allele which has more than one effect on the phenotype.
- This phenomenon occurs when a single gene locus produces more than one traits.

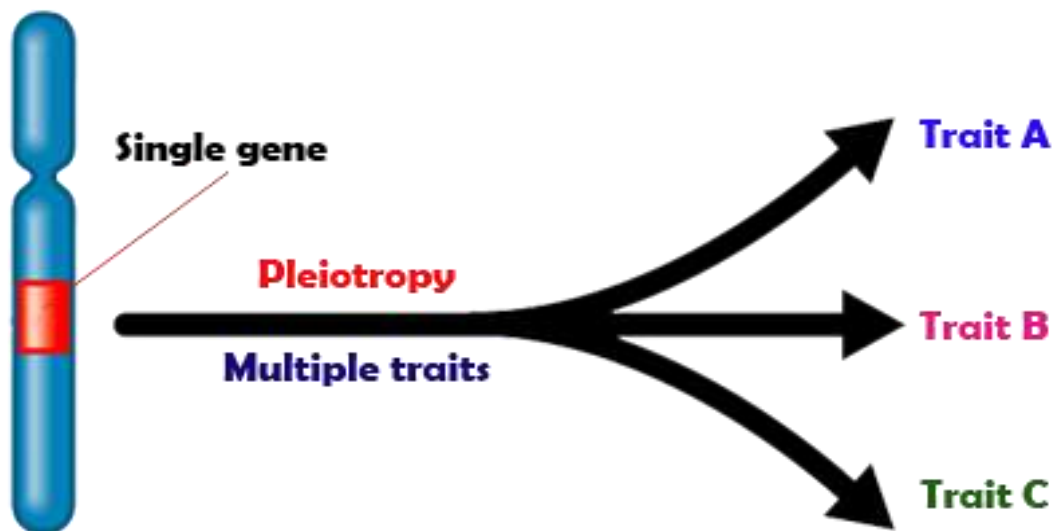

### Pleiotropic effects in humans

- Example:
  - Sickle cell anemia
  - Cystic fibrosis

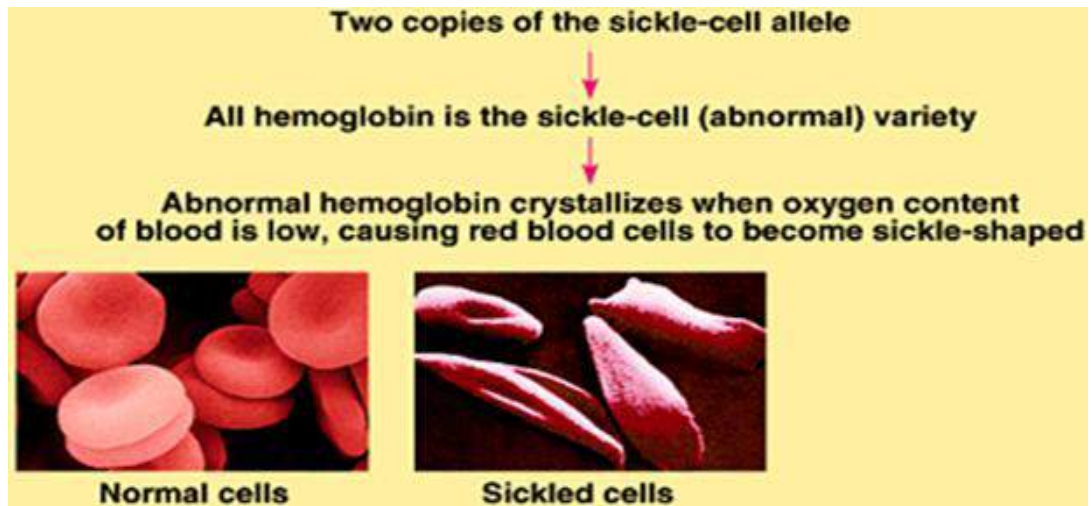

## Cystic fibrosis

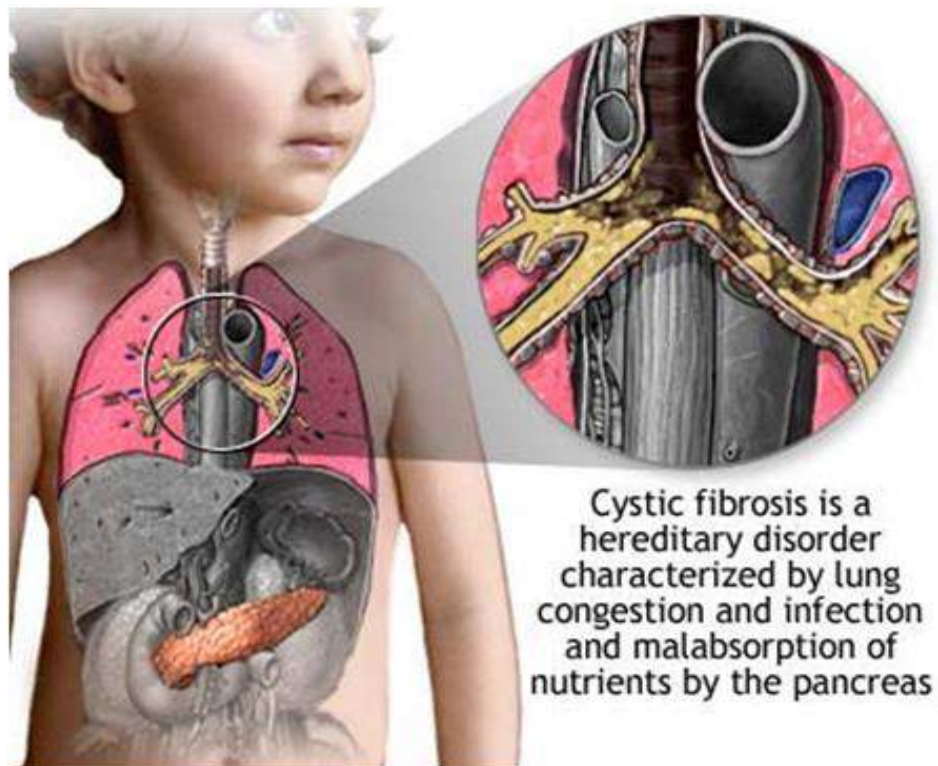

## **Huntington disease**

- One gene – more than one phenotypes
- **Phenotype 1:** progressive dementia at age of 40-50 years
- **Phenotype 2:** death in about 5 years after onset of disease.



## Lesson 24

### Environmental effects

#### Environmental effects on Gene expression

- The phenotype of an organism depends not only on which genes it has (genotype), but also on the environment under which it develops.

#### Interaction - genotype and environment

- Although scientists agree that phenotype depends on a complex interaction between genotype and environment.
- Debate and controversy about the relative importance of both.

### Environmental effects

- Allele expression may be affected by environmental conditions
- Examples:
  - Coat color in arctic foxes
  - Himalayan rabbits
  - Siamese cats

### Explanation

- ch allele affected by temp  $>33$  C tyrosinase enzyme inactivates and reduces melanin pigment.



Arctic Fox Summer



Arctic Fox Winter

## Himalayan rabbits



## Siamese cats



## Environmental effect on phenotype

- pH of the soil will change the color of hydrangea flowers.

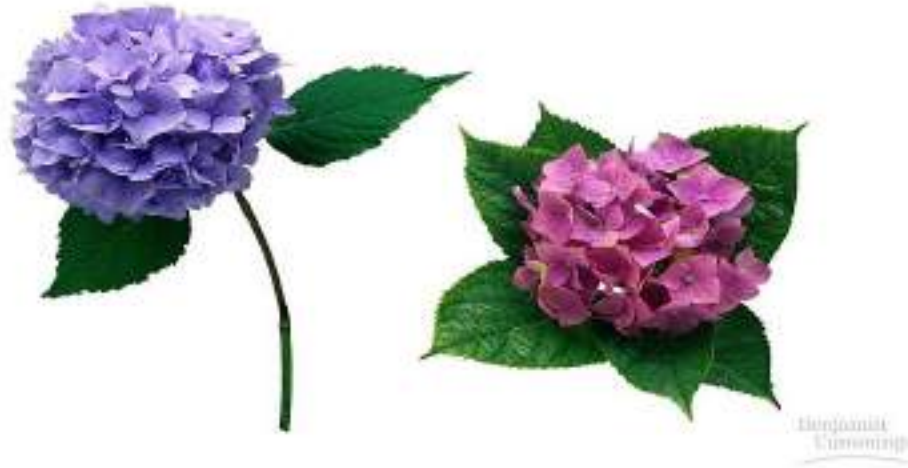

There is a strong impact of environment on the expression of certain traits.

## Lesson 25

### What are Chromosomes:

Chromosomes are the rod-shaped, filamentous bodies present in the nucleus. They are the carriers of genes. Chromosome not visible in active nucleus due to high water content but can be seen during cell division. Chromosomes were described by Strausberger in 1875. Chromosome was first used by Waldeyer in 1888.

They were given the name chromosome (Chromo = color; Soma = body). Their numbers can be counted easily only during mitotic metaphase. Chromosomes are composed of thin chromatin threads called chromatin fibers.

**Chromatin fibers folding** Chromatin fibers undergo folding, coiling and supercoiling during prophase so that the chromosomes become progressively thicker and smaller and become visible. At the end of cell division, the fibers uncoil and extend as fine chromatin threads, which are not visible at light microscope.

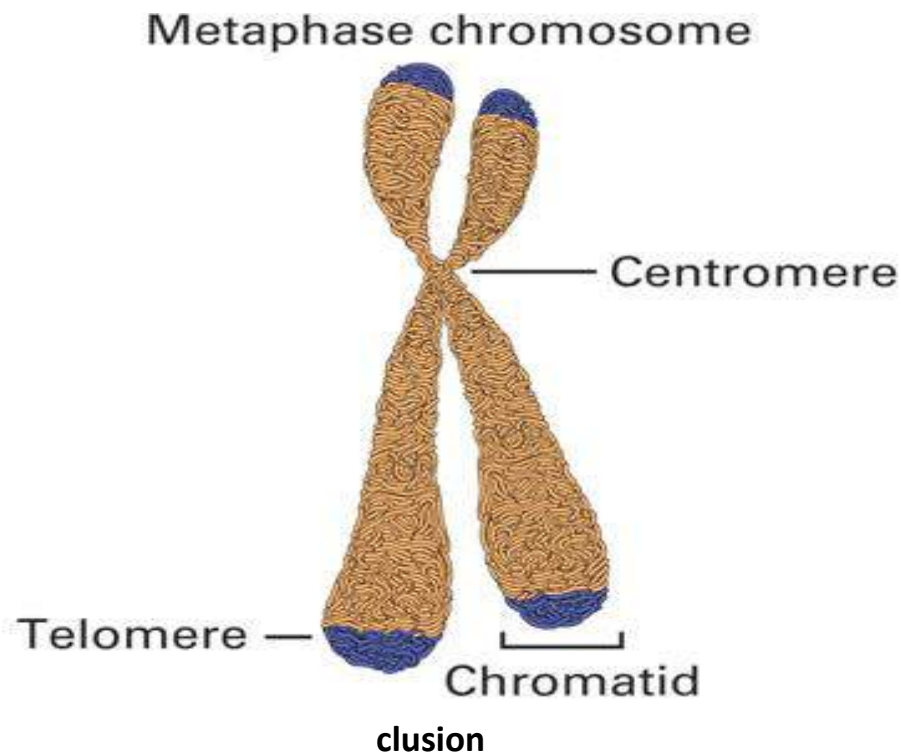

- Chroso

Chromosomes are rod shaped filamentous bodies present in the prokaryotic/eukaryotic cells.

## Lesson 26

Chromosome Structure: Living organisms are made up of cells. Within cell, there is nucleus or nucleoid region. DNA or chromosomes are present in nucleus/nucleoid region.

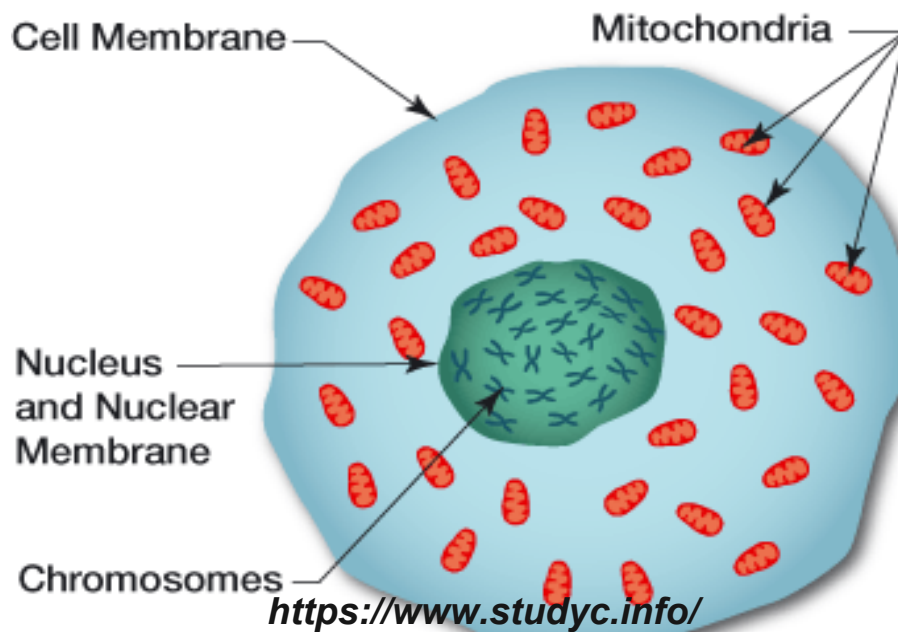
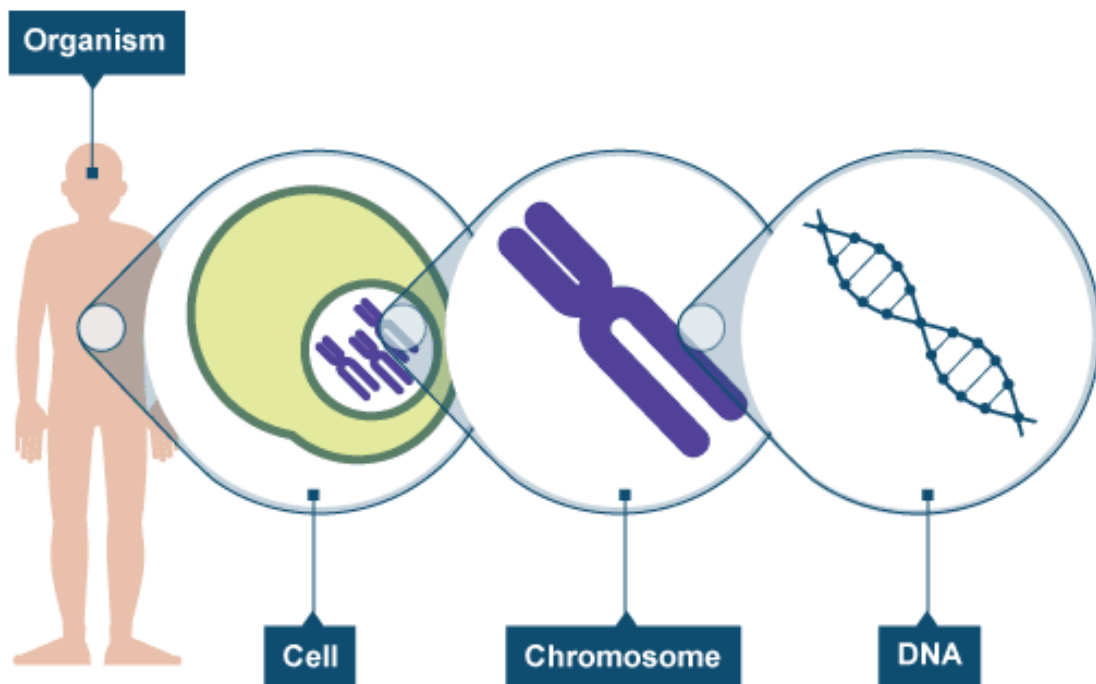

Chromosome structure: chromosomes are made of DNA and associated proteins. Chromosome carries part or all of a cell's genetic information. Chromosomes have sister chromatids. Centromere is constricted region, where chromatids are attached.

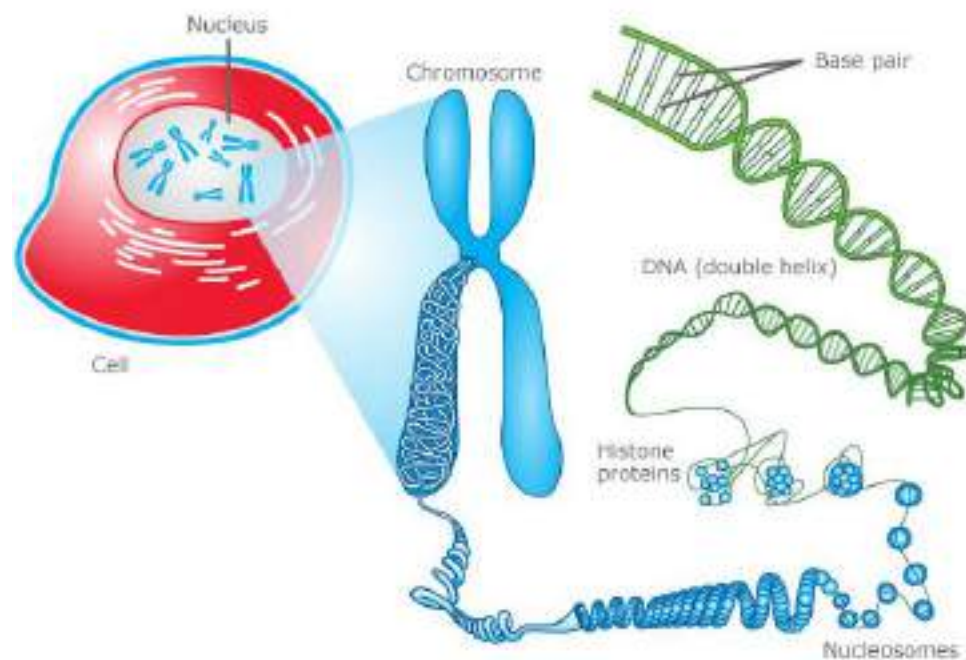

A chromosome constitutes DNA molecule, a protein Histones and supercoiled DNA

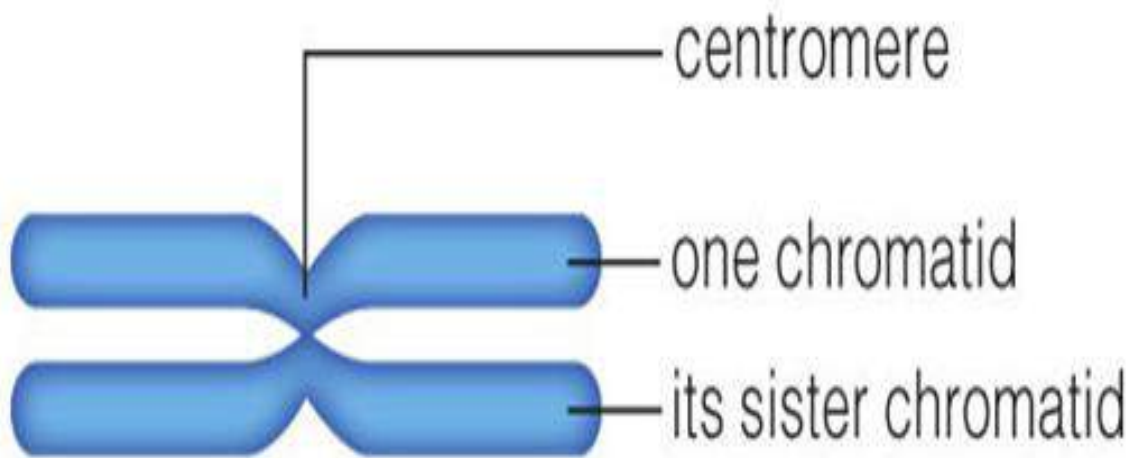

## Lesson 27

### Variation in number of chromosomes:

Different organisms have different number of chromosomes. Most organisms have chromosomes numbers between 12 to 50. Round worm has only two chromosomes. Protozoa having 300 or more. Fungi have 3-8 chromosomes. Angiosperms have from 8 – 16 (most common number 12).

**Chromosomes in humans:** There are 46 chromosomes in humans. Humans have 23 pairs of chromosomes out of which 22 pair of autosomes and one pair of sex chromosomes.

Organism	No. chromosomes
■ Human	46
■ Chimpanzee	48
■ Dog	78
■ Horse	64
■ Chicken	78
■ Goldfish	94
■ Fruit fly	8
■ Mosquito	6
■ Nematode	11(m), 12(f)
■ Horsetail	216
■ Sequoia	22
■ Round worm	2

Organism	No. chromosomes
■ Onion	16
■ Mold	16
■ Carrot	20



■ Tomato	24
■ Tobacco	48
■ Rice	24
■ Maize	20
■ Haploppus gracilis	4
■ Crepis capillaris	6

## Lesson 28

**Chromosomes in prokaryotes and eukaryotes:** Chromosomes are present in both kinds of cells. Although they are different in both type of cells.

**Chromosomes in prokaryotes:** Prokaryotes have single chromosome plus plasmids. Circular chromosome is made up only of DNA which is found in cytoplasm.

- **Chromosomes in prokaryotes**

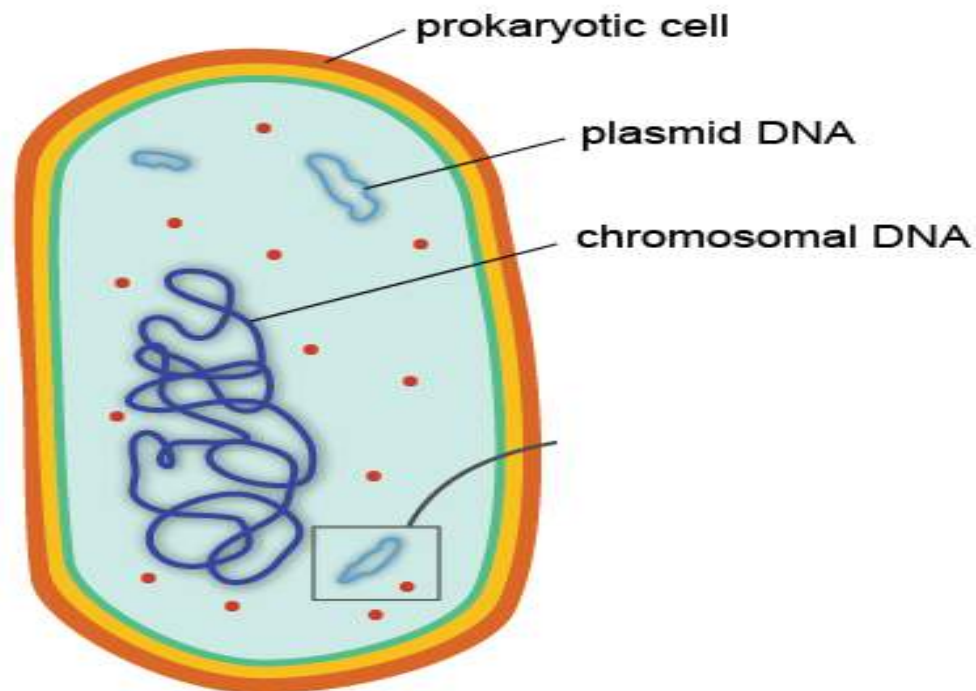

**Chromosomes in Eukaryotes:** There are many chromosomes in eukaryotes which are linear and made of chromatin, a nucleoprotein – histones. These chromosomes are found in a nucleus. Eukaryotic chromosomes are condensed and visible during cell division. At the beginning of mitosis can be seen - consist of two threads (sister chromatids) joined by a centromere. The sister chromatids are identical copies. During mitosis, the sister chromatids separate and are placed into two daughter nuclei.

Comparison of prokaryotes and eukaryotes

<b>PROKARYOTES</b>	<b>EUKARYOTES</b>
single chromosome plus plasmids	many chromosomes
circular chromosome	linear chromosomes
made only of DNA	made of DNA and histones.
found in cytoplasm	found in a nucleus
copies its chromosome and divides immediately afterwards	copies chromosomes, then the cell grows, then goes through mitosis into two groups

## Lesson 29

**Salient features of Chromosomes:** Followings are the salient features of chromosomes.

**Shape of Chromosomes:** Chromosomes can be circular or linear

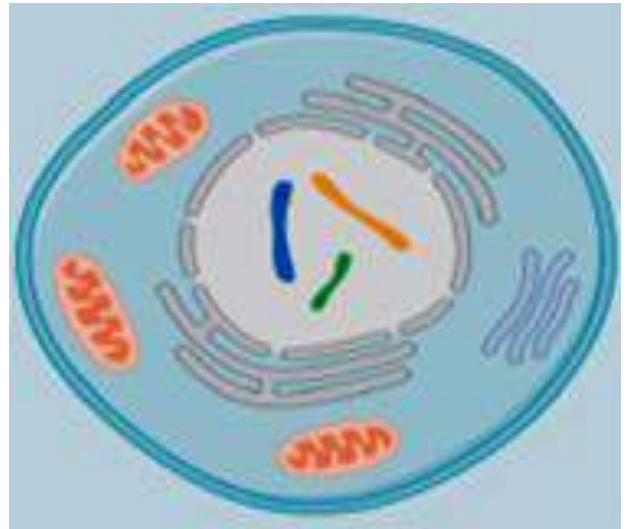
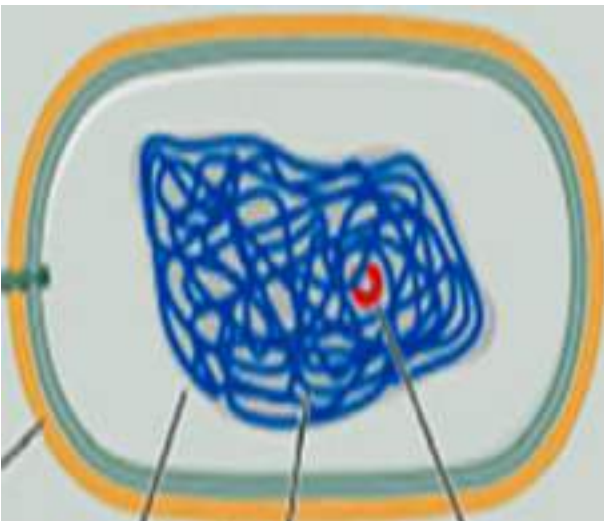

**Chromosomes numbers:** Chromosome number is a characteristic of a species.

**Copy number of Chromosomes:** Chromosome can be haploid, diploid or polyploid.

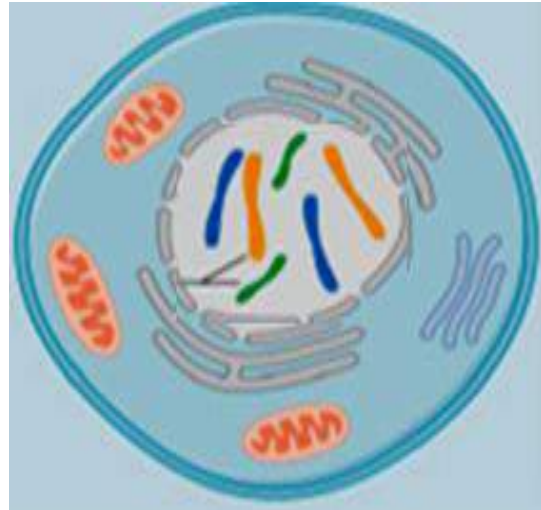
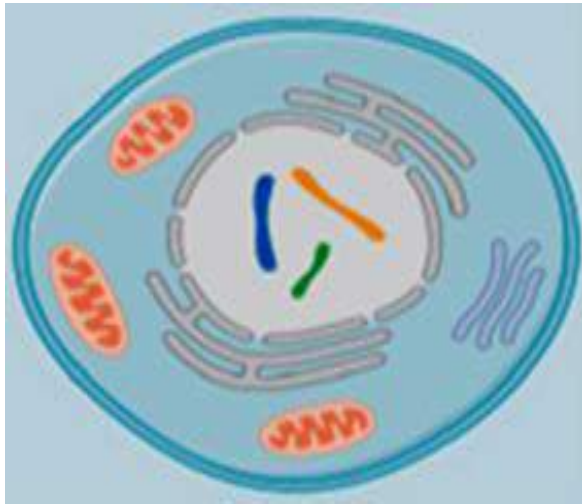

Genes on chromosomes: Number of genes are different in each of the species.

- Humans 25,000 - 27,000
- Rice 45,000
- Drosophila 13,700
- Yeast 5,800

Gene density on Chromosomes: Prokaryotes has higher gene density than eukaryotes per Mb of DNA.

Genome characteristics: Prokaryotes have less genome size as compared to eukaryotes. Prokaryotes have less number of genes as compared to eukaryotes. Prokaryotes have higher gene density as compared to eukaryotes.

## Lesson 30

**Size of chromosomes:** The size of the chromosomes varies between 0.5  $\mu$  to 32  $\mu$  in length. Diameter of chromosomes varies - 0.2  $\mu$  and 3.0  $\mu$ . The longest chromosomes found in Trillium - 32  $\mu$ . The giant chromosomes found in diptera and they may be as long as 300  $\mu$  and up to 10  $\mu$  in diameter. In general, plants have longer chromosomes than animals. Species having less chromosome number usually have long chromosomes. Dicots in general, have a higher number of chromosomes than monocots. Chromosomes are longer in monocot than dicots.

Size at stages of mitosis: There is variation in the sizes of chromosomes during different stages of mitosis such as

Interphase: Chromosomes are longest & thinnest.

Prophase: there is a progressive decrease in their length accompanied with an increase in thickness.

Anaphase: chromosomes are smallest.

Metaphase: chromosomes can be easily observed.

Chromosomes are studied during metaphase

Measurement of chromosomes: Chromosomes are generally measured during mitotic metaphase.

## Lesson 31

**Types of Chromosomes:** There are two types of eukaryotic chromosomes:

- Autosomes
- Sex chromosomes
- 

**Autosomes:** Paired chromosomes with the same length, shape, centromere location, and genes.

Any chromosomes other than sex chromosomes are called as autosomes.

**Sex Chromosomes:** Members of a pair of chromosomes that differ between males and females.

Bases on this pair of chromosomes, sex is identified.

**Type of Chromosomes based on Centromere position** Chromosomes may differ in the position of the centromere.

Centromere is near the middle, metacentric

Centromere is toward one end, acrocentric or sub metacentric

Centromere is very near to end, telocentric

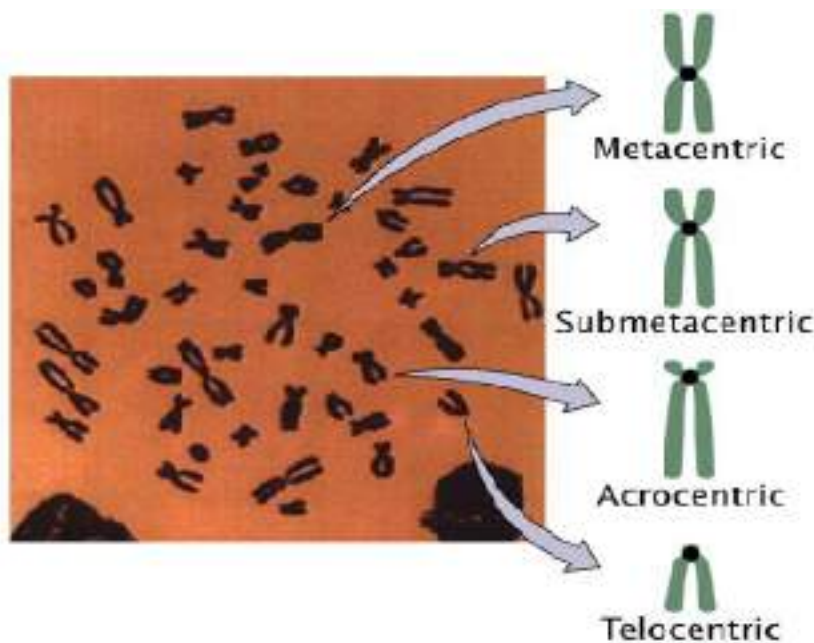

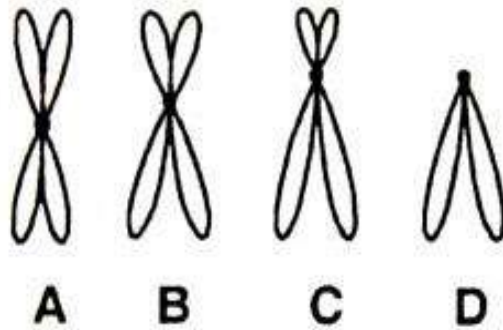

- A - Metacentric chromosome**
- B - Sub-metacentric chromosome**
- C - Acrocentric chromosome**
- D - Telocentric chromosome**

### Lesson 28

**Centromere-function:** Centromere and telomeres are two essential features of all eukaryotic chromosomes. Each provide a unique function i.e., absolutely necessary for the stability of the chromosomes. Centromeres are required for the segregation of the chromosomes during meiosis and mitosis. Telomeres provide terminal stability to the chromosome and ensure its survival. The region where two sister chromatids of a chromosome joined or “held together” during mitotic metaphase is called centromere. When chromosomes stained they show a dark-stained region that is the centromere. The region where two sister chromatids of a chromosome joined or “held together”

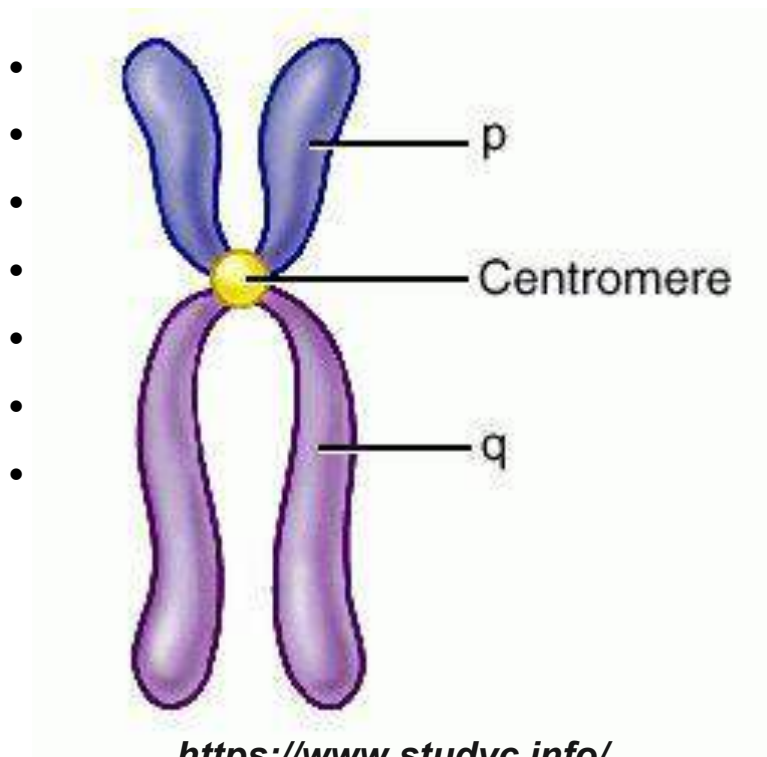



During mitosis, the centromere that is shared by the sister chromatids must divide so that the chromatids can migrate to opposite poles of the cell. Centromere is an important component of chromosome structure and segregation. Centromeres are the first parts of chromosomes to be seen moving towards the opposite poles during anaphase.

Centromere moving towards the opposite poles. The remaining regions of chromosomes lag behind and appear as if they were being pulled by the centromere.

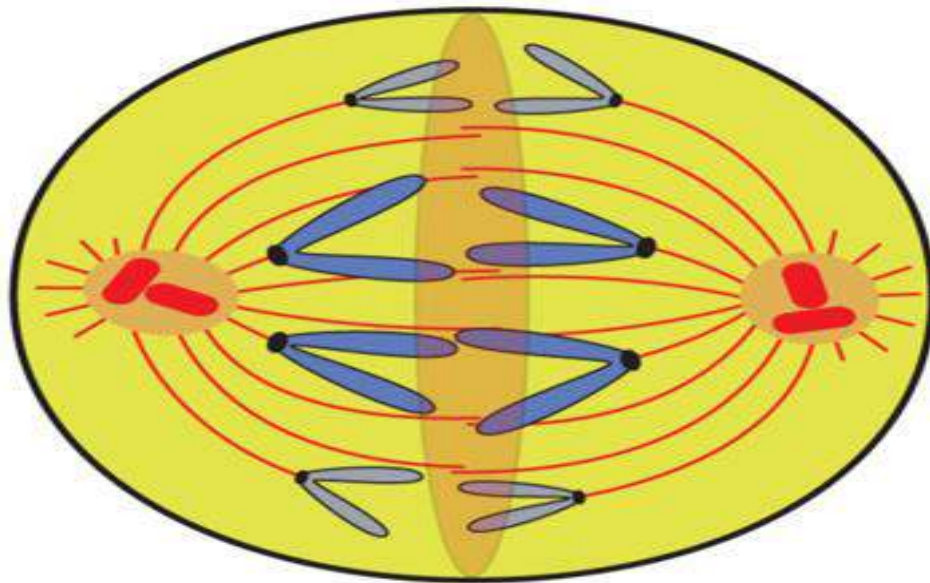

## Lesson 32

**What are telomeres:** The two ends of a chromosome are known as telomeres. These are required for the replication and stability of the chromosomes. When telomeres are damaged or removed due to chromosome breakage, ends can readily fuse or unite with broken ends of other chromosome.

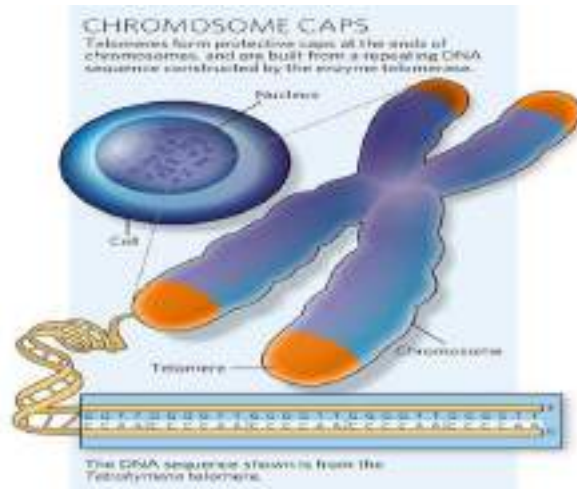

Telomeres are like the strings Ends of broken sticky, whereas the sticky, suggesting the chromosomes have

ends of shoes chromosomes are normal end is not ends of unique features.

Telomeres have been isolated and characterized from several species.

- 
- 
- 
- 
- 
- 
- 
- 
- 
- 
- 

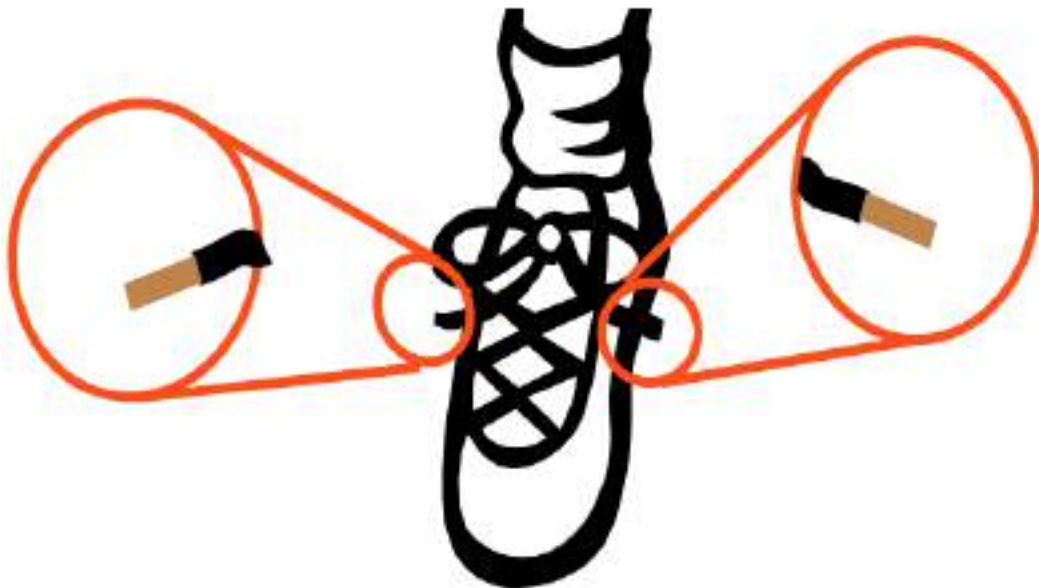

Species	Repeat Sequence
• <i>Arabidopsis</i>	TTTAGGG

- Human TTAGGG
- *Oxytricha* TTTTGGGG
- Slime Mold TAGGG
- *Tetrahymena* TTGGGG
- Trypanosome TAGGG

**Process of Telomere replication** The telomeres of this organism end in the sequence 5'-TTGGGG-3'. The telomerase adds a series of 5'-TTGGGG-3' repeats to the ends of the lagging strand. Finally, the hairpin is removed at the 5'-TTGGGG-3' repeat. Thus the end of the chromosome is faithfully replicated.

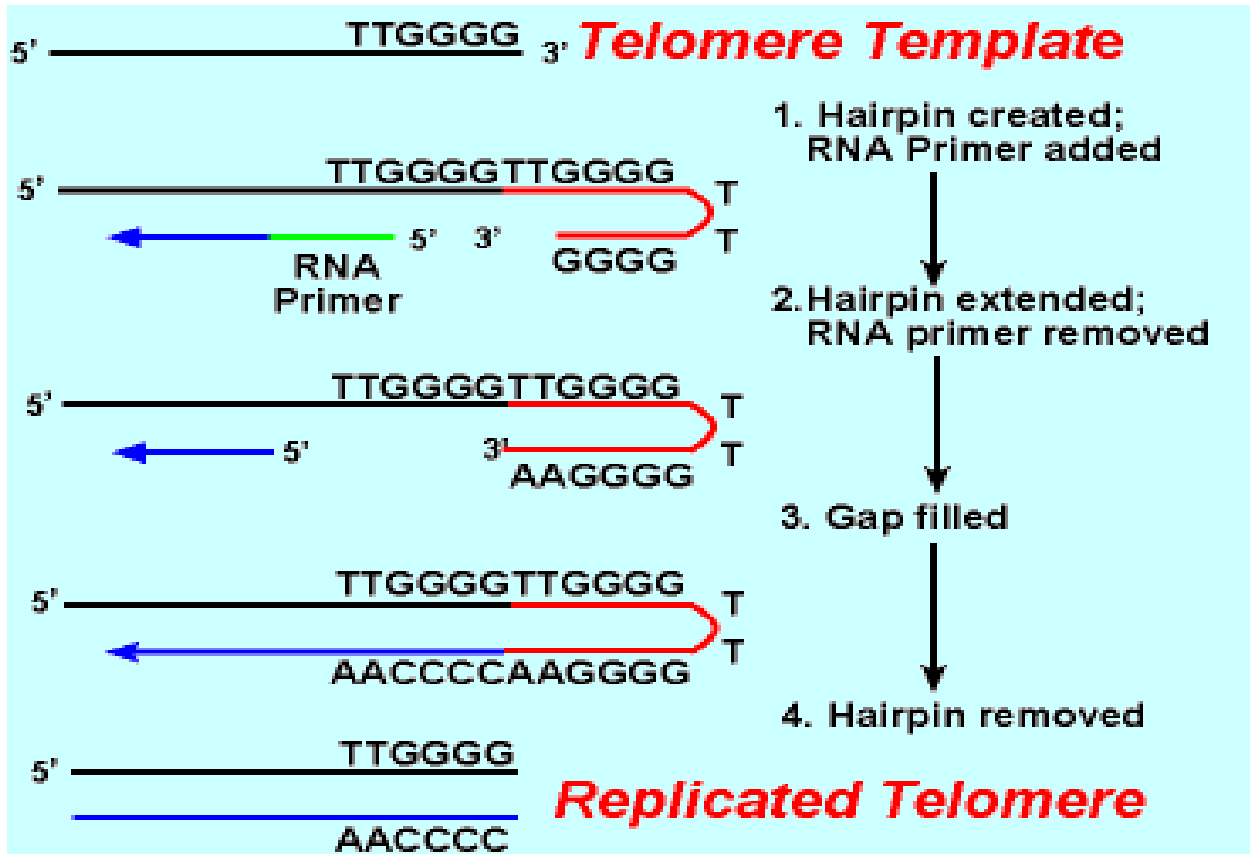

RNA Primer - Short stretches of ribonucleotides (RNA substrates) found on the lagging strand during DNA replication. Helps initiate lagging strand replication .

## Lesson 33

**Euchromatin and Heterochromatin:** Chromosomes may be identified by regions that stain in a particular manner when treated with various chemicals. Several different chemical techniques are used to identify certain chromosomal regions by staining. Darker bands are generally found near the centromere or on the ends (telomeres) of the chromosome. The position of the dark-staining is heterochromatic region or heterochromatin. Light staining regions are Euchromatin region or Euchromatin.

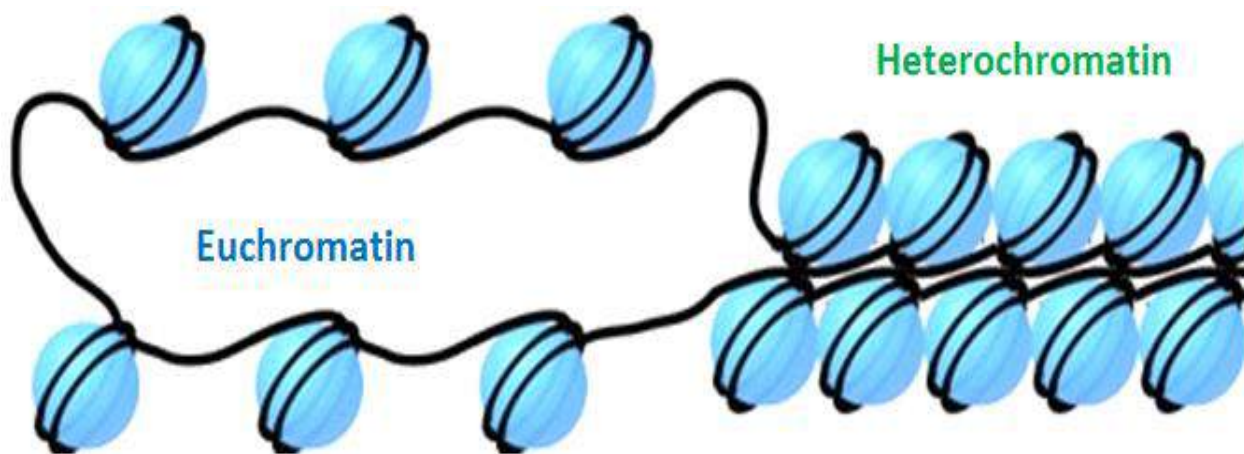

**Heterochromatin** Heterochromatin is classified into two groups:

- Constitutive
- Facultative

Constitutive heterochromatin remains permanently in the heterochromatic stage. It does not revert to the Euchromatin stage. Facultative heterochromatin consists of Euchromatin that takes on the staining and compactness characteristics of heterochromatin during some phase of development.

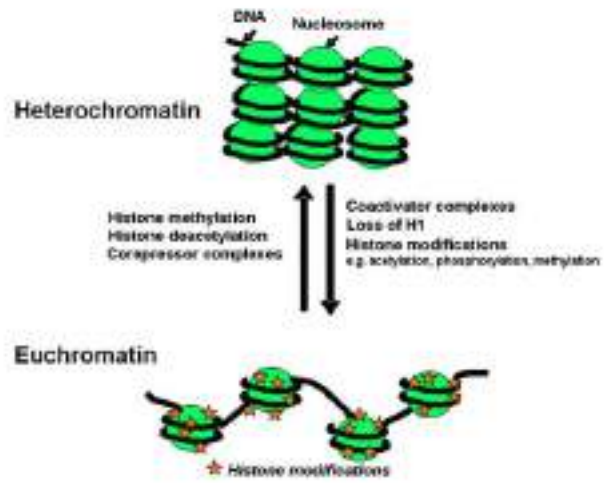

## Lesson 34

### Staining and banding chromosomes

#### Staining procedures

- Staining procedures have been developed in the past two decades and these techniques help to study the karyotype in plants and animals.

#### Feulgen staining

- Cells are subjected to a mild hydrolysis in 1N HCl at 60 °C for 10 minutes.
- This treatment produces a free aldehyde group in deoxyribose molecules.

#### Q Banding

- Q bands are the fluorescent bands observed after quinacrine mustard staining with UV light.
- The distal ends not stained by this technique.

#### R Banding

- The R bands (reverse) are those located in the zones that do not fluoresce with the quinacrine mustard, that is they are between the Q bands and can be visualized as green.

#### C Banding

- The C bands correspond to constitutive heterochromatin.

The heterochromatin regions in a chromosome distinctly differ in their stainability from euchromatic region

## Human chromosome banding patterns

- Human body cells contain 46 chromosomes in 23 pairs – one of each pair inherited from each parent.

Q-banding	Quinacrine	Chromosome arms; mostly repetitive AT-rich DNA	Under UV light, distinct fluorescent banded pattern for each chromosome.
G-banding	Giemsa	Chromosome arms; mostly repetitive AT-rich DNA	Distinct banded pattern for each chromosome; same as Q-banding pattern except single additional band near centromere of chromosomes 1 and 16
R-banding	Variety of techniques	Chromosome arms; mostly unique GC-rich DNA	Reverse banding pattern of that observed with Q- or G-banding
C-banding	Variety of techniques	Centromere region of each chromosome and distal portion of Y chromosome; highly repetitive, mostly AT-rich DNA	Largest bands usually on chromosomes 1, 9, 16, and Y; chromosomes 7, 10, and 15 have medium-sized bands; size of C-bands highly variable from person to person

## Lesson 35

### Nucleosomes

- The nucleosome is composed of a core of eight histone proteins and DNA (147 bp) wrapped around them.
- The DNA between nucleosome ...linker DNA.
- Linker DNA 20-60 bp.

### NUCLEOSOME ASSEMBLY

- Nucleosomes are assembled immediately after DNA replication.
- Two molecules each of four types of histones are packed by DNA to form a Nucleosomes.

### Histones

Histones are small, positively charged (basic) proteins

### Nucleosomes- Five histones

- Five abundant histones are H1, H2A, H2B, H3 and H4.
- The core histones share a common structural fold, called histone-fold domain.

### Nucleosomes- Five histones

- Five abundant histones are H1, H2A, H2B, H3 and H4.
- The core histones share a common structural fold, called histone-fold domain.

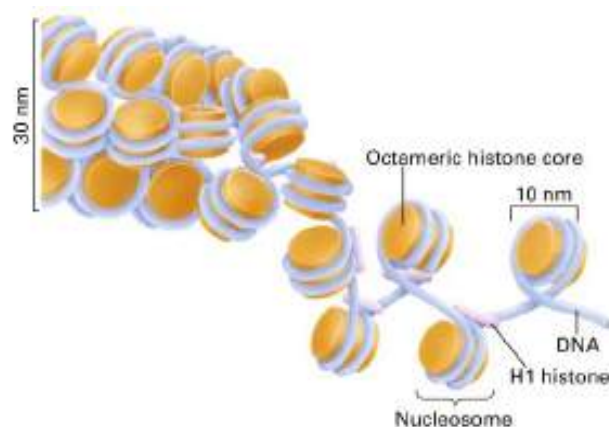



## Lesson 36

### Chromatin and chromosomes

#### chromatin

- The complexes between eukaryotic DNA and proteins are called chromatin.
- The major proteins of chromatin are the histones – small proteins containing a high proportion of basic amino acids arginine and lysine.
- **chromatin**
- There are 5 major types of histones: H1, H2A, H2B, H3, and H4 – which are very similar among different sp of eukaryotes.
- The histones are extremely abundant proteins in eukaryotic cells.
- **Molecular weight and number of amino acids**

Histone	Mol. Wt	No. of Amino acid	Percentage Lys + Arg
H1	22,500	244	30.8
H2A	13,960	129	20.2
H2B	13,774	125	22.4
H3	15,273	135	22.9
• H4	11,236	102	24.5

- **Histones - size and molecular weight**

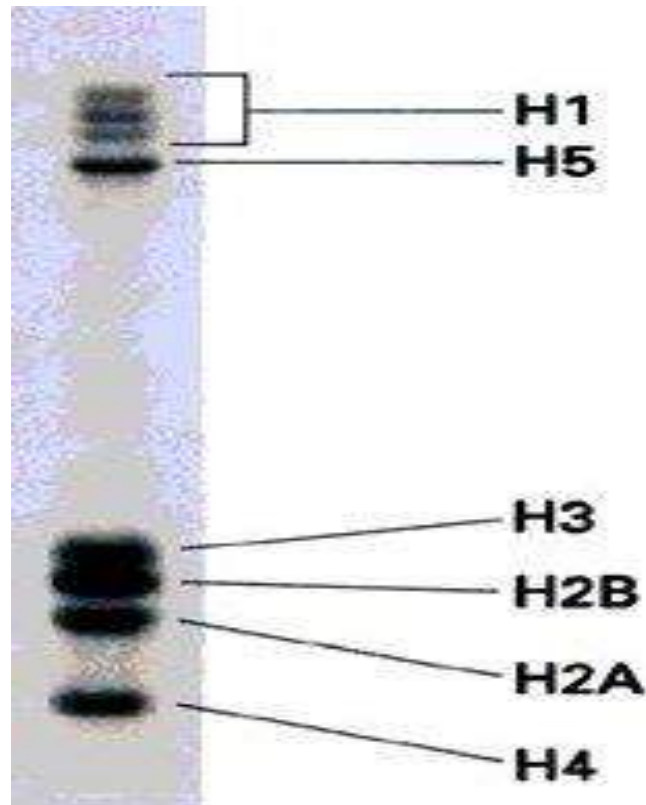

- 
- **Non-histones**
- Chromatin contains an approximately equal mass of a variety of nonhistone proteins.
- More than a thousand different types of proteins, which are involved in a DNA replication and gene expression.
- The DNA of prokaryotes is similarly associated with proteins, some of which presumably function as histones do, packing DNA within the bacterial cell.

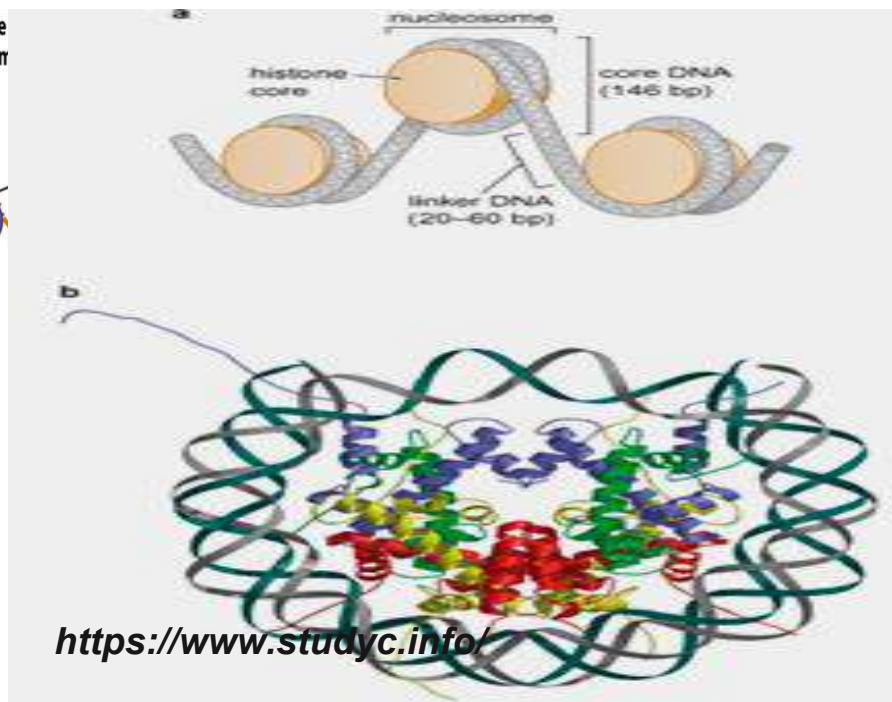
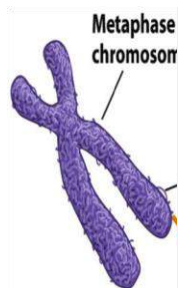

### **Chromosomes**

- Tightly packaged DNA
- Found only during cell division
- DNA is not being used for macromolecule synthesis

### **Chromatin**

- Unwound DNA
- Found throughout Interphase
- DNA *is* being used for macromolecule synthesis

## Lesson 38

### Higher order chromatin folding

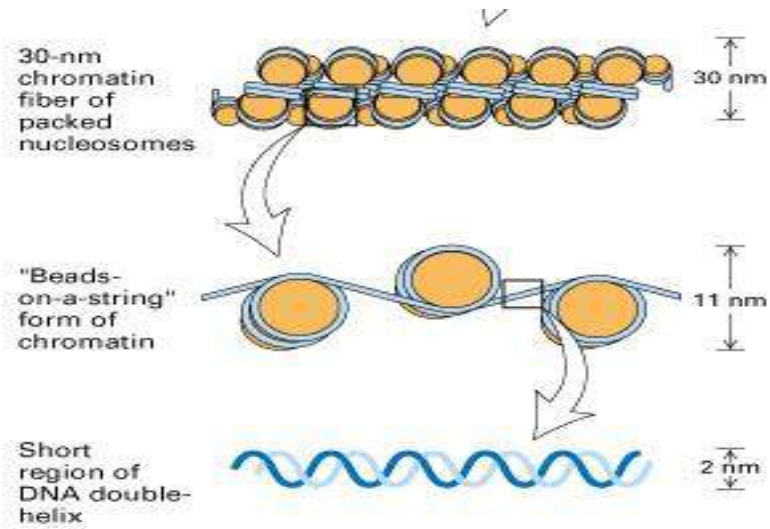

### Nucleosomes and higher order

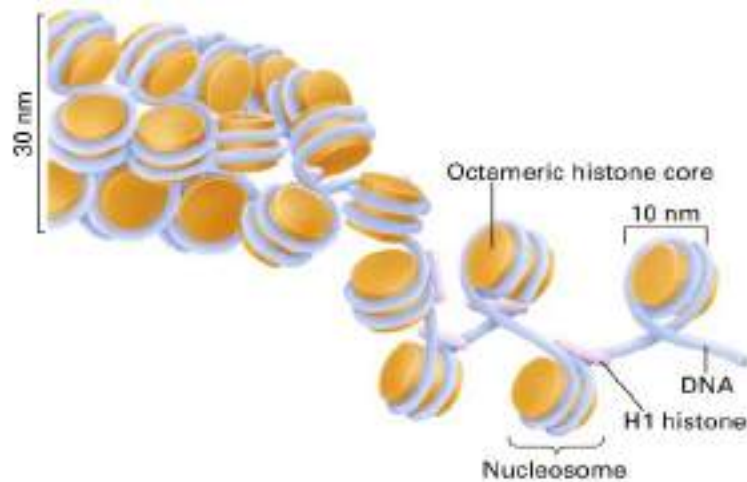

### 30 nm fibre

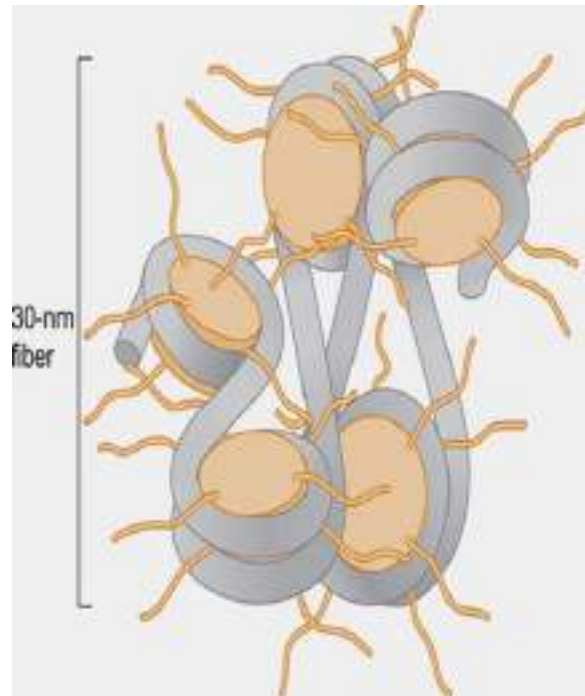

### 300 nm fibre

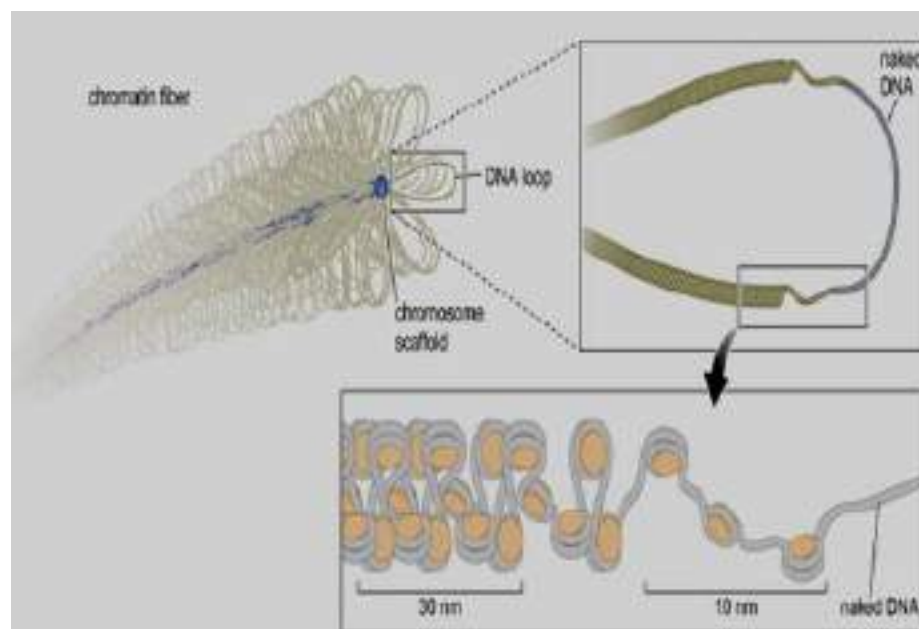

300 nm fibre

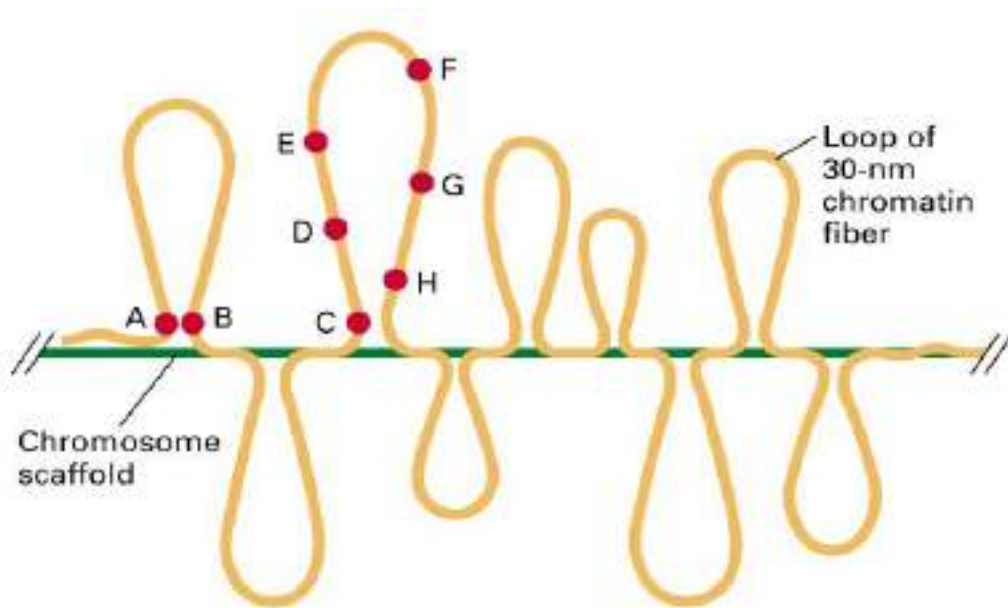

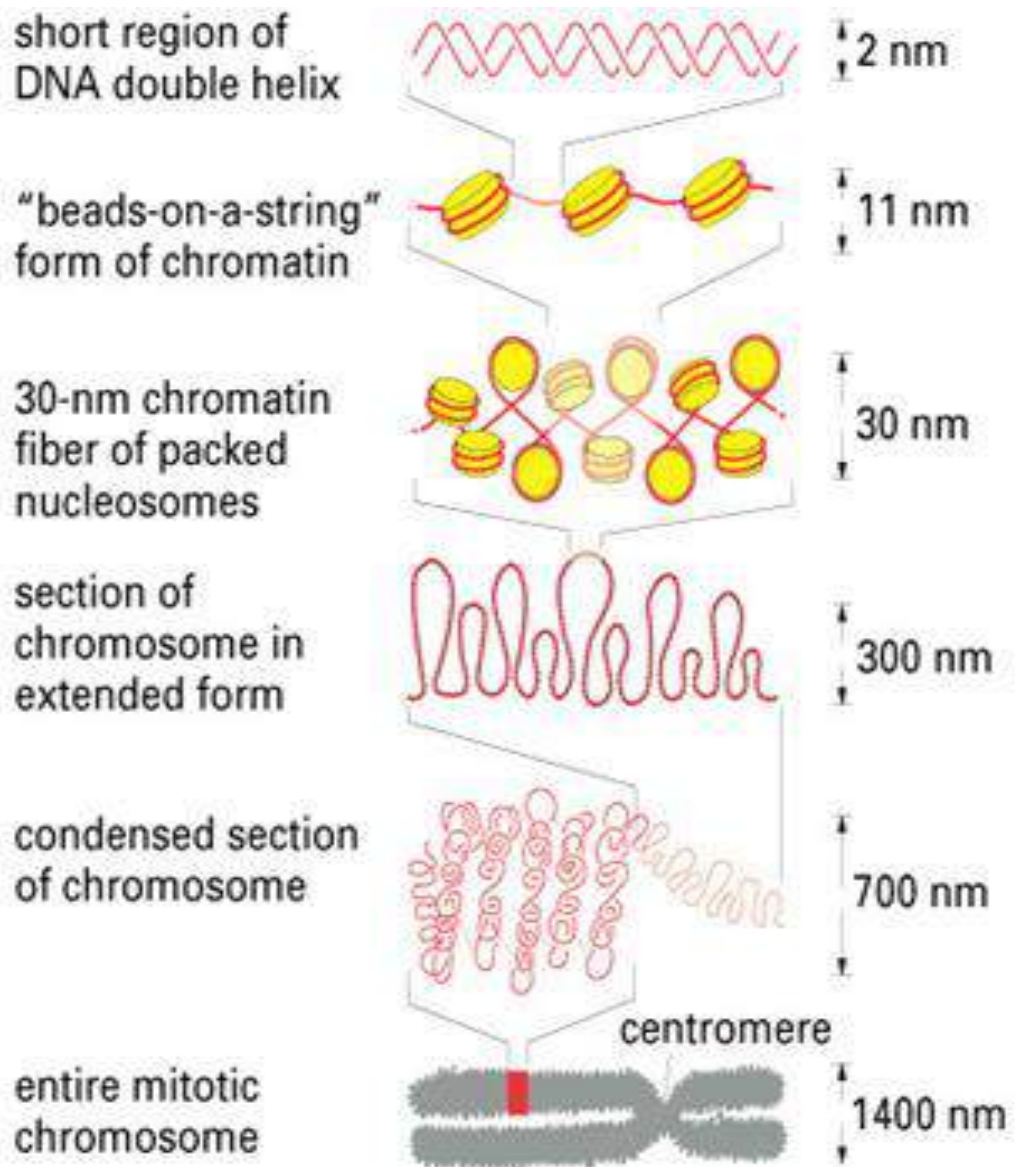

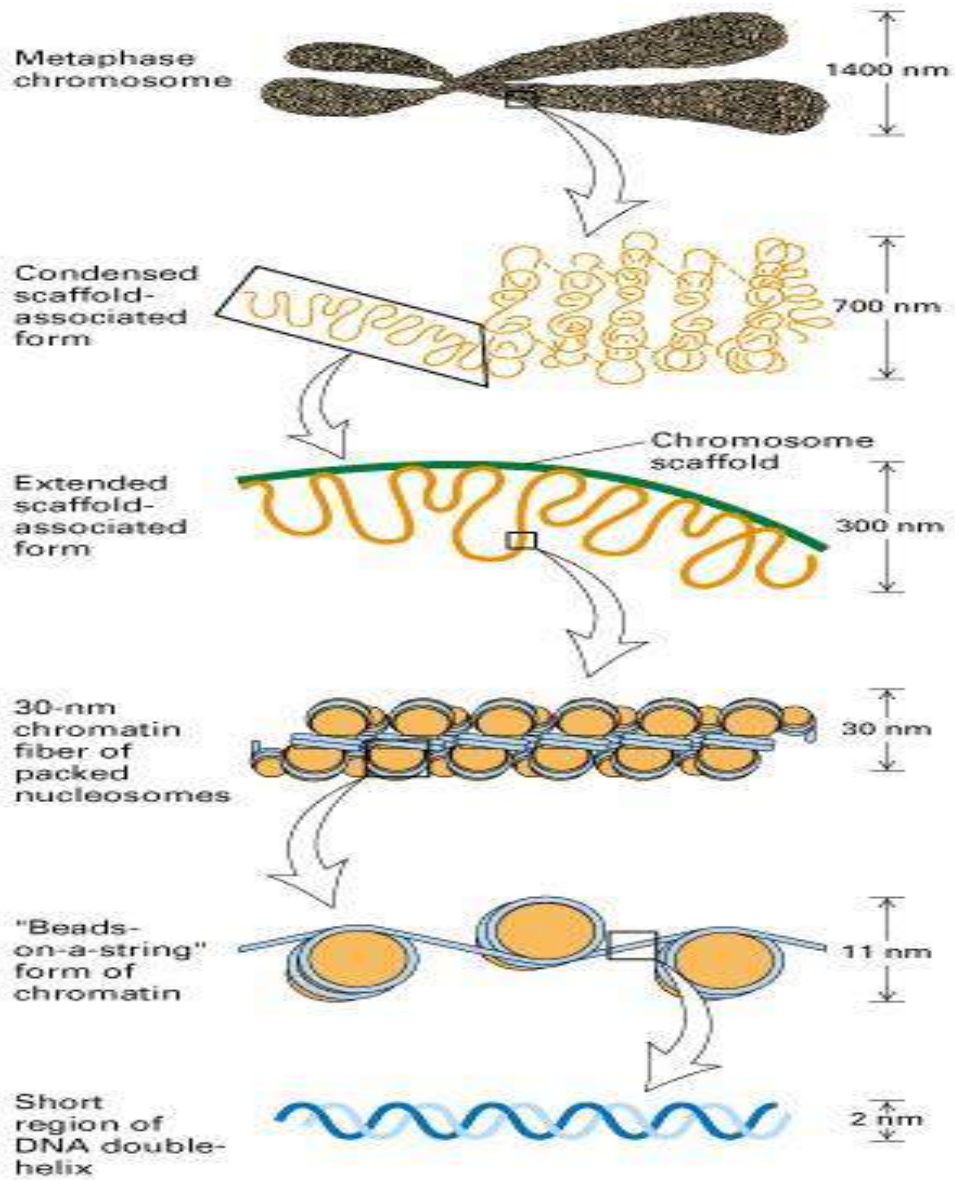



## Lesson 39

### Kinetochores

- Within the centromere region, ...locations where spindle fibers attach which consist of DNA as well as protein.
  - The actual location where the attachment occurs is called the kinetochore and is composed of both DNA and protein.
  - The DNA sequence within these regions is called CEN DNA ..120 base pairs long and consists of sub-domains, CDE-I, CDE-II and CDE-III.
  - Mutations in the first two sub-domains have no effect upon segregation.
  - But a point mutation in the CDE-III sub-domain completely eliminates the ability of the centromere to function during chromosome segregation.

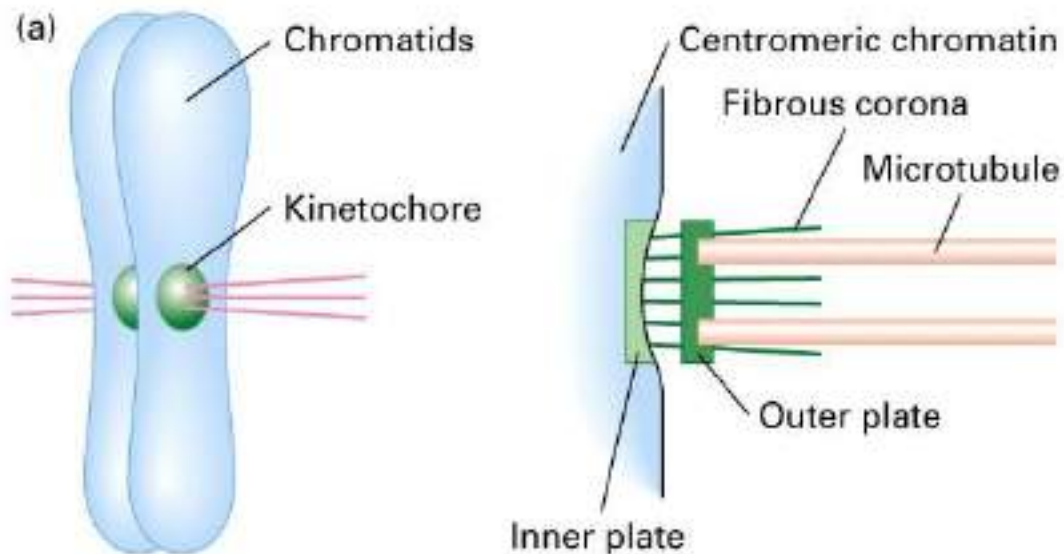

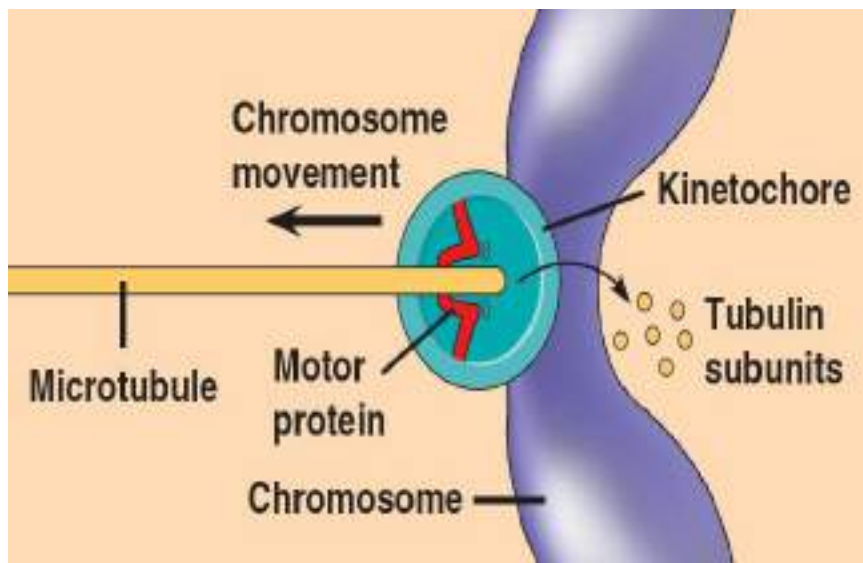
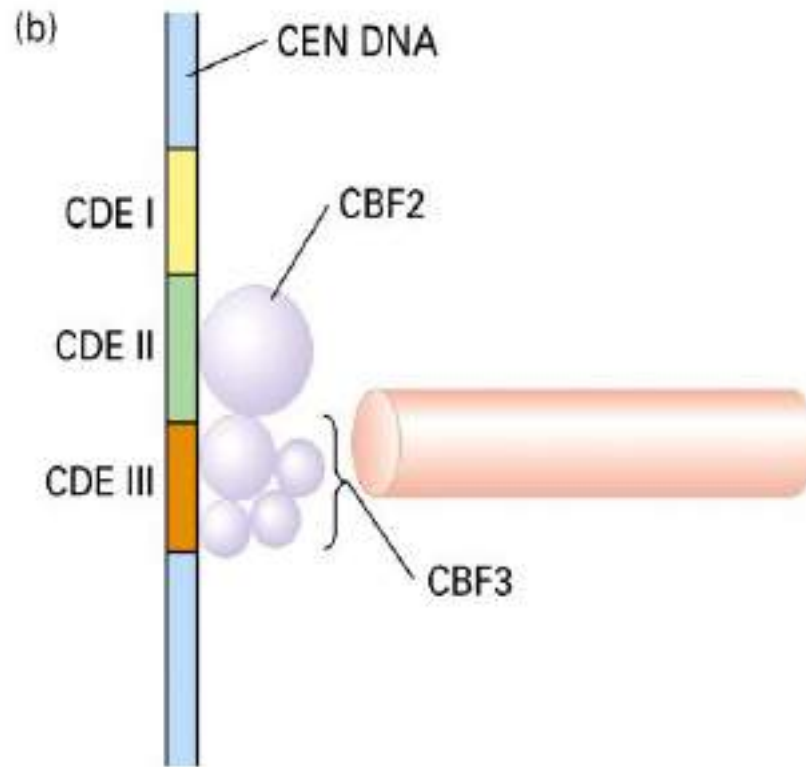

## Lesson 40

### Karyotyping

#### IDENTIFYING CHROMSOMES

- Chromosomes identified by:
- Their size
- Their shape (the position of the centromere)
- Banding patterns produced by specific stains (Giemsa)
- Chromosomes are analyzed by organizing them into a karyotype.
- Karyotype is the general morphology of the somatic chromosome.
- Generally, karyotypes represent by arranging in the descending order of size keeping their centromere in a straight line.

#### IDIOTYPE

- Idiotypic: the karyotype of a species may be represented diagrammatically, showing all the morphological features of the chromosome; such a diagram is known as Idiotypic.

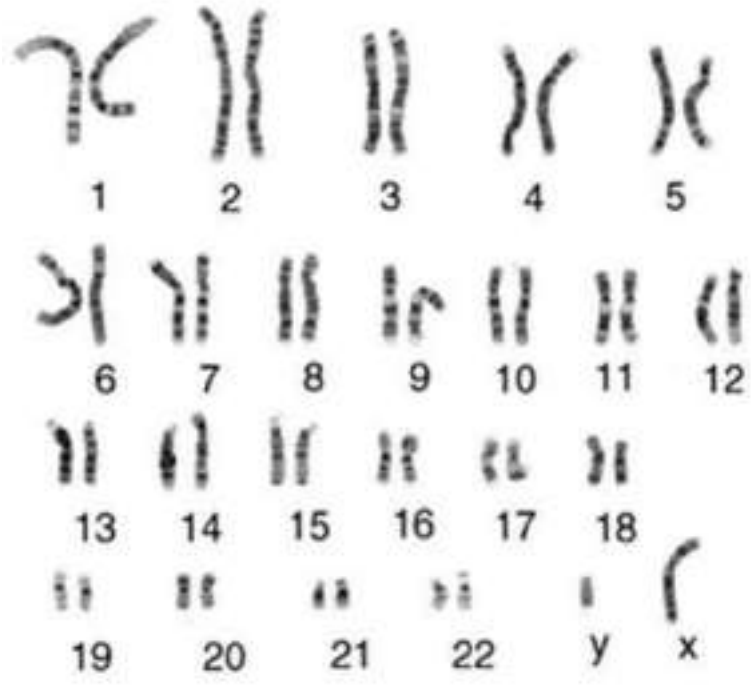
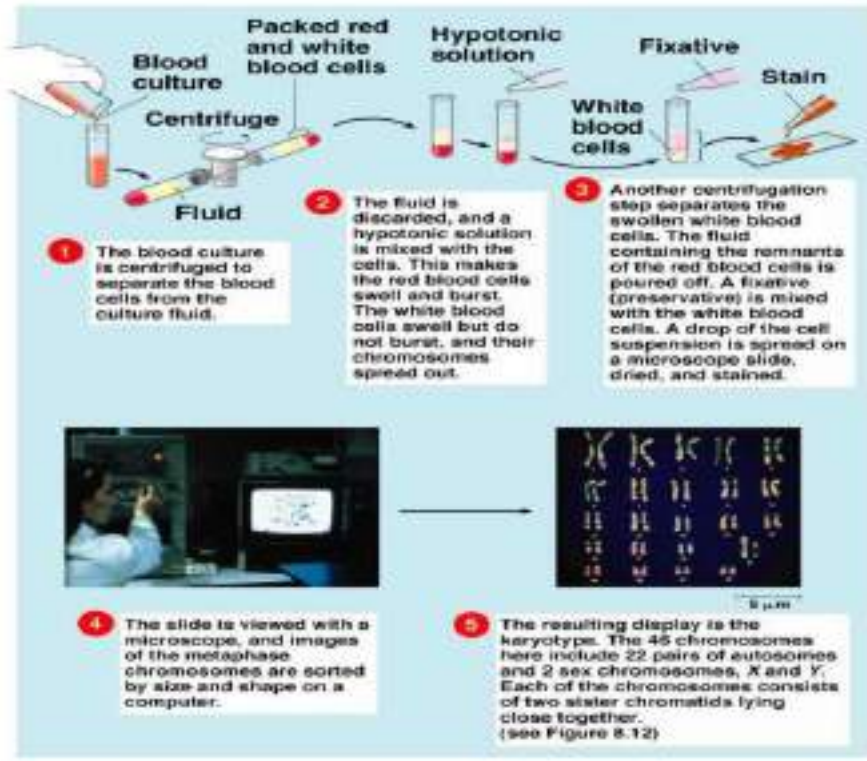

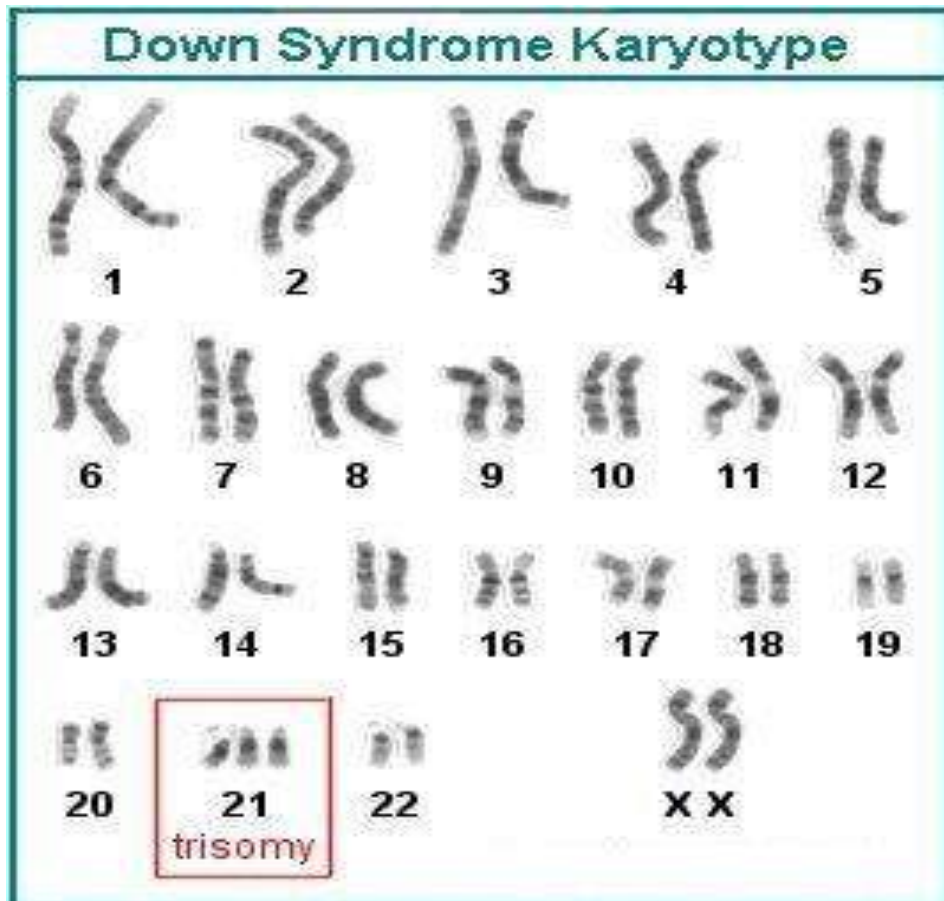
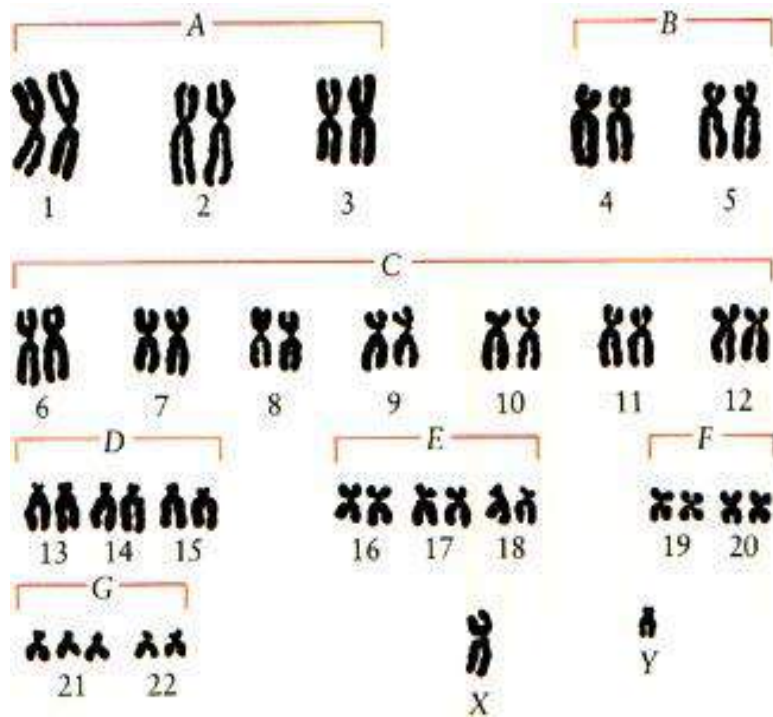

## Lesson 41

### Prokaryotic Chromosomes

- The prokaryotes usually have only one chromosome, and it bears little morphological resemblance to eukaryotic chromosomes.
- The genome length is smallest in RNA viruses.
- The number of gene may be as high as 150 in some larger bacteriophage genome.
- In E.coli, about 3000 to 4000 genes are organized into its one circular chromosome.
- The chromosome exists as a highly folded and coiled structure dispersed throughout the cell.
- There are about 50 loops in the chromosome of E. coli.
- These loops are highly twisted or supercoiled structure with about four million nucleotide pairs.
- During replication of DNA, the coiling must be relaxed.
- DNA gyrase is necessary for the unwinding the coils.

### Bacterial Chromosome

- Single, circular DNA molecule located in the nucleoid region of cell.

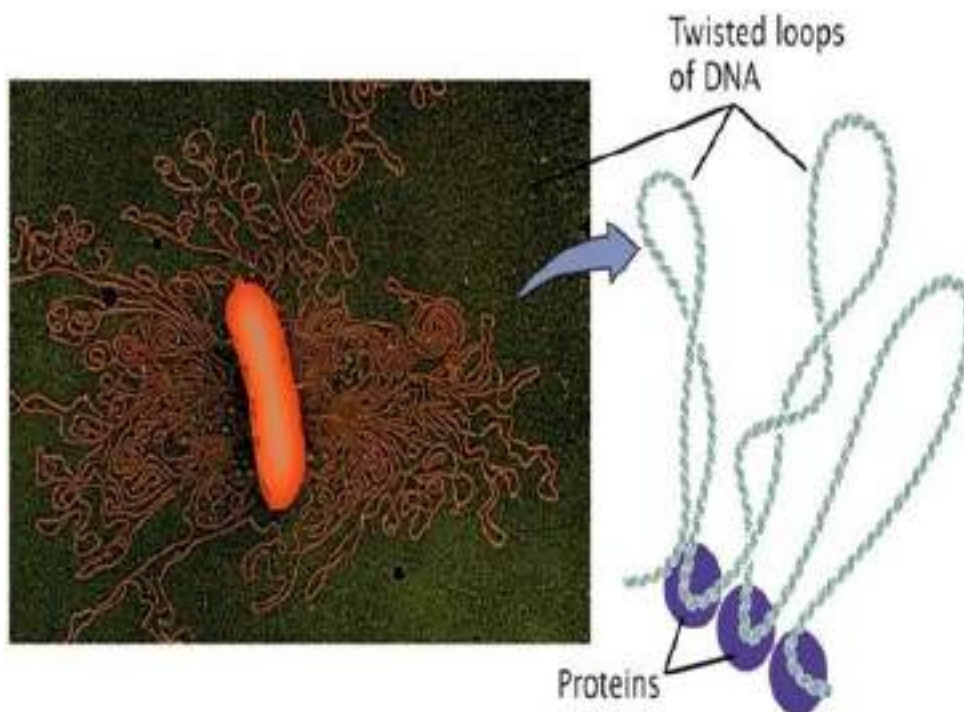



## Mechanism of folding of bacterial CHROMOSOME

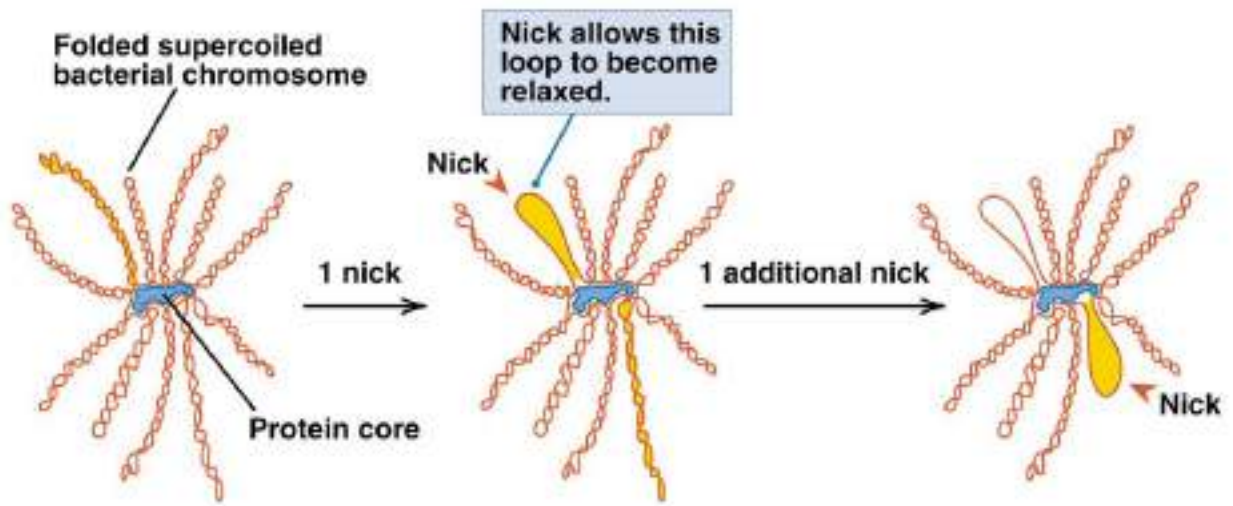



## Lesson 42

### Sex chromosomes and sex determination

#### Sex Chromosomes

- Sex of many animals is determined by genes on chromosomes called sex chromosomes.
  - Sex can be homogametic
  - Sex can be heterogametic
- 
- **Sex determination in different animals**

<b>HOMOGAMETIC SEX</b>	<b>HETEROGAMETIC SEX</b>	<b>SEX DETERMINATION</b>
Female <b>XX</b>	Male <b>XY</b>	Presence of Y-chromosome = maleness (mammals and fish) Presence of second X-chromosome = femaleness (Drosophila, the fruit fly)
Male <b>ZZ</b>	Female <b>ZW</b>	Birds, amphibians, reptiles, butterflies, moths.
Female <b>XX</b>	Male <b>Xo</b>	Grasshoppers

Inheritance of gender in humans

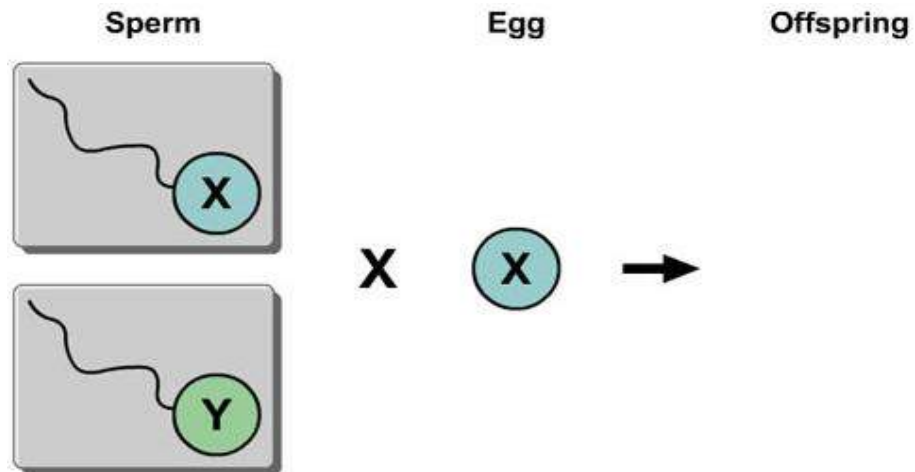
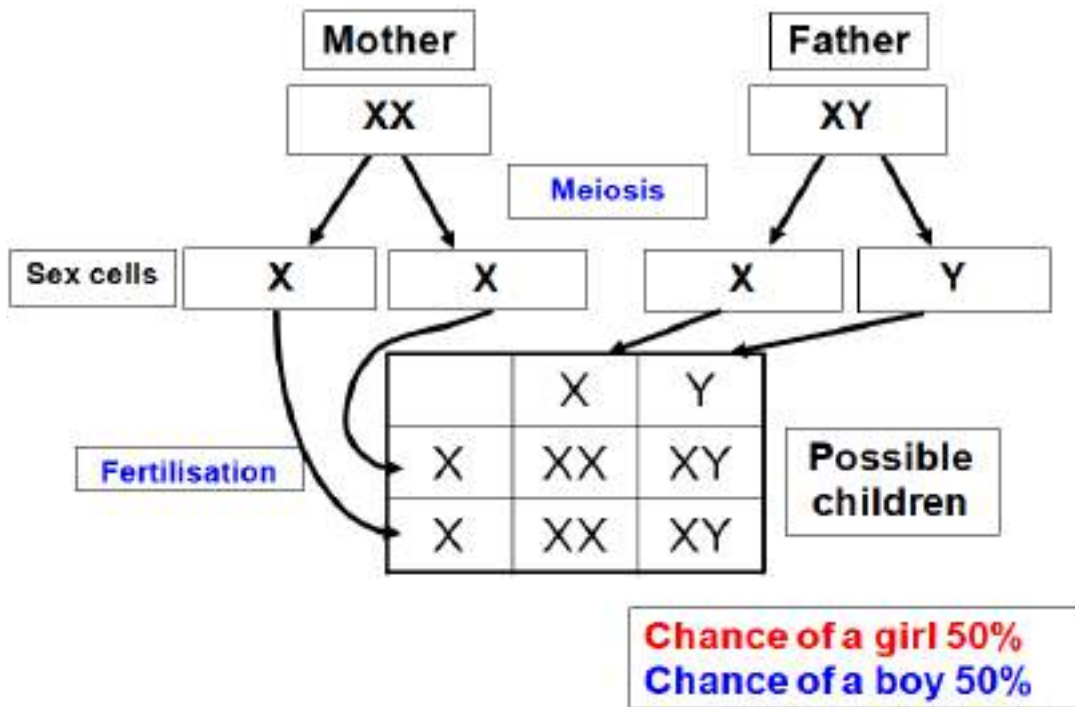

## Sex system in birds

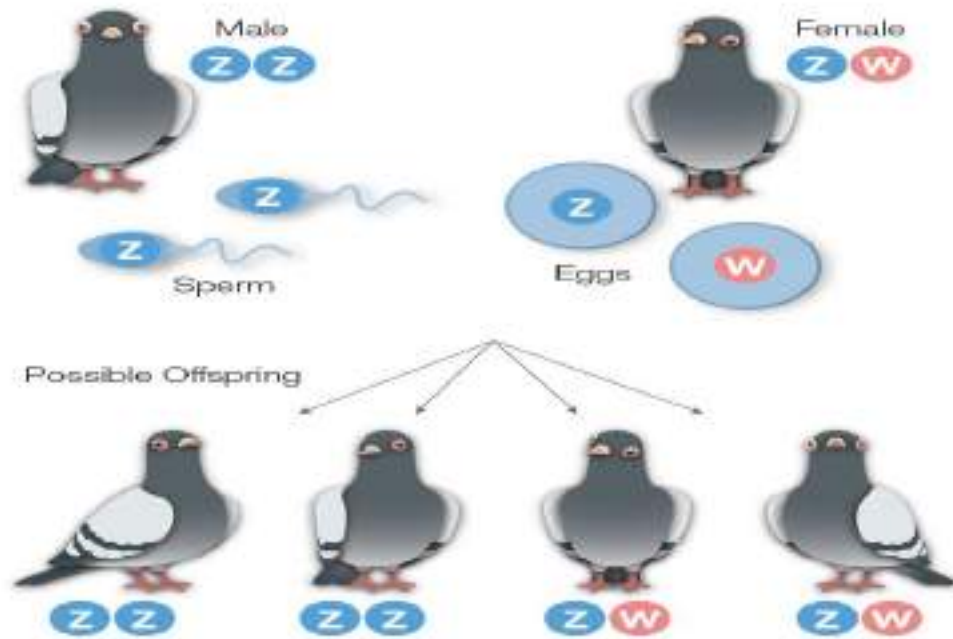

## Xo system in grasshopper

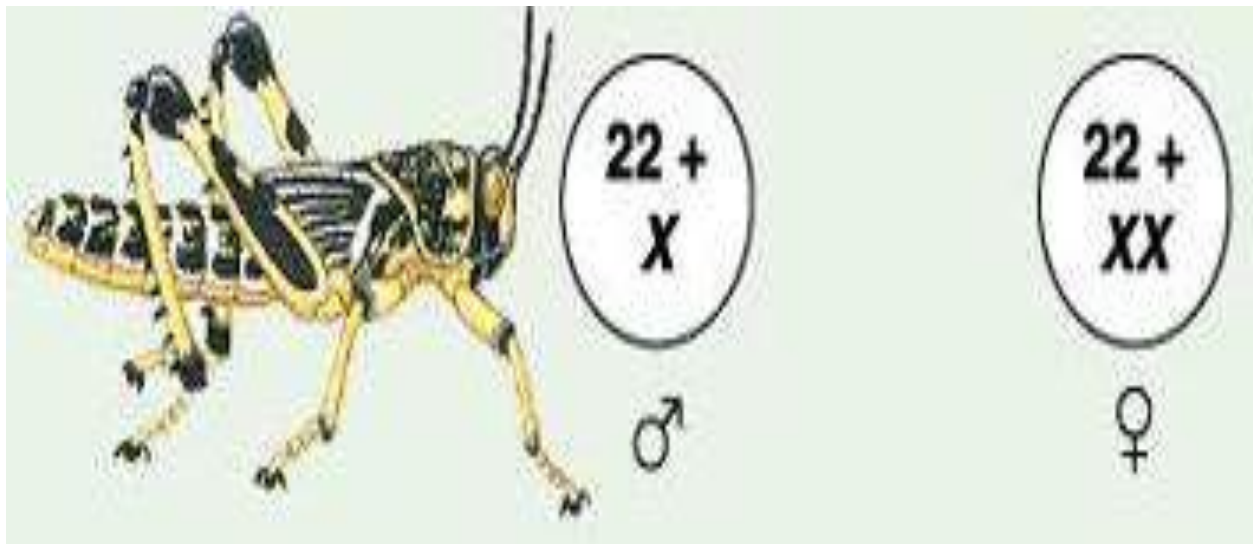

## Lesson 43

### Salient features of DNA

- Watson: X-rays diffraction pattern projected by DNA.
- Erwin Chargaff demonstrated ratio of A:T are 1:1, and G:C are 1:1
- Chemical structure of nucleotide identified.
- Composed of 2 polymers of nucleotides.
- Run antiparallel.
- Molecule structure resembles a spiral staircase.
- Complementary base pairing:
  - A-T, C-G
- Genetic information in the linear sequence of nucleotides.
- Genetic information is to synthesize proteins.
- DNA forms double helix with two complimentary strands holding - hydrogen bonds.
- DNA duplication occurs using one strand of parental DNA as template to form complimentary pairs with a new DNA strand.

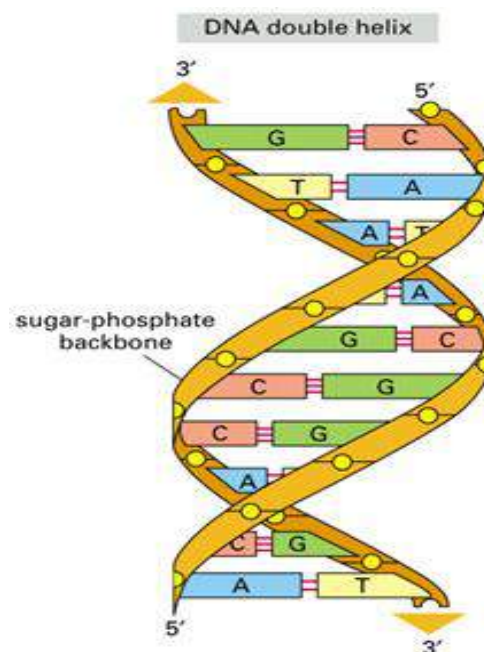

- The structure of Nucleotides includes: A phosphate sugar backbone, with one of the 5 nitrogenous bases (ATCG,U).

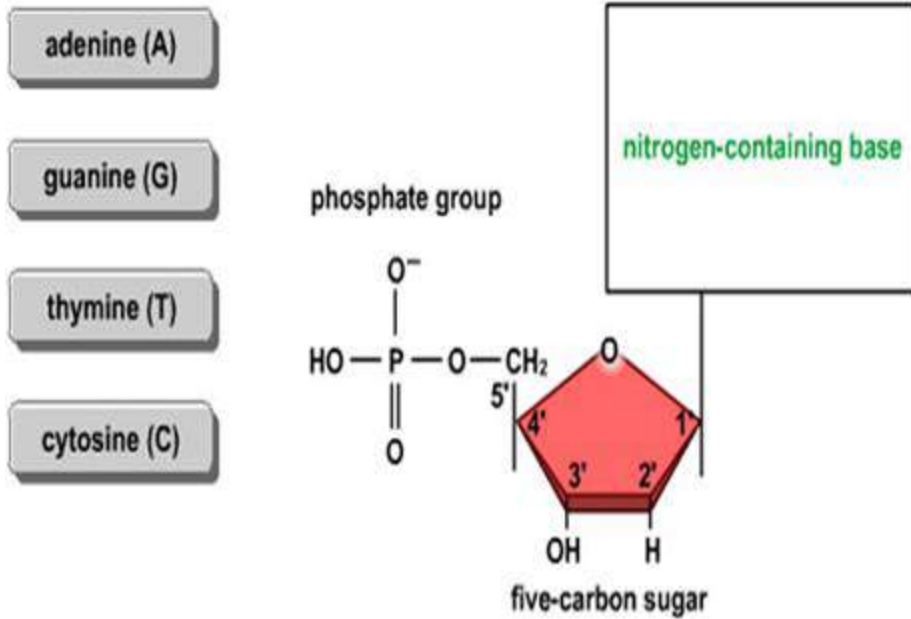

## Lesson 44

### NUCLEOTIDE

Made of three components 5 carbon sugar (pentose) nitrogenous base phosphate group

- Oligonucleotide – short polymer (<10)
- Polynucleotide – long polymer (>10)
- Nucleoside = monomer of sugar + base

### NUCLEOTIDE MONOMER

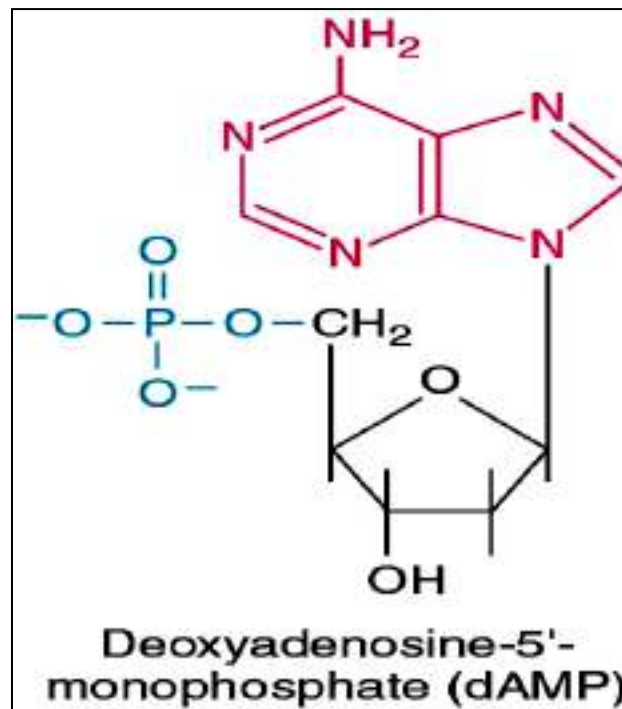

## Sugar molecules

- Two types of sugar molecules

### DNA

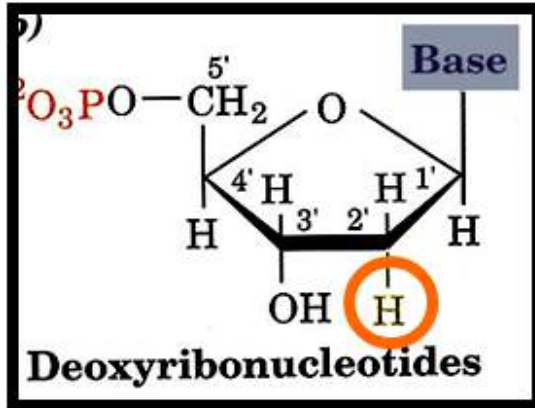

2'-deoxy-D-ribose

### RNA

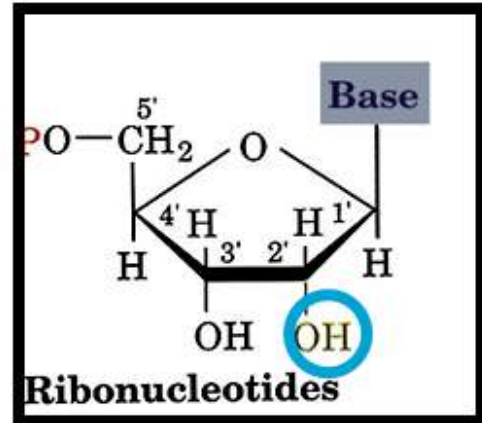

2'-D-ribose

## Nitrogenous Bases pyrimidines

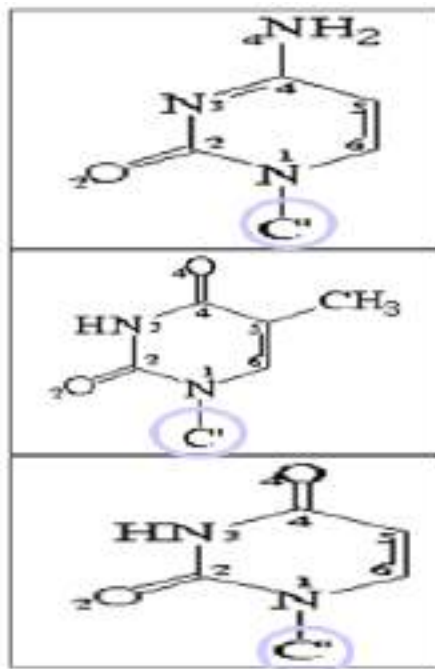

*cytosine*

*thymine*

*uracil*

Nitrogenous bases purines

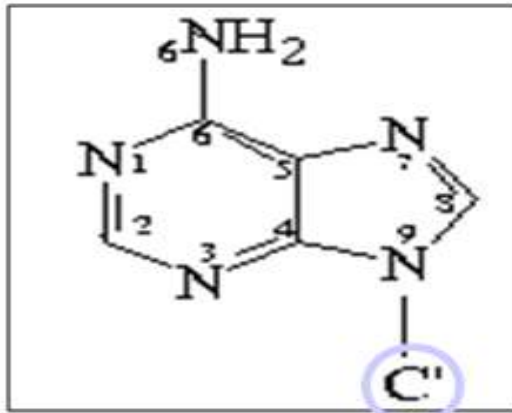

*adenine*

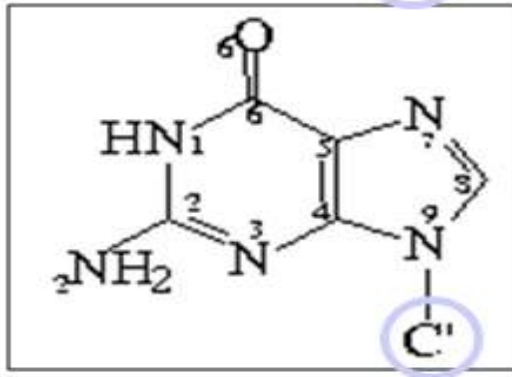

*guanine*

Polynucleotide linkage



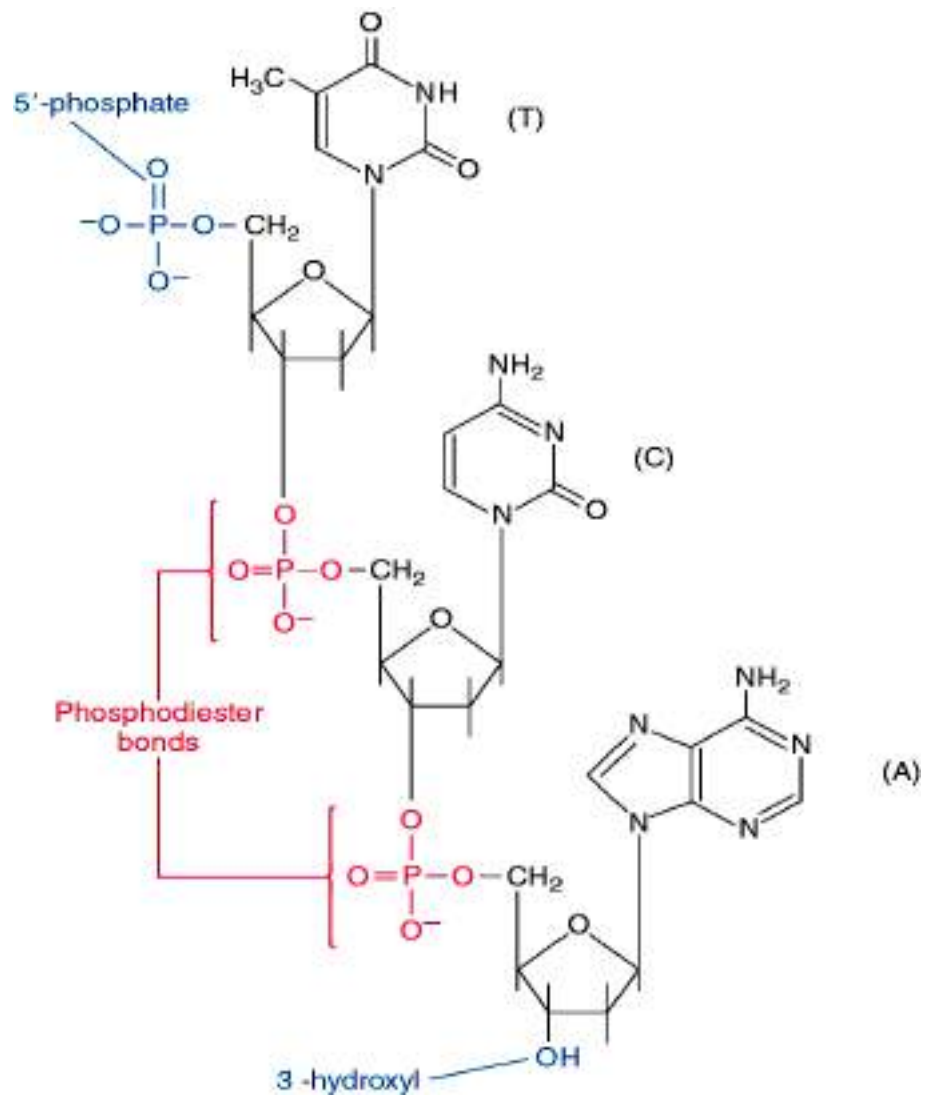

## Pairing of A - T , c - G

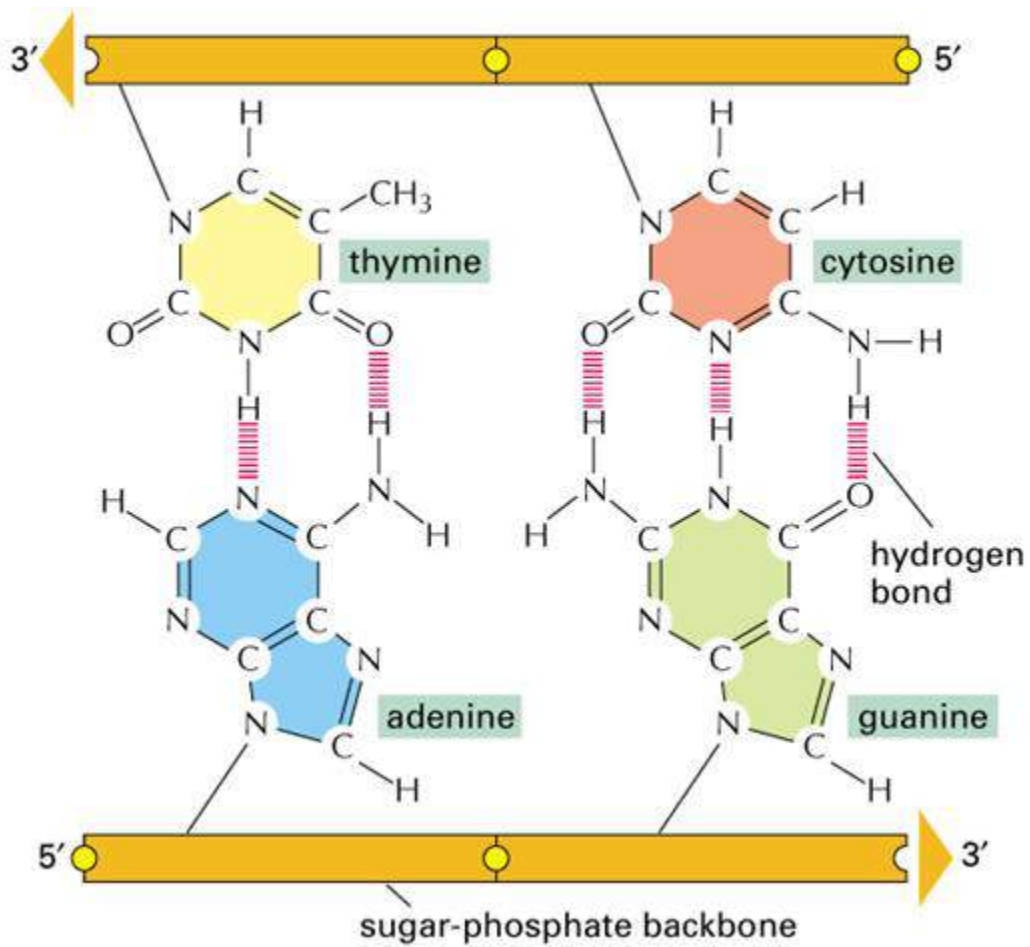

## Lesson 45

### Conformations of DNA

#### B-DNA

- Right-handed helix.
- Intermediate.
- Planes of the base pairs nearly perpendicular to the helix axis
  - Tiny central axis.
  - Wide + deep major groove.
  - Narrow + deep minor groove.

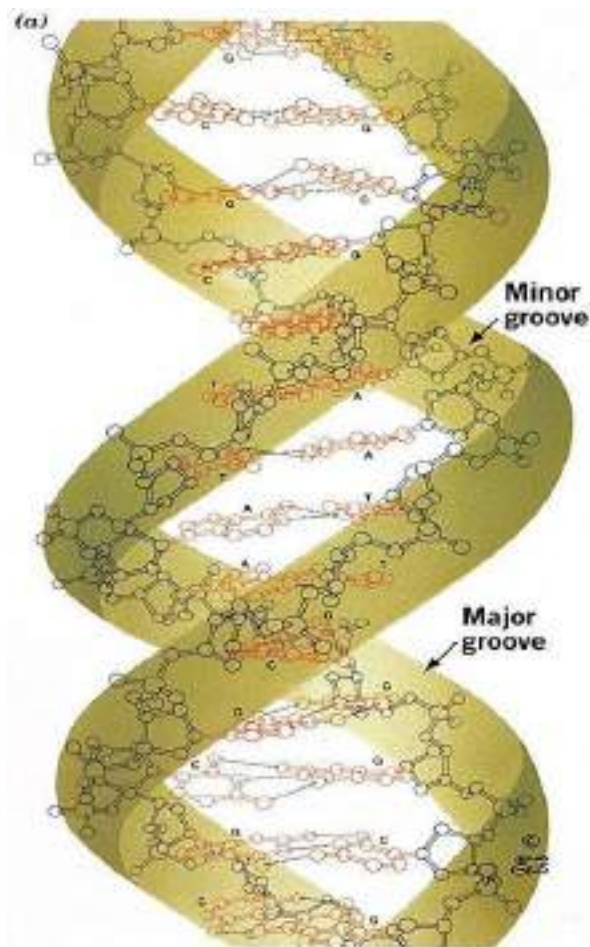

## A-DNA

- Right-handed helix.
- Widest .
- Planes of the base pairs inclined to the helix axis.
  - Narrow + deep major groove.
  - Wide + shallow minor groove.

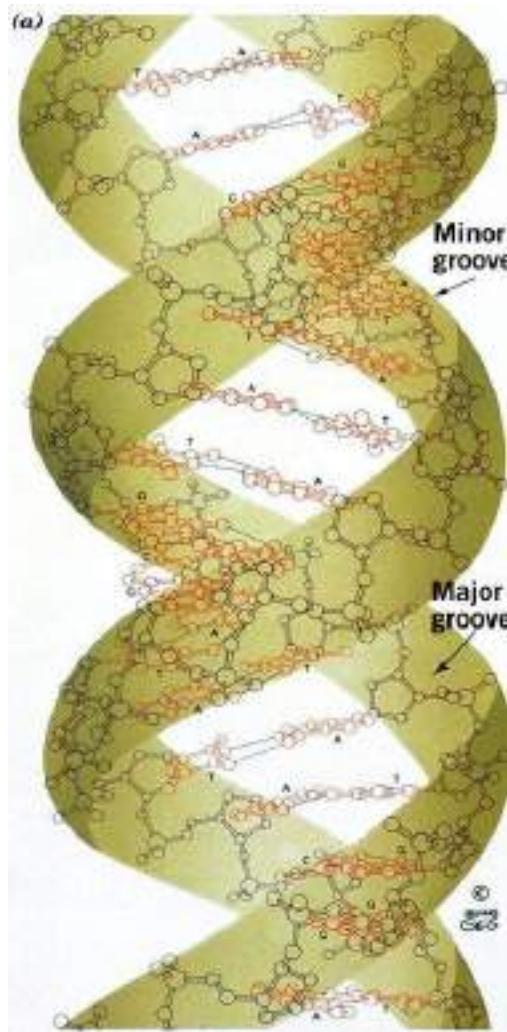

## Z-DNA

- Left-handed helix.
- Narrowest .
- Planes of the base pairs nearly perpendicular to the helix axis.
  - No internal spaces.
  - No major groove.
- Narrow + deep minor groove.

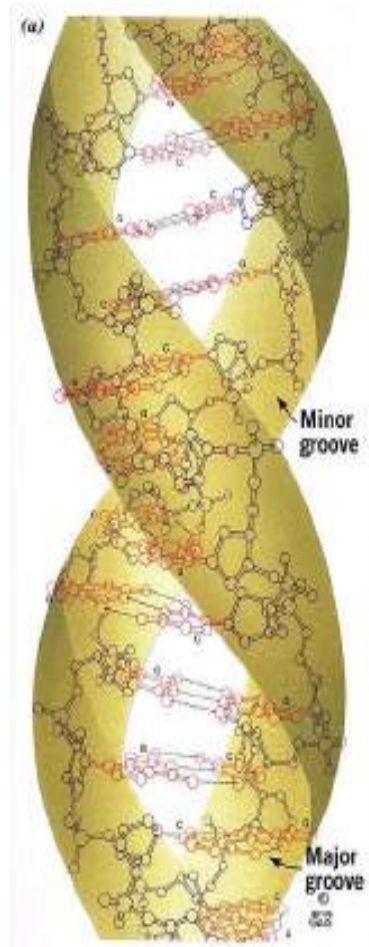

	<b>A-DNA</b>	<b>B-DNA</b>	<b>Z-DNA</b>
<i>Helix</i>	Right-handed	Right-handed	Left-handed
<i>Width</i>	Widest	Intermediate	Narrowest
<i>Planes of bases</i>	planes of the base pairs inclined to the helix axis	planes of the base pairs nearly perpendicular to the helix axis	planes of the base pairs nearly perpendicular to the helix axis
<i>Central axis</i>	6Å hole along helix axis	tiny central axis	no internal spaces
<i>Major groove</i>	Narrow and deep	Wide and deep	No major groove
<i>Minor groove</i>	Wide and shallow	Narrow and deep	Narrow and deep

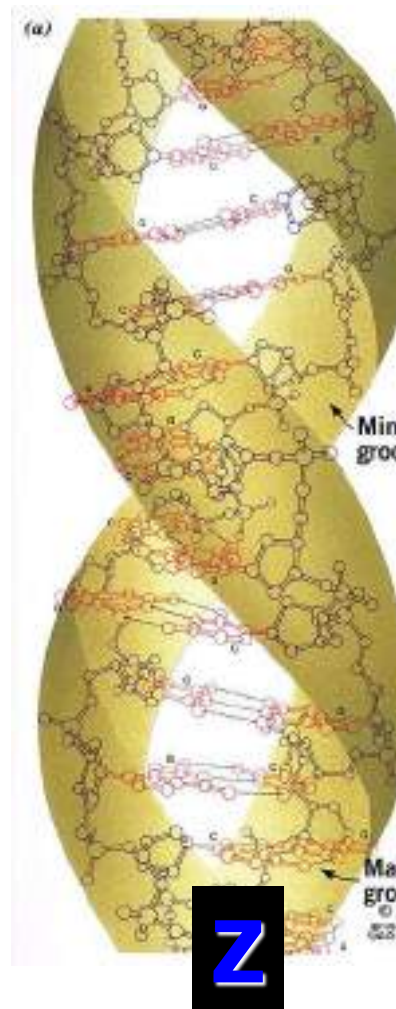
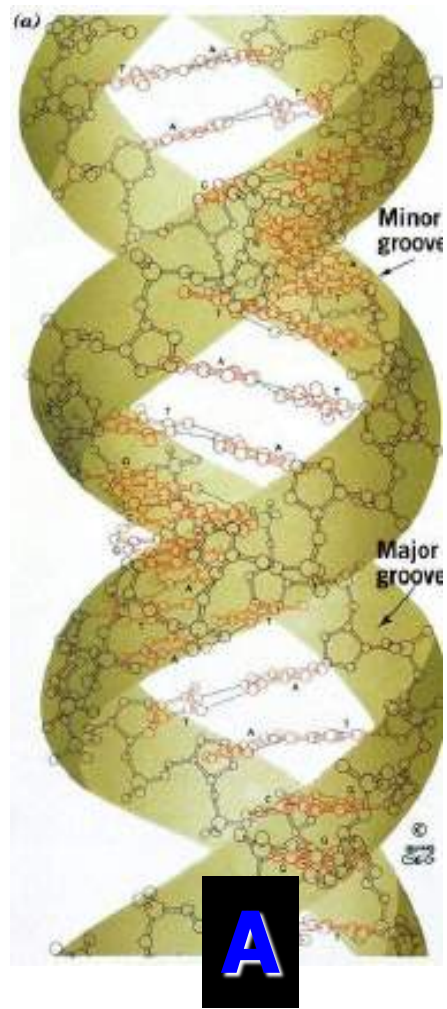
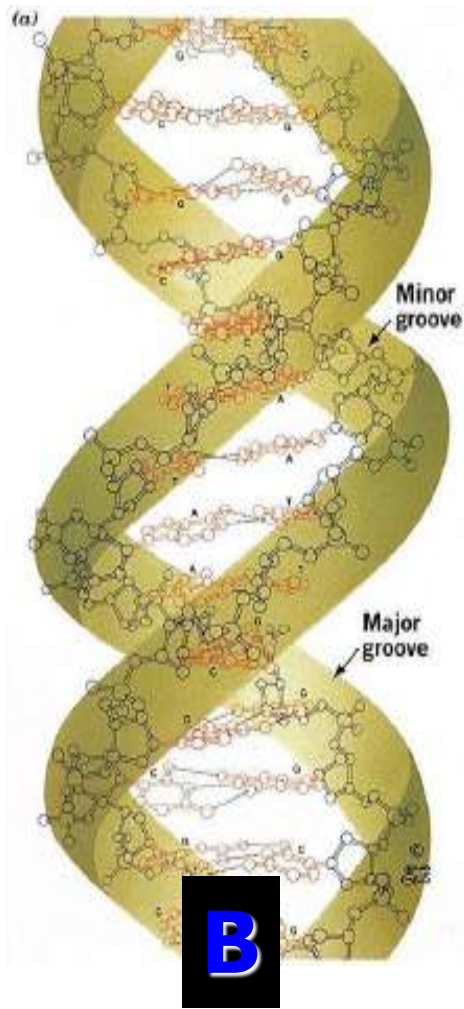

## Lesson 46

### Chargaff rule of base ratios

#### Chargaff

- 1944 - Study of DNA and its four chemical bases - adenine, cytosine, guanine and thymine.
- Discover amounts of adenine and thymine were equal, as were the amounts of cytosine and guanine.

#### Purines

- Consist of a six-membered and a five-membered nitrogen-containing ring, fused together.
- Adenine = 6-amino purine  
Guanine = 2-amino-6-oxy purine .

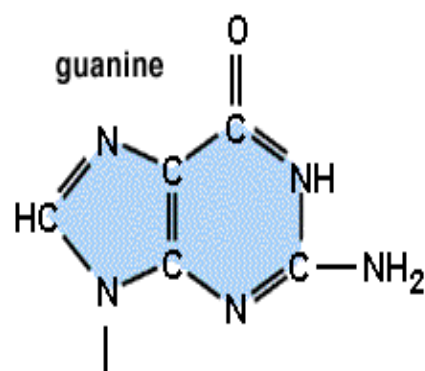
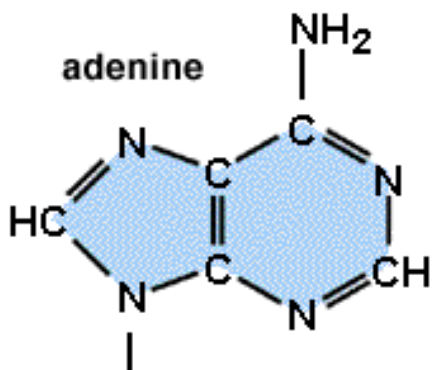



## Pyrimidines

- Have only a six-membered nitrogen-containing ring.
- Uracil = 2,4-dioxy pyrimidine
- Thymine = 2,4-dioxy-5-methyl pyrimidine
- Cytosine = 2-oxy-4-amino pyrimidine

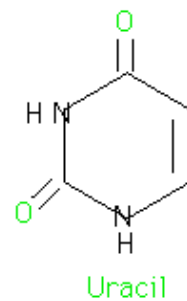
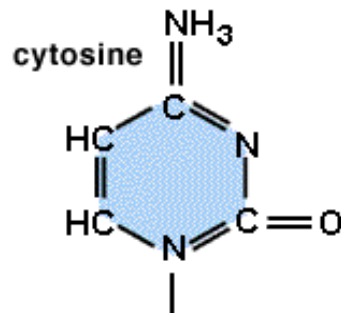
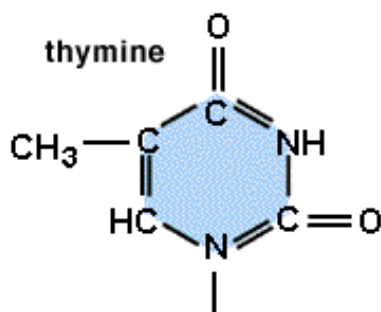

## Chargaff's first parity rule

- Stated that purines pair with pyrimidines, specifically A with T and C with G

## Chargaff's second parity rule

- % of A approximately equals % of T
- % of G approximately equals % of C

### Chargaff's second parity rule

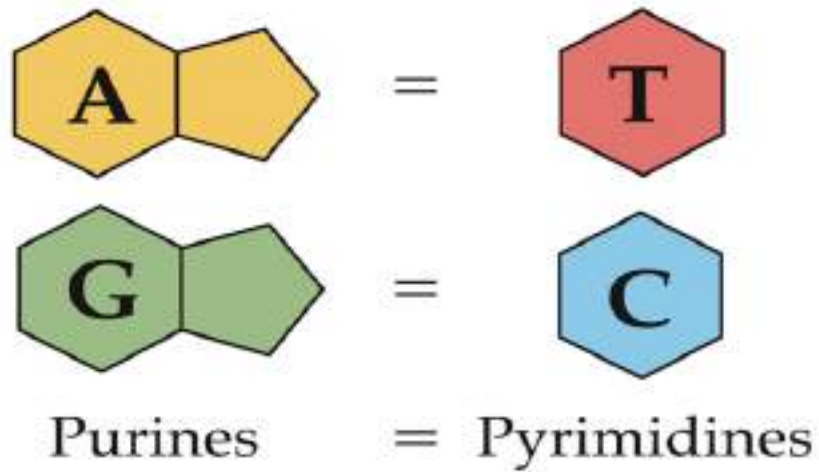

### G-C rule

- Stated that (G+C) % is constant within a species, but often differs between species.

### Cluster rule

- Stated that pyrimidines often occur in clusters, and hence on the complementary strand purines do likewise.

## **Lesson 47**

### **Giant or Polytene chromosome**

#### **Giant chromosome**

- Found in salivary glands of some Diptera.
- These chromosomes are very long and thick.
- Hence they are known as Giant chromosomes.

#### **Giant chromosome**

- They are first discovered by Balbiani in 1881 in dipteran salivary glands and thus also known as salivary gland chromosomes.

#### **Giant chromosome**

- Giant chromosomes have also been discovered in suspensors of young embryos of many plants, but these do not show the bands so typical of salivary gland chromosomes.

#### **Giant chromosome**

- The total length of *D. melanogaster* giant chromosomes is about 2,000 $\mu$ .

#### **Giant chromosome**

- Giant chromosomes are made dark staining regions called “bands”.
- Separated by relatively light or non-staining “interband” regions. In *Drosophila* about 5000 bands can be recognized.

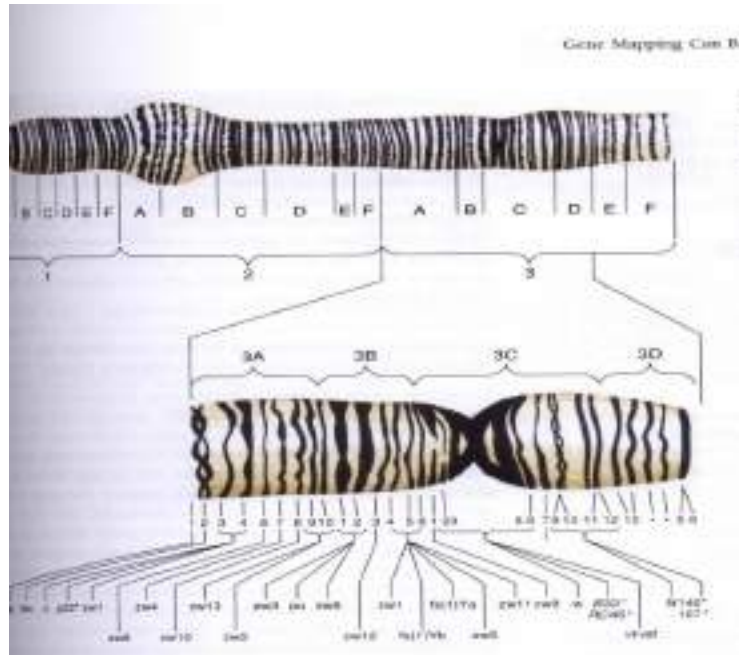

### Giant chromosome

- Some of these bands are as thick as  $0.5\mu$ , while some may be only  $0.05\mu$  thick.
- About 25,000 base-pairs are now estimated for each band.

### Giant chromosome

- These chromosomes are also known as “Polytene chromosome”, and the condition is referred to as “Polytene”

### Giant chromosome

- The numerous strands of these chromosomes are produced due to repeated replication of the paired chromosomes without any nuclear or cell division.

## **Giant chromosome**

- It is estimated that giant chromosomes of *Drosophila* have about 1,024 strands.
- In the case of *Chironomus* may have about 4,096 strands.

## Lesson 48

### Lampbrush Chromosome

#### Lampbrush chromosome

- It was given this name because it is similar in appearance to the brushes used to clean lamp chimneys.
- First observed by Flemming in 1882.

#### Lampbrush chromosome

- These are found in oocytic nuclei of vertebrates (sharks, amphibians, reptiles and birds) as well as in some invertebrates.
- Also found in some plants.

#### Lampbrush chromosome

- One loop represent one chromatid, i.e., one DNA molecule. The size of the loop may be ranging the average of 9.5  $\mu\text{m}$  to about 200  $\mu\text{m}$

#### Lampbrush chromosome

- Each lampbrush chromosome contains a central axial region, where the two chromatids are highly condensed.
- Each chromosome has several chromomeres distributed over its length.

#### Lampbrush chromosome

- One loop represent one chromatid, i.e., one DNA molecule. The size of the loop may be ranging the average of 9.5  $\mu\text{m}$  to about 200  $\mu\text{m}$

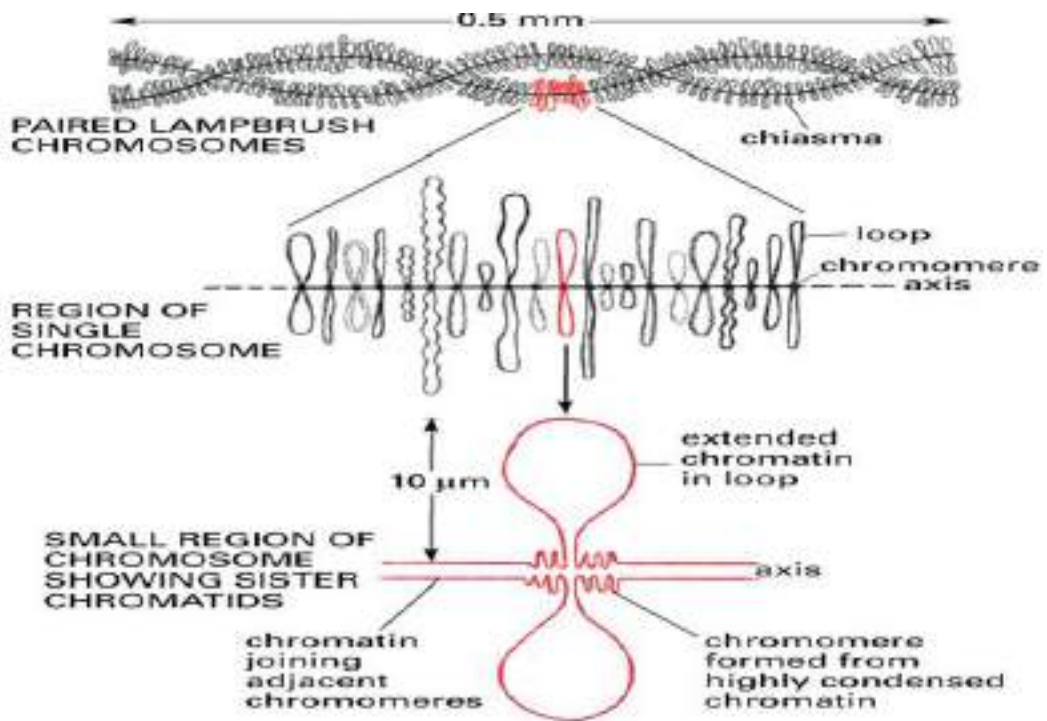

## Lampbrush chromosome

- One end of each loop is thinner (thin end) than the other end (thick end).

**Phase-contrast and fluorescent micrographs**

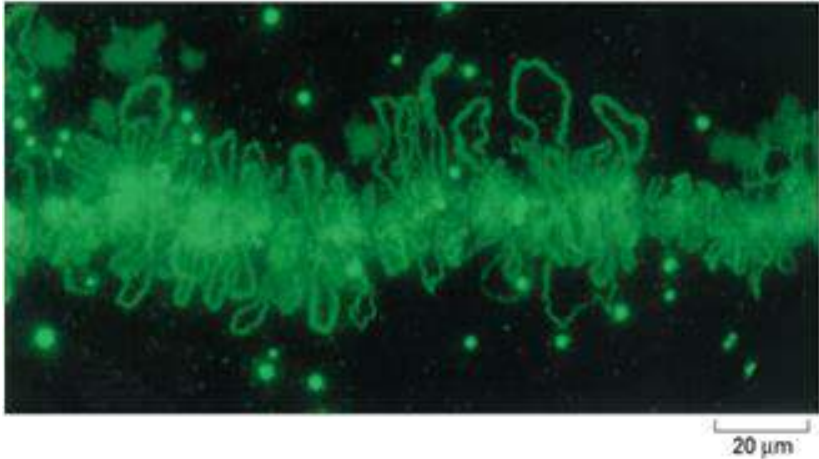
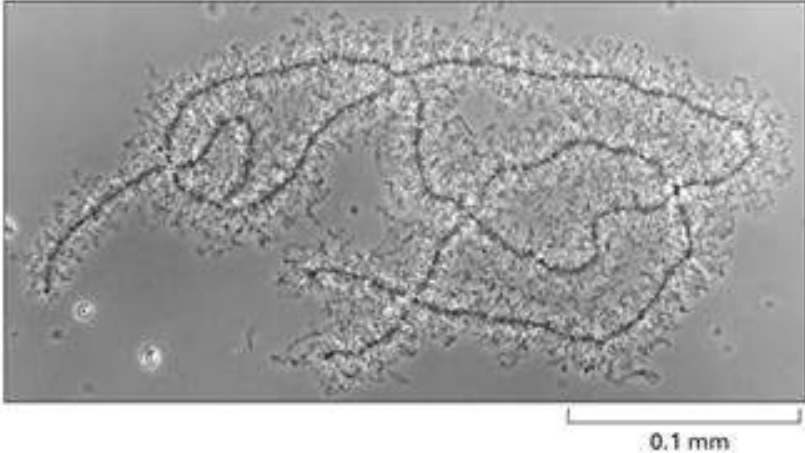



## Lesson 49

**Cell division and reproduction:** Cell division is a fundamental process which is required for growth in unicellular and multicellular organisms. It is a process that divides the cell into two daughter cells. It is necessary for reproduction in unicellular and multicellular organism. Cell division also helps to replace worn out cells in multicellular organisms.

### Reproduction in prokaryotes - binary fission

Prokaryotes simply divide their cells into two daughter cells by binary fission.

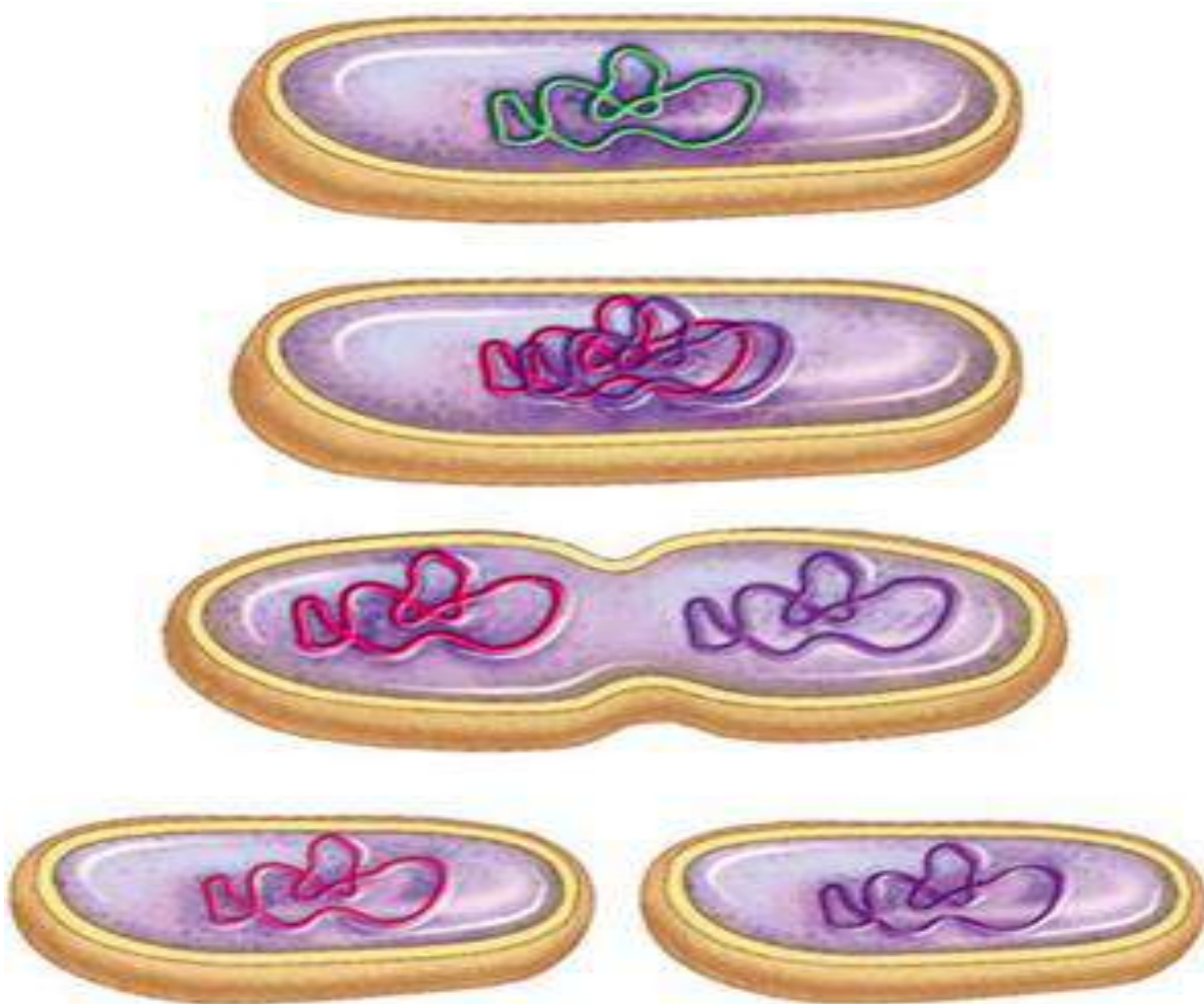

## Reproduction in eukaryotes

Eukaryotes must divide their nucleus and other organelles before cell division.

Before the nucleus divides, the genetic material replicates.

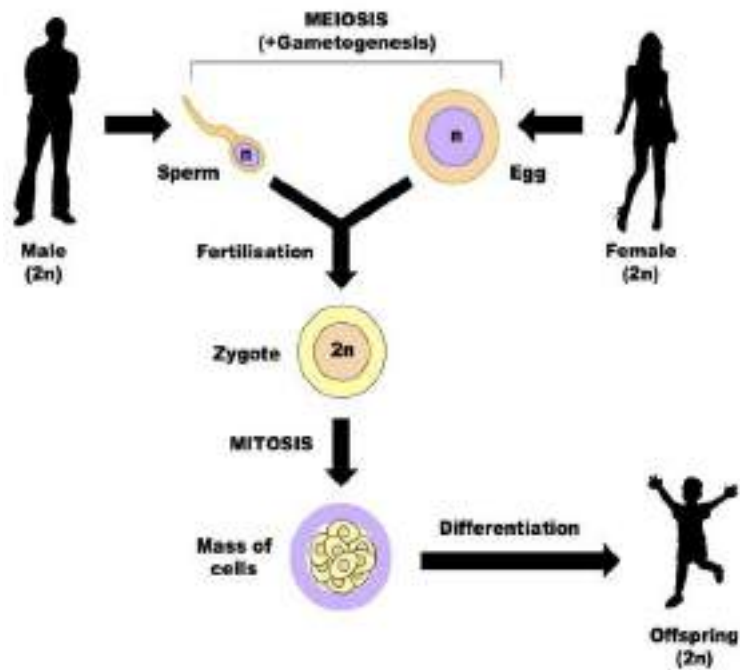

## Conclusion

Cell division and reproduction are two fundamental processes in prokaryotes and eukaryotes

## Lesson 50

**Cell cycle:** The cell cycle consists of;

- Interphase
- Mitotic phase

### Phases of cell cycle

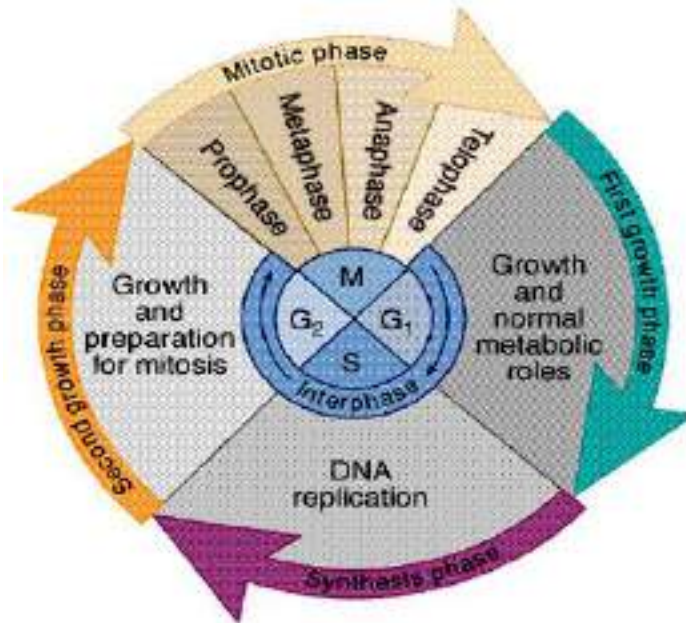

### Mitotic phase

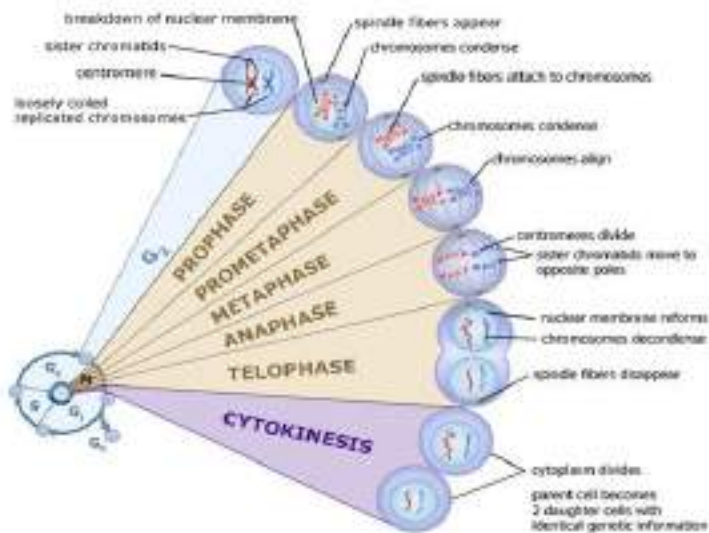

## **G0 phase**

G0 phase also called as post-mitotic phase.

Eukaryotes cells generally enter into G0 state from G1.

## **Interphase**

Before a cell enters into cell division, it needs to take nutrients.

Interphase is a series of changes that takes place in a newly formed cell.

Interphase proceeds in three stages;

- G1 stage
- S stage
- G2 stage

Functions of cell cycle include reproduction, growth and development after tissue renewal

## Lesson 51

**Mitosis:** A single cell divides into two identical daughter cells. Some haploid & diploid cells divide by mitosis. It produces two new cells from a single cell. Both new cells are genetically identical to the original cell. Each cell has to have its own cytoplasm and DNA.



Chromosomes replicate before mitosis, DNA replicate to produce identical copies. Two sister chromatids have to break apart.

# MITOSIS

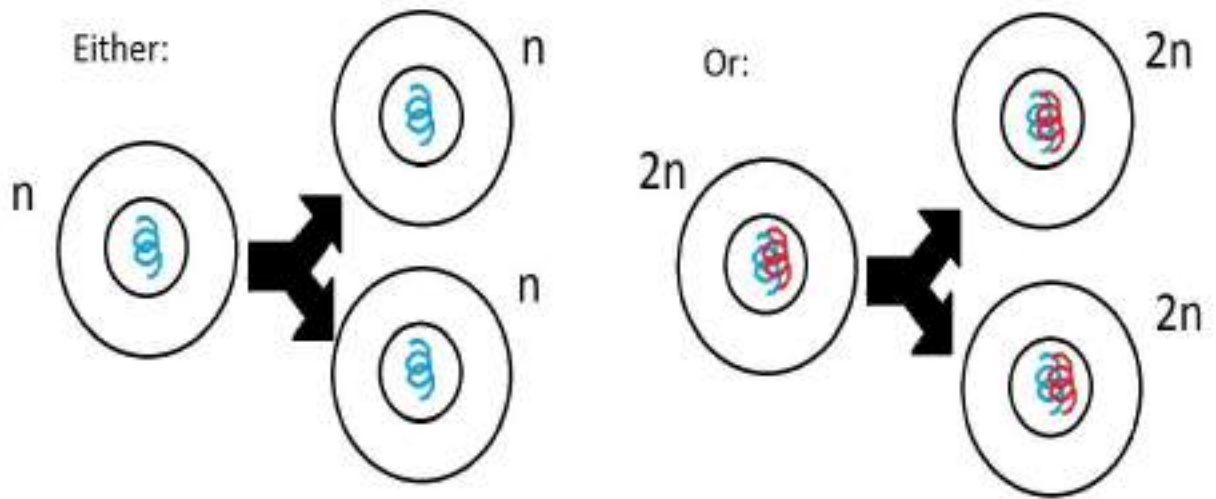

A single cell divides into two identical daughter cells.

## Lesson 52

**Un-replicated and replicated chromosome:** before the cell division takes place; Chromosomes (DNA) are replicated (duplicated) .Duplicated chromosomes which are attached at their centromere As long as they remain attached, known as sister chromatids.

### Un-replicated

Duplicated chromosomes are due to DNA replication Entire DNA of each of the chromosome replicates. Replication is semiconservative.

DNA replication: Double helical structure is opened by enzyme gyrases and topoisomerase. These enzymes remove helix and produce a nick to uncoiled DNA. One strand of DNA is called as leading strand while other strand is called as lagging strand. Continuous replication in leading strand. Discontinuous replication in lagging strands, i.e. in forms of small fragments which are called as Okazaki fragments.

Conclusion, before cell division, DNA replicates.

## Lesson 53

Interphase: Interphase consists of

- G1 phase
- S phase
- G2 phase

**Interphase summary** Interphase ~ 90% of the time.

- G1: new cell absorbs nutrients and grows larger.
- S phase: Synthesis of new DNA for daughter cells.
- G2: Cell continues to grow, gets too large, needs to divide.

## Lesson 54

**Prophase of mitosis:** Prophase is characterized by four events: Chromosomes condensed - more visible. Nuclear membrane disappears. Centrioles are separated and take positions on the opposite poles of the cell. Spindle fibers form and radiate toward the center of the cell.

- Chromosomes condense at the start of mitosis.
- DNA wraps around histones that condense it.

**Prophase- chromosomes are condensed-** Different levels of condensation/folding Chromosomes condense at the start of mitosis. DNA wraps around histones that condense it.

**Prophase Summary** Prophase is the first stage of mitotic cell division.



## Lesson 55

**Metaphase** During metaphase, two events occurs; Chromosomes line up across the middle of the cell. Spindle fibers connect the centromere of each sister chromatid to the poles of the cell, where centrioles are present. Metaphase – chromosomes are aligned in the middle

Metaphase-Summary During metaphase, two events occurs; Chromosomes lined up in the middle line. Spindle fibers connect to centromere.

## Lesson 56

Anaphase of mitosis During anaphase, three events occurs; Centromere split – as a result sister chromatids are separated. Sister chromatids become individual chromosomes. Separated chromatids move to opposite poles of the cell.

- Anaphase Securin is a protein which inhibits a protease known as separase. Destruction of securin results in split of centromeres and the new daughter chromosomes are pulled toward the poles.

Cell in an oval shape Chromosomes are drawn to each side of the cell.

Non-kinetochore spindle fibers push against each other, that stretch the cell into an oval shape

Summary Centromere split and chromosomes are separated. Chromosomes arrived at poles. Cell stretches into an oval shape.

## **Lesson 57**

### **Telophase**

consists of four events: Chromosomes start to uncoil. Nuclear envelope forms around the chromosomes at each pole of the cell.

Telophase Spindle fibers break down and dissolve, Daughter nucleus is formed in each of the daughter cell. Telophase Nuclear membranes are formed around each set of chromatids. Nucleoli also reappear. Chromosomes unwind back into chromatin material.

Telophase – effects of prophase are reversed During telophase, the effects of prophase and pro-metaphase are reversed.

Telophase Summary Spindle fibers break down and nuclear members develops around each daughter nucleus.

## **Lesson 58**

### **Cytokinesis**

Cytokinesis is the division of the cytoplasm into two individual cells. Process differs in plants and animal cells

Cytokinesis in animal cells Cell membrane forms a cleavage furrow that eventually pinches the cell into two equal parts. Each part containing its own nucleus and cytoplasmic organelles.

Cytokinesis in Plants cells a cell plate is formed in midway that divides the nuclei. Cell plate gradually develops into a separating membrane.

Plants cell- cytokinesis

Cytokinesis - comparison

Summary Cytokinesis differs in animal and plant cells. In animal cells, the membrane pinches and divides the cell. In plant cells, a cell plate forms that divides the cell.

## Lesson 59

Mitotic apparatus/ spindles include

- Centrosomes
- Spindle microtubules
- Asters

Mitotic apparatus/ spindles the apparatus of microtubules controls chromosome movement during mitosis. Centrosome replicates Centrosome replicates, forming two centrosomes that migrate to opposite poles. Assembly of spindle microtubules begins in the centrosome. Mitotic spindles – asters Asters are the radial array of short microtubules extends from each centrosome Spindles microtubules attach to kinetochores Spindle microtubules attach to the kinetochores of chromosomes and move the chromosomes to the metaphase plate.

Mitotic spindles in anaphase, sister chromatids separate and move along the kinetochore microtubules toward opposite ends of the cell.

## Lesson 60

### Diploid cells and haploid cells

**Diploid cells** are body cells. They are called as  $(2n)$  cells. Examples: skin cells, brain cells, bone cells, blood cells. In humans,  $\sim 220$  types of somatic cells.

**Haploid cells** Sex cells produce gametes. Gametes are haploid  $(n)$  cells. Sperms and ova are gametes which are produced in males and females respectively.

**Male Gametes and female gametes** the male gametes are the sperms and are produced in the male gonad - testes. The female gametes are the ova (ovum) and are produced in the female gonad - ovaries.

**Fertilization** is a process of fusion of spermatozoa and ova to produce a cell called zygote.

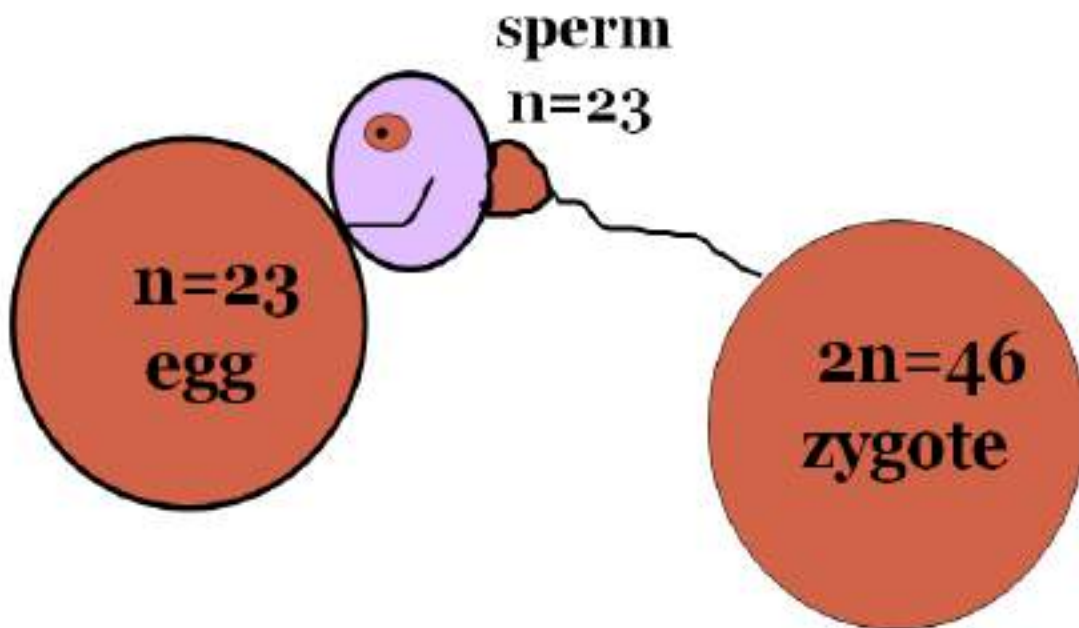

Diploid - somatic cells

Haploid - sex cells

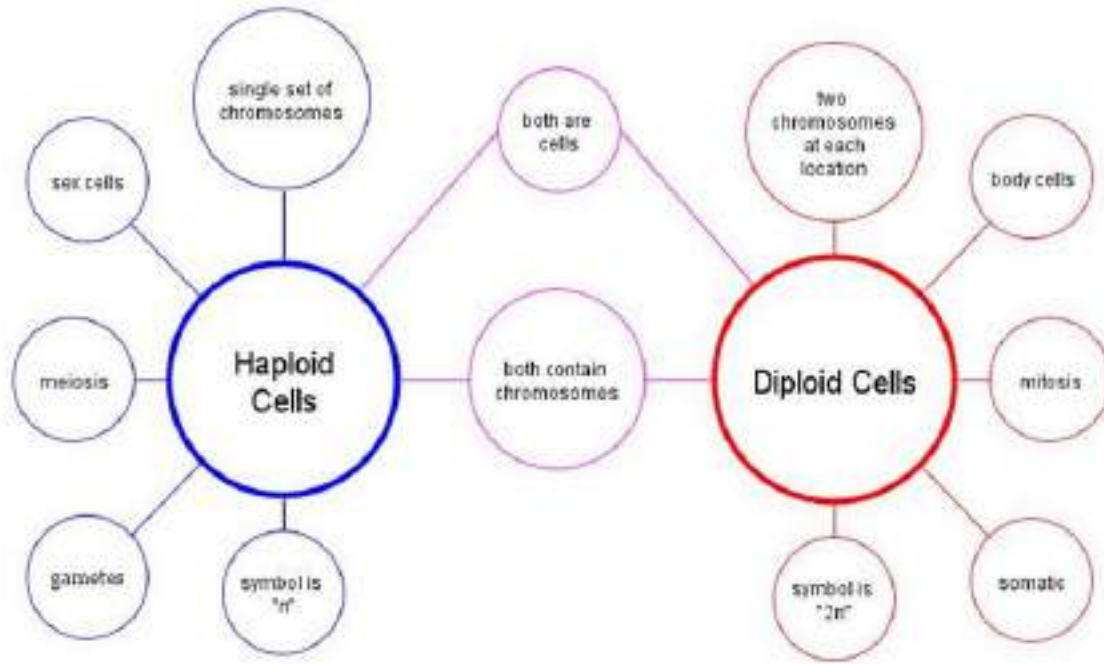

Meiosis is a process that reduces diploid number into haploid.

## Lesson 61

### Homologous chromosomes:

Pair of chromosomes that are similar in shape and size are called as homologous chromosomes. Homologous pairs carry genes (alleles) controlling the same inherited traits. Each gene alleles are in the same position on homologous chromosome.

### Homologous – shape and size

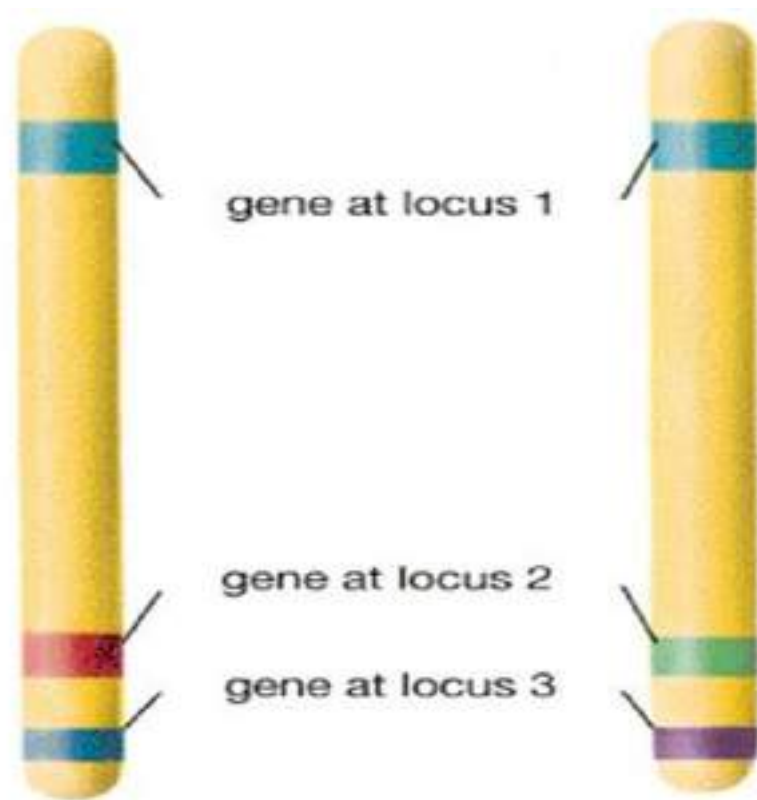

**Homologous- one from male, one from female:** For each set, one of the homologues comes from the male, while other homologue comes from the female. If an organism is diploid ( $2n$ ) then it has two matching

**Homologous chromosomes in humans** are 46 chromosomes; 22 pair of homologous chromosomes, while one pair is of sex chromosomes. Sex chromosomes in male are XY while female is XX.

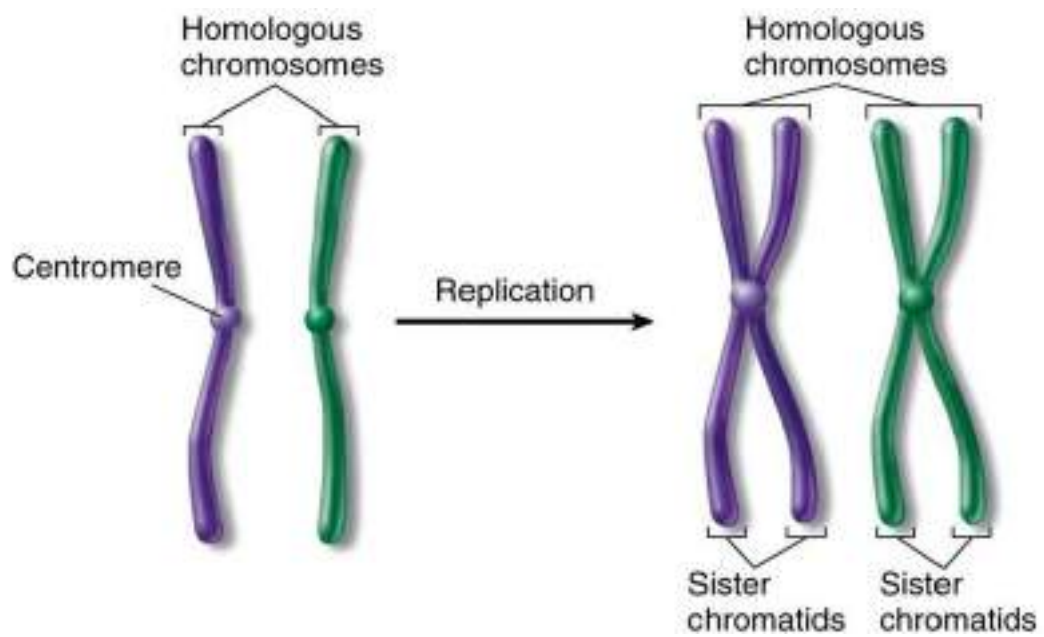
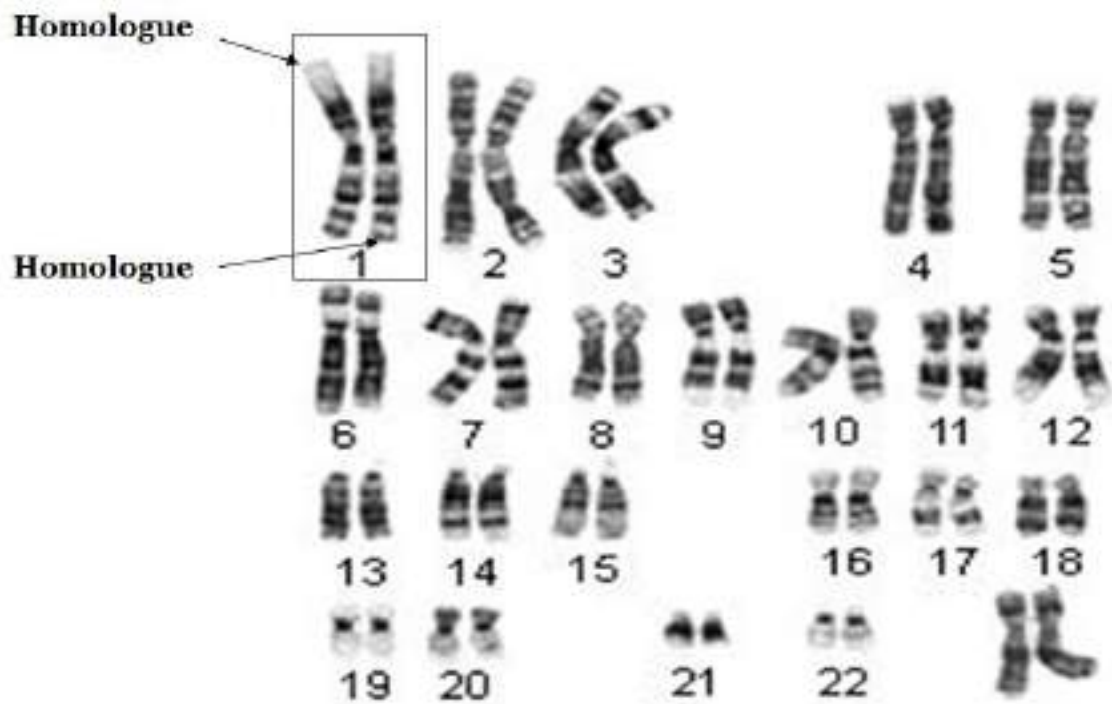

## Lesson 62

**Meiosis:** Meiosis - diploid cells are reduced to haploid cells. This is a process by which gametes (sex cells) are produced.

**Chromosome numbers would be doubled without meiosis.** If meiosis did not occur, the chromosome number in each new generation would be doubled. The offspring would die.

**Meiosis** is a two cell divisions process. There is only one duplication of chromosomes during meiosis I.

Meiosis I

Meiosis II

### Spermatogenesis and oogenesis

Meiosis in males is called spermatogenesis and produces sperms.

Meiosis in females is called oogenesis and produces ova.

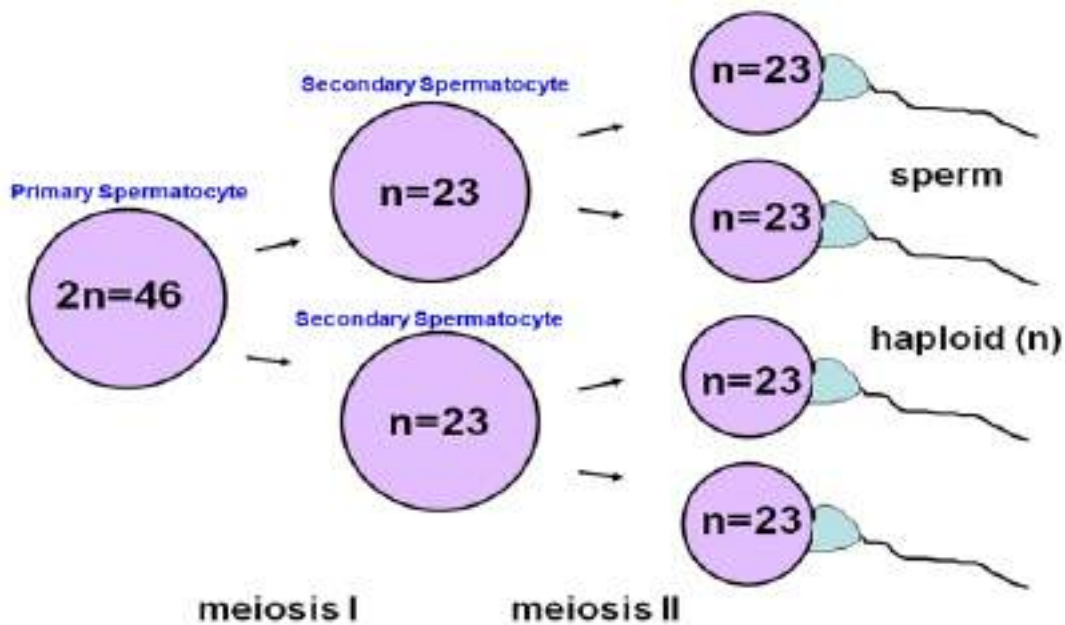

Spermatogenesis: Four sperm cells are produced from primary spermatocyte



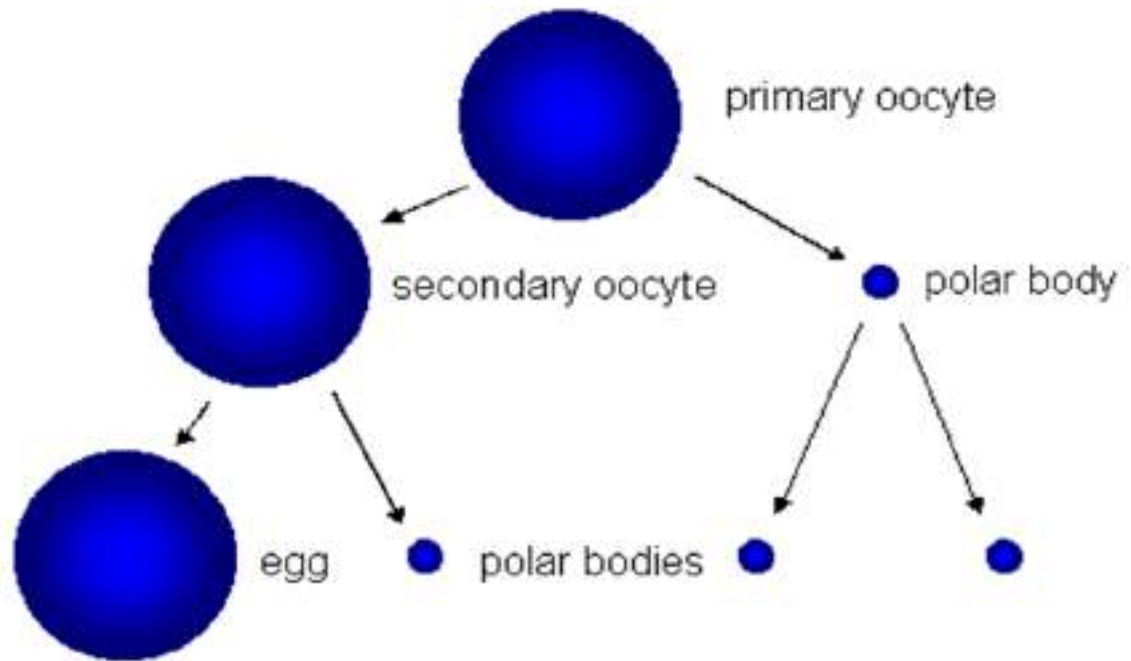

Oogenesis: The polar bodies die. Only one ovum (egg) is produced from each primary oocyte.

## Lesson 63

**Stages of meiosis:** There are two stages of meiosis

Meiosis I

Meiosis II

During meiosis I, homologous chromosomes separate.

During meiosis II, sister chromatids separate.

### Meiosis I – Reductional division

Meiosis I results in two haploid daughter cells. It is called the reductional division. Homologous chromosomes separate.

**Meiosis II:** Second cell division where sister chromatids separate. As a result of meiosis II, two haploid cells become four haploid cells. Meiosis II behaves like mitosis, where no reduction in chromosomes number.

**Meiosis II – Equational division:** Meiosis II results in four haploid daughter cells with unreplicated chromosomes; it is called equational division.

### Interphase chromosomes replicates

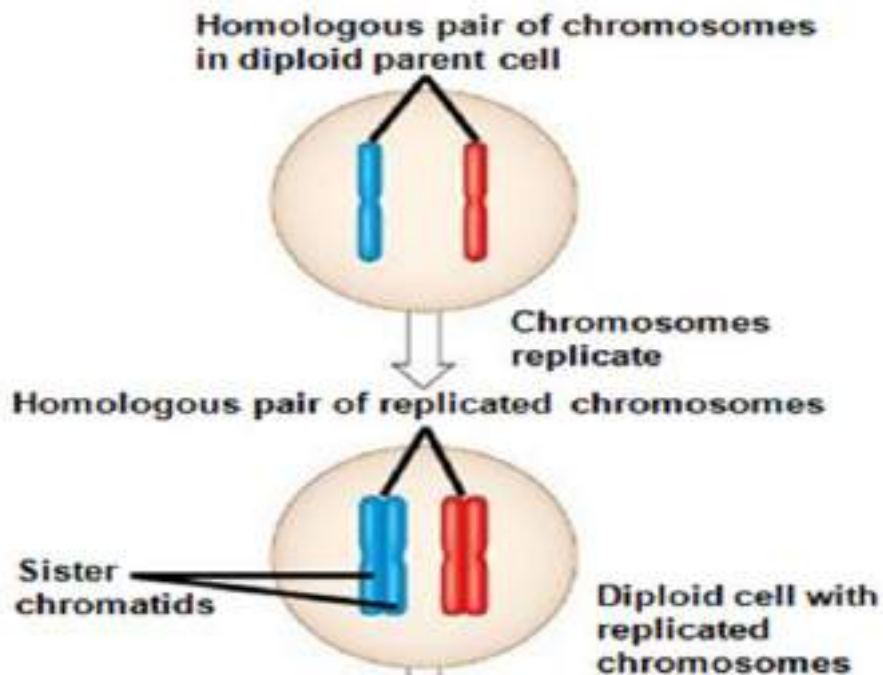

## Meiosis I, Meiosis II

Meiosis - four haploid cells

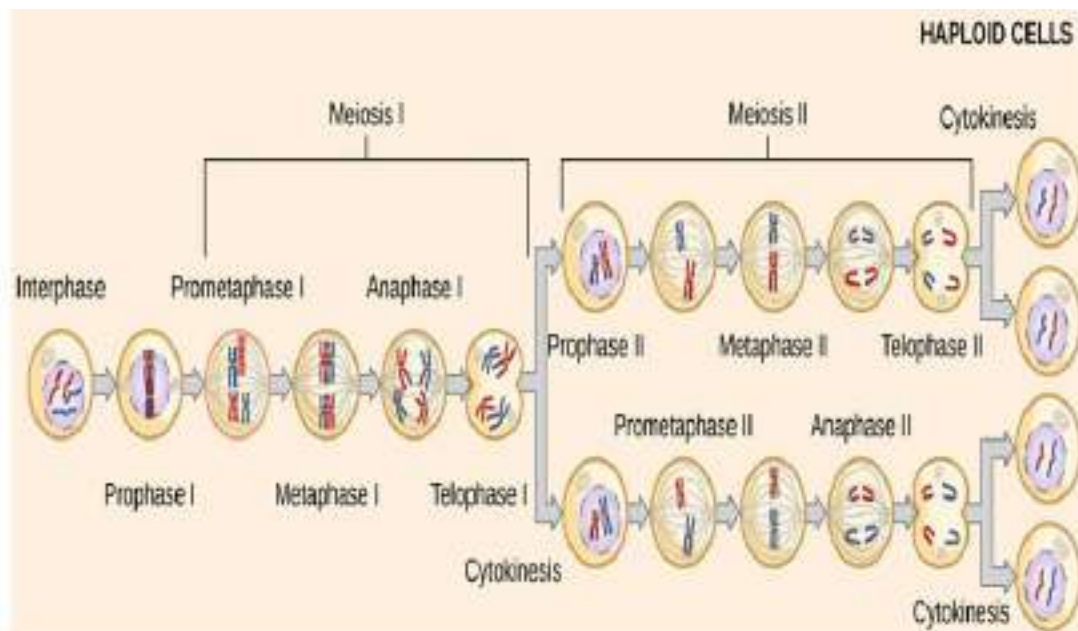
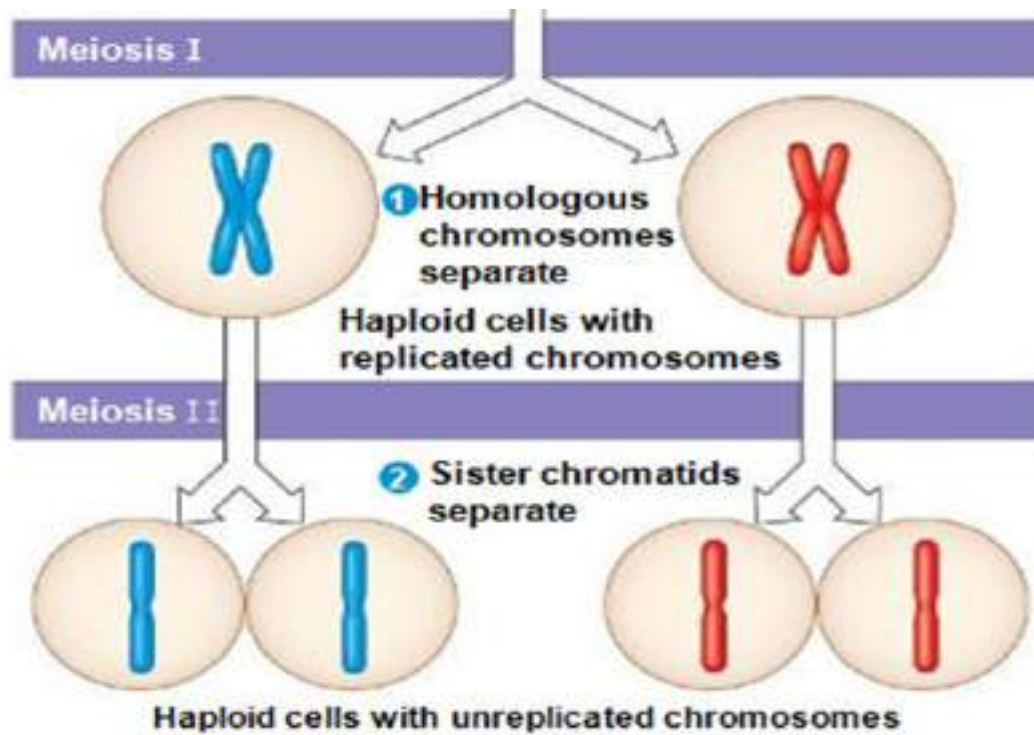

## Lesson 64

### Prophase I of meiosis

Prophase I occupies more than 90% of the time required for meiosis. Five sub stages of prophase I

#### Sub stages of prophase I

- Leptotene
- Zygotene
- Pachytene
- Diplotene
- Diakinesis

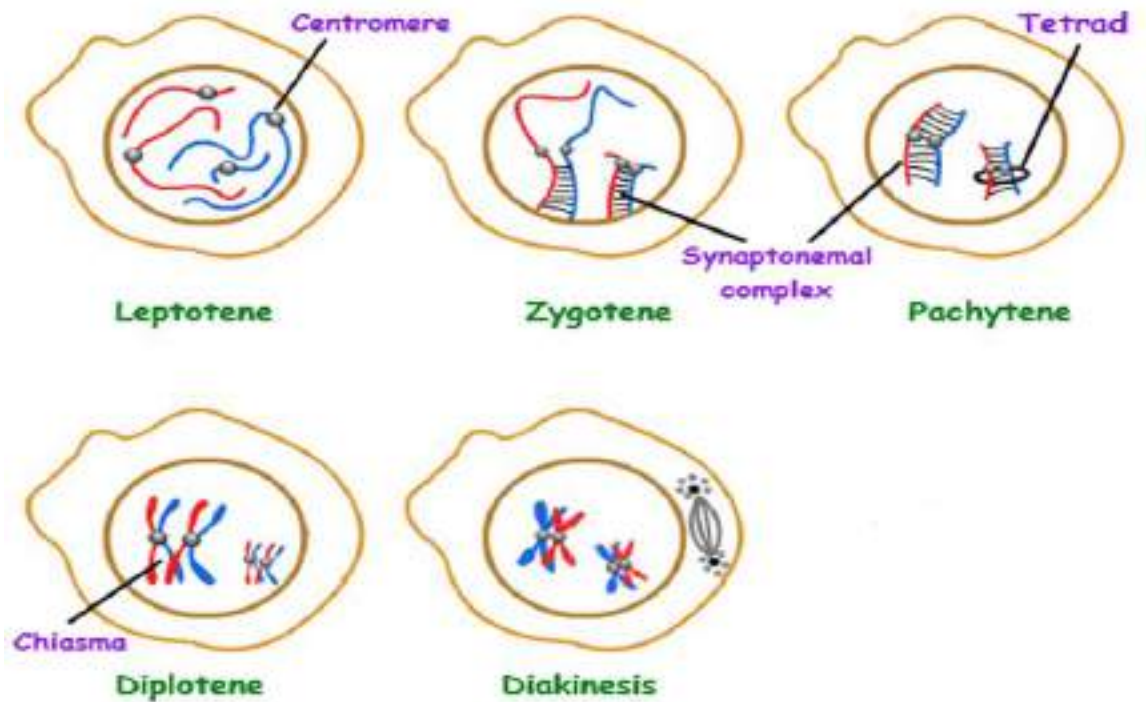

**Events of prophase I:** The duplicated homologous chromosomes pair. The nucleolus disappears. Centrioles migrate to opposite poles of the cell. Meiotic spindle forms between the two pairs of centrioles. Nuclear membrane disappears.

**Chiasmata formation during prophase I** During pairing up of chromosomes, nonsister chromatids exchange DNA segments. Each pair of chromosomes forms a tetrad, a group of four chromatids.

**Pairing and exchange of chromosome fragments**

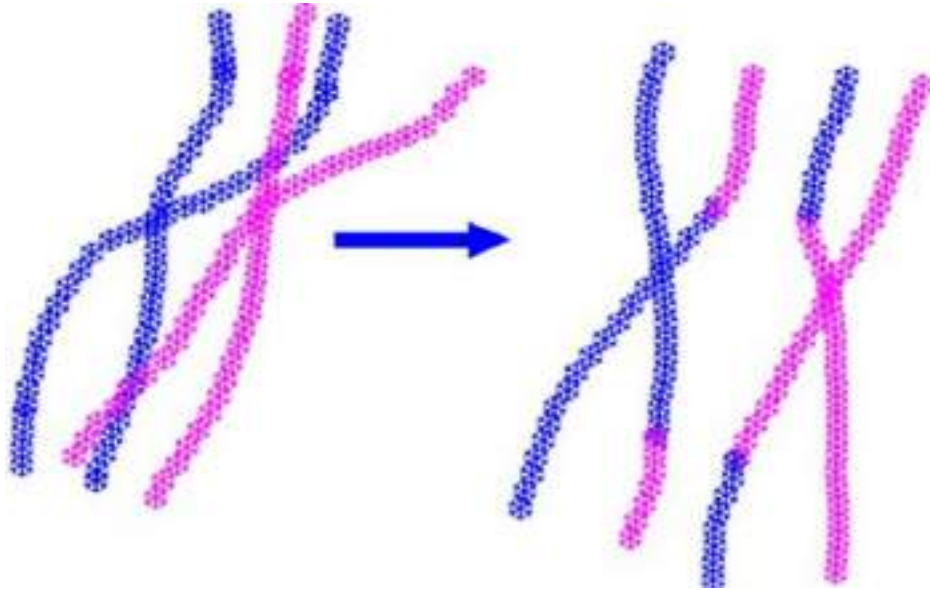

**Prophase I – Chiasmata**

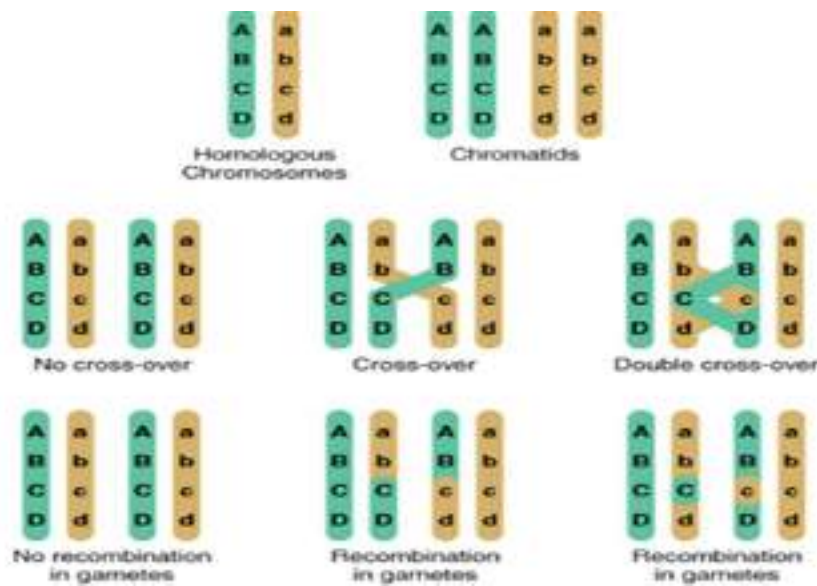

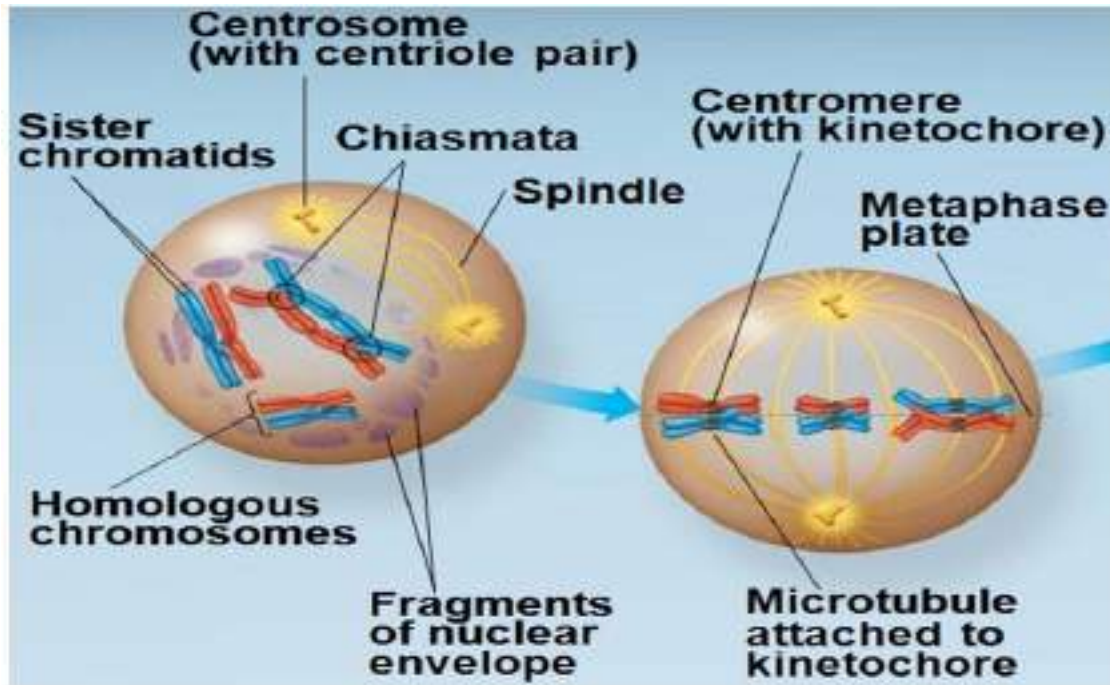

### Summary - Prophase I

- Homologous chromosomes pairs.
- Nucleolus disappears.
- Meiotic spindle forms.
- Nuclear membrane disappears.

## Lesson 65

### Metaphase I of meiosis:

In metaphase I, tetrads line up at the metaphase plate, with one chromosome facing each pole. Microtubules from one pole are attached to kinetochores of one chromosome of each tetrad. Microtubules from the other pole are attached to the kinetochores of the other chromosome.

### Metaphase I

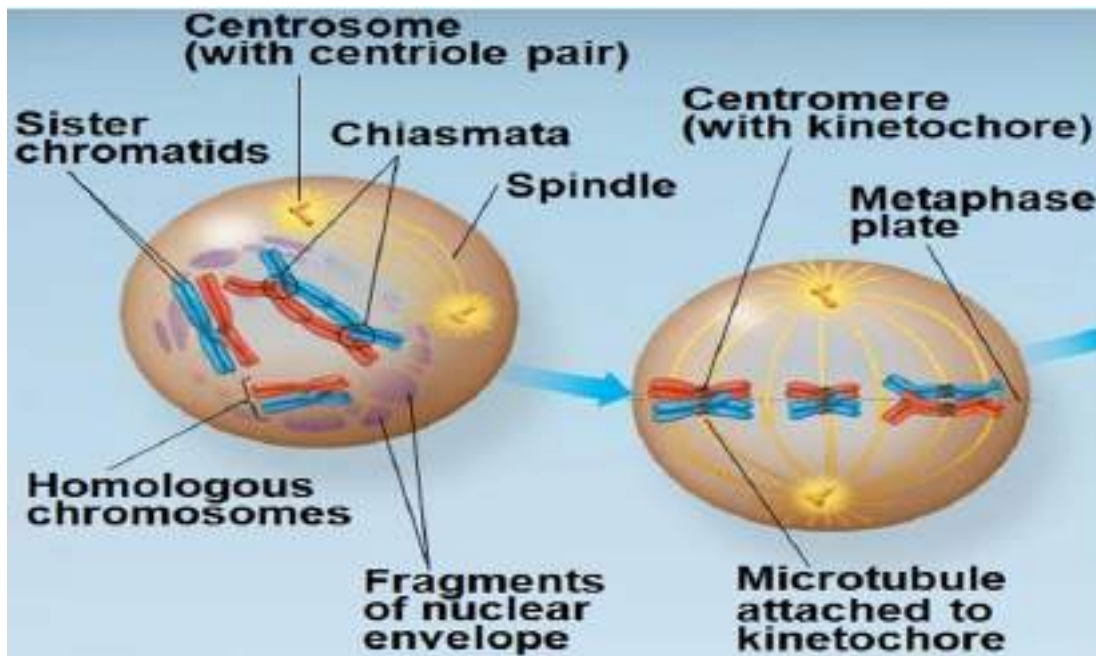

## Lesson 66

**Anaphase I of meiosis** Pairs of homologous chromosomes separate. One chromosome moves toward each pole, guided by the spindle apparatus.

**Anaphase I – sister chromatids attached at centromere** Sister Chromatids remain attached at the centromere of each of the homologue chromosome and move as one unit toward the pole.

### Difference between anaphase of mitosis and meiosis I

Sister chromatids remained joined in meiosis I, whereas in mitosis they separate.

In mitosis, centromere splits into two parts while in meiosis it do not splits.

### Anaphase I

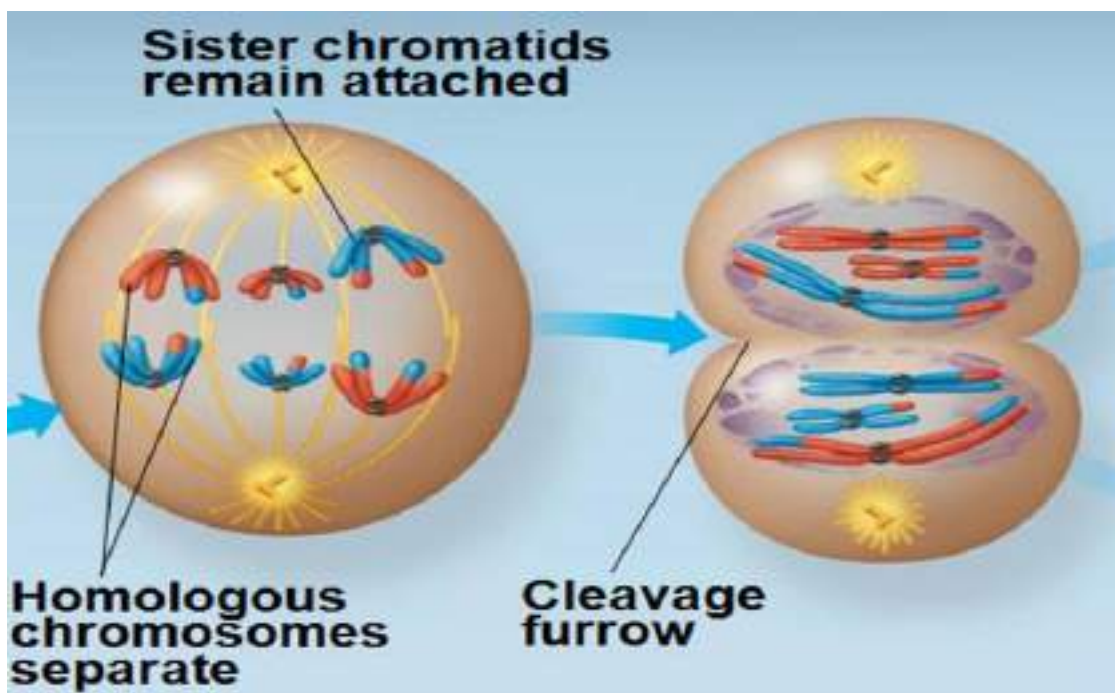



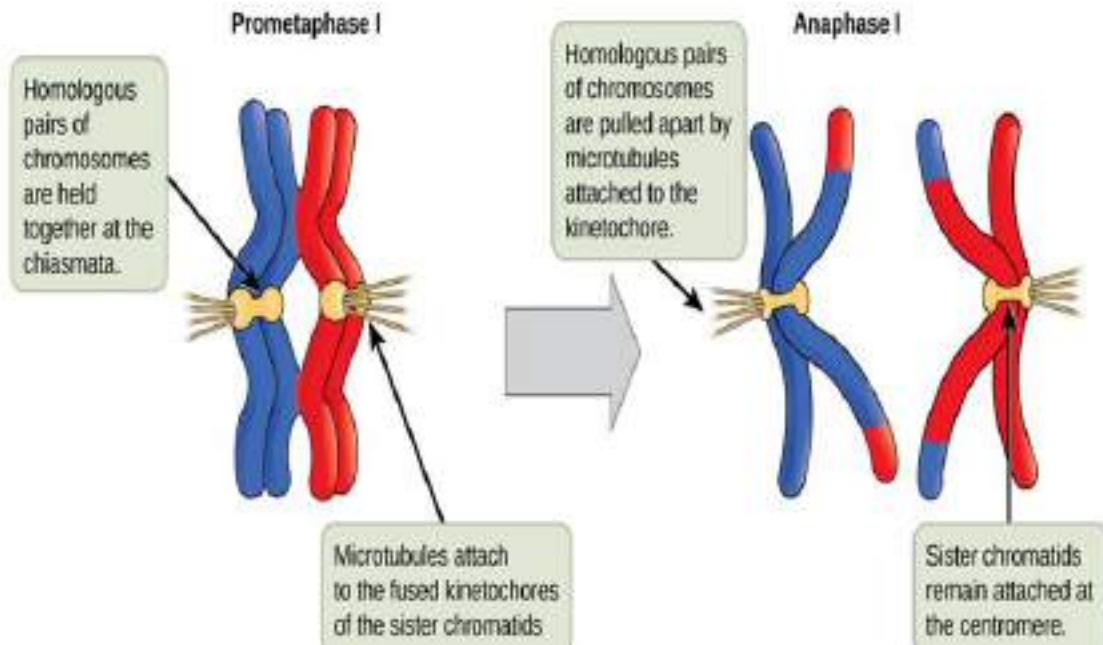

### Summary - Anaphase I

- Pairs of homologous chromosomes separate.
- One chromosome moves toward one pole while other chromosome moves to other pole of the cell.

## Lesson 67

### Telophase I of meiosis:

Haploid set of chromosomes arrived at each of the pole. Each chromosome still consists of two sister chromatids. Cytokinesis usually occurs simultaneously, forming two haploid daughter cells.

### Cytokinesis – Animal cell and plants cell

- In animal cells, a cleavage furrow is formed.
- In plant cells, a cell plate formed.

**No replication between Meiosis I and meiosis II:** There is no chromosome replication between the end of meiosis I and beginning of meiosis II. Chromosomes are already replicated.

### Telophase I

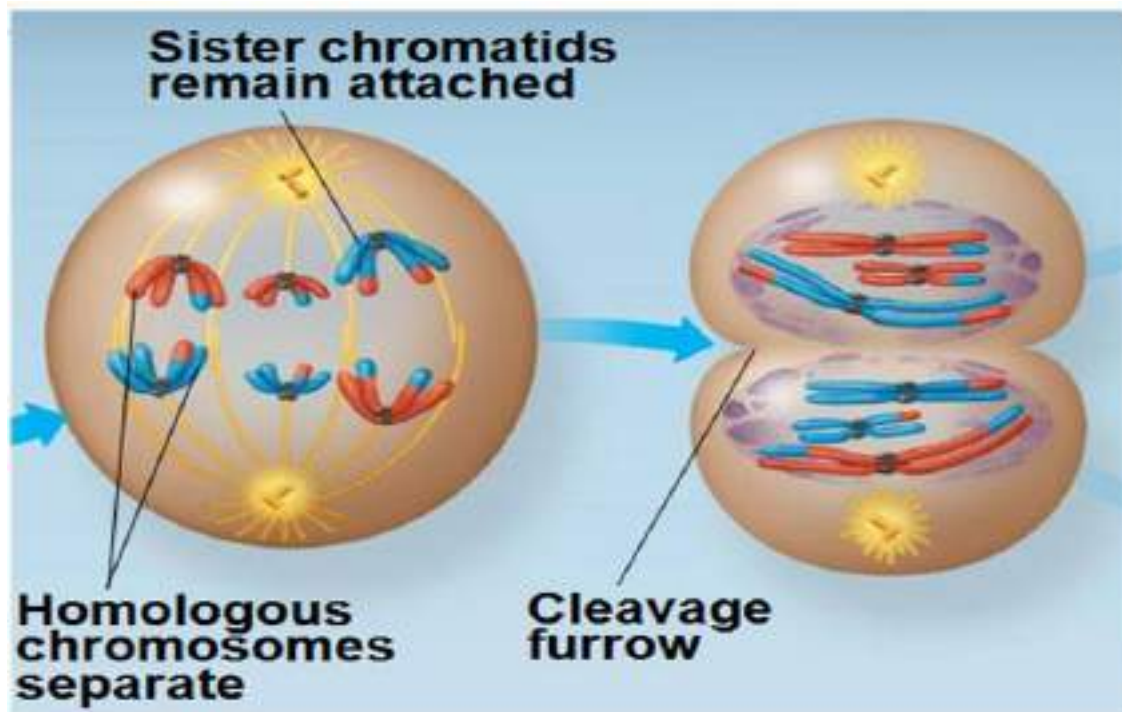

Haploid set of chromosomes arrived at each of the pole.

Meiosis I results, a diploid cell produced two haploid cells.

## Lesson 68

### Prophase II of meiosis

#### Meiosis II similar to mitosis

- Meiosis II also occurs in four phases:
- Prophase II
- Metaphase II
- Anaphase II
- Telophase II and cytokinesis

**Prophase II:** No replication of Chromosomes as they are already replicated. Centrioles are separated and take positions on the opposite poles of the cell. Nuclear membrane disappears. Spindle fibers form and radiate toward the center of the cell.

#### Prophase II

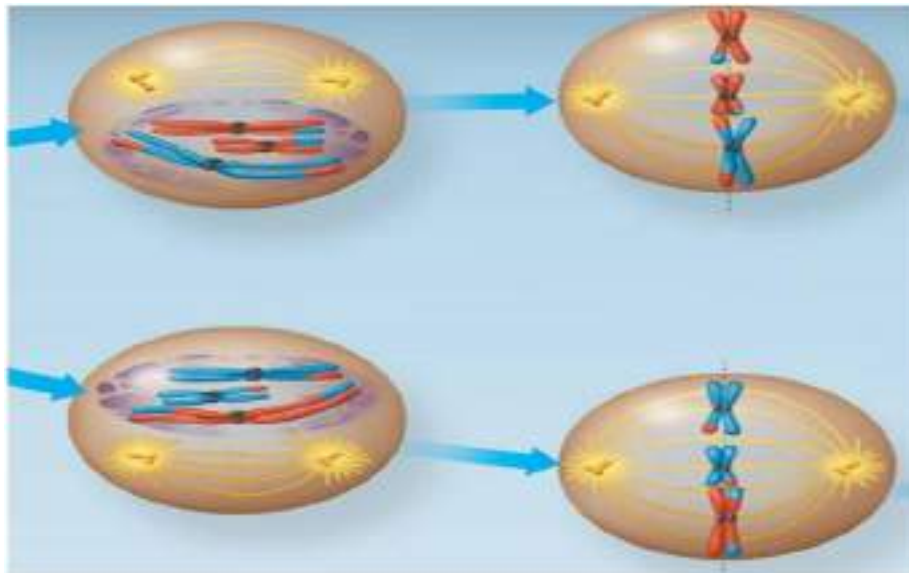

#### Summary - Prophase II

- Nuclear membrane disappears.
- Spindle fibers form and radiate toward the center of the cell.
- Centrioles take the position on poles.

## Lesson 69

**Metaphase II of meiosis:** In metaphase II, sister chromatids are arranged at the metaphase plate.

The kinetochores of sister chromatids attach to microtubules extending from opposite poles.

Chromosomes lined up across the middle of the cell. Due to crossing over during meiosis I, the two sister chromatids of each chromosome are no longer genetically identical.

### Metaphase II

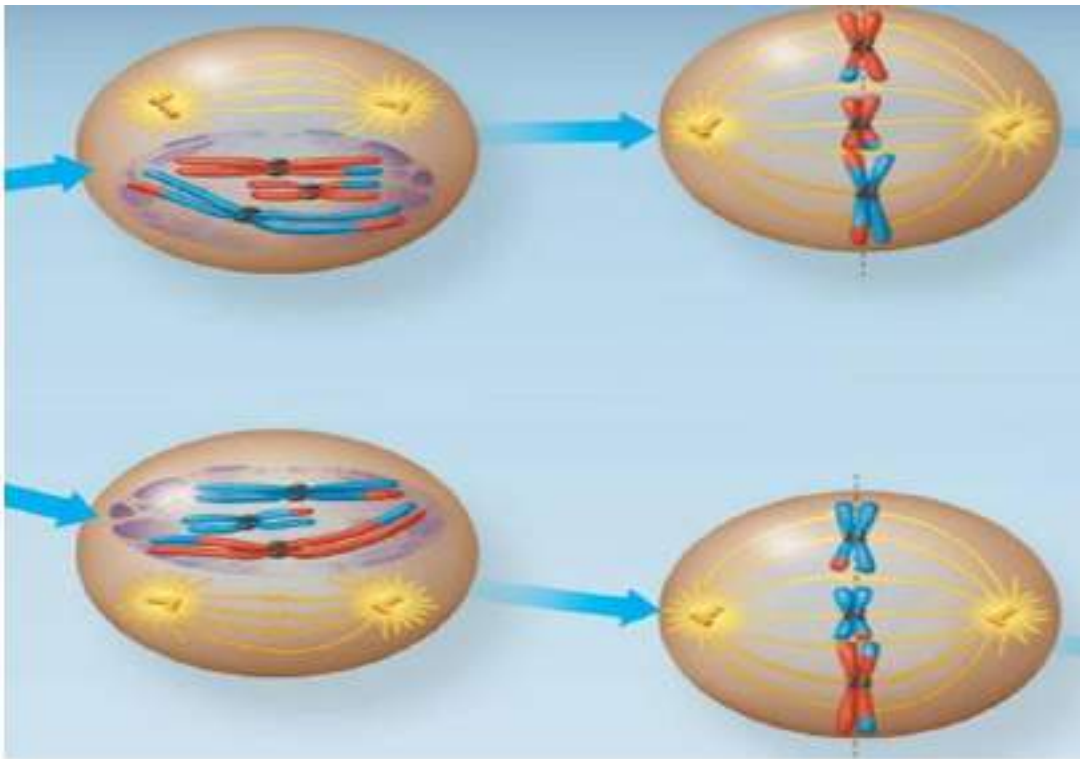

Kinetochores of sister chromatids attach to microtubules extending from opposite poles. Chromosomes lined up across the middle of the cell.

## Lesson 70

**Anaphase II of meiosis:** Centromere split – as a result sister chromatids are separated. Sister chromatids become individual chromosomes. Separated chromatids move to opposite poles of the cell.

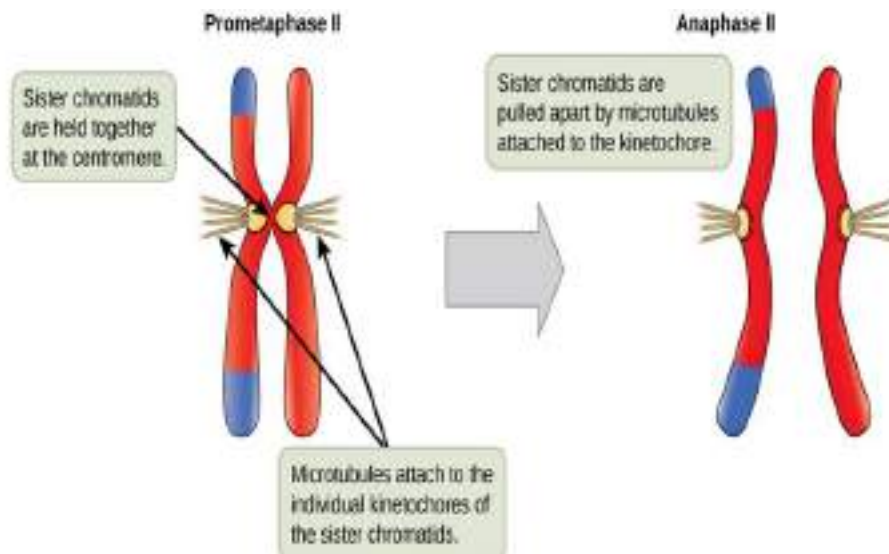
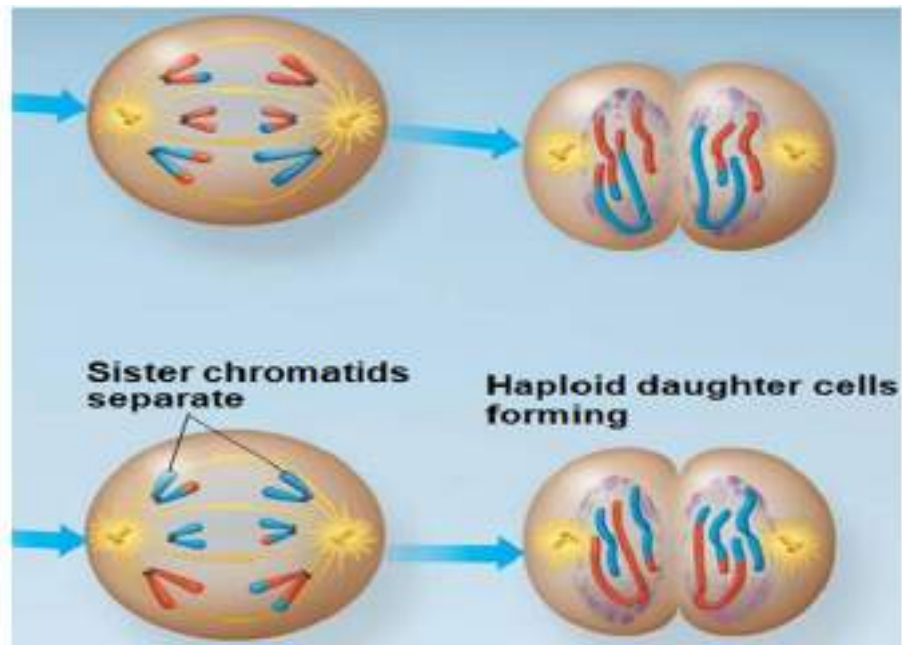

### Summary - Anaphase II

- Sister chromatids become individual chromosomes.
- Separated chromatids move to opposite poles of the cell.

## Lesson 71

**Telophase II of meiosis:** In Telophase II, the chromosomes arrive at opposite poles. Nuclear membrane forms and the chromosomes begin de-condensing. Cytokinesis occurs. Now, there are four daughter cells, each with a haploid set of chromosomes. Each daughter cell is genetically distinct from the others and from the parent cell.

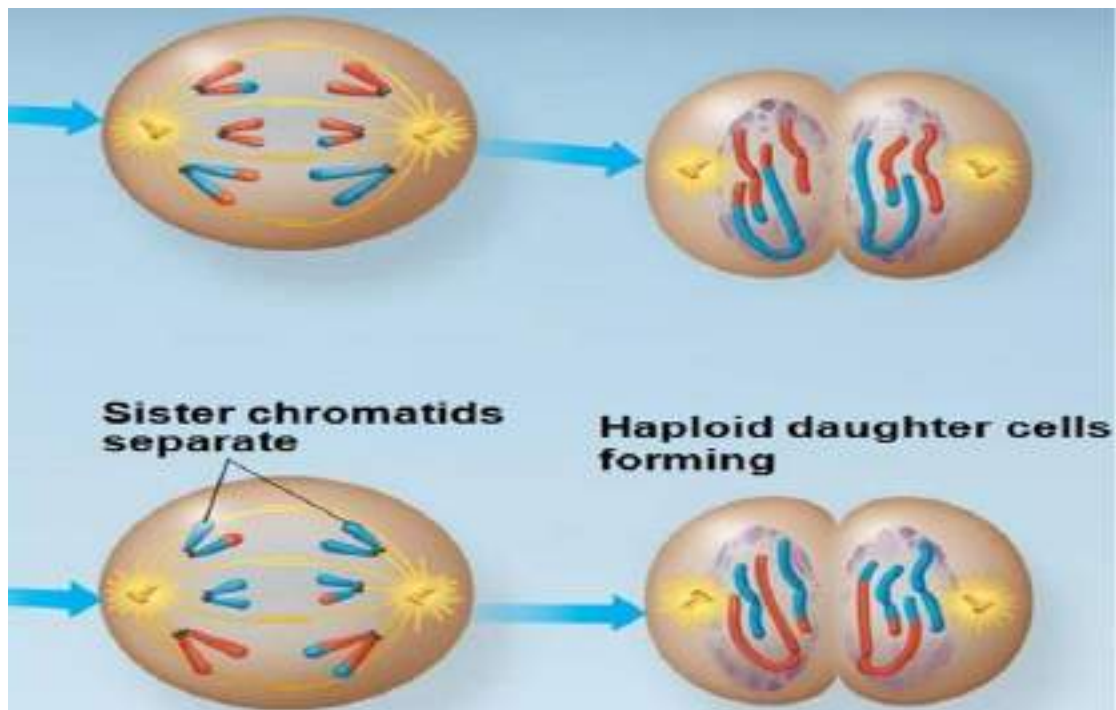

### Telophase II

#### Summary - Telophase II

- Four daughter cells are produced each with a haploid set of chromosomes.
- Each daughter cell is genetically distinct from the others and from the parent cell.

## Lesson 72

### Mitosis and meiosis

**Mitosis:** Mitosis conserves the number of chromosome sets, producing cells that are genetically identical to the parent cell.

**Meiosis:** Meiosis reduces the number of chromosomes sets from two (diploid) to one (haploid), producing cells that differ genetically from each other and from the parent cell.

### Comparison

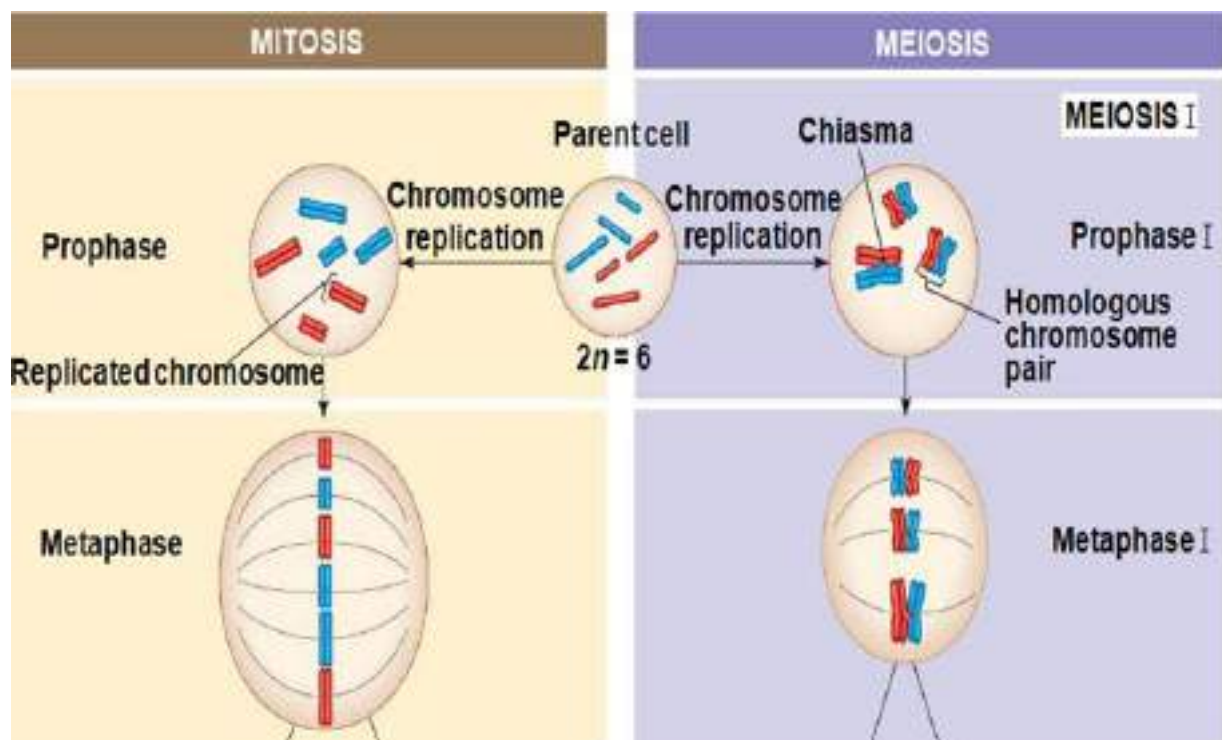

The mechanism for separating sister chromatids is virtually identical in meiosis II and mitosis.

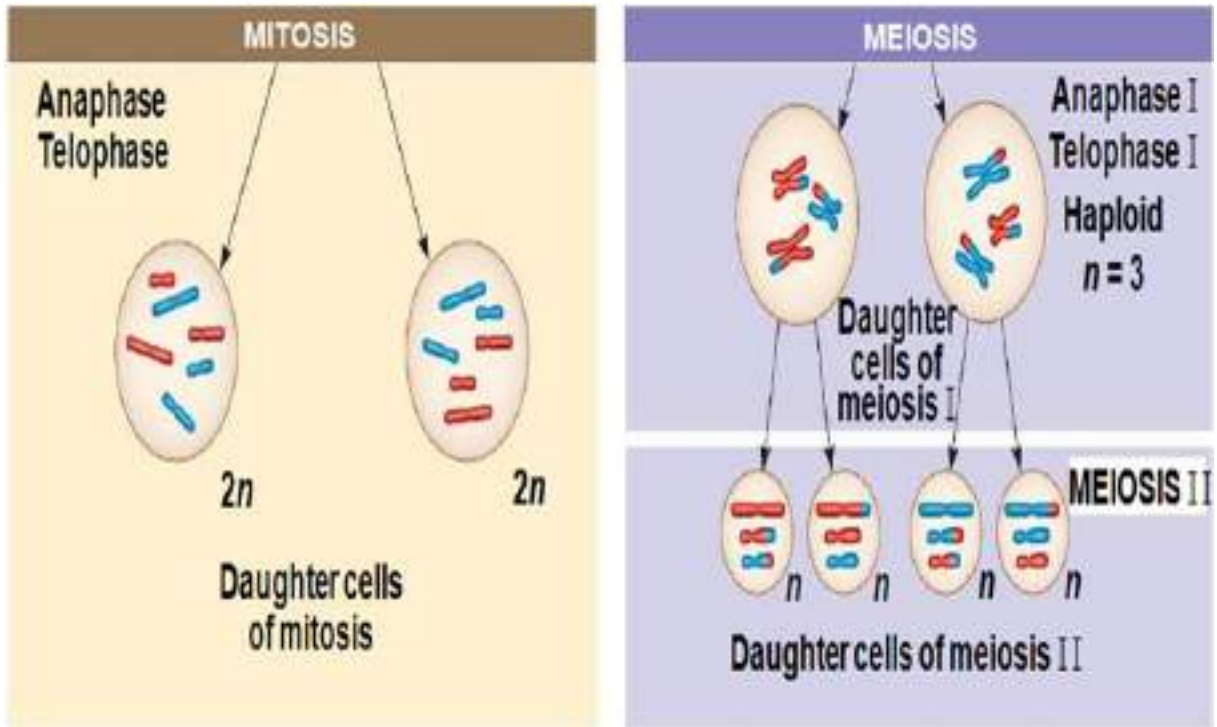

### Comparison

Meiosis reduces the number of chromosomes sets from diploid to one haploid and produced four daughter cells which not identical to each other and parent cell.

Mitosis – produces two daughter cells which are identical to parent cell.



## Lesson 73

### Summary - Mitosis and meiosis

SUMMARY		
Property	Mitosis	Meiosis
DNA replication	Occurs during interphase before mitosis begins	Occurs during interphase before meiosis I begins
Number of divisions	One, including prophase, metaphase, anaphase, and telophase	Two, each including prophase, metaphase, anaphase, and telophase
Synapsis of homologous chromosomes	Does not occur	Occurs during prophase I along with crossing over between nonsister chromatids; resulting chiasmata hold pairs together due to sister chromatid cohesion
Number of daughter cells and genetic composition	Two, each diploid ( $2n$ ) and genetically identical to the parent cell	Four, each haploid ( $n$ ), containing half as many chromosomes as the parent cell; genetically different from the parent cell and from each other
Role in the animal body	Enables multicellular adult to arise from zygote; produces cells for growth, repair, and, in some species, asexual reproduction	Produces gametes; reduces number of chromosomes by half and introduces genetic variability among the gametes

## Lesson 74

**Chromosomal theory of inheritance:** The chromosomal theory of inheritance states that genes have specific loci on chromosomes.

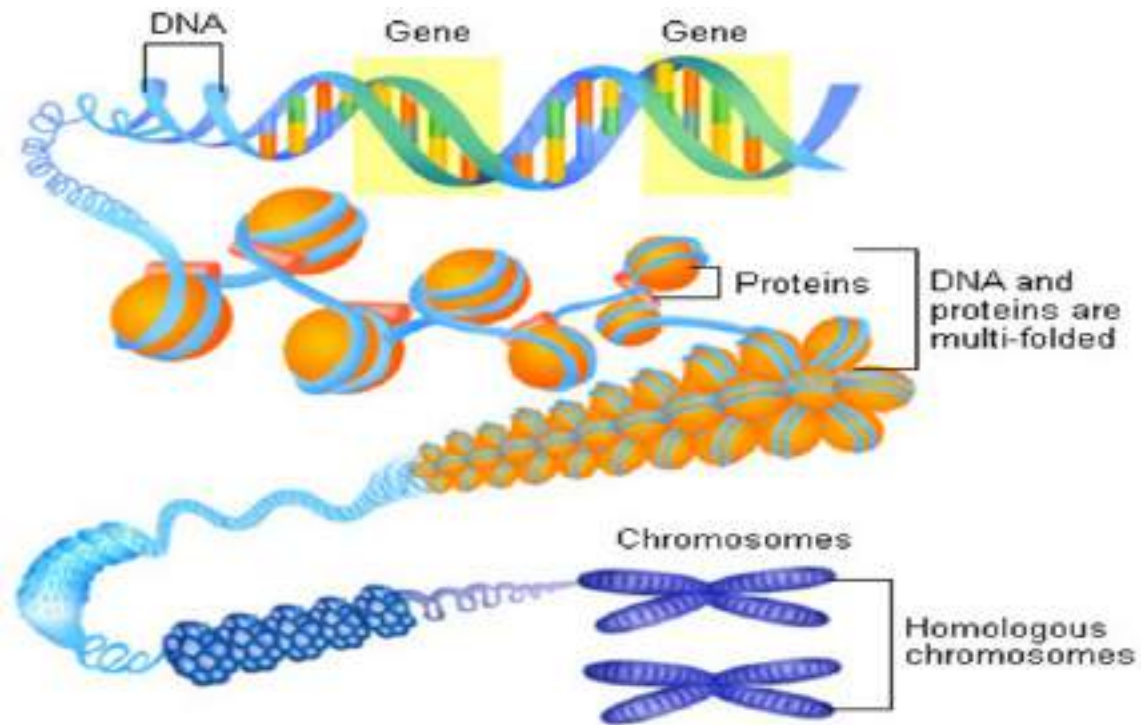

Genes on chromosomes

### **Behavior of chromosomes – According to Mendel's Laws**

Theory states that behavior of chromosomes is according to Mendel's laws of segregation and independent assortment.

### **Mendel's factors and chromosomes behavior**

Around 1900, cytologists and geneticists began to see parallels between the behavior of chromosomes and the behavior of Mendel's factors.

Homologous chromosomes separate and alleles segregate during meiosis.

Fertilization restores the paired condition for both chromosomes and genes.

## Evidence that chromosomes are location of genes

- T. H. Morgan was the first to associate a specific gene/trait with a specific chromosome.
- Convincing evidence that chromosomes are the location of Mendel's heritable factors.

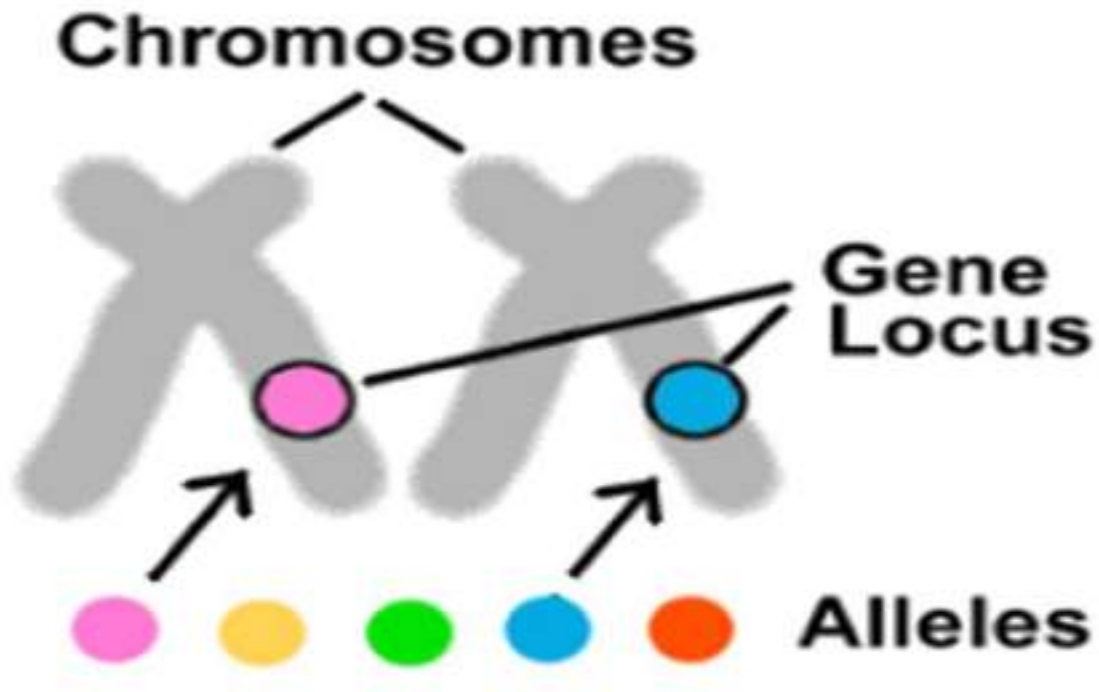

Chromosomal theory of inheritance states that Genes are present on chromosomes.

## Lesson 75

### Experiment of T. H. Morgan

#### Eye color trait is linked with sex of drosophila

- Morgan with an experiment proved that eye color trait is linked with sex of the drosophila.

#### Experiment

- Male flies were with white eyes (mutant).
- Female flies were with red eyes (wild type).

#### Male flies with white eyes Female flies with red eyes

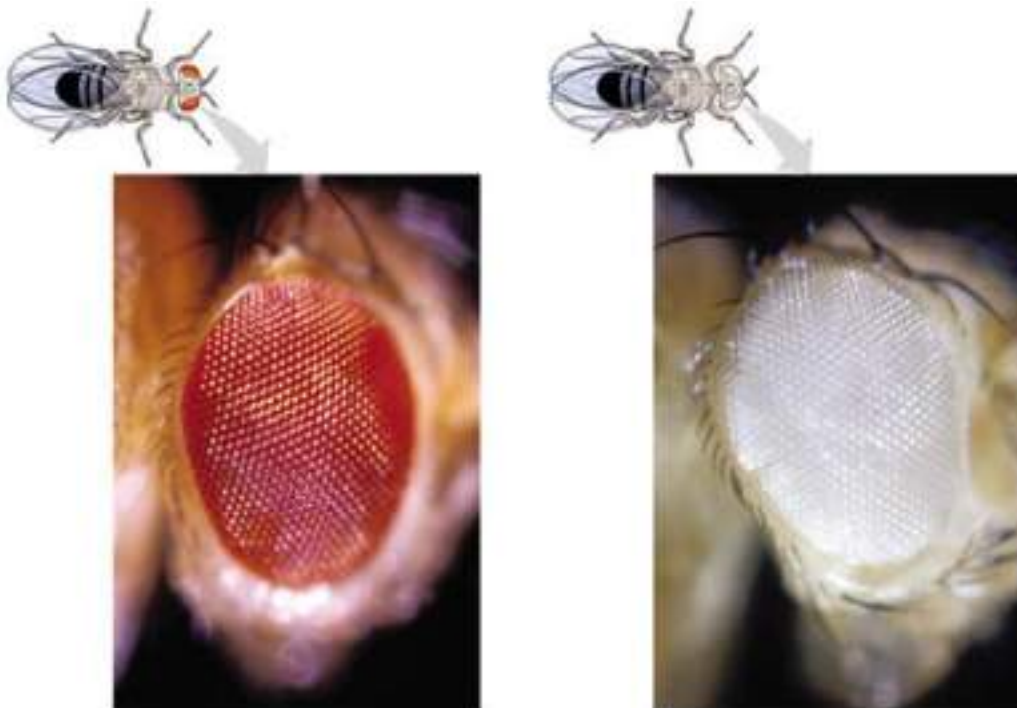

#### Progeny f1 was with red eyes

- All the flies produced during F1 generation were with red eyes.

#### Progeny f2 showed 3:1 ratio

- F2 generation showed 3:1 (three red eye: one white eye).

- White-eyed trait appeared only in males.
- All females and half males with red eye.

**White eyed trait appeared only in males**

- White-eyed trait appeared only in male fruit flies (*Drosophila melanogaster*).

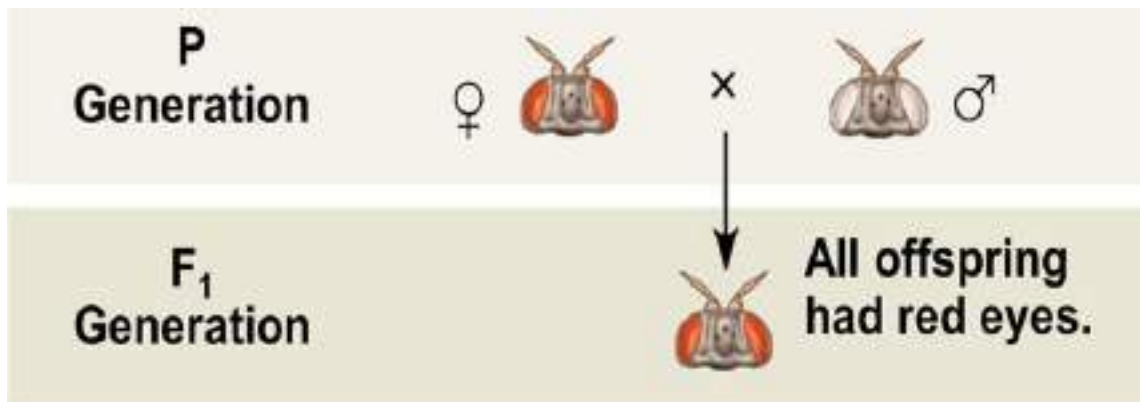

**RESULTS**



## Morgan's Experiment

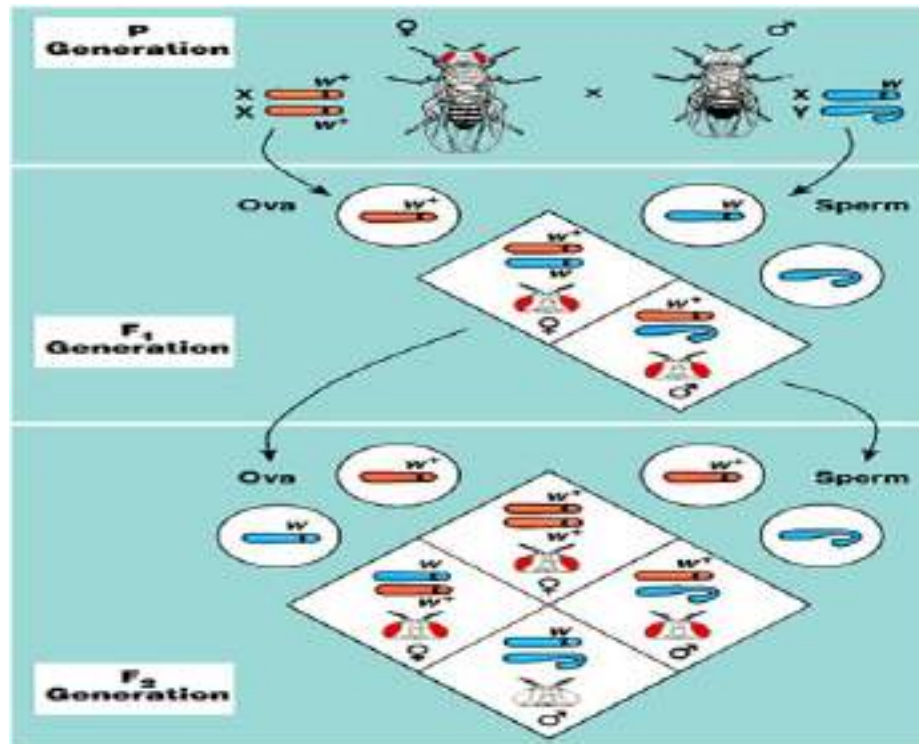

**Morgan's Discovery:** Transmission of X chromosome correlates with inheritance of eye color trait. First solid evidence indicating that a gene is associated with a specific chromosome.

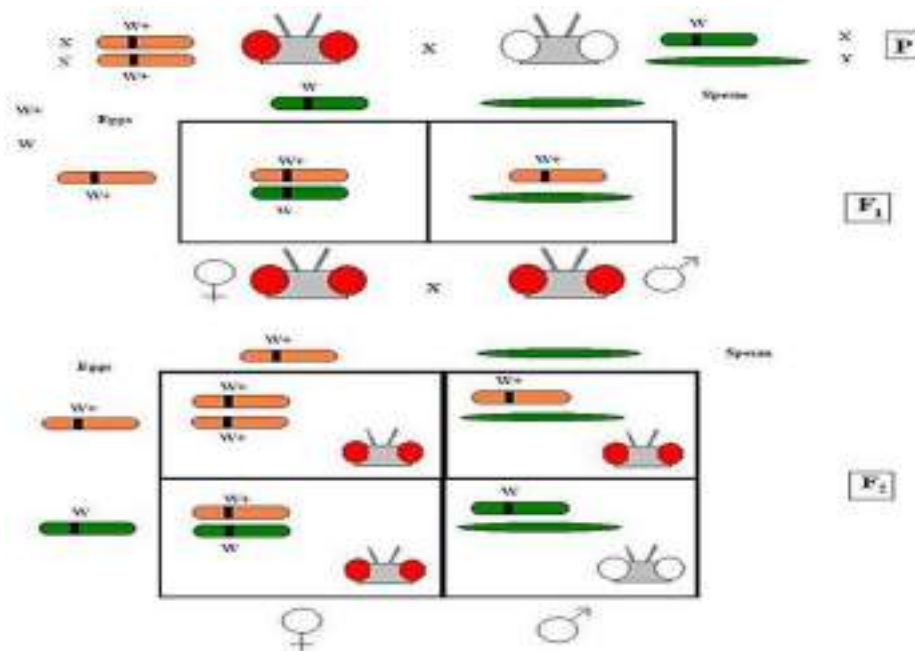

## Lesson 76

### Effect of linkage on inheritance

#### Linked Genes inherit together

- Genes located on the same chromosome, if are linked, will inherit together.

#### Effect of linkage on inheritance

- Morgan did another experiment with fruit flies to see how linkage affects the inheritance of two different characters.
- **body color – wild type gray, mutant black**
- **wing size – wild type Normal, mutant vestigial**



**Wild type (gray body,  
normal wings)**



**Double mutant (black body,  
vestigial wings)**

# CROSS

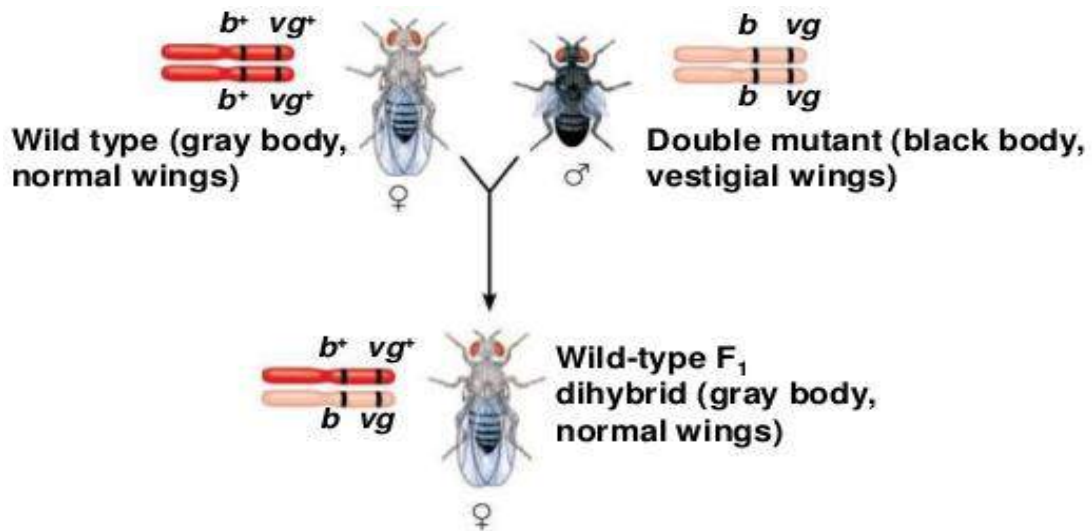

## P Generation (homozygous)

Wild type (gray body, normal wings)

$b^+ b^+ \quad vg^+ \quad vg^+$

F<sub>1</sub> dihybrid (wild type)

$b^+ b \quad vg^+ \quad vg$

Testcross offspring

Double mutant (black body, vestigial wings)

$b \quad b \quad vg \quad vg$

Double mutant

$b \quad b \quad vg \quad vg$

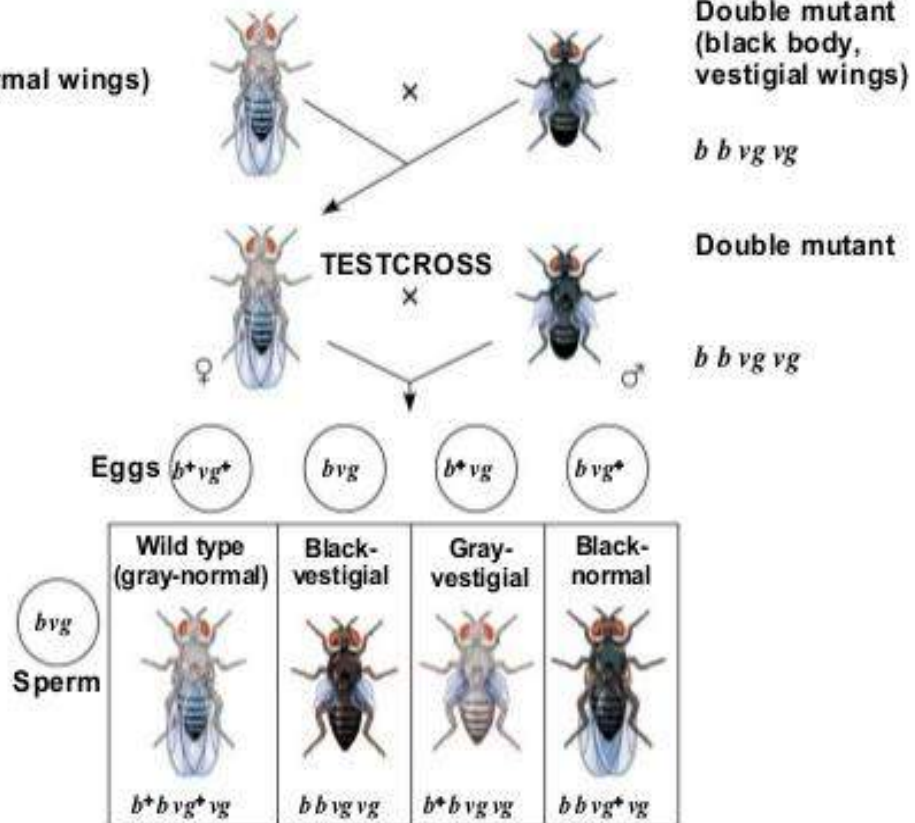



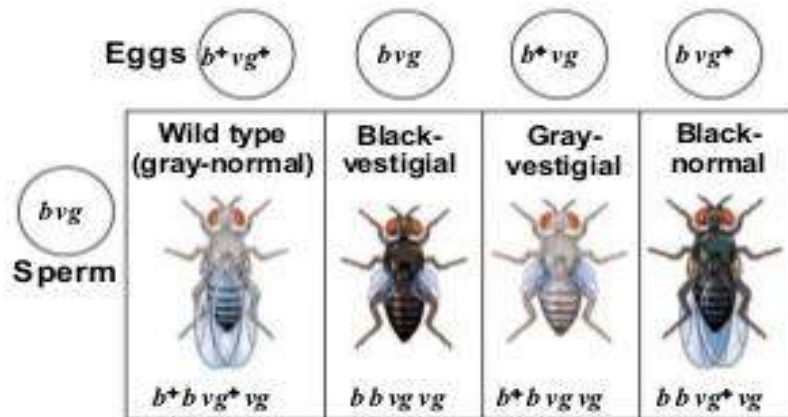

If gene are located on different chromosomes	1 (575)	1 (575)	1 (575)	1 (575)
If genes are located on same chromosomes	1 (1150)	1 (1150)	0	0
Morgan Results	965	944	206	185

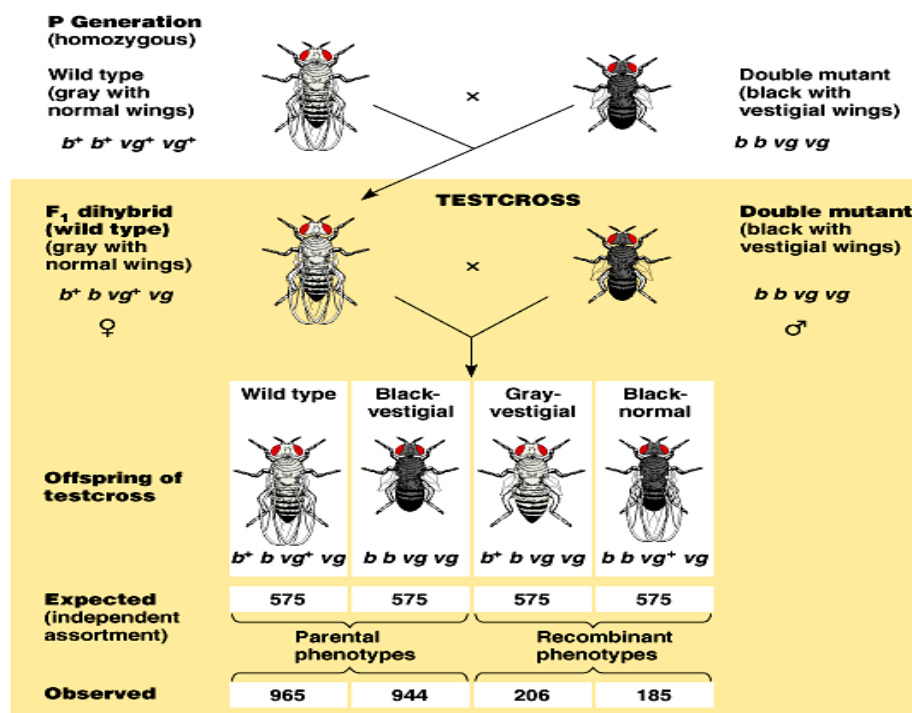

### **Results -linkage and cross over**

- According to independent assortment, four phenotypes in 1:1:1:1 ratio.
- Observed large number of wild-type and double-mutant flies.

### **Morgan reasoned**

- Body color and wing shape are inherited together because their genes are on the same chromosome.
- New phenotypic variations --- crossing over and linkage that break the genes physical connection.

## Lesson 77

### Linkage map

- Linkage map is an ordered list of the genetic loci along a particular chromosome.
- A map of the genes on a chromosome based on linkage analysis.

### Linkage map does not show physical distance

- A linkage map does not show the physical distances between genes but rather their relative positions, as determined by how often two gene loci are inherited together.

### Position of genes in terms of recombination frequency

- A linkage map is a genetic map of a species that shows the position of its known genes or genetic markers relative to each other in terms of recombination frequency.

### Linkage mapping used for identifying location of diseased genes

- Linkage mapping is critical for identifying the location of genes that cause genetic diseases.

### Genetic map is based on recombination frequencies

- A genetic map is a map based on the frequencies of recombination between markers during crossover of homologous chromosomes.

### Greater frequency more distance

- The greater the frequency of recombination (segregation) between two genetic markers, the further apart they are assumed to be.

### Markers used

- Microsatellites
- Restriction fragment length polymorphisms (RFLPs).

## Lesson 78

### Linkage map of drosophila chromosome

#### Linkage map

- A linkage map is a genetic map of a species that shows the position of its known genes or genetic markers relative to each other in terms of recombination frequency.

#### Frequency of recombinant offspring reflect the distance

- Frequency of recombinant offspring reflected distances between genes on chromosomes.

#### Greater the distance, more chances of cross over

- The greater the distance between two genes, the more points between them where crossing over can occur.

#### Sturtevant used recombination frequencies to map position

- He used recombination frequencies from fruit fly crosses to map the position of genes along chromosomes.

#### Test cross designed to map three genes

- The test cross design to map the relative position of three fruit fly genes, body color (b), wing size (vg), and eye color (cn).

## Linkage map

- Recombination frequency between *cn* and *b* is 9%
- Between *cn* and *vg* is 9.5%
- Recombination frequency between *b* and *vg* is 17%

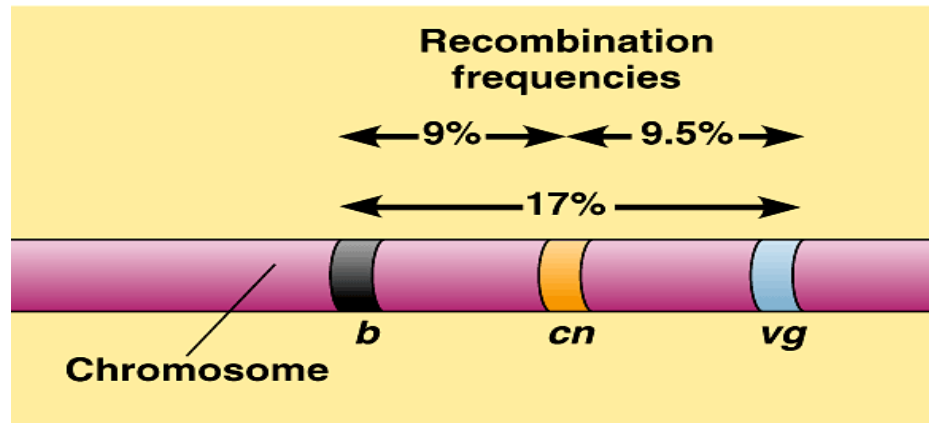

## Eye color gene between the two others

- The only possible arrangement of these three genes places the eye color gene between the other two.

## Linkage map of drosophila chromosome 2

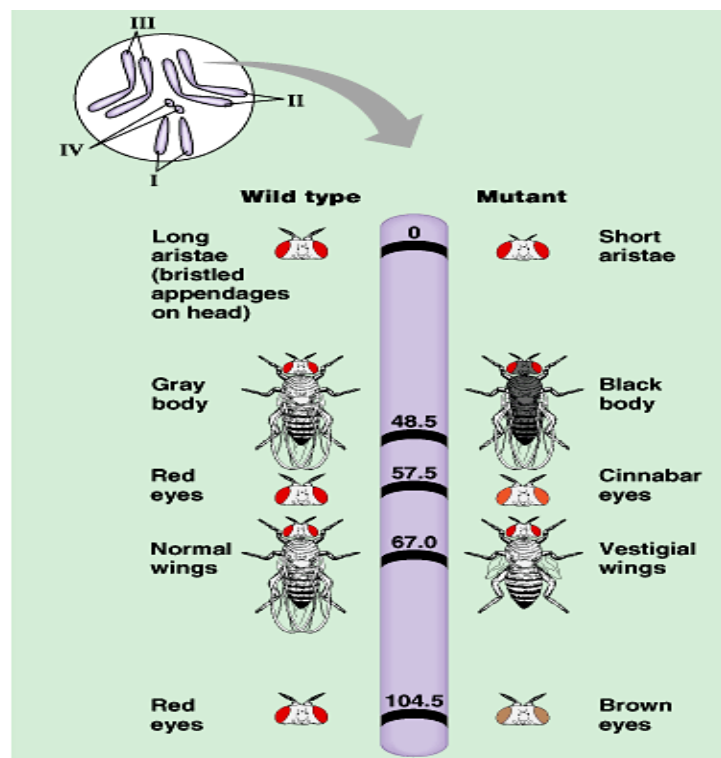

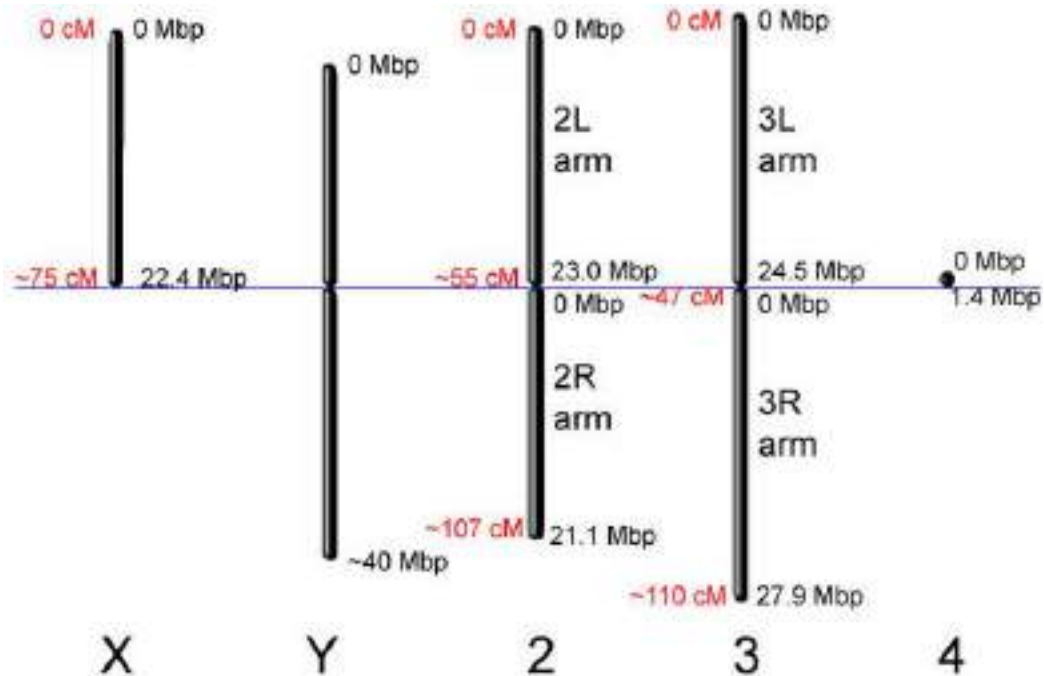

### Drosophila Chromosome Map

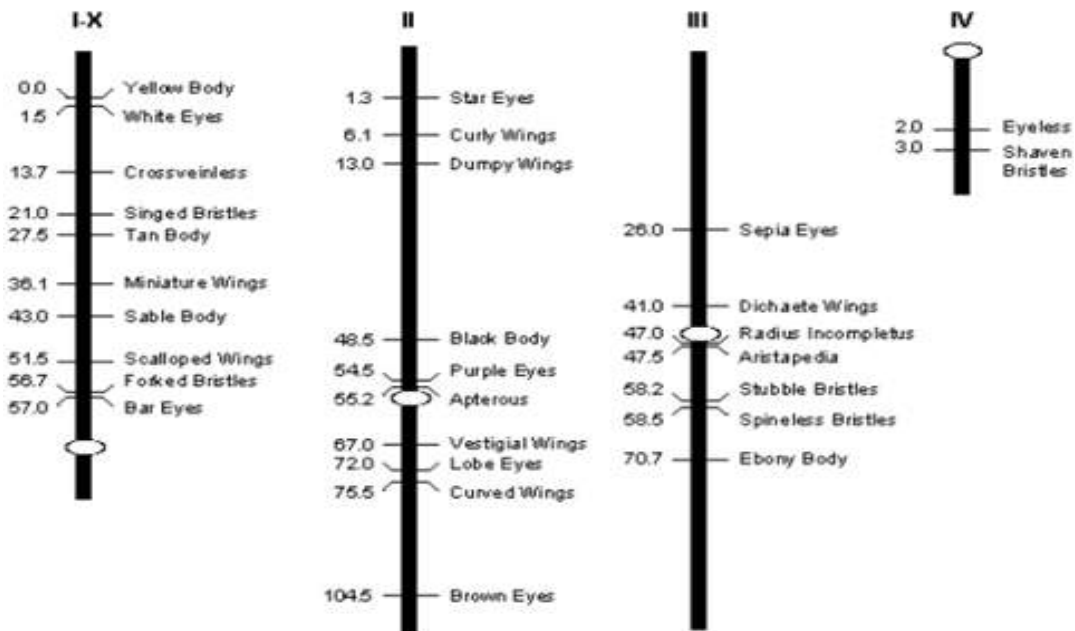

### Map Units – CentiMorgan

- Sturtevant expressed distance between genes - as map units.
- One map unit (1 cM) is equivalent to a 1% recombination frequency.

## **Lesson 79**

### **Sex determination and chromosomes role**

#### **Genetic basis of sex – discovery of sex chromosomes**

- Understanding of genetic basis of sex was with the discovery of sex chromosomes in the early 1900s.

#### **Insects chromosomes**

- Analyses of male and female insect chromosomes.
- Most chromosomes were present in equal numbers in both males and females.
- One /two additional chromosome.

#### **Chromosomal difference is responsible for Sex determination**

- Analyses of other species revealed that chromosomal differences are primarily responsible for sex determination.

#### **Sex determination**

- Chromosomal basis for determining sex
- The X-Y System
- The X-O System
- The Z-W System
- The haploid-diploid System

#### **Sex determination in humans**

- Female homogametic XX
- Male heterogametic XY
- Sex of offspring depends on the sperm has an X or Y

## SRY gene - Y chromosome

- Researchers have found the SRY gene (sex determining region of the Y chromosome)
- In individuals with the SRY gene, the generic embryonic gonads are modified into testes.

## Sex determining region on Y chromosome

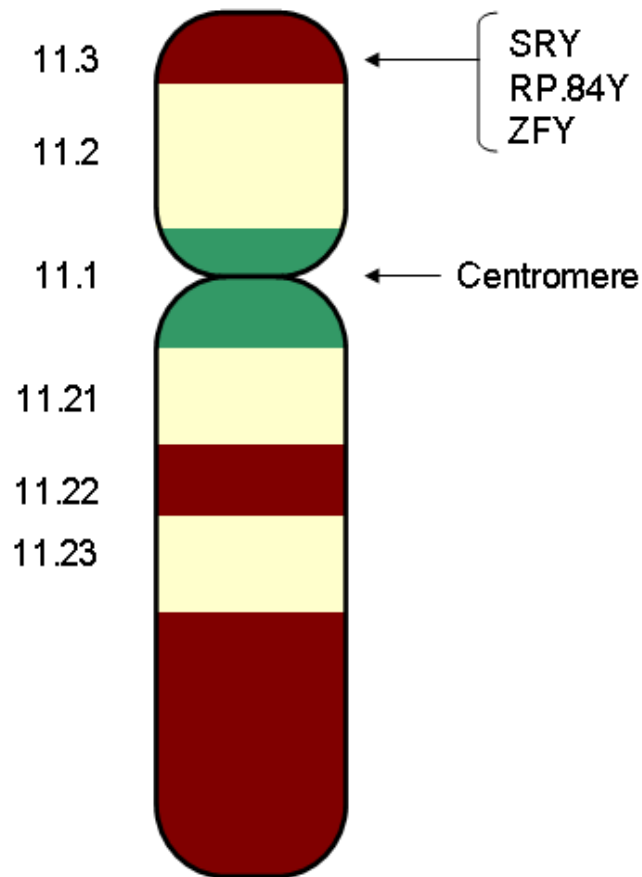

## Other genes on Y chromosome

- In addition, other genes on the Y chromosome are necessary for the production of functional sperms.
- In individuals lacking the SRY gene, the generic embryonic gonads develop into ovaries.



## Lesson 80

### Sex determination systems

#### X-O System

- In insects, only one type of chromosome.
- Females XX, Males XO
- Sex of offspring, sperm X or O

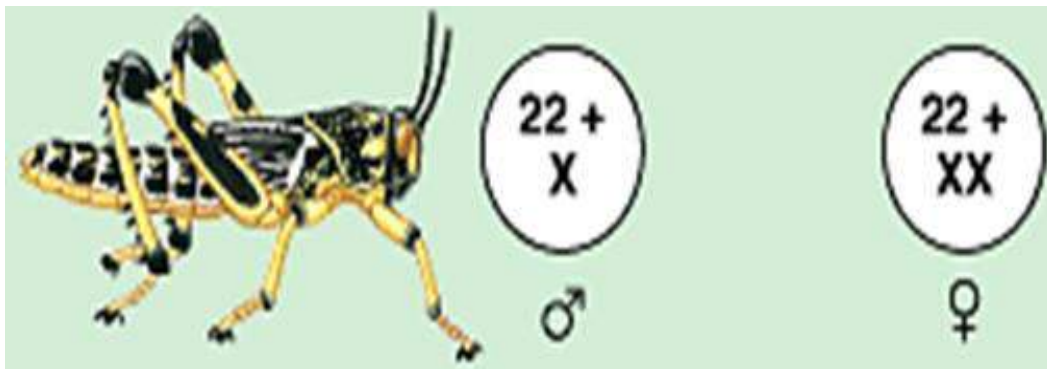

#### Z-W System

- In birds, some fishes and some insects.
- Females ZW, Males ZZ.

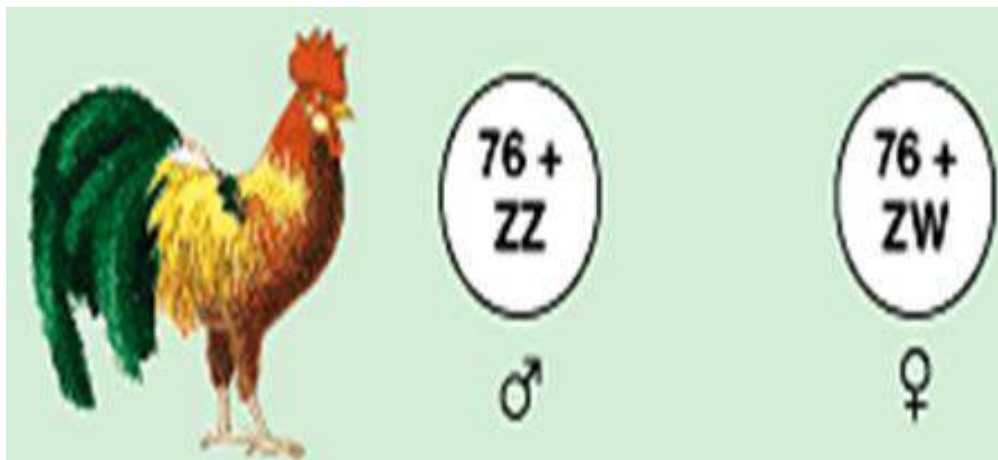

## Haploid-diploid

- No sex chromosomes in most species of ants and bees.
- Females fertilized ova diploid
- Males unfertilized ova haploid

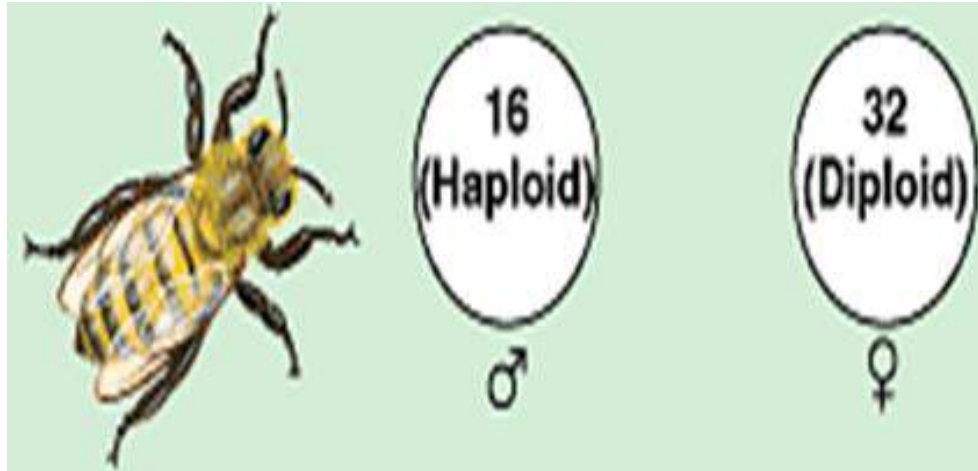

## Sex Determination - Conclusion

- Different organisms have different systems of sex determination.

## Lesson 81

### Sex linked genes

#### Inheritance of sex linked genes

- A gene located on either sex chromosome a sex-linked.
- The sex chromosomes have genes for many characters unrelated to sex.

**Father with disorder will transmit the mutant allele to all daughters but to no sons**

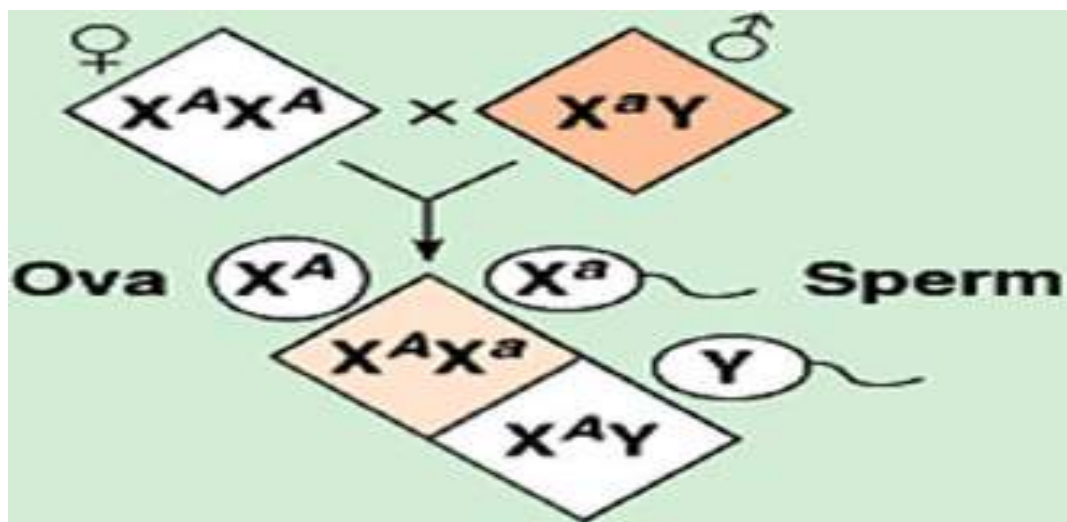

**Carrier female mates normal male, 50% chance that each daughter will be a carrier; 50% chance that each son will have the disorder.**

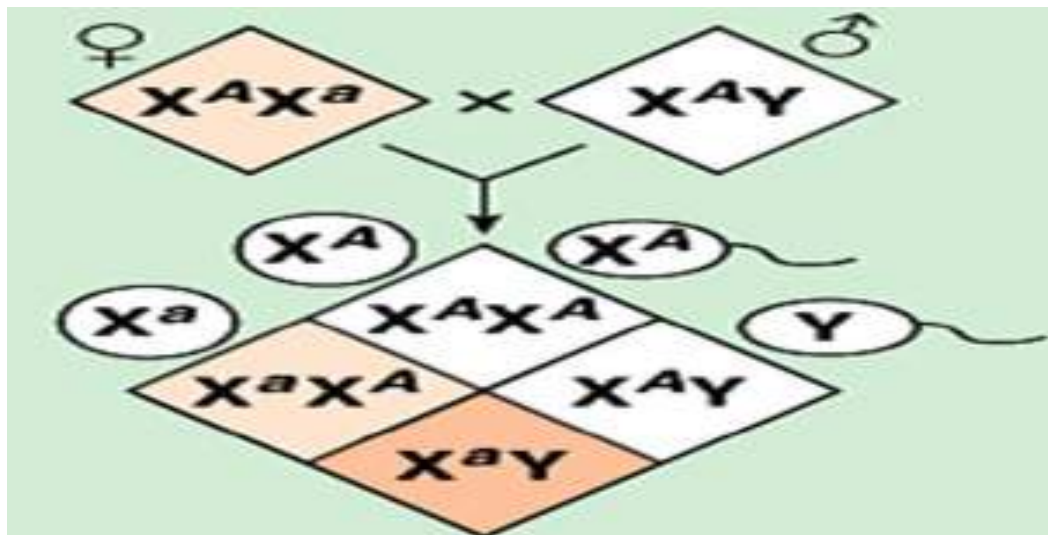

If a carrier female mates a male with disorder, 50% chance that each child born with disorder, regardless of sex.

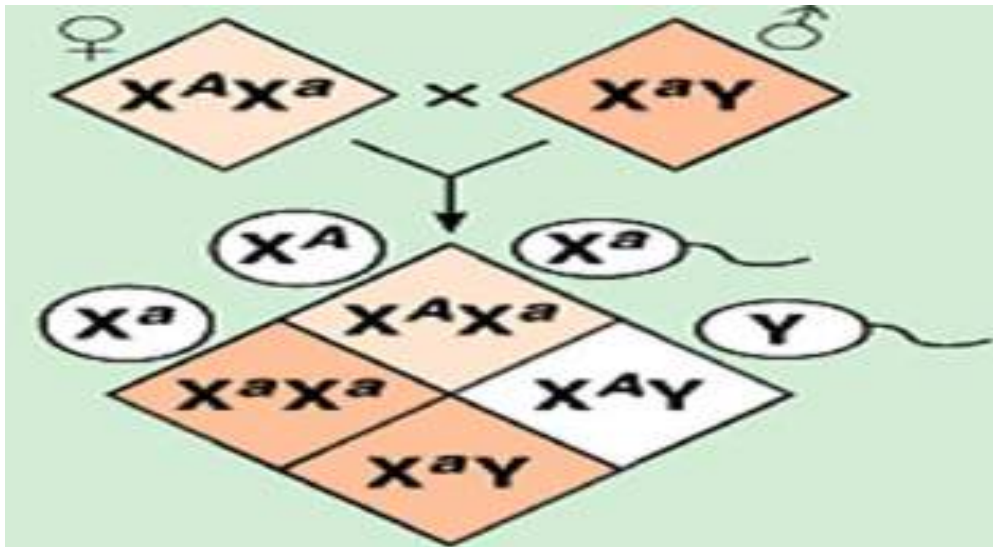

### Human Sex linked Disorders

- Color blindness
- Duchenne muscular dystrophy
- Hemophilia

## Color Blindness

- Normal Female XX, Normal male XY
- Color Blind  $X^cX^c$ , Carrier  $X^cX$ , Color Blind Male  $X^cY$

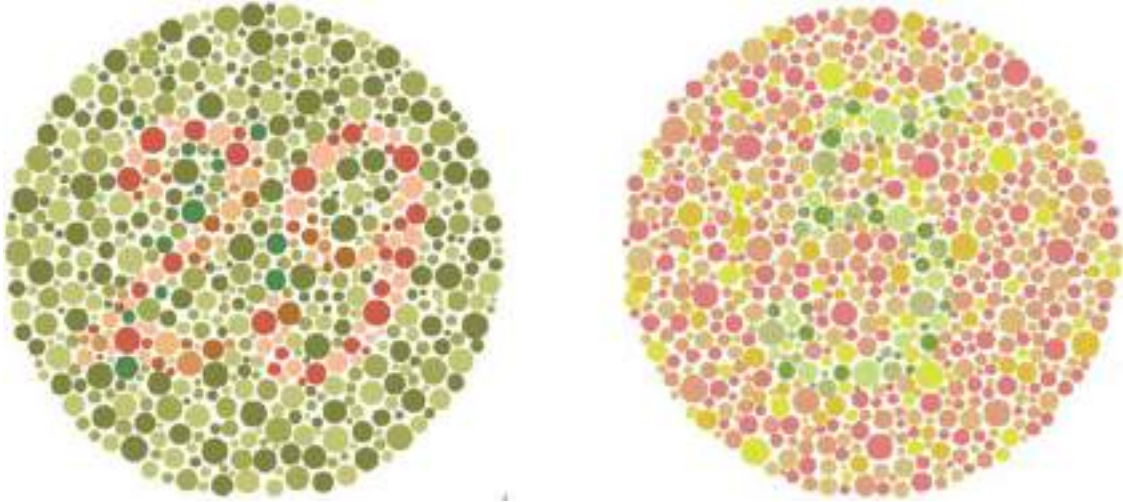

### Normal Father, Color Blind Mother

- All daughters are carriers, sons are color blind.

	X	Y
$X^c$	X $X^c$	X $X^c$
$X^c$	X $X^c$	$X^c$ Y

### Normal Mother, Color Blind Father

- All daughters are carriers, sons are normal

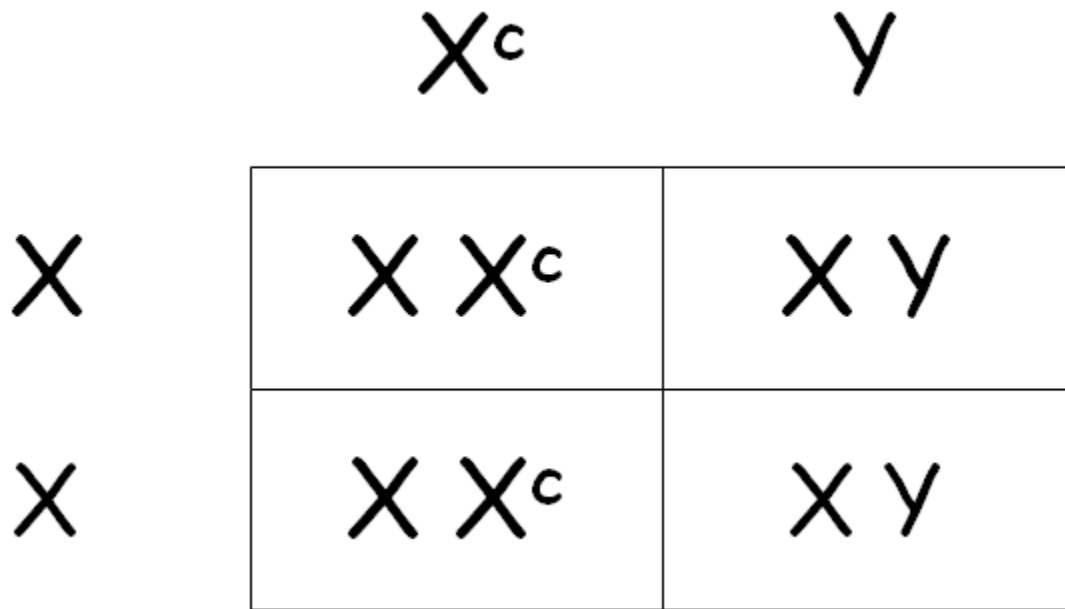

### Sex linked genes/traits

- A gene located on either of sex chromosome is called sex-linked and traits are called as sex-linked traits.

## Lesson 82

### Genetic mapping in humans

#### Genetic mapping

- Genetic mapping - also called linkage mapping provides clues about which chromosome contains the gene and precisely where it lies on that chromosome.

#### Single gene disorders identified

- Genetic maps have been used successfully to find the single gene responsible inherited disorders, like cystic fibrosis and muscular dystrophy.

#### How genetic mapping performed

- To produce a genetic map, researchers collect blood or tissue samples from family members where a certain disease or trait is prevalent.

#### How genetic mapping performed

- Scientists isolate DNA from samples and examine it for the unique patterns of bases.
- Molecular techniques are referred to as genotyping polymorphisms or markers.

#### Dna markers help in location of genes

- Before researchers identify the gene responsible for the disease or trait, DNA markers can tell them roughly where the gene is on chromosome.

#### More markers increases chance of linkage

- The more DNA markers there are on a genetic map, the more likely it is that one will be closely linked to a disease gene.

#### Types of Genetic markers

- Several different types of genetic markers, the type most used on genetic maps is known as a microsatellite and SNPs.

## Genetic mapping in humans

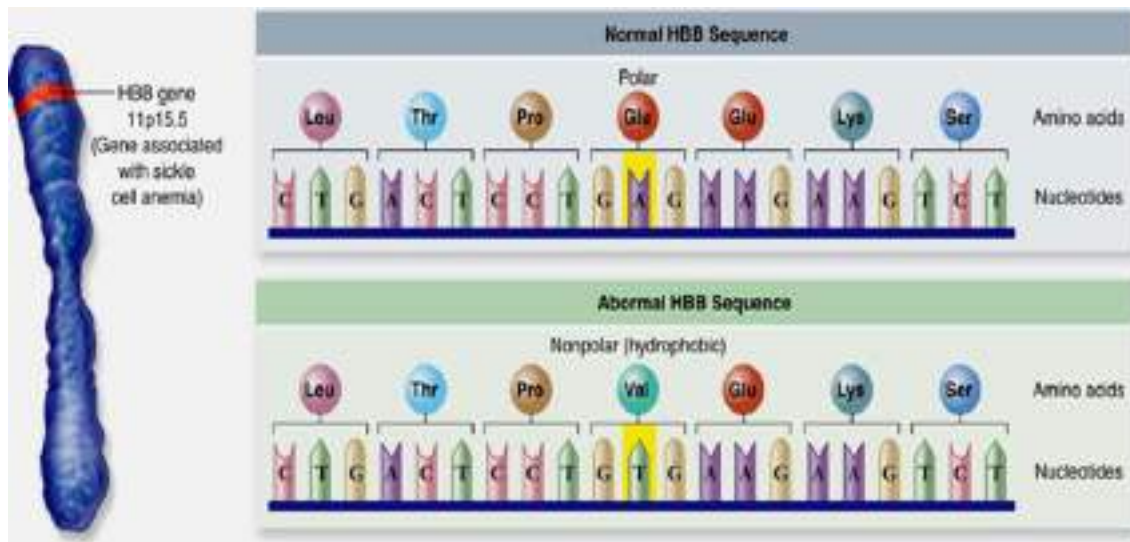

## Genetic mapping provide clues about location of genes

- Genetic mapping provides clues about the location of genes on chromosomes.



## Lesson 83

### Multiple alleles

- Three or more alternative forms of a gene (alleles) that can occupy the same locus/position on a chromosome.

### Genes have specific loci on chromosomes

- According to chromosomal theory of inheritance, genes have specific loci/position on chromosomes.

### Diploid individuals have two alleles

- Diploid individuals have two alleles, one on each of the homologous chromosome.

### All genes do not have two forms

- All genes do not have two forms; many have multiple alleles or multiple forms.
- ABO blood groups

### Mono-allelic, di-allelic and poly-allelic

- 30% genes in humans are di-allelic - they exist in two forms.
- 70% are mono-allelic; they exist only in one form.
- Few are poly-allelic.

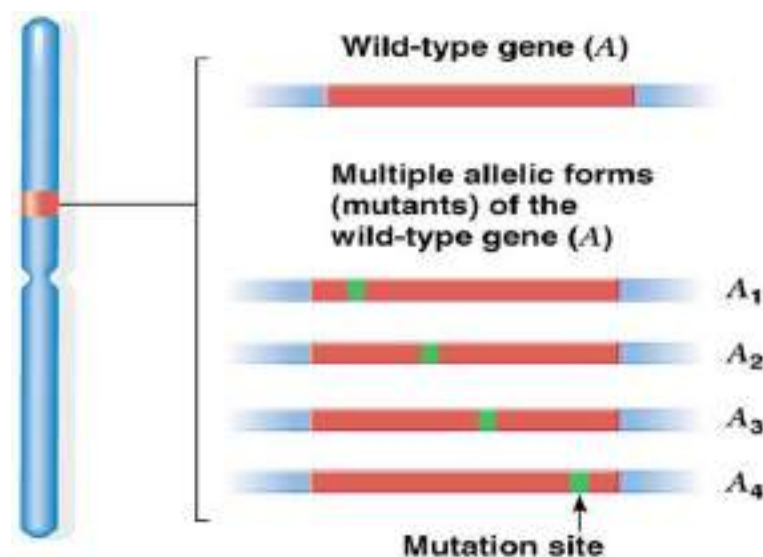

## **Multiple alleles**

### **Poly-allelic genes are tissue specific**

- Poly-allelic genes are usually associated with tissue types.
- These genes are so varied that they provide us with our genetic finger print.

### **Number of alleles - number of genotypes**

- Di-allelic genes can generate 3 genotypes.
- Genes with 3 alleles can generate 6 genotypes.
- Genes with 4 alleles can generate 10 genotypes.

### **Multiple alleles - conclusion**

- Three or more alternative forms of a gene (alleles) that can occupy the same locus/position on a chromosome.

## Lesson 84

### Multiple alleles - blood groups

#### Abo blood system

- Controlled by a tri-allelic gene.
- Allele A, Allele B, Allele i
- Generate 6 genotypes.

#### Two of the alleles are co-dominant to each other

- Two of the alleles are codominant to one another.
- Both are dominant over the third allele.
- Allele A and Allele B when exist together will be co- dominant.

#### Alleles control the production of antigens



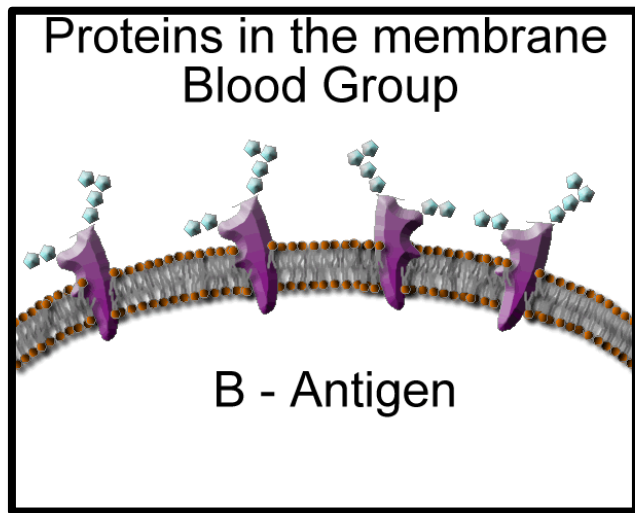
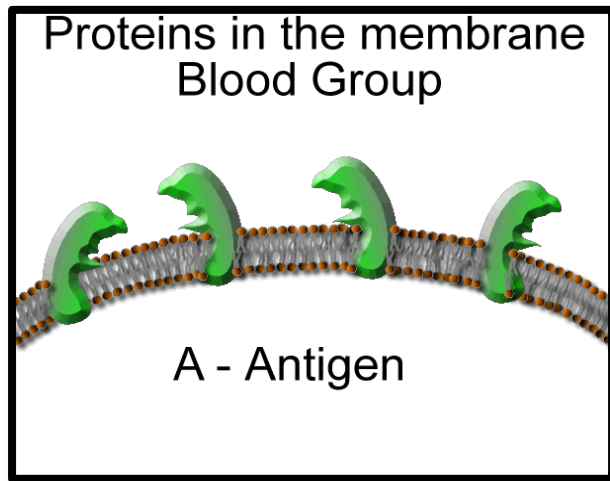
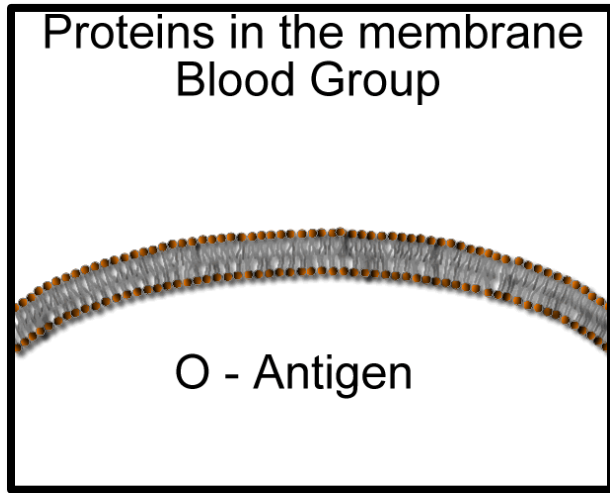

- The alleles control the production of antigens on the surface of the red blood cells.

#### Alleles and antigens

- Allele  $I^A$  produces antigen A
- Allele  $I^B$  produces antigen B
- Allele i produces no antigen



## Alleles and antigens

$I^A I^A$ or $I^A i$	A	
$I^B I^B$ or $I^B i$	B	
$I^A I^B$	AB	
$ii$	O	

## Blood group

6 Genotypes	4 Phenotypes (blood group types)
$I^A I^A$	A
$I^A I^B$	AB
$I^A i$	A
$I^B I^B$	B
$I^B i$	B
$ii$	O

**Blood groups exists in homo and hetero forms**

- Blood type A - homozygous and heterozygous.
- Blood type B - homozygous and heterozygous.
- Blood types AB and O have only one genotype each.

**Blood groups system - conclusion**

- Controlled by a tri-allelic gene.
- Four major blood groups – can be positive – negative based on Rh factor.

## Lesson 85

### Blood groups and Transfusions

Immune system– self and non-self

- Blood types vary and your immune system recognizes your own blood type as being self.
- Other blood group types are recognized as non-self.
- Type A produce antibodies to agglutinate cells which carry Type B antigens. They recognize them as non-self
- The opposite is true for Type B.

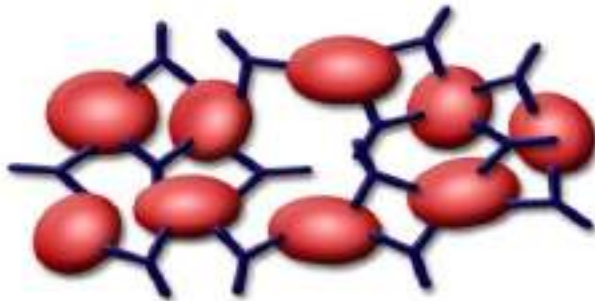

### Blood group type o, do not carry any antigens

- Neither of these people will agglutinate blood cells which are Type O.
- Type O cells do not carry any antigens for the ABO system.

### Universal – donor and recipient

- Type O blood may be transfused into all the other types = the universal donor.
- Type AB blood can receive blood from all the other blood types = the universal recipient.

		Recipient			
		A	B	AB	O
Donor	A				
	B				
	AB				
	O				

	= Agglutination
	= Safe transfusion

### Donor-recipient compatibility

- Person with Type A (Heterozygous) married a person Type B (Heterozygous) blood. genotypes and phenotypes ?

$I^A i \times I^B i$

Genotypic Ratio:

$I^A I^B \quad I^A i \quad I^B i \quad ii$

Phenotypic Ratio:

AB : A : B : O

	$I^A$	$i$
$I^B$	$I^A I^B$	$I^B i$
$i$	$I^A i$	$ii$



If a cross between a person with type O with heterozygous type B, what would be genotypic and phenotypic ratio

$ii \times I^B i$

**GENOTYPIC RATIO**

$I^B i : ii$

**Phenotypic Ratio**

**B : O**

	<b>i</b>	<b>i</b>
<b>I<sup>B</sup></b>	<b>I<sup>B</sup>i</b>	<b>I<sup>B</sup>i</b>
<b>i</b>	<b>ii</b>	<b>ii</b>

### **Blood groups- conclusion**

- Immune system recognized the blood as self and non-self.

## Lesson 86

### Multiple alleles- rabbits

Multiple alleles In rabbits

- Traits controlled by more than two alleles – multiple alleles.
- Fur color of rabbits – example of multiple alleles.

### Fur color in rabbits

Fur color in rabbits





C = Agouti (dark gray)

$c^{ch}$  = Chinchilla (light gray)

$c^h$  = Himalayan (white with black points)

c = White



Allele			
$C$	$c^{ch}$	$c^h$	$c$
Genotype			
$C^+C^+$	$c^{ch}c^{ch}$	$c^hc^h$	$cc$
Phenotype			
<b>WILD TYPE:</b> Brown fur	<b>CHINCHILLA:</b> Black-tipped white fur	<b>HIMALAYAN:</b> White fur with black paws, nose, ears, tail	<b>ALBINO:</b> White fur
			

### Genotypes of Fur color

- White  $cc$
- Himalayan  $c^hc^h$ ,  $c^hc$
- Chinchilla  $c^{ch}c^{ch}$ ,  $c^{ch}c^h$ ,  $c^{ch}c$
- Gray  $CC$ ,  $Cc^{ch}$ ,  $Cc^h$ ,  $Cc$

### Dominance of alleles

Allele  $C$  dominant to allele  $c^{ch}$

Allele  $c^{ch}$  dominant to allele  $c^h$

Allele  $c^h$  dominant to allele  $c$

### Multiple alleles conclusion

- Traits controlled by more than two alleles.

## Lesson 87

### Alleles and genotypes

#### Number of alleles and number of genotypes

- Genotypes =  $n(n + 1)/2$
- Homozygotes =  $n$
- Heterozygotes =  $n(n - 1)/2$

# alleles	# genotypes	Homozygotes	Heterozygotes
1	1	1	0
2	3	2	1
3	6	3	3
4	10	4	6
5	15	5	10

#### Number of alleles and number of genotypes

$$\text{Genotypes} = n(n + 1)/2$$

$$\text{Homozygotes} = n$$

$$\text{Heterozygotes} = n(n - 1)/2$$

Calculate genotypes for fur color of rabbits, if Four (4) alleles for fur color.

$$\text{Genotypes} = n(n + 1)/2$$

$$\text{Homozygotes} = n$$

$$\text{Heterozygotes} = n(n - 1)/2$$

**Number of alleles and number of genotypes**

- Based on number of alleles, number of genotypes can be calculated.

## Lesson 88

### Linkage and crossing over

#### Linkage

- Genes that are found on the same chromosome are said to be linked genes.
- Linked genes are inherited together.

#### Linkage -genetically failure of segregation

- Genetically linkage is defined as the failure of two genes to assort independently.
- Linkage occurs when two genes are close to each other on the same chromosome.

#### Linkage is based on frequency of crossing over

- Genes far apart on the same chromosome assort independently.
- Linkage is based on the frequency of crossing over between the two genes.

#### Chiasmata formation

- Chiasmata visible on chromosomes are regions of crossing over.
- Occurs between non-sister chromatids.

## Crossing over in prophase I

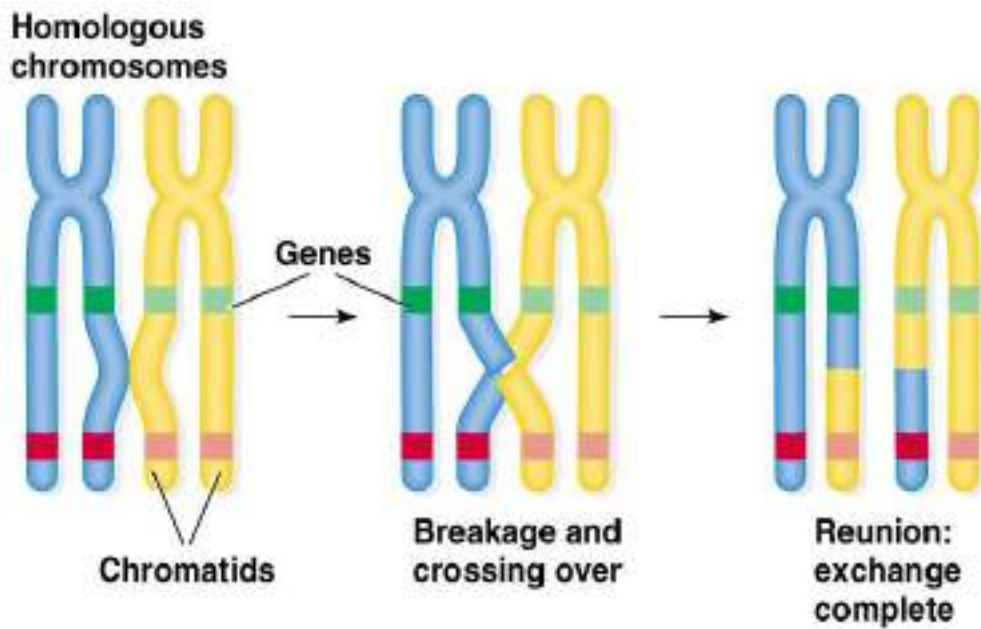
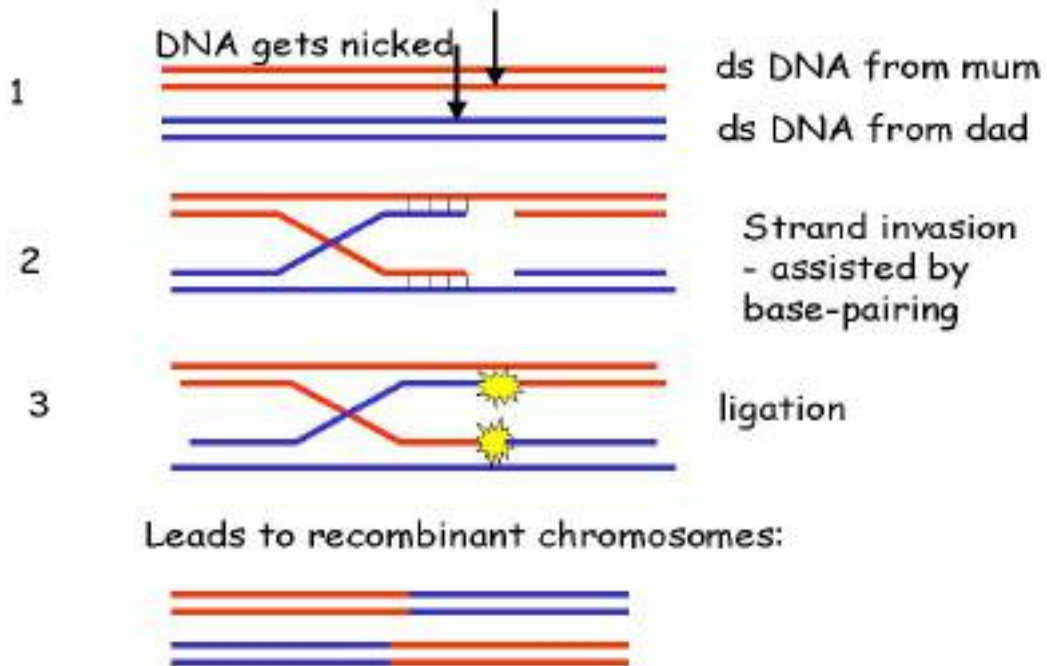

## Crossing over in prophase I

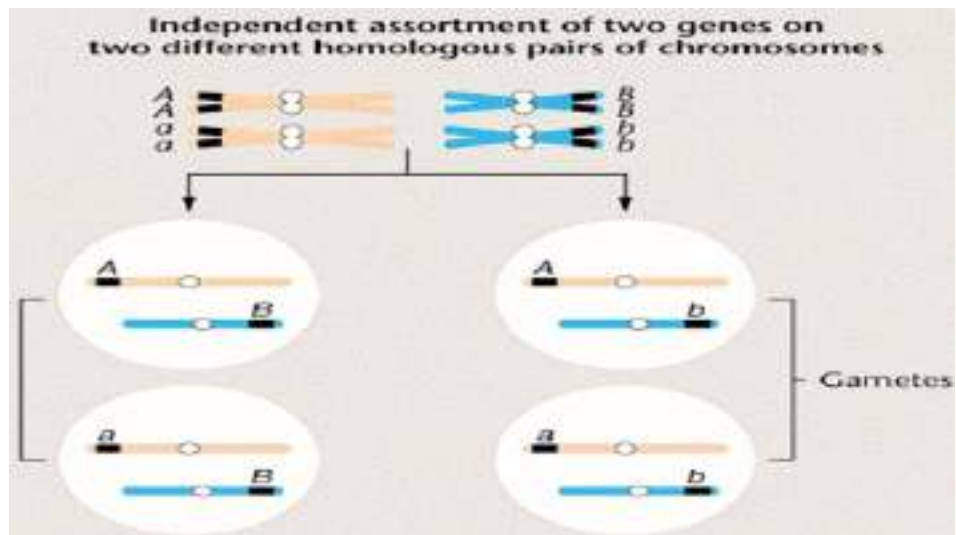

## Crossing over in prophase I

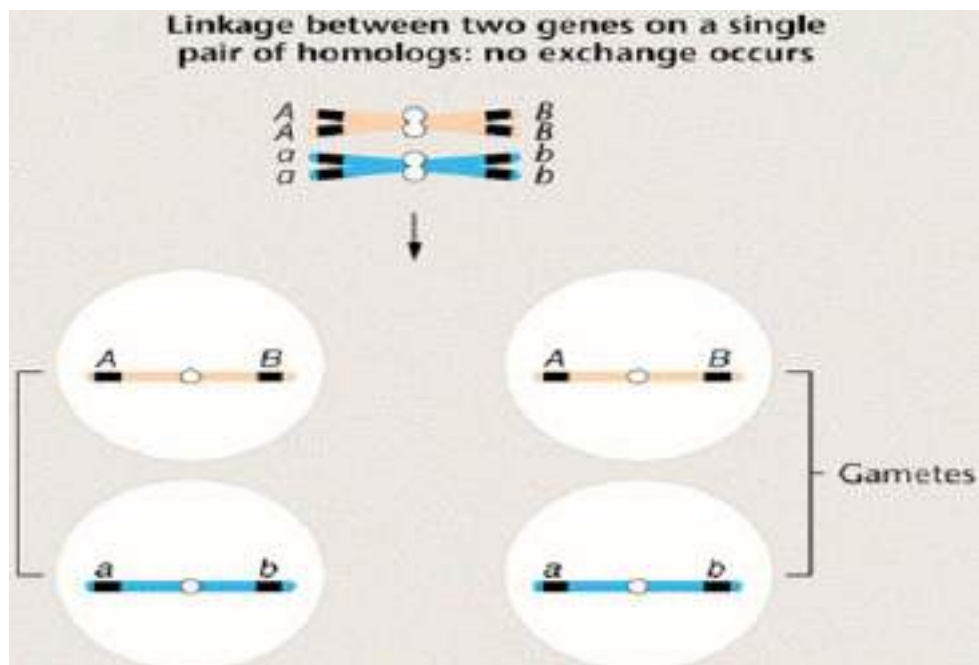



## Genes are linked

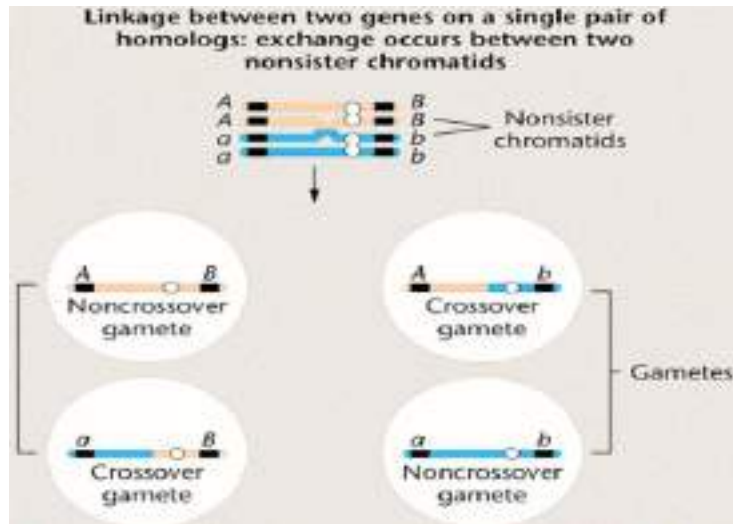

## Exchange between two non-sister chromatids

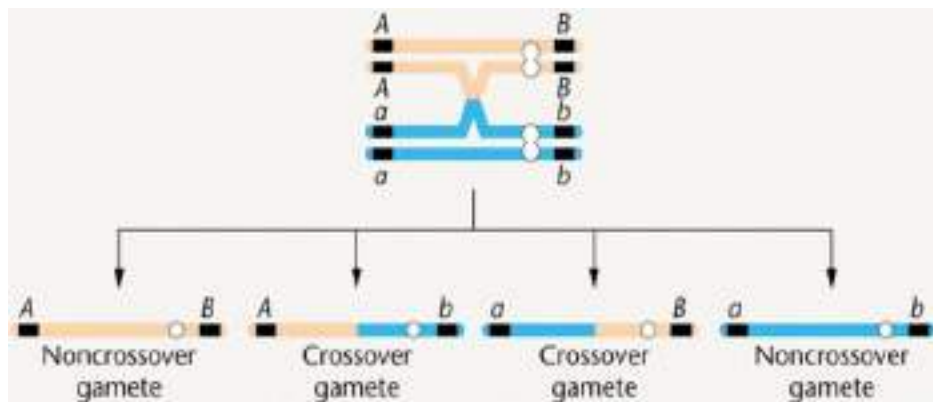

Parental and non-parental gametes

## Linkage and crossing over

- Linkage and crossing over a phenomenon that may be seen during meiosis.

## Lesson 89

### Linked genes

Chromosome mapping

- Genes that are found on the same chromosome are said to be linked genes.
- Linked genes are inherited together.

### Chromosome mapping

- Linkage is defined genetically as the failure of two genes to assort independently.
- Linkage occurs when two genes are close to each other on the same chromosome

### Closer the genes, fewer the cross over

- The closer genes are together on a chromosome, the fewer crossovers will occur.
- Genes farther apart, affected by more crossovers (higher crossover frequency).

### Map units

Crossover value of

- 1% = 1 map unit apart - genes are close together.
- 12% = 12 map units apart - genes are further apart.
- Cross over frequency = Map distance/units.

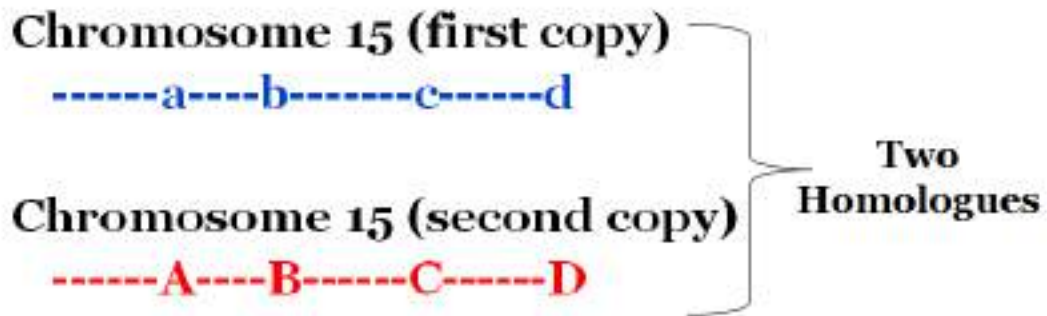

Linkage and linked genes

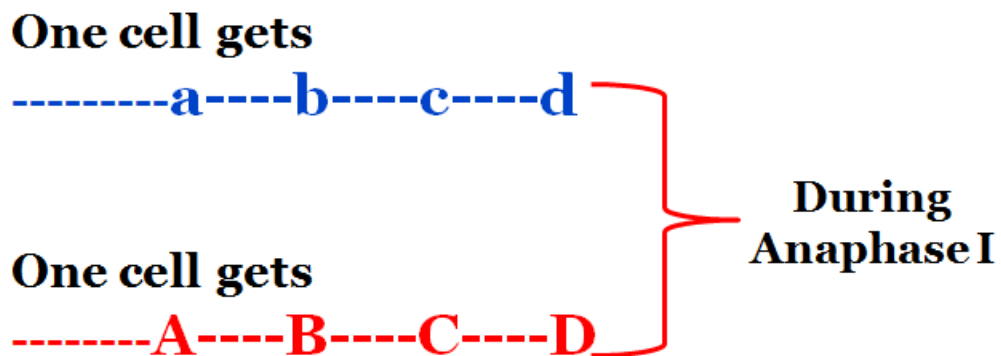

When separated during meiosis linkage

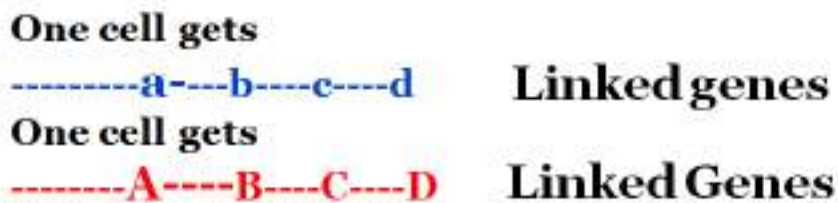

Linked genes inherit together. This phenomenon used for identification of many diseased genes in humans.

## Lesson 90

### Physical mapping

- A physical map is primarily based on the locations of landmarks along a DNA molecule.
- Units of distance are expressed in base pairs or Mbs.

### Different Mapping techniques

- Cytogenetic map
- In situ hybridization
- Genetic mapping
- Restriction enzymes site mapping
- Radiation hybrid mapping

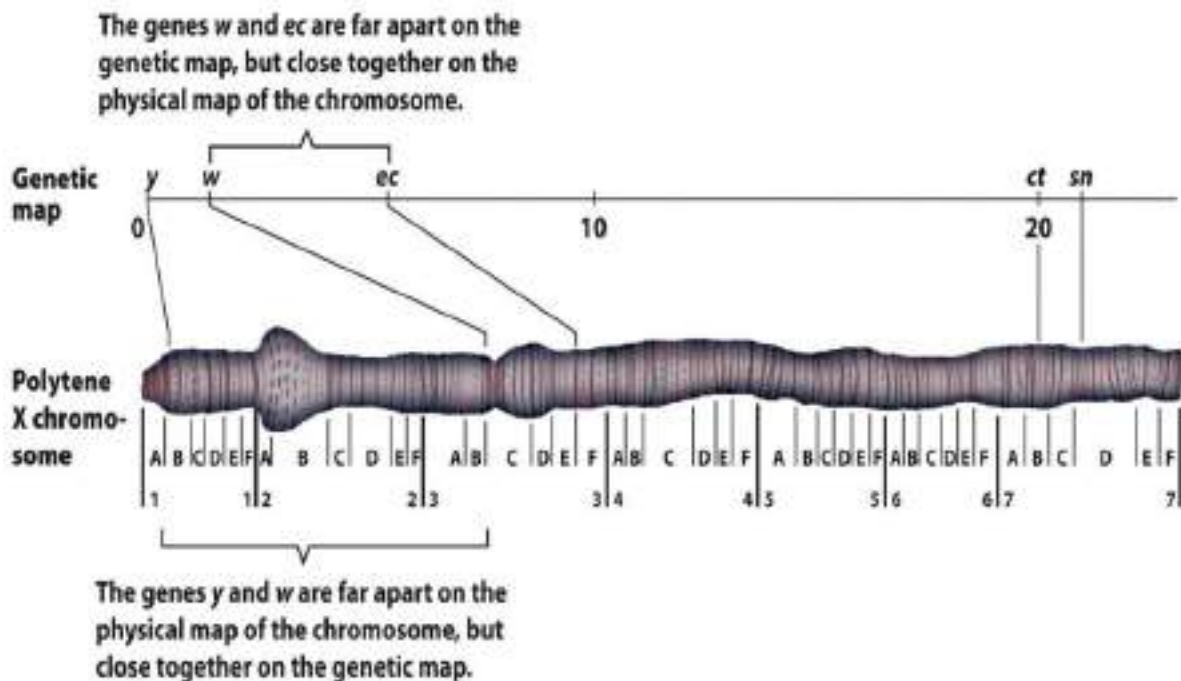

## Physical mapping - Top down

1. Construction of maps of ordered landmarks (genetic markers, genes): provides long-range map and organisation into individual chromosomes.

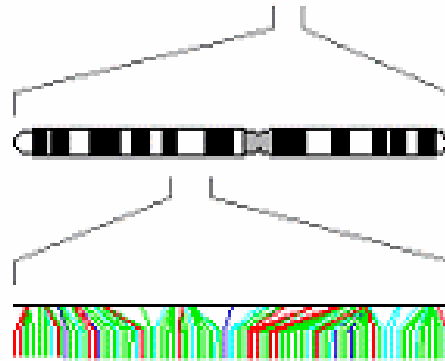

2. Physical maps of overlapping clones anchored to the landmark maps.

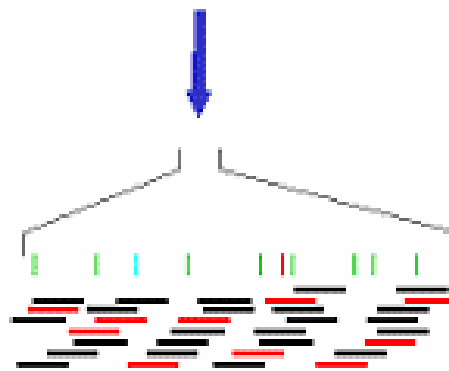

3. Selection of tile path (clones in red)



4. Shotgun sequencing and assembly (for working draft); subsequent directed finishing (for reference sequence).

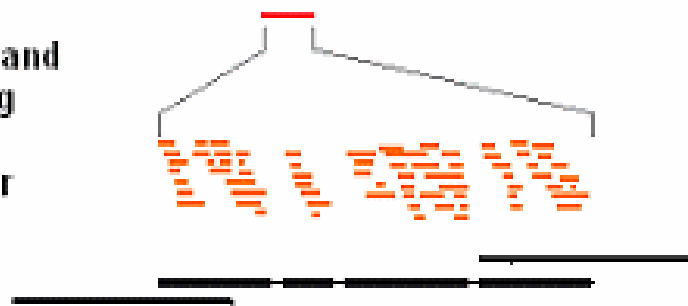

## Top down mapping

- 1 Order large-insert clones by overlapping fingerprints to create a physical map.**

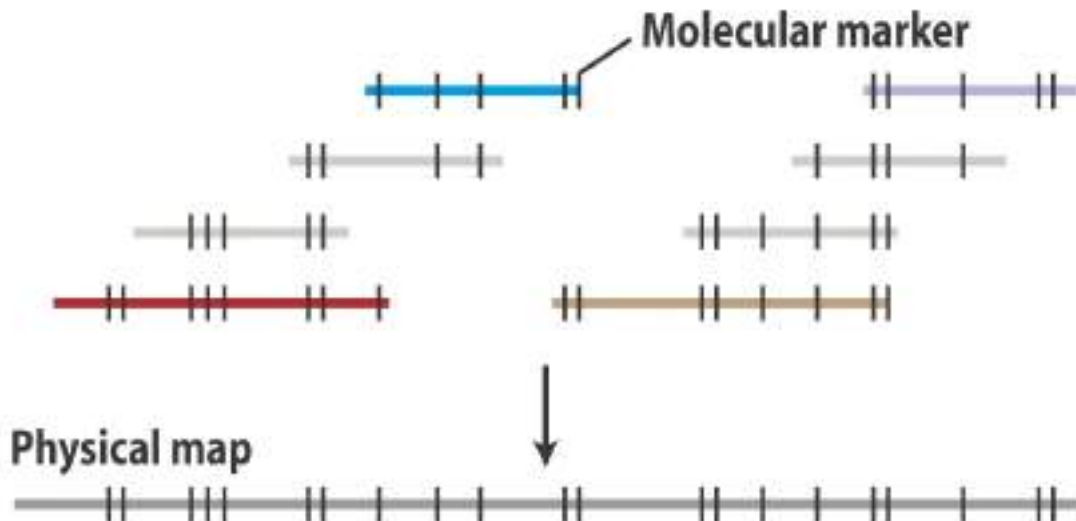

- 2 Select clones with minimal overlap.**



- 3 Divide into subclones.**



- 4 Sequence subclones.**

- 5 Assemble subclones to create the genome sequence.**



## Bottom-up Mapping

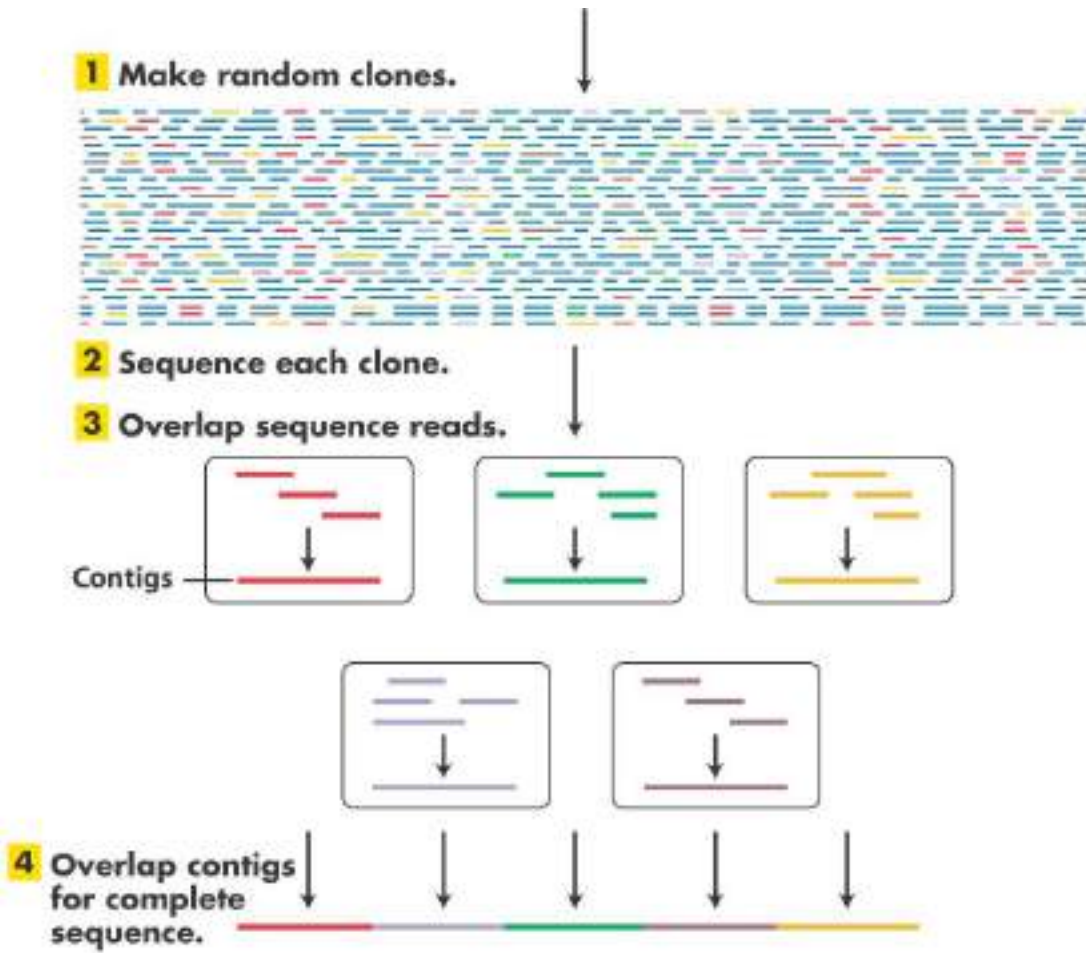

## Physical Mapping

- Physical maps -locations of the genes on genomes.

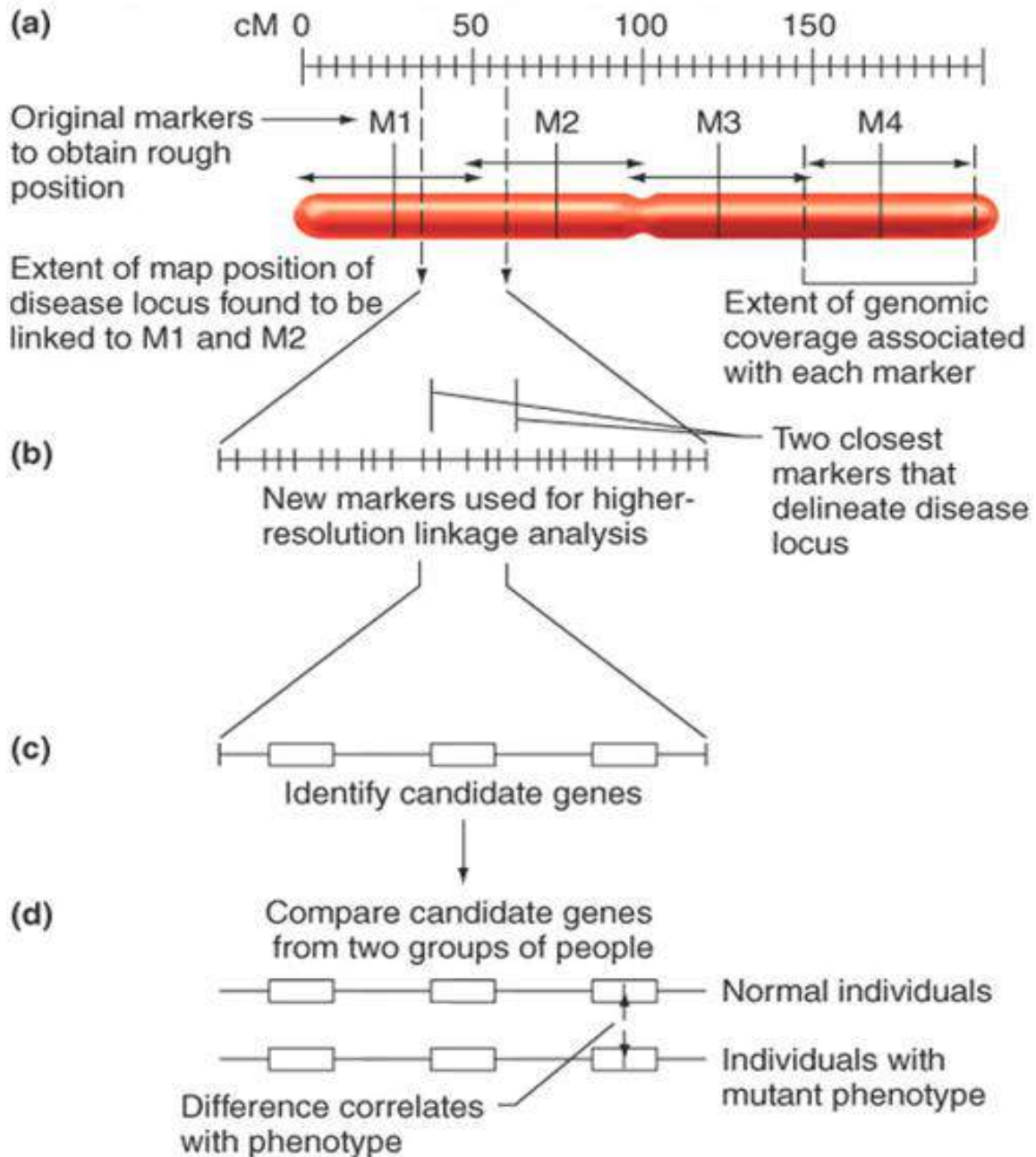



## Lesson 91

### Mapping diseased genes in Humans

Mapping genes in human pedigrees

- Different methods are used to map human chromosomes and to locate the position of genes.

### Mapping human disease gene

- Human pedigrees and DNA typing are used to identify genes.

### Polymorphic markers are used

- Polymorphic DNA sequences are used in human genetic mapping.

### Several methods, Two are common methods

- Position independent
- Position dependent

### Position independent

- Not knowing anything about the location of the gene.
- Starting at the phenotype, determining which protein was involved and then getting to the gene through the protein.
- Forward genetics

### Position dependent

- Starting from the approximate location of the gene, to finding the gene itself.
- Translating it to learn about the protein and its function.

### Position dependent

- Positional cloning or reverse genetics.
- This is the method most used today.

### **Oligonucleotide method**

- Isolating the protein product of the gene.
- Such genes usually produce large amounts of proteins.
- Gene-specific oligonucleotide are prepared.

### **Oligonucleotide method**

- These probes were used with colony hybridization against a cDNA library.
- Positive clones were re-screened with the secondary probe.

### **Antibody method**

- Antibodies against a known protein are produced.
- A library of expressed cDNAs are then screened using the antibody.

### **Positional cloning**

- Disease gene locus is mapped with the help of marker.
- Genes in candidate region are screened by sequencing to identify mutation.
- Protein of identified gene is studied.

### **Different methods**

- Different methods to identify diseased genes

## Lesson 92

**Polygenic inheritance:** Condition when two or more genes influence the expression of one trait. Polygenic inheritance is controlled by multiple genes

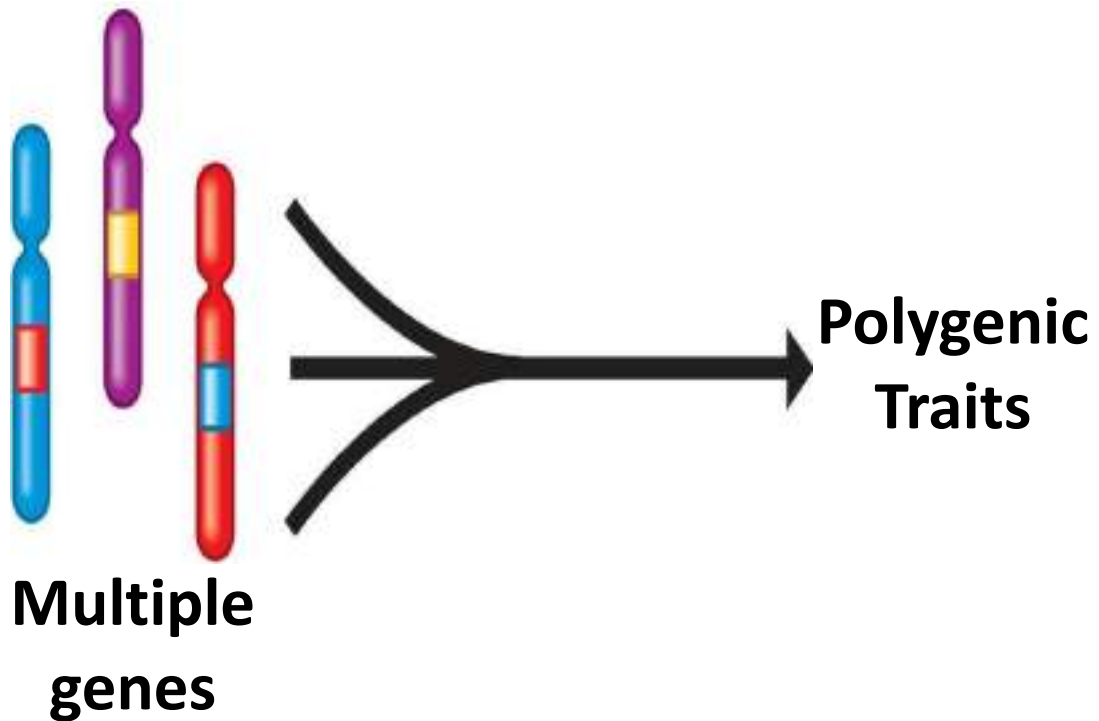

Multiple genes produce a spectrum of resulting phenotypes.

- Skin color, height etc.
- Pepper color
- Gene 1: R= red r = yellow
- Gene 2: Y= absence of chlorophyll; y = presence of chlorophyll



Possible genotypes

- $R-/Y-$  : red (red/no chlorophyll)



- $R-/yy$  : brown/orange (red/chlorophyll)



- $rr/Y-$  : yellow (yellow/no chlorophyll)



- $rr/yy$  : green (yellow/chlorophyll)



Test cross: Try crossing a brown pepper ( $RRyy$ ) with a yellow pepper ( $rrYY$ ). Which trait will your offspring ( $F_1$  generation) produce?

What traits are produced when you cross two of the peppers found in the  $F_1$  generation?

Brown Pepper  $RRyy$ , Yellow pepper  $rrYY$

Polygenic inheritance is a condition when two or more genes influence the expression of one trait.

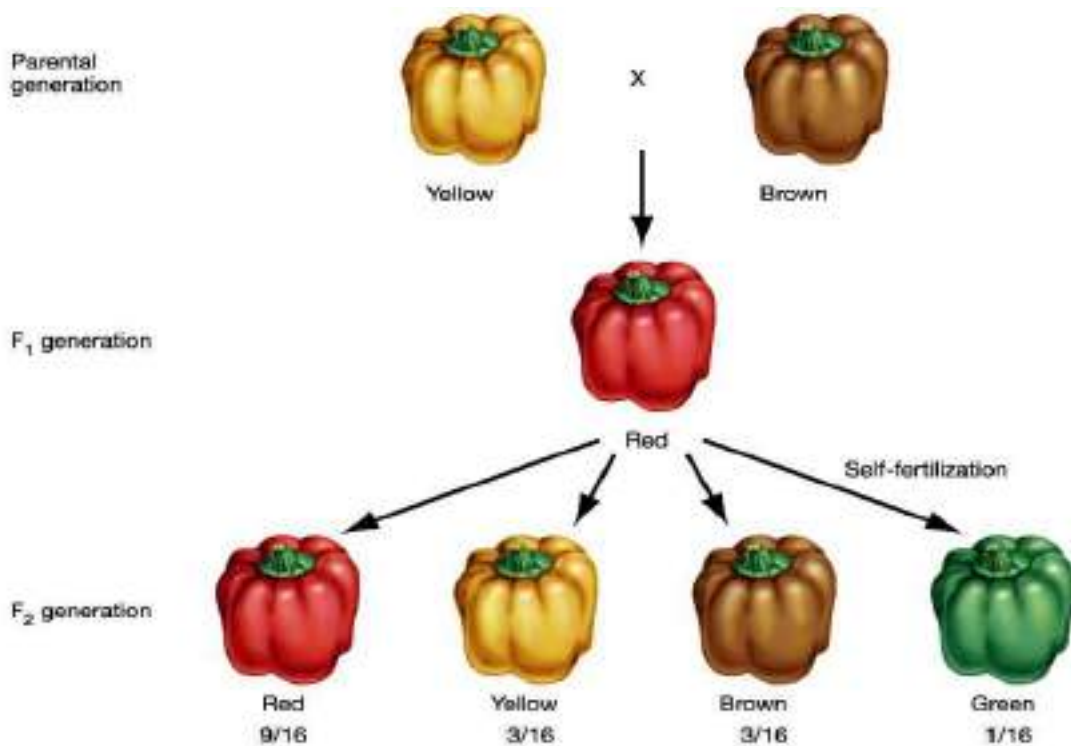

## Lesson 93

**Examples of polygenic traits** Eye color, height, body shape and intelligence. Many of these traits are also affected by the person's environment, so they are called multifactorial.

Polygenic traits, or continuous traits, are governed by alleles at two or more loci, and each locus has some influence on the phenotype. Hair, eye and skin color are polygenic traits.

### Polygenic trait – eye color



### Stature, shape of face, finger prints

- Stature
- Shape of face
- Fingerprint patterns

**Chicken Combs** Four different comb shapes. Comb shape is controlled by two genes found on two different chromosomes.

- Gene 1: R
- Gene 2: P

Four different phenotypes result

- Rose Combs (R-pp)



Rose

Walnut Combs (R-P-)



Walnut

- Pea Combs (rrP-)



Pea

Single Combs (rrpp)



Single

**Hair color** Hair color is controlled by alleles on chromosomes 3, 6, 10, and 18. When more dominant alleles appear in the genotype; the darker will be the hair.



## Lesson 94

**Epistasis and modifier genes** Epistasis is a phenomenon that consists of the effect of one gene being dependent on the presence of one or more modifier genes Type of polygenic inheritance where alleles at one gene locus can hide or prevent expression of alleles at second gene locus.

### Positive epistasis – double mutation

- Double mutation has a fitter phenotype than either single mutation.
- Positive epistasis between beneficial mutations generates improvements in function.

### Negative epistasis – two mutations have smaller effect

- When two mutations together have a smaller effect than expected from their effects when alone, it is called negative epistasis.

**Sign epistasis** occurs when one mutation has the opposite effect when in the presence of another mutation.

**Reciprocal epistasis** occurs when two deleterious genes are beneficial when together.

### Epistasis between genes

- Epistasis within the genomes of organisms occurs due to interactions between the genes within the genome.
- This interaction may be direct if the genes encode for proteins.
- Interaction may be indirect, where the genes encode components of a metabolic pathway or network, developmental pathway.

**Epistasis within genes** when one deleterious mutation can be compensated for by a second mutation within that gene.

**Epistasis** Type of polygenic inheritance where alleles at one gene locus can hide or prevent expression of alleles at second gene locus. There are several types of epistasis.



## Lesson 95

**Recessive Epistasis** Epistatic gene exerts its affect with homozygous recessive genotype.

Petal color in blue-eyed Mary plants Both enzymes active blue; Enzyme 1 active magenta

**Precursor 1 → Precursor 2 → blue anthocyanin**  
**colorless                      magenta**

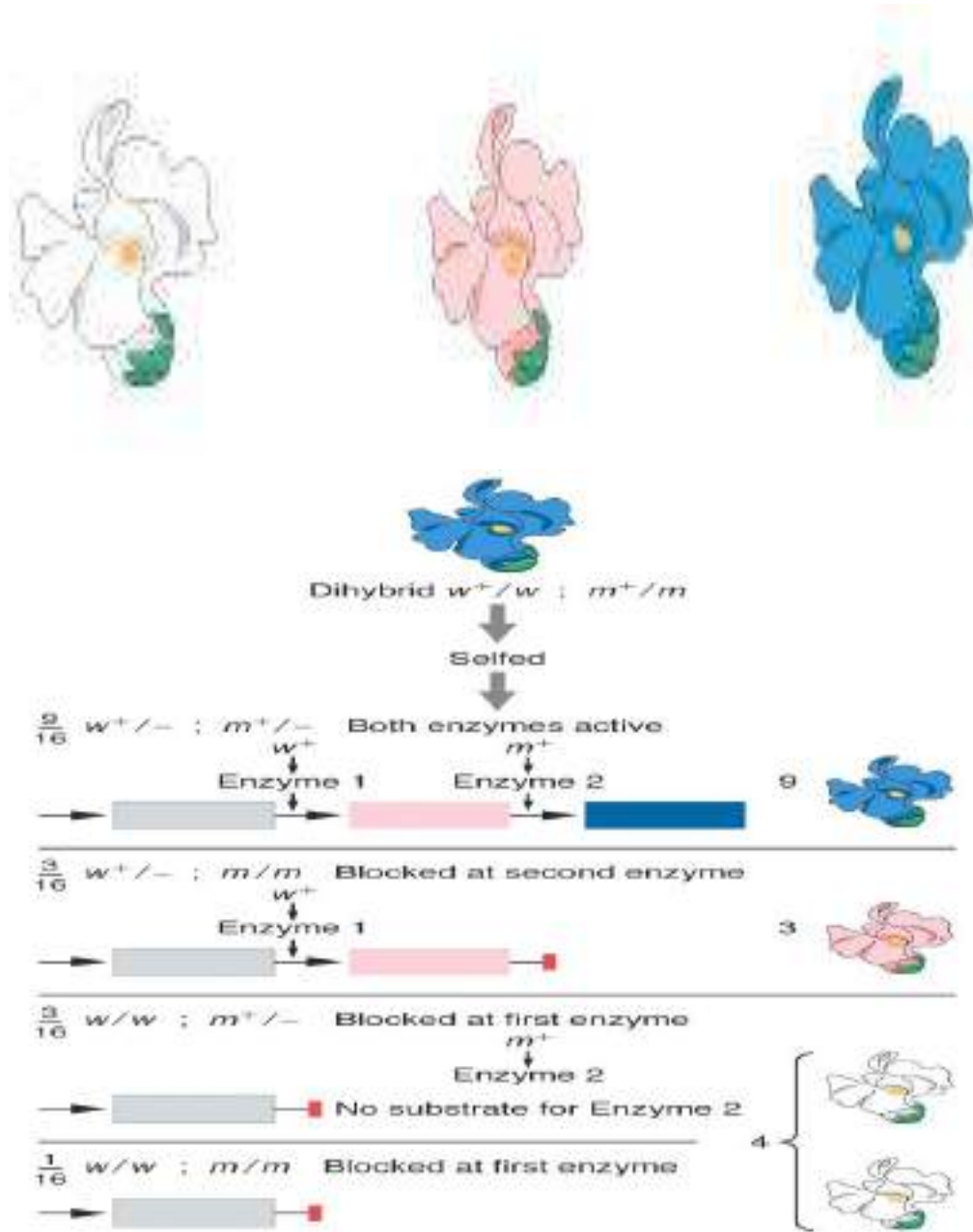

Recessive Epistasis Epistatic gene exerts its affect with homozygous recessive genotype.

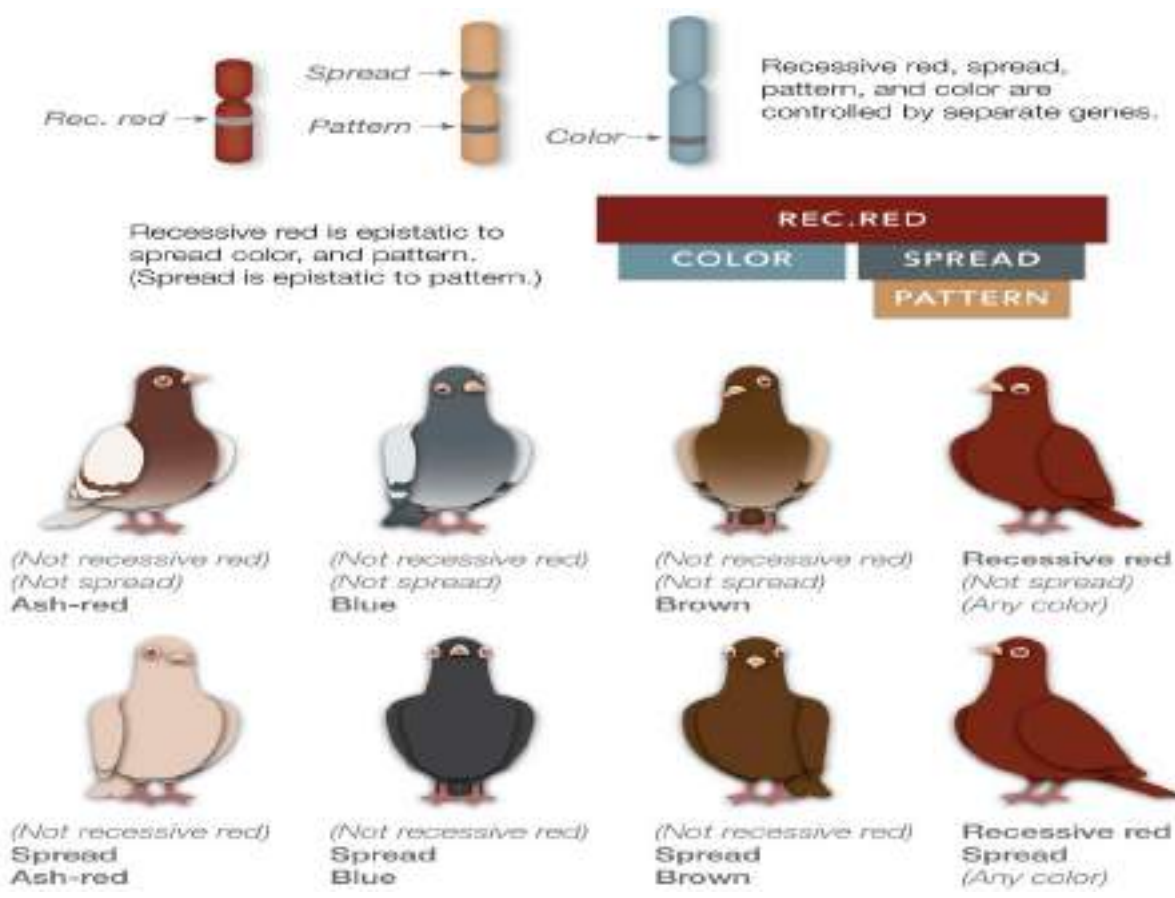

## Lesson 96

### Dominant epistasis

- Epistatic gene exerts its effect with the presence of a dominant allele.
- Dominant epistasis is fruit color in summer squash
- Y = Yellow
- yy = Green
- W inhibits either color = color will be white (dominant)
- w has no effect on color

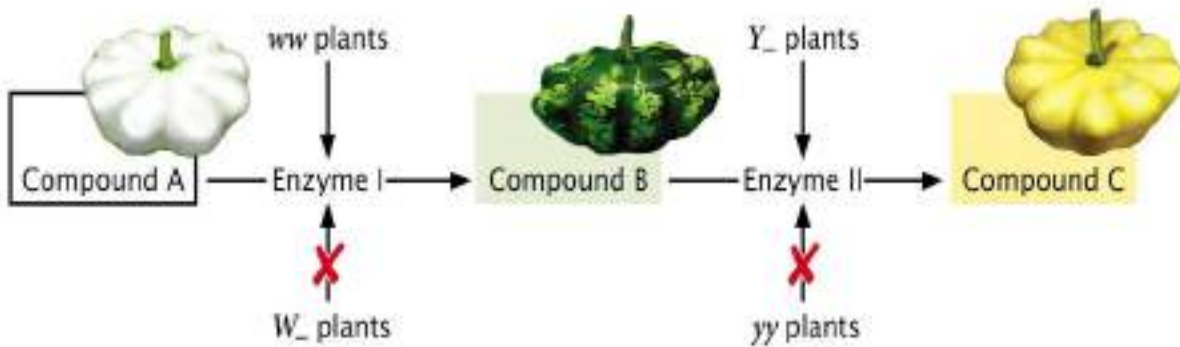

### Dominant Epistasis- ratios

Fruit color in summer squash

$W w Y y \times W w Y y$

9/16  $W \_ Y \_$

3/16  $W \_ yy$

3/16  $ww Y \_$

1/16  $ww yy$

### **Duplicate dominant Epistasis**

Fruit shape in Shepherd's purse

$A\_ \text{ or } B\_ = \text{heart shape}$

$aa \text{ and } bb = \text{narrow shape}$

### **Duplicate dominant Epistasis**

Fruit shape in Shepherd's purse

$A\_ \text{ or } B\_ = \text{heart}$      $aa \text{ and } bb = \text{narrow}$

$A a B b \quad \times \quad A a B b$

$9/16 \quad A\_B\_$

$3/16 \quad A\_b b$

$3/16 \quad a a B\_$

$1/16 \quad a a b b$

Epistatic gene exerts its affect with the presence of a dominant allele.

## Lesson 97

### Example of Epistasis

**Fur color in dogs** Fur color in Labrador Retrievers is controlled by two separate genes.

- Gene 1: Represented by B; which controls color.
- Gene 2: Represented by E which controls expression of gene B.

### Epistasis

If a Labrador retriever has a dominant B allele, they will have black fur.

If they have two recessive alleles (bb) they will have brown fur.











- **BBEE and BbEe --> Black**
- **bbEE and bbEe --> Brown**
- **BBee, Bbee, or bbee --> Golden retrievers**



## Epistasis-genotypes/phenotype

Epistasis In dogs when a gene in recessive form has effect on expression of other genes.

	EE	Ee	ee
BB			
Bb			
bb			

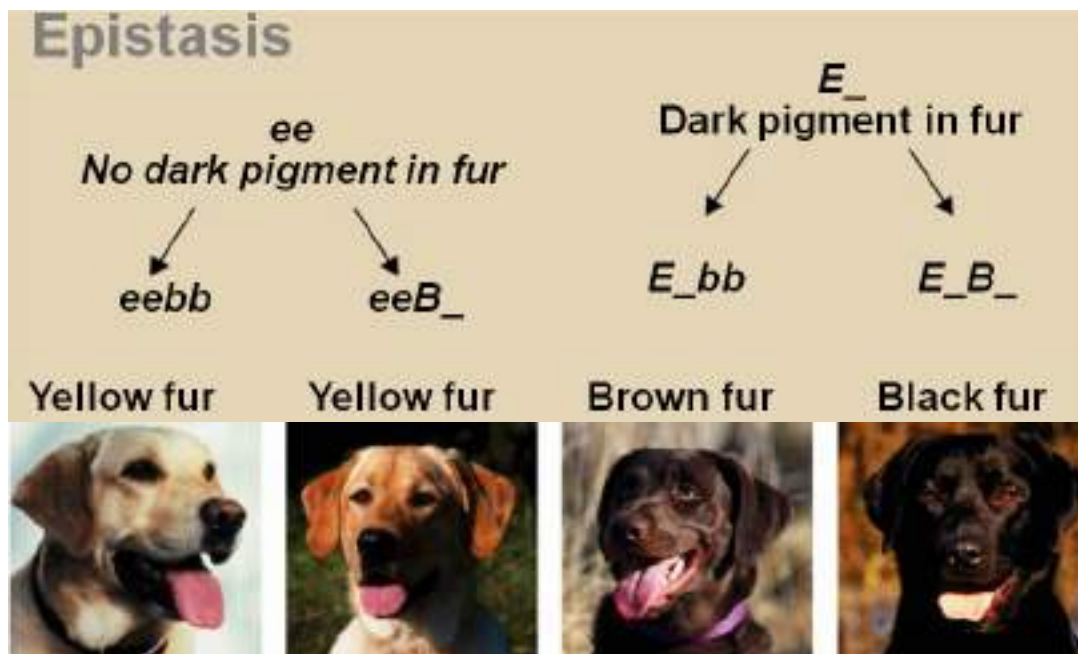

## Lesson 98

**Epigenetics** literally means ‘above’ the genetics. Epigenetic trait is a stable and heritable phenotype resulting from changes in chromosome without alterations in the DNA sequence.

### Causes of Epigenetics

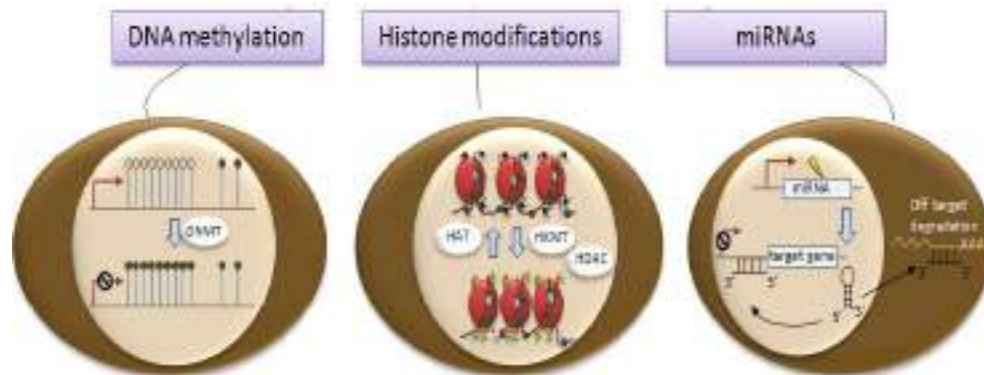

Cytosine methylation: Methyl group to carbon-5 of cytosine residues.

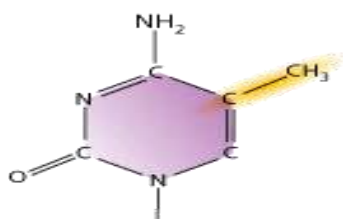
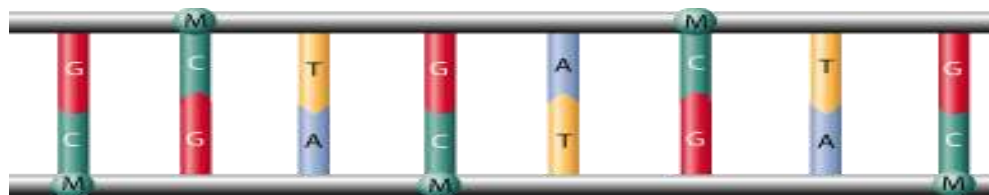

DNA methylation is the addition of a methyl group (M) to the DNA base cytosine (C).

**DNA Methylation is epigenetics, not changes in DNA sequence**

DNA methylations are regarded as epigenetics and not genetic changes in sequence of DNA.

**Molecular Mechanism of Epigenetics** Two primary mechanisms identified. Methylation of cytosine Posttranslational modification to histone proteins; includes acetylation, phosphorylation etc.

### Molecular Mechanisms

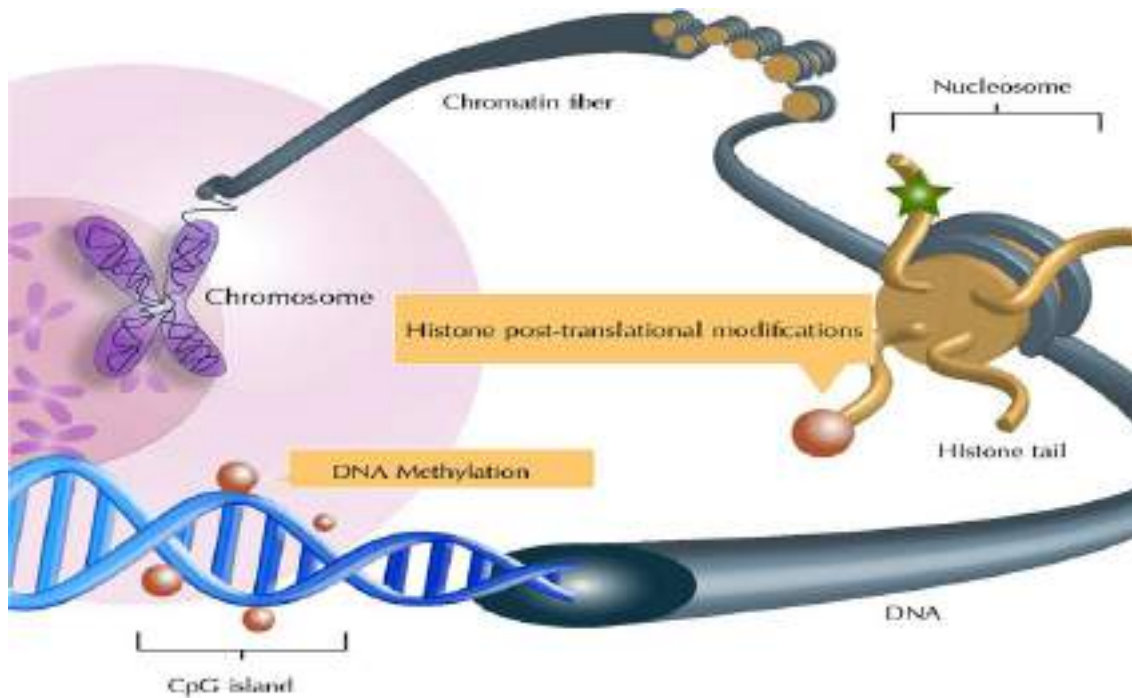

### Histones modifications

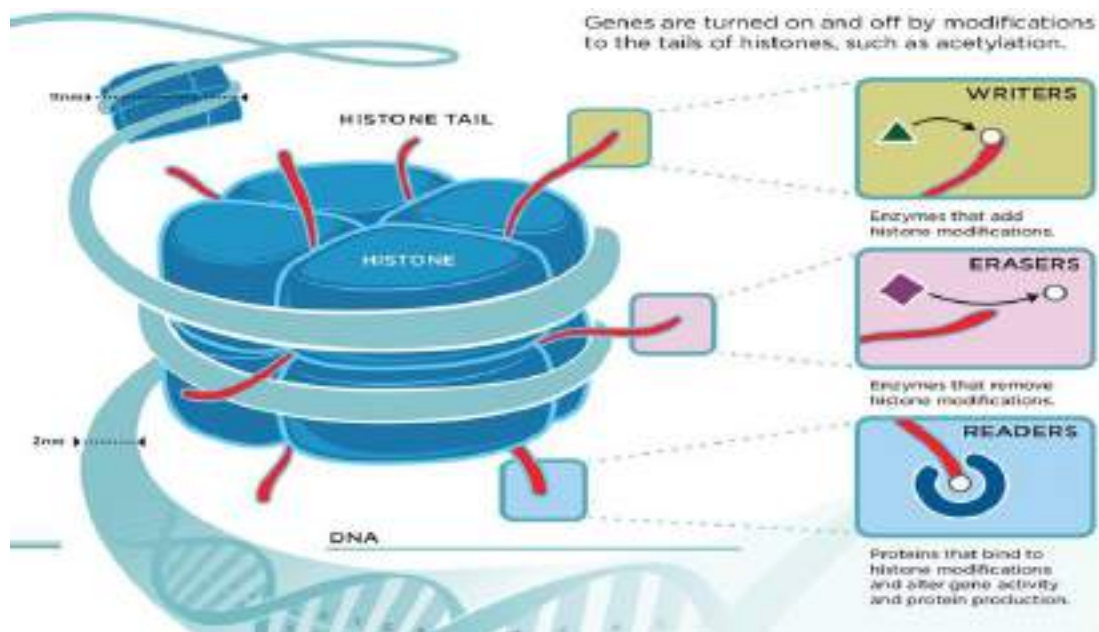



**Small interfering RNA – mechanism causing epigenetics** A third mechanism involves expression of small interfering RNAs (siRNA).

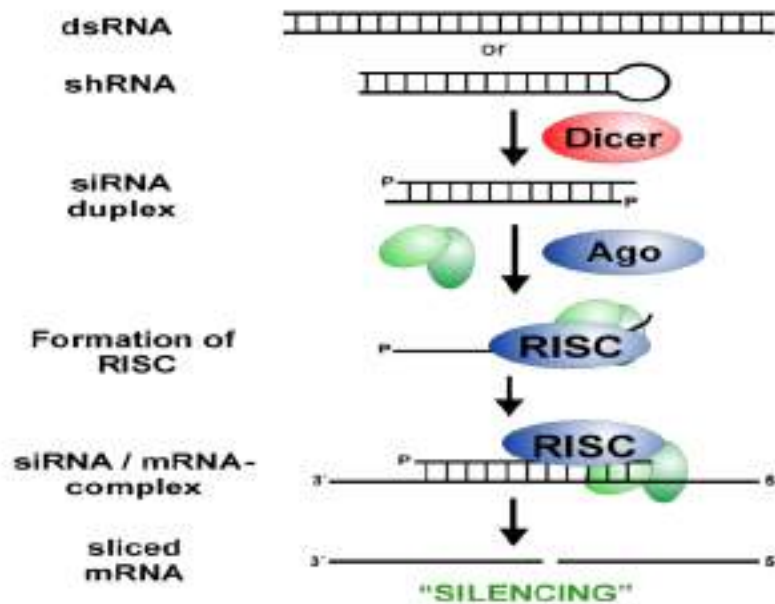

### Genetics vs Epigenetics

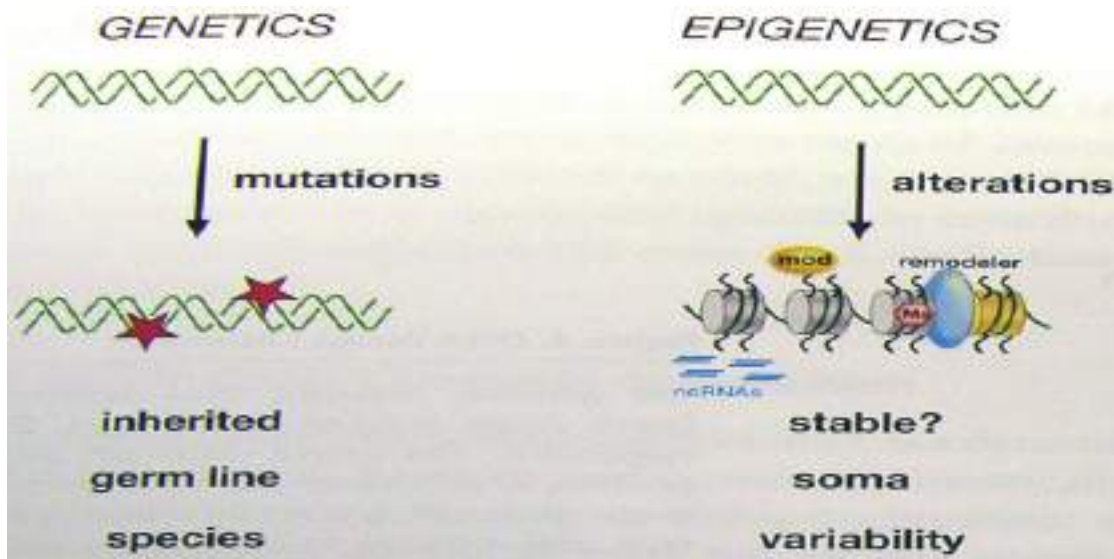

**Epigenetics** An epigenetic trait is a stable heritable phenotype resulting from changes in chromosome without alterations in the DNA sequence.

## Lesson 99

**Epigenetic Modifications:** Followings are the steps of epigenetics modifications

- Cytosine methylation
- Histones modification
- Non-coding RNAs (siRNAs)
- All above regulate gene expression.

Cytosine Methylation – methyl transferase

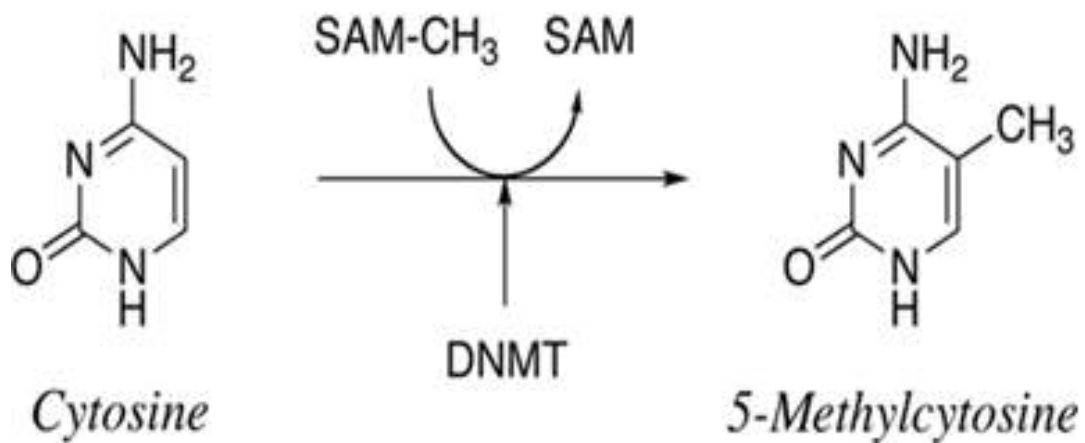

## Genes-switched on & off

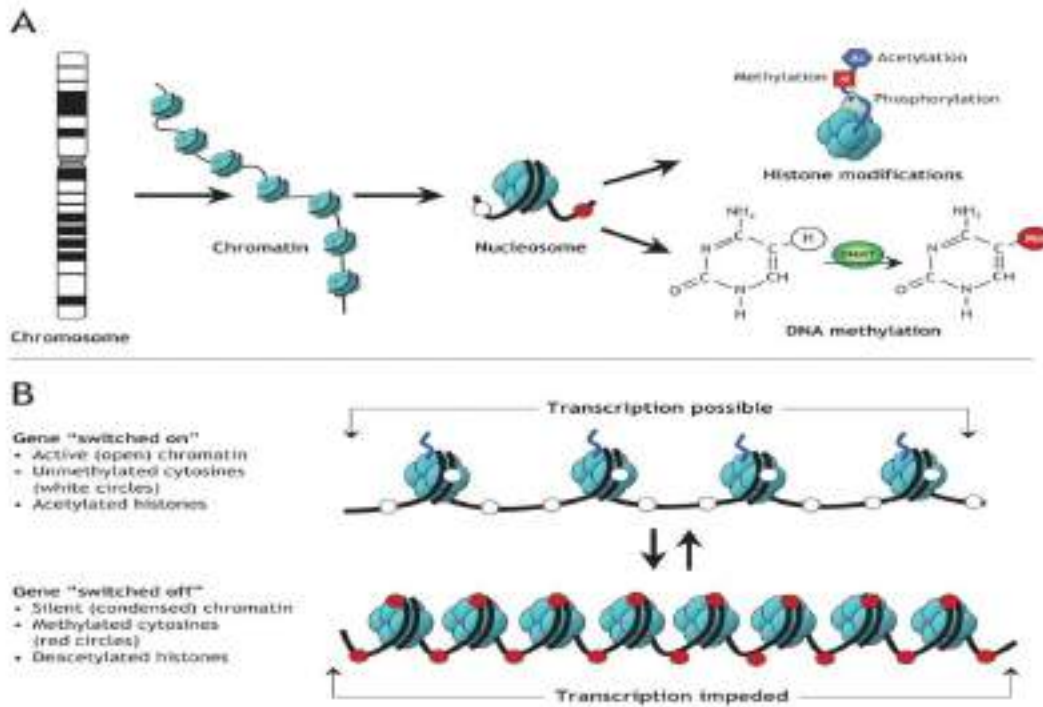

## Methylated cytosine in CpG

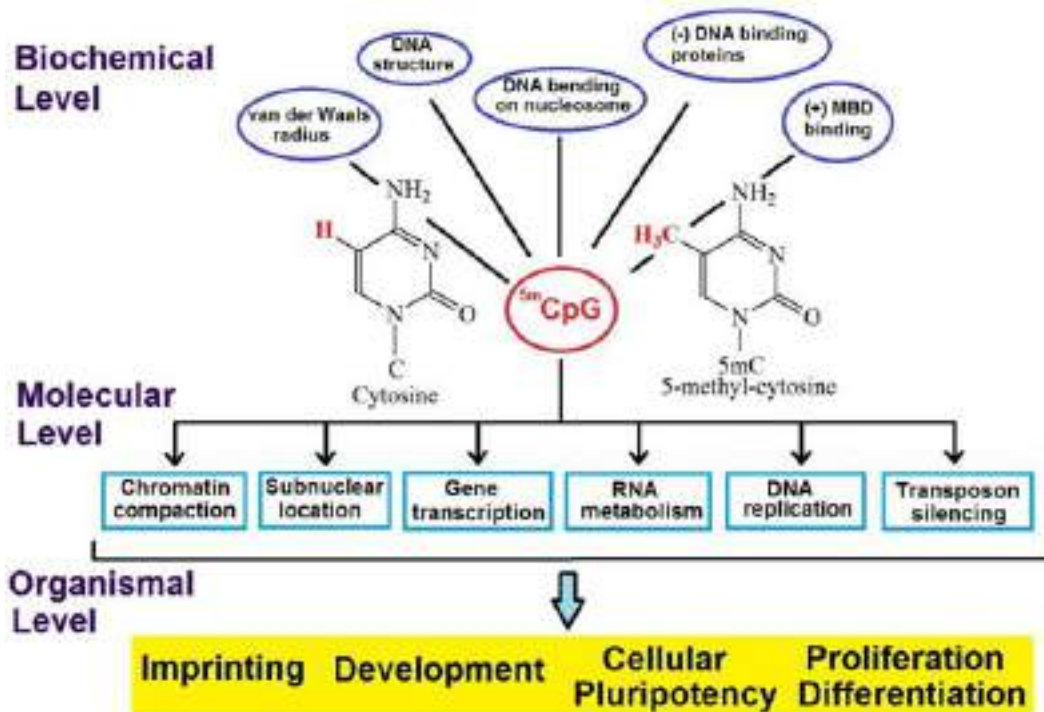

## Cytosine Methylation

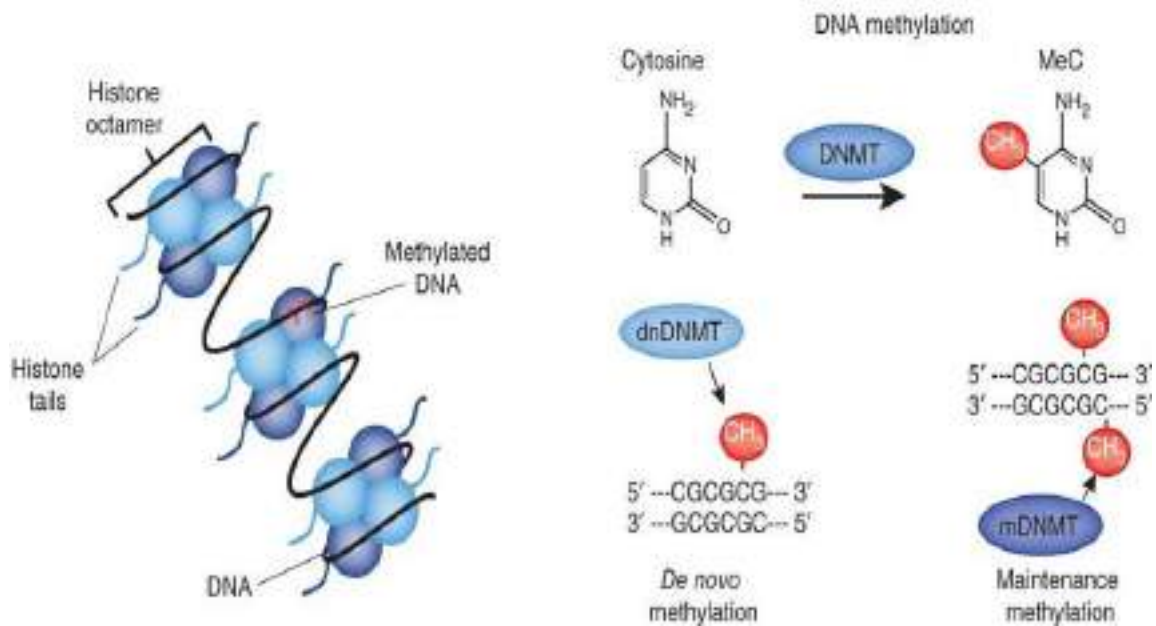

**Cytosine Methylation occurs at upstream regions of genes** Often located just upstream of genes (promoter regions). Associated with attenuation of expression of nearby genes.

**Histones modifications** Histones are the proteins that organize the genetic material. Have a high percentage of basic amino acids, which gives histones an overall positive charge, while DNA is negative charged.

**Acetylated Histones-genes are active** when histones are acetylated, chromatin is open and genes are potentially active. When histones not tagged, deacetylated, the chromatin condenses and genes silenced.

## Histones modifications

•

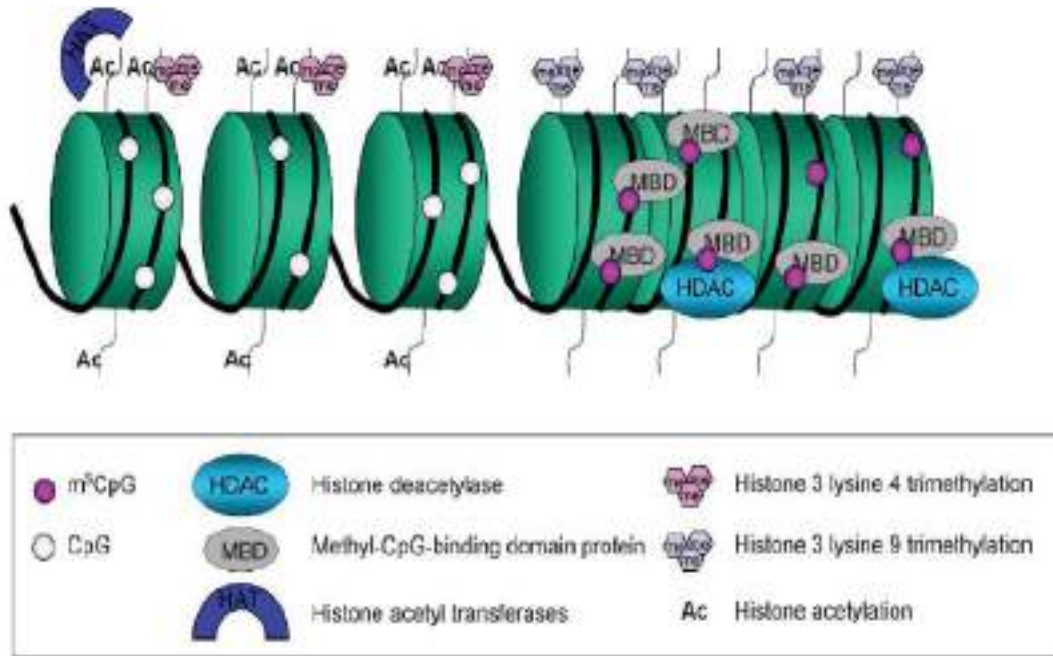

Most histones modifications occurs on the extended tails of histone proteins

## Histones tails - acetylation

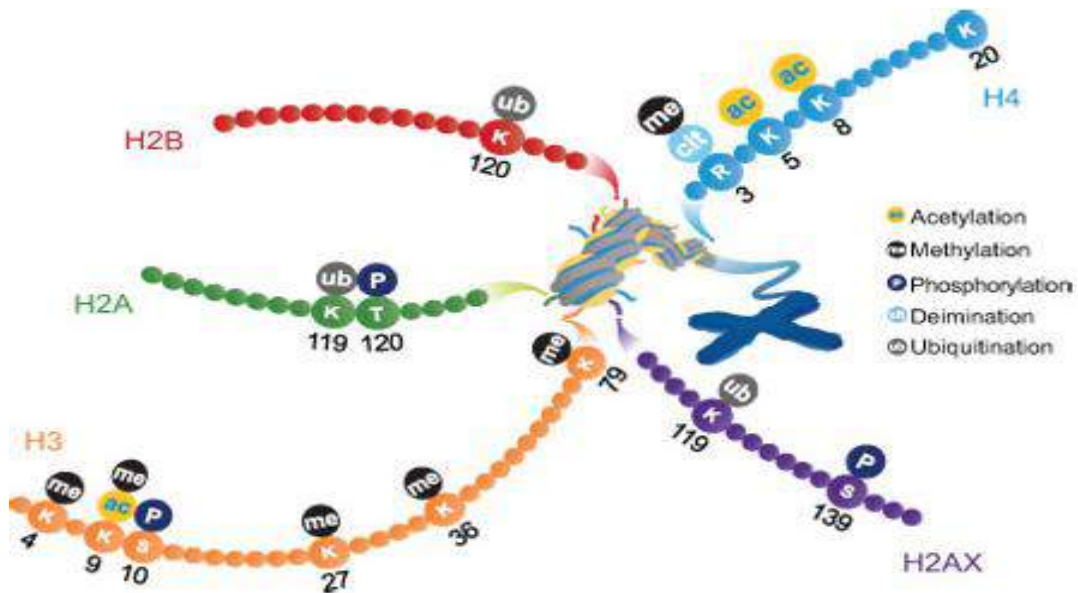

**Histones acetylation** two enzyme types involved in histone acetylation.

- HAT: Histone acetyltransferase
- HDAC: Histone deacetylase.

**Higher acetylation, higher gene expression** Chromatin conformations changes to a form which is more open to transcription.

↑ Acetylation = ↑ gene expression

**Epigenetic modification** - non coding RNA is a new mechanism for gene regulation. RNA which is not used for making proteins can be cleaved and used to inhibit protein-coding RNAs (siRNAs, microRNAs).

**Three common types of modification -**

- Cytosine methylation
- Histones modifications
- siRNAs

## Lesson 100

### Common Epigenetics regulated phenomena

- Cellular Differentiation
- X Chromosome inactivation
- Genomic imprinting

**Cellular differentiation** totipotent cells become pluripotent cells of the embryo which differentiate into specific lineages.

**X chromosome inactivation** Gene expression on one of the female X-chromosomes is down regulated. DNA methylation and histone modifications.

### X chromosome inactivation

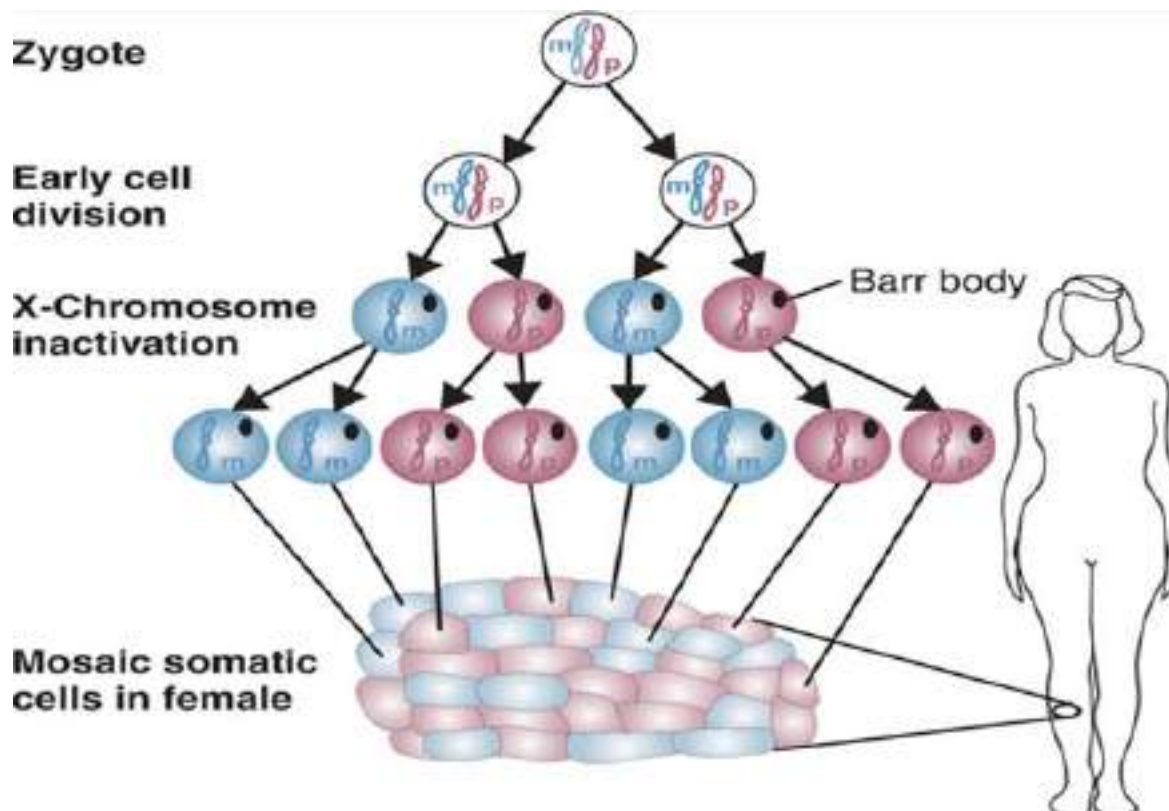

**Genomic Imprinting** Epigenetic marking of a locus on the basis of parental origin. Results in monoallelic gene expression.

**Genomic Imprinting** Some genes are expressed only from the maternal genome and some only from the paternal genome. It is estimated that about 40 genes are imprinted and they can be found on several different chromosomes.

**Epigenetics and fragile X chromosome** Fragile X syndrome is most commonly caused by a CGG trinucleotide repeat expansion in the 5' region of the FMR1 gene. Unaffected individuals have 6-50 CGG repeats.

#### **Epigenetics and fragile X chromosome**

- 200 CGG repeats is seen in individuals with fragile X.
- >200 CGG repeats is correlated with hyper methylation at CpG dinucleotides and silencing.

**Identical twins** Identical twins are from the same zygote, so they begin life with the same genetic information. While infants they experience the same or very similar environments, so there is little variation in the epigenome. Over time the twins' environments will diverge, resulting in individual epigenetic tags to form for each twin. The difference in the twins' epigenomes is what makes them become different when they are older. The epigenetic tags can have such an effect on the twins that one can develop a disease while the other is fine.



## Lesson 101

**Therapies for epigenetics** In contrast to mutations, epigenetic changes can be reversed. Are there therapies that influence epigenetic patterns? Yes

Therapies for epigenetics

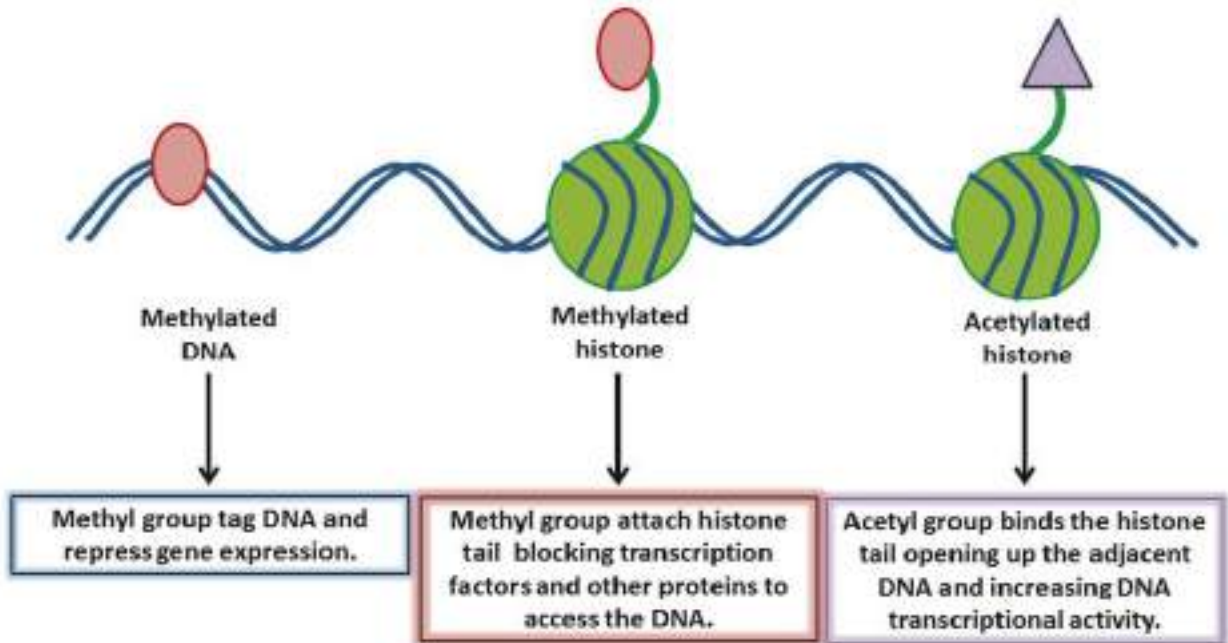



## Lesson 102

### Environmental factors and Epigenetics

#### Nutrition of mother

- The nutrition of the mother can affect the epigenome of a fetus.

#### Stress hormones

- Stress hormones also travel from the mother to a fetus to affect the epigenome

#### Social interactions and physical activities

- Social interactions, physical activity, are factors that affect the epigenome

#### Exposure to toxins and diet

- Exposure to toxins and diet are major factors that affect the epigenome

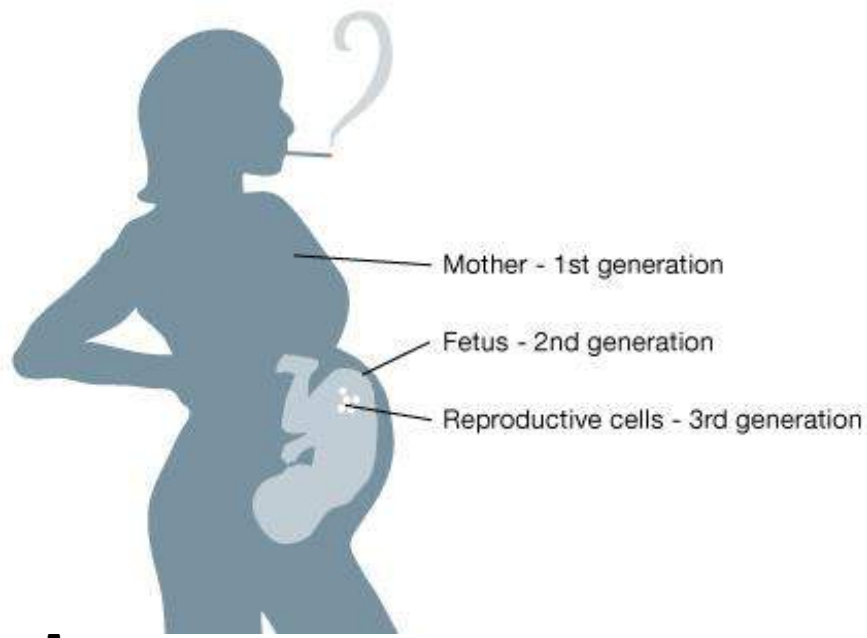

- Epigenetics has opened a new field in genetic research.
- Muddles the nature vs. nurture argument.
- Personal responsibility towards health for further generations.

## Lesson 103

**Epigenetics- conclusions:** Epigenetic traits are heritable phenotypes resulting from changes in chromosomes that do not involve changes in DNA sequence. Two prominent epigenetic mechanisms involve

- DNA methylation (gene silencing)
- Histone acetylation (gene activation).

Errors in epigenetic patterns can influence human diseases including cancer.

**Epigenetics conclusion:** The epigenome changes as we age and can be influenced by the environment. Drugs that influence the epigenome represent a major area of current research.

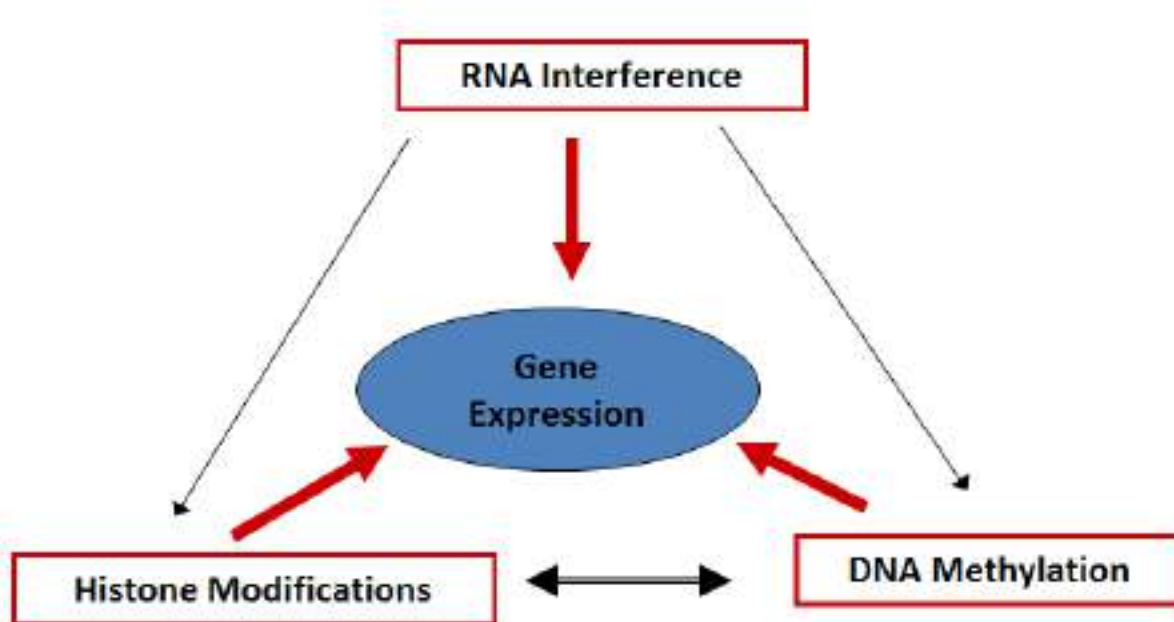

## Lesson 104

### Penetrance and Expressivity

Percent individuals with a given allele that show the phenotype of the allele

Proportion of individuals carrying a particular variant of a gene (allele or genotype) that also expresses an associated trait (phenotype)

Less than 100% penetrance is a result of modifiers, epistasis, suppressors, and environmental conditions.

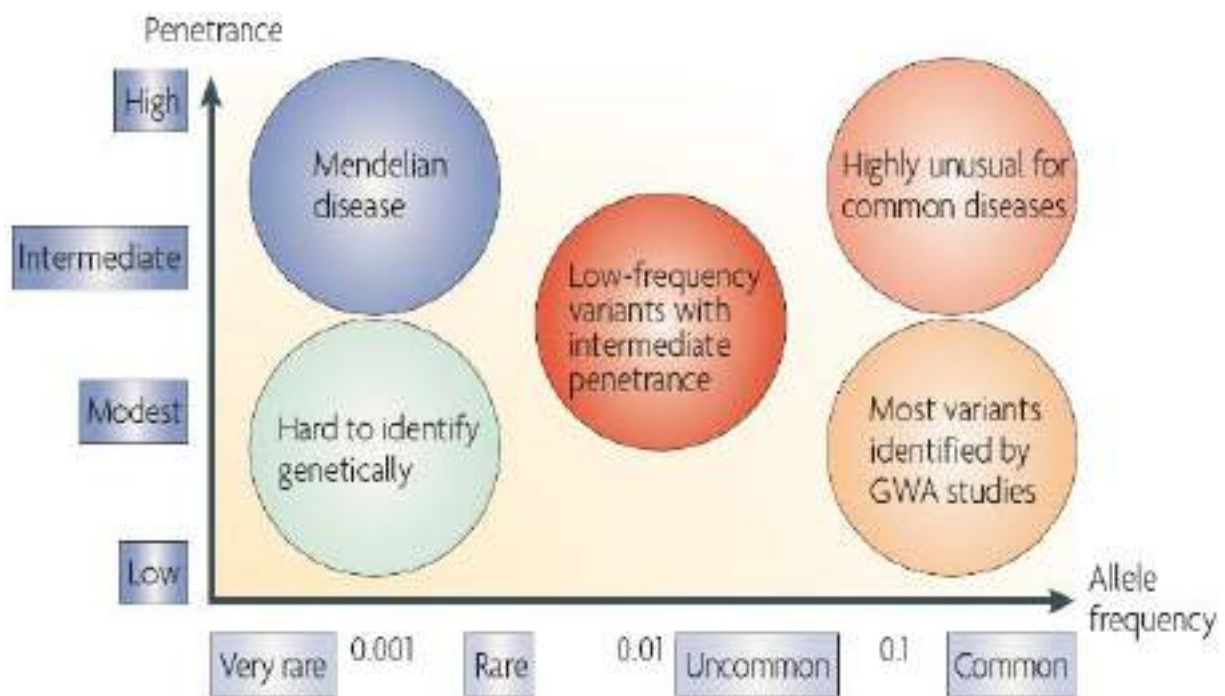

### Expressivity

Extent to which allele is expressed at phenotypic level affected by genetic background and environment.

Difference likelihood of the gene generating its associated phenotype. Influence of an expressed gene at the level of particular individuals.

## Expressivity

The term is analogous to the severity of a condition in clinical medicine.

Variable expressivity when phenotype is expressed to a different degree among individuals with the same genotype.

Phenotypic expression  
(each oval represents an individual)

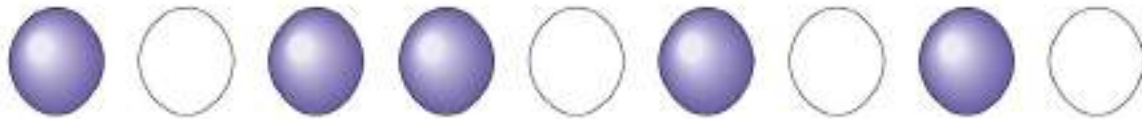

Variable penetrance

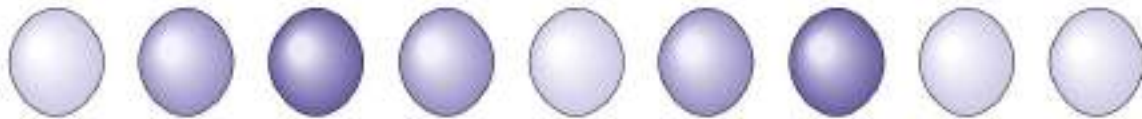

Variable expressivity



Variable penetrance and expressivity

## Penetrance & expressivity – Conclusion

- Likelihood of the gene generating its associated phenotype
- Influence of an expressed gene at the level of particular individuals

## Lesson 105

### Types of Penetrance

**Complete Penetrance** The allele is said to have complete penetrance if all individuals who have the disease-causing mutation have clinical symptoms of the disease.

**Highly Penetrant** If an allele is highly penetrant, and then the trait it produces will almost always be apparent in an individual carrying the allele.

**Incomplete or reduced Penetrance** is said to be reduced or incomplete when some individuals fail to express the trait, even though they carry the allele.

- **Incomplete or reduced Penetrance**



**Low Penetrance** An allele with low penetrance will only sometimes produce the symptom or trait with which it has been associated at a detectable level. In low penetrance, it is difficult to distinguish environmental from genetic factors.

**Determine Penetrance is difficult – if age related** Penetrance can be difficult to determine reliably, even for genetic diseases that are caused by a single polymorphic allele.

For many hereditary diseases, the onset of symptoms is age related.

- **Penetrance is expressed as frequency**
- Multiple endocrine neoplasia 1 (MEN 1), a hereditary disorder
- Age related – 7% at age 10, 100% at age 60.

## Types of Penetrance

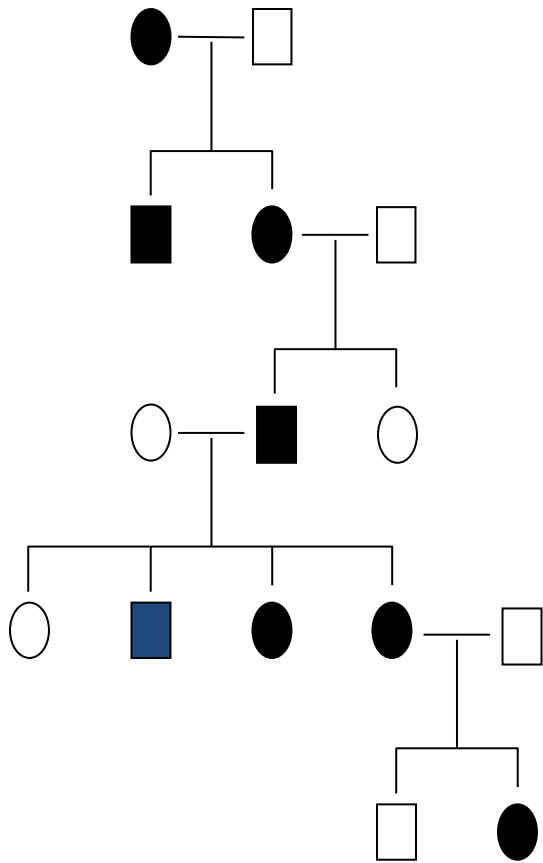

Complete Penetrance

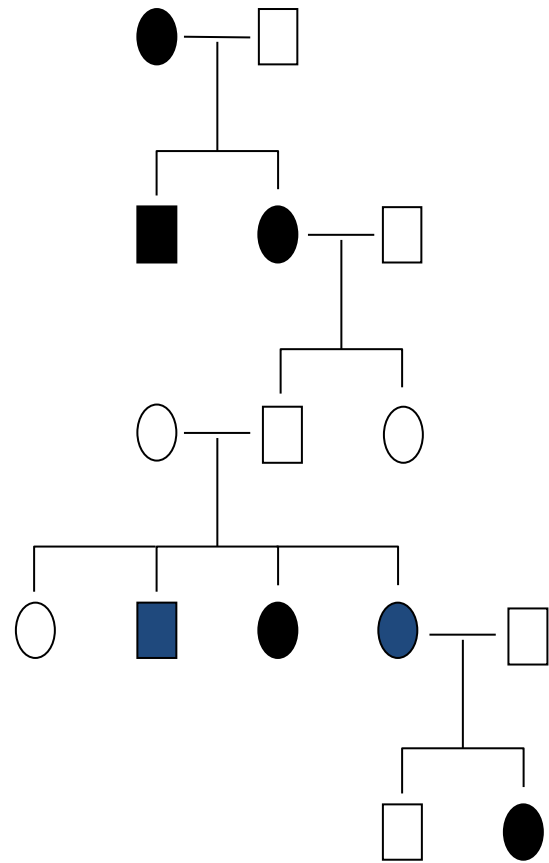

Partial Penetrance



## Lesson 106

**Chromosomal Aberrations:** any change in normal number or structure of chromosomes. Affects individuals may be due altering the amounts of products of the genes involved. Altered amounts may cause anomalies directly or may alter the balance of genes

### Classification

- Numerical (usually due to de novo error in meiosis).
- Structural (may be due to de novo error in meiosis or inherited).

Different cell lines (occurs post-zygotically).

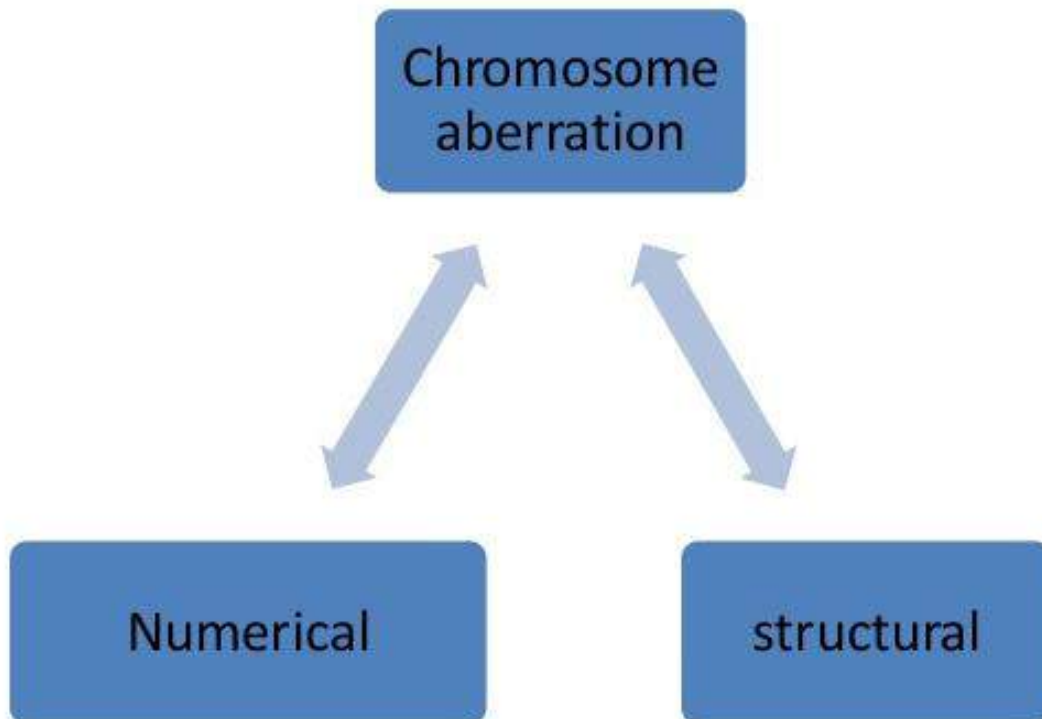

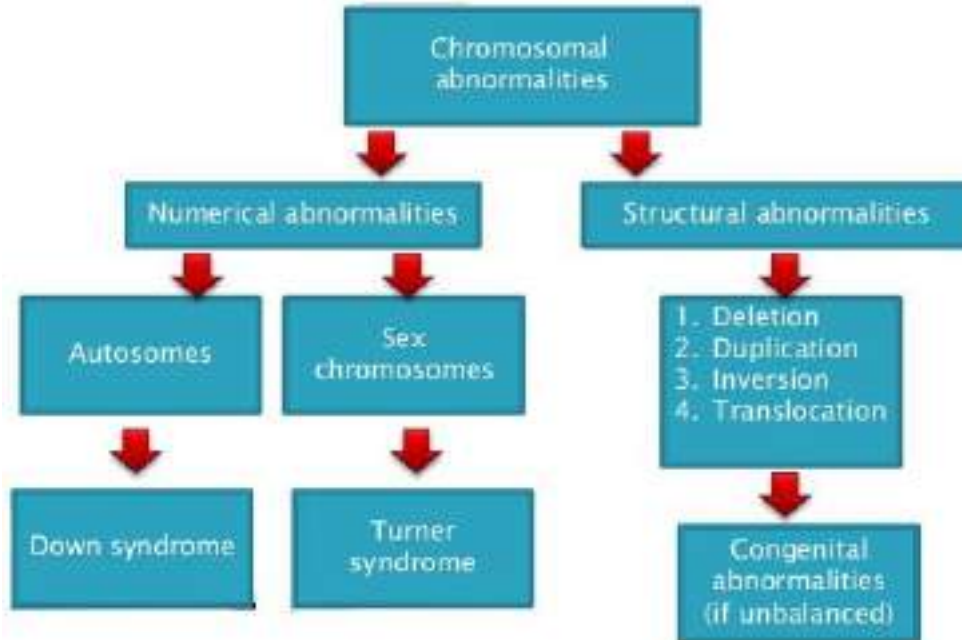

### Numerical changes

- Aneuploidy

- Hypo ploidy

- Hyper ploidy

- Euploidy

- Monoploidy

- Diploidy

- Polyploidy

### Structural

- Translocations

- Deletions

- Duplications

- Inversions

### Different cell lines

- Mosaicism

## Lesson 107

### Karyotyping- Nomenclature

**Karyotype** A normal male chromosome pattern would be described as: 46, XY.

- 46 = total number of chromosomes
- XY = sex chromosome constitution

**Description of anomaly** any further description would refer to any abnormalities or variants found.

46,XY	
47,XX,+21	Trisomy 21 (Down syndrome)
47,XXX	Triple X syndrome
69,XXY	Triploidy
45,XX,der(13;14)(p11;q11)	Robertsonian translocation
46,XY,t(2;4)(p12;q12)	Reciprocal translocation
46,XX,del(5)(p25)	Deletion tip of chromosome 5
46,XX,dup(2)(p13p22)	Duplication of part of short arm Chr 2
46,XY,inv(11)(p15q14)	Pericentric inversion chromosome 11
46,XY,fra(X)(q27.3)	Fragile X syndrome
46,XY/47,XXY	Mosaicism normal/Klinefelter syndrome

**47,XX,+21**

**47,XXX**

**69,XXY**

**45,XX,der(13;14)(q10;q10)**

**46,XY,t(2;4)(p12;q12)**

**46,XX,del(5)(p25)**

**46,XX,dup(2)(p13p22)**

**46,XY,inv(11)(p15q14)**

**46,XY,fra(X)(q27.3)**

**46,XY/47,XXY**

# Lesson 108

## Defining chromosome regions

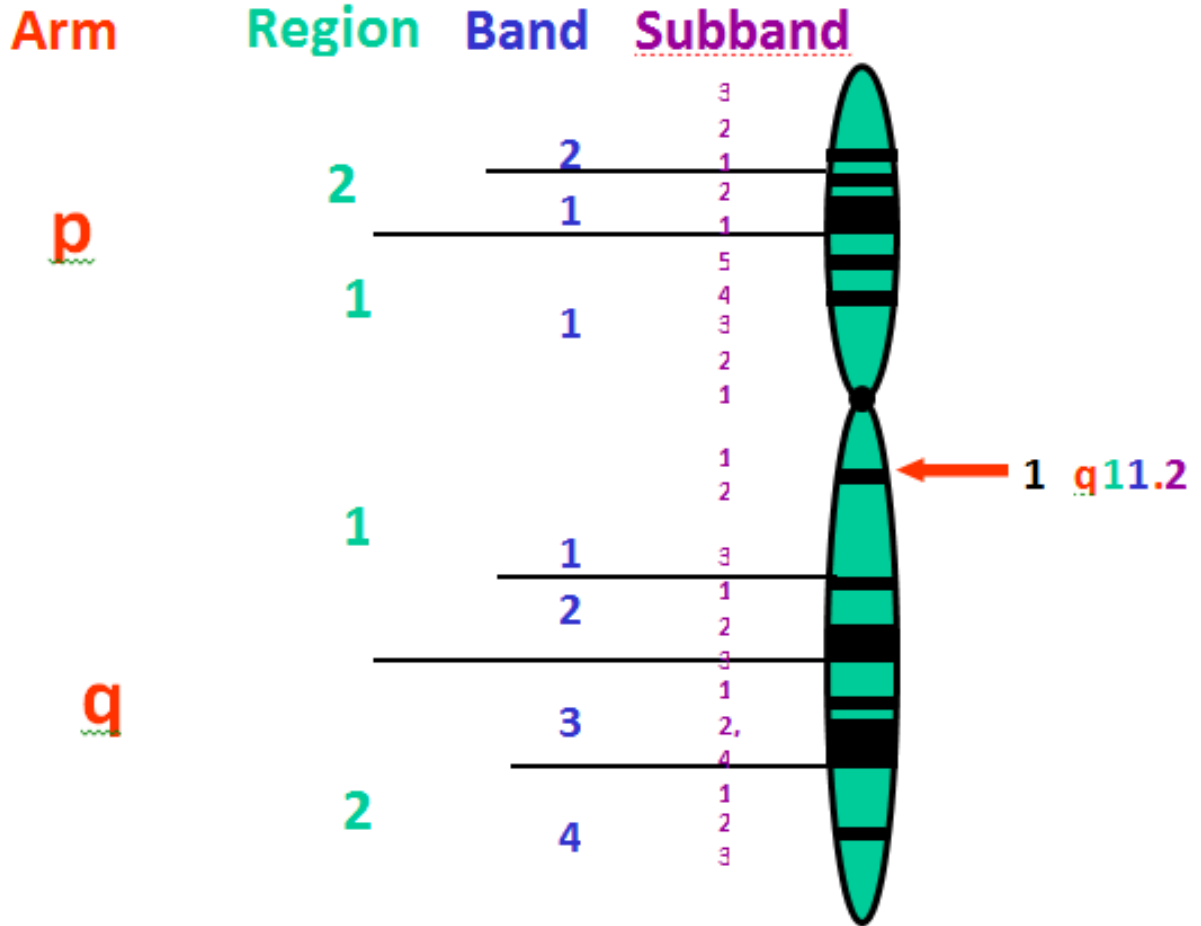

## Bands within bands

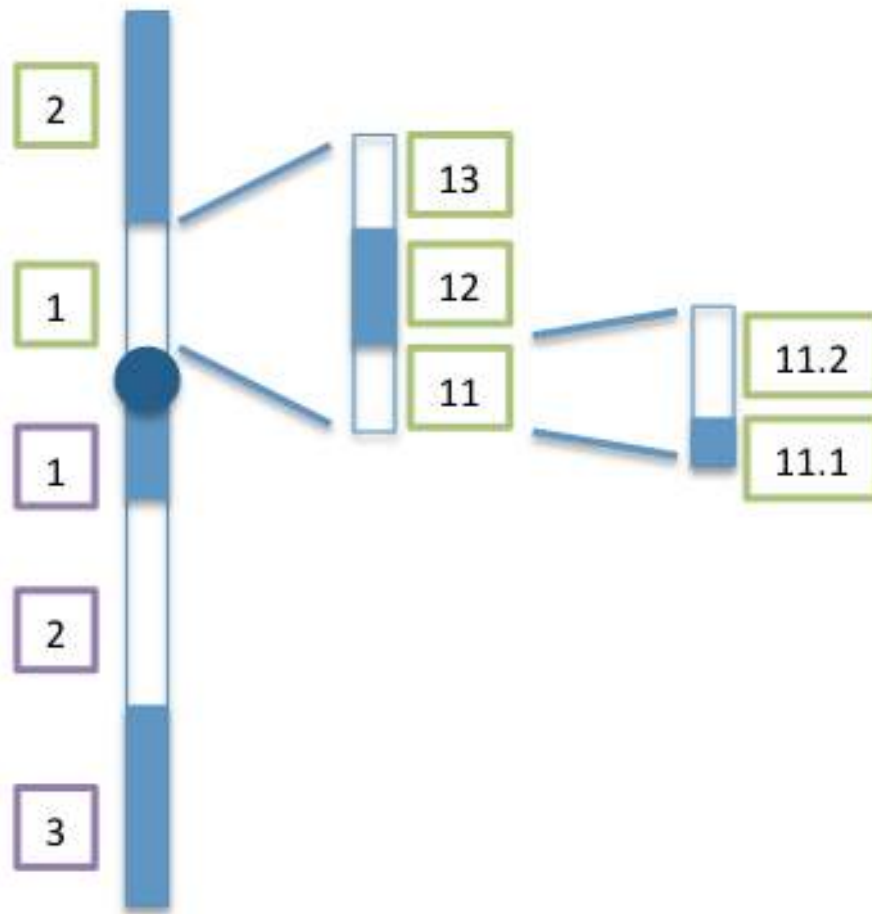

**Chromosome identification** Microscopic examination of chromosomes - Karyotype To identify and classify

1. Size
2. Location of the centromere
3. Banding patterns

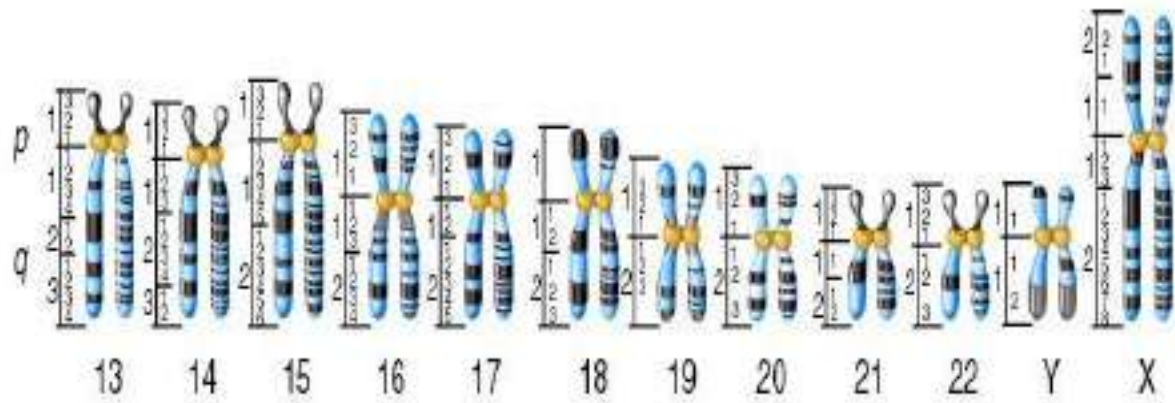
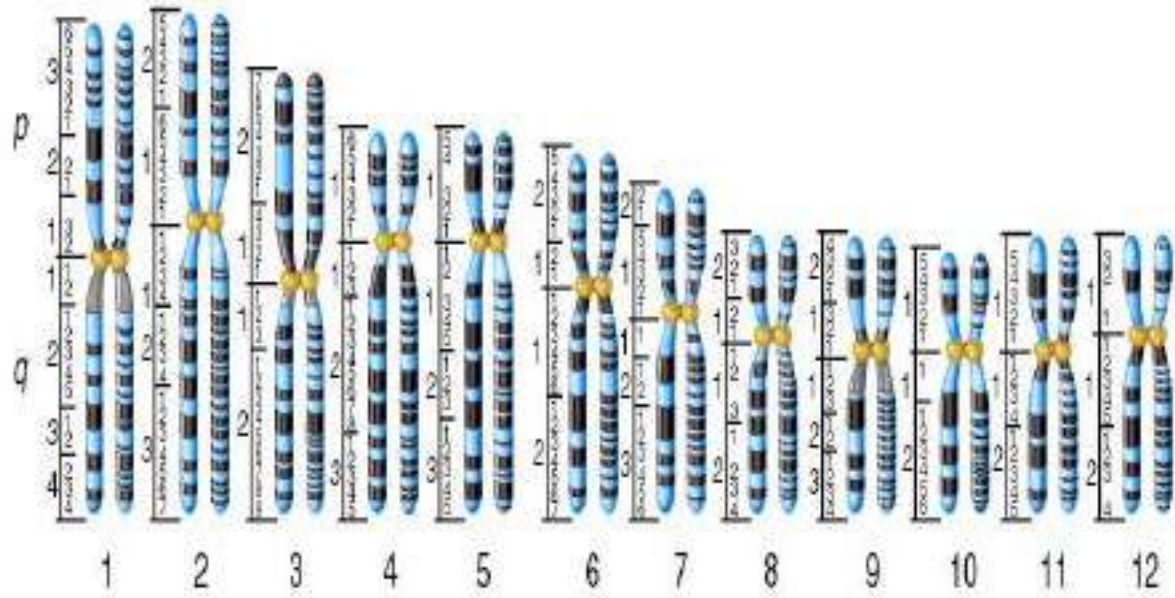

## Lesson 109

### Common numerical abnormalities

- Down syndrome (trisomy 21: 47,XX,+21)
- Edwards syndrome (trisomy 18: 47,XX,+18)
- Patau syndrome (trisomy 13: 47,XX+13)

### Sex chromosome abnormalities

Turner syndrome 45,X

Klinefelter syndrome 47,XXY

### All chromosomes abnormalities

Triploidy (69 chromosomes)

**Down syndrome** this is a Trisomy 21 (47+21). The frequency of trisomy increases with increasing maternal age.

Sometimes, Robertsonian translocation involving chromosome 21

3-4 % not related to maternal age.

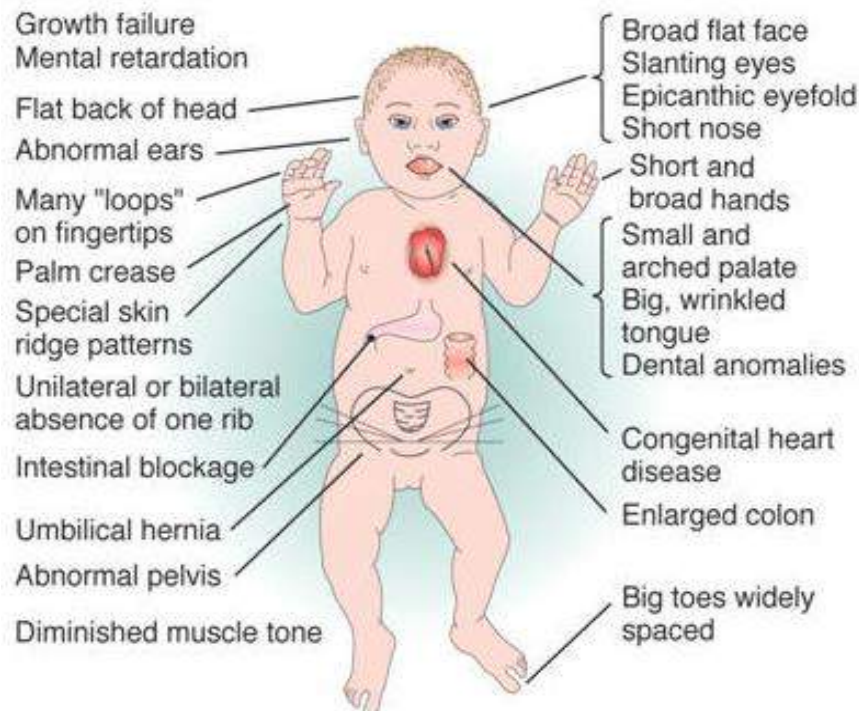

## **Down syndrome clinical features**

- **Head and neck**

Brachycephaly

Epicanthal folds

- Brushfield spots
- Flat nasal bridge
- Folded ears
- Open mouth
- Protruding tongue
- Short ne

## **Extremities**

Short fifth finger

Short broad hands

Incurved fifth finger

Space between first and second toe

Hyper flexibility of joints



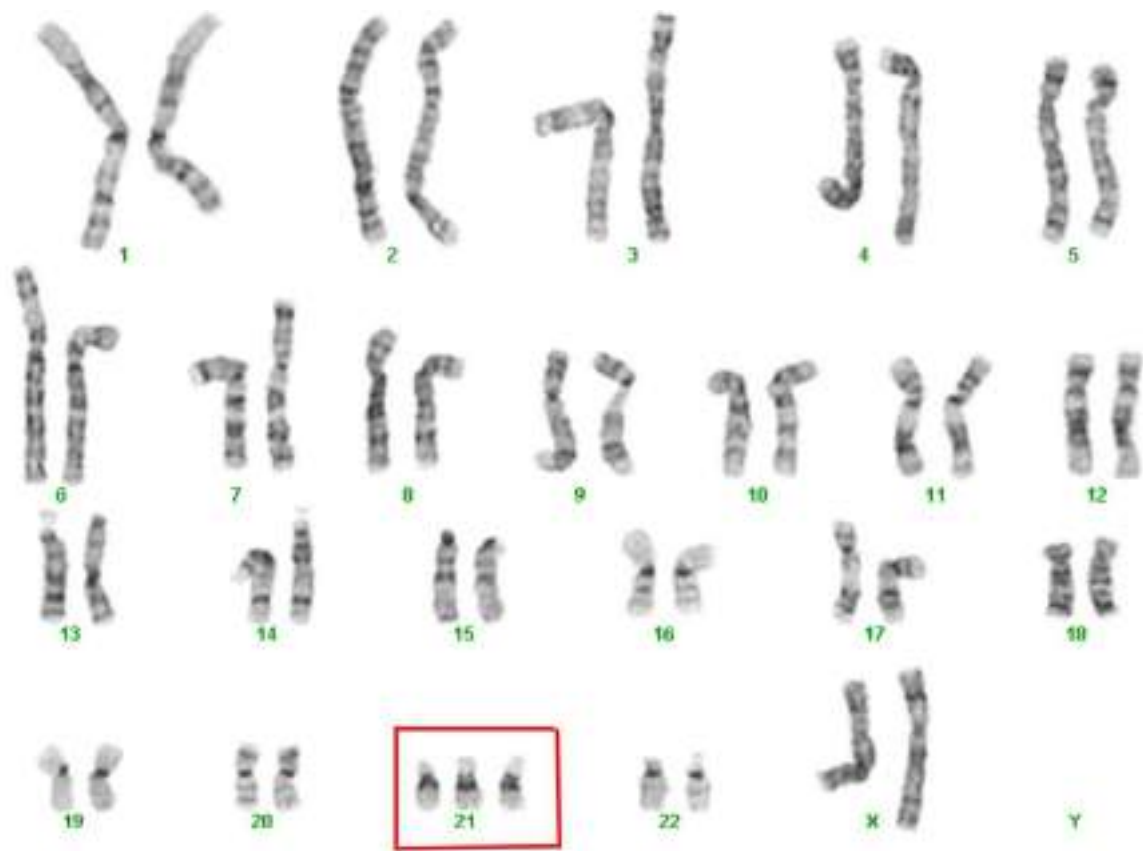

**Turner syndrome** relatively common disorder caused by the loss of genetic material from one of the sex chromosomes.

Affects only females

### Turner syndrome - clinical features

- Short stature (143-145cm tall)
- Loss of ovarian function
- Hormone imbalances( thyroid, diabetes)
- Stress and emotional deprivation
- Diseases affecting the kidneys, heart, lungs or intestines
- Bone diseases
- Learning problems( esp. in math)

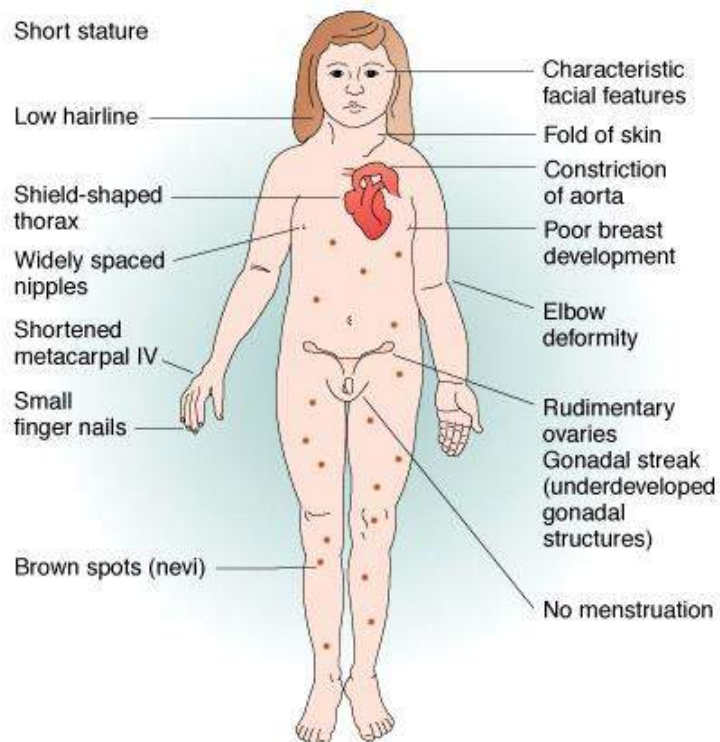

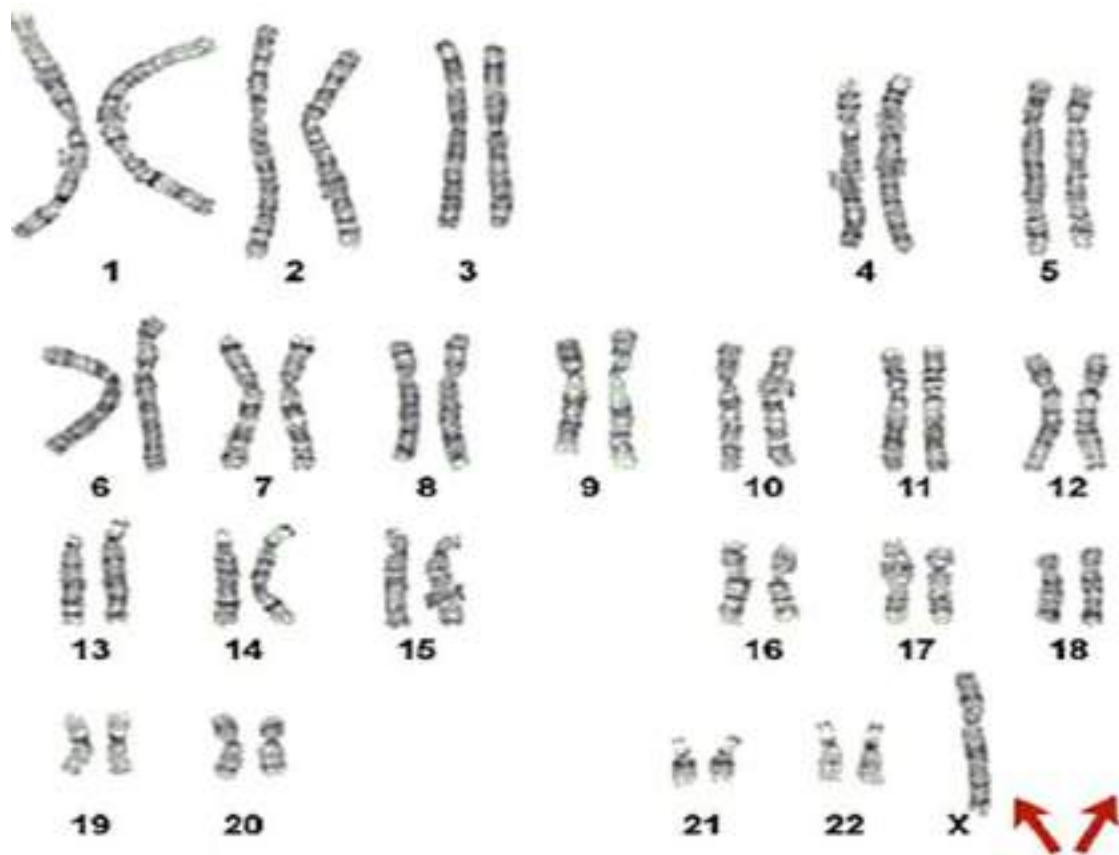

Although it is a genetic disorder, it is not usually hereditary.

There are no known environmental causes of the syndrome

Women with Turner Syndrome are usually infertile

## Triploidy- 69 chromosomes

### Numerical abnormalities

- Due to chromosomes numbers.



## Lesson 110

### Structural Abnormalities

Chromosome breakage & subsequent reunion in a different configuration

#### Types based on genetic material

- Balanced – chromosome complement is complete.
- Unbalanced – when there is incorrect amount of genetic material.

#### Types

- Translocations
- Deletions
- Insertions
- Inversions
- Ring chromosome
- Isochromosomes

#### Types of structural abnormalities

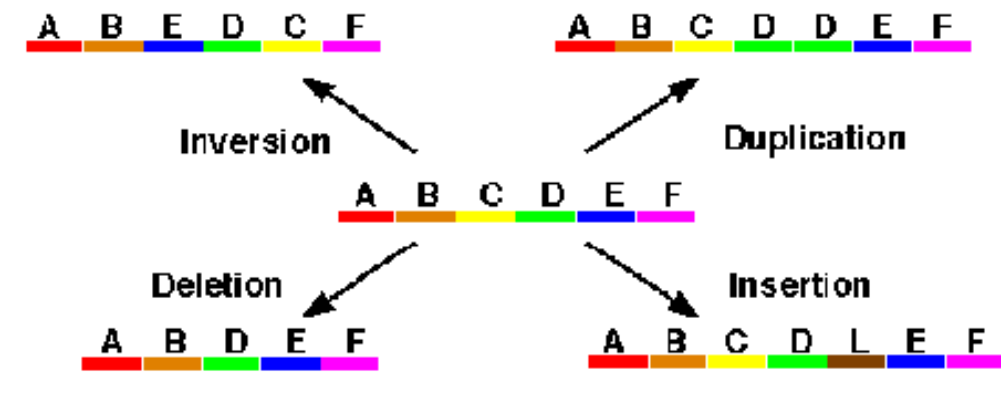

#### Translocation



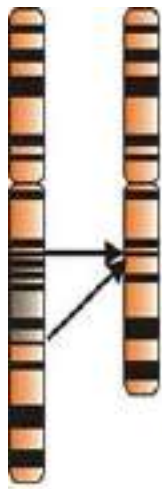

Deletion



Duplication



Inversion

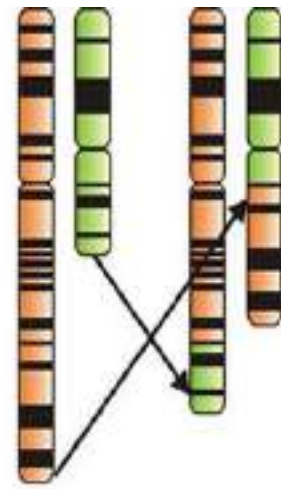

Translocation

## Lesson 111

### Translocations

Definition Transfer of genetic material from one chromosome to another. There are two types of translocations

- Reciprocal translocation
- Robertsonian translocation

**Balanced and unbalanced** where no genetic information extra or missing genes.

Unbalanced translocations where exchange of genetic information is extra or missing some of the genes.

**Reciprocal an** exchange of material between two different chromosomes is called a reciprocal translocation. When this exchange involves no loss or gain of chromosomal material.

Reciprocal in non-homologous chromosomes Reciprocal translocations are usually an exchange of material between non-homologous chromosomes. One in each of 600 births in humans.

Reciprocal translocations

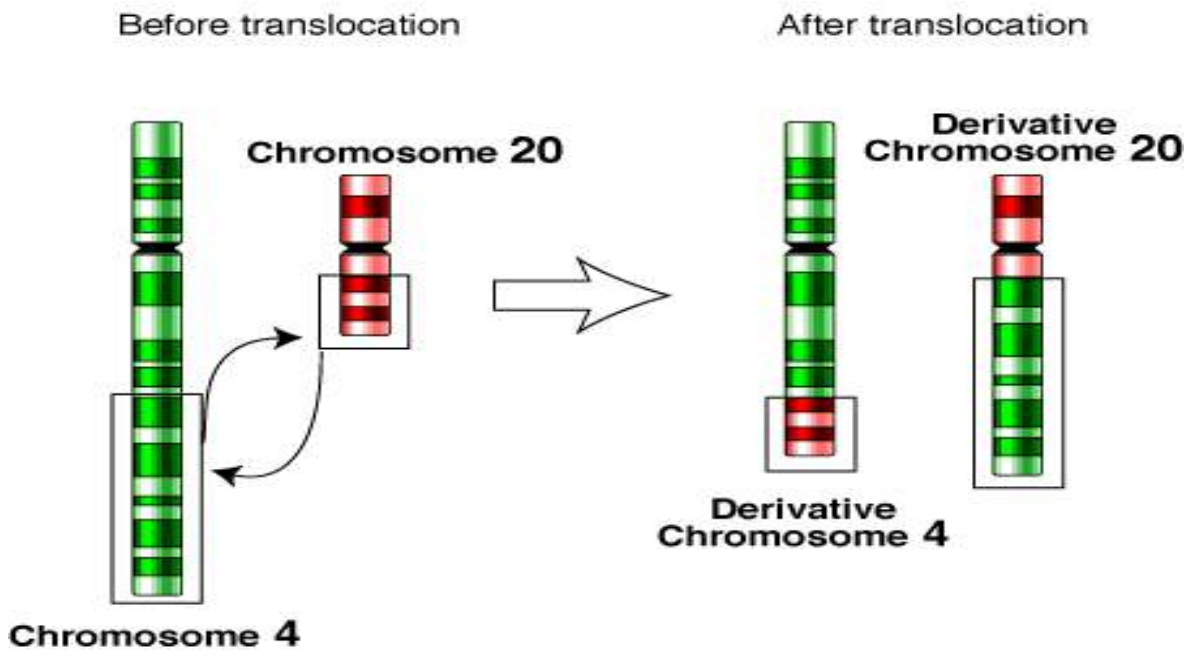

## Robertsonian Translocations

Breaks occur at the extreme ends of the short arms of two non-homologous acrocentric chromosomes. The small acentric fragments are lost. The larger fragments fuse at their centromere regions to form a single chromosome. The most common translocation in humans involves chromosomes 13 and 14 and is seen in about 0.97 / 1000 newborns.

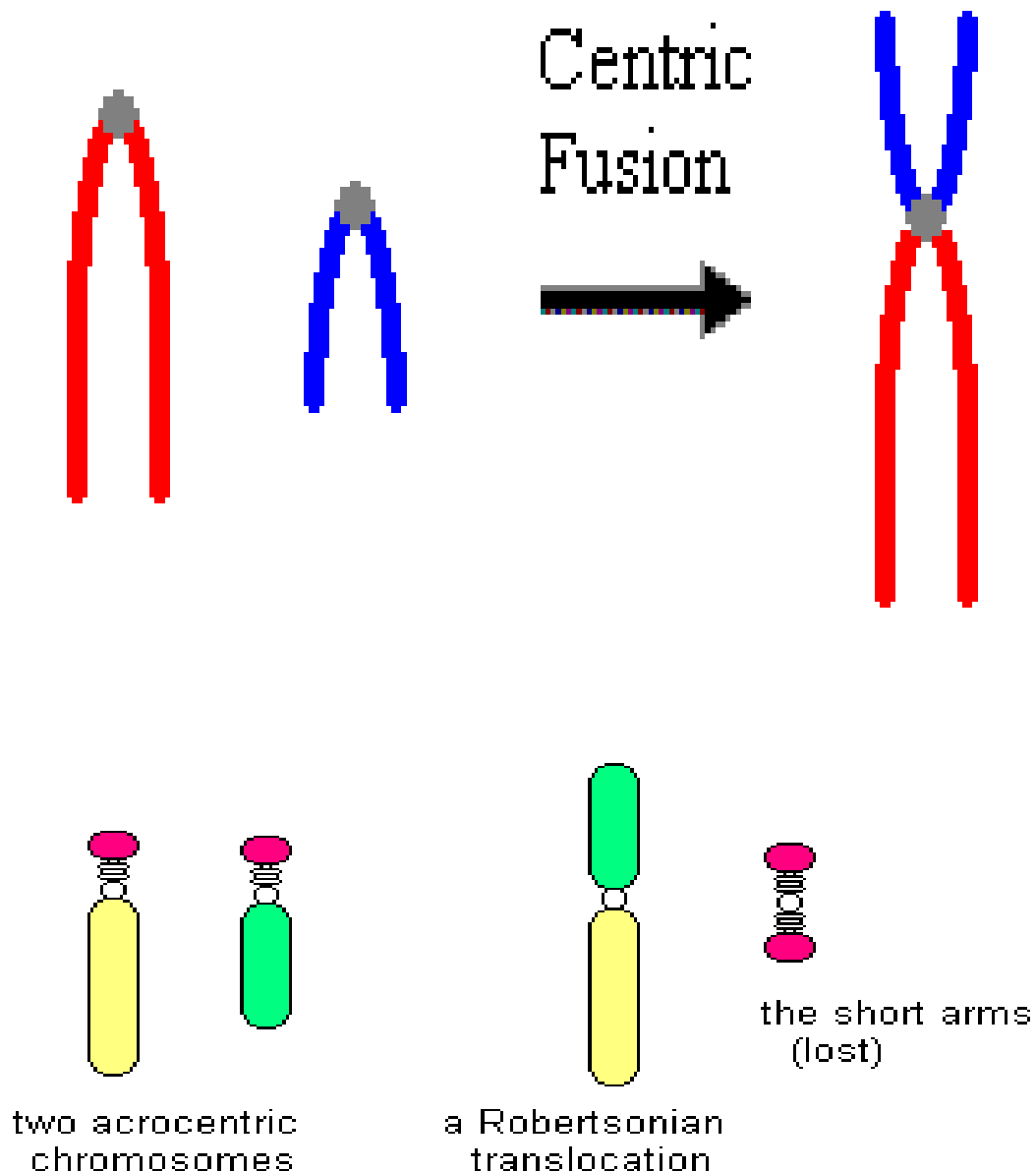



## Types of translocation

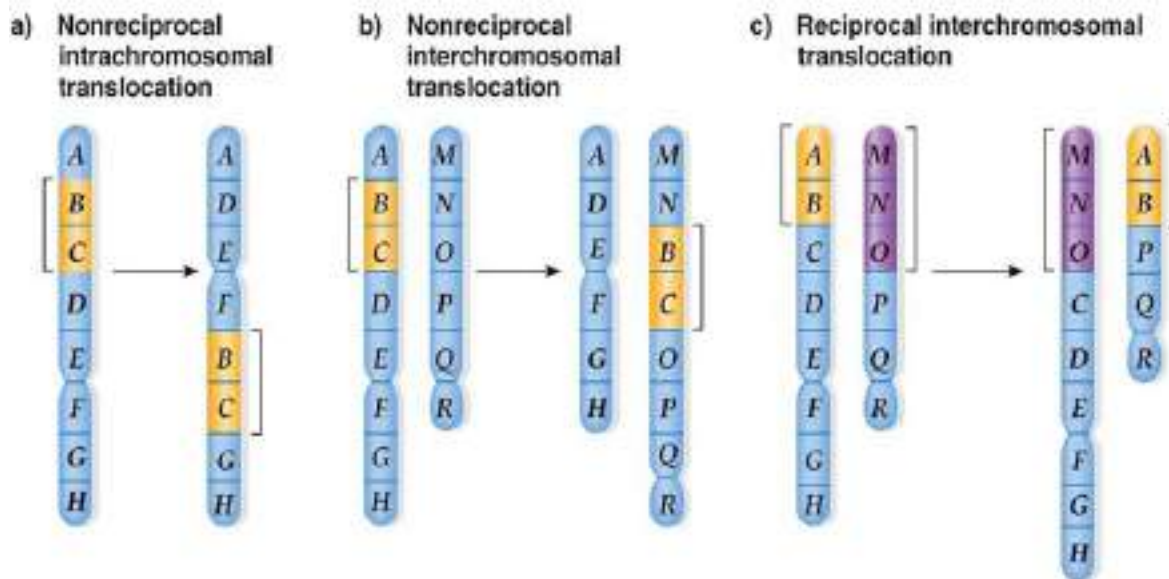

## Common human diseases caused by translocation

- Cancer
- Infertility
- Down syndrome
- Leukemia
- XX male syndrome

## Lesson 112

### Non-disjunction:

When two homologous chromosomes or sister chromatids fail to separate during cell division, such a phenomenon is called as Non-disjunction

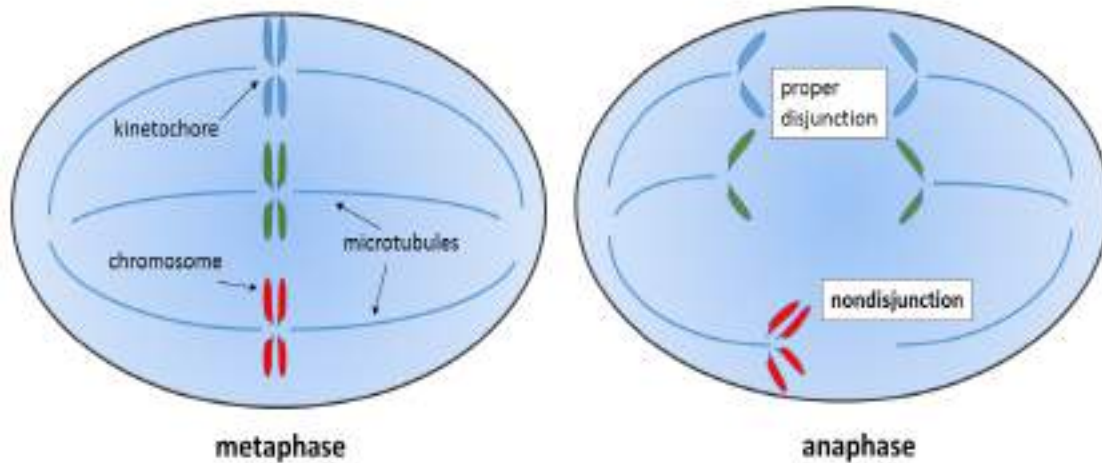

### Types of Non-disjunction

Meiotic non-disjunction

Mitotic non-disjunction

**Meiotic Non-disjunction** If non-disjunction occurs during 1st meiotic division then all the sperms/ova derived from primary spermatocyte/oocytes will be abnormal.

### Failure of chromosomes separation

- Failure of a pair of homologous chromosomes to separate in meiosis I.
- Failure of sister chromatids to separate during meiosis II.
- Failure of sister chromatids to separate during mitosis.

**Mitotic Non-disjunction** Mitotic non-disjunction results in cells with different number of chromosomes. Breaking of the spindle fibers during metaphase or anaphase. If spindle fibers do not form for one of the chromosomes, then during anaphase it will not separate into two chromatids and one cell will have an extra chromatid and the other will be lacking one. Mitotic nondisjunction causes trisomic and monosomic daughter cells to be formed.

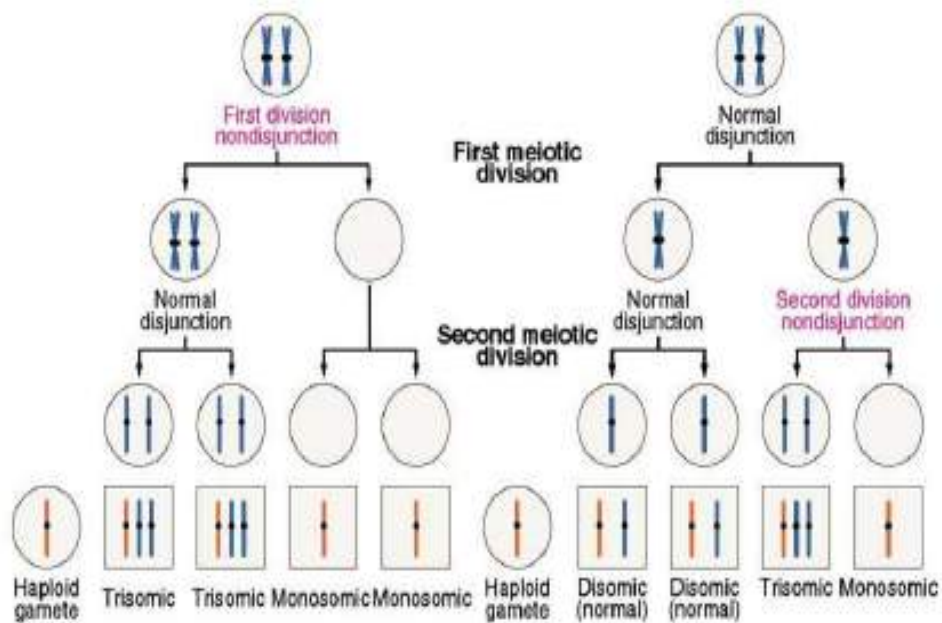

Cell with 46 chromosomes

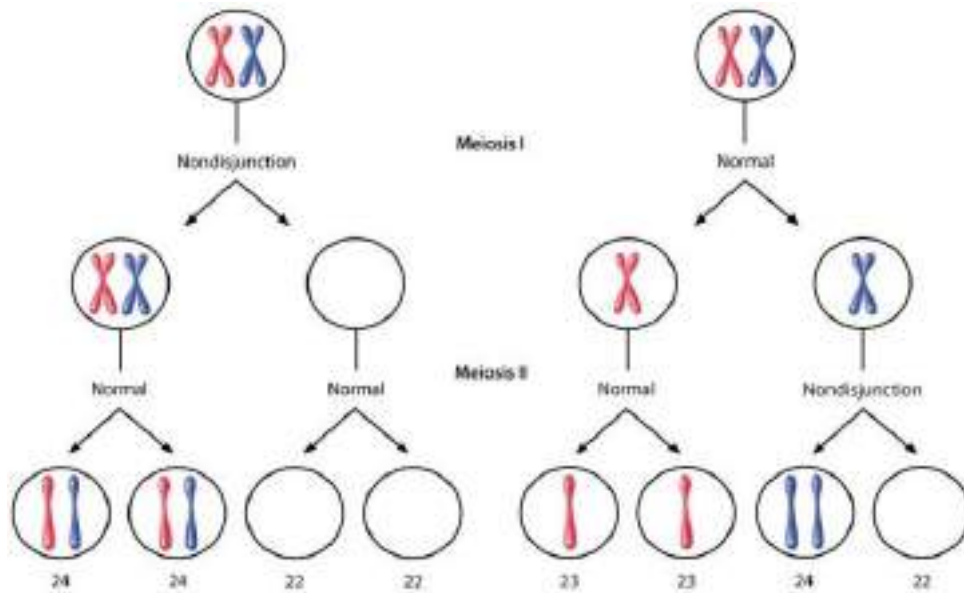

### Causes of non-disjunction

- Aging effect on primary oocyte
- Radiation
- Delayed fertilization after ovulation

## Lesson 113

**Trisomy** is a type of polysomy in which there are three copies of a particular chromosome, instead of the normal two. Trisomy is a type of aneuploidy (an abnormal number of chromosomes).

### Trisomy -Autosomes and sex chromosome

- Autosomal trisomy
- Sex-chromosome trisomy
- Trisomy of chromosome 21, which is found in Down syndrome, is called trisomy 21.

### Trisomy Types

- Primary trisomy - an entire extra chromosome has been copied.
- Partial trisomy - an extra copy of part of a chromosome.
- Secondary trisomy - the extra chromosome has duplicated arms.
- Tertiary trisomy - extra chromosome is made up of copies of arms from two other chromosomes.

### Common trisomy in humans

- Trisomy 21
- Trisomy 18
- Trisomy 13
- Klinefelter's syndrome (47 XXY)

**Trisomy 21 Down syndrome** Trisomy 21 1 in 700 live births Associated with increased maternal age

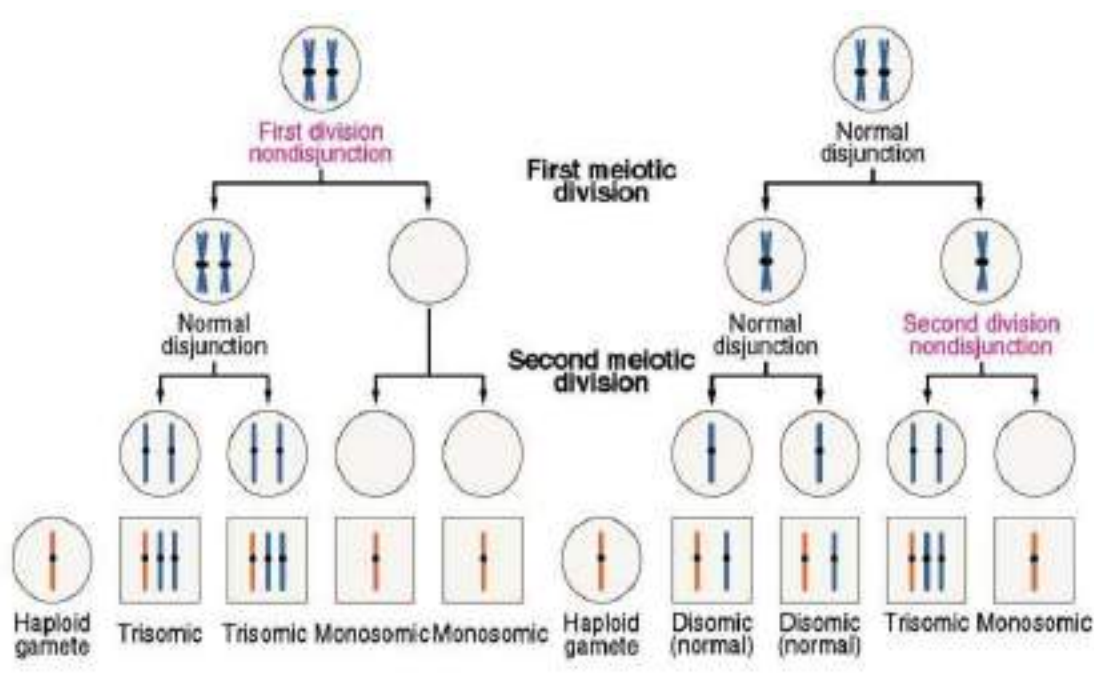
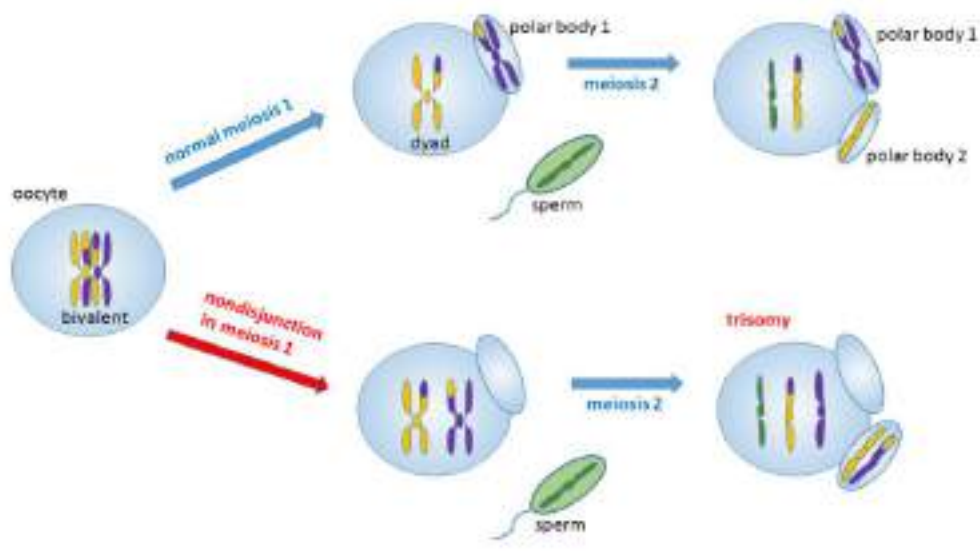

## Trisomy 18 Edwards' syndrome

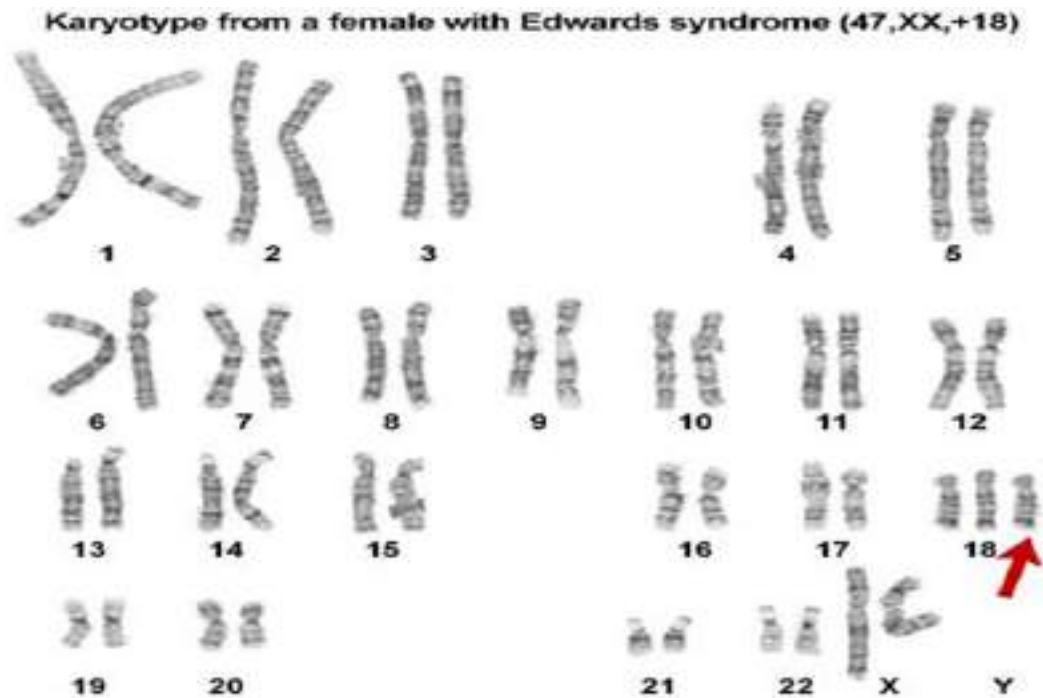

## Trisomy 13 Patau's syndrome



Trisomy is a type of polysomy in which there are three copies of a particular chromosome, instead of the normal two.

## Lesson 114

**Monosomy:** Loss of a single chromosome

Monosomy of autosomes is lethal

Turner syndrome XO i.e. loss of sex chromosome.

**Causes of monosomy:** followings are the causes of monosomy

- Non disjunction – one gamete receives two copies of homologous chromosomes and other will have no copy.
- Loss of chromosome. As it move towards pole of cell during anaphase.

### Fruit fly

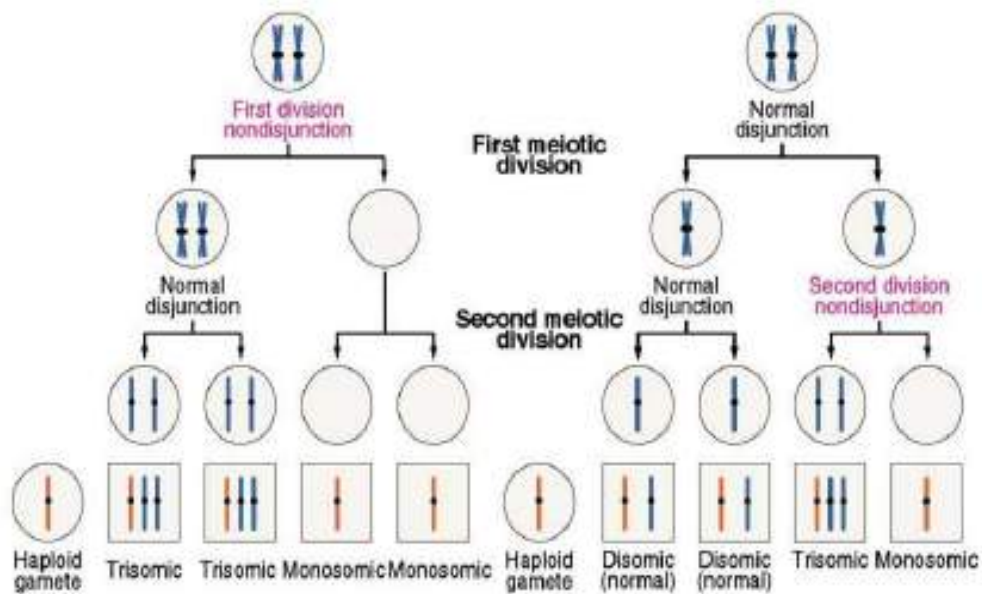
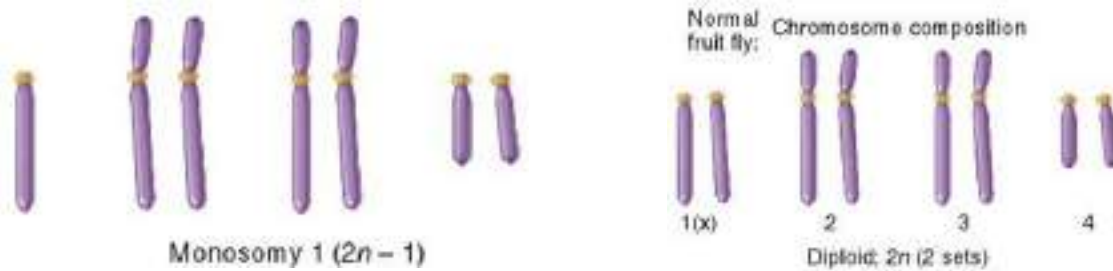

## Monosomy – Chromosome 7

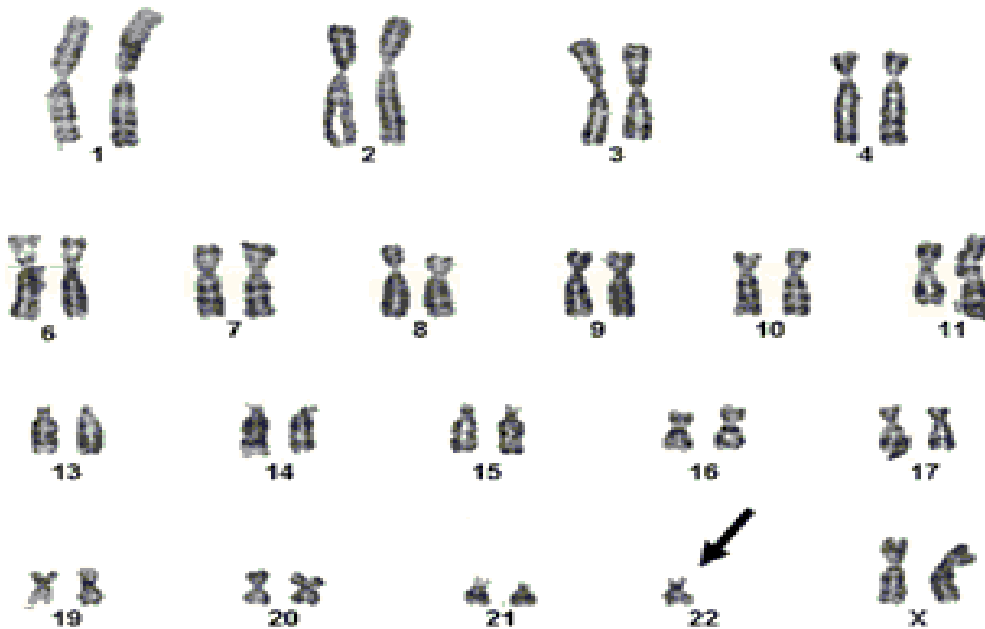
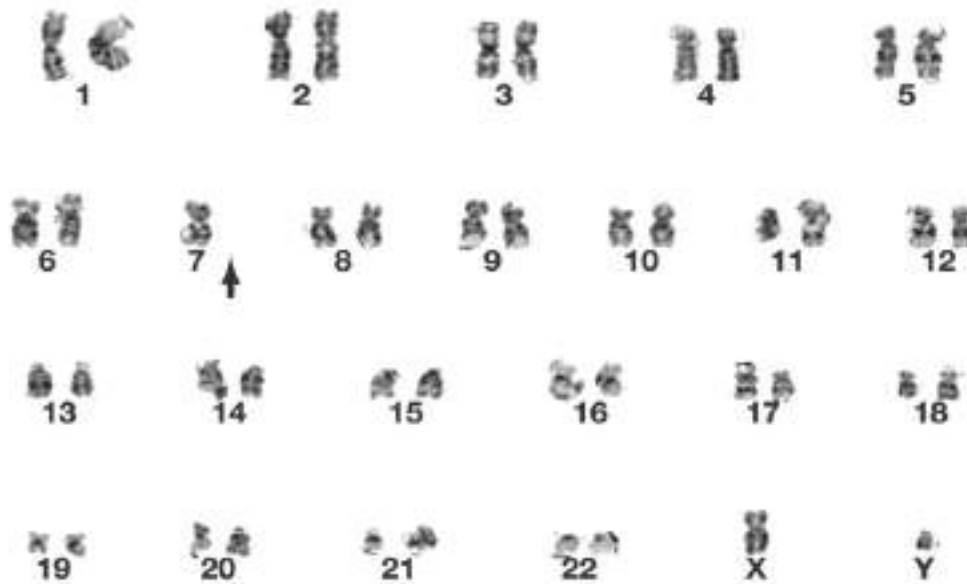

Monosomy – chromosome 22

## Diseases due to Monosomy

- Turner syndrome
- Cri du chat syndrome



## Lesson 115

**Polyploidy:** Multiples of haploid number

- Triploidy or tetraploidy etc
- Fetus does not survive

**Two major types**

- Autopolyploidy
- Allopolyploidy

**Types of polyploidy**

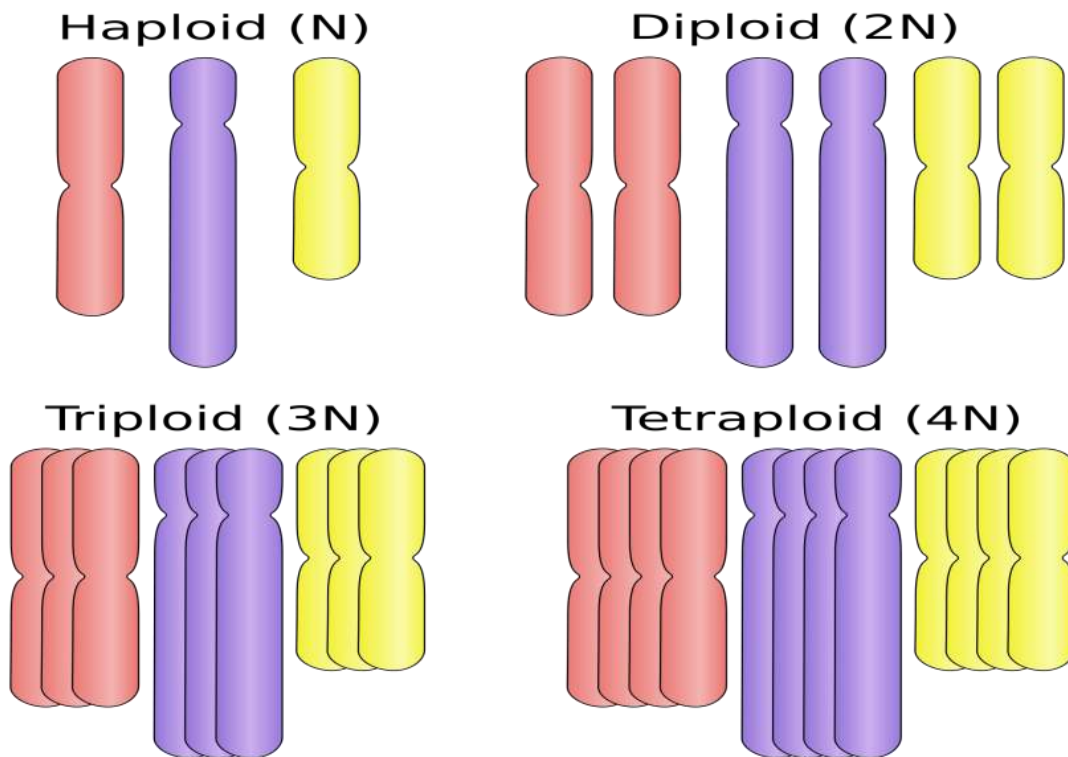

- Triploid (3x) watermelon
- Tetraploid (4x) - cotton
- Pentaploid (5x) - Kenai Birch
- Hexaploid (6x) - wheat



### Causes of polyploidy

- Retention of polar body.
- Formation of diploid sperms.
- Di-spermy – fertilization by two sperms.

### Triploidy

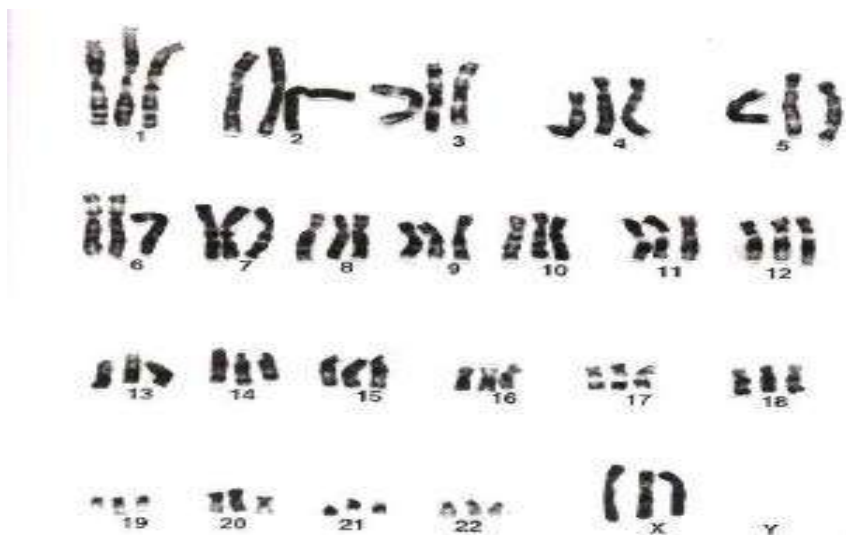

### Polyploidy in Plants

- Triploid: apple, banana, citrus, ginger, watermelon
- Tetraploid: cotton, potato, tobacco, peanut
- Hexaploid: oat, kiwifruit
- Octaploid: strawberry
- Decaploid: some sugar cane hybrids

## Lesson 116

### Allopolyploidy

#### Types of Polyplody:

- Autopolyploidy
- Allopolyploidy

**Autopolyploidy :** Autopolyploids are polyploids with multiple chromosome sets derived from a single species.

**Allopolyploidy:** Allopolyploids are polyploids with chromosomes derived from different species. Allopolyploidy is inter-species cross Interspecies crosses can generate allopolyploids. Offspring are generally sterile.

#### Allopolyploid

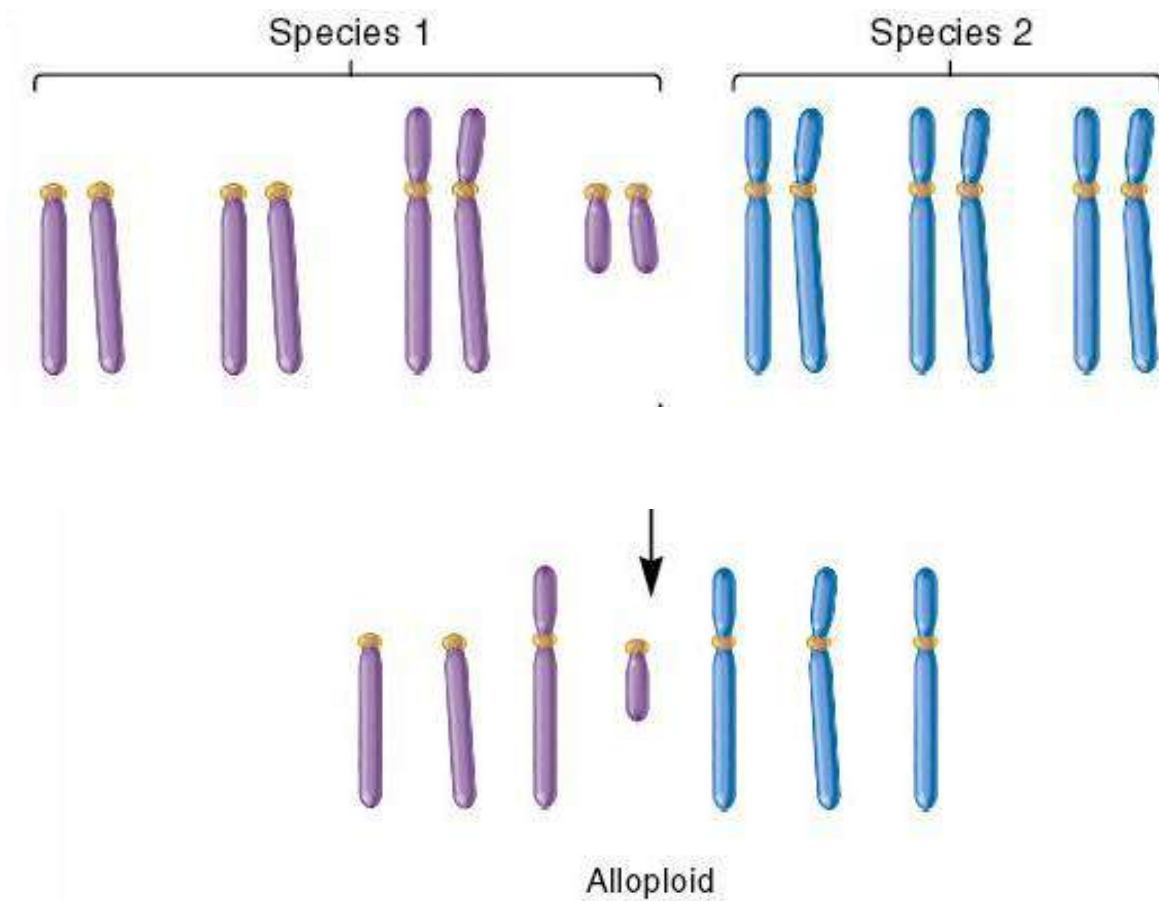

**Inter-species cross can results in Allodiploid**

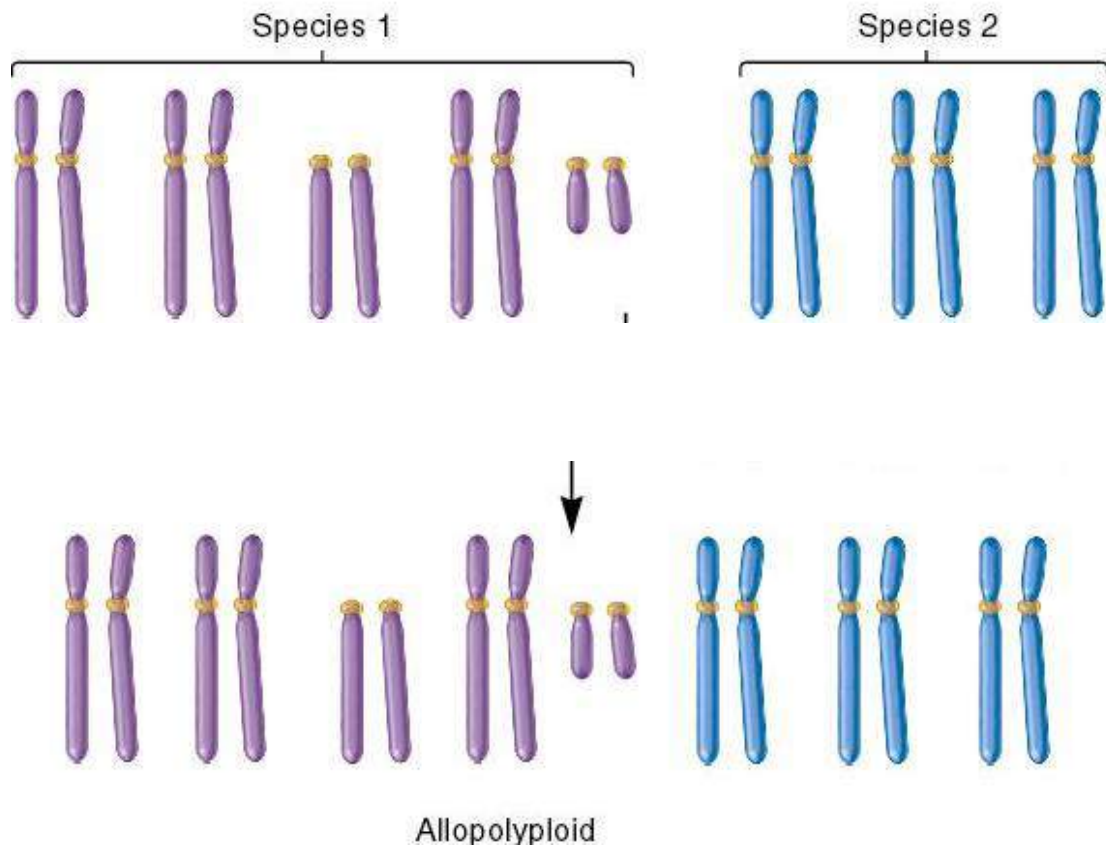

**Colchicine to promote polyploidy:** Polyploidy and allopolyploid plants often exhibit desirable traits. Colchicine is used to promote polyploidy Colchicine binds to tubulin, disrupting microtubule formation and blocks chromosome segregation.

## Allopolyploidy Resulting from Viable Matings between Two Species

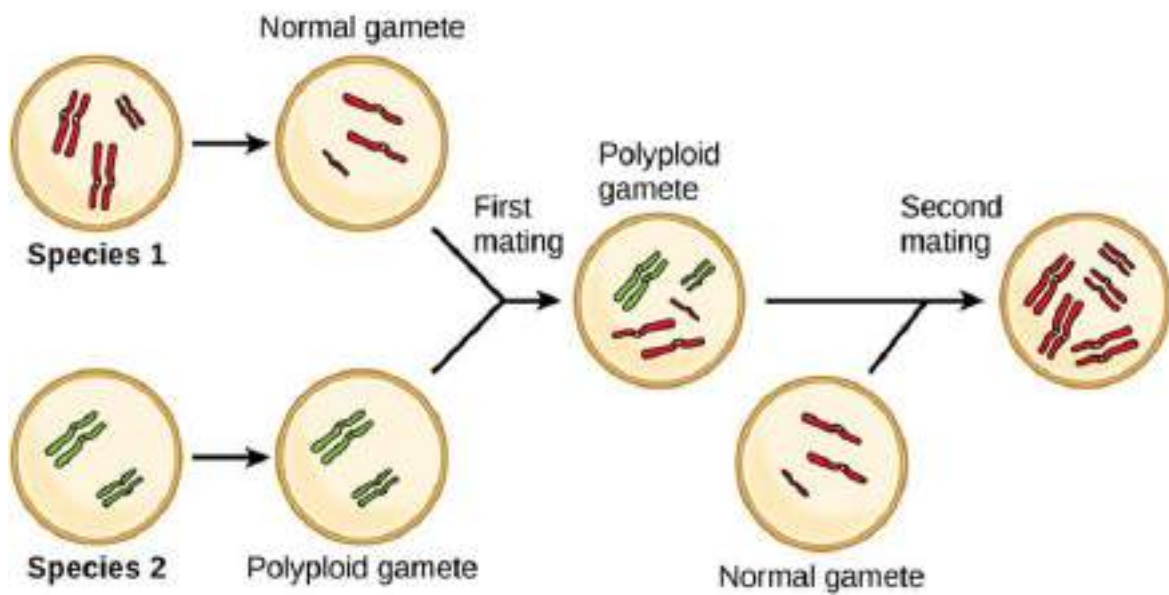

### Allopolyploidy

An interspecies cross results in allopolyploidy.

<b>Mother donkey</b>	<b>+</b>	<b>Father horse:</b>	
<b>Offspring is a <b>hinny</b> (sterile)</b>			
<b>Domestic mare</b>	<b>+</b>	<b>Father zebra:</b>	
<b>Offspring is a <b>zebra hinny</b> (sterile)</b>			

## Lesson 117

**Aneuploidy:** Change in chromosomes number can occur by the addition/deletion of chromosome or part of a chromosome.

**Euploidy:** Gain of one or more complete sets of chromosomes

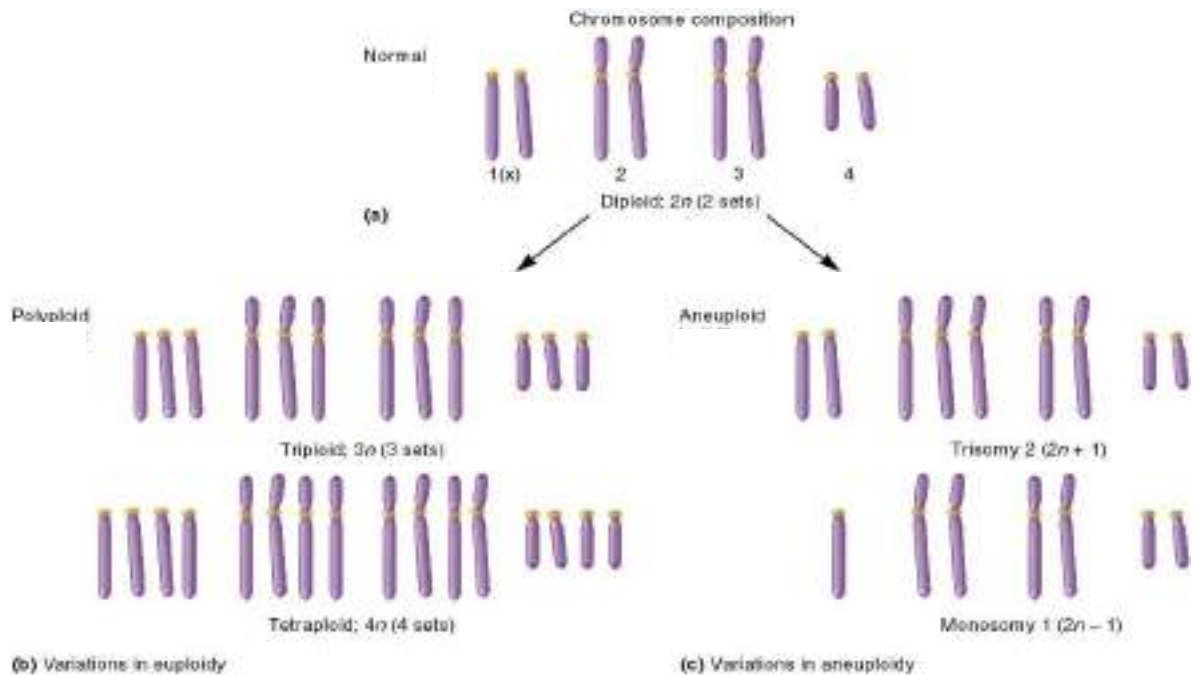

### Aneuploidy

Nullisomy

Monosomy

Trisomy

Tetrasomy

### Euploidy

Triploid

Tetraploid

Pentaploid

## **Comparison**

**Aneuploidy:** change in chromosomes number.

**Euploidy:** gain of one or more complete sets of chromosomes

## Lesson 118

**Chromosomal deletions:** Deletions of larger portions are usually incompatible with life. 10-15% is due to balanced translocations in one parent. 85-90% are true deletions.

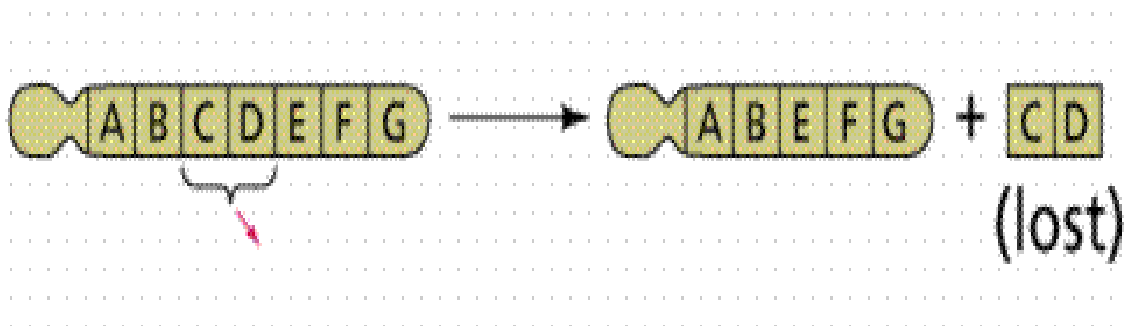
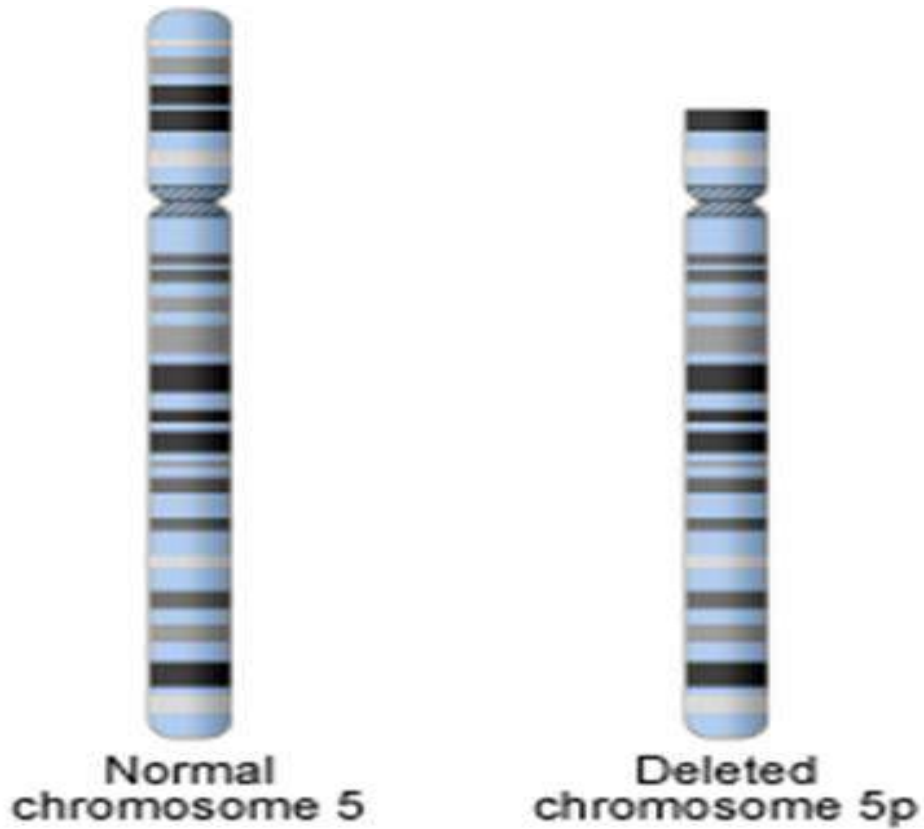



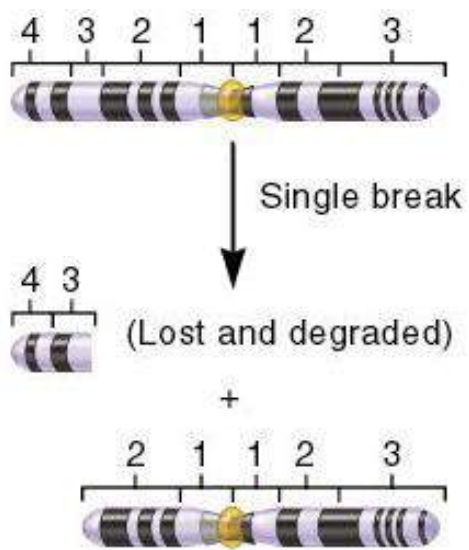

**(a) Terminal deficiency**

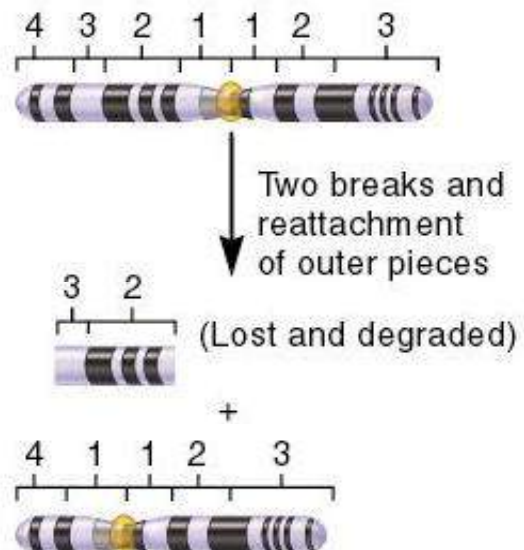

**(b) Interstitial deficiency**

Phenotypic consequences of deficiency depends on

- Size of the deletion
- Functions of genes

Deleted Phenotypic consequences of deficiency depends on

- Phenotypic effect of deletions usually detrimental.

## Deletions – interstitial

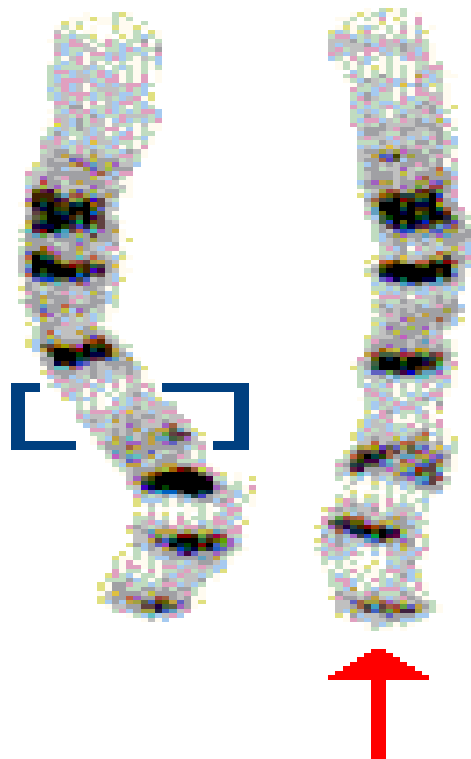

## Interstitial deletion at 16

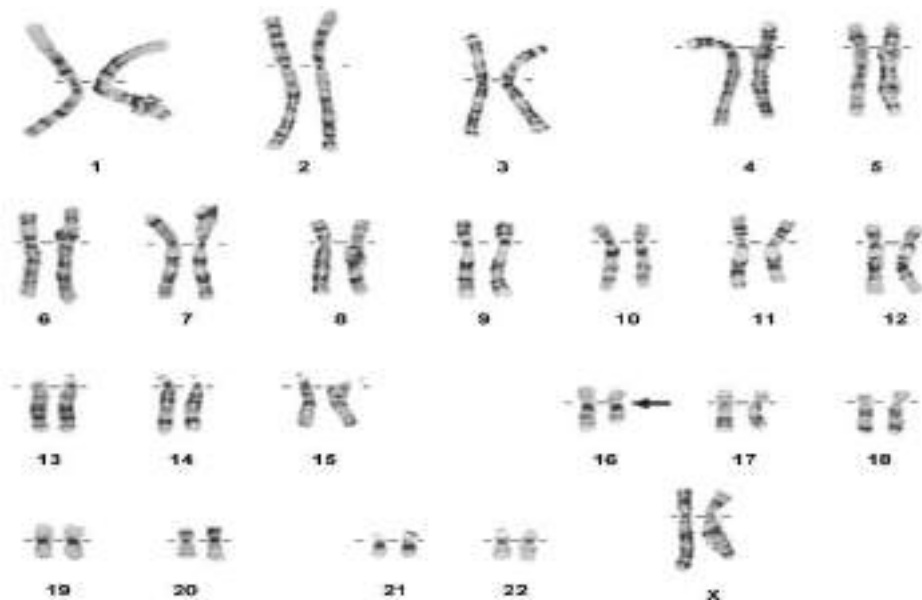

## Deletion – terminal in Cri-du-chat Syndrome

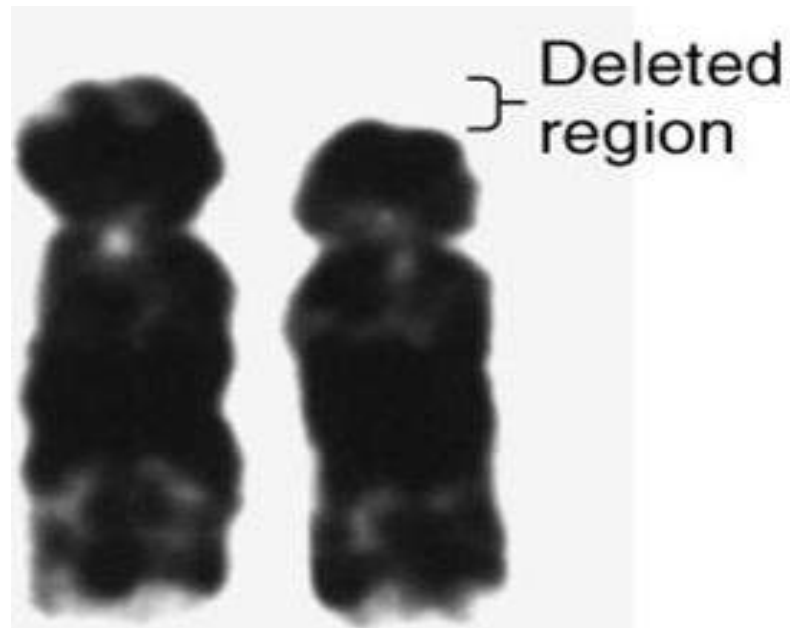

## Terminal deletion in chromosome 6

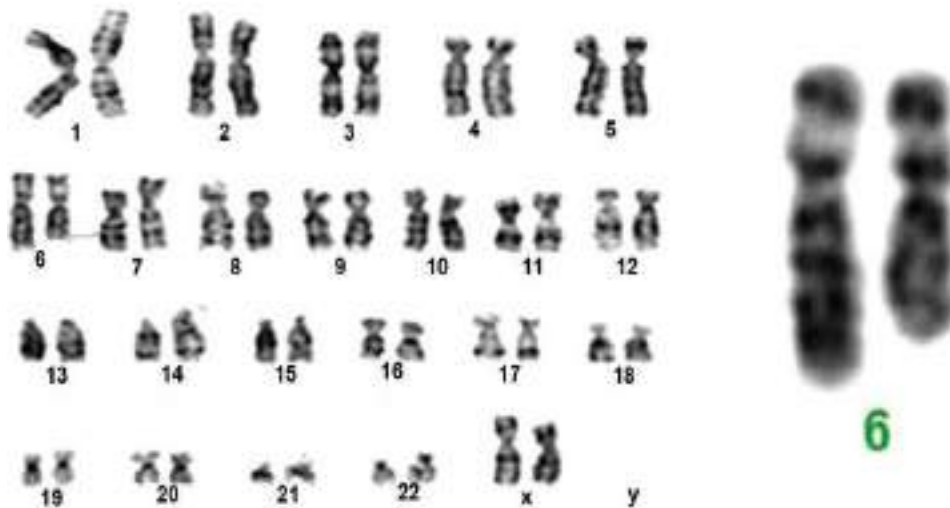

## Type of Deletions

- Terminal – from one end
- Interstitial – two breaks and middle part is lost
- Micro deletions

## Lesson 119

**Chromosomal duplication:** Gene duplication (or chromosomal duplication) is a major mechanism through which new genetic material is generated during molecular evolution

### Chromosomal Duplications

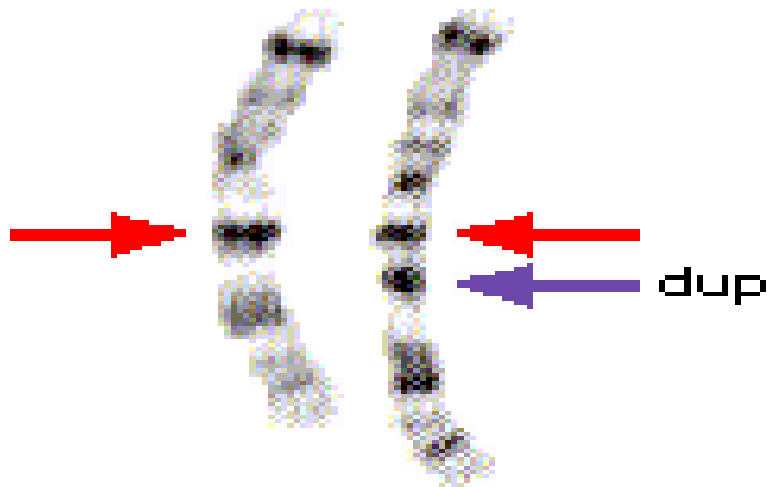

**Causes of Duplications – DNA replication:** Gene duplications can arise as products of several types of errors in DNA replication and repair machinery. Common sources of gene duplications include ectopic homologous recombination.

**Ectopic recombination - misaligned homologous** Duplications arise from an event termed unequal crossing-over that occurs during meiosis between misaligned homologous chromosomes.

**Other Causes of Duplications** Retro-transposition event, aneuploidy, polyploidy, and replication slippage are also cause of duplications.

**Replication slippage:** Replication slippage is an error in DNA replication that can produce duplications of short genetic sequences. During replication DNA polymerase begins to copy the DNA.

## Duplications

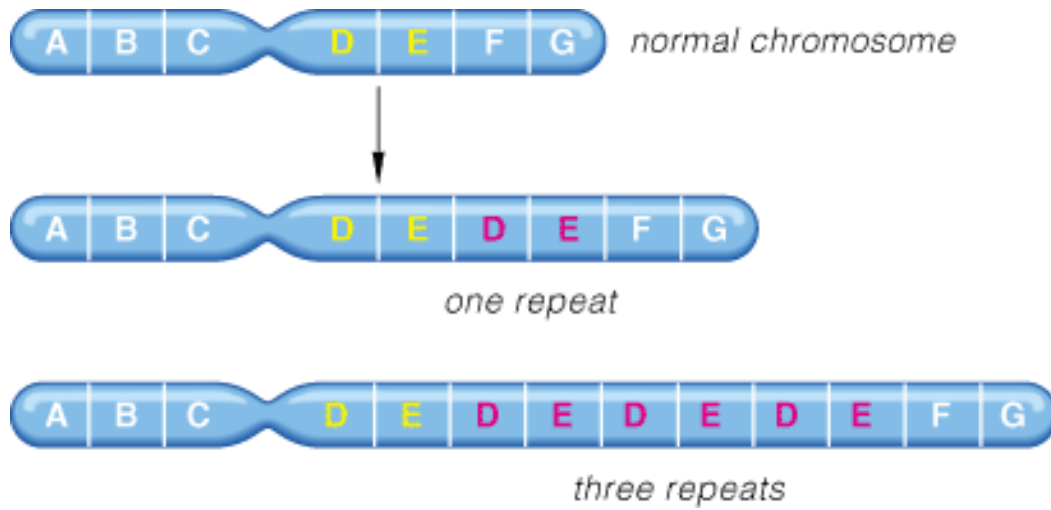

**Dispersed and tandem duplications:** Some duplication is “dispersed”, found in different locations from each other. Tandem duplications found next to each other.

**Tandem duplications become pseudo-genes:** These extra copies can then mutate to take on altered roles in the cell, or they can become pseudogenes, inactive forms of the gene, by mutation.

## Lesson 120

### Chromosomal Inversions

- Two breaks re-arrangement
- Segment is reversed
- Pericentric – when centromere is involved
- Paracentric – only one arm is involved

There is no loss of genetic information. Many inversions have no phenotypic consequences. Sometimes break point effects are within regulator or structural portion of a gene.

**Chromosomal inversions affects gene expression** Gene is re-positioned in a way that alters its gene expression. ~ 2% of the human population carries karyotypically detectable inversions.

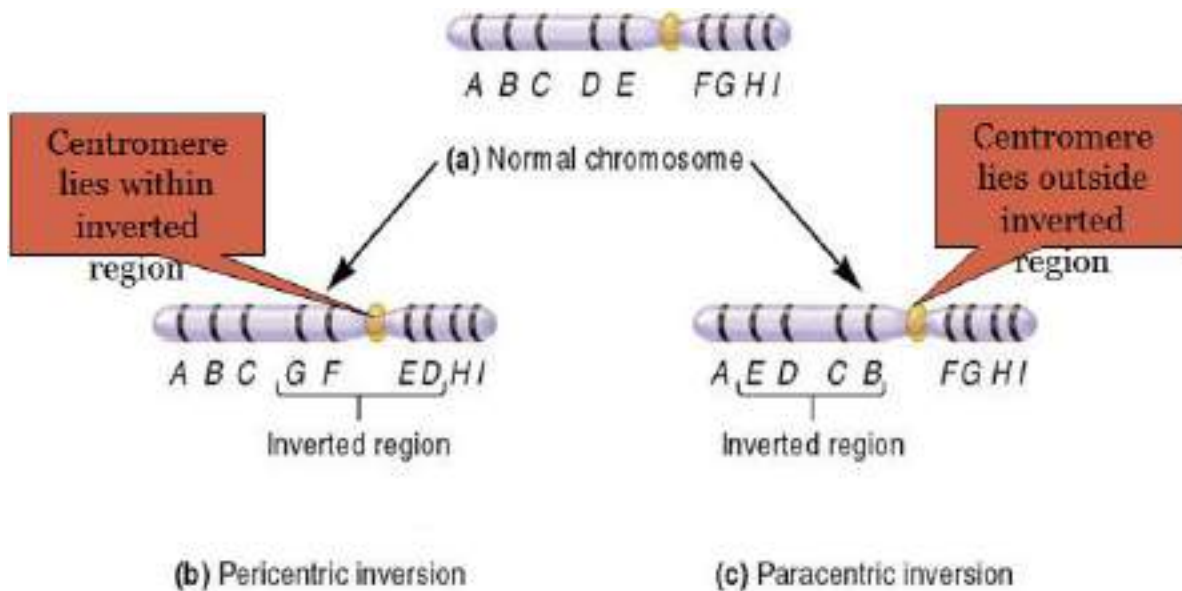

**Inversion Heterozygotes:** Individuals with one copy of a normal chromosome and one copy of an inverted chromosome. Usually phenotypically normal

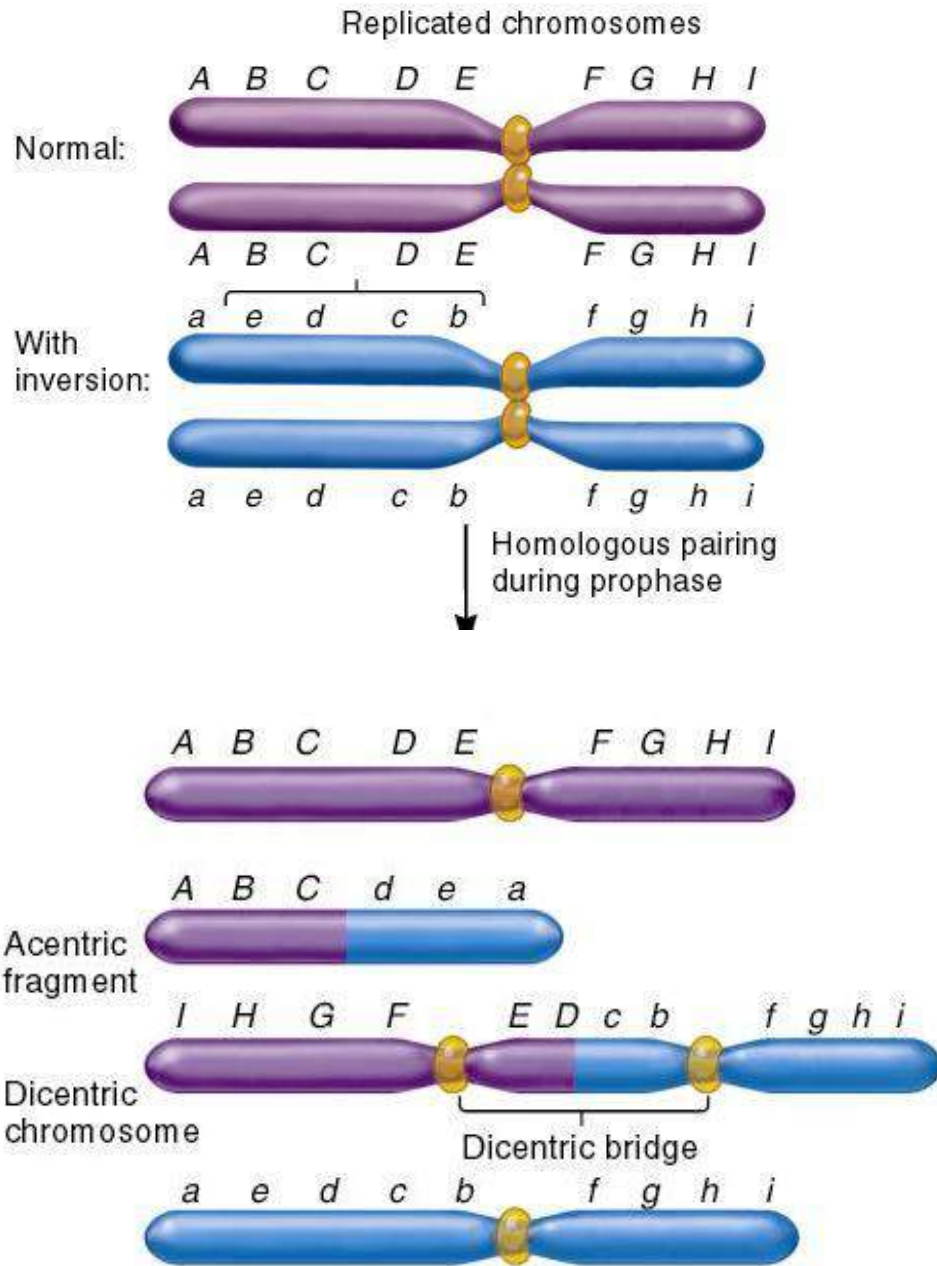

**Chromosomal Inversion:** The most common inversion seen in humans is on chromosome 9, at inv (9)(p12q13). This inversion is generally considered to have no harmful effects, but increased risk for miscarriage or infertility.

## Lesson 121

**Ring chromosome:** A ring chromosome is a chromosome whose arms have fused together to form a ring. A ring chromosome is denoted by the symbol r in human genetics or R in drosophila genetics.

**Ring chromosome due to mutagens:** Ring chromosomes may form in cells following genetic damage by mutagens like radiation.

**Ring chromosome formation – lost arms:** both ends of the chromosome must usually be lost, enabling the arms to fuse together. Ring formation can also occur with only one end being lost.

**Telomeres of chromosomes fuse to form ring:** In rare cases, the telomeres at the ends of a chromosome fuse without any disappearance of genetic material.

**Ring chromosome** 20% cases of Turner's syndrome are due to ring chromosome.

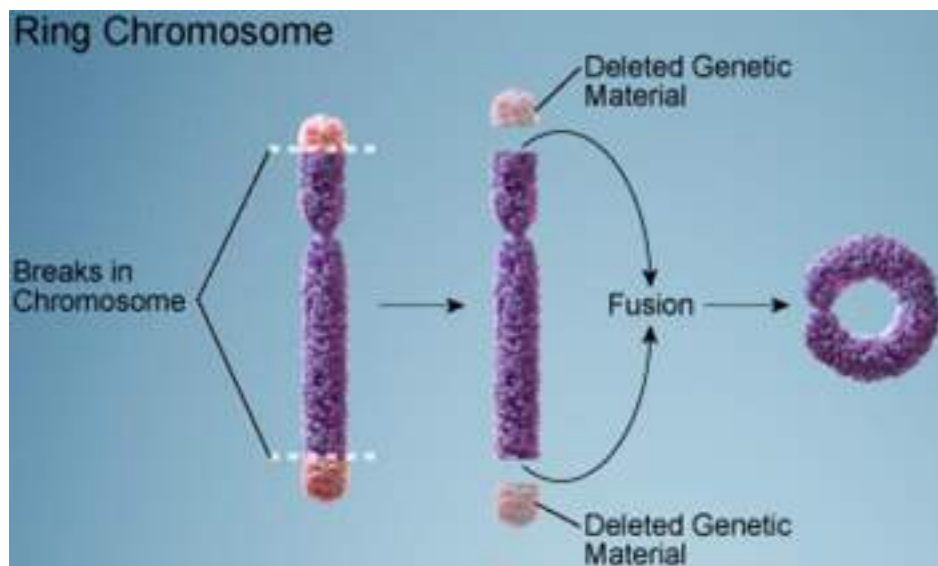



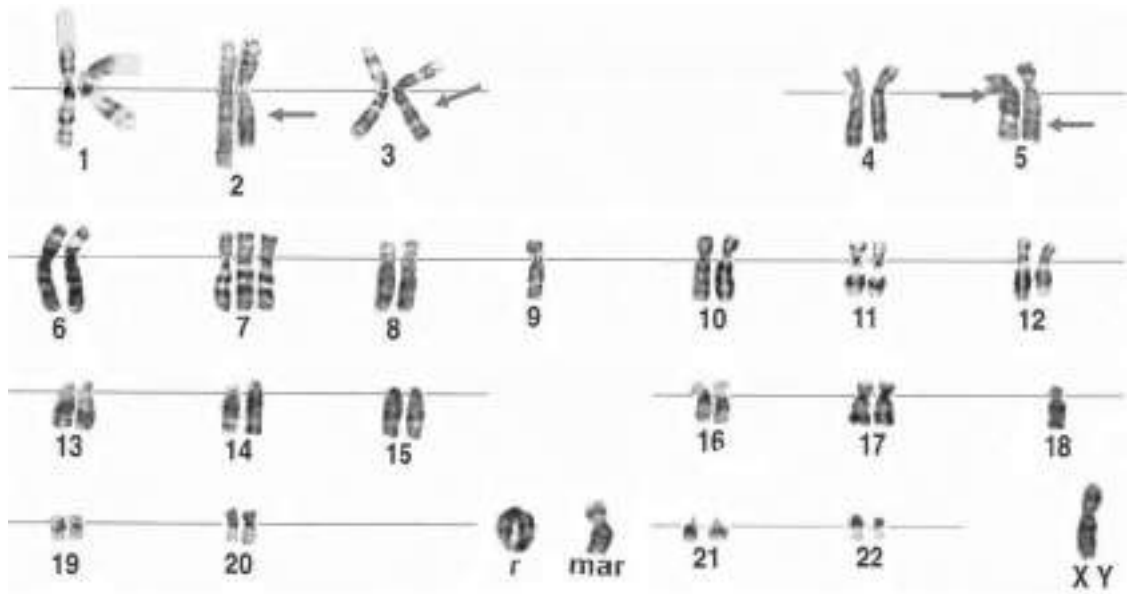

**Philadelphia chromosome:** Philadelphia chromosome is a specific chromosomal abnormality that is associated with chronic myelogenous leukemia (CML). Reciprocal translocation between chromosome 9 and chromosome 22, which is specifically designated  $t(9;22)(q34;q11)$ .

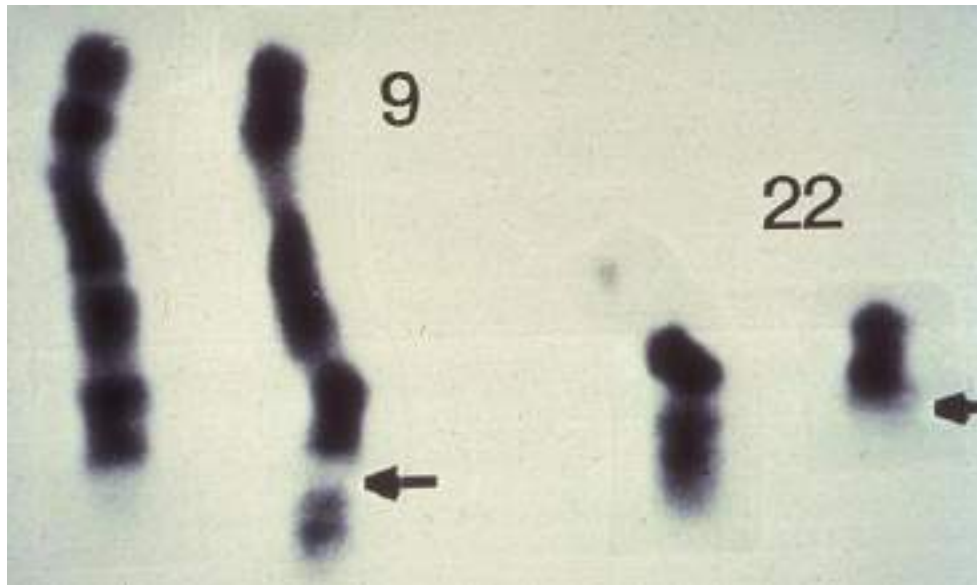

### Formation of Philadelphia

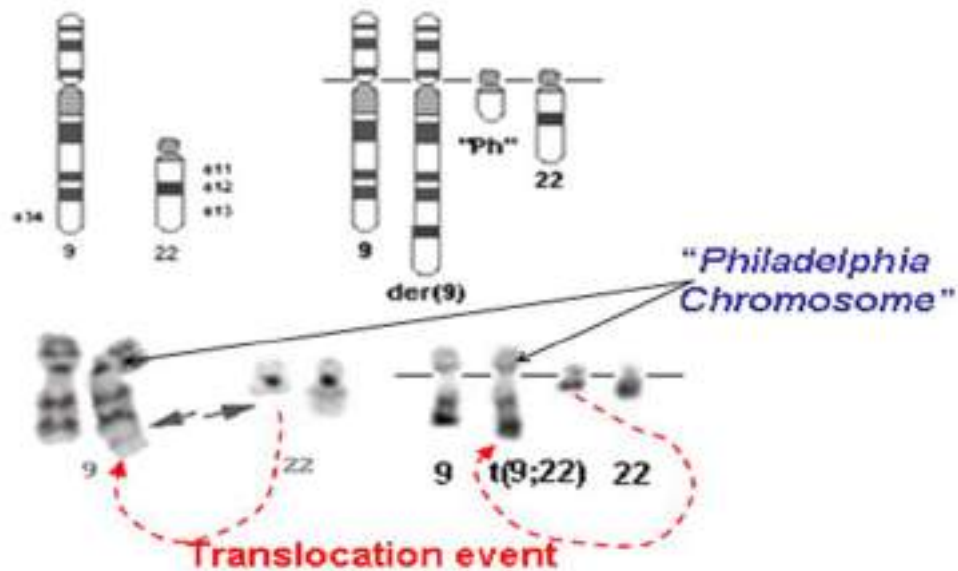

**Ring and Philadelphia chromosome** Fusion of ends of chromosomes to form a ring is ring chromosome. Fusion of segments of chromosomes 9 and 22 is Philadelphia chromosome.

## Lesson 122

**Mutation:** In some disciplines the term "mutation" is used to indicate "a change" while in other disciplines it is used to indicate "a disease-causing change".

**Sequence/ allelic variant** some geneticists do not use term mutation. They use neutral terms like "sequence variant", "alteration" and "allelic variant" "Mutations occurs at a frequency of about 1 in every 1 billion base pairs. Every individual has about 6 mutations in each cell in their body.

### Effect of mutation:

- Mutations may be harmful.
- Mutations may be beneficial.
- Mutations may have no effect on the organism.

### Mutation at DNA level



**Mutation and variation** Mutations are a major source of genetic variation in a population increasing biodiversity. Some variations may help to survive better and longer. Mutations in gametes (egg & sperm) are passed onto offspring. Mutations in body cells only affect the organism in which they occur and are not passed onto offspring.

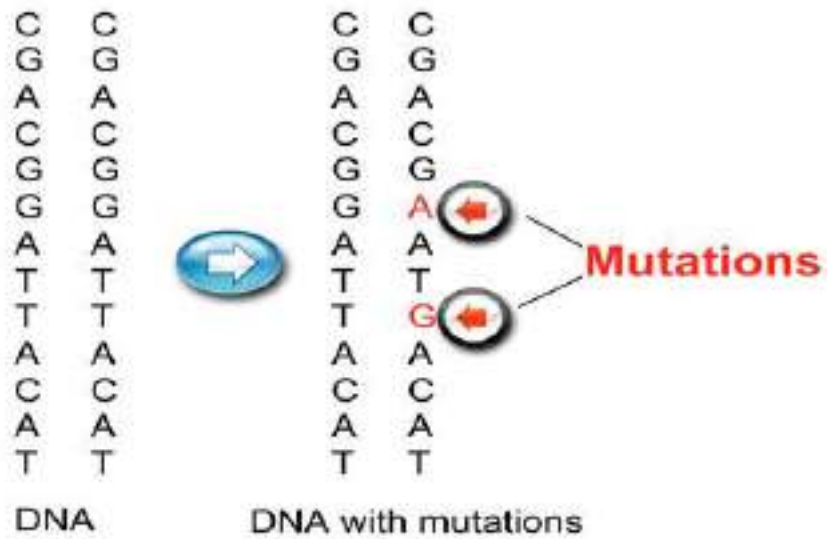

## Lesson 123

**Types of mutation:** Followings are the types of mutations.

- Points Mutations
- Variations in chromosomes number
- Variations in chromosomes structure
  
- **Point mutation**
  - Base Pair Substitutions
    - Silent
    - Missense
    - Nonsense
  - Base pair insertions/deletions
    - Triplet Repeats
    - Frameshift
  
- **Variation in Chromosome Number**
  - Aneuploidy
    - Hyperploidy, Hypoploidy
  - Euploidy
    - Monoploidy, Diploidy, Polyploidy
  
- **Variation in chromosome structure**
  - Deletions
  - Translocations
  - Duplications
  - Inversions

## Mutations and effects

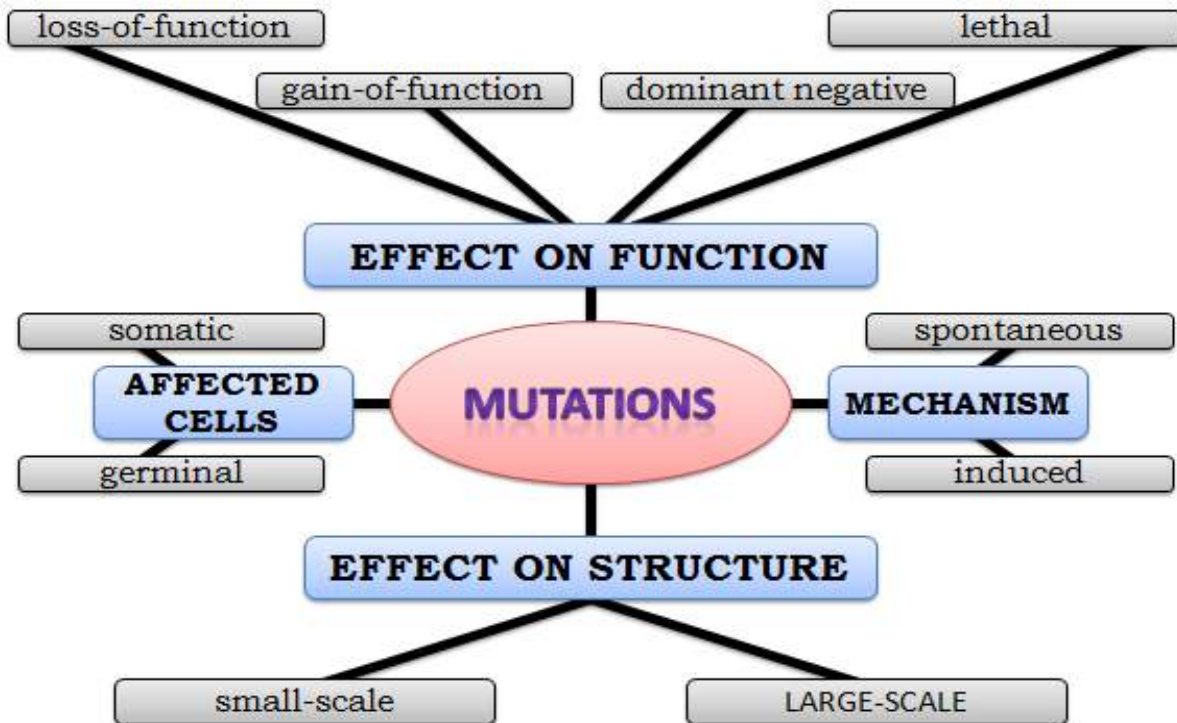

## Major types of mutations

- Points Mutations
- Variations in chromosomes number
- Variations in chromosomes structure

## Lesson 124

### Somatic and Germline mutation

**Somatic mutation:** Arise in the somatic cells. Passed on to other cells through the process of mitosis. Effect of these mutations depends on the type of the cell in which they occur.

**Germline mutation:** They occur in the cells that produce gametes. This type of mutation usually passed on to future generation. In multicellular organisms, the term mutation is generally used for germ line mutations.

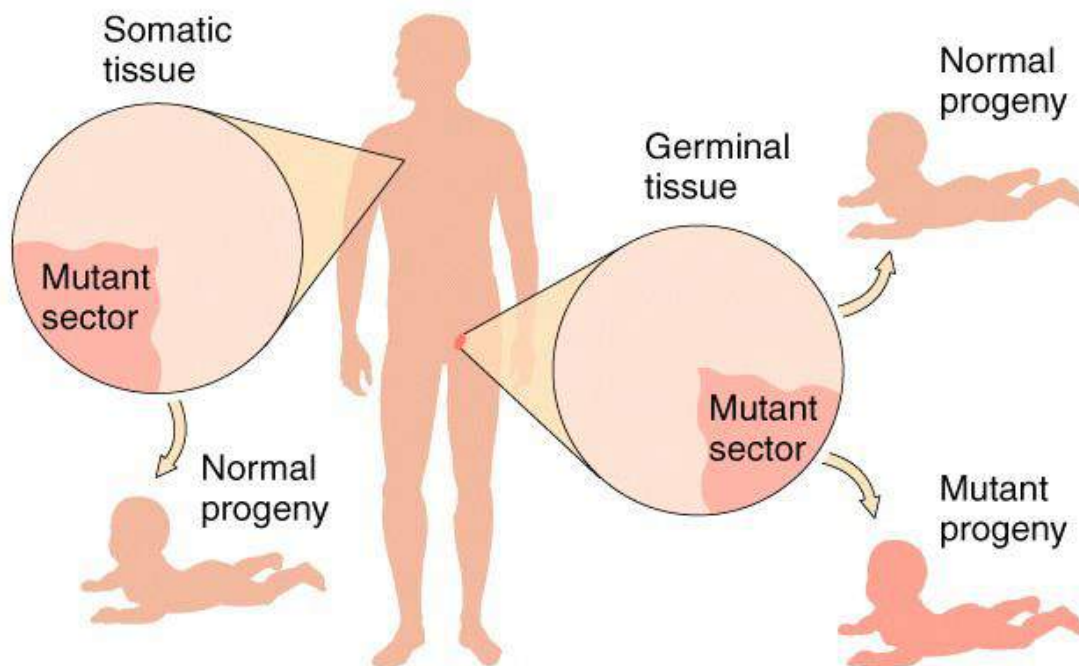

### Methods to classify mutations:

Followings are the methods to classify mutations.

- On the basis of the molecular nature of the defect
- On the nature of the phenotypic effect
- On basis of the causative agent

## Lesson 125

### **Mutation - Forward, Reverse and Neutral**

**Wild type** most common phenotype in natural populations of the organism is called as wild type phenotype. The effect of mutation is considered with reference to wild type phenotype.

**Forward mutation:** Mutation that alters the wild type phenotype into mutant phenotype.

**Reverse mutation:** Mutation that changes a mutant phenotype back into the wild type.

**Neutral mutation:** Mutation that alters the amino acid sequence of the protein but does not change its function as replaced amino acid is chemically similar or the affected AA has little influence on protein function.



## Lesson 126

### Loss of function, Gain of function

**Loss of function:** Complete or partial loss of the normal function. Structure of protein is so altered that it is no longer works correctly. Mutation can occur in regulatory regions that affect transcription, translation or splicing of the protein. Frequently recessive

**Gain of function:** Produces an entirely new trait. Such a mutation causes a trait to appear in inappropriate tissues or at inappropriate times in development. It **is** frequently dominant.

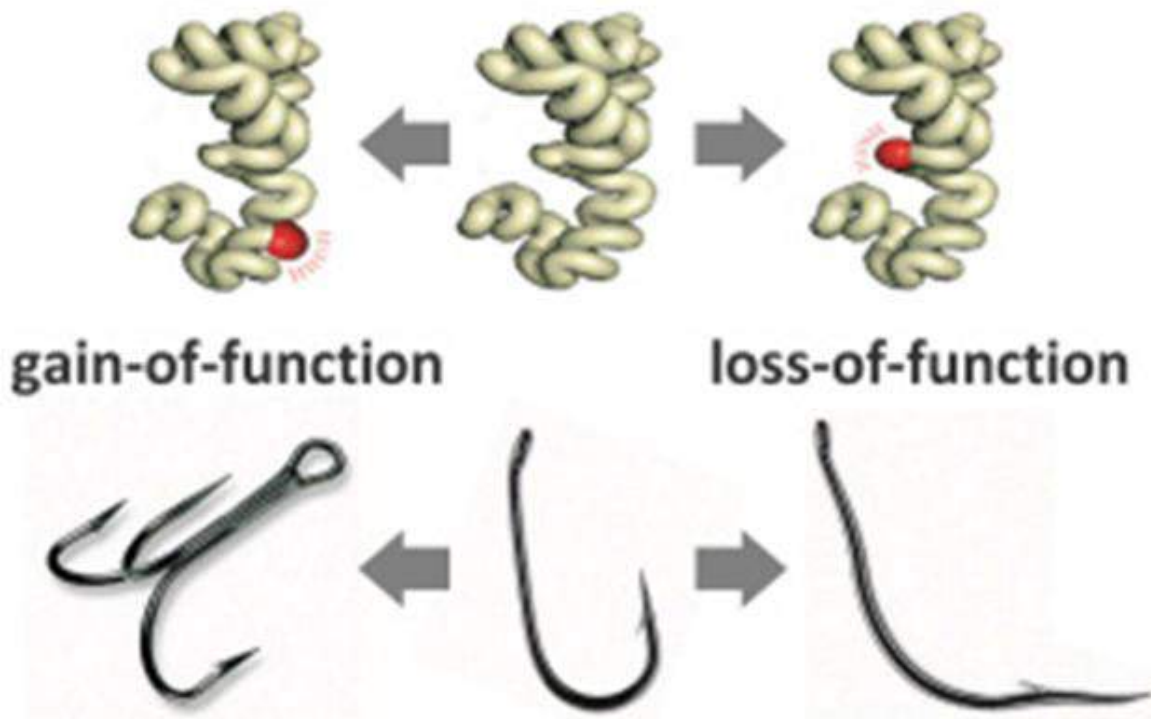

**Conditional mutation:** Expressed only under certain conditions. E.g. A temperature-sensitive mutation can cause cell death at high temperature, but might have no deleterious effects at a lower temperature.

**Lethal mutation:** Causes the death of the organism. Death does not have to occur immediately, it may take several months or even years. Longevity of an individual is significantly reduced.

## Lesson 127

### Spontaneous and Induced mutation

**Spontaneous mutation:** Mutations that result from natural changes in DNA

#### Origins of Spontaneous mutation

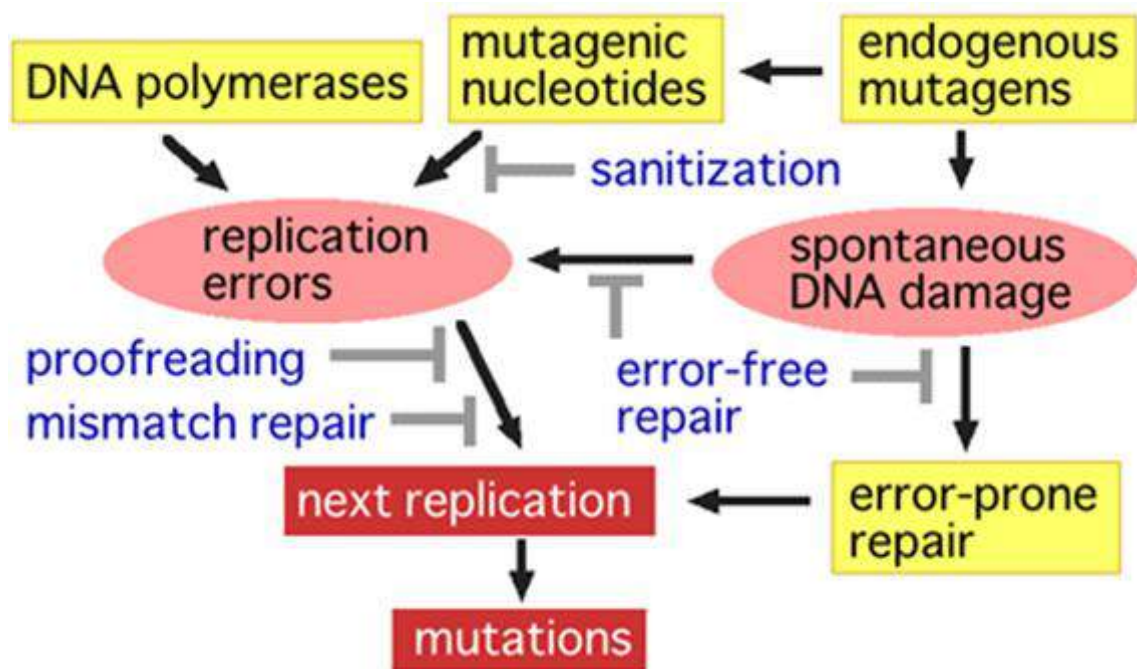

**Induced mutation** results from changes caused by environmental, chemicals and radiations.

**Mutagen:** Any environmental agent that increases the rate of mutation above the spontaneous is called a mutagen such as chemicals & radiations, X-rays, Mustard gas etc

**Base analogs:** Chemicals with structures similar to that of any of the four standard bases of DNA. DNA polymerases cannot distinguish these analogs. They may be incorporated into newly synthesized DNA molecules

**Base analogs:** 5 bromouracil is an analog of thymine

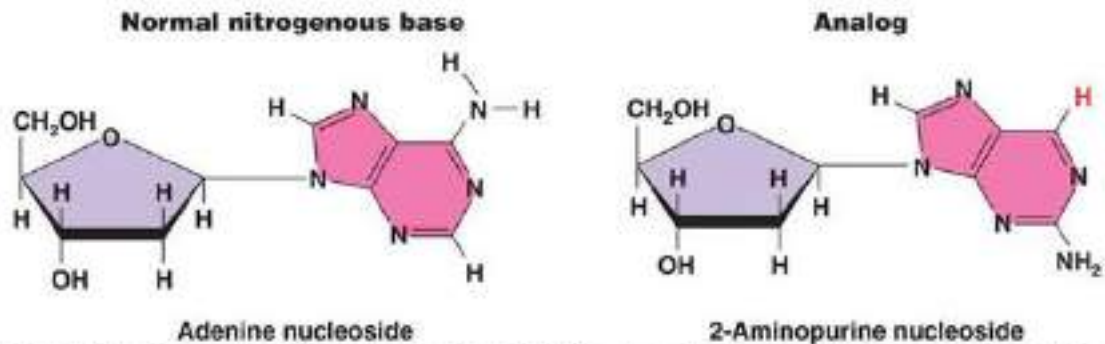
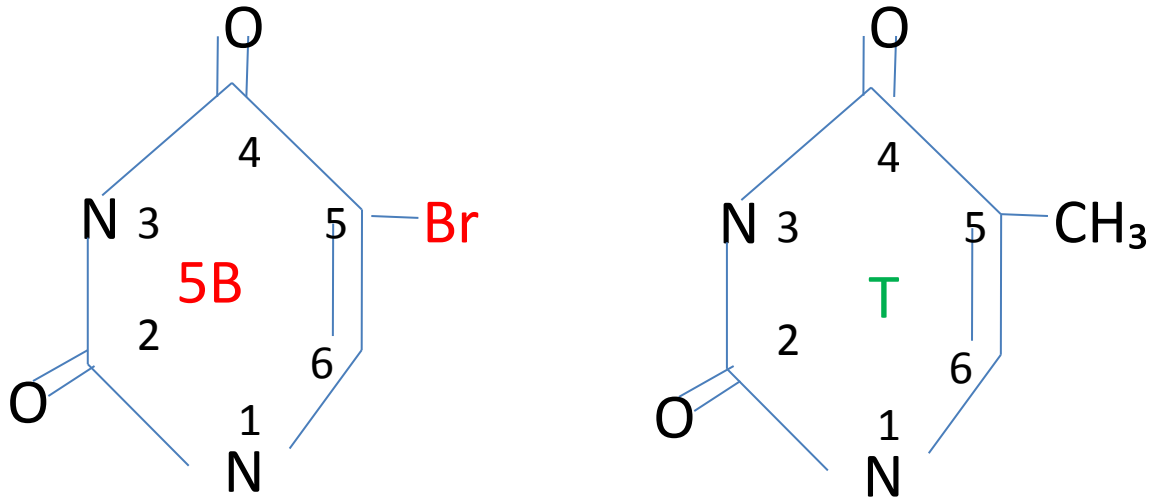

**(a)** The 2-aminopurine is incorporated into DNA in place of adenine but can pair with cytosine, so an AT pair becomes a CG pair.

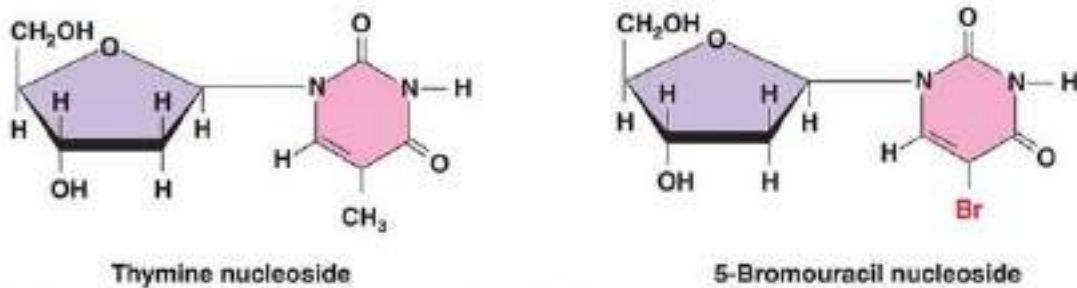

**(b)** The 5-bromouracil is used as an anticancer drug because it is mistaken for thymine by cellular enzymes but pairs with cytosine. In the next DNA replication, an AT pair becomes a GC pair.

## Lesson 128

**Suppressor mutation:** Suppresses the effect of other mutation. Suppressor mutation occurs at a site different from the site of original mutation. Organism with a suppressor mutation is a double mutant but exhibits the phenotype of unmutated wild type. Different from reverse mutation in which mutated site is reverted back into the wild type sequence. Genetic suppression therefore restores the phenotype seen prior to the original background mutation. Suppressor mutations are useful for identifying new genetic sites which affect a biological process of interest.

**Intragenic suppression:** Intragenic suppression results from suppressor mutations that occur in the same gene as the original mutation. Intergenic (extragenic) suppression relieves the effects of a mutation in one gene by a mutation somewhere else within the genome. Second mutation is not on same gene as original mutation

## Lesson 129

### Point mutations:

- Point mutations affect single sites on DNA.
- Substitution of one base for another.
- Deletion/addition of a single base or small number of bases.

**Transition:** If purine (A/G) or pyrimidine (T/C) substitutes for itself = transition substitution

**Transversion:** If purine substitutes for pyrimidine or vice versa = transversion substitution

### Results of point mutations

- Silent mutations
- Missense mutations
- Nonsense mutations

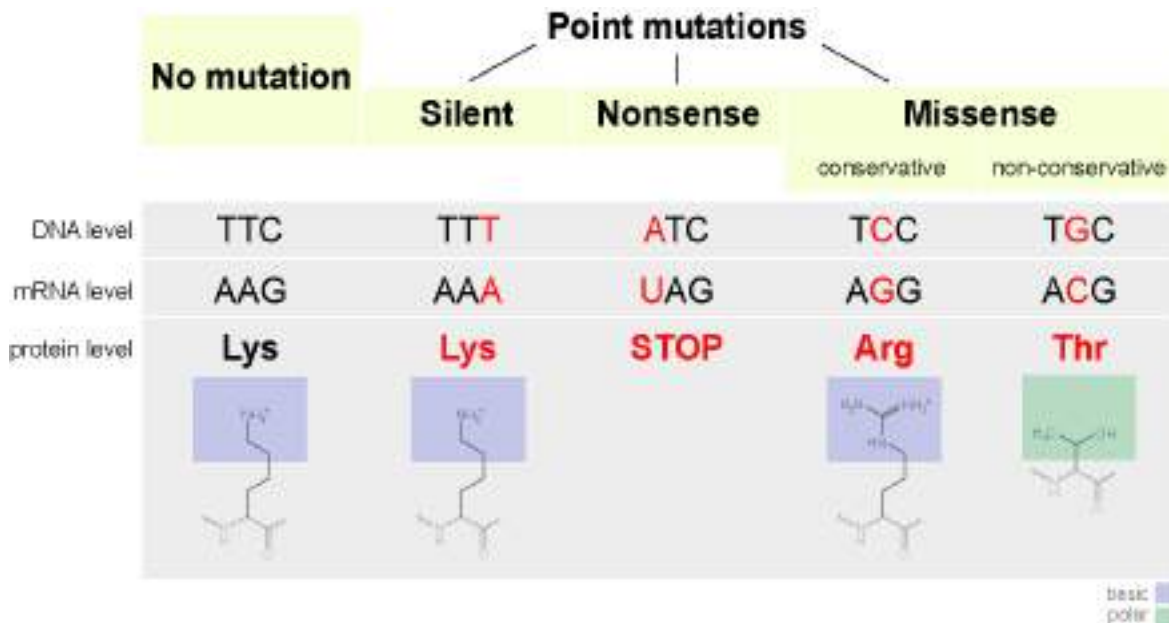

## Lesson 130

**Silent Mutation:** These types of mutations have affected the DNA sequence but not the protein. They have no effect on the organism's phenotype. Since the genetic code is degenerate, several codons produce the same amino acid. Third base changes often have no effect on the amino acid sequence of the protein.

		second base in codon				
		U	C	A	G	
first base in codon	U	UUU Phe	UCU Ser	UAU Tyr	UGU Cys	U C A G
		UUC Phe	UCC Ser	UAC Tyr	UGC Cys	
		UUA Leu	UCA Ser	UAA stop	UGA stop	
		UUG Leu	UCG Ser	UAG stop	UGG Trp	
	C	CUU Leu	CCU Pro	CAU His	CGU Arg	U C A G
		CUC Leu	CCC Pro	CAC His	CGC Arg	
		CUA Leu	CCA Pro	CAA Gln	CGA Arg	
		CUG Leu	CCG Pro	CAG Gln	CGG Arg	
	A	AUU Ile	ACU Thr	AAU Asn	AGU Ser	U C A G
		AUC Ile	ACC Thr	AAC Asn	AGC Ser	
		AUA Ile	ACA Thr	AAA Lys	AGA Arg	
		AUG Met	ACG Thr	AAG Lys	AGG Arg	
	G	GUU Val	GCU Ala	GAU Asp	GGU Gly	U C A G
		GUC Val	GCC Ala	GAC Asp	GGC Gly	
		GUA Val	GCA Ala	GAA Glu	GGA Gly	
		GUG Val	GCG Ala	GAG Glu	GGG Gly	

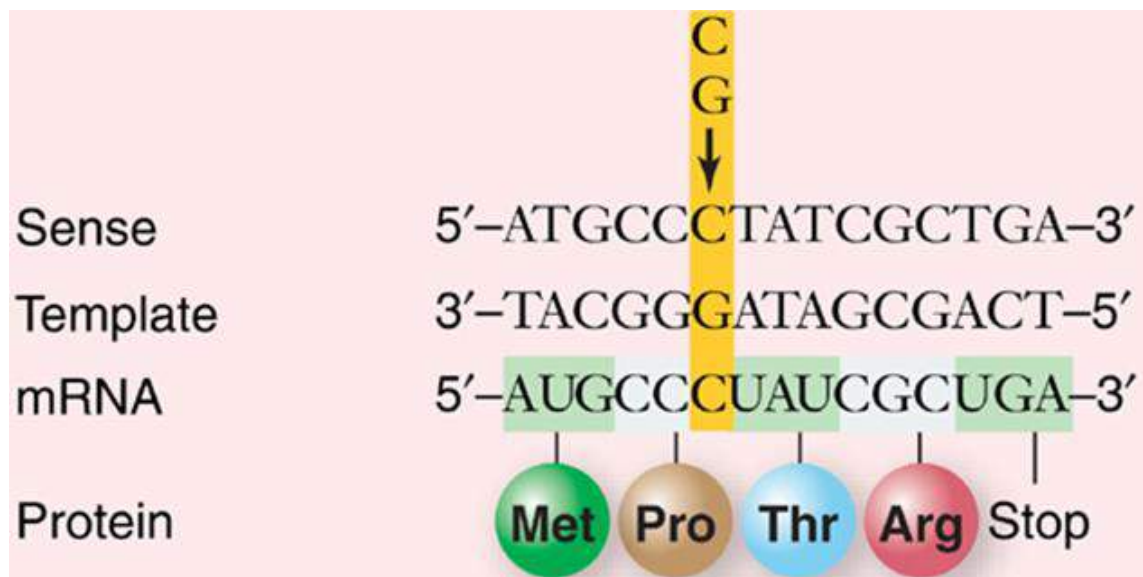
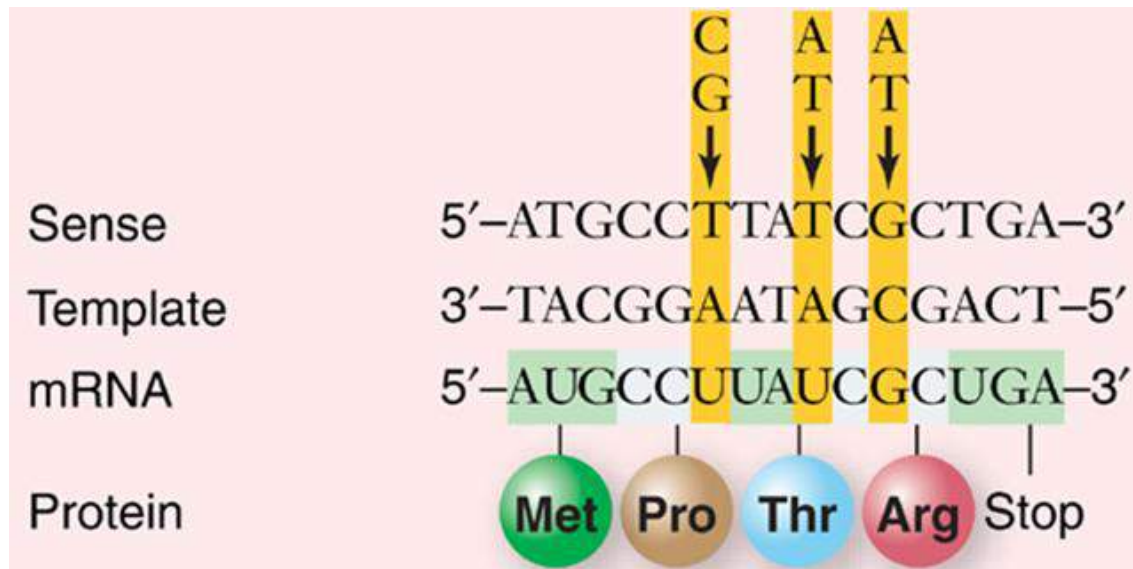

## Lesson 131

**Missense mutation:** Missense mutations substitute one amino acid for another. Some missense mutations have very large effects. Some have minimal or no effect. It depends on where the mutation occurs in the protein's structure and how big a change in the type of amino acid it is. Missense mutation produces a change in amino acid sequence in protein product (e.g. Histidine in for Arginine). May change function of protein or may not!

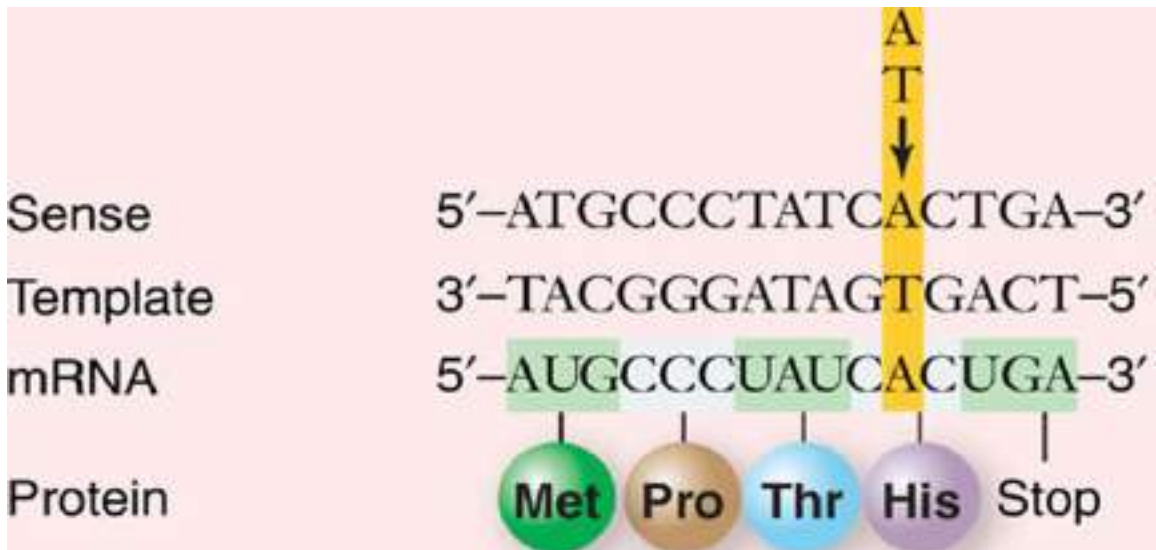
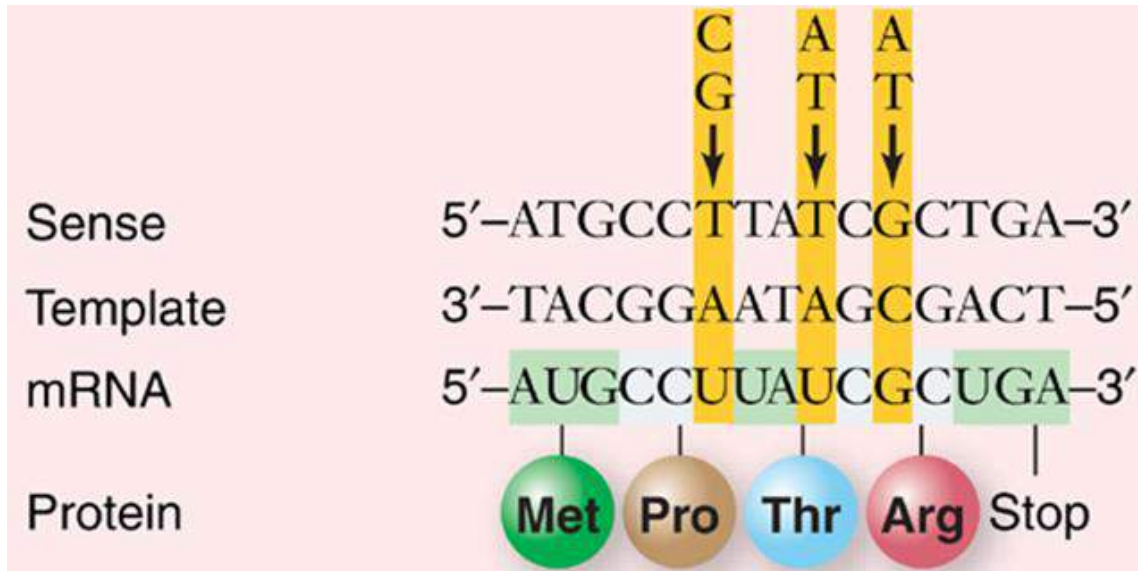



## Lesson 132

**Nonsense mutation:** Nonsense mutations convert an amino acid into a stop codon. The effect is to shorten the resulting protein. Sometimes this has only a little effect, as the ends of proteins are often relatively un-important to function. However, often nonsense mutations result in completely non-functional proteins.

GGTCTCCTCACGCCA



CCAGAGGAGUGCGGU

Pro-Glu-Glu-Cys-Gly

GGTCTCCTCACTCCA



CCAGAAGAGUGAGGU

Pro-Glu-Glu-STOP

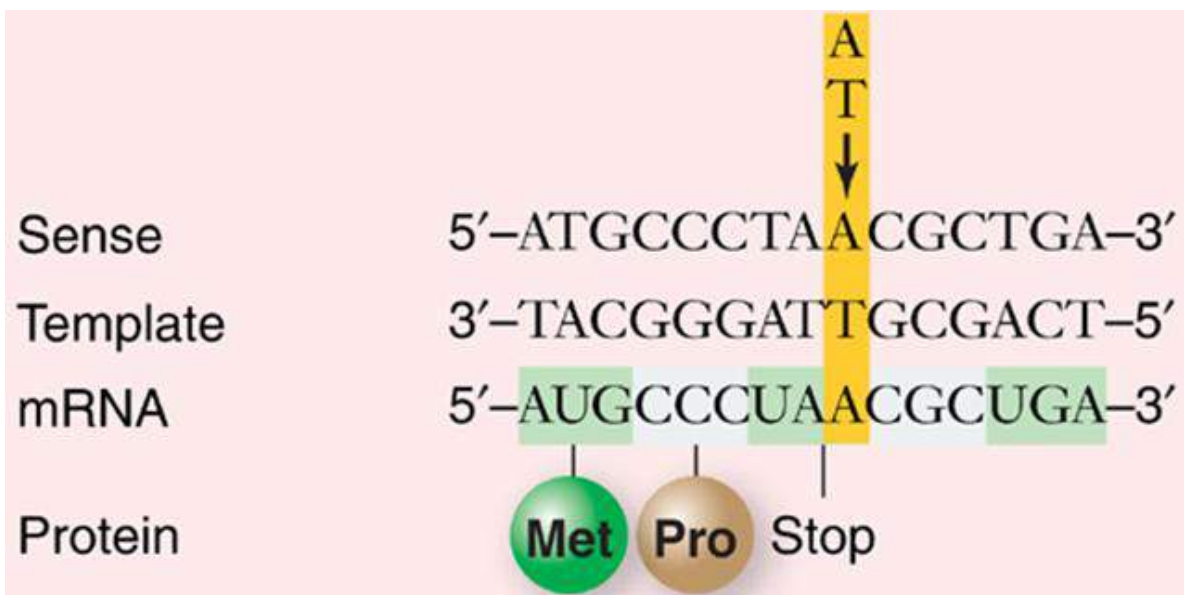
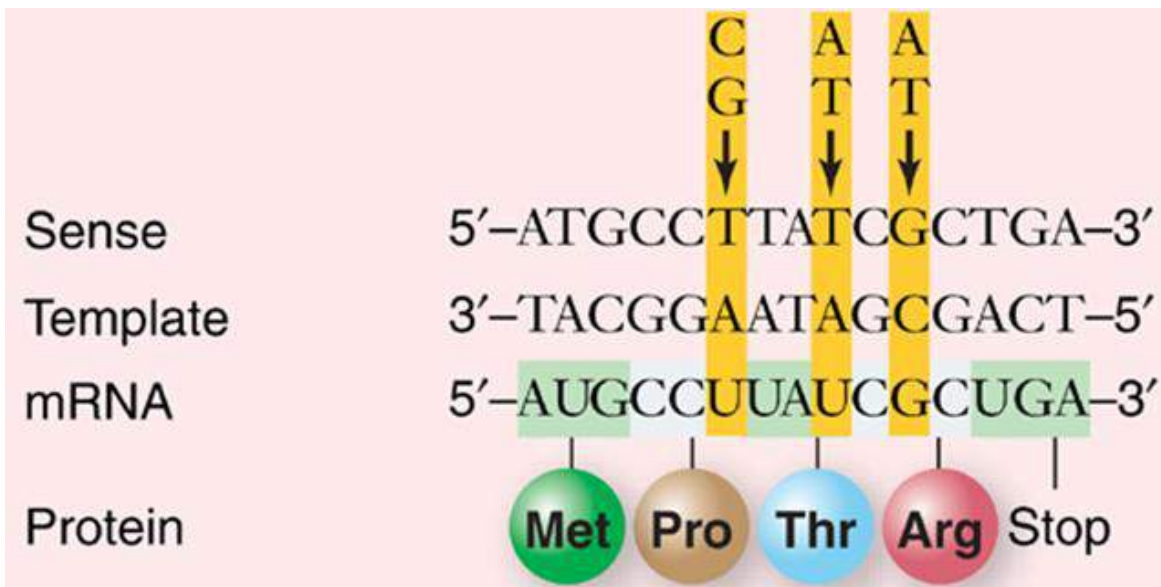

## Lesson 133

**Additions mutation:** Addition mutation is actually results in a frame shift mutation. Often, it has severe effects on protein function. It is also called as insertions.

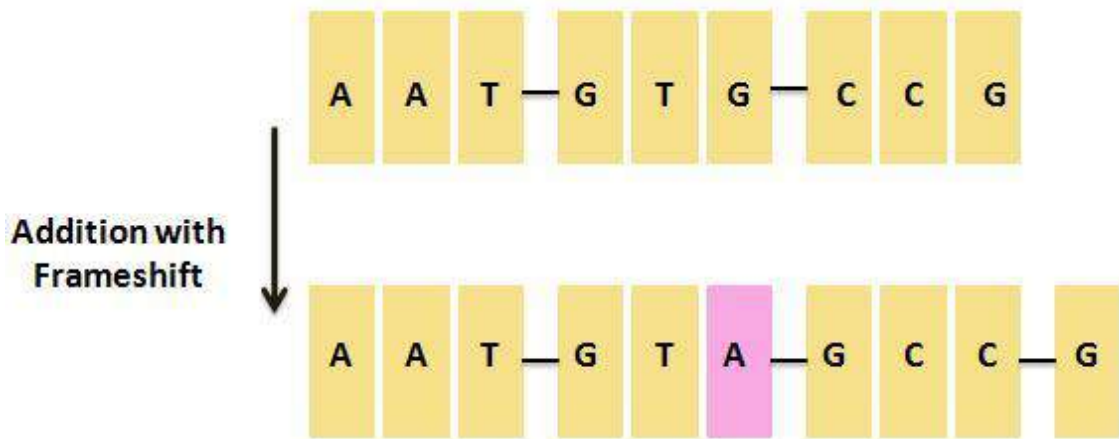

	DNA Sequence	Amino Acid Sequence
Normal:	<div style="display: flex; justify-content: space-around;"> <div style="border: 1px solid black; padding: 2px;">CAG</div> <div style="border: 1px solid black; padding: 2px;">CCC</div> <div style="border: 1px solid black; padding: 2px;">ACT</div> </div> <div style="display: flex; justify-content: space-around; font-size: small; margin-top: 5px;"> <span>Codon 1</span> <span>Codon 2</span> <span>Codon 3</span> </div>	<div style="display: flex; align-items: center;"> <span style="font-size: 2em; margin-right: 10px;">→</span> <div style="display: flex; justify-content: space-around;"> <div style="background-color: #ADD8E6; padding: 5px;">Gln</div> <div style="background-color: #ADD8E6; padding: 5px;">Pro</div> <div style="background-color: #ADD8E6; padding: 5px;">Thr</div> </div> </div>
Insertion Mutation (Frameshift):	<div style="display: flex; justify-content: space-around;"> <div style="border: 1px solid black; padding: 2px;">CAG</div> <div style="border: 1px solid black; padding: 2px; color: red;">TCC</div> <div style="border: 1px solid black; padding: 2px;">CAC</div> <div style="border: 1px solid black; padding: 2px;">T</div> </div> <div style="display: flex; justify-content: space-around; font-size: small; margin-top: 5px;"> <span>Codon 1</span> <span>Codon 2</span> <span>Codon 3</span> <span>Codon 4</span> </div>	<div style="display: flex; align-items: center;"> <span style="font-size: 2em; margin-right: 10px;">→</span> <div style="display: flex; justify-content: space-around;"> <div style="background-color: #ADD8E6; padding: 5px;">Gln</div> <div style="background-color: #FF0000; padding: 5px;">Ser</div> <div style="background-color: #FF0000; padding: 5px;">His</div> <div style="font-size: 2em; margin-left: 10px;">?</div> </div> </div>
Insertion Mutation (Non-frameshift):	<div style="display: flex; justify-content: space-around;"> <div style="border: 1px solid black; padding: 2px;">CAG</div> <div style="border: 1px solid black; padding: 2px; color: red;">TTT</div> <div style="border: 1px solid black; padding: 2px;">CCC</div> <div style="border: 1px solid black; padding: 2px;">ACT</div> </div> <div style="display: flex; justify-content: space-around; font-size: small; margin-top: 5px;"> <span>Codon 1</span> <span>Codon 2</span> <span>Codon 3</span> <span>Codon 4</span> </div>	<div style="display: flex; align-items: center;"> <span style="font-size: 2em; margin-right: 10px;">→</span> <div style="display: flex; justify-content: space-around;"> <div style="background-color: #ADD8E6; padding: 5px;">Gln</div> <div style="background-color: #FF0000; padding: 5px;">Phe</div> <div style="background-color: #ADD8E6; padding: 5px;">Pro</div> <div style="background-color: #ADD8E6; padding: 5px;">Thr</div> </div> </div>

## Lesson 134

**Inversion mutation:** Inversion mutations only affect a small part of the gene.

Normal gene

GGTCTCCTCACGCCA



CCAGAGGAGUGCGGU

*Codons*



Pro-Glu-Glu-Cys-Gly

*Amino acids*

Inversion mutation

GGTCCTCTCACGCCA



CCAGGAGAGUGCGGU



Pro-Gly-Glu-Cys-Gly

## Lesson 135

**Deletions Mutation:** Frameshift mutations result in all amino acids downstream from the mutation site being completely different from wild type. These proteins are generally non-functional.

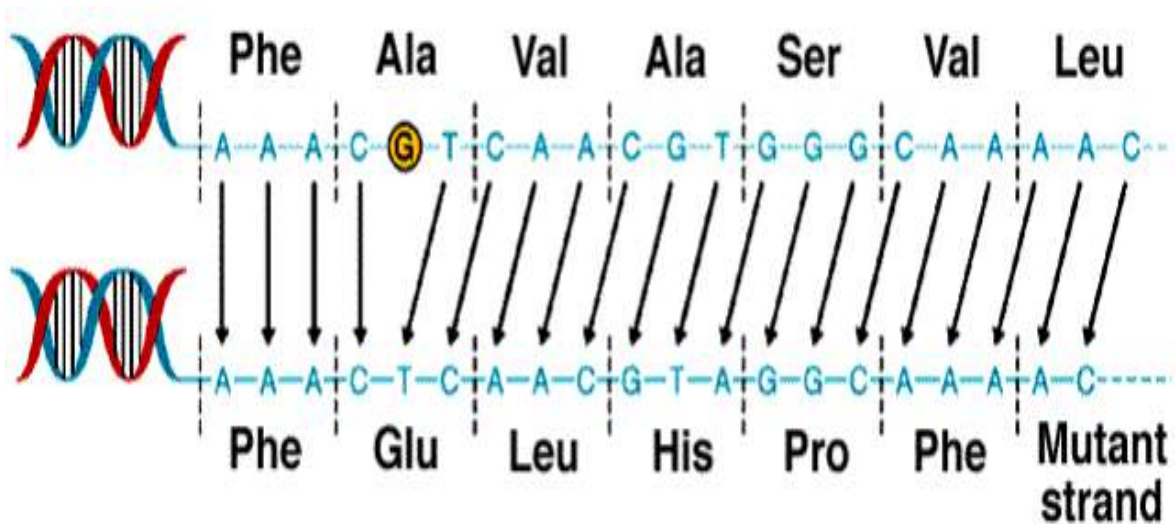
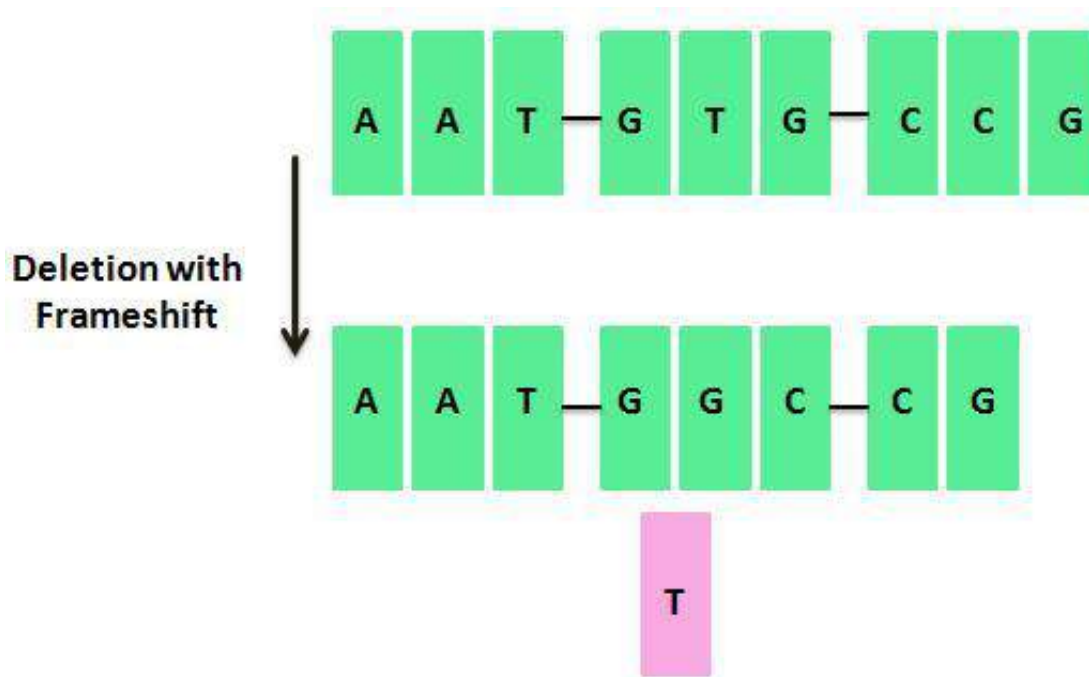

## Deletion mutation

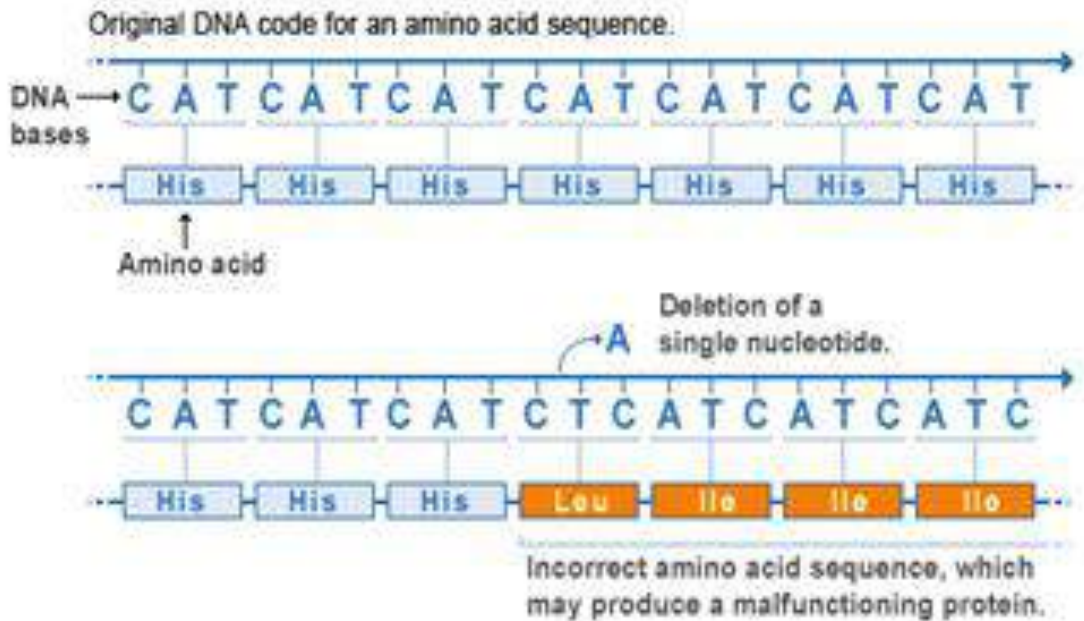

U.S. National Library of Medicine

Deletions - are designated by "del" after the first and last amino acid(s) deleted; p.Lys2del in the sequence MKMGHQCC denotes a deletion of amino acid Lysine-2 (Lys, K).

As another example: p.Cys28\_Met30del denotes a deletion of three amino acids, from Cysteine-28 to Methionine-30

## Lesson 136

### How mutations alter gene function

**Non-coding mutations:** Promoter/enhancer element trinucleotide repeats in 5' and 3'UTRs  
Splice sites

### Effect of mutation on gene function

- Null allele (loss of function) - no gene product.
- Hypomorph – decreased activity.
- Gain of function - increased activity.
- Dominant negative-antagonizes normal product
- Neomorph - novel activity

### Predicting that a gene product won't do the job

- Deletion, nonsense, frameshift of sequence is deleterious.
- Mutation in splice site usually has severe effects.
- Missense mutations depend on location in protein.
- Is it non-conservative
- Is AA conserved in evolution

## Lesson 137

### Mutation nomenclature

- All variants should be described at the most basic level, i.e. DNA level.
- Descriptions should always be in relation to a reference sequence, either a genomic or a coding DNA sequence.
- Although theoretically a genomic reference sequence seems best, in practice a coding DNA reference sequence is preferred.
- Good for promoters, alternative splicing etc.
- When the entire genomic sequence is not known, a cDNA reference sequence should be used.
- To avoid confusion in the description of a variant it should be preceded by a letter indicating the type of reference sequence used.
- Several different reference sequences can be used.
- "c." for a coding DNA sequence (like c.76A>T)
- "g." for a genomic sequence (like g.476A>T)
- "m." for a mitochondrial sequence (like m.8993T>C,)
- "r." for an RNA sequence (like r.76a>u)
- "p." for a protein sequence (like p.Lys76Asn)
- Describing genes / proteins, only official HGNC (HUGO gene nomenclature committee) gene symbols should be used ([www.genenames.org](http://www.genenames.org) )
- DNA reference sequence used should preferably be from the RefSeq database, listing both database accession and version number (like NM\_004006.2)



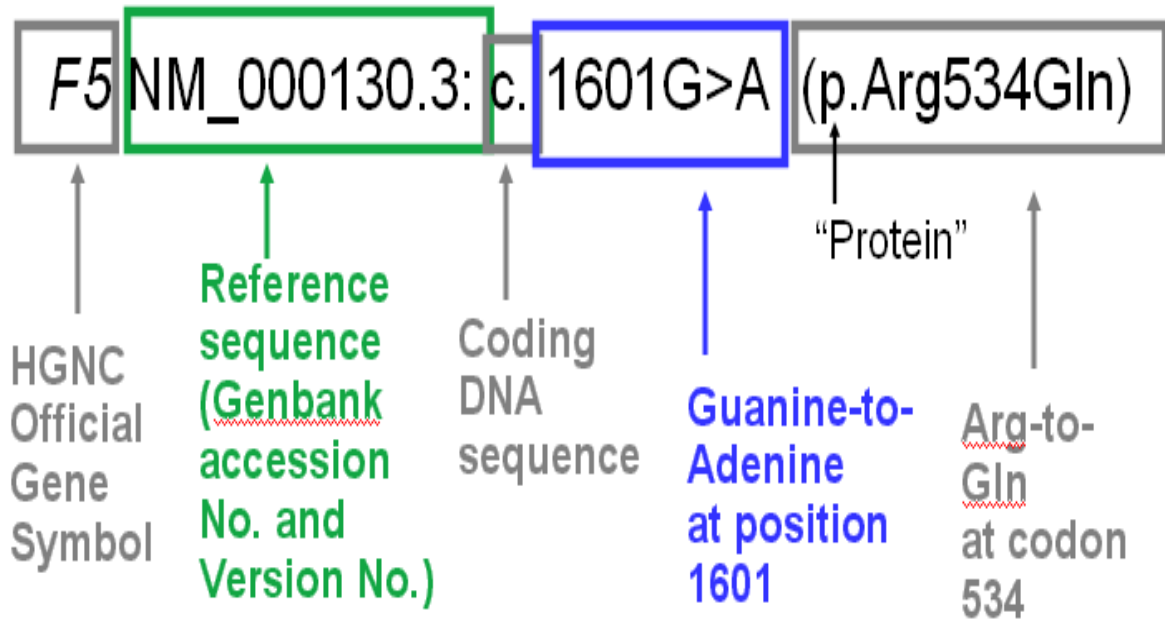

## Lesson 138

### Salient feature of Mutation nomenclature

- There is no nucleotide 0 (zero).
- Nucleotide 1 is A of the ATG-translation initiation codon.
- The nucleotide 5' of the ATG-translation initiation codon is -1, the previous -2, etc. e.g. in 5' UTR c.-12G>A
- The nucleotide 3' of the translation stop codon is \*1, the next \*2, etc. e.g. in 3' UTR c.\*70T>A
- Nucleotide numbering is purely arbitrary and starts with 1 at the first nucleotide of the database reference file.
- No +, - or other signs are used.
- The sequence should include all nucleotides covering the sequence (gene) of interest and should start well 5' of the promoter of a gene.

## Lesson 139

### Mutation at DNA, RNA and protein level

#### Mutation at DNA Level

- DNA-level  
in capitals, starting with a number referring to the first nucleotide affected (like c.76A>T or g.476A>T)

#### Mutation at RNA Level

- RNA-level  
in lower-case, starting with a number referring to the first nucleotide affected (like r.76a>u)

#### Mutation at Protein Level

- Protein level  
in capitals, starting with the letters referring to first the amino acid affected (like p.Lys76Asn)

### Nomenclature

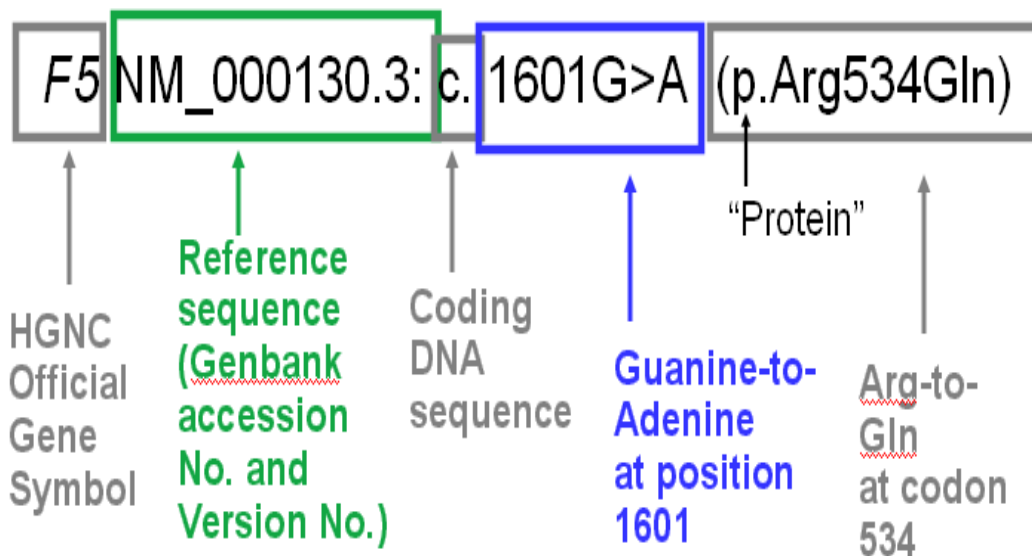

## Lesson 140

### Mutation in intronic sequence

#### Beginning of intron

- The number of the last nucleotide of the preceding exon, a plus sign and the position in the intron, like c.88+2T>G

#### End of intron

- The number of the first nucleotide of the following exon, a minus sign and the position upstream in the intron, like c.89-1G>T
- **Splicing boundaries**

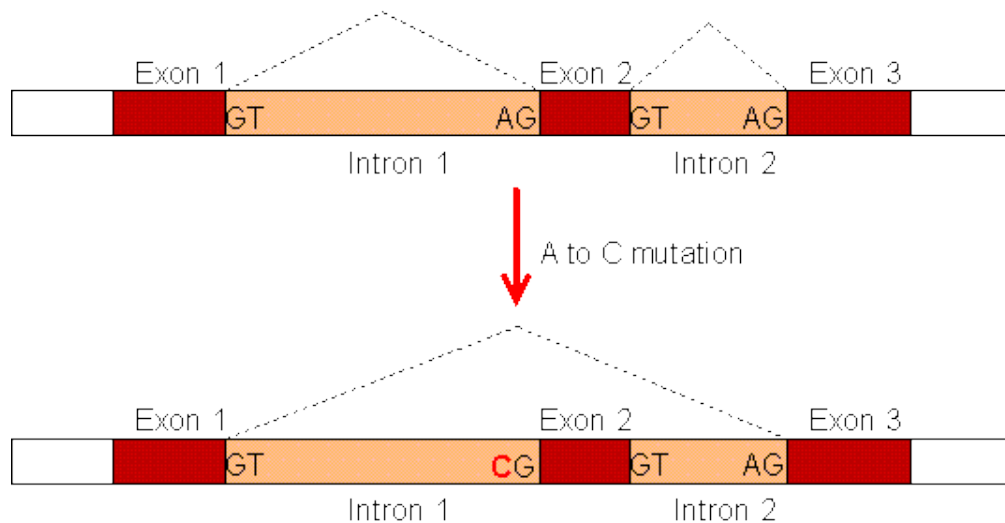

### Exon and intron

intron #	1	2	3	4	5	6	7	8	9
(length)	(2274)	(3468)	(1459)	(3181)	(2434)	(1757)	(1471)	(1852)	(2466)

exon #	1	2	3	4	5	6	7	8	9	10
start	-63*	133	268	379	556	739	905	1109	1237	1391
end	132	267	378	555	738	904	1108	1236	1390	

### **Middle of intron**

- In the middle of the intron, numbering changes from "c.77+.." to "c.78-.."; for introns with an uneven number of nucleotides the central nucleotide is the last described with a "+"

## Lesson 141

### Specific changes in sequence

- ">" indicates a substitution at DNA level (like c.76A>T)
- "\_" (underscore) indicates a range of affected residues, separating the first and last residue affected (like c.76\_78delACT).
- "del" indicates a deletion (like c.76delA).
- "dup" indicates a duplication (like c.76dupA); duplicating insertions are described as duplications, not as insertions.
- "ins" indicates a insertion (like c.76\_77insG)
- "inv" indicates an inversion (like c.76\_83inv)

## Lesson 142

### Mutations - Summary

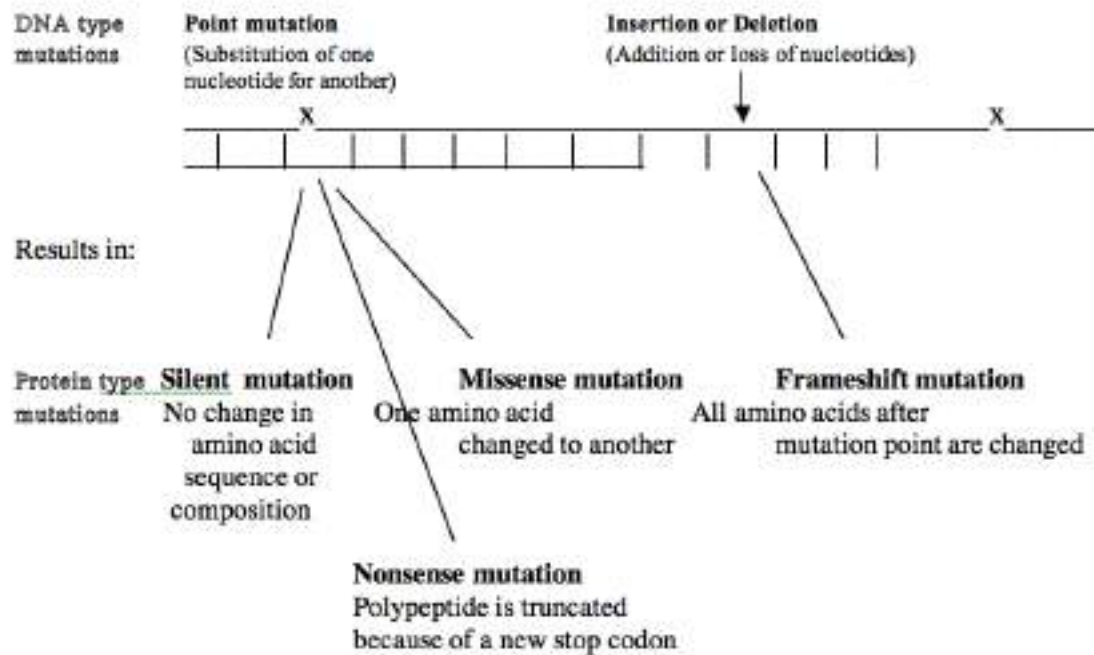

Normal	THE BIG RED DOG RAN OUT.
Missense	THE BIG RAD DOG RAN OUT.
Nonsense	THE BIG RED
Frameshift (1 bp deletion)	THE BGR EDD OGR ANO....
Frameshift (1 bp insertion)	THE BIG RED DOO GRA NOU
Frameshift (3bp deletion)	THE BIG DOG RAN OUT.
Triplet repeat expansion	THE BIG BIG BIG BIG BIG RED DOG RAN OUT.

## Lesson 143

**Genetic Disorders:** A genetic disease or disorder appears as a result of mutations in an individual's DNA. Change in DNA sequence may be small or large like deletions/addition of entire chromosome.

### Classification

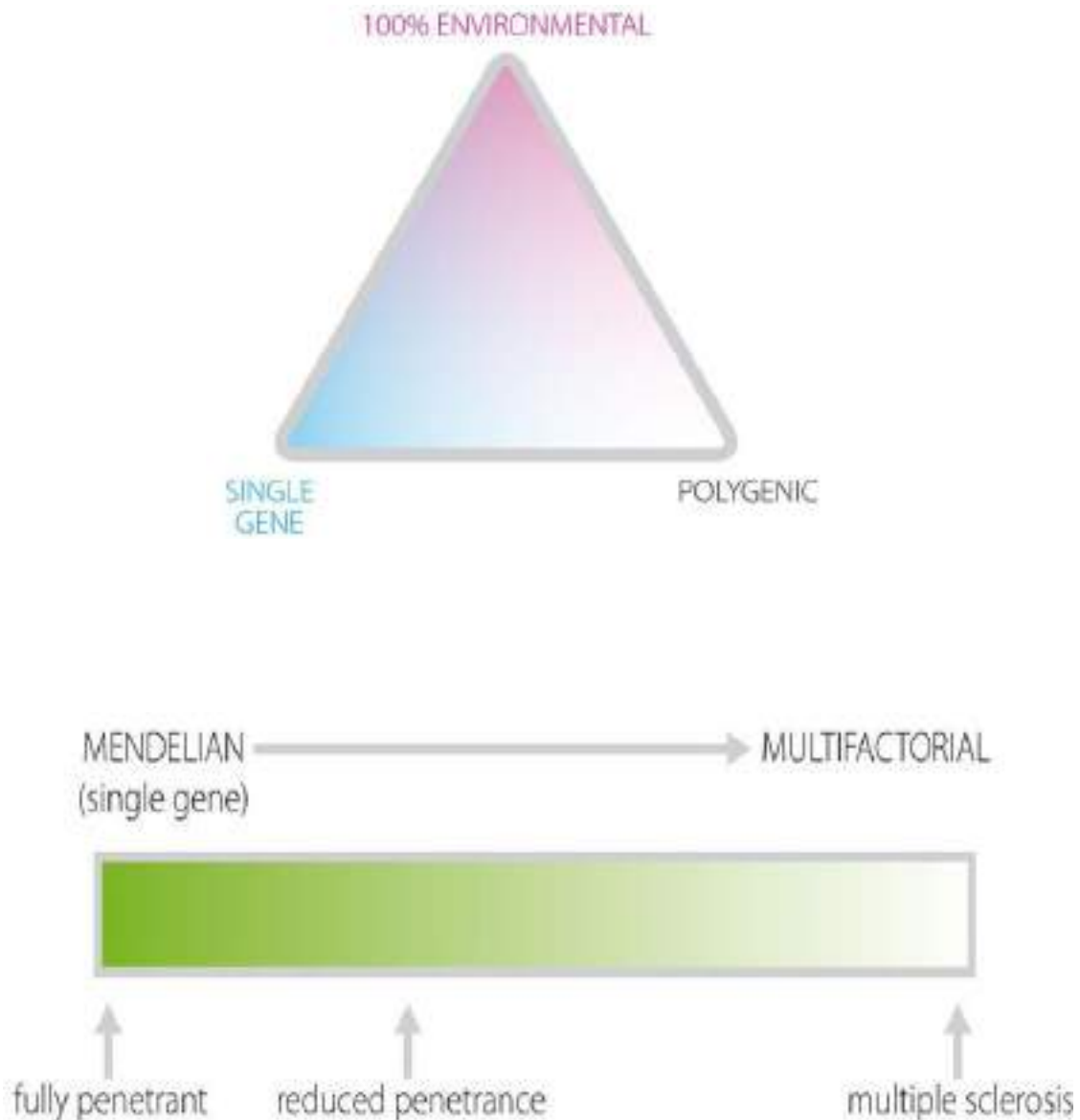



## Fully penetrant and low penetrant

Fully penetrant, where other genes and environmental factors have no effect

Low-penetrance, genes play a small part, along with other environmental factors

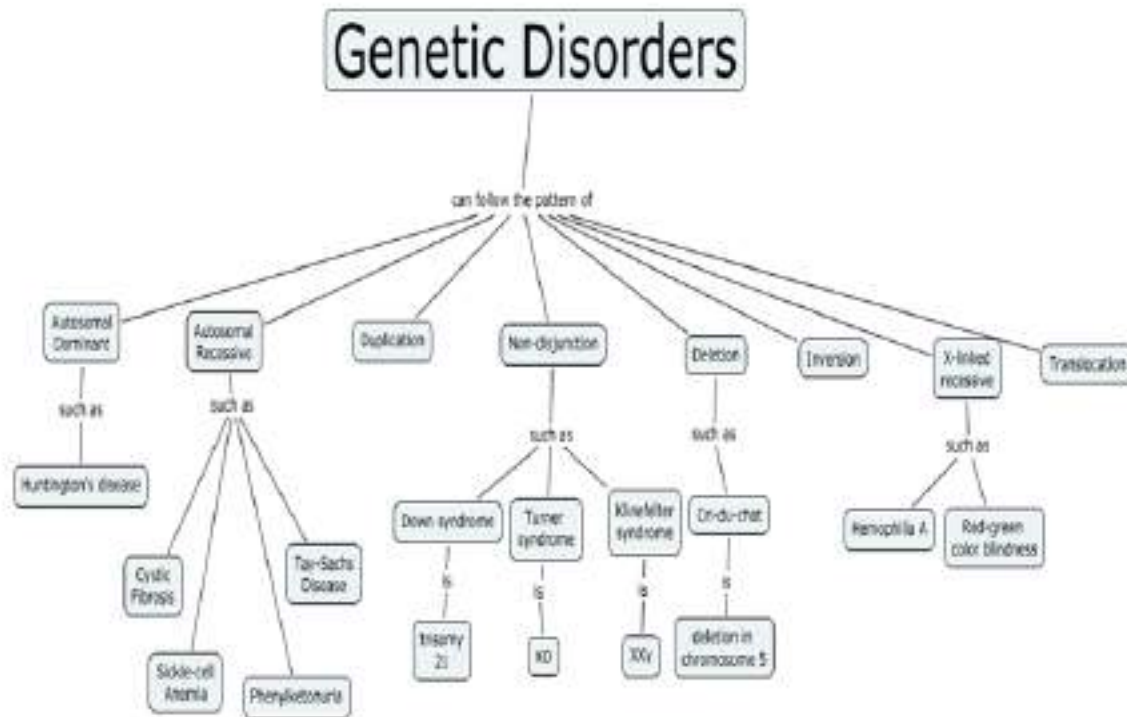

## Classification of genetic disorders

- Multifactorial disorders
- Single gene disorders
- Chromosomal disorders
- Mitochondrial disorders
- Somatic mutations (cancers)

## Lesson 144

### Inheritance patterns of genetic disorders

**Autosomal Dominant:** Affected individuals are heterozygote. One allele is mutated, while other one is normal.

**Autosomal recessive:** Homozygous, when both alleles of the gene are mutated.

**X-linked recessive:** Mutated alleles are present on either of the sex chromosomes.

**Multifactorial:** Genes and environment both contribute.

**Multifactorial frequent, single gene disorders less frequent:** Multifactorial are common. Single gene less common like dominant/recessive pedigree patterns

### Genes and genetic disorders

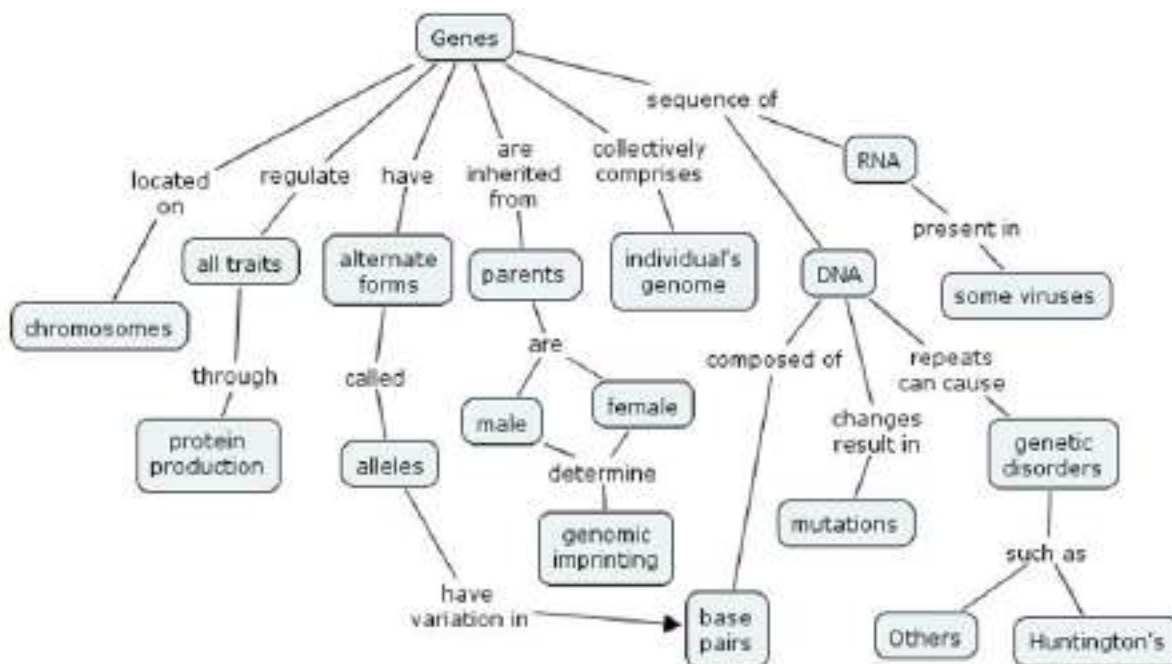

### Chromosomal disorders

- Thousands of genes may be involved.
- Multiple organ systems affected at multiple stages in gestation.

## Lesson 145

### Autosomal recessive inheritance / diseases

**Autosomal Recessive diseases:** Diseases occurs in individuals with two mutant alleles.

- In general, an individual inherit one mutant allele from each of the parent.

**Recessive diseases:** Homozygotes with two copies of the altered gene

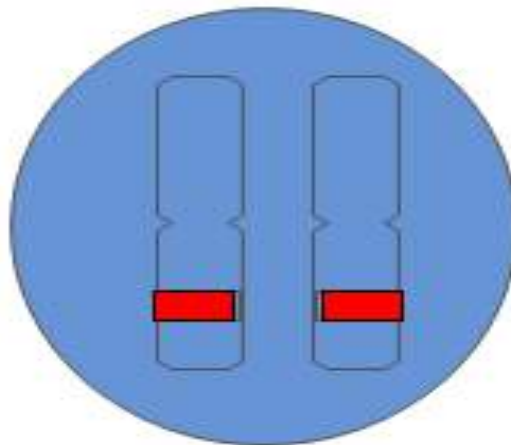

**Recessive diseases:** Since each parent has two alleles. Chance of inheriting a mutant allele from one parent is 50% and for the other parent is also 50%. Net chance of inheritance of two mutant alleles is 25%.



Parent who are carriers for the same autosomal recessive condition have one copy of the normal form of the gene and one copy of an altered form of gene

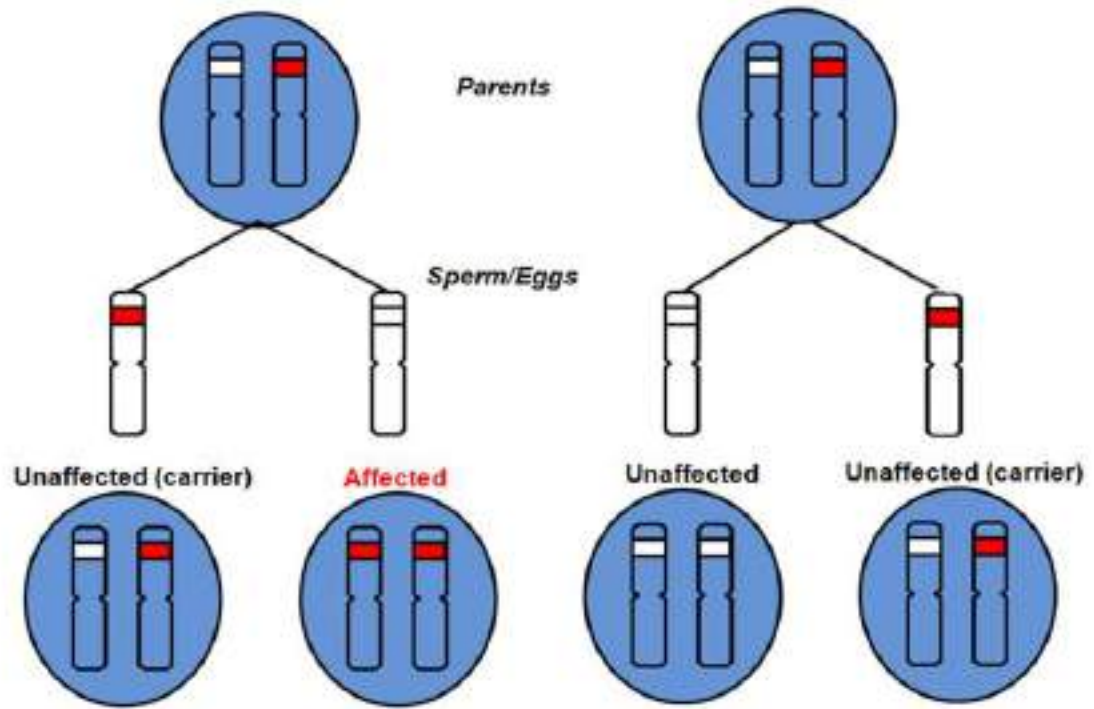
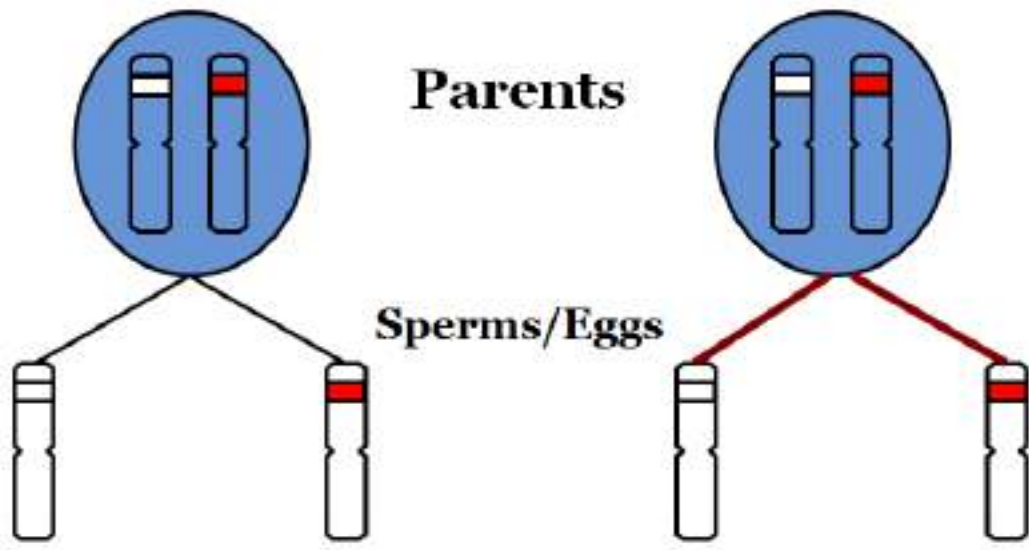

Generally, the disease appears in the progeny of unaffected parents.

Affected progeny include both males and females equally.

**Phenotypic proportions are equal – autosomal recessive:** When we know that both male and female phenotypic proportions are equal, we can assume that we are dealing with autosomal inheritance.

#### **Common recessive disorders**

- Bloom syndrome
- Carpenter syndrome
- Cystic fibrosis
- Thalassemia
- Many forms of mental retardation
- Gaucher's disease
- Glycogen storage diseases
- Rotor syndrome
- Many of eye diseases

## Lesson 146

### Properties of Autosomal recessive inheritance

**Consanguinity:** These diseases appear where parents have common ancestors.

**Same allele increases chances of inheriting disorders:** The chance of inheriting identical alleles by an individual from both parents increases the chance of inheriting a recessive disorder.

**Common genetic background:** Small populations of individuals with a common genetic background may have increased risk of recessive diseases.

Ashkenazi: Gaucher disease

Phenotype found more likely in siblings of proband than in other relatives. Males and females are equally affected. In most of the cases, parents of affected individuals are asymptomatic.

### Risk for each of the sibling being affected

Risk of disease for each sib is 25 %

## Lesson 147

### Autosomal dominant inheritance/ disorders

**Autosomal dominant disorders:** In autosomal dominant disorders, the normal allele is recessive and the abnormal allele is dominant. In a typical pedigree, every affected person has one affected parent. Equal numbers of affected females/males are expected. Male to male transmission is possible. One-half of the children of an affected individual are expected to have inherited the dominant allele.

### Autosomal Dominant disorders

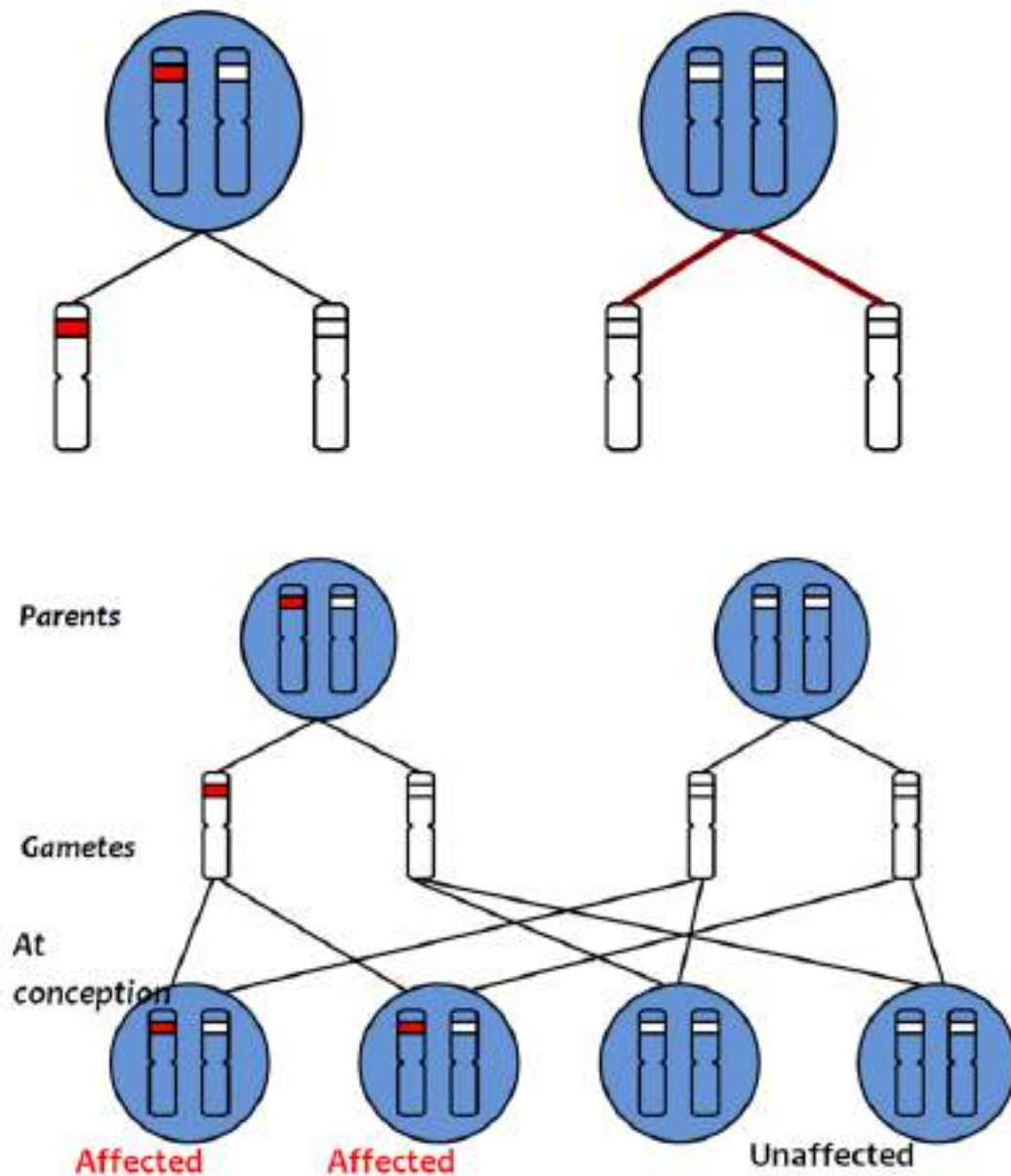

Pedigree analysis, main clues for identifying a dominant disorder is that the phenotype tends to appear in every generation of the pedigree. Affected fathers/mothers transmit the phenotype to both sons and daughters. Trait is common in the pedigree. Trait is found in every generation.

### **Autosomal Dominant diseases**

- Marfan syndrome
- Huntington's disease
- Retinoblastoma
- Waardenburg syndrome
- Myotonic dystrophy
- Polycystic kidney disease
- Achondroplasia
- Polydactyly
- Heredity hearing loss



## Lesson 148

### Variations in Autosomal dominant inheritance

**Autosomal dominant disorders:** In autosomal dominant disorders, the normal allele is recessive and the abnormal allele has dominant effect. In a typical pedigree, every affected person has one affected parent.

### Autosomal dominant disorders

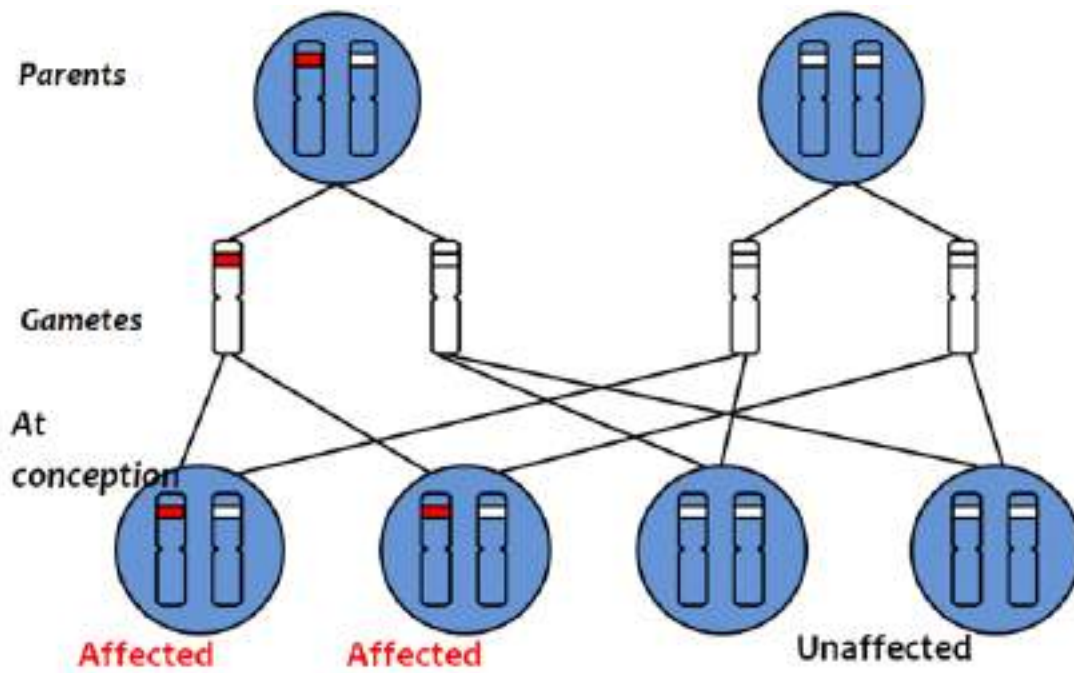

### Penetrance - variation to A.D inheritance

Some people with an appropriate genotype fail to express the phenotype called as incomplete or reduced penetrance.

### Expressivity - variation to autosomal dominant inheritance

Severity of the phenotype: When phenotypic severity varies among those with same genotypes

### Pleiotropy - variation to autosomal dominant inheritance

Pleiotropy: Multiple phenotypic effects of a single gene.

## Lesson 149

**Dominance and Recessiveness** Dominance and recessiveness are the properties of characters/traits, not genes. A character is dominant if it is expressed in the heterozygote and recessive if not.

**Recessiveness:** Cystic fibrosis is recessive because only homozygotes manifest it, whereas heterozygotes show the normal phenotype.

**Hemizygous:** Males are hemizygous for loci on the X and Y chromosomes, where they have only a single

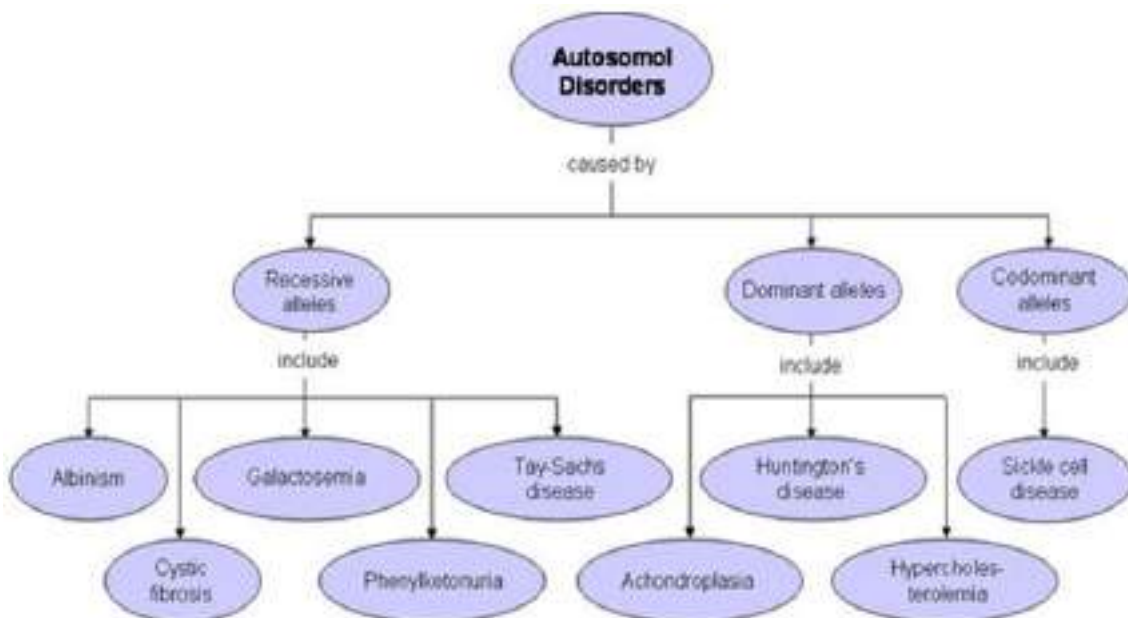

<b>Traits</b>	<b>Dominant</b>	<b>Recessive</b>
<b>Eye color</b>	<b>brown eyes</b>	<b>grey, green, hazel, blue eyes</b>
<b>Hair</b>	<b>dark hair</b>	<b>blonde, light, red hair</b>
	<b>non-red hair</b>	<b>red hair</b>
	<b>curly hair</b>	<b>straight hair</b>
<b>Facial features</b>	<b>dimples</b>	<b>No dimples</b>
	<b>unattached earlobes</b>	<b>attached earlobes</b>
	<b>broad lips</b>	<b>thin lips</b>
<b>Appendages</b>	<b>extra digits</b>	<b>normal number</b>
	<b>clubbed thumb</b>	<b>normal thumb</b>

### **Dominance and recessiveness**

Dominance and recessiveness are the properties of characters/traits, not the genes.

## Lesson 150

### X-linked recessive inheritance and disorders

**X-linked recessive:** Traits which are due to the genes which are present on either of the sex chromosomes. Many of the genes have a disease phenotype.

**Males are hemizygous and express the disease:** Males are hemizygous, will express the disease phenotype if one mutation is present.

**Homozygous Females manifest disease:** Females may be homozygous or heterozygous. Homozygous may manifest the disease.

### General characteristic

- Trait is rare in pedigree.
- Trait skips generations.
- Affected fathers do not pass to their sons.
- Males are more often affected than females.

### X-linked recessive disorders

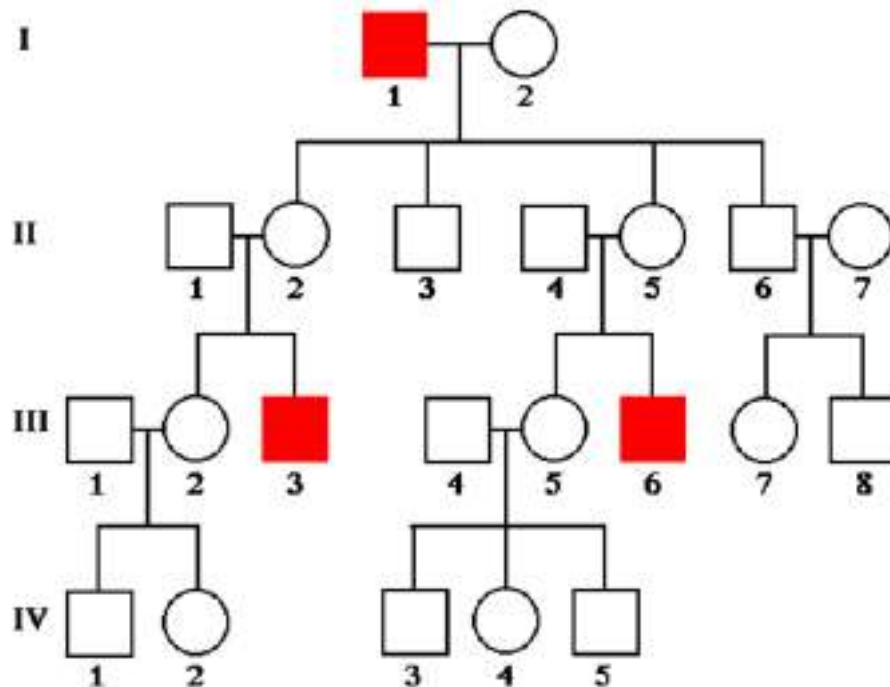

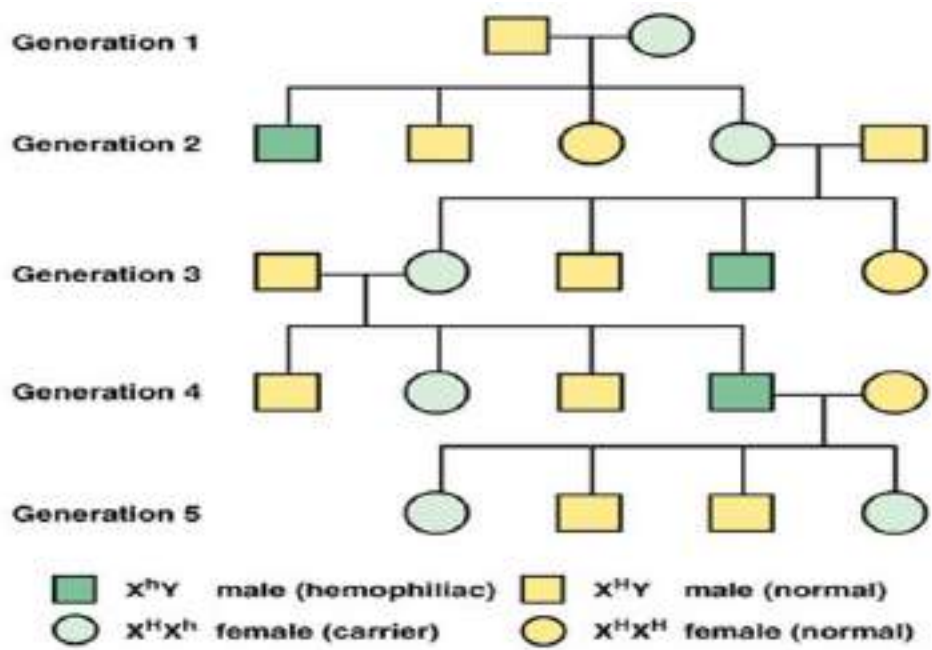
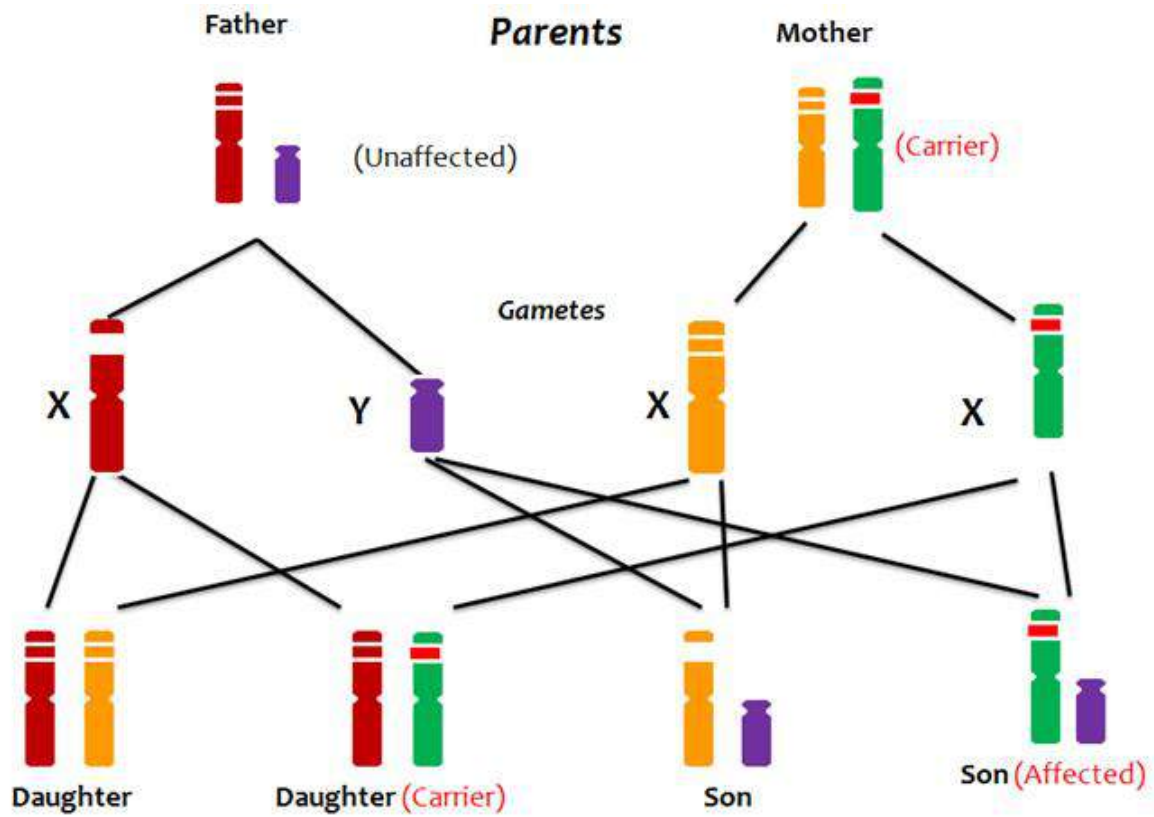

**X-linked recessive:** X-linked recessives expressed in all males but only in homozygous females.

X-linked color blindness

**Common X-linked disorders**

- Duchene Muscular Dystrophy
- Hunter's Disease
- Menkes Disease
- Hemophilia A and B
- Color Blindness

## Lesson 151

### X-linked dominant inheritance and disorders

Affected males transmit disease to all daughters but none of sons

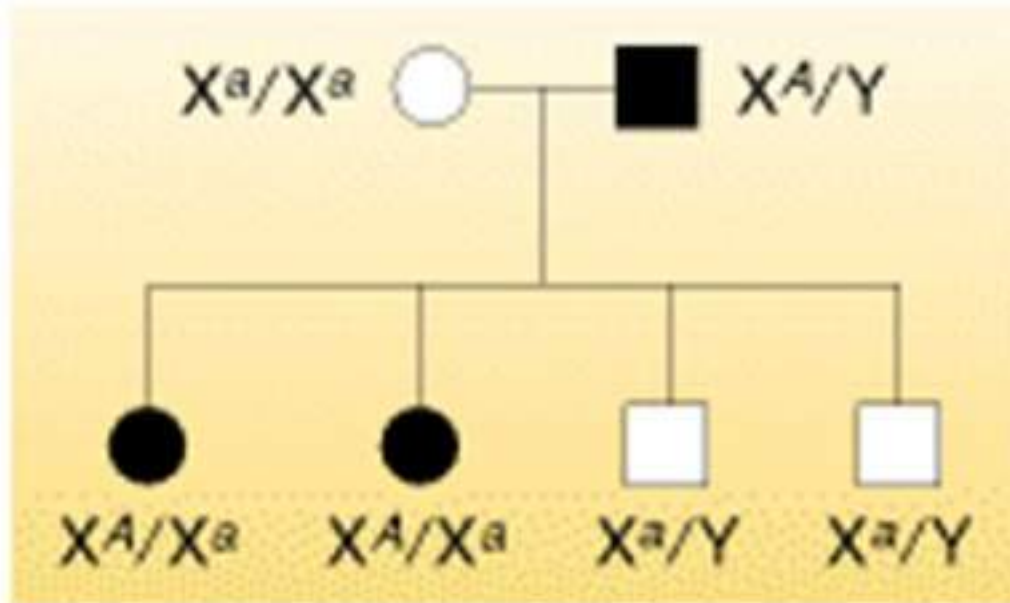

Affected heterozygous females and un-affected males pass the disease to half their sons and daughters

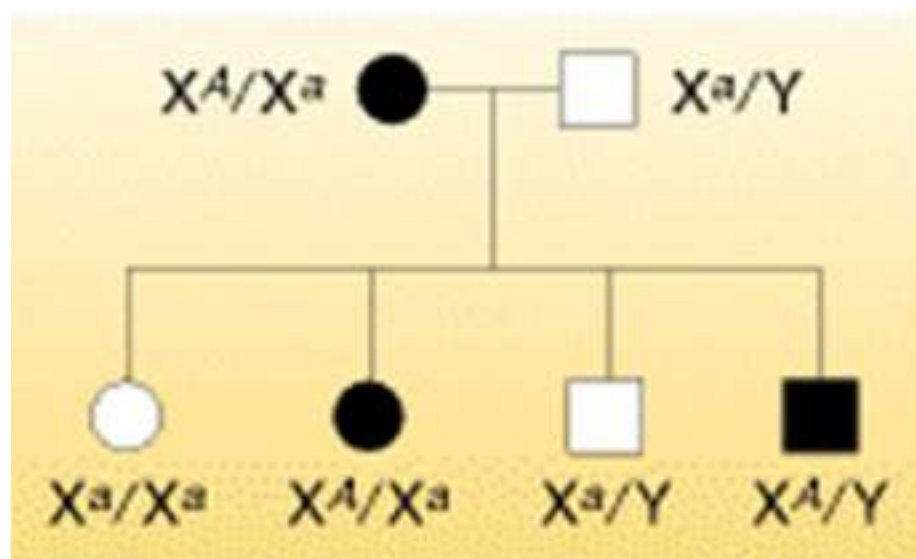

**X-linked dominant diseases:** Affected fathers pass to all of their daughters.

Males and females are equally likely to be affected.

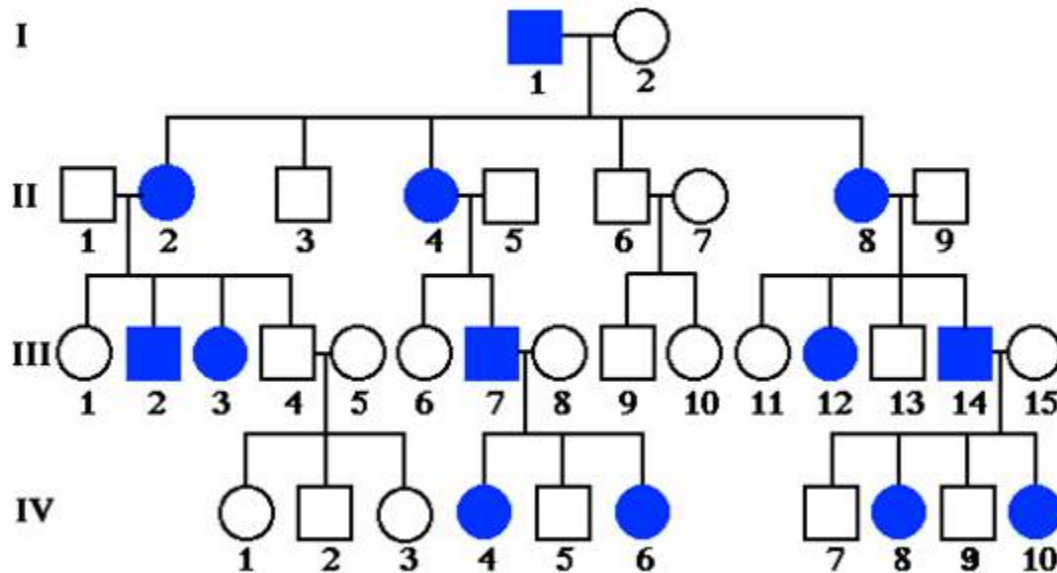

#### Common X-linked dominant diseases

- Rett syndrome
- Alport syndrome
- Goltz syndrome
- Fragile-X Syndrome



## Lesson 152

### Maternal inheritance of mitochondrial DNA

- Mitochondrial DNA (MTDNA) is inherited through ovum not sperm
- Mother could pass it to all children.
- Father will pass it to none of the children.

### Mitochondrial DNA

- More than one copy of mtDNA is passed.
- Mutations are common.
- More than one type of mtDNA genome is passed.

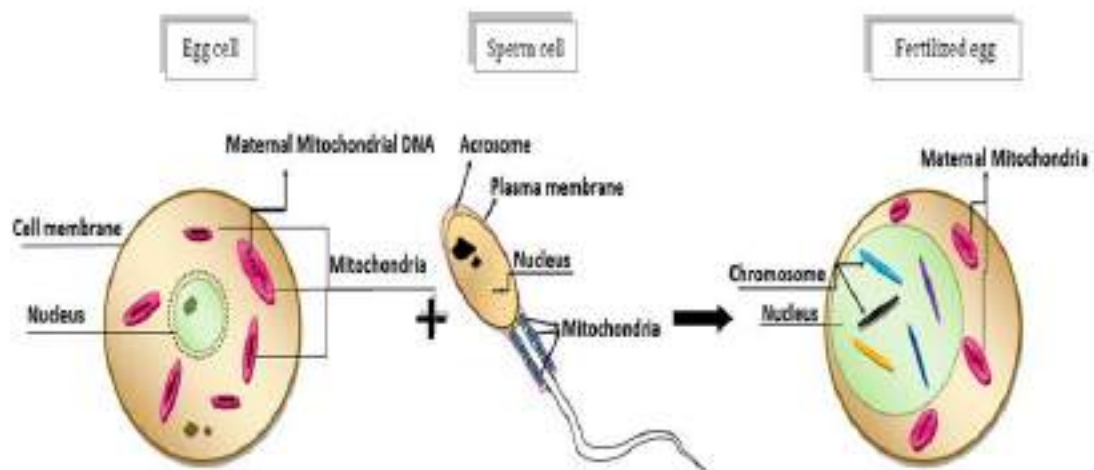

Nuclear DNA is inherited from all ancestors.

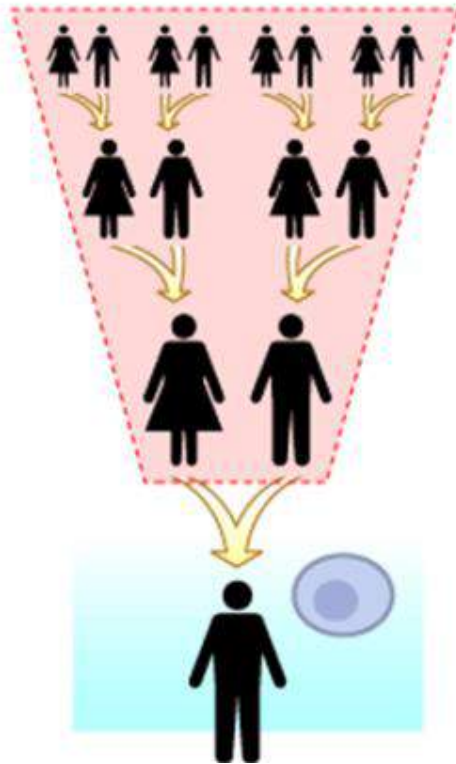

Mitochondrial DNA is inherited from a single lineage.

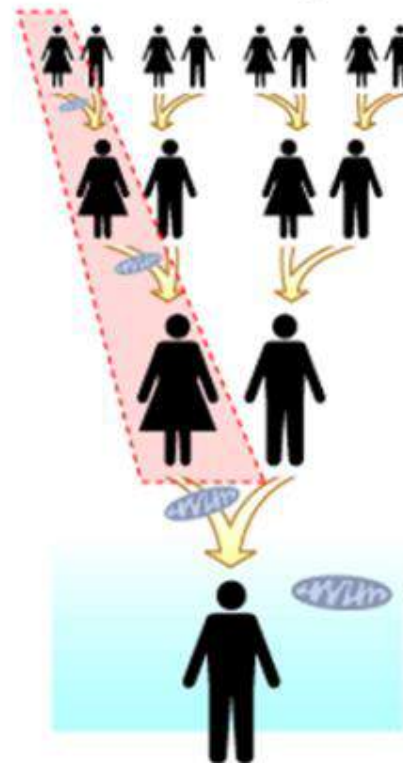

### Properties of Mitochondrial inheritance

- Heteroplasmy
- Variable expression
- Pleiotropy
- Reduced penetrance
- Functional somatic mosaicism

## Mitochondrial DNA

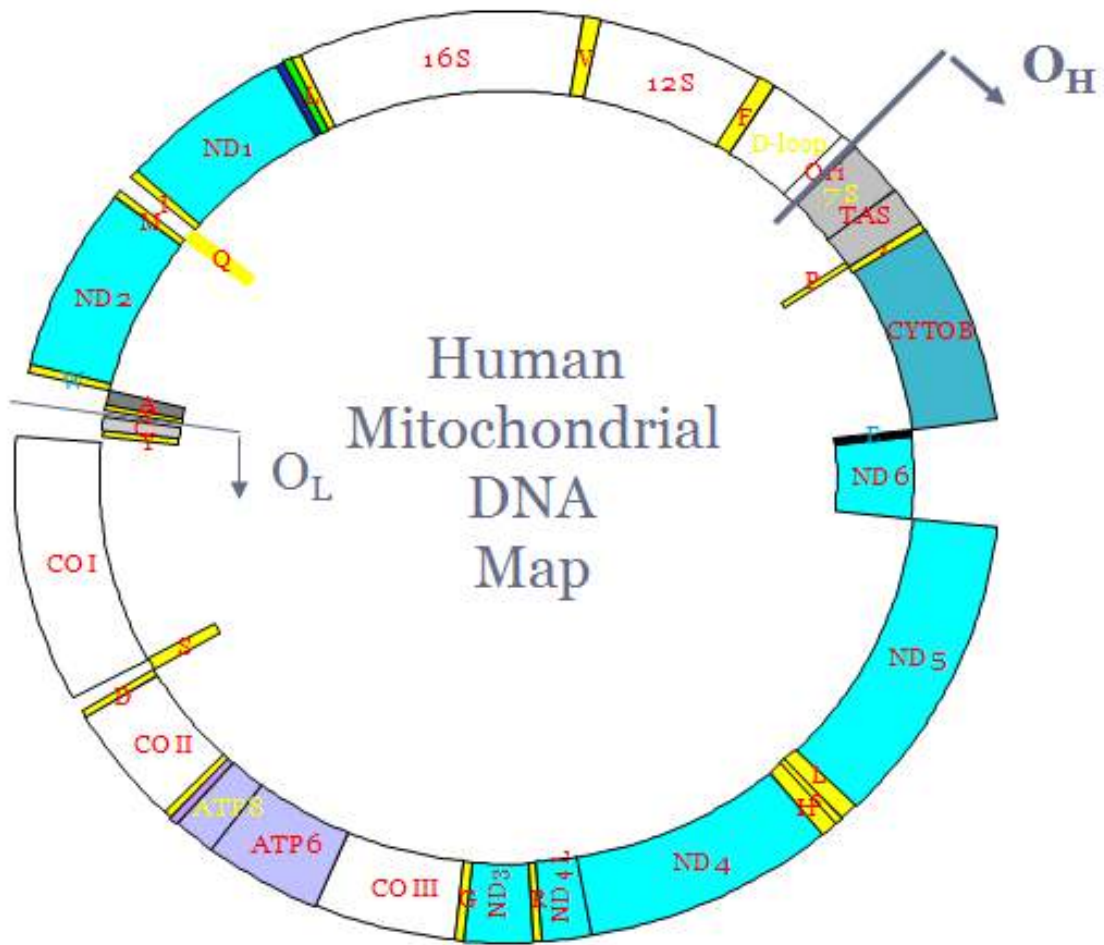

## Mitochondrial DNA – Severity

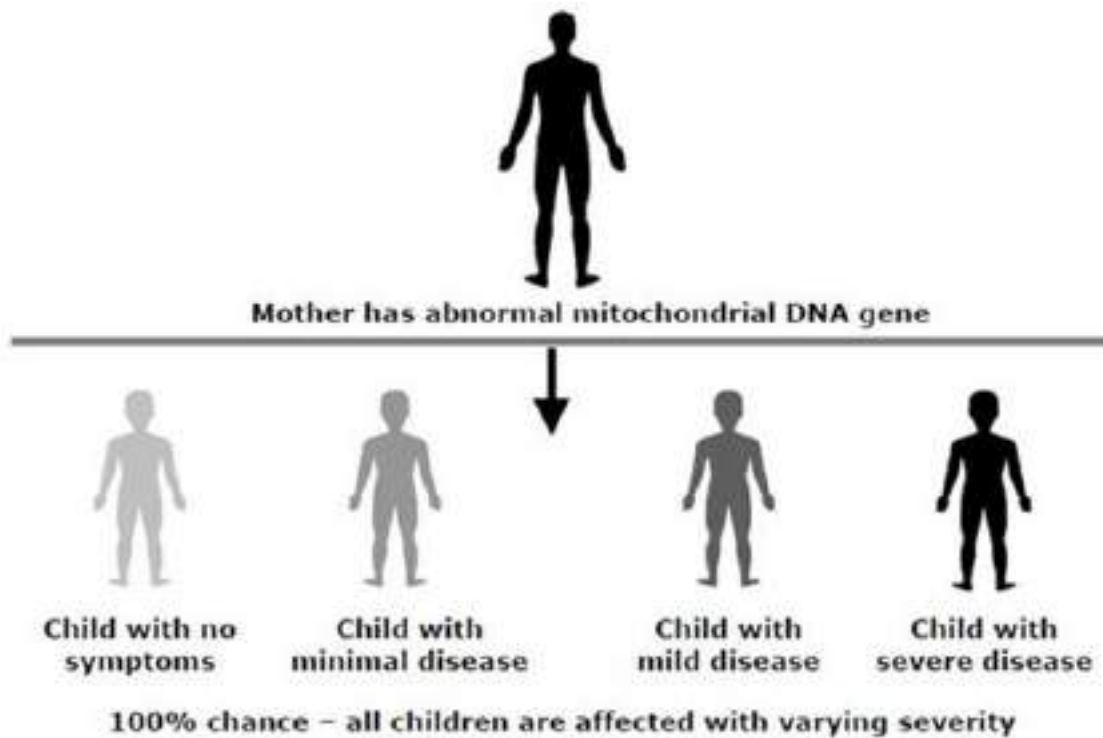
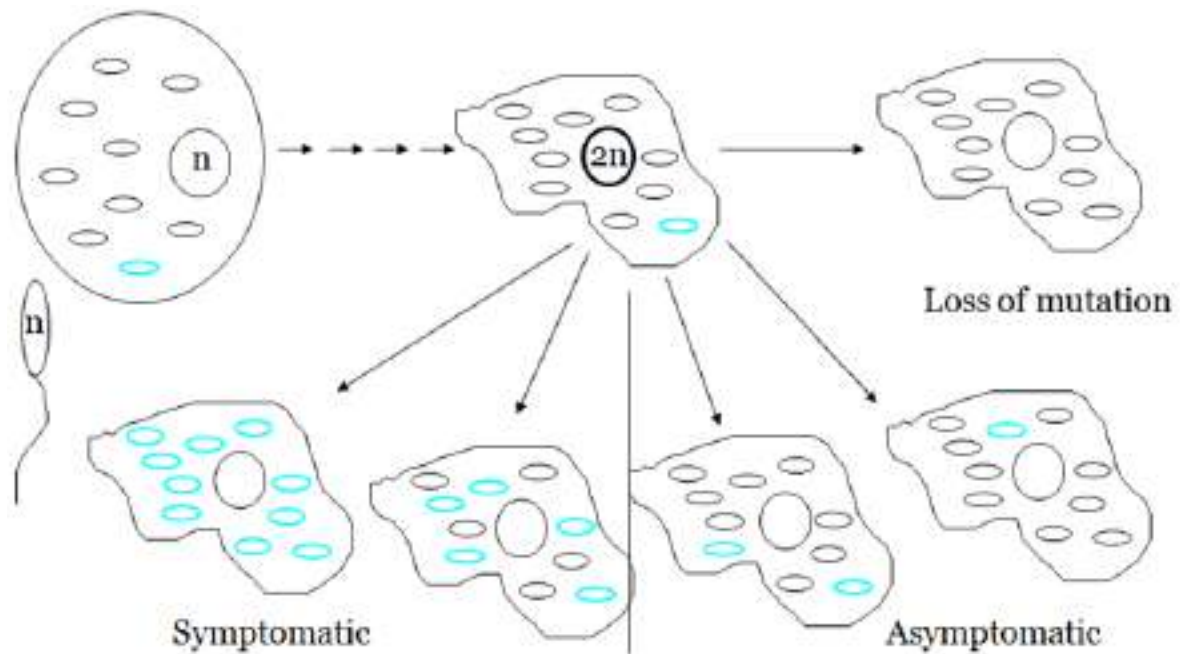

### **Common mitochondrial diseases**

- Myoclonic epilepsy
- Mitochondrial recessive ataxia
- Leber hereditary optic neuropathy
- Sensory ataxia neuropathy

## Lesson 153

### Multifactorial inheritance and disorders

**Multifactorial diseases:** Genetic disorders controlled by many genes plus the effects of the environment.

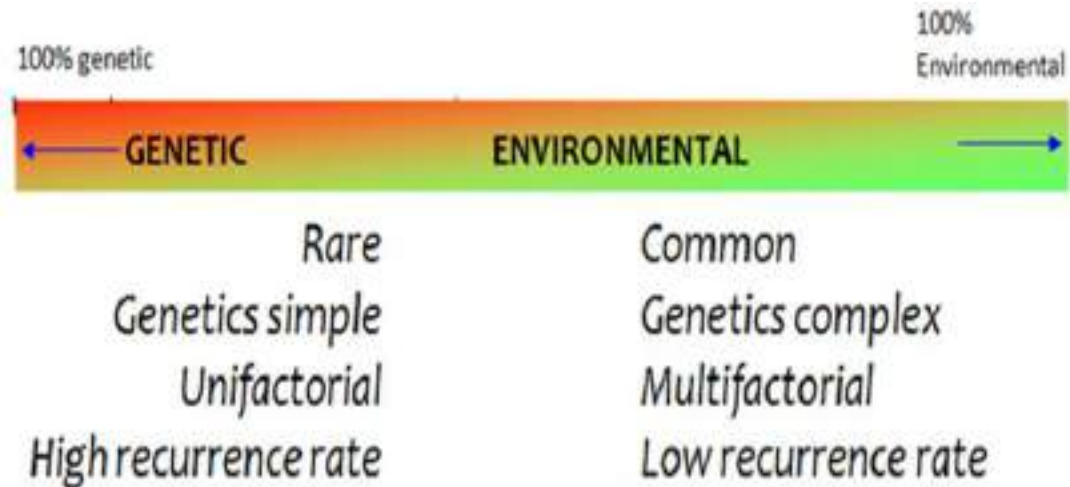

### Multifactorial diseases

- Asthma
- Cancers
- Ciliopathies
- Cleft palate
- Diabetes
- Heart diseases
- hypertension
- inflammatory bowel disease
- intellectual disability
- mood disorder
- Obesity
- infertility

## **Lesson 154**

### **Frequency of genetic disorders**

#### **Frequency of autosomal dominant disorders**

Frequency of autosomal dominant disorders varies between 3 – 9.5 per 1000 individuals

#### **Frequency of autosomal recessive disorders**

Frequency of autosomal recessive disorders is between 2-2.5 per 1000 individuals.

#### **Frequency of x-linked disorders**

Frequency of X-linked disorders is between 0.5 – 2 per 1000 individuals.

#### **Frequency of chromosomal disorders**

Frequency of chromosomal disorders is between 6-9 per 1000 individuals.

#### **Frequency of multifactorial disorders**

Frequency of multifactorial disorders is between 20 – 50 per 1000 individuals.

Most common multifactorial disorders are cancers, diabetes, heart diseases.

## Lesson 155

### **Diagnostic tests for genetic disorders**

**Physical analysis:** Physical analysis for affected individual.

**Ultrasonography of fetus:** Ultrasonography of fetus determines malformations of head, internal organs, and extremities.

**Analysis of amniotic fluids:** Amniotic fluid analysis to determine genetic and chromosomal disorders after 14 wks gestation. More than 200 various genetic diseases easily be detected.

**Maternal blood analysis:** Maternal blood analysis to observe abnormal fetus.



## Lesson 156

### **Genetic Counseling**

#### **Genetic counseling and background history of parents**

A genetic counselor usually begins with a complete family history of both prospective parents.

#### **Genetic counseling and pedigree drawing/ analysis**

A complete, detailed family history is called a pedigree. Pedigrees are used to determine the pattern of inheritance of a genetic disease within a family.

**Genetic counseling** Genetic counselor can inform prospective parents of the possibility of having genetically abnormal offspring, and they can make an informed decision.

**Genetic counseling and molecular tests** Genetic counselor advise them to perform molecular tests for relevant disease in the parents.

**Gene therapy** A procedure that involves identification, manipulation, and transference of genetic segments into a host to replace defective genes and to perform desired genetic activities.

## Lesson 157

### Complications in basic inheritance pattern

#### Single genes -Non-mendelian inheritance

Differences in gene actions can generate more complex inheritance patterns.

Single gene can give codominance, incomplete dominance, overdominance.

#### Complications to inheritance patterns

Multiple genes - epistasis, polygenic traits Genes & the environment - sex-influenced traits, incomplete penetrance

#### Complications

- A common recessive inheritance can give dominant pattern
- Autosomal dominant inheritance with non-penetrance
- Autosomal dominant inheritance with variable expression.

#### Pedigrees with complicated inheritance pattern

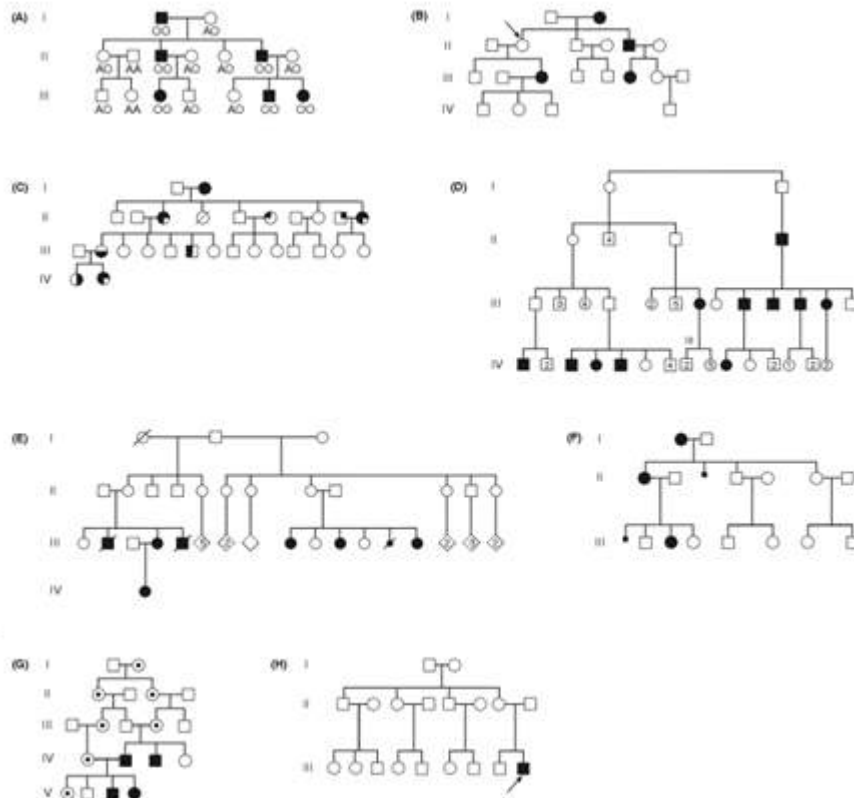

## **Complications**

- A common recessive can give dominant pattern
- Autosomal dominant inheritance with non-penetrance
- Autosomal dominant inheritance with variable expression

# Lesson 158

## Drawing pedigree

### Generations of a pedigree as roman numerals

Generations in a pedigree diagram are numbered, by using Roman numerals, starting with the parental generation, at the top of the diagram as generation I.

### Members of each generation are numbers from left to right

For convenience, the members of each generation are numbered across the line, from left to right, using normal numerals.

## Drawing pedigree

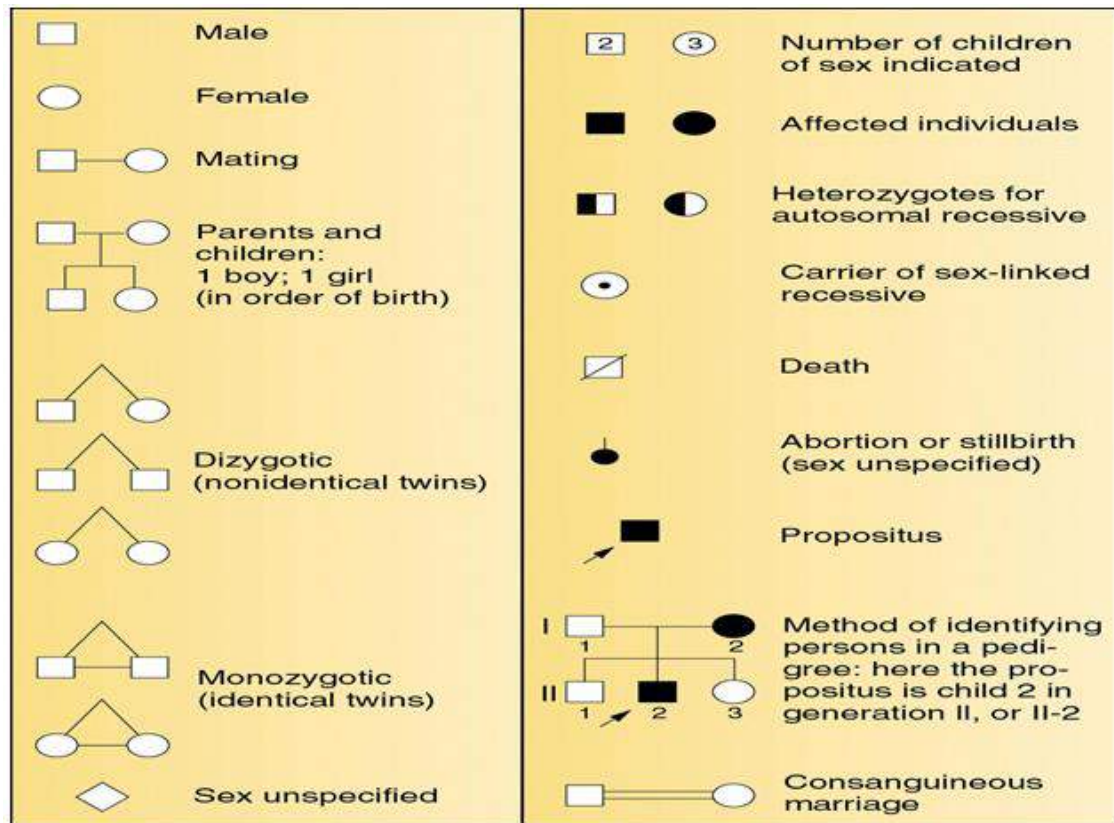

## Steps for drawing pedigree

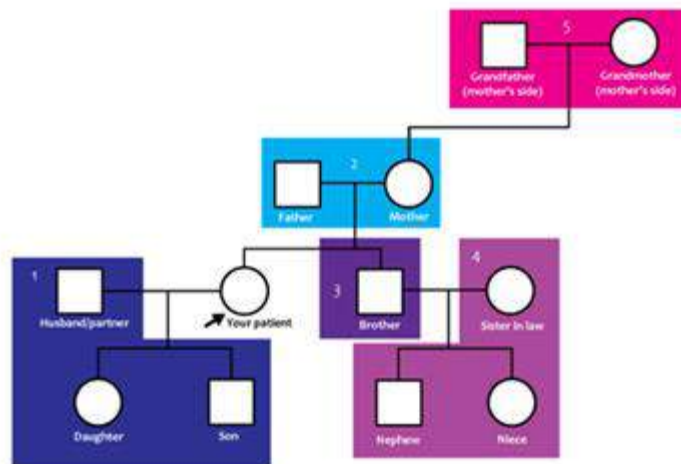
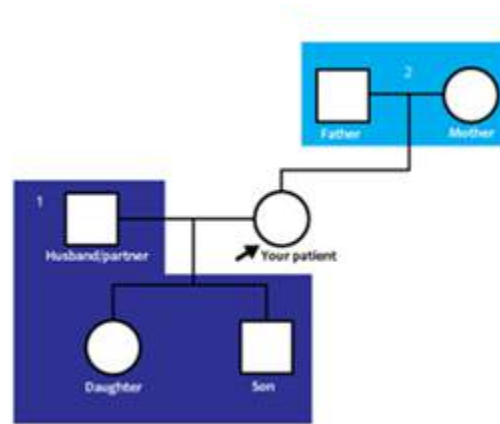
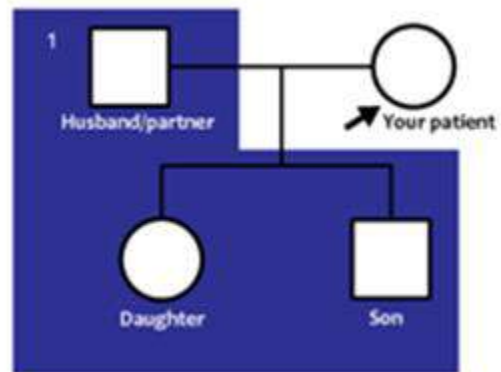

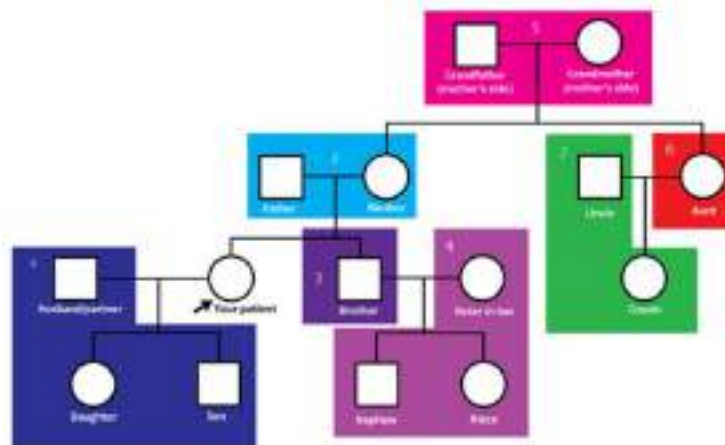
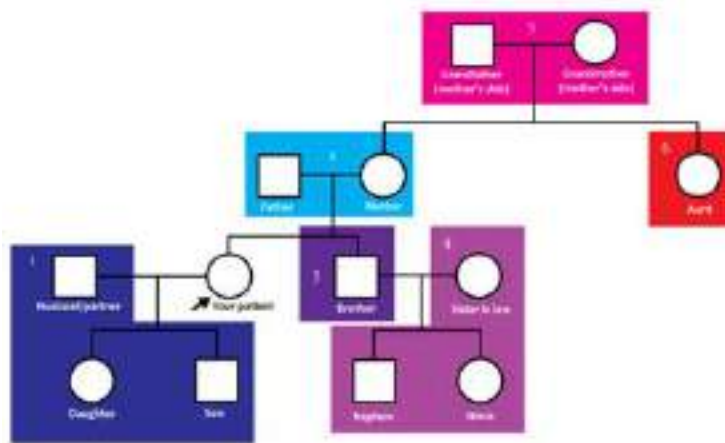
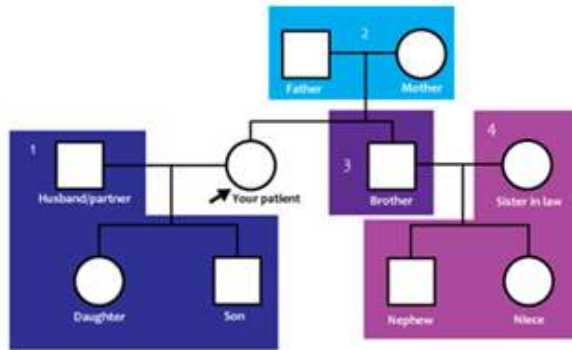

## Drawing pedigree

Pedigree drawing helps in understand the pattern of inheritance of the disease.







## Lesson 159

### Pedigree analysis

#### Goals of pedigree analysis

- Determine the mode of inheritance: dominant, recessive, sex-linked.
- Determine the probability of an affected offspring for a given cross.

#### Basic symbols

	male (unaffected)
	affected male
	female (unaffected)
	affected female
	unknown sex
	Dead

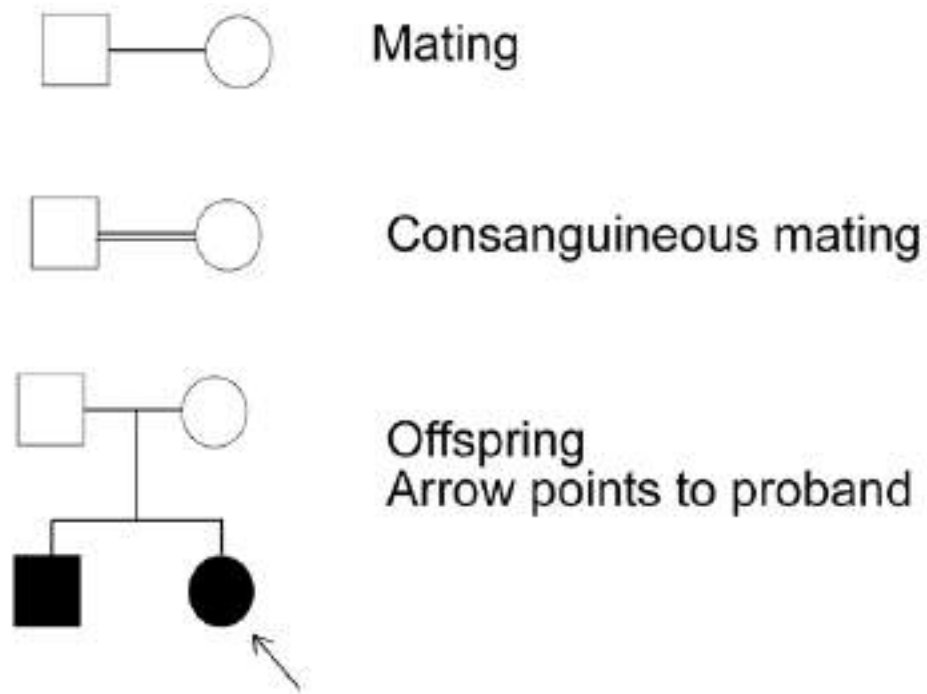

**Pedigree analysis:** Pedigree analysis helps to determine mode of inheritance.



## Lesson 160

### DNA polymorphism

- DNA polymorphism is a sequence difference compared to a reference standard present in at least 1–2% of a population.

### DNA Polymorphism may be single nucleotide or thousands of BASES

- Polymorphisms can be due to a single base or thousands of bases.

### DNA Polymorphism may or may not have phenotypic effects

- Polymorphisms may or may not have phenotypic effects.

### DNA POLYMORPHISM - SNP

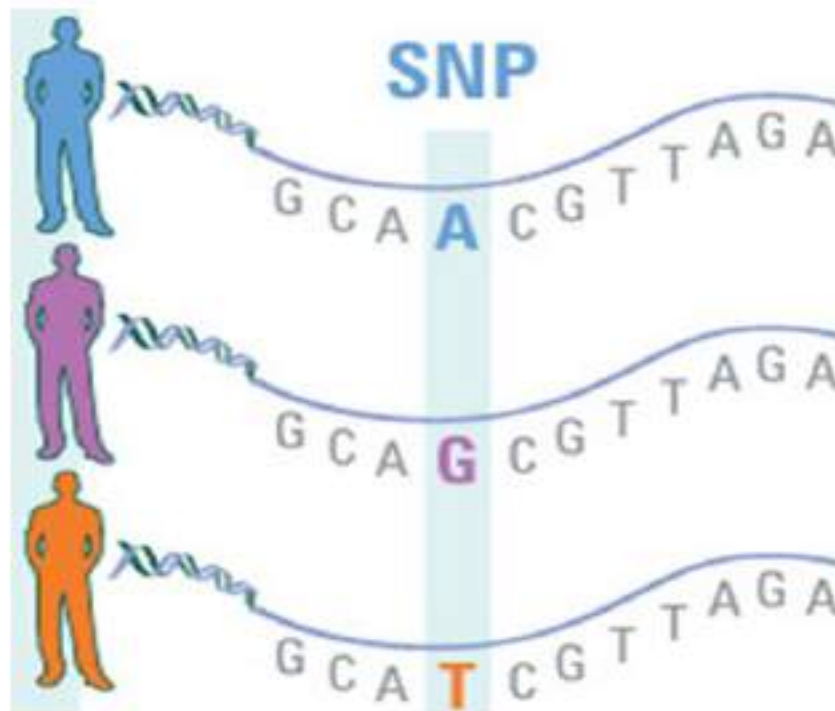

## DNA Polymorphism are found throughout the genomes

- Polymorphisms are found throughout the genome.

## Polymorphic sequence can serve as marker

- If the location of a polymorphic sequence is known, it can serve as a marker for locating other genes or genetic regions.

## Polymorphic markers have different versions

- Each polymorphic marker has different versions or alleles.

Polymorphisms can be silent, or be exhibited at levels of Proteins

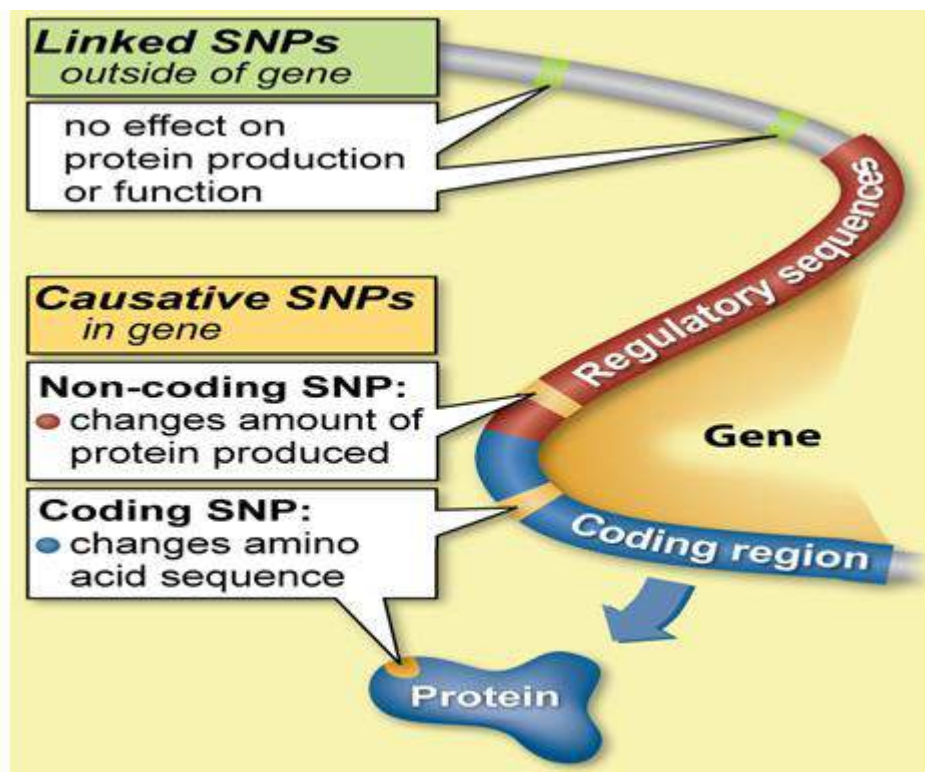

## Polymorphism - why to study

Essential to study inheritance patterns. Map phenotypes and anchor genes to the genetic map by co-segregation analysis. Determine change in function: resistant/sensitive populations genetically determined variability among humans is due to a difference in 0.1% of the genomic sequence.

## Lesson 161

### Types of Polymorphic DNA Sequences

- RFLP: Restriction Fragment Length Polymorphism
- VNTR: Variable Number Tandem Repeats (8 to > 50 base pairs)

### Types of Polymorphic DNA Sequences

- STR: Short Tandem Repeats (1– 8 base pairs).
- SNP: Single Nucleotide Polymorphisms
- AFLP: Amplified Fragment Length Polymorphism

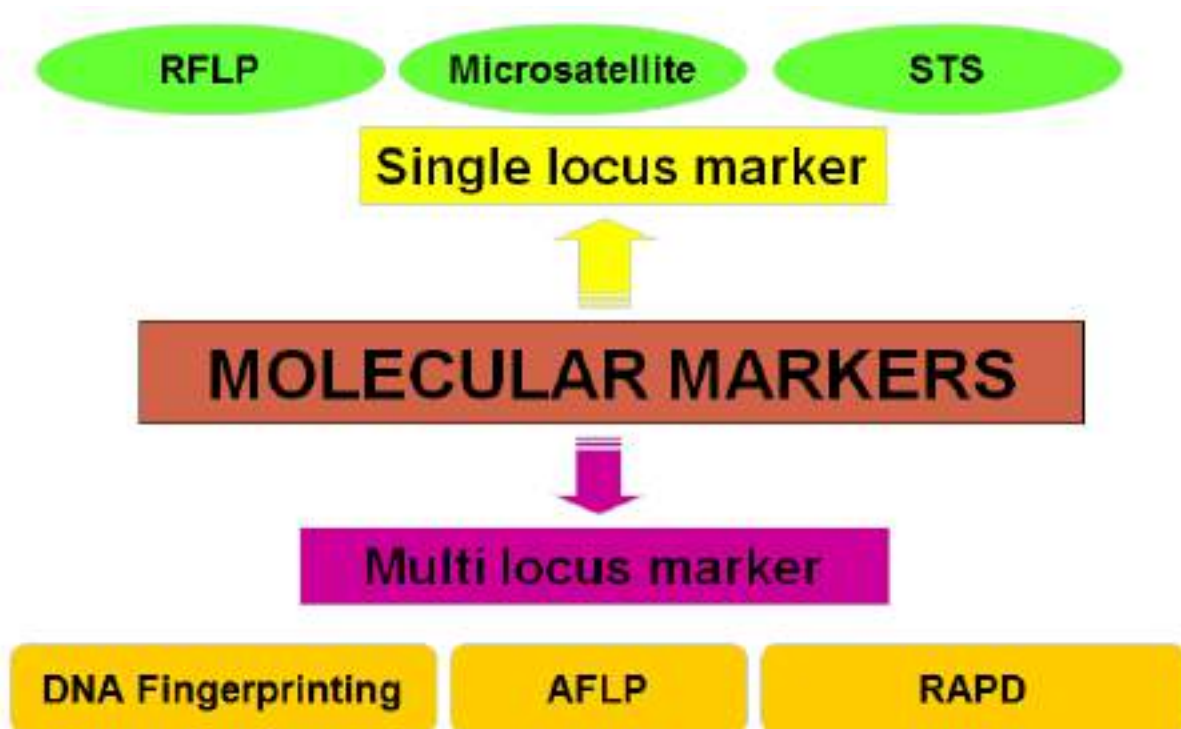

### **Applications of molecular markers – short range**

- Parentage determination
- Genetic distance estimation
- Determination of twin zygosity
- Sexing of pre-implanted embryos
- Identification of disease carriers

### **Applications of Molecular Markers – Long Range**

- Gene mapping & mapping of QTL by linkage
- Markers assisted selection of breeds

### **Polymorphic DNA sequences in humans**

- In humans, 99.9 percent bases are same.
- Remaining 0.1 percent makes a person unique.
- These variations can be harmless and harmful.

## Lesson 162

### Restriction Fragment Length Polymorphism

**What is RFLP:** RFLP is a difference in homologous DNA sequences that can be detected as fragments of different lengths after digestion of the DNA samples.

Most RFLP markers are heterozygous and highly locus-specific.

RFLP probe is a labeled DNA sequence that hybridizes with one or more fragments of the digested DNA sample after they were separated by gel electrophoresis.

### Methodology

- Genomic DNA digested with restriction enzymes.
- DNA fragments separated via electrophoresis and transfer to nylon membrane.
- Membranes exposed to probes labeled with P32.
- Film exposed to X-Ray.

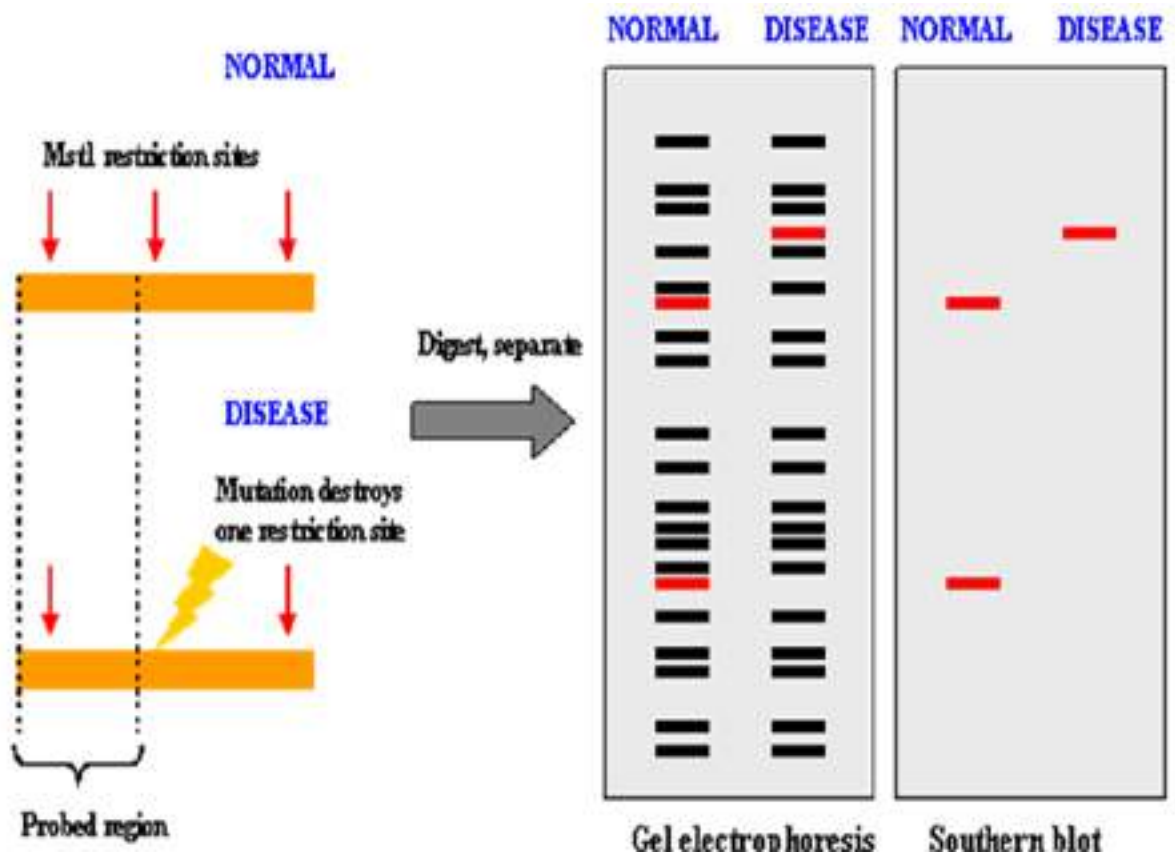

# Paternity analysis - RFLP

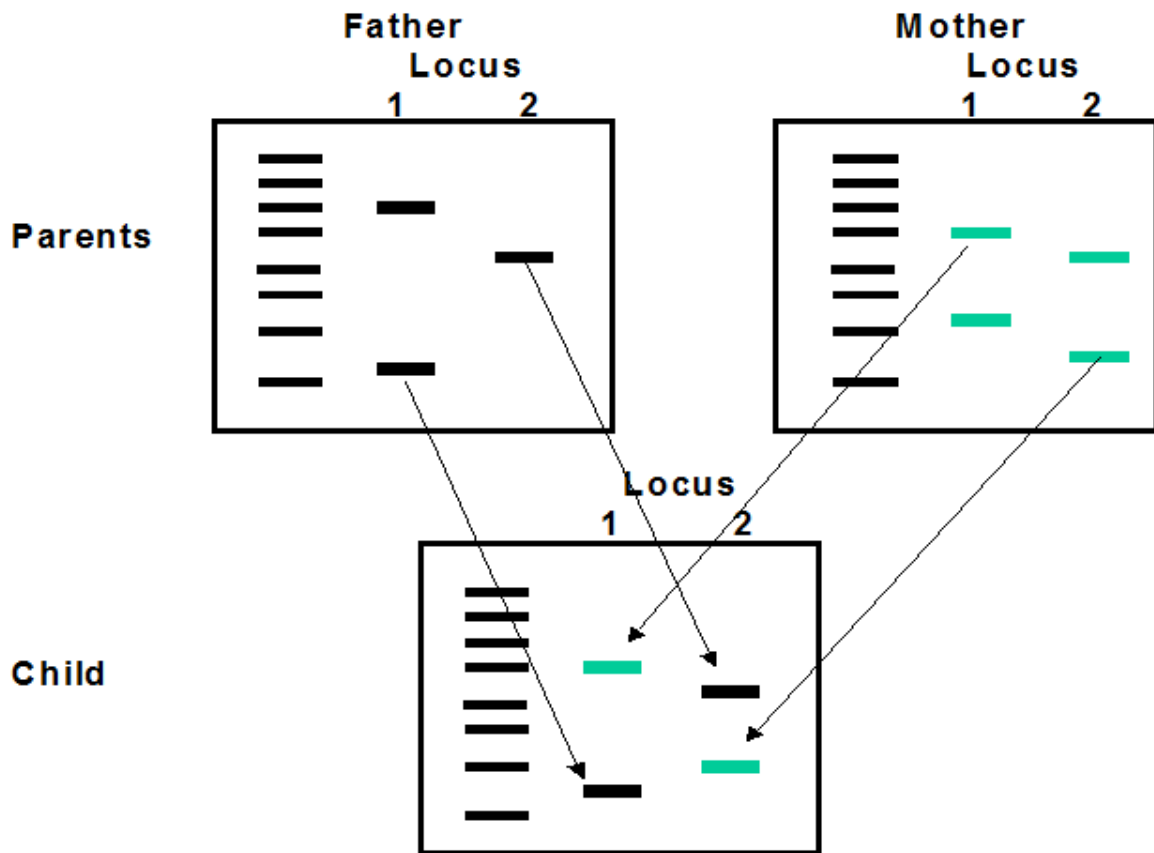

Who is father of child?

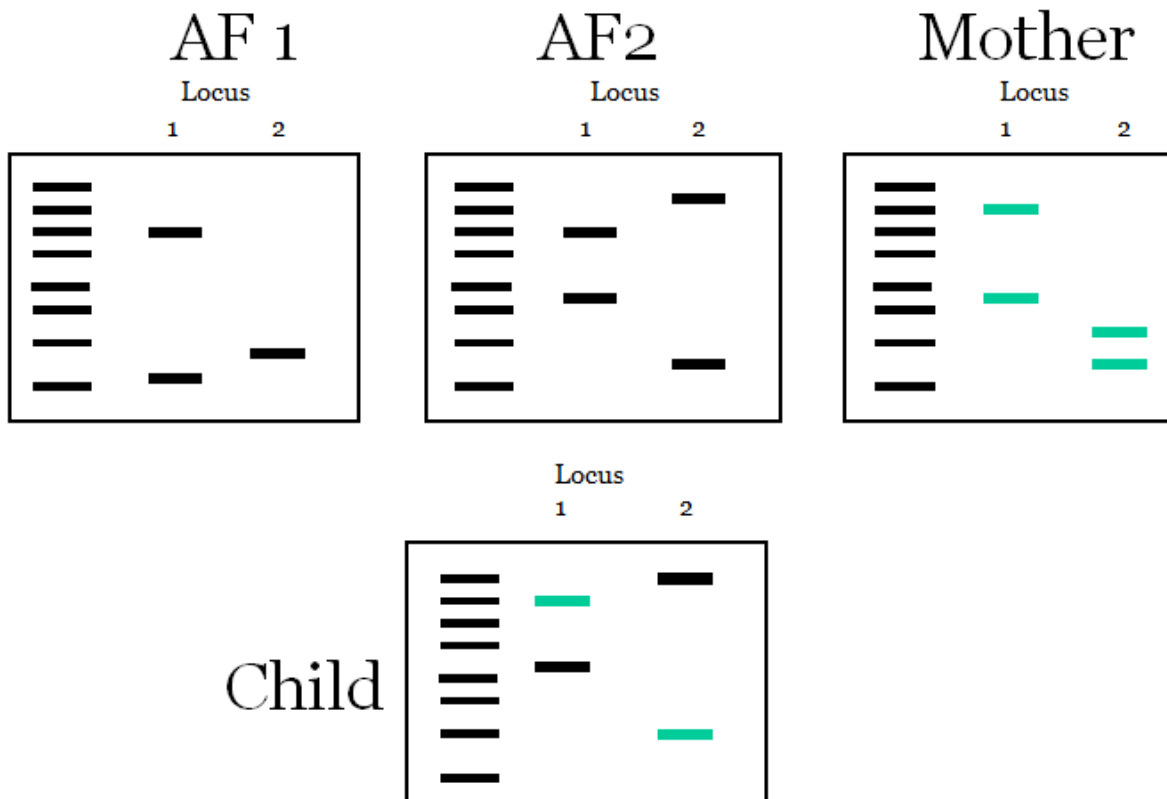

### Paternity Cases – DNA forensic applications

- RFLPs can be used in paternity cases or criminal cases to determine the source of a DNA sample. (i.e. it has forensic applications).

### RFLP used for constructing genetic maps

- RFLPs can be used to measure recombination rates which can lead to a genetic map with the distance between RFLP loci.

### Disease resistant genes may be analyzed by RFLP

- Direct method for selecting desirable genes such as disease resistance genes.



### **RFLP used to determine disease status**

- Determine disease status of an individual, i.e.
- Huntington
- Cystic fibrosis
- Sickle cell anemia

### **Mutation detection**

- RFLPs can be used to determine the disease status of an individual; (e.g. it can be used in the detection of particular mutations).

## Lesson 163

### Variable Number Tandem Repeats

#### VNTR

- VNTR are short nucleotide sequences organized as a tandem repeats on genomes.
- Found on many chromosomes
- Show variations in length between individuals.

#### Size of VNTR

- The size of repeat is about 7 to few tens of base pairs long.

#### Each variant acts as inherited allele

- Each variant acts as an inherited allele, allowing them to be used for personal or parental identification.

#### VNTR

- The rectangular blocks represent each of the repeated DNA sequences.
- The repeats are tandem - they are clustered together and oriented in the same direction.



## **VNTR - Methodology**

- Restriction enzymes are used to cut the VNTR blocks from its specific sites and analyzed by RFLP.
- Blocks (VNTR) are amplified by polymerase chain reaction.
- Amplified products are run on gel electrophoresis which also determined its length.

## **VNTR – variations in patterns of banding**

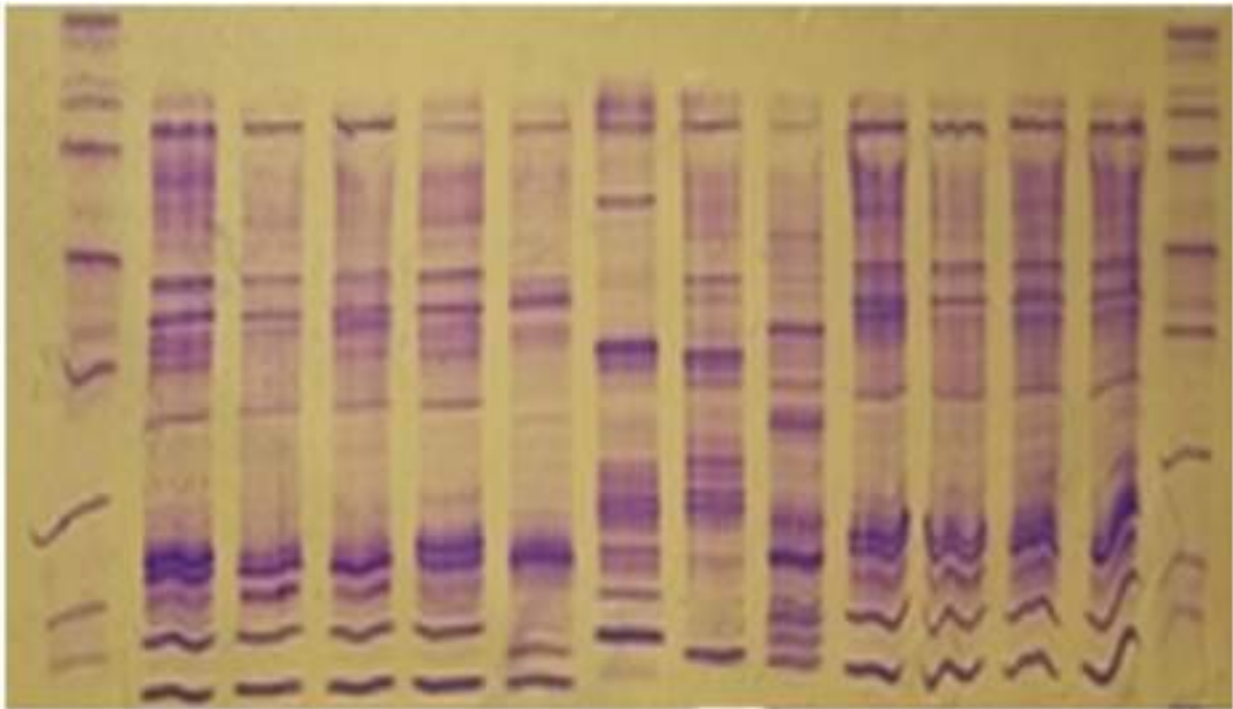

## **Importance of VNTR**

VNTRs are an important source of RFLP genetic markers used in linkage analysis (mapping) of genomes. When removed from surrounding DNA by the PCR or RFLP methods, and their size determined by gel electrophoresis or Southern blotting. As a result, they produce a pattern of bands unique to each individual.

## **Basic genetic principles during VNTR data analysis**

**Identity Matching:** VNTR alleles from a specific location must match. If two samples are from the same individual - same allele pattern

**Inheritance Matching:** Matching an individual with his/her parents or children, a person must have an allele that matches one from each parent.

## **Applications of VNTR**

- Microbiology
- DNA fingerprinting
- Genetic diversity
- Forensics
- Mapping of genomes
- Breeding patterns of wild or domesticated animals

## Lesson 164

### Short Tandem Repeat Polymorphism

Short tandem repeat sequences

- STR are repeats of nucleotide sequences.
- AAAAAA... mononucleotide
- ATATAT... dinucleotide
- TAGTAGTAG... trinucleotide
- TAGTTAGTTAGT... tetranucleotide
- TAGGCTAGGCTAGGC... pentanucleotide
- Different alleles contain different numbers of repeats.

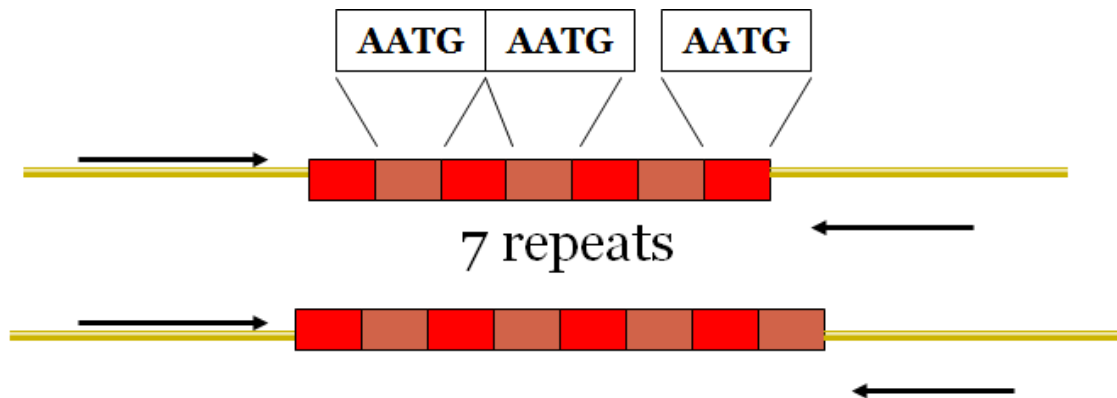

Repeat region is variable between samples while the flanking regions where PCR primers bind are constant

Homozygote = both alleles are the same length

Heterozygote = alleles differ and can be resolved from one another

STR markers - DNA forensics

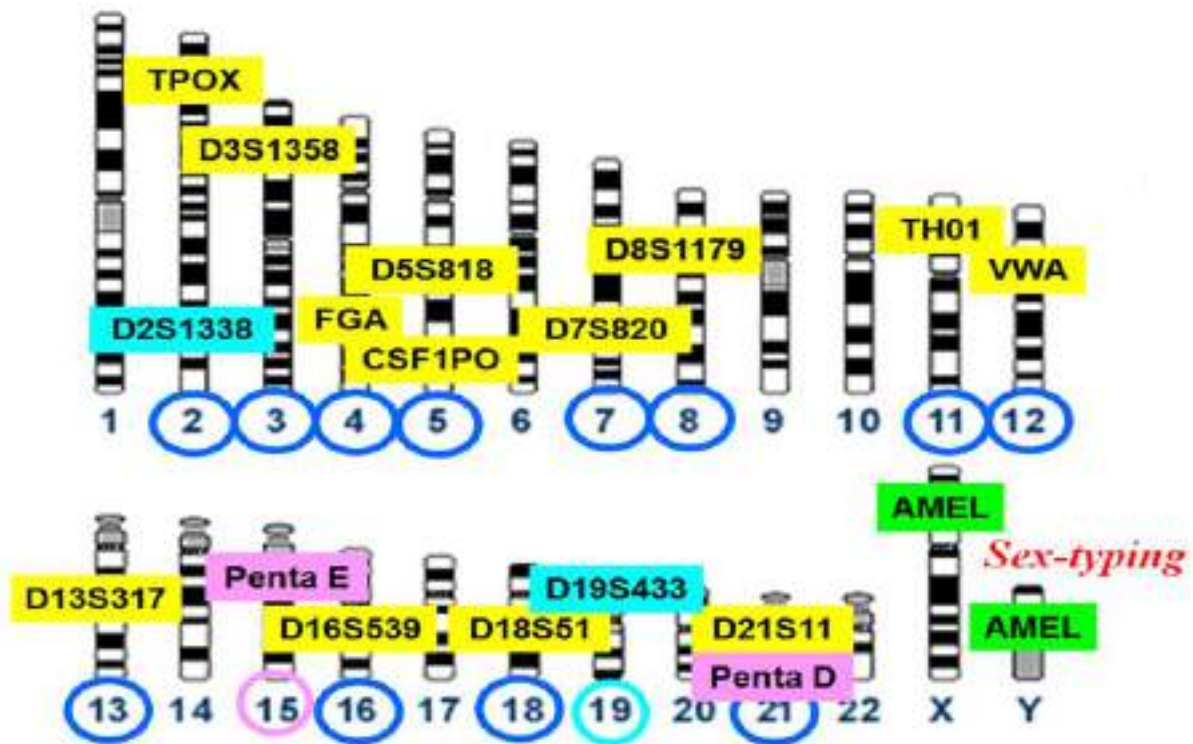

STR Marker	#Alleles
CSF1PO	11
FGA	19
TH01	7
TPOX	7
VWA	10
D3S1358	10
D5S818	10
D7S820	11
D8S1179	10
D13S317	8
D16S539	8
D18S51	15
D21S11	20

## Short tandem repeat sequence

### Allele 1

Short tandem repeat sequence

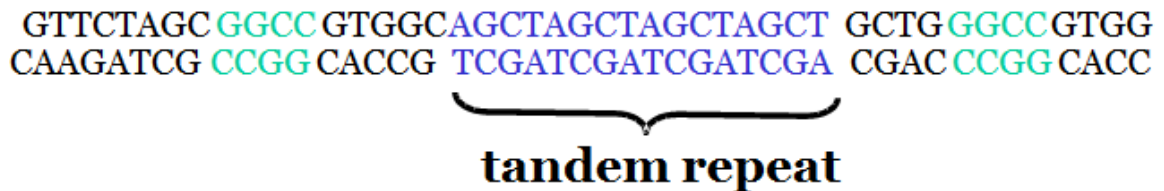

### Allele 2

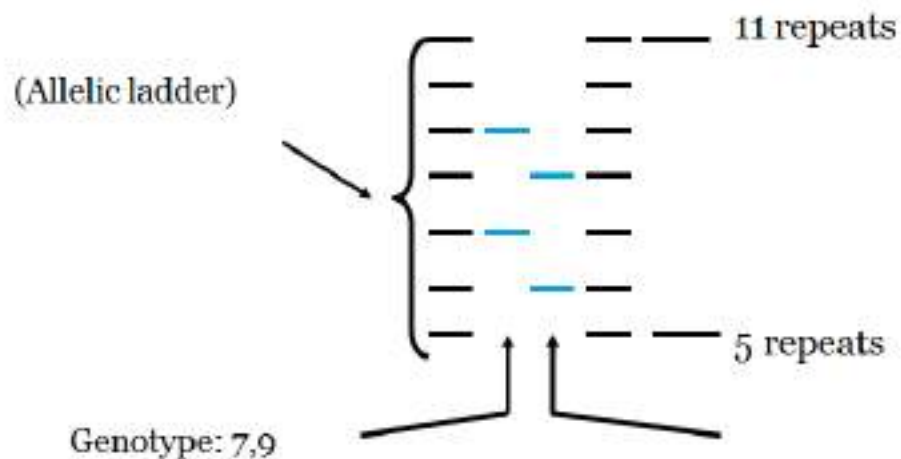

## Short tandem repeat sequences

- STR is simple repeats of nucleotide sequences.
- Mononucleotide, dinucleotide
- Used in linkage analysis
- Used in DNA forensics.

## **Lesson 165**

### **Random Amplified Polymorphic DNA**

**&**

### **Amplified Fragment Length Polymorphism**

#### **Random Amplified Polymorphic DNA**

- PCR based marker with 10-12 base pairs
- Random amplification of several fragments
- Amplified fragments run in agarose gel detected by ethidium bromide.
- Unstable amplification leads to poor repeatability

#### **Amplified Fragment Length Polymorphism**

- Restriction endonuclease digestion of DNA
- Ligation of adaptors
- Amplification of ligated fragments
- Separation of the amplified fragments via electrophoresis and visualization
- AFLPs have stable amplification and good repeatability



## Comparison

<b>Features</b>	<b>RFLP</b>	<b>RAPD</b>	<b>STR</b>	<b>SNP</b>
<b>Detection method</b>	Hybridization	PCR	PCR	PCR
<b>Type of probe/ primer used</b>	g DNA/ cDNA sequence of structural genes	Arbitrarily designed primer	Sequence specific primers	Sequence specific primers
<b>Requirement of radioactivity</b>	Yes	No/Yes	No/Yes	No/Yes
<b>Degree of polymorphisms</b>	Low	Medium to High	High	High

## Molecular Markers

- Different types of markers used to study diseases
- DNA forensics
- QTL traits in animals and plants

## Lesson 166

### Distribution of SNP

**SNP:** Genetic variations in a DNA sequence when a single nucleotide in a genome is altered.

### Single Nucleotide Polymorphism

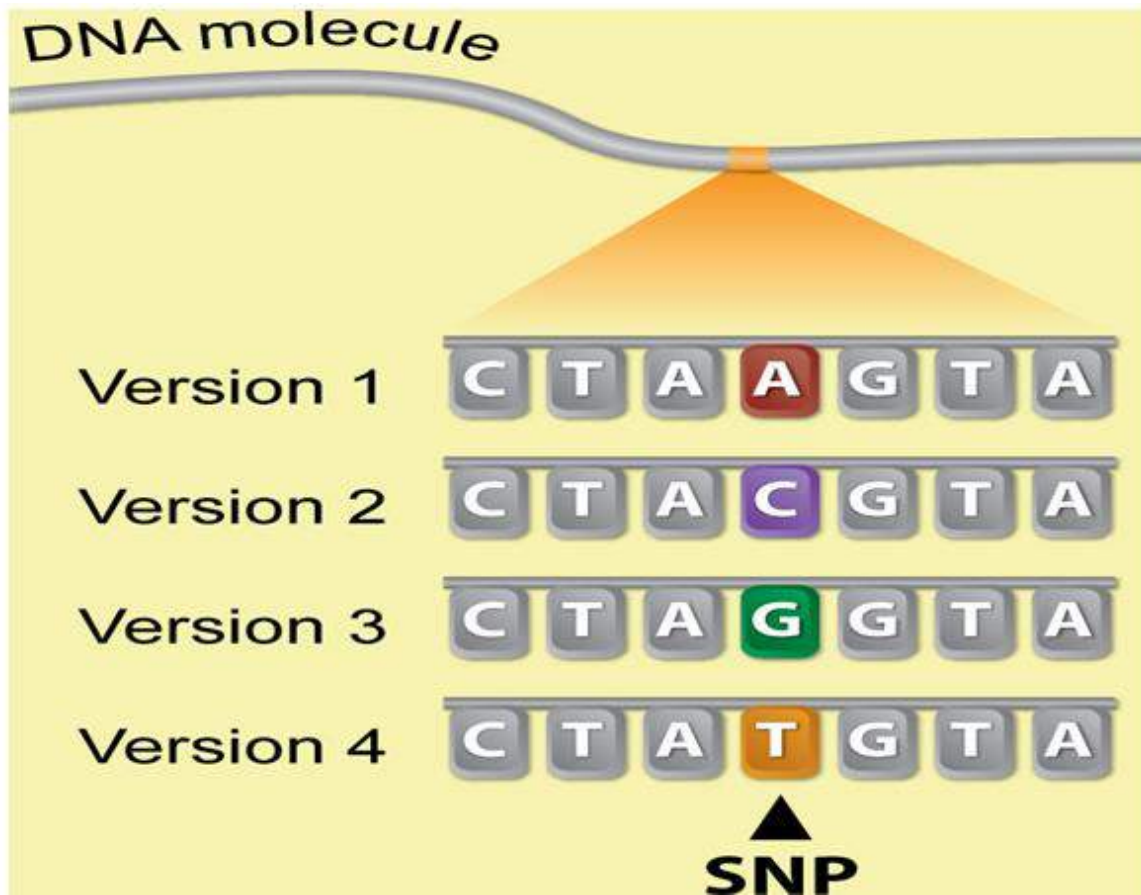

## SNP

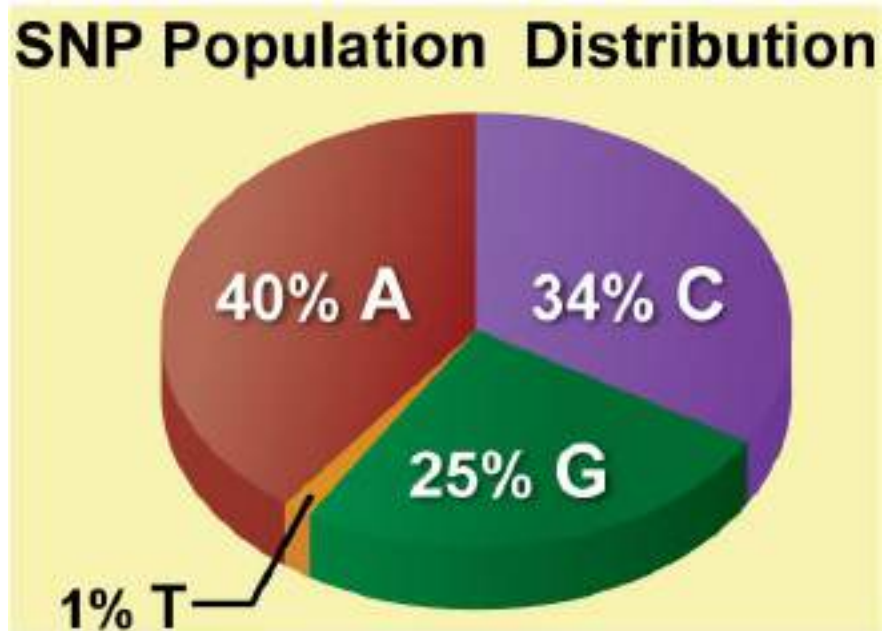

### HUMANs SNP DISTRIBUTION

- 25,000 Non-synonymous
- 50,000 Synonymous
- 25,000 Regulatory region
- 50,000 Intragenic
- 50,000 Distributed intergenic SNPs

## Human SNP Distribution

### Most common changes

#### Transitions:

Purines to Purines

Pyrimines to Pyrimidines

#### Transversion:

Purines to Pyrimidines

Pyrimidines to Purines

### Single-base insertions & deletion (indel)

### How SNP are indicated

IUPAC code	Meaning
A	A
C	C
G	G
T	T
M	A or C
R	A or G
W	A or T
S	C or G
Y	C or T
K	G or T
V	A or C or G
H	A or C or T
D	A or G or T
B	C or G or T
N	G or A or T or C

### **SNP Related Databases**

- Androgen Receptor Mutation Database
- Ataxia-Telangiectasia Mutation Database
- Breast Cancer Mutation Database
- Cystic Fibrosis Mutation Database
- Cytokine Polymorphism Database
- Fanconi Anemia Mutation Database
- GM2 Gangliosidoses Database
- Human Ornithine Transcarbamylase Database
- Human Type I and Type III Collagen Mutation Database
- Hypertension Candidate Gene SNP Database

SNP are found throughout the genomes.

## Lesson 167

### SNP- Screening and importance

#### People can be grouped based on SNP profile

- Genome of each individual contains distinct SNP pattern.
- People can be grouped based on the SNP profile.

#### SNP - found in coding and noncoding regions

- SNPs are found in coding and (mostly) noncoding regions.
- Occur with a very high frequency about 1 in 1000 bases to 1 in 100 to 300 bases.

#### SNP SCREENING methods: Two different screening strategies

- Many SNPs in a few individuals
- A few SNPs in many individuals

SNP Screening- Different strategies will require different tools.

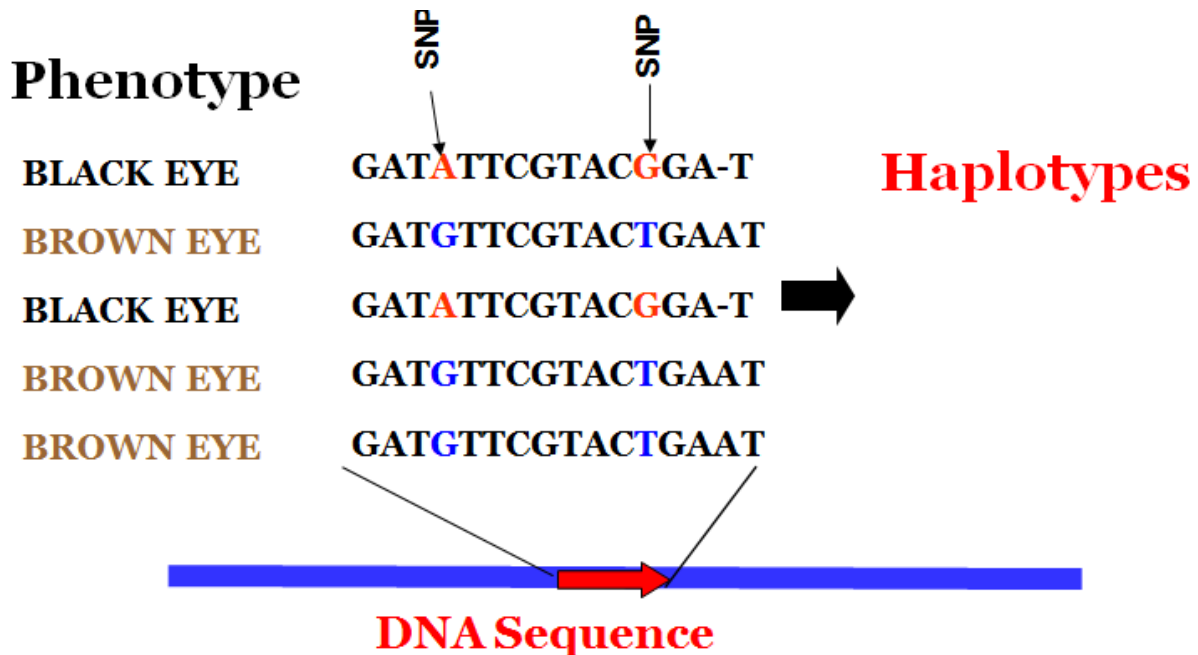

## **SNP Importance**

- In disease diagnosis
- In finding predisposition to diseases
- In drug discovery and development
- In drug responses
- Investigation of migration patterns
- Medication and diagnosis at individual level