

RVU6425

TOPMOUNT WORKSTATION SINK

RUVATI[®]
SPECIFICATION SHEET

MATERIAL

- True 16 Gauge Thickness
- Premium T304 Grade Stainless Steel
- 18/10 Chromium/Nickel Content
- Commercial Brushed Finish

FEATURES

- Heavy duty sound guard padding and undercoating
- Slanted bottom with elegant drain grooves for easy draining
- Single-Tier Ledge for Accessories



IN THE BOX

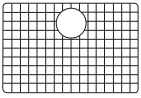

Rinse Grid
[RVA68023]

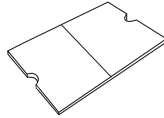

Cutting Board
[RVA1225]



Cut-out
Template



Basket Strainer
[RVA1025]



Drain Cover
[RVA1035]



Mounting Clips
[RVA11042]

NOMINAL DIMENSIONS

- Exterior:** 25" (wide) x 22" (front-to-back)
- Interior Bowl:** 23" (wide) x 16" (front-to-back)
- Bowl Depth:** 12"
- Minimum Cabinet Size:** 27" wide
- Drain Hole Size:** 3-1/2"

- Installation Type:** Topmount
- Inside Corners:** Rounded
- Drain Location:** Rear Center

OPTIONAL ACCESSORIES (SOLD SEPARATELY)



Deep Basket
Disposal Flange
[RVA1049ST]

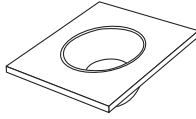

Mixing Bowl
and Platform
[RVA1288]

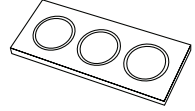

Condiment
Serving Tray
[RVA1377]

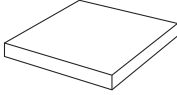

Butcher Block
[RVA2445ACA]

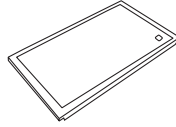

Black Plastic
Cutting Board
[RVA1217BLK]

DIMENSIONS

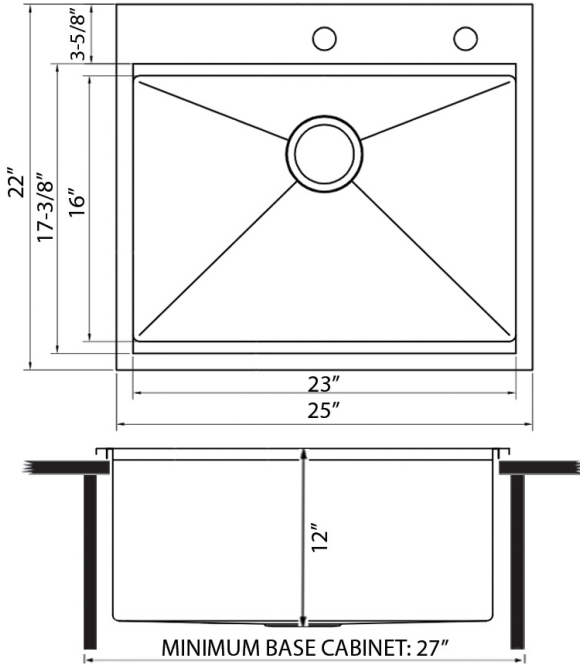

Register your product at www.ruvati.com/register.