

RVH6300

UNDERMOUNT KITCHEN SINK

RUVATI[®]
SPECIFICATION SHEET

MATERIAL

True 16 Gauge Thickness
Premium T304 Grade Stainless Steel
Nano-PVD colored finish: easy to clean, and long lasting

FEATURES

- Heavy duty sound guard padding and undercoating
- Slanted bottom with elegant drain grooves for easy draining
- Rounded inside corners

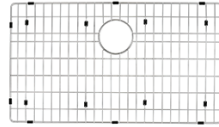

COLOR OPTIONS

BL: Black Stainless Steel

GG: Matte Gold Brass Tone

IN THE BOX



Basket Strainer
[RVA1022BL / GG]

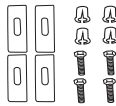

Mounting Clips
[RVA11031]

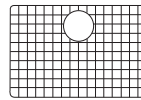

Rinse Grid
[RVA66300]



Cut-out
Template

NOMINAL DIMENSIONS

Exterior: 30" (wide) x 19" (front-to-back)
Interior Bowl: 28" (wide) x 17" (front-to-back)
Bowl Depth: 9"
Minimum Cabinet Size: 33" wide
Drain Hole Size: 3½"

Installation Type:
Undermount

Inside Corners:
Rounded

Drain Location:
Rear Center

RUVATI USA
www.ruvati.com

Phone: 1.855.478.8284
Email: support@ruvati.com

OPTIONAL ACCESSORIES (SOLD SEPARATELY)

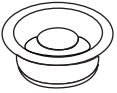

Garbage
Disposal Flange
[RVA1041BL / GG]



cUPC certified by IAPMO to meet US and Canada plumbing standards.
Codes compliance: ASME A112.19.3/CSA B45.4

DIMENSIONS

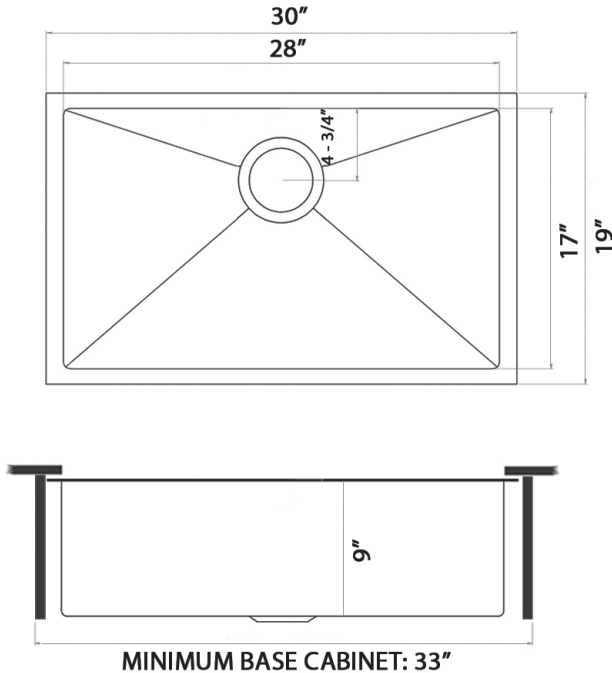

Register your product at www.ruvati.com/register.