

Temporary Work Light Double End 60w



DESCRIPTION:

Touch-Plate's Temporary Work Lights were designed to be used as temporary lighting and/or areas that need 360° lighting with a protective cage. Temporary Work Lights can offer energy savings of 30% or greater over traditional lighting. The Temporary Work Light is optimal for temporary installations and outdoor areas.

PRODUCT FEATURES:

- Cooling heatsink fins, no fans
- >6KV surge protection
- Isolated driver for better heat dissipation
- Linkable (10pcs max)
- Remote Controlled
- Lifetime of 50,000 hrs or greater
- UL Listed (E489971)
- 5 Year Limited Warranty

SPECIFICATIONS:

- Wattage: 60w
- Lumens: 6,500 (approx > 105lm/w)
- Equivalence: 200w HID/HPS/MH
- CRI: >80Ra
- 360° Beam Angle
- IP Rating: IP64
- LED Chips: Epistar SMD 2835
- PF: >0.90

PHYSICAL PARAMETERS:

- Dimensions
 - Diameter: 6.22"
 - Height: 10.67"
- Weight
 - 5.40lbs

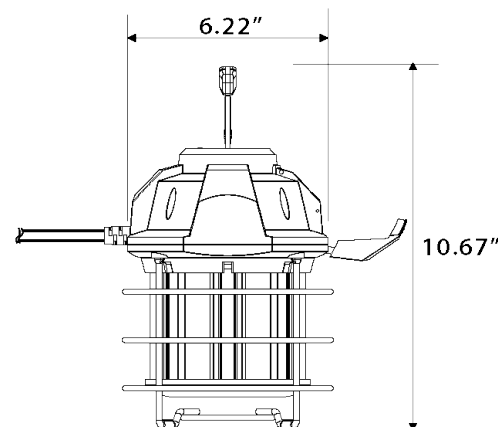

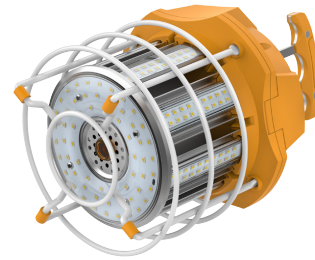

Temporary Work Light Double End

ORDERING GUIDE

LED Type XXX-	Lumens - Wattage XXX-XXX-	CCT XX	Voltage X-
<ul style="list-style-type: none"> TWD Temporary Work Double 	<ul style="list-style-type: none"> 065-060 6,500 ^ _ Ž 60i 	<ul style="list-style-type: none"> 35 3500k 40 4000k 45 4500k 50 5000k 	<ul style="list-style-type: none"> R 120v

INCLUDED ACCESSORIES

- US 120v plug (5' Long)
- Portable, retractable handle
- Remote Control

ACCESSORIES (SOLD SEPARATELY)

- Stainless Steel Cable (2f t/.5m)
- Stainless Steel Cable (3f t/1m)
- Stainless Steel Cable (7f t/2m)
- Stainless Steel Cable (10f t/3m)
- Stainless Steel Cable (20f t/6m)
- S Hook Clip (Medium & Large)

PHOTOMETRIC

LUMINOUS INTENSITY DISTRIBUTION DIAGRAM

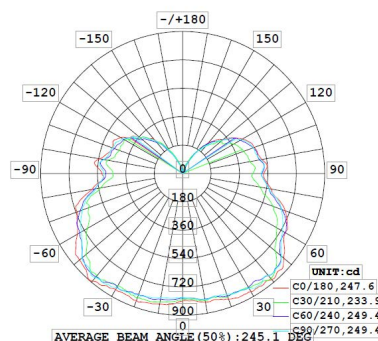

Temporary Work Light Double End

INSTALLATION INFORMATION

This product must be installed in accordance with National Electrical Code(NEC) and/or applicable local codes, by a qualified electrician.

DANGER - RISK OF SHOCK - DISCONNECT POWER BEFORE INSTALLATION

- Ensure the area where the the LED light will hang can hold up to 60lbs. Open the 'O' hook and affix the LED.
- Plug in the LED and ensure that it works properly.

