

747 ATLAS AIR -7J

DIFFERENCES

PANEL DIAGRAMS

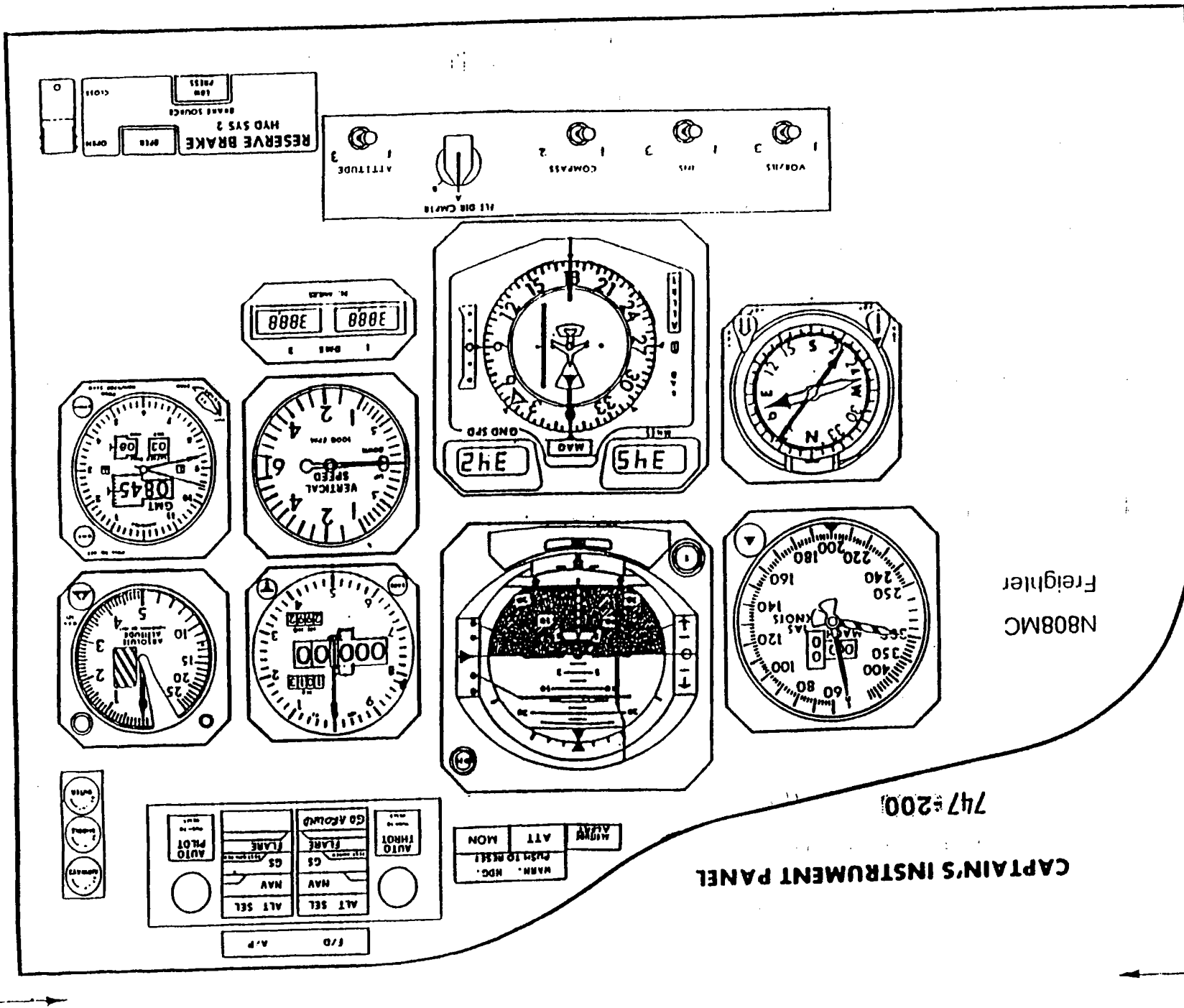

PILOTS' INSTRUMENT PANELS

PILOT PANEL

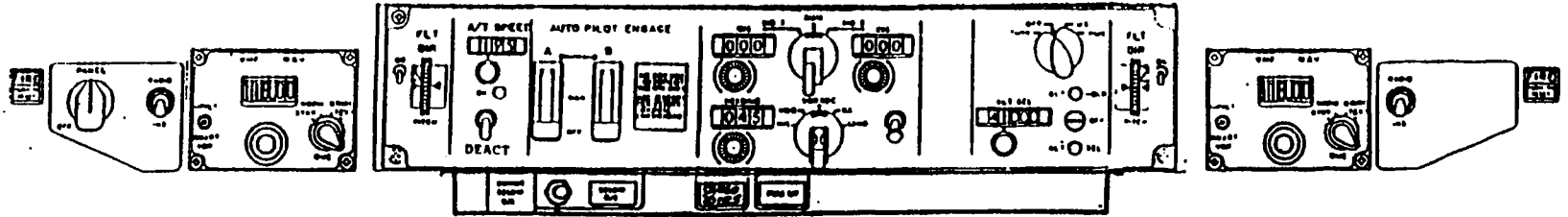

N808MC

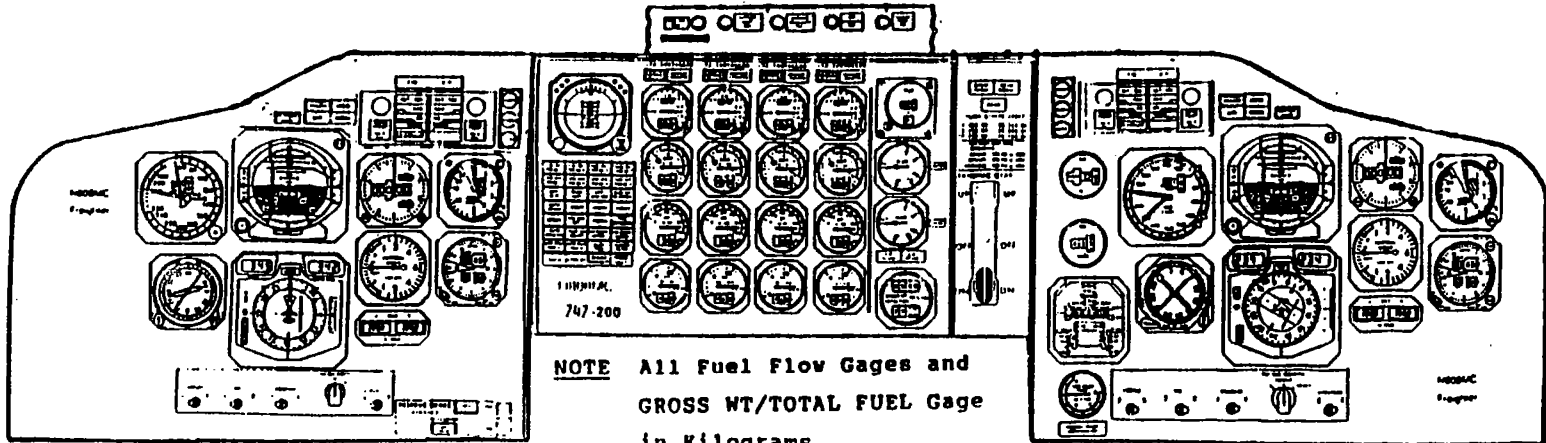

CAPTAIN'S INSTRUMENT PANEL

CENTER INSTRUMENT PANEL

FIRST OFFICER'S INSTRUMENT PANEL

747 ATLAS AIR -808-7J

DIFFERENCES

PANEL DIAGRAMS

PILOTS' OVERHEAD PANEL 747-200

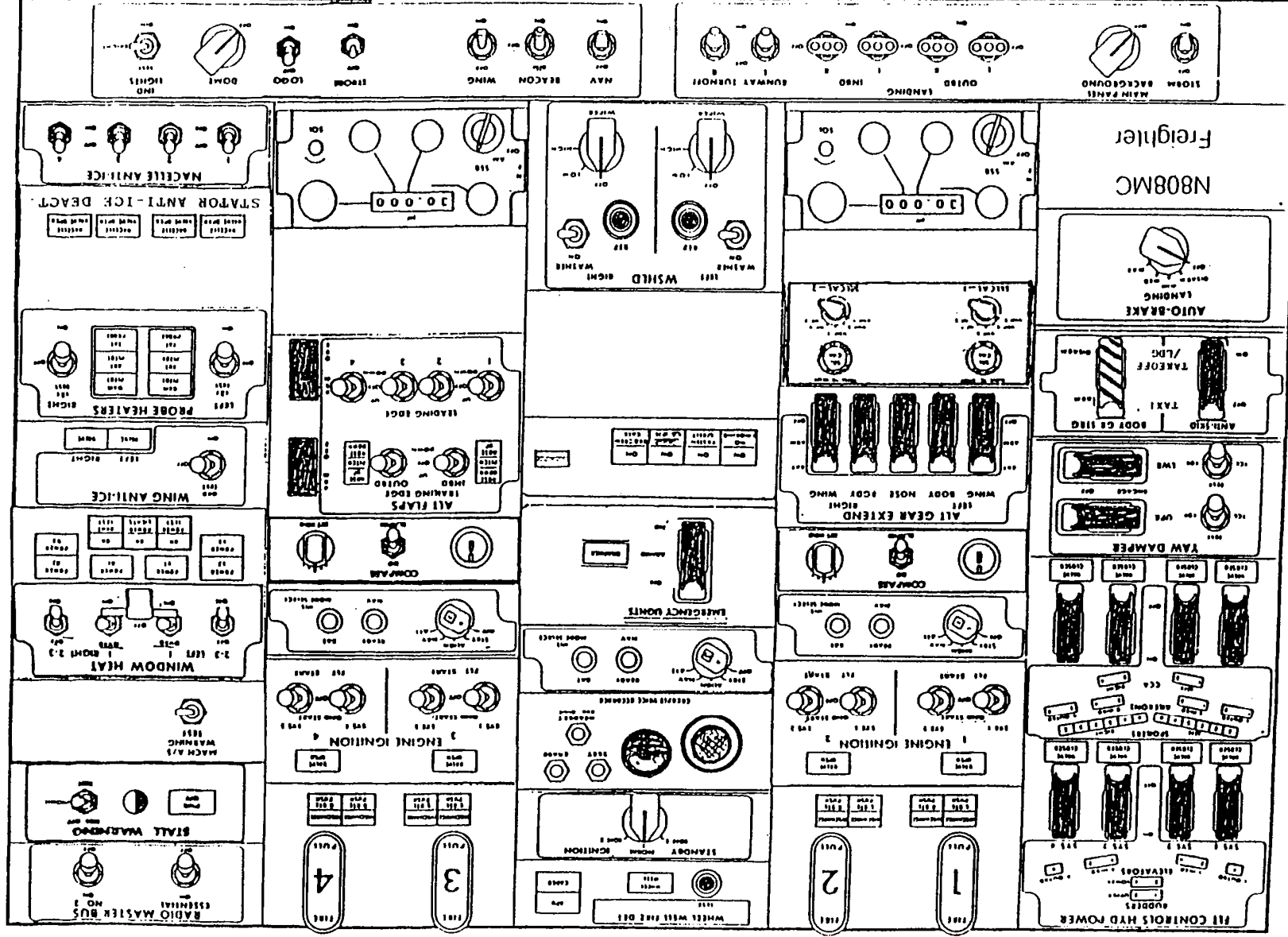

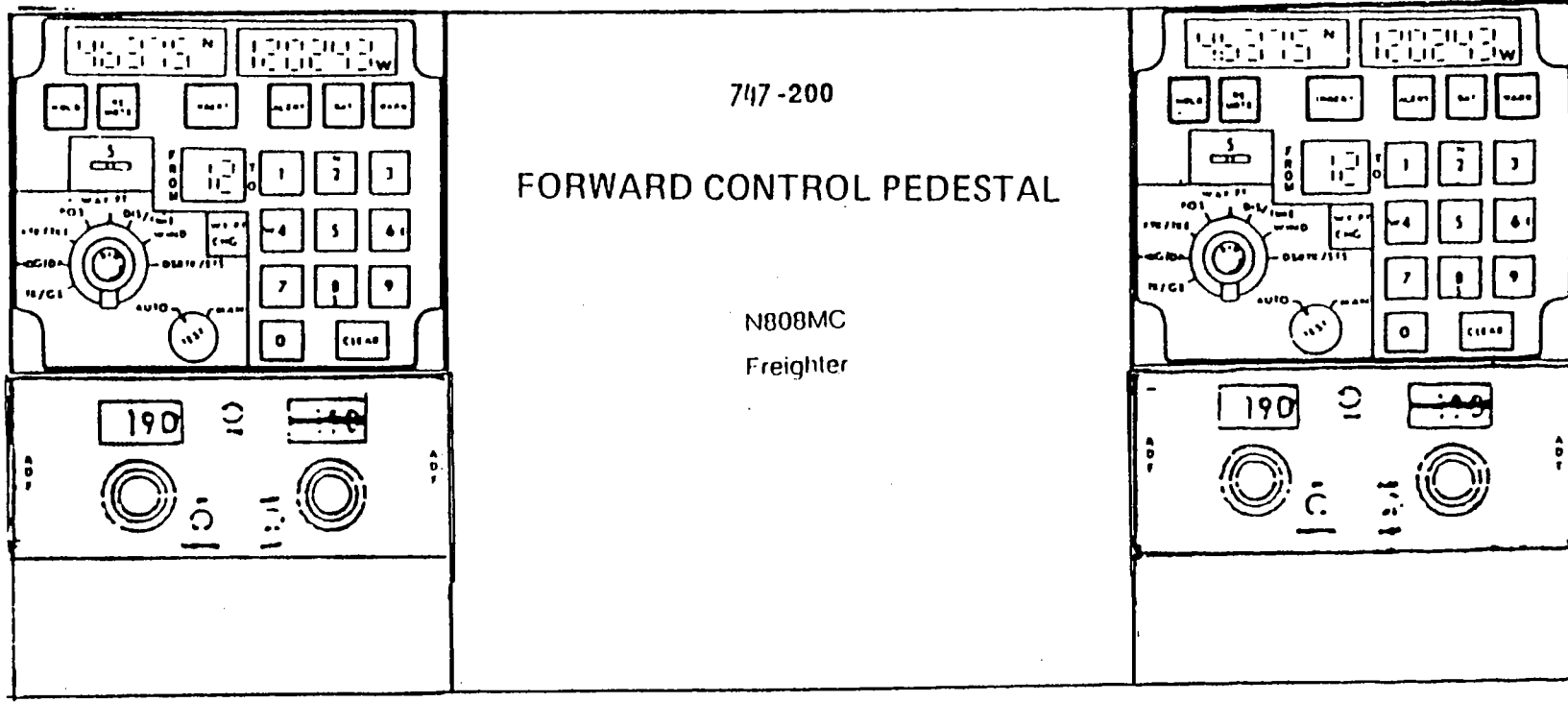

AFT CONTROL PEDESTAL

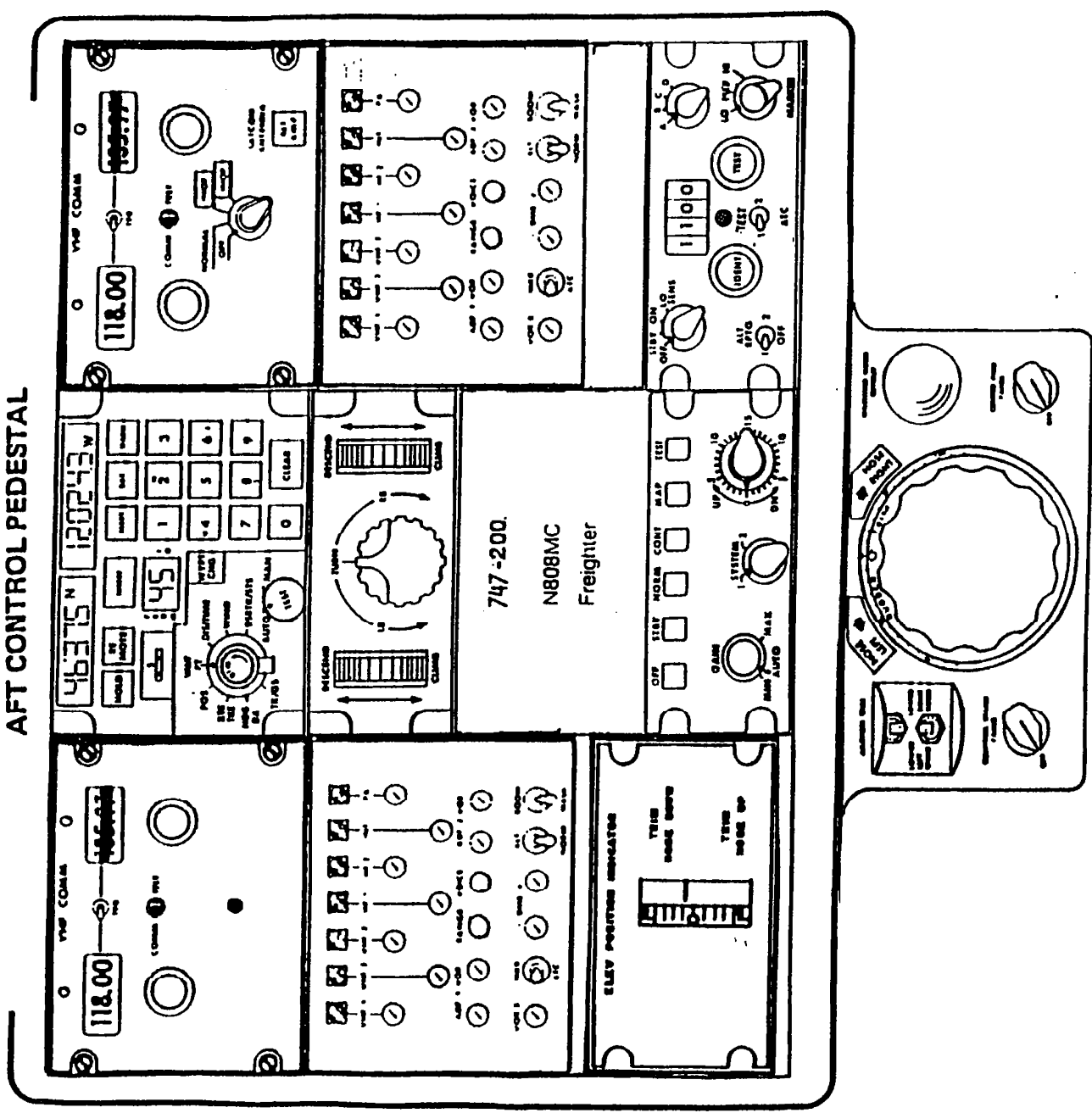

PILOTS' CONTROL STAND

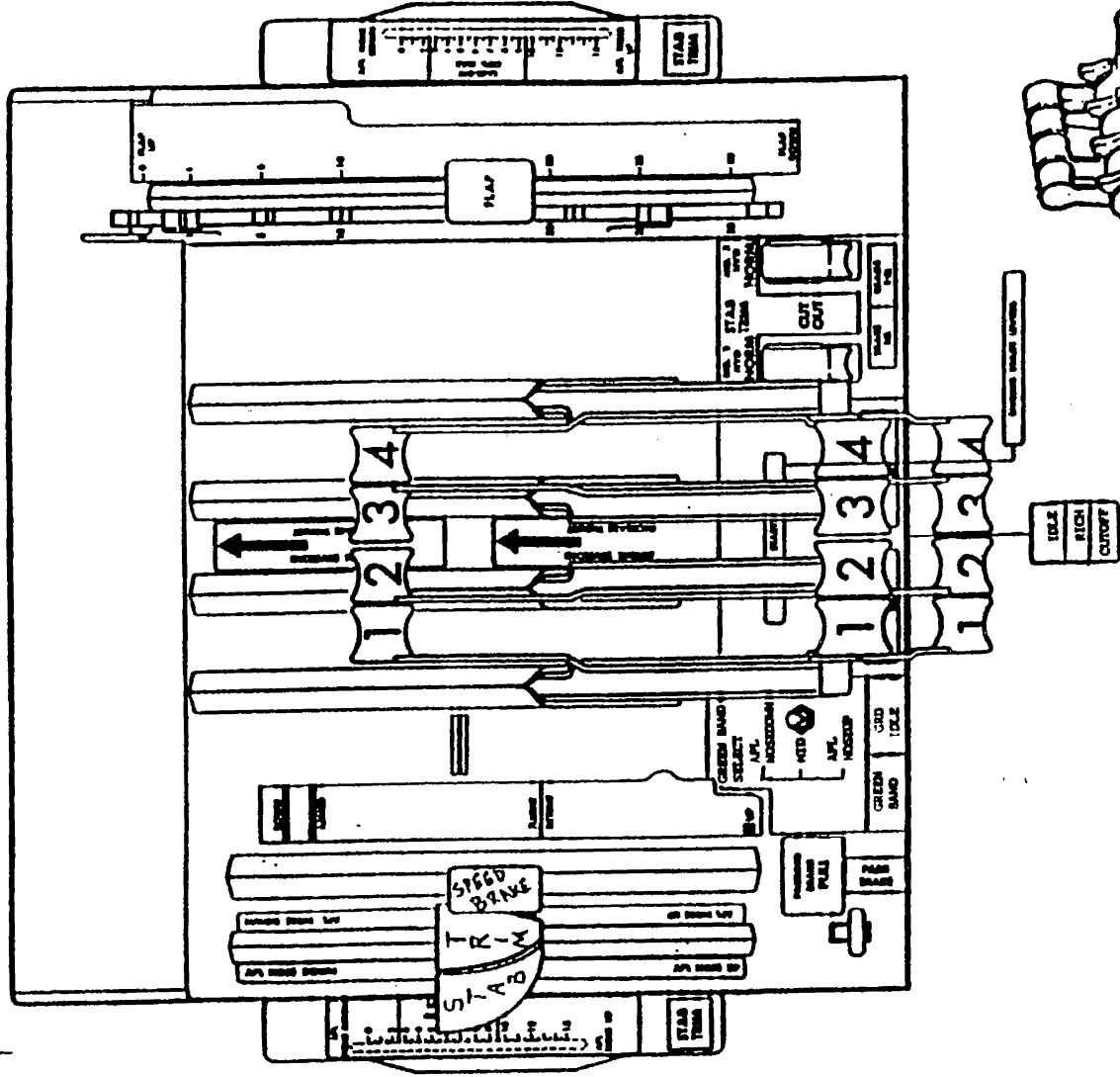

N808MC
Freighter

747-200

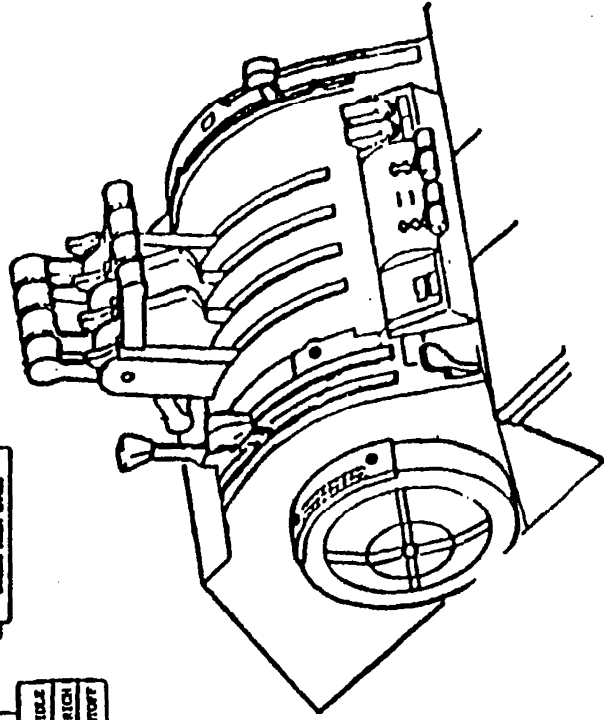

747 ATLAS AIR -808-7J

PANEL DIAGRAMS

DIFFERENCES

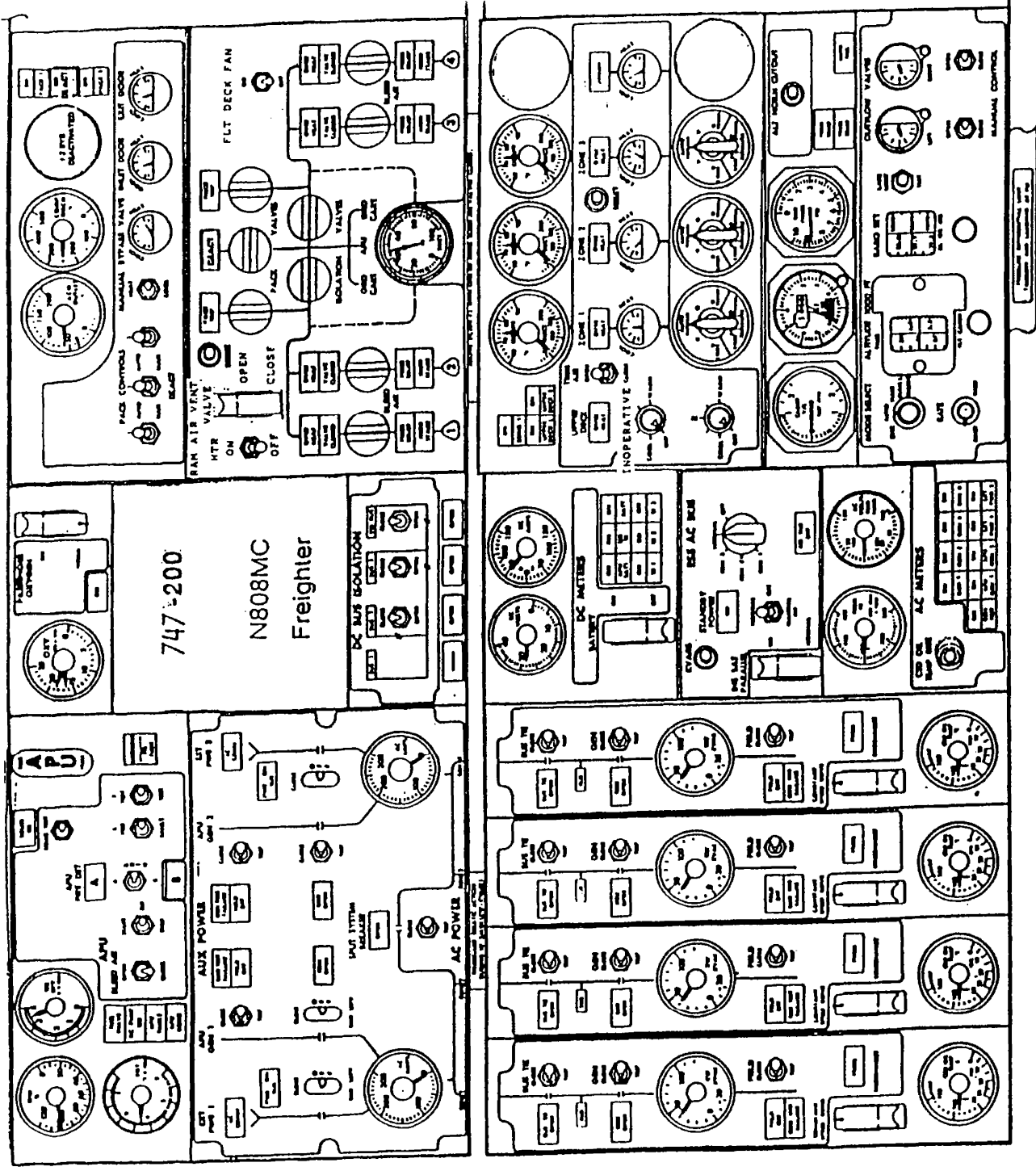

FLIGHT ENGINEER'S INSTRUMENT PANEL-UPPER PANELS-LEFT

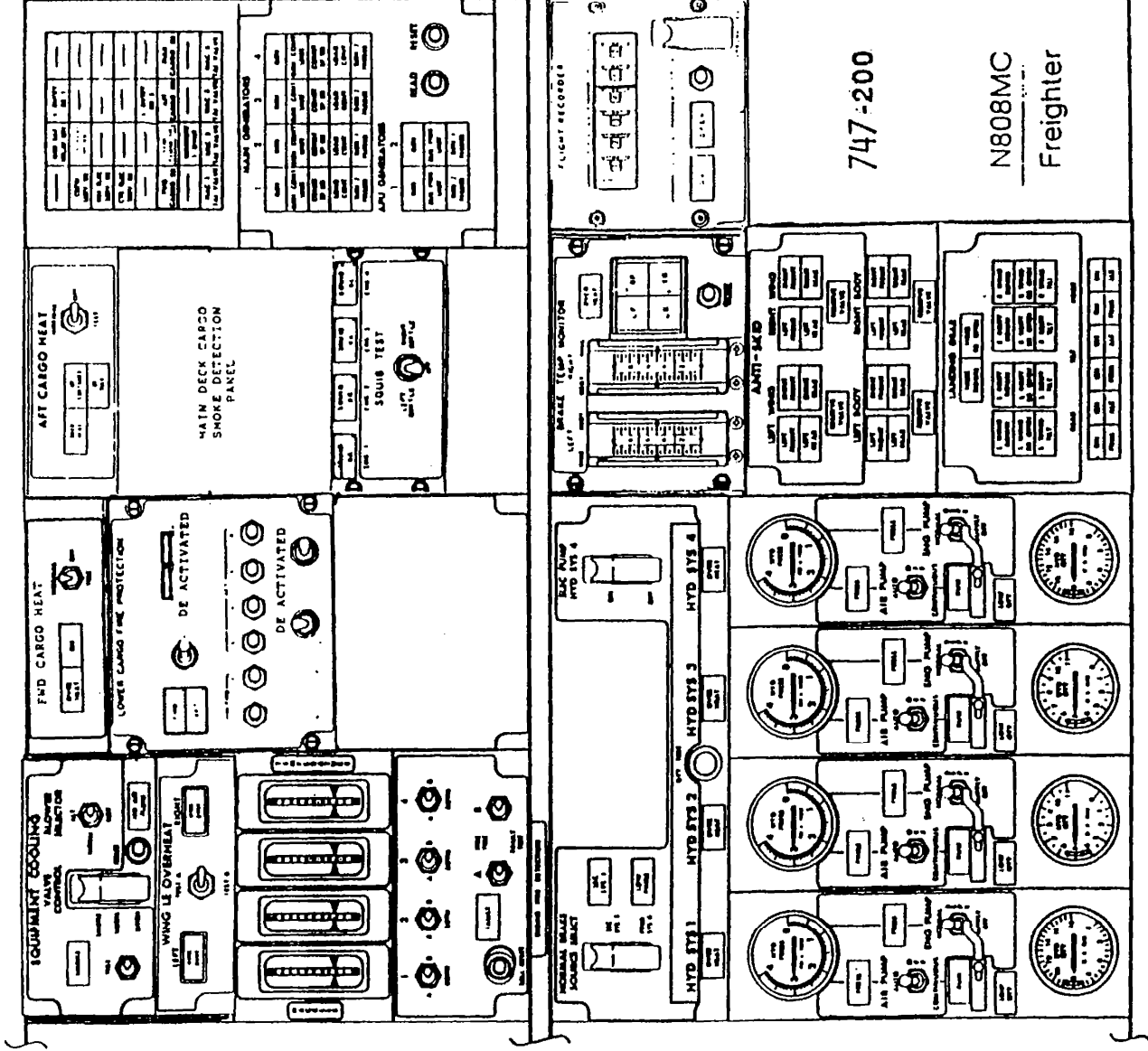

FLIGHT ENGINEER'S INSTRUMENT PANEL - UPPER PANELS-RIGHT

747 ATLAS AIR -808-7J

PANEL DIAGRAMS

DIFFERENCES

NOTE ALL FUEL QUANTITY AND FUEL USED GAGES ARE IN KILOGRAMS

FLIGHT ENGINEER'S INSTRUMENT PANEL-LOWER PANEL-LEFT & CENTER

747-200

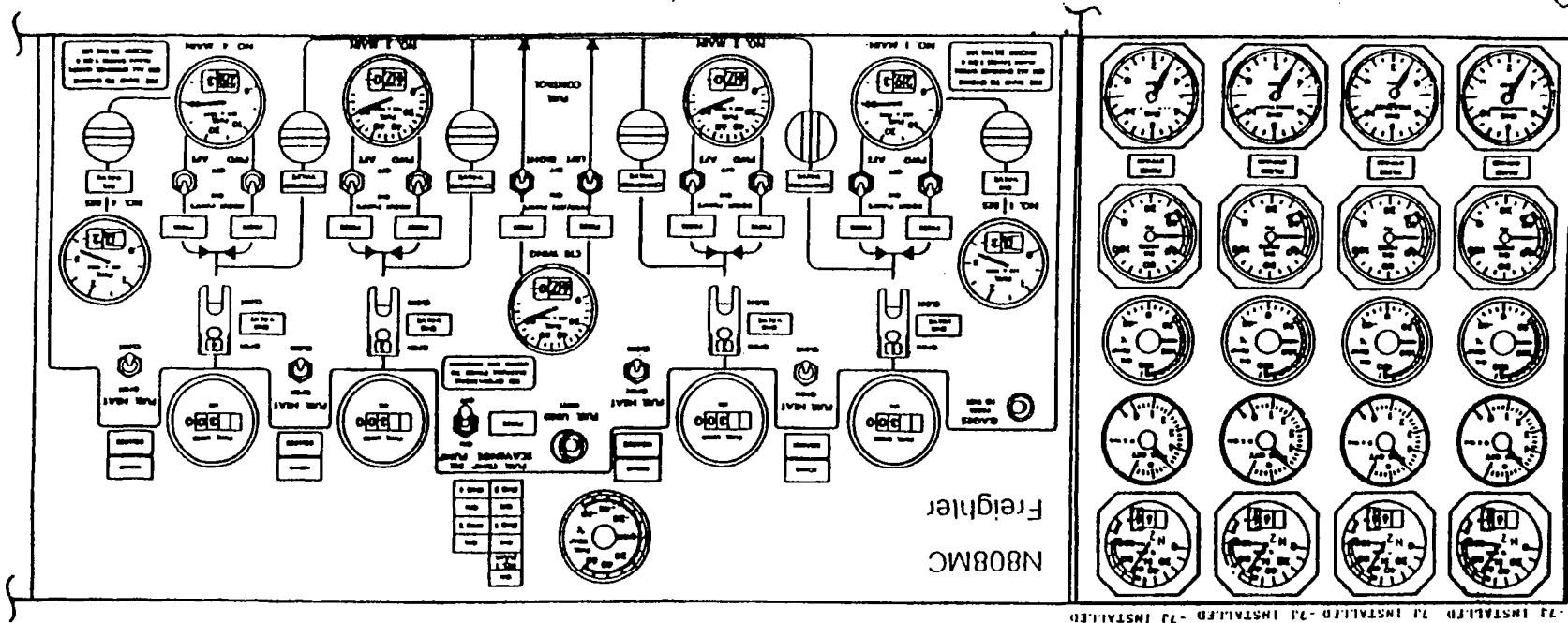

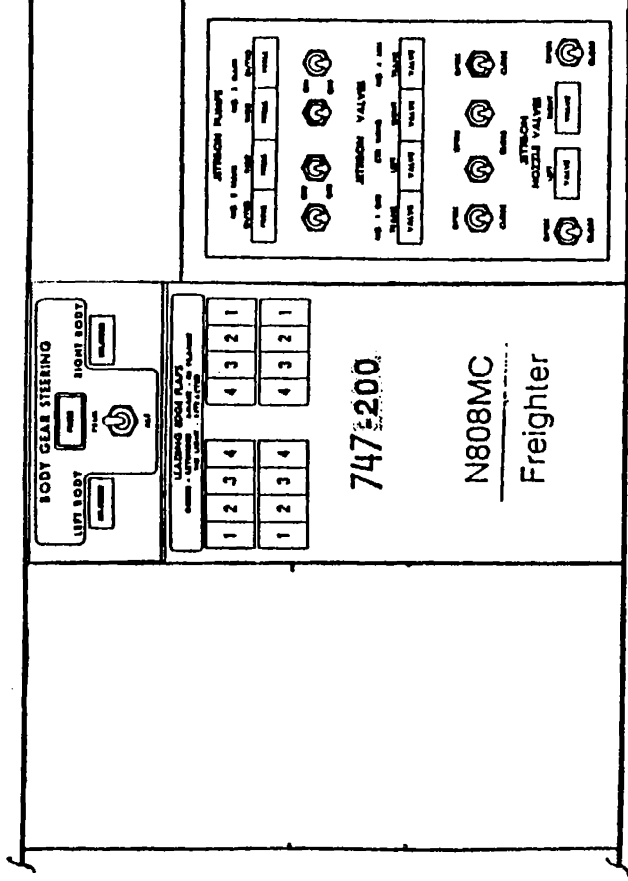

**FLIGHT ENGINEER'S INSTRUMENT PANEL-
LOWER PANEL- RIGHT**