

19

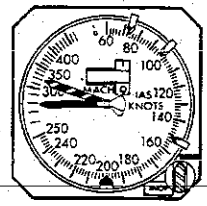

▷ thru ▷ As installed

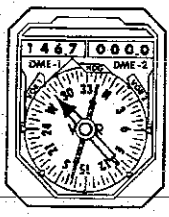
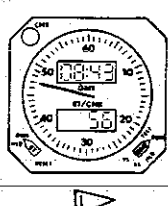
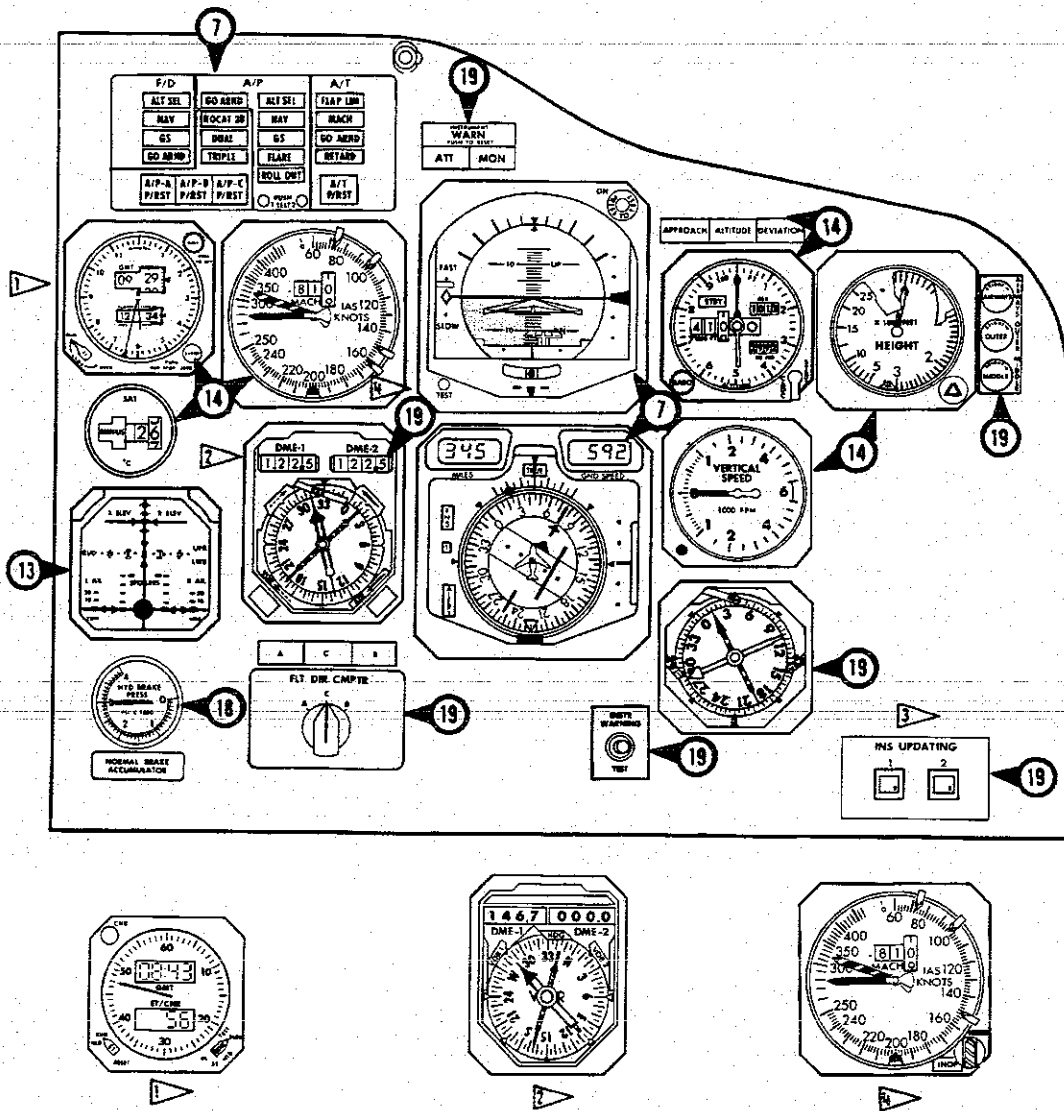

1 thru 4 As installed

FIRST OFFICER'S INSTRUMENT PANEL

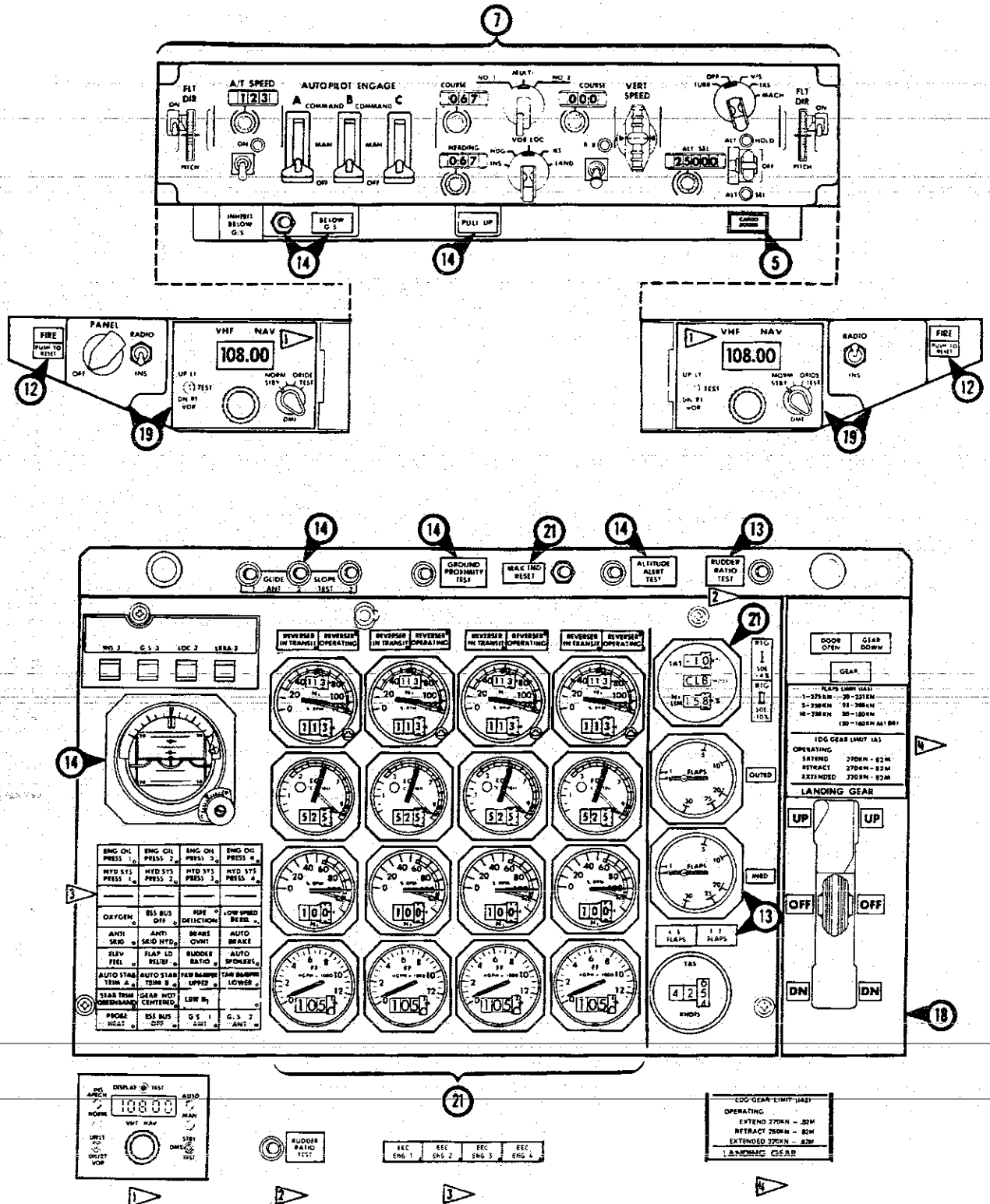

**PILOTS' CENTER INSTRUMENT PANEL & LIGHTSHIELD**

B91062

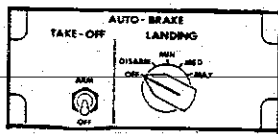
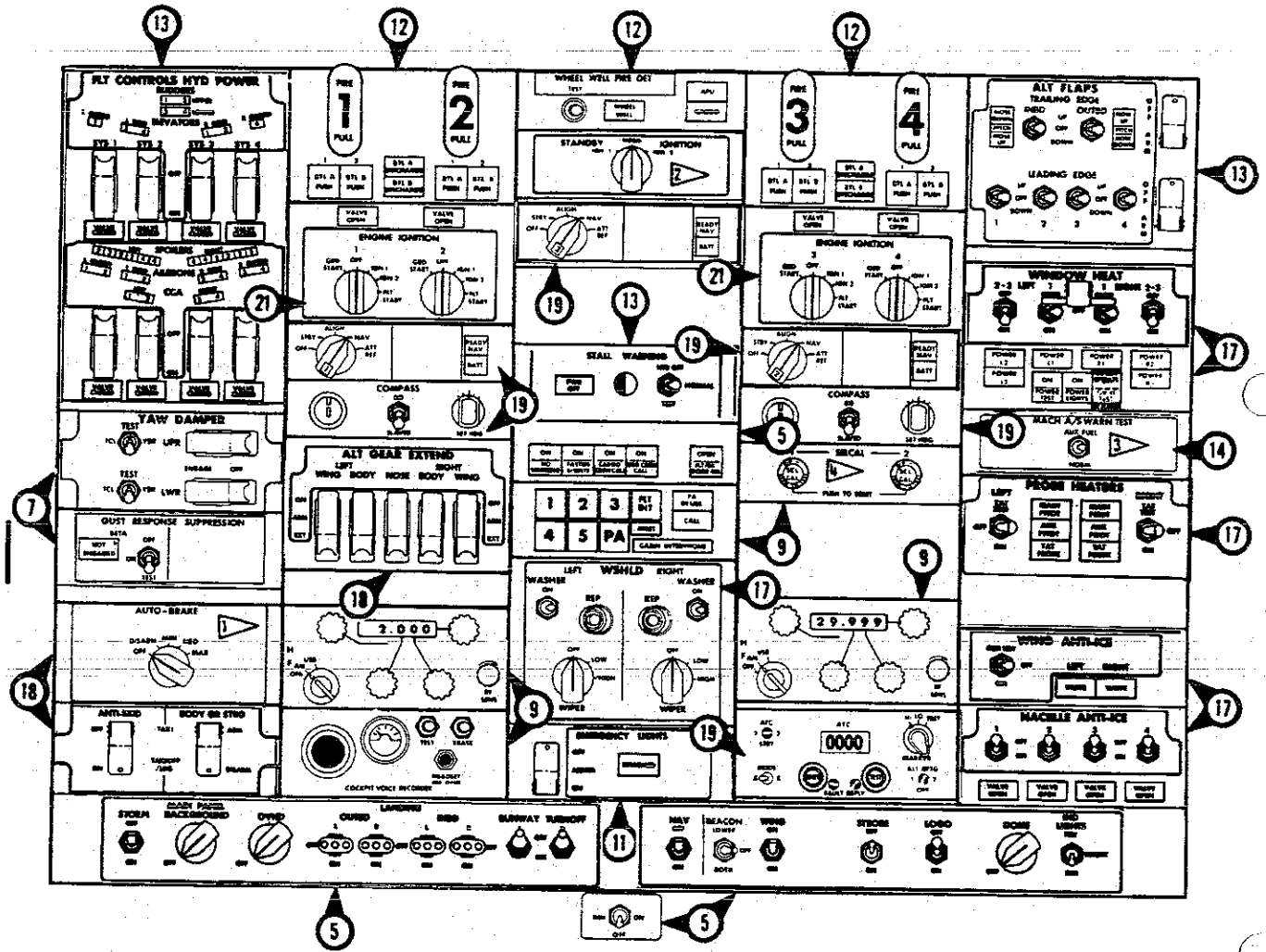

1

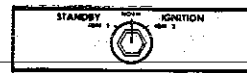

2



3

1 thru 4 As installed

PILOTS' OVERHEAD PANEL

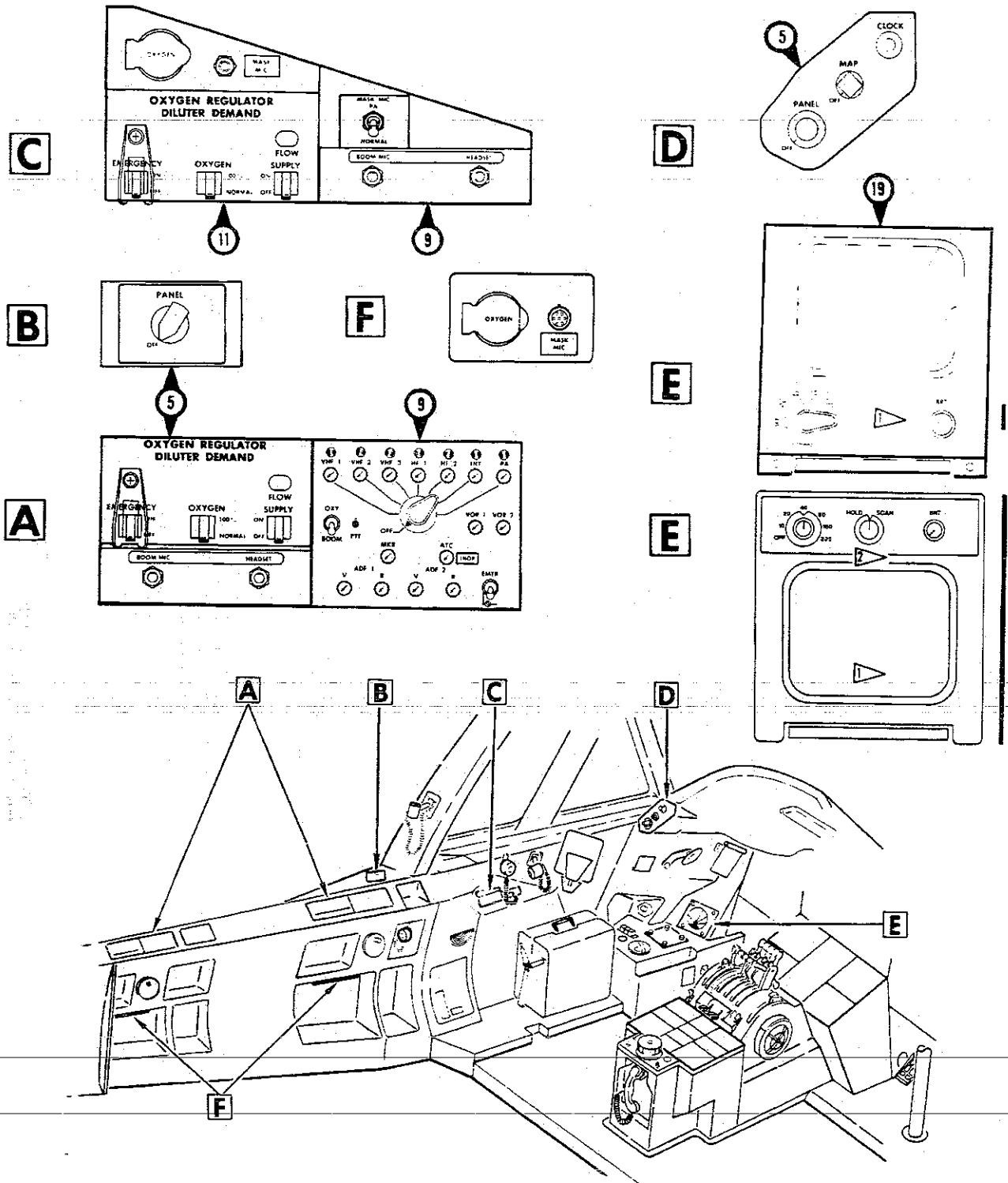

1 and 2 As installed

**CAPTAIN'S & FIRST OFFICER'S AUXILIARY PANELS**

B91853

16P  
Apr 01/88

05.20.05

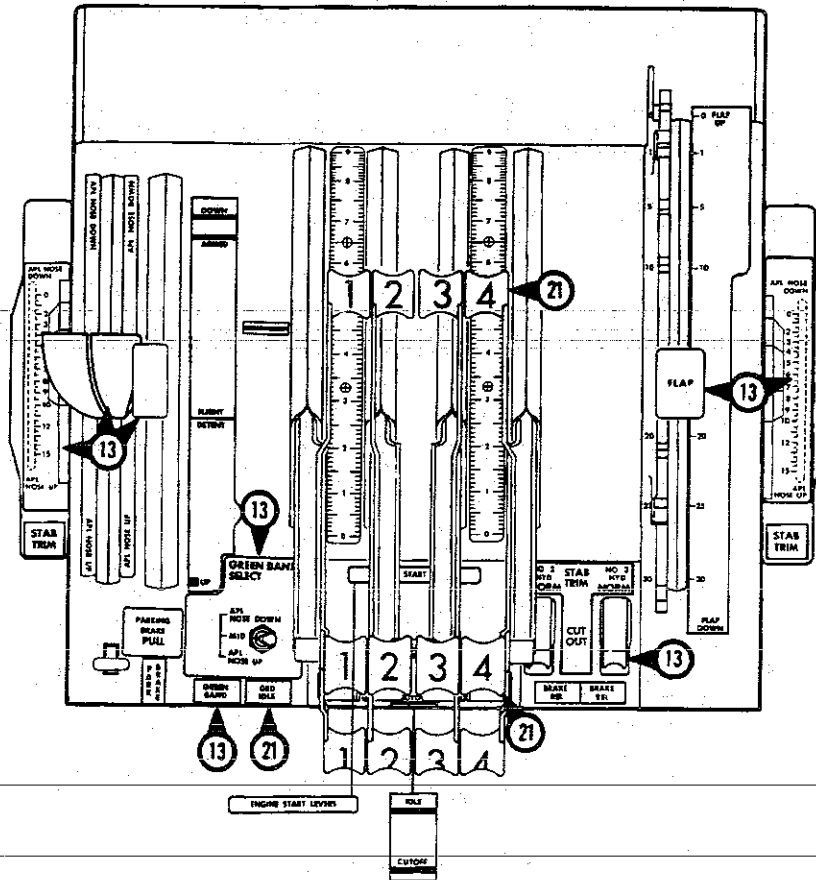
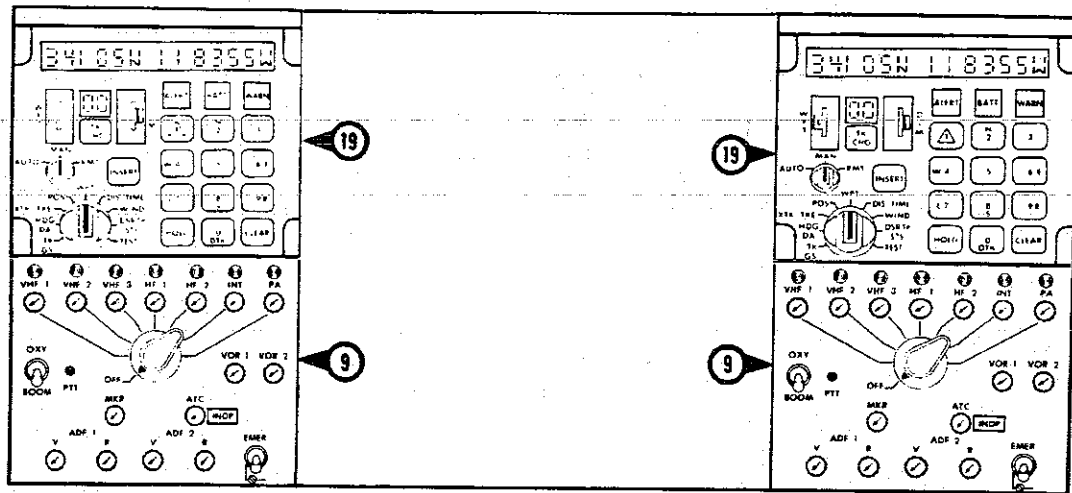

PILOTS' CONTROL STAND (UPPER HALF)

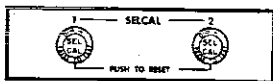
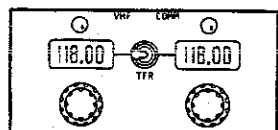
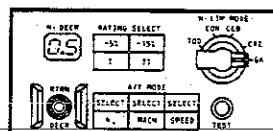
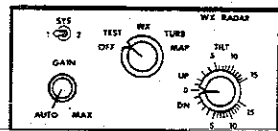
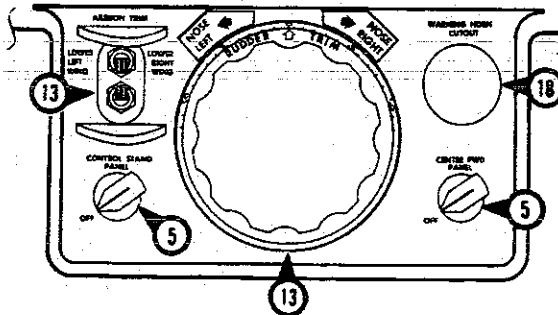
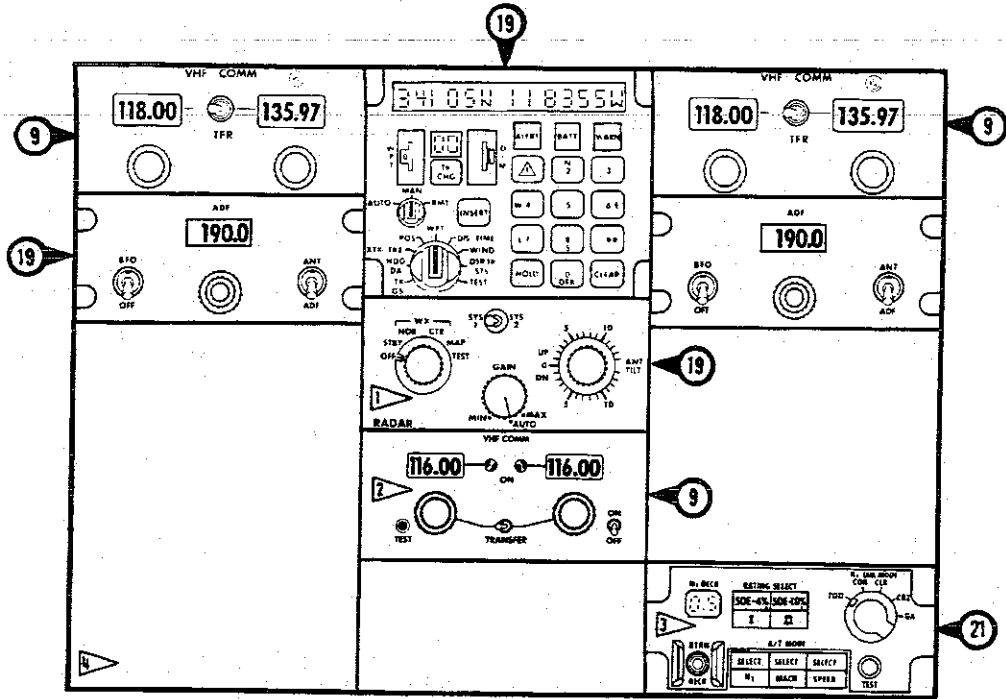

1 thru 4 As installed

**PILOTS' CONTROL STAND (LOWER HALF)**

892825

16S  
Apr 24/89

05.20.07

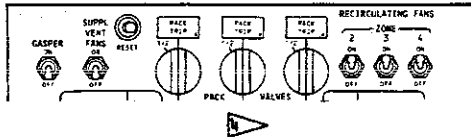
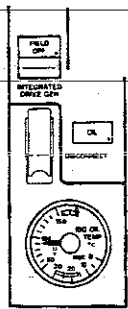
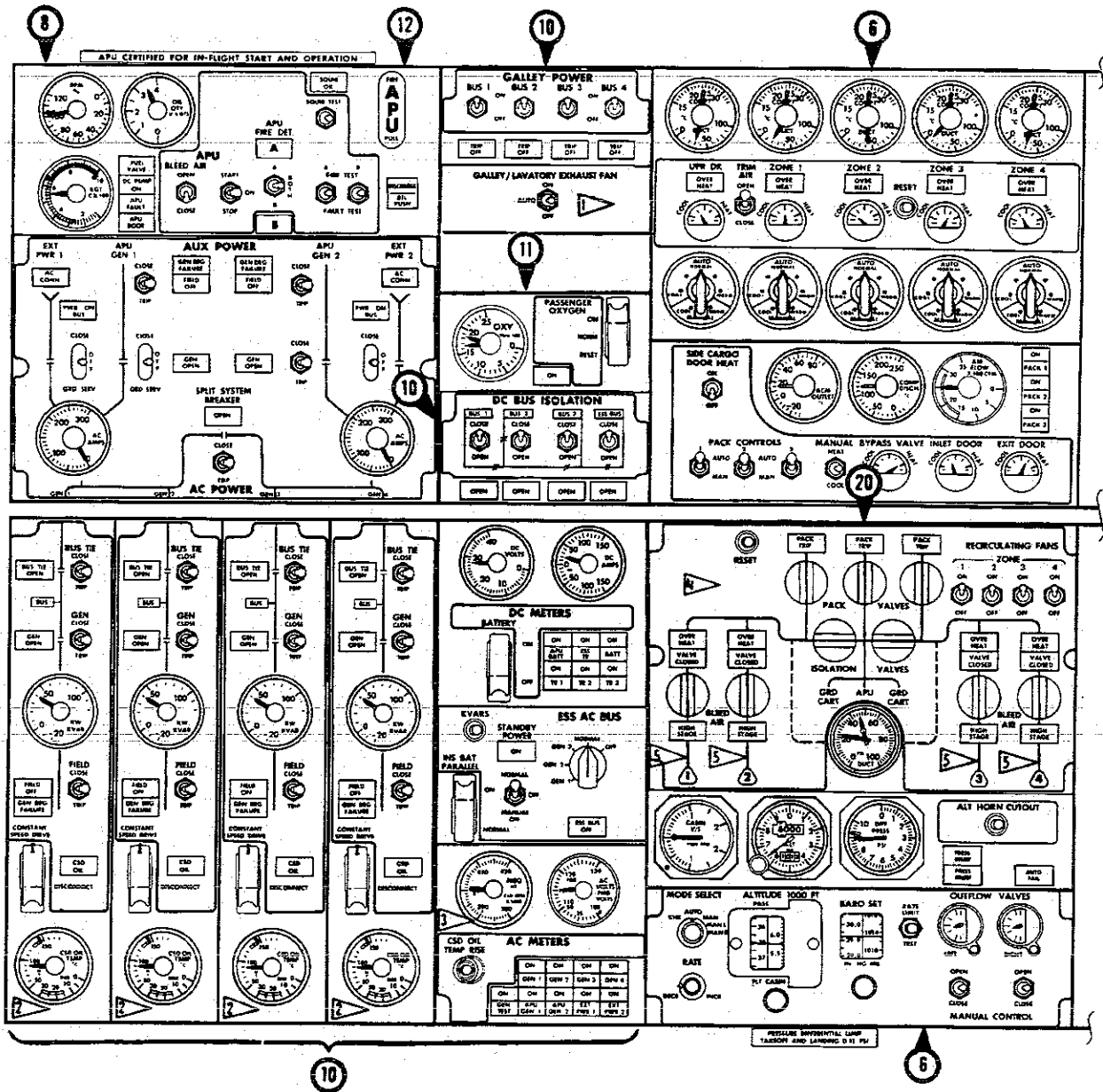

1 Thru 5 As installed

**FLIGHT ENGINEER'S INSTRUMENT PANEL - UPPER PANEL-LEFT**

B93081

05.20.08



# BOEING 747 OPERATIONS MANUAL

## AIRPLANE GENERAL COCKPIT PANELS

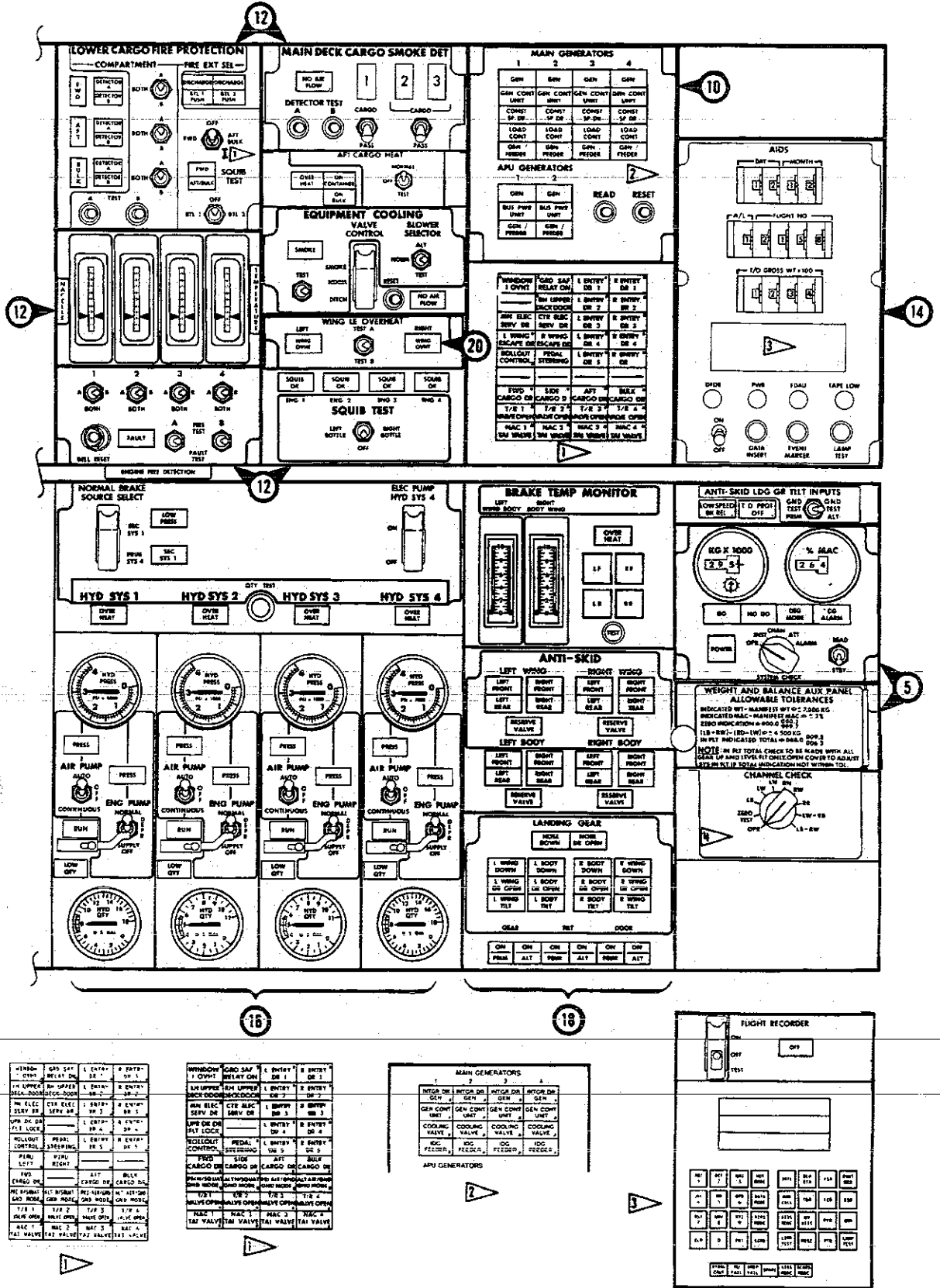

▶ thru ▶ As installed

### 16P Apr 01/88 FLIGHT ENGINEER'S INSTRUMENT PANEL - UPPER PANELS-RIGHT

05.20.09

B03625

21

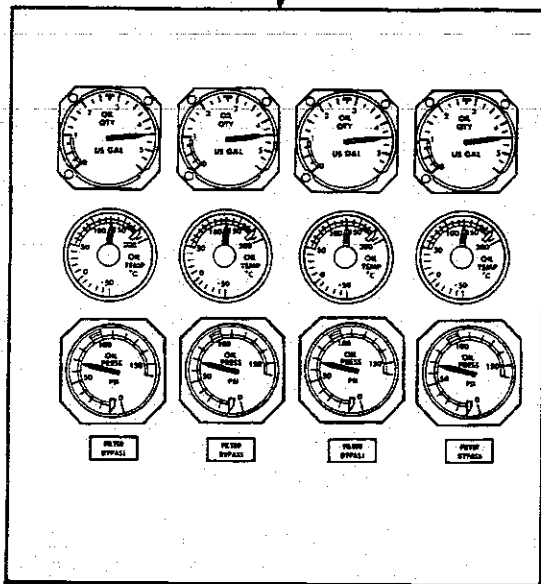

15

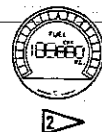
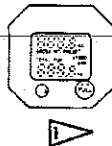
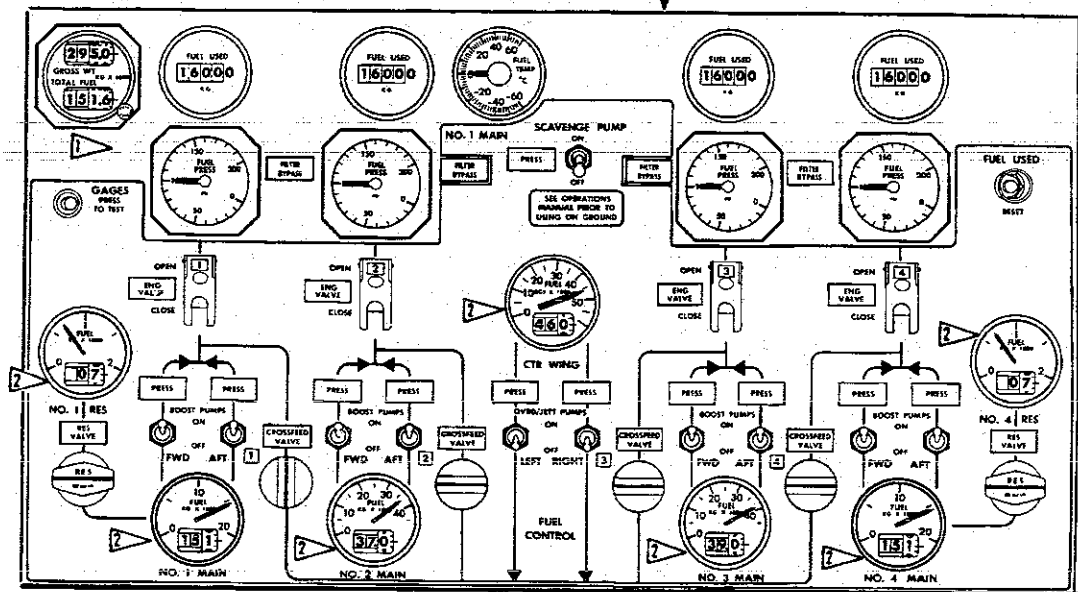

1 and 2 As installed

FLIGHT ENGINEER'S LOWER INSTRUMENT PANELS

B95883

05.20.10

16P  
Apr 01/88

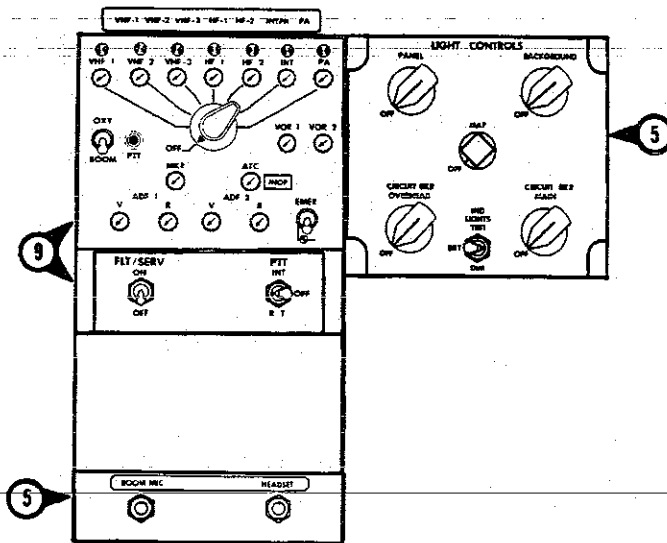
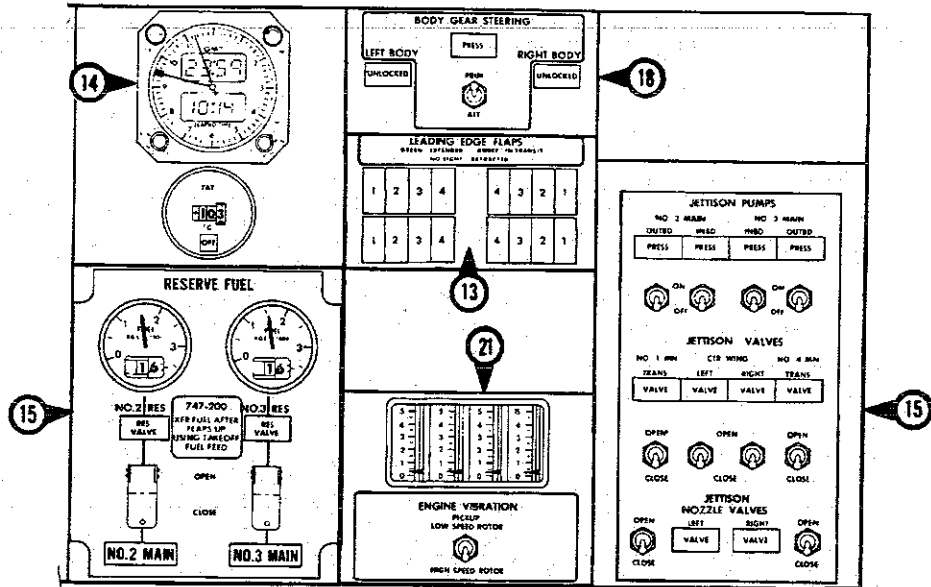

**FLIGHT ENGINEER'S LOWER INSTRUMENT PANELS (CONT)**

B94267

16  
Sep 30/81

05.20.11

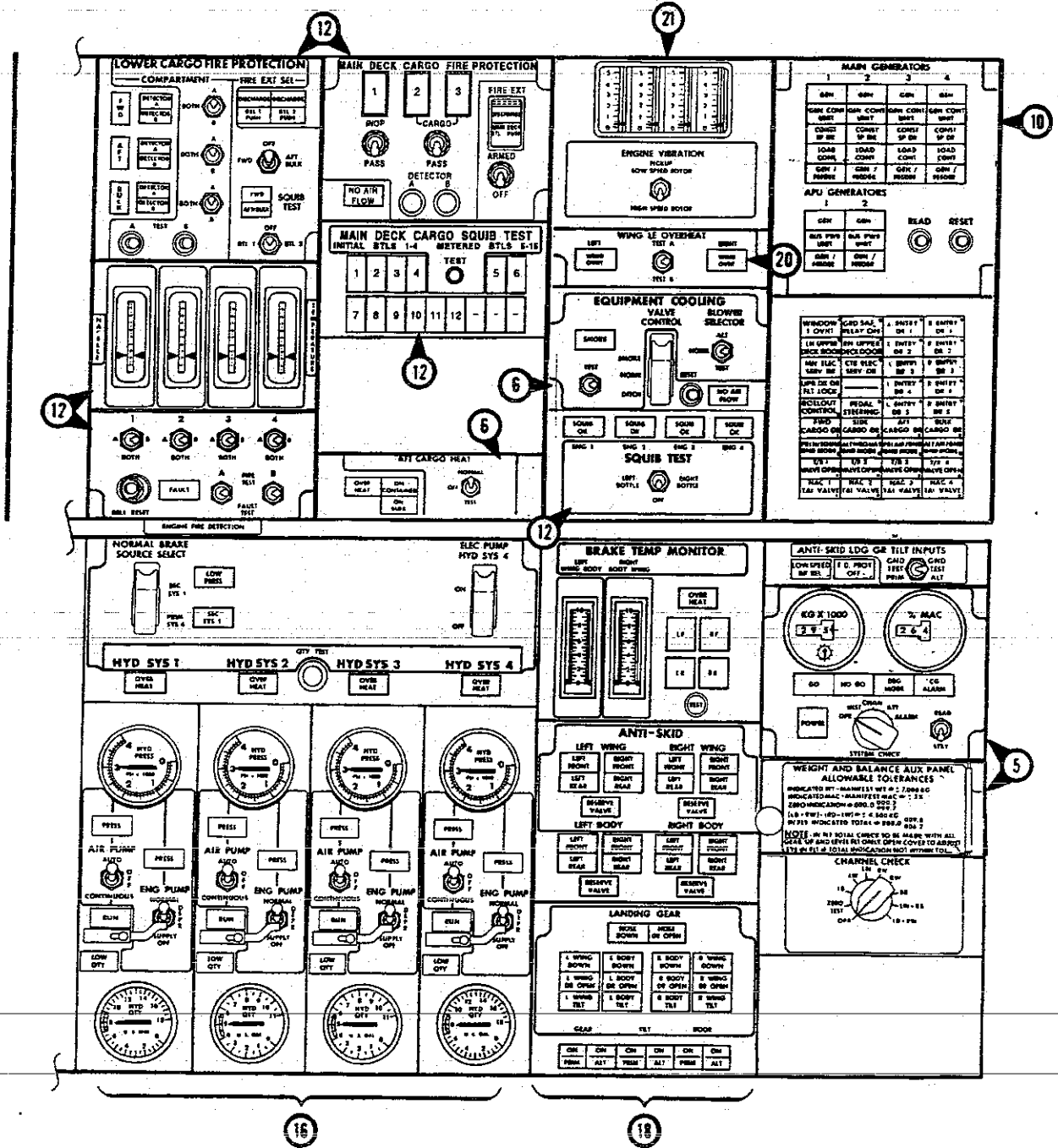

FLIGHT ENGINEER'S INSTRUMENT PANEL - UPPER PANELS RIGHT  
Airplanes PP - VNH, PP - VNI

S08494

05.20.12

16  
Jun 02/97

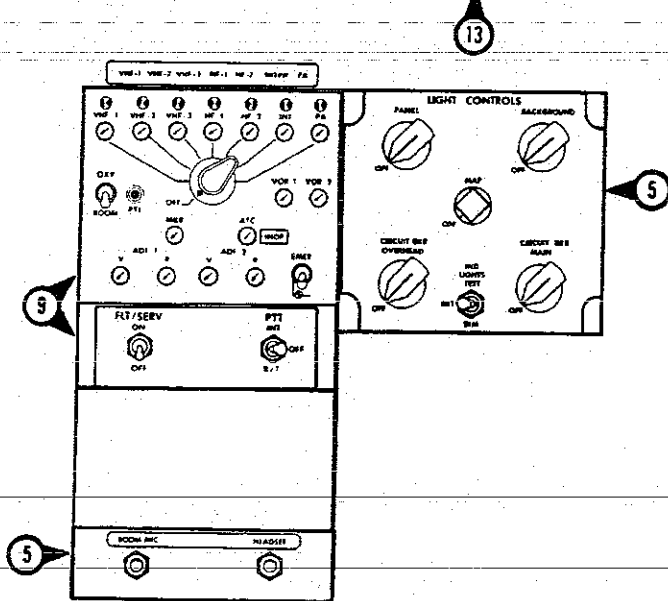
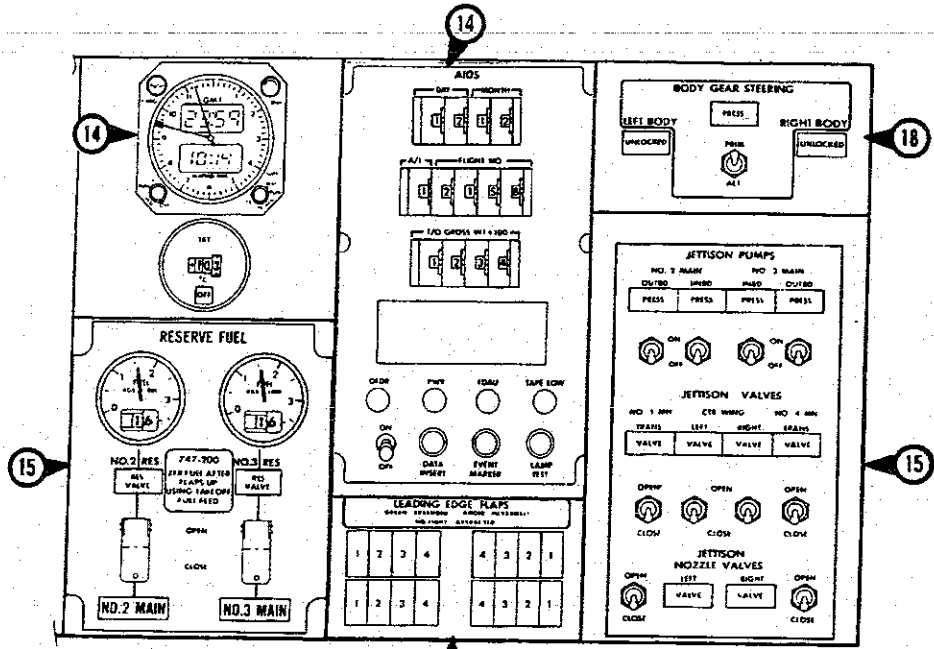

**FLIGHT ENGINEER'S LOWER INSTRUMENT PANELS (CONT)**  
Airplanes PP - VNH, PP - VNI

508495

16  
Jun 02/97

05.20.13