



EXOLANDER© (P/N 93-103)

D100 Drone Spotlight© (P/N 700-340)

**Manual Payload Delivery System©
(P/N 640-100)**

FOR AUTEL EVO II

PRODUCT MANUAL

TABLE OF CONTENTS

EXOLANDER®	
Reference Guide	3
Physical Characteristics	4
Installation	4-6
<hr/>	
D100 Drone Spotlight®	
Reference Guide	7
Physical Characteristics	8
Battery	9
Operational Modes	9
Installation	10-11
<hr/>	
Manual Payload Delivery System®	
Reference Guide	12
Physical Characteristics	13
Installation	13-14
Payload Delivery	14
<hr/>	
CARE/CLEANING	16
WARNINGS/WARRANTY	16-17
CONTACT FOXFURY	17

EXOLANDER® REFERENCE GUIDE

FULL ASSEMBLY

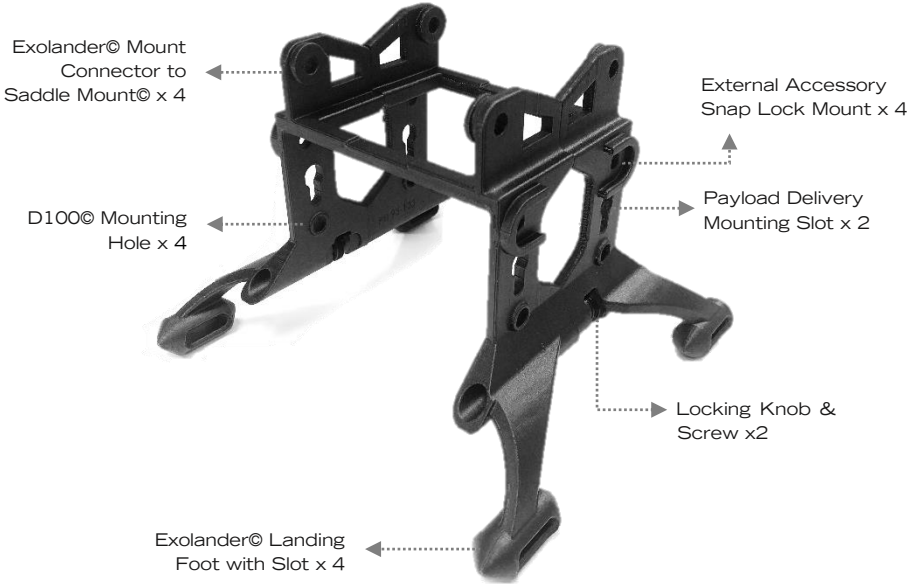

Exolander® Half

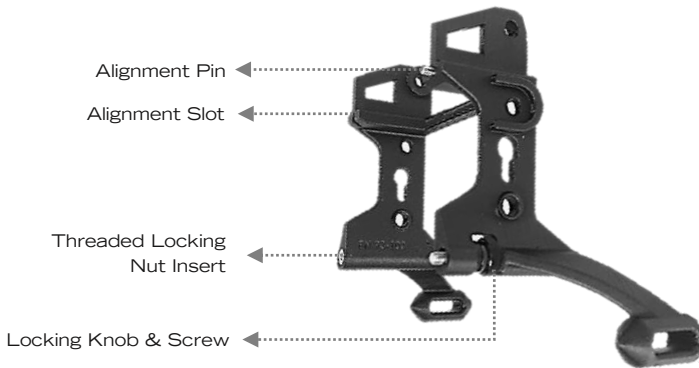



WHAT'S INCLUDED

PHYSICAL CHARACTERISTICS

DIMENSIONS	6.7 x 6.5 x 4.7 in (170.0 x 165.0 x 120.0 mm)
WEIGHT	1.1 oz (31.0 g)

WARNINGS

 Manually test the Exolander® mount by wiggling it and making sure nothing is loose. Note that a small amount of movement between the structure and the UAS has been created, at the request of AUTEL, to eliminate adding unnecessary forces to the vehicle's structure.

 It is the responsibility of drone / UAV users to follow the FAA laws and regulations and/or the laws and regulations applicable to the flight location.

INSTALLATION

ITEM REQUIRED:

 Saddle Mount® for EVO II

① Install Saddle Mount® on EVO II.

1. Slide the Saddle Mount® on EVO II and make sure that the two extensions fit behind the front arms of the EVO II and press down.

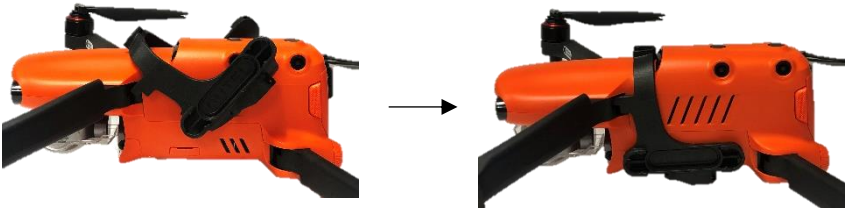

2 Install Exolander© on Saddle Mount©.

1. Place EVO II with Saddle Mount© upside down on a flat surface.
2. Align the Exolander© half with Saddle Snap Lock locations and slide in the Exolander© in angle as shown below. Make sure the foot is facing away from the center of the drone. Tilt the Exolander© as shown.



3. Install the second Exolander© in the open Saddle Snap Lock location. Bring the units together, align the Pin into the Hole on each side.



4. Align Locking Knob & Screw and Thread Locking Nut Insert on each side.

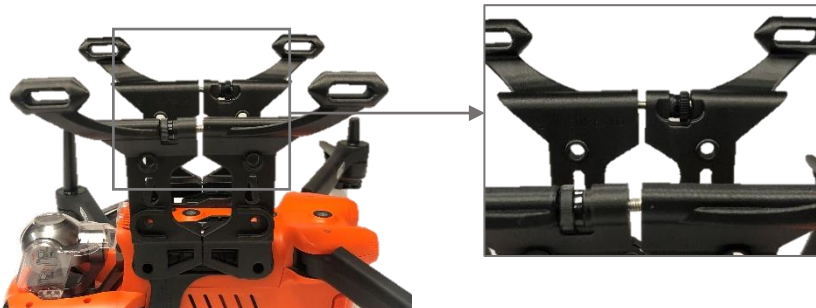

5. Tighten each screw until the units are mated.



6. Installation is done.



D100© REFERENCE GUIDE

D100 Drone Spotlight©



Back View







WHAT'S INCLUDED

- ▣ D100 Drone Spotlight©
- ▣ Mounting Knob (2 ea)
- ▣ 18650 Lithium-Ion Battery (2 ea.)
- ▣ XTAR Battery Charger

PHYSICAL CHARACTERISTICS

DIMENSIONS	3.46 x 1.97 x 2.46 in (88.0 x 50.0 x 62.5 mm)
WEIGHT	8.92 oz (253.0 g) 12.23 oz (346.6 g) with provided batteries

WARNINGS

-  Please fully charge the provided 18650 batteries before using D100© for the first time.
-  Do not stare into the LEDs for long periods of time or from close range (less than 2ft/ 0.6m)
-  While using any FoxFury product, please operate at safe speeds.
-  It is the responsibility of drone / UAV users to follow the FAA laws and regulations and/or the laws and regulations applicable to the flight location.
-  The D100© will become hot to touch after 20 min of continuous use. Please handle carefully, by avoiding contact with the heatsink.

BATTERY

- ❖ D100C requires two (2) 18650 batteries.
- ❖ Mixing of new and used, or different brand batteries is not recommended as this could lead to leakage or explosion.

BATTERY INSTALLATION AND REPLACEMENT

- 1 Slide the battery cover open and Insert the battery according to the plus (+) and minus (-) symbol located inside of the battery compartment.
- 2 Once Batteries are installed, test the light's performance by activating the Power/ Mode Switch. Slide the battery cover back on.

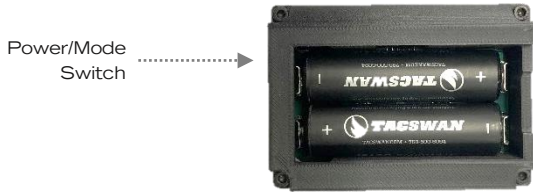

CHARGING BATTERY

Refer to the instruction manual provided with XTAR Battery Charger

OPERATIONAL MODES

OPERATIONAL MODES

- ❖ Press and hold Power/Mode Button to turn light ON.
- ❖ Press Power/Mode Button again to turn light to STROBE.
- ❖ Press Power/Mode Button again to turn light to OFF.

MODE	LUMENS	BATTERY LIFE
ON	2,300	70 minutes
STROBE	2,300	140 minutes

INSTALLATION

ITEMS REQUIRED:

- ◆ Saddle Mount© for EVO II
- ◆ Exolander©

1. Install Saddle Mount© on EVO II. Refer to page 5.
2. Install Exolander© on Saddle Mount©. Refer to page 5.
3. Install D100© on Exolander©
 1. Put each Mounting Knob in the D100© Mounting Hole on the bottom section of front Exolander©.



2. Align the screws with the ¼-2- threaded screw holes on D100© and install D100© on Exolander©.



3. Tilt D100© to access the Switch and turn it on to desired mode.

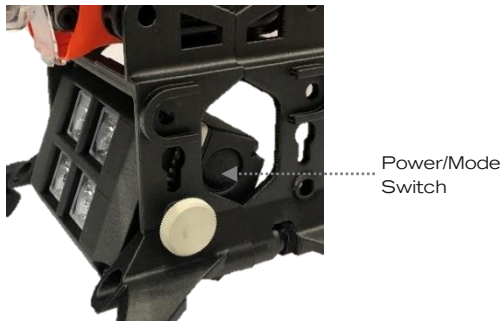







4. Adjust angle of D100© and tighten knobs.



MANUAL PAYLOAD DELIVERY SYSTEM[®] REFERENCE GUIDE







WHAT'S INCLUDED

-  Payload Delivery Unit with Cross Bar
-  Handle/ Cord Reel with 550 Paracord (20ft)
-  1/4 x 1 1/2 QR Pin with Ring
-  Ring (38mm diameter)
-  Carabiner with Ring,
-  Payload Delivery Bag

PHYSICAL CHARACTERISTICS



WEIGHT	7.58 oz (21 g) - fully assembled
---------------	----------------------------------

WARNINGS

-  While using any FoxFury product, please operate at safe speeds.
-  It is the responsibility of drone/UAV users to follow the FAA laws and regulations and/or the laws and regulations applicable to the flight location.
-  If Delivering with D100© installed, maximum Payload is 400 grams.
-  If Delivering without the D100© installed, maximum Payload is 800 grams.

INSTALLATION

ITEMS REQUIRED:

-  Saddle Mount© for EVO II
-  Exolander©

- ① Install Saddle Mount© on EVO II. Refer to page 5.
- ② Install Exolander© on Saddle Mount©. Refer to page 5.
- ③ Install Key Ring (38 mm Diameter) and 1/4 x 1½ QR Pin with Ring on the Payload Delivery Unit with Cross Bar if not already installed.

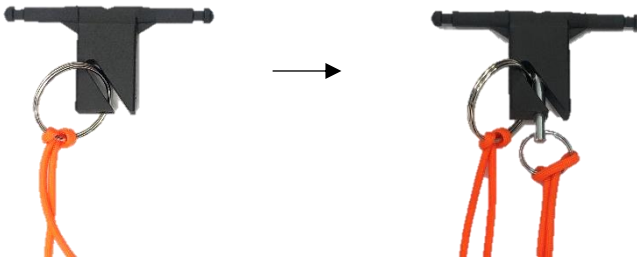

- 4 Install Payload Delivery Unit with Cross Bar on the rear of Exolander©.
1. Locate Payload Delivery Mounting Slots on the rear of Exolander©

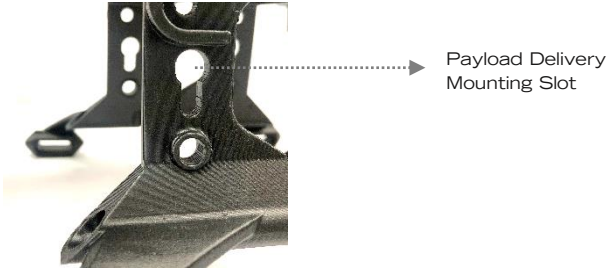

2. Align the Cross Bar on the top hole of the Payload Delivery Mounting Slot and slide it down to lock in place.

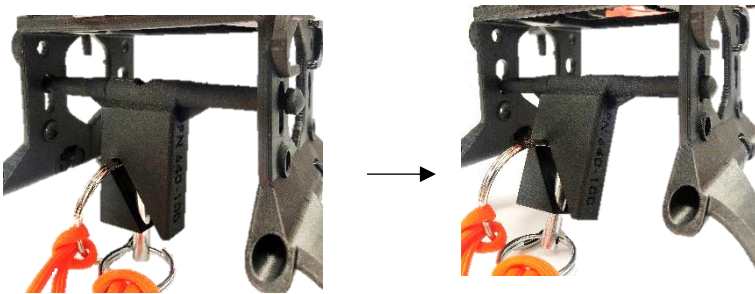

PAYLOAD DELIVERY

- ❏ Insert the payload inside the Payload Delivery Bag
- ❏ Place the bag with payload behind EVO II, about 24" away.
- ❏ Unwind the Paracord and fly EVO II.
- ❏ To release payload, simply pull on the Handle with a force of 2-3 lbs.

WARRANTY AND OTHER INFORMATION

PRODUCT DURABILITY









CARE/CLEANING

Your FoxFury product is a professional tool. Regular maintenance and care of your light will maximize performance for you. As needed, clean your FoxFury product using a soft washcloth. Do not immerse.

WARNINGS

FoxFury, LLC is not responsible for the incorrect use of any FoxFury Lighting product.

-  When used for extended periods of time the D10 will become HOT to the touch. Please use care when operating.
-  Lights are strong enough to cause damage to the human eye.
-  Do not stare into LEDs for long periods of time or from a close range (less than 2 ft /0.6 m).
-  FoxFury, LLC is not responsible for any injury or damage caused during the use of this product.
-  Usage of this product must be supervised by an adult when it is being used by a minor.
-  Any FoxFury product should be operated at speeds safe enough to maneuver around surrounding obstacles.

-  Do not use under the influence of drugs or alcohol.

ONE YEAR WARRANTY

FoxFury, LLC ("FoxFury") warrants this product to be free from defects in material for one year after purchase. LiPo batteries have a one year pro-rated or 300 re-charge cycle pro-rated warranty, whichever the user reaches first.

This warranty is given only to the original end user of the accompanying product. If you purchased a product from someone other than an authorized FoxFury reseller/distributor or if the product was used, (including but not limited to demo models, show models or refurbished product by someone other than FoxFury) prior to your purchase, you are not the Original Purchaser and the product that you purchased is not covered by this warranty. This warranty is VOID if this Product has been altered or modified in any way (including but not limited to attempted warranty repair without authorization from Foxfury and/or alteration/removal of the serial number). To expedite warranty concerns, we encourage the end user to register their FoxFury Product at www.foxfury.com/pages/warrantyregistration.

THIS IS THE ONLY WARRANTY, EXPRESSED OR IMPLIED, INCLUDING ANY WARRANTY OF MERCHANTABILITY OR FITNESS FOR A PARTICULAR PURPOSE.

INCIDENTAL, CONSEQUENTIAL
OR SPECIAL DAMAGES ARE
EXPRESSLY DISCLAIMED EXCEPT
WHERE SUCH LIMITATION IS
PROHIBITED BY LAW.

You may have other specific legal
rights which vary by jurisdiction. Go
to www.foxfury.com/pages/warranty
for a complete copy of the warranty.
Retain your receipt for proof of
purchase.

CONTACT FOXFURY

FoxFury, LLC
Oceanside, CA 92056 USA
Toll-Free: 844-FOXFURY
Tel: 760.945.4231
Fax: 760.433.3650
Email: service@FoxFury.com
Web: FoxFury.com

All FoxFury products are designed in
Oceanside, CA. All FoxFury
products are manufactured with the
highest quality USA and foreign
parts. Products are assembled in
either FoxFury's controlled plant in
Asia or the USA, under strict quality
control.

CALIFORNIA PROPOSITION 65

This product can expose you to
chemicals including Lead and DEHP,
which are known to the State of
California to cause cancer and birth
defects or other reproductive harm.
For more information go to [www.
P65Warnings.ca.gov](http://www.P65Warnings.ca.gov).

