

BOEING 747

MODEL 747-2B3F/2S4F/2B3B/3B3

**OPERATIONS MANUAL
VOLUME 1**

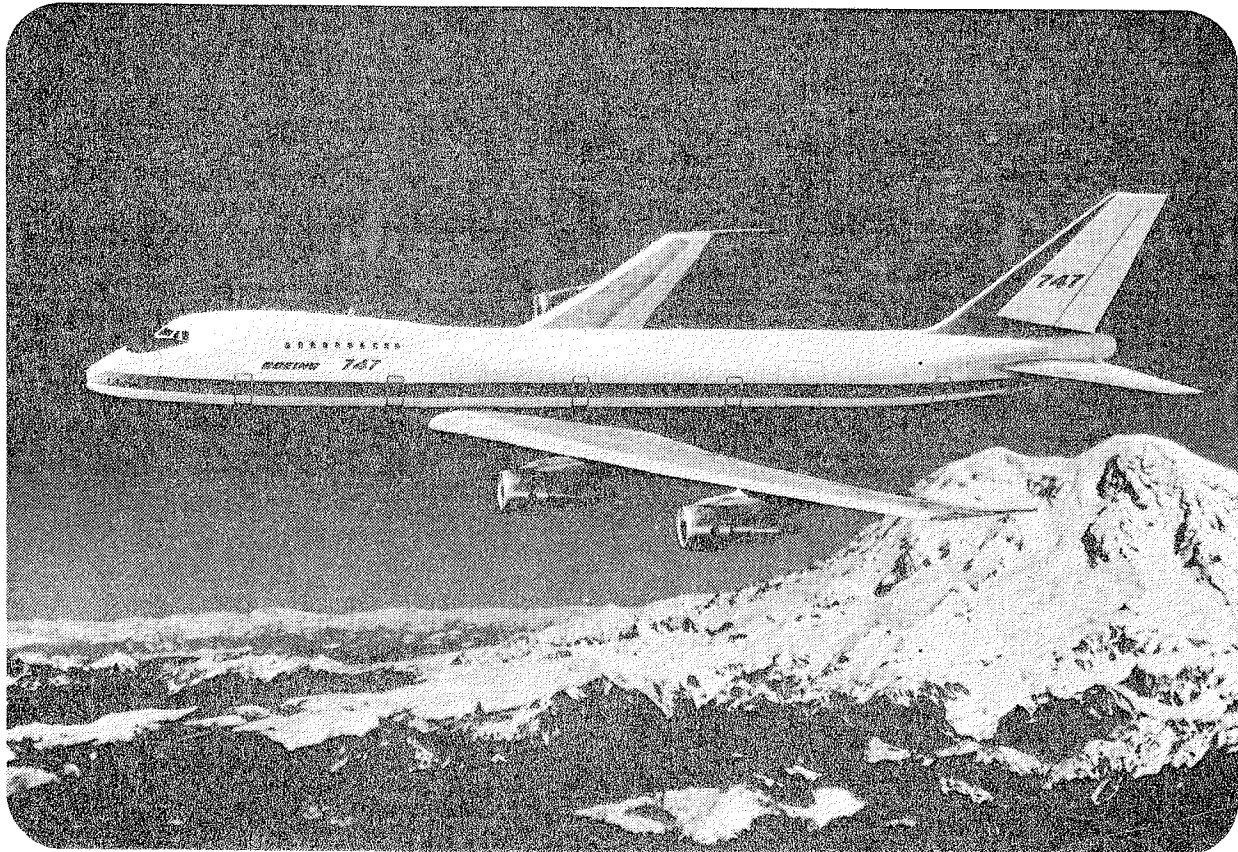



**UNION DE TRANSPORTS AERIENS, SA
AIR AFRIQUE**

PUBLISHED BY THE BOEING COMMERCIAL AIRPLANE COMPANY, SEATTLE, WASHINGTON U.S.A.

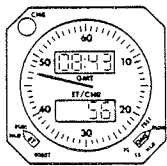
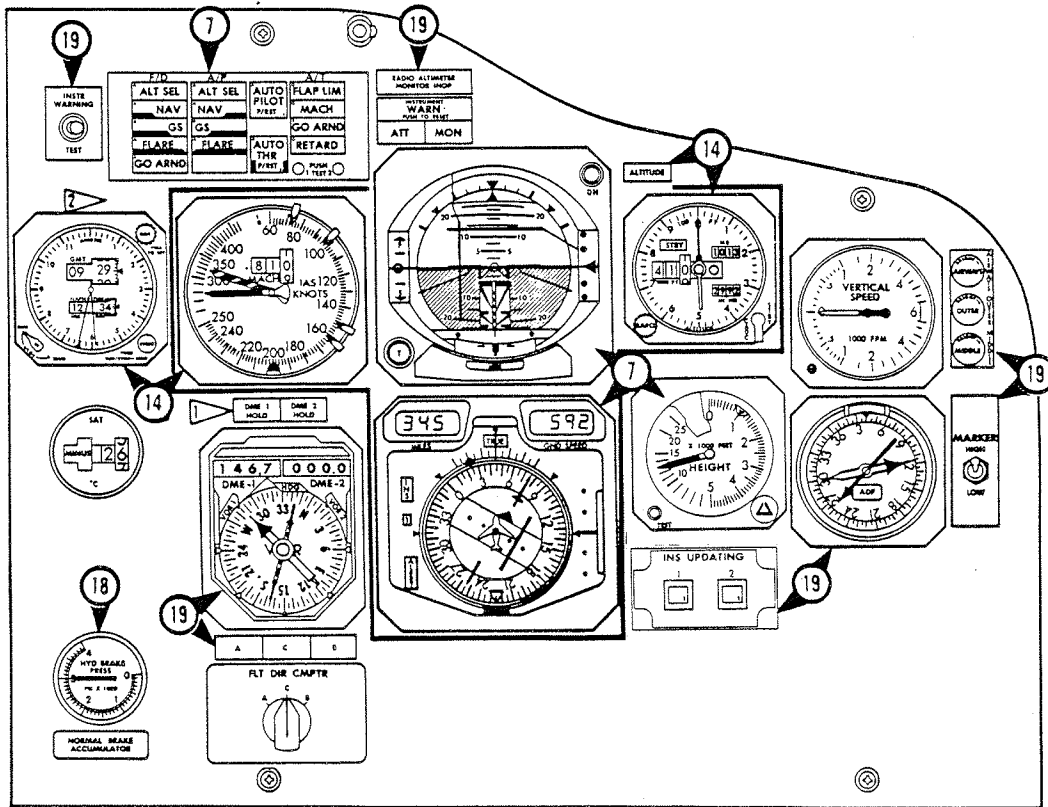

BOEING DOCUMENT NO. D6-30151-283F MAY 20, 1978

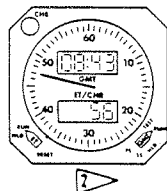
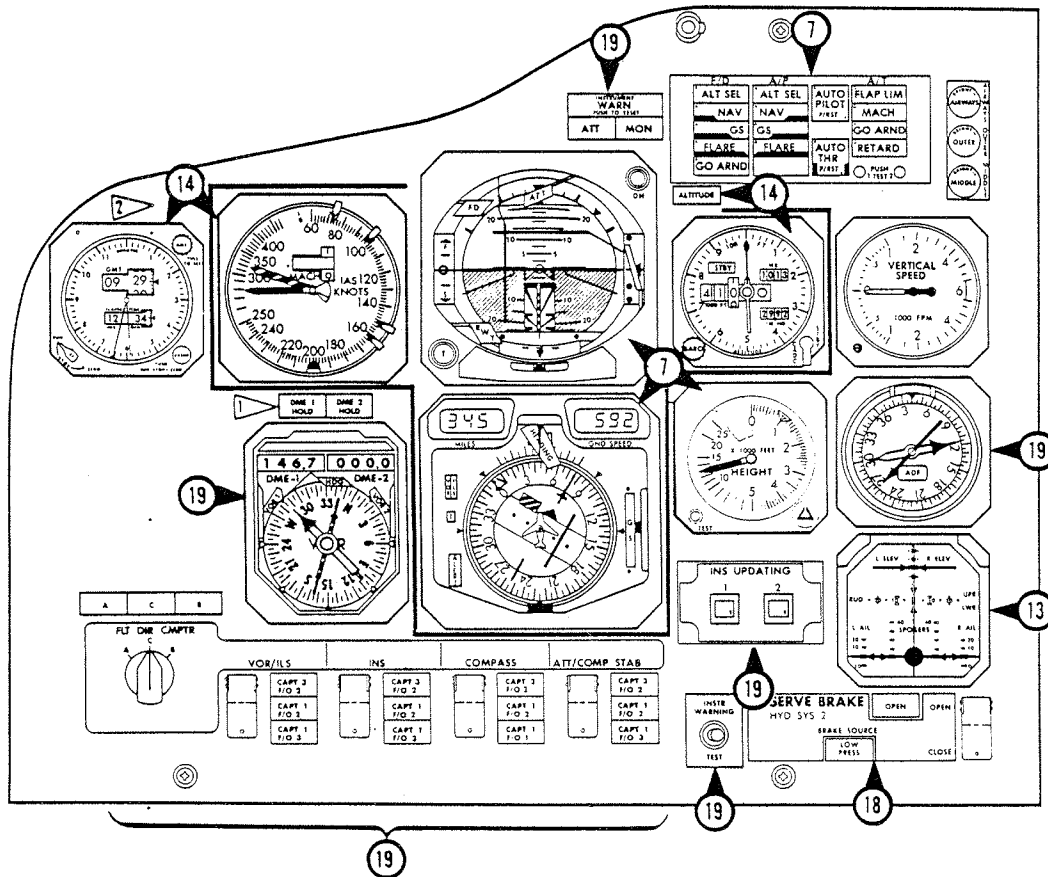

 and  As installed

FIRST OFFICER'S INSTRUMENT PANEL



 and  As installed

CAPTAIN'S INSTRUMENT PANEL

PILOTS' CENTER INSTRUMENT PANEL & LIGHTSHIELD

1 thru 6 As installed

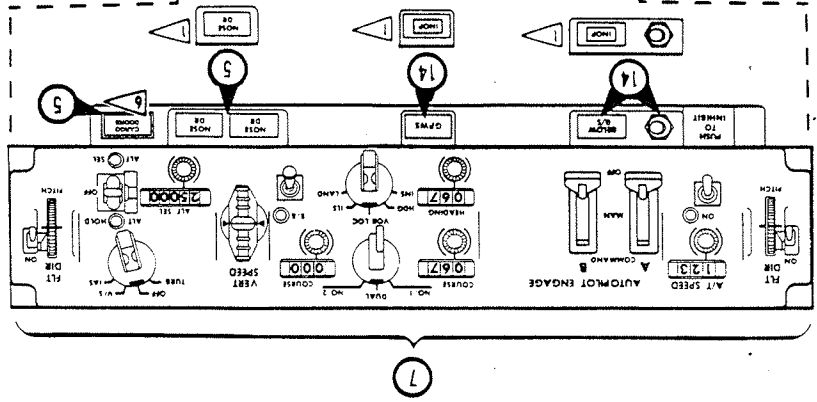
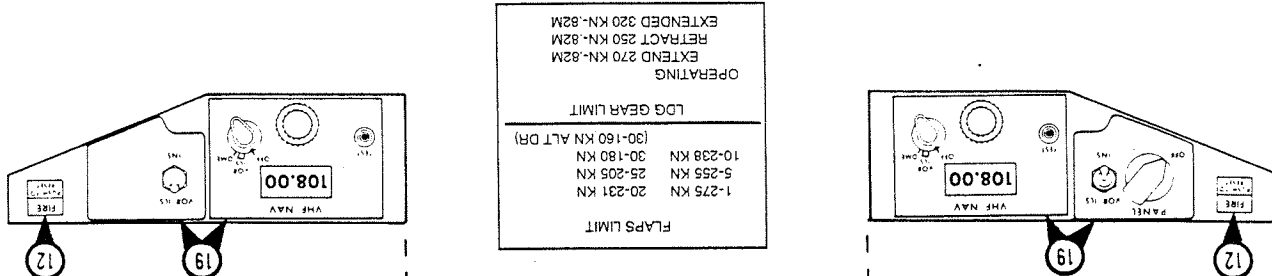
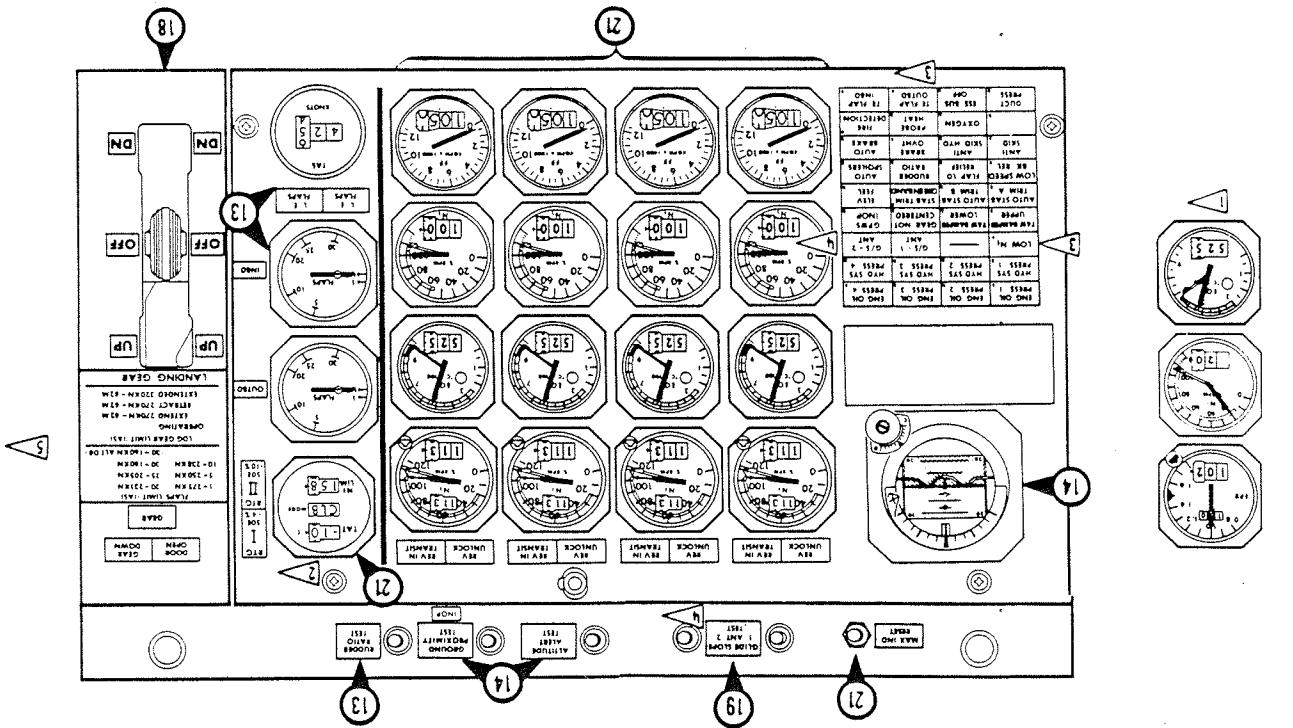

PILOTS' OVERHEAD PANEL

1 thru 7 As Installed

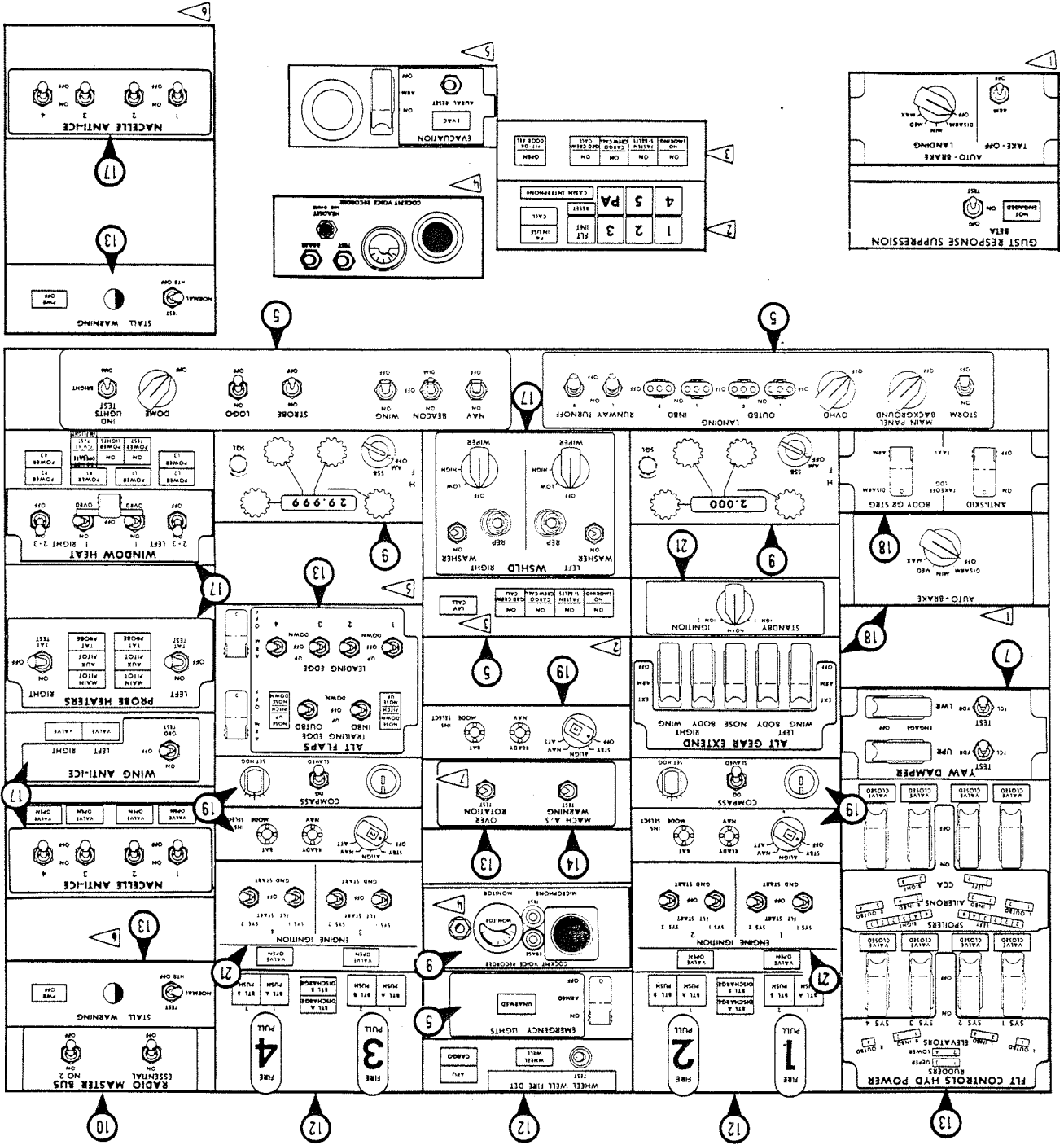

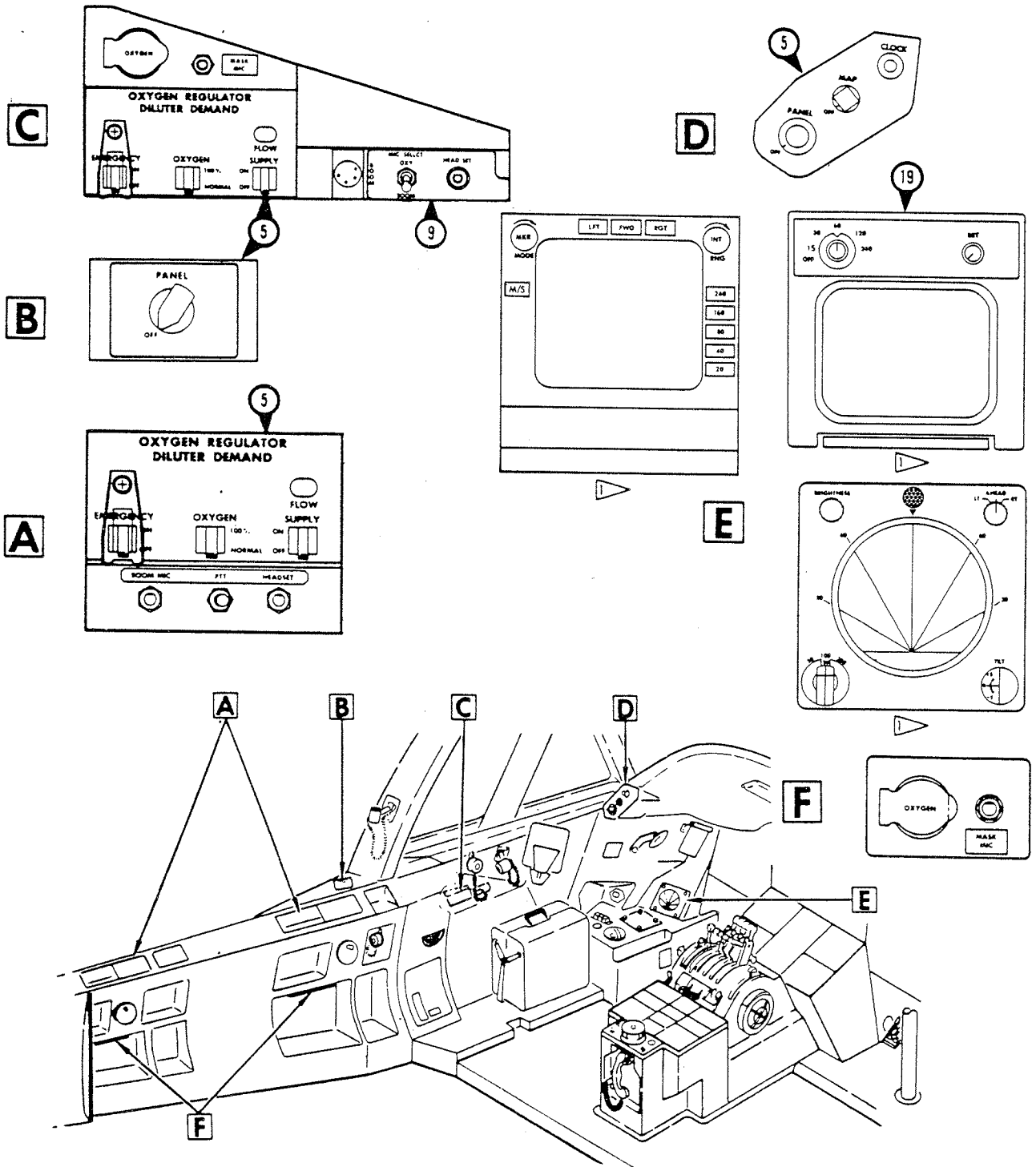

CAPTAIN'S & FIRST OFFICER'S AUXILIARY PANELS

PILOTS' CONTROL STAND (UPPER HALF)

As installed

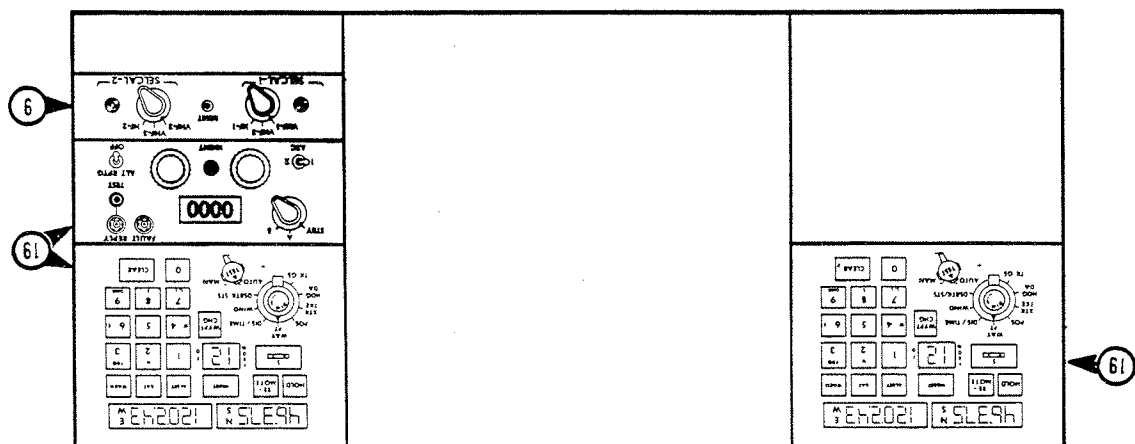
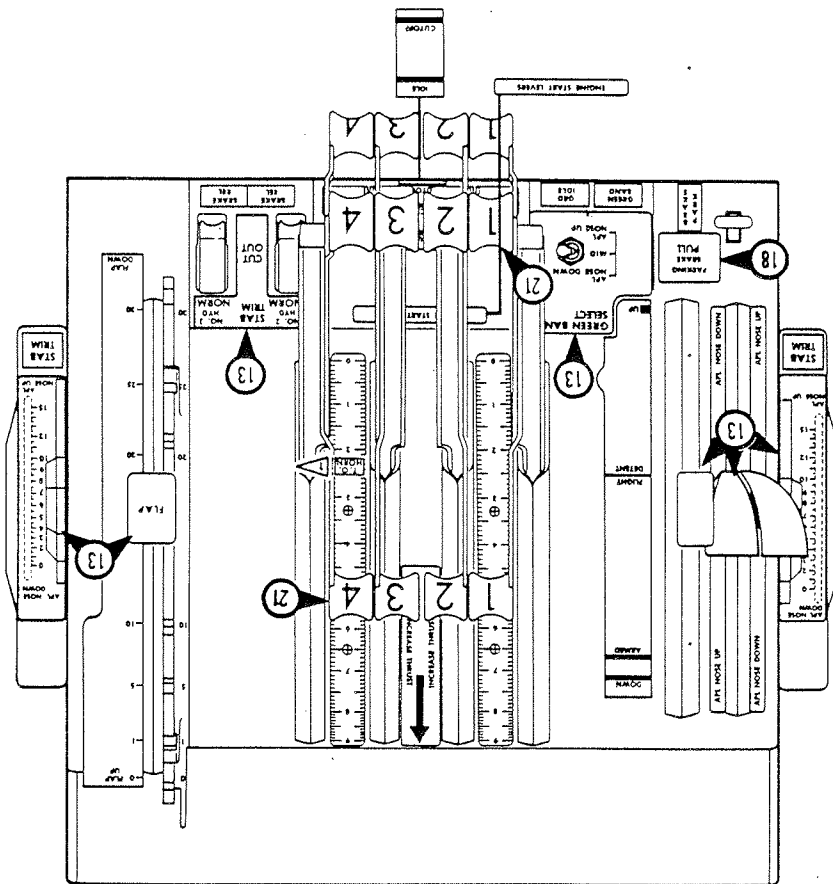

FLIGHT ENGINEER'S LOWER INSTRUMENT PANELS (-300)

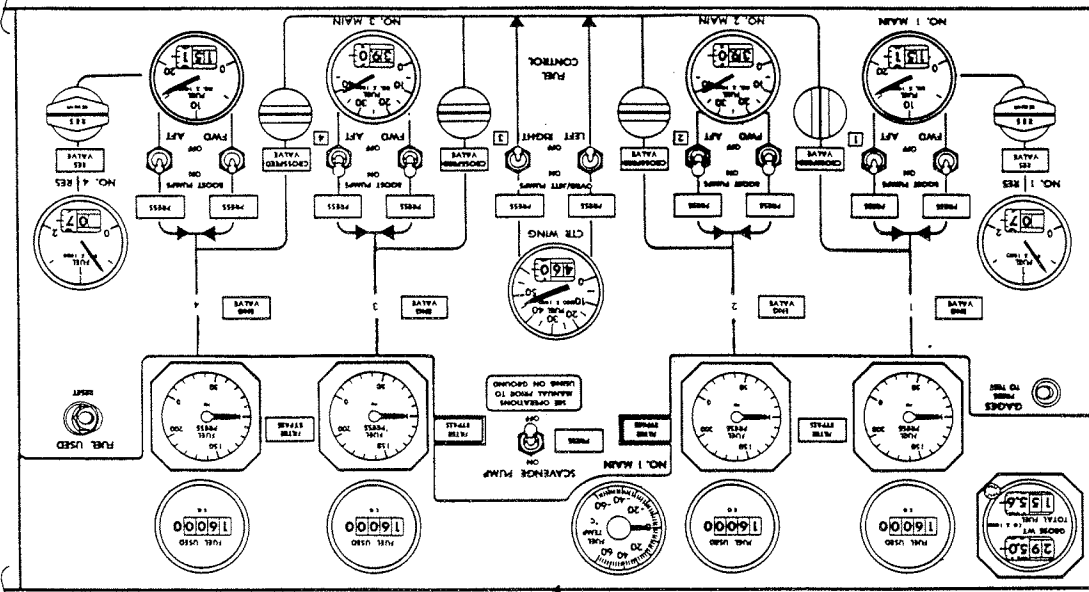

15

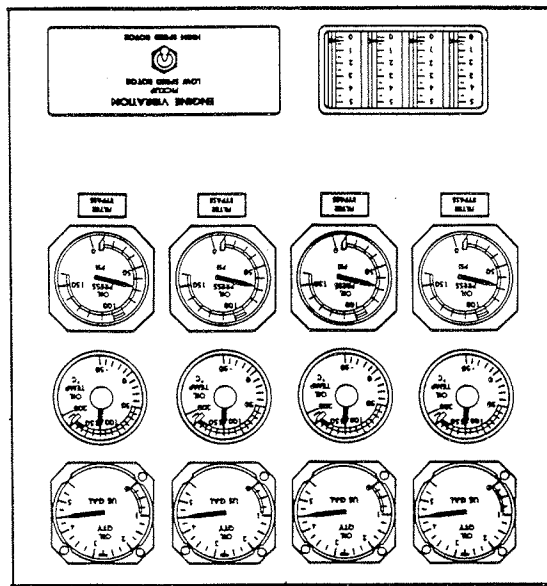

21

21

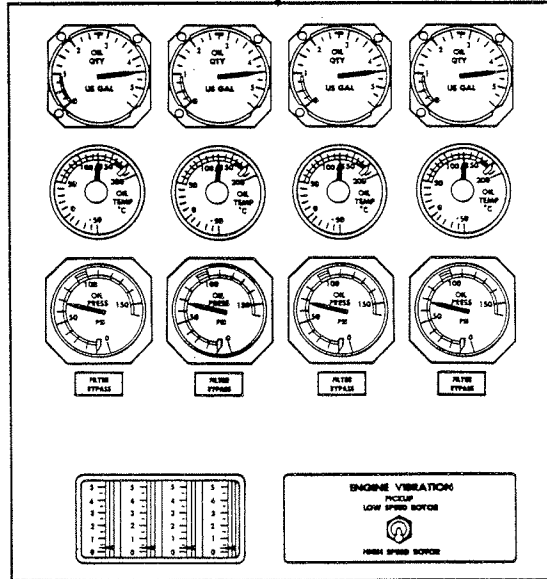

15

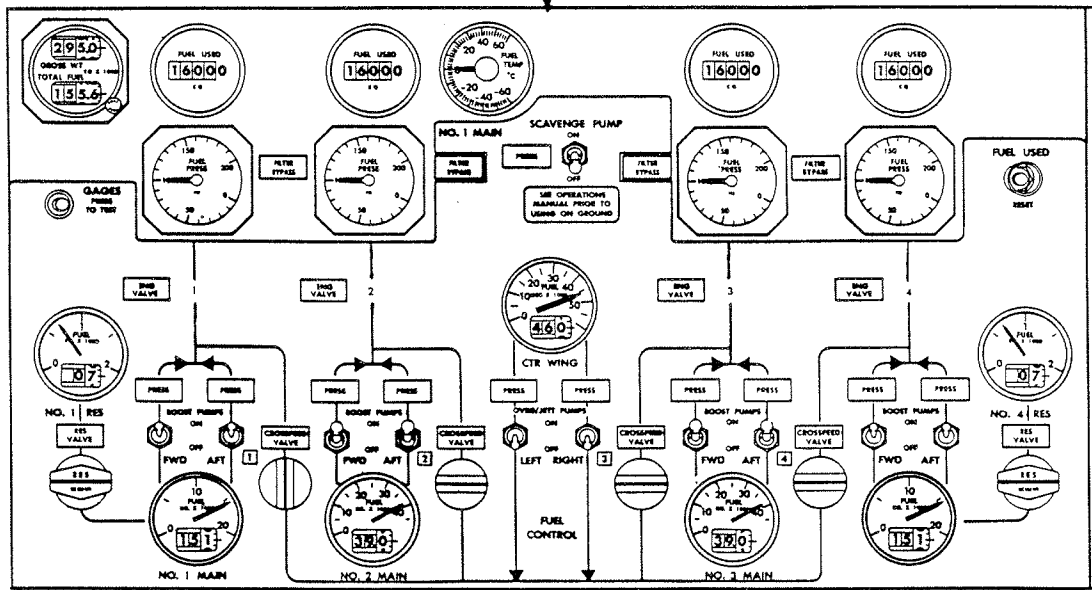

FLIGHT ENGINEER'S LOWER INSTRUMENT PANELS
(-300)

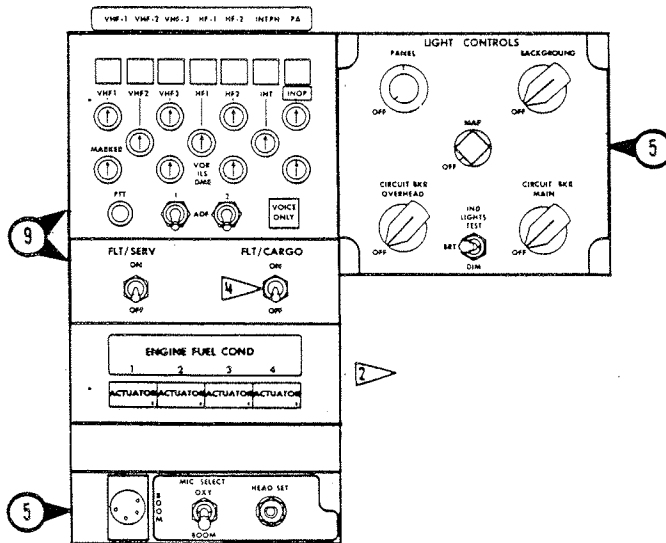
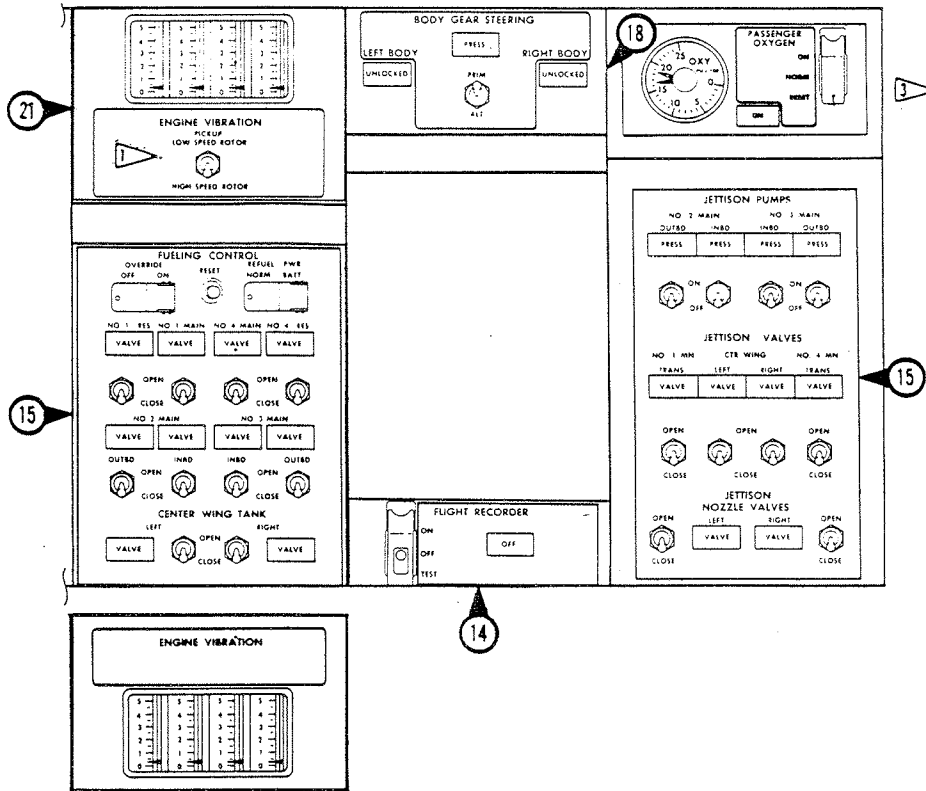

1 thru 4 As installed

FLIGHT ENGINEER'S LOWER INSTRUMENT PANELS (CONT)

FLIGHT ENGINEER'S INSTRUMENT PANEL - UPPER PANELS - LEFT (FREIGHTER)

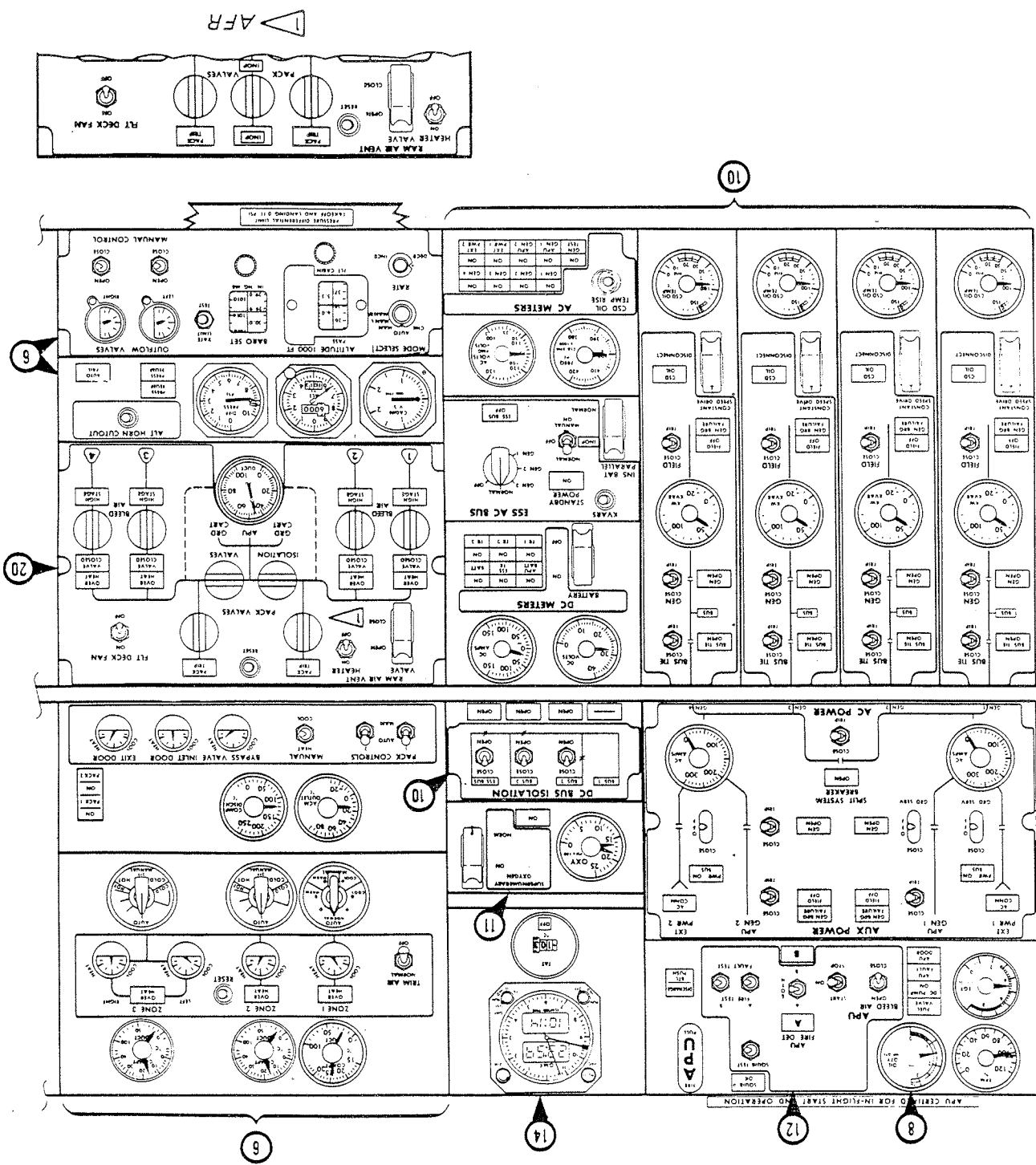

PILOTS' CONTROL STAND (LOWER HALF)

1 thru 3 As installed

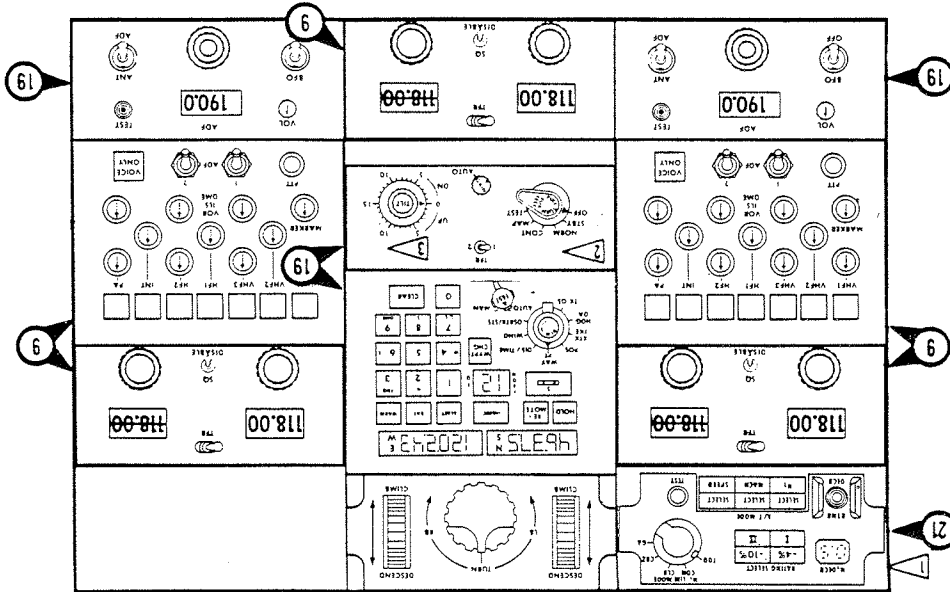
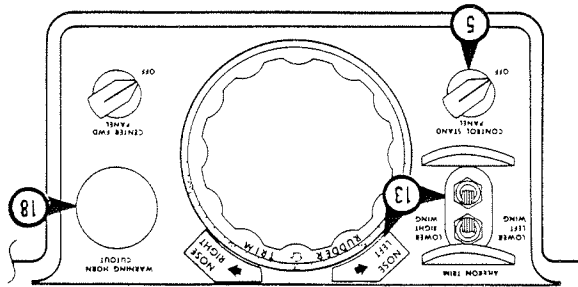
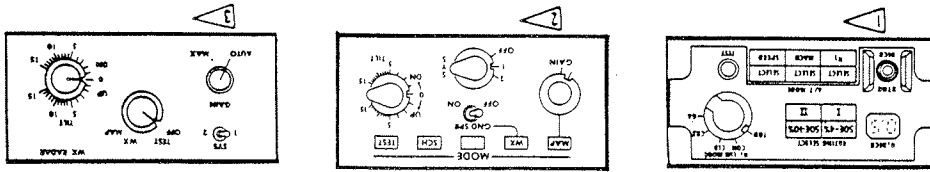

FLIGHT ENGINEER'S INSTRUMENT PANEL - UPPER PANEL - LEFT
(COMBI & -300)

1 thru 3 As installed

APU CERTIFIED FOR IN-FLIGHT OPERATION
IMPOUND OPERATION AFTER DEPARTURE IS NOT ALLOWED

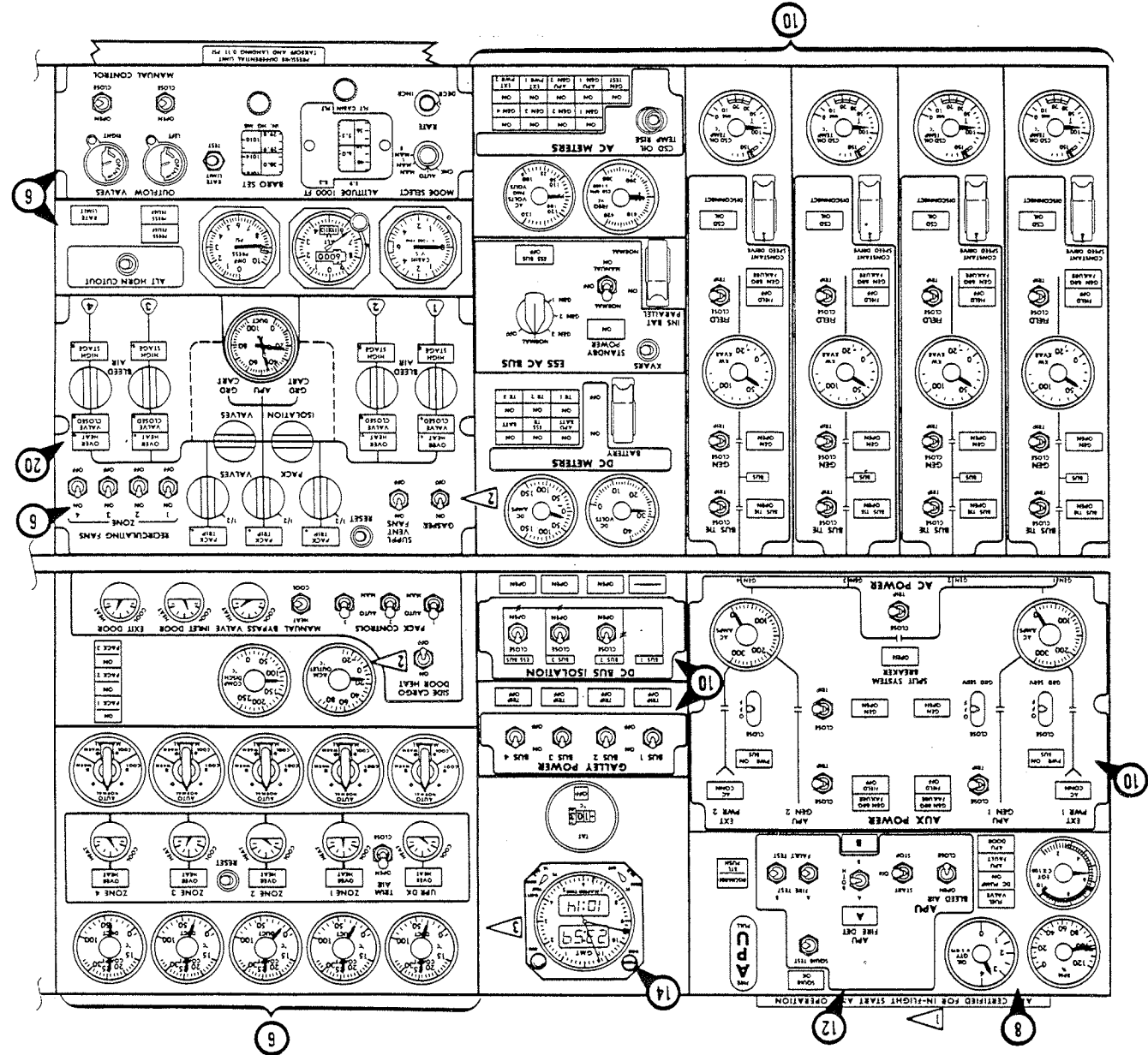
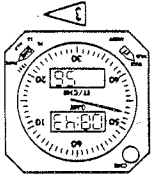

FLIGHT ENGINEER'S INSTRUMENT PANEL - UPPER PANEL - RIGHT (COMBI & -300)

As installed thru 4

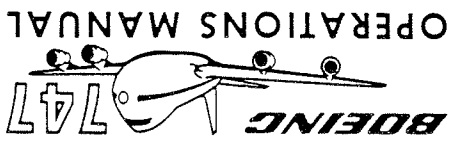
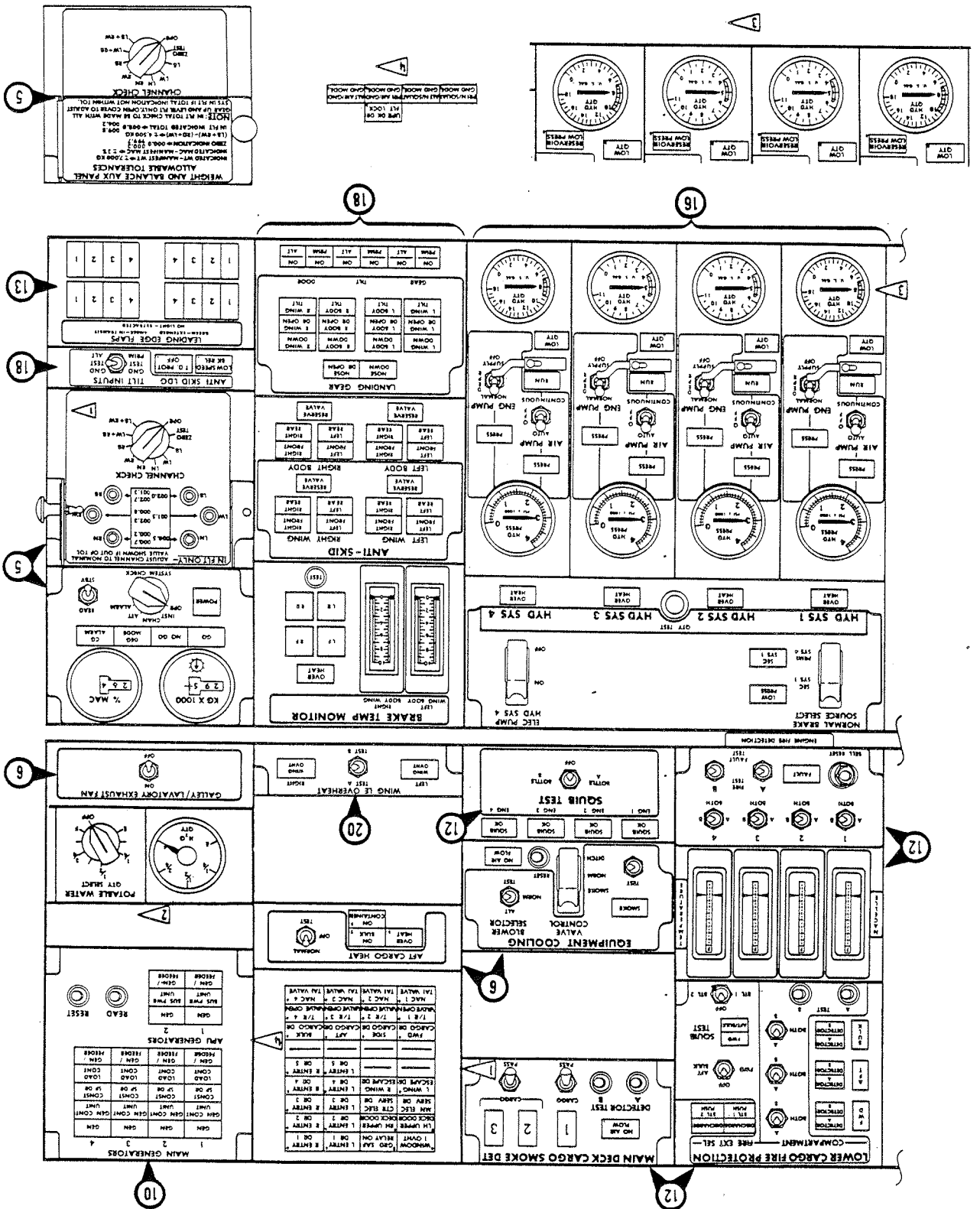

OPERATIONS MANUAL

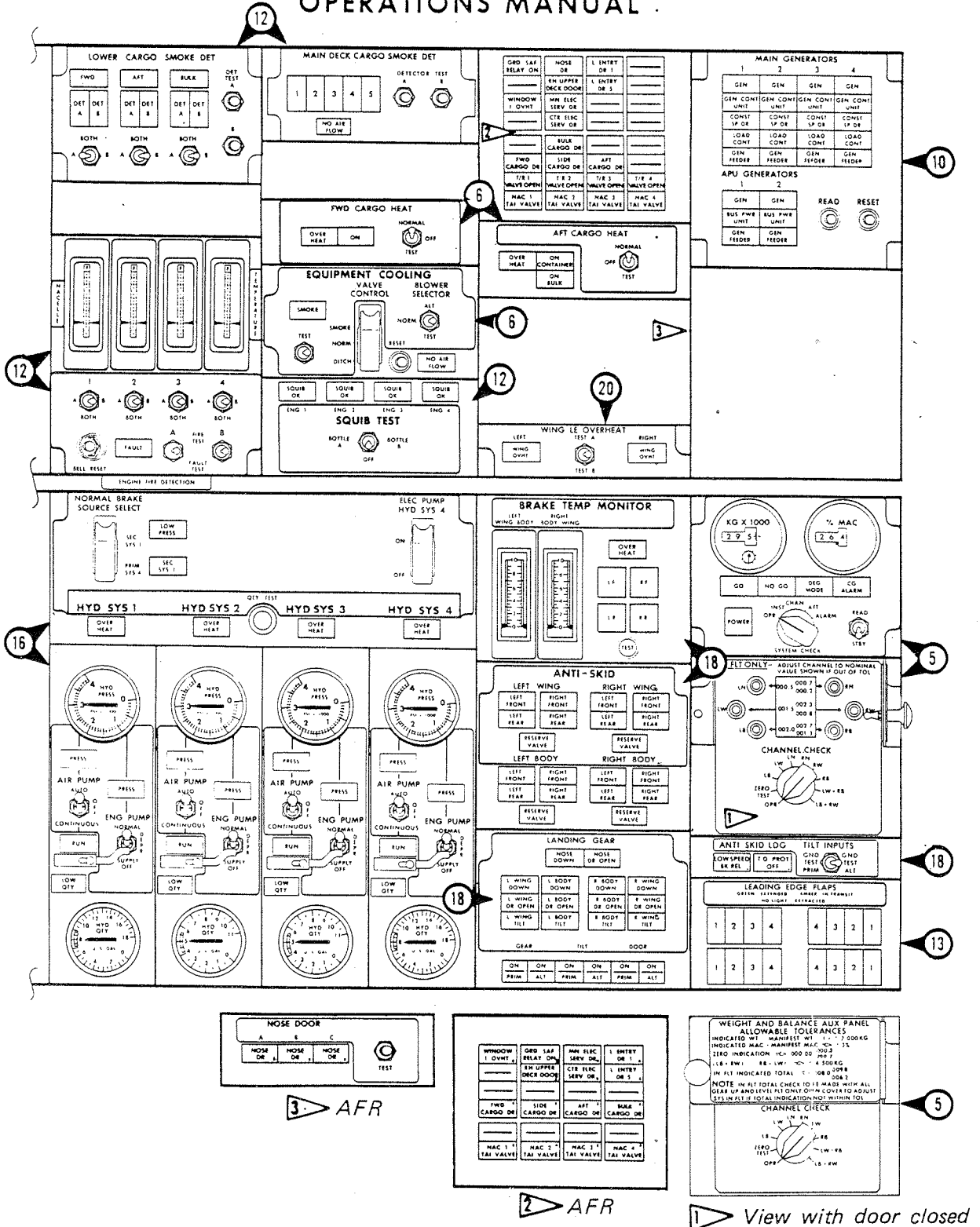

FLIGHT ENGINEER'S INSTRUMENT PANEL - UPPER PANEL - RIGHT (FREIGHTER)

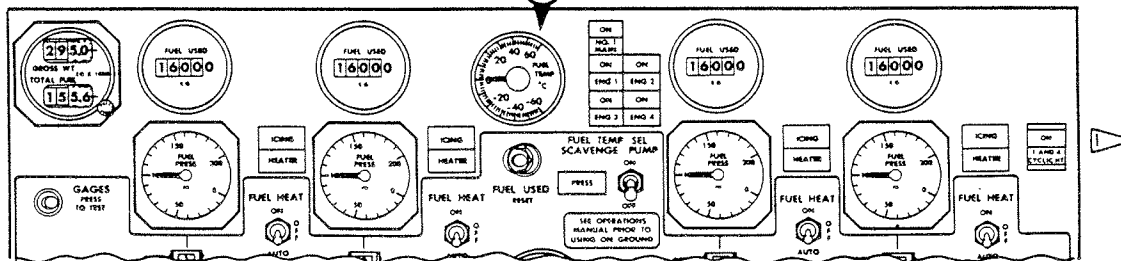
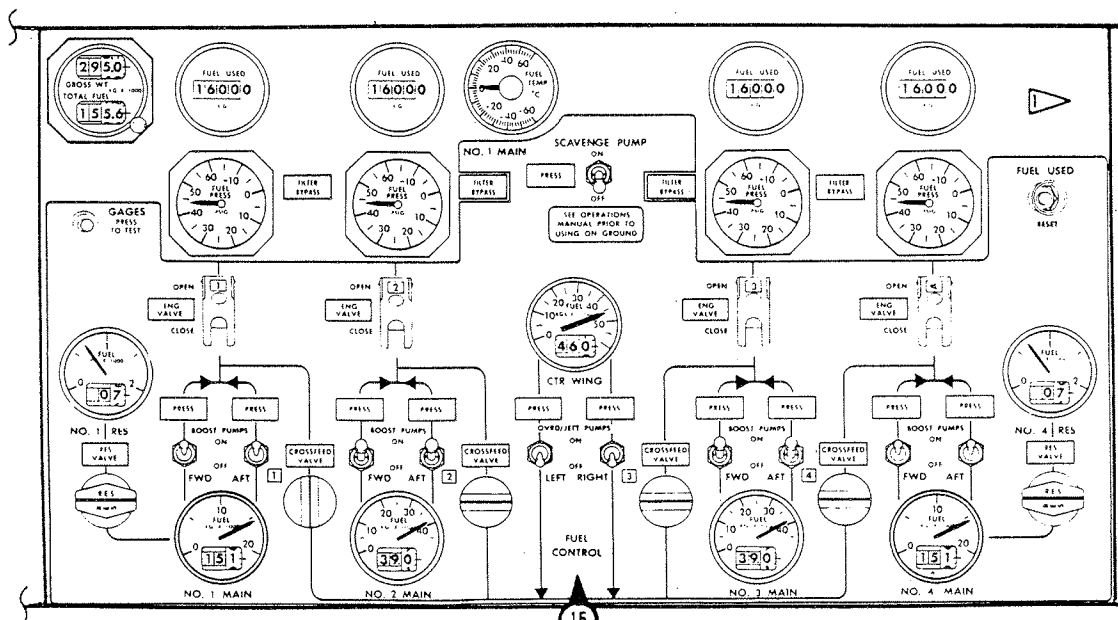
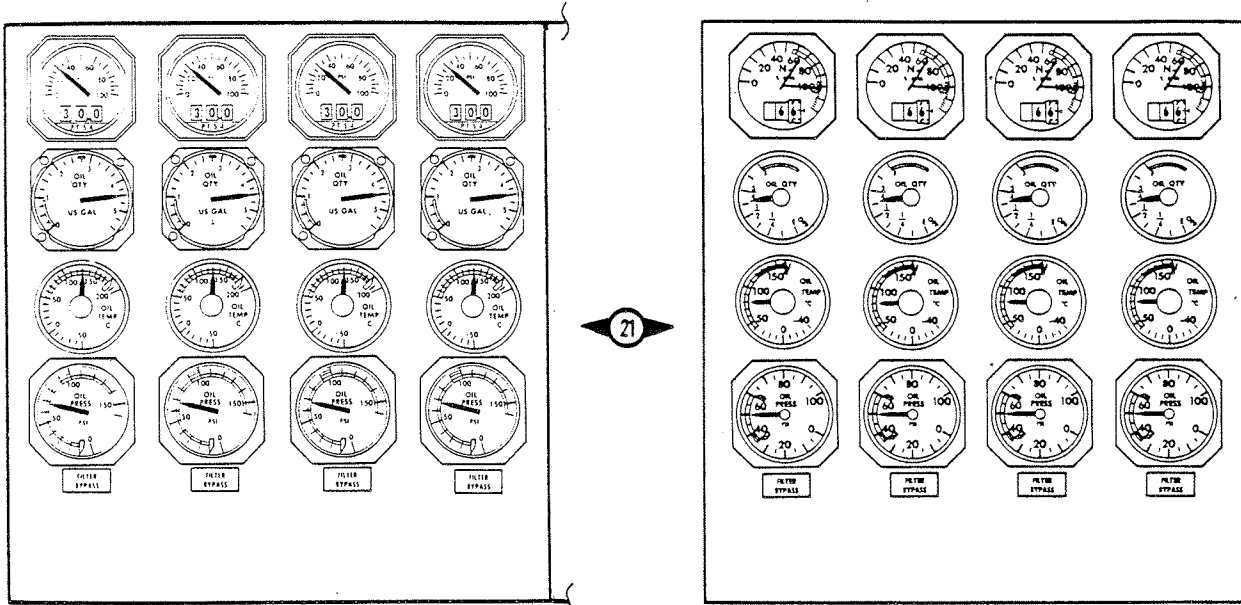

▶ As installed

FLIGHT ENGINEER'S FUEL INSTRUMENT PANELS
(-200)