

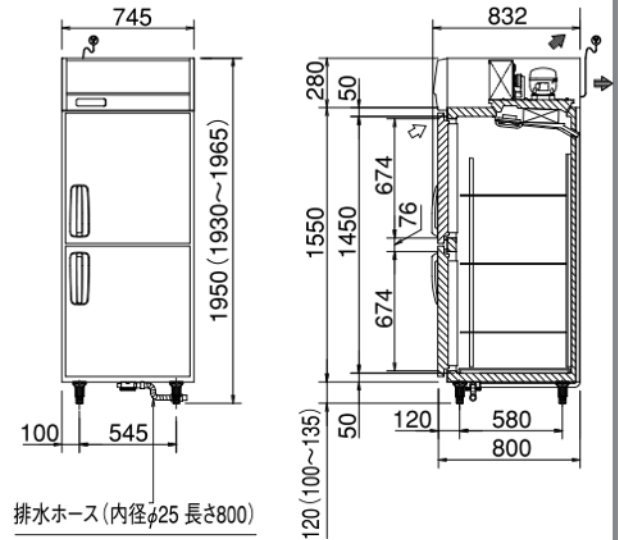

# Panasonic

## BUSINESS

### Refrigerator and Freezer STAINLESS STEEL UPRIGHT



Model	Temperature	Dimension	Volume	Weight	Refrigerant	Power
<b>SRR-K761</b> (CHILLER)	-6°C ~ +12°C	Ext: W745xD650xH1950 Int: W645xD550xH1450	490 L	81kg	R134a	<b>Cooling:</b> 100V / 164/164W (50/60Hz) <b>Defrosting:</b> 100V / 309/309W (50/60Hz)
<b>SRF-K761</b> (FREEZER)	-25°C ~ -15°C	Ext: W745xD650xH1950 Int: W645xD550xH1450	490 L	81kg	R134a	<b>Cooling:</b> 100V / 198/198W (50/60Hz) <b>Defrosting:</b> 100V / 329/329W (50/60Hz)
<b>SRR-K781</b> (CHILLER)	-6°C ~ +12°C	Ext: W745xD800xH1950 Int: W645xD700xH1450	636 L	88kg	R134a	<b>Cooling:</b> 100V / 164/164W (50/60Hz) <b>Defrosting:</b> 100V / 309/309W (50/60Hz)
<b>SRF-K781</b> (FREEZER)	-25°C ~ -15°C	Ext: W745xD800xH1950 Int: W645xD700xH1450	636 L	88kg	R134a	<b>Cooling:</b> 100V / 198/198W (50/60Hz) <b>Defrosting:</b> 100V / 329/329W (50/60Hz)

#### High energy saving performance

- Inverter compressor
- Automatic frame heater duty optimization
- Automatic condensing fan speed control

ECONAVI

