

BOEING 747 OPERATIONS MANUAL

AIRPLANE GENERAL COCKPIT PANELS

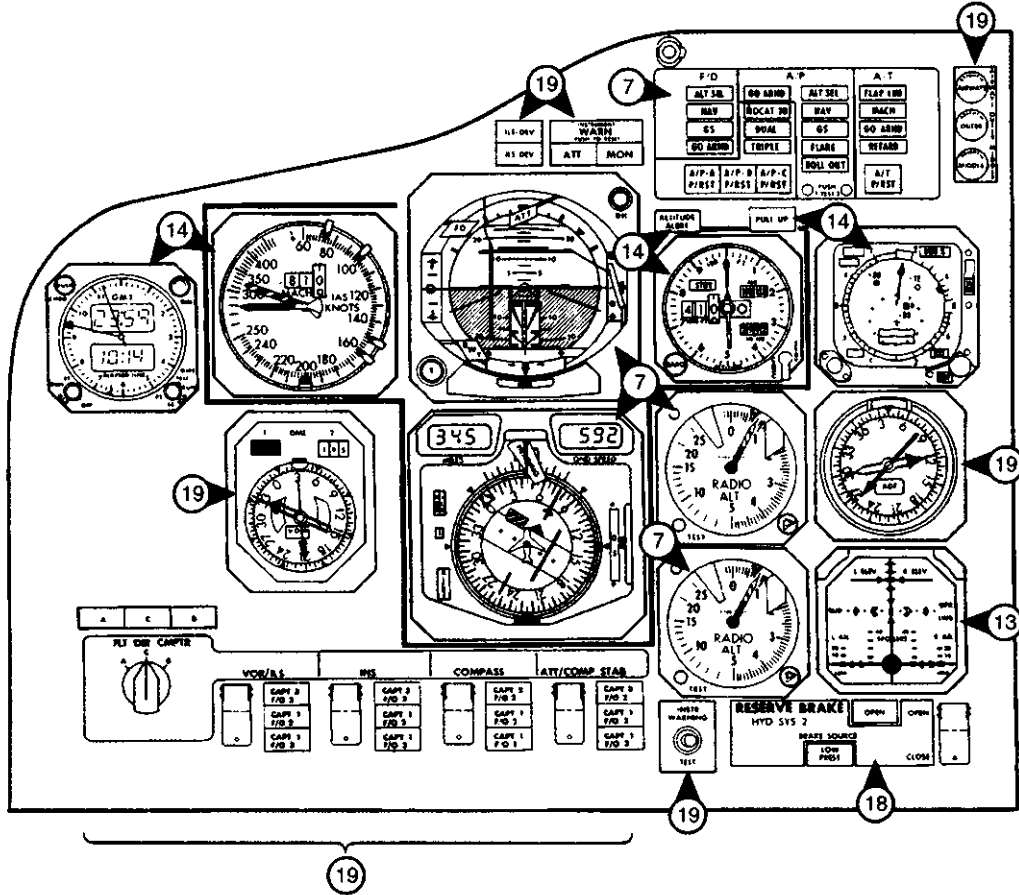

**CAPTAIN'S INSTRUMENT PANEL
(-240BC)**

R33102

PA
Jun 01/07

Copyright © The Boeing Company. See title page for details.

05.20.01

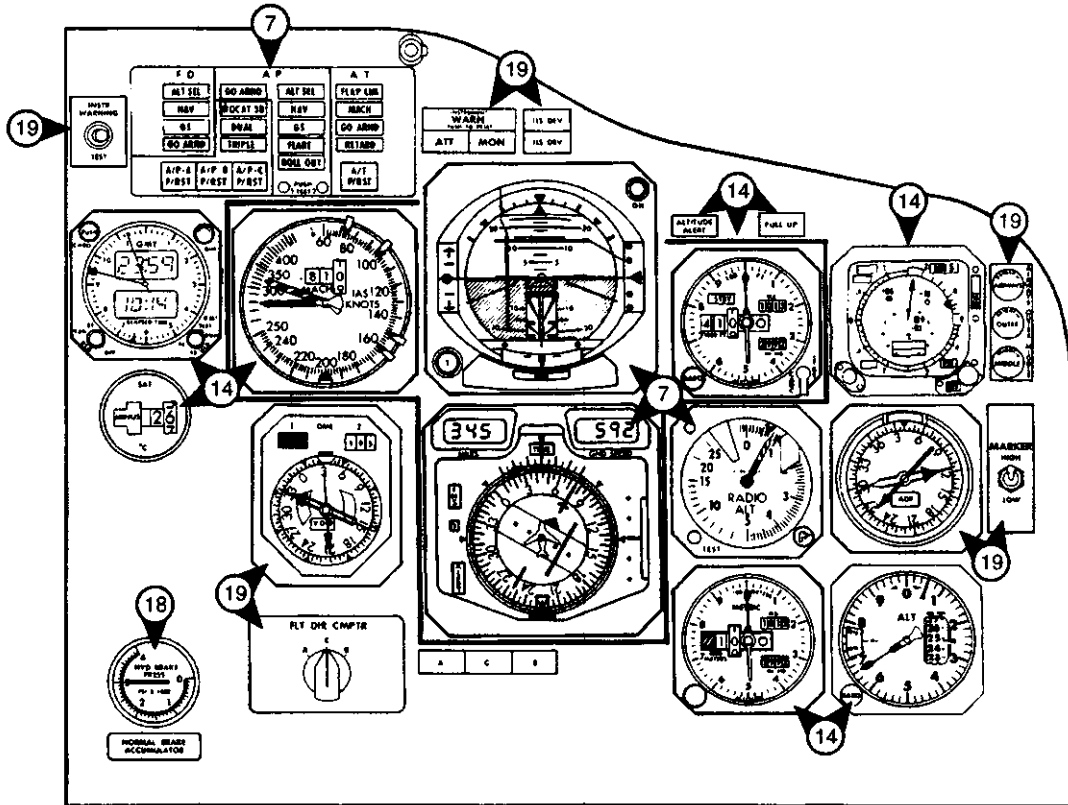

FIRST OFFICER'S INSTRUMENT PANEL

BOEING 747 OPERATIONS MANUAL

AIRPLANE GENERAL COCKPIT PANELS

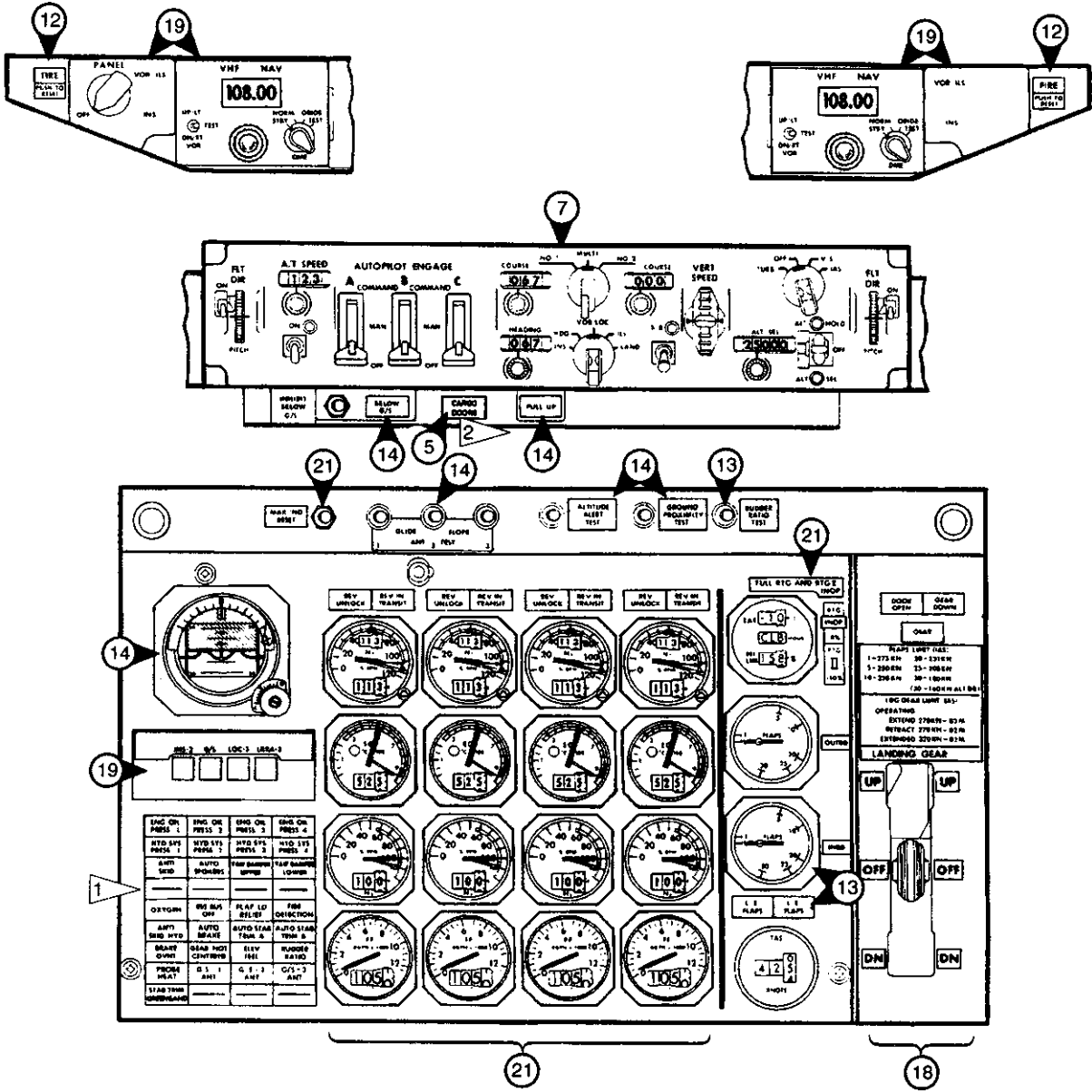

LOW N₁

- 1 As installed
- 2 As installed

PILOT'S CENTER INSTRUMENT PANEL & LIGHT SHIELD (-240BC)

1376267

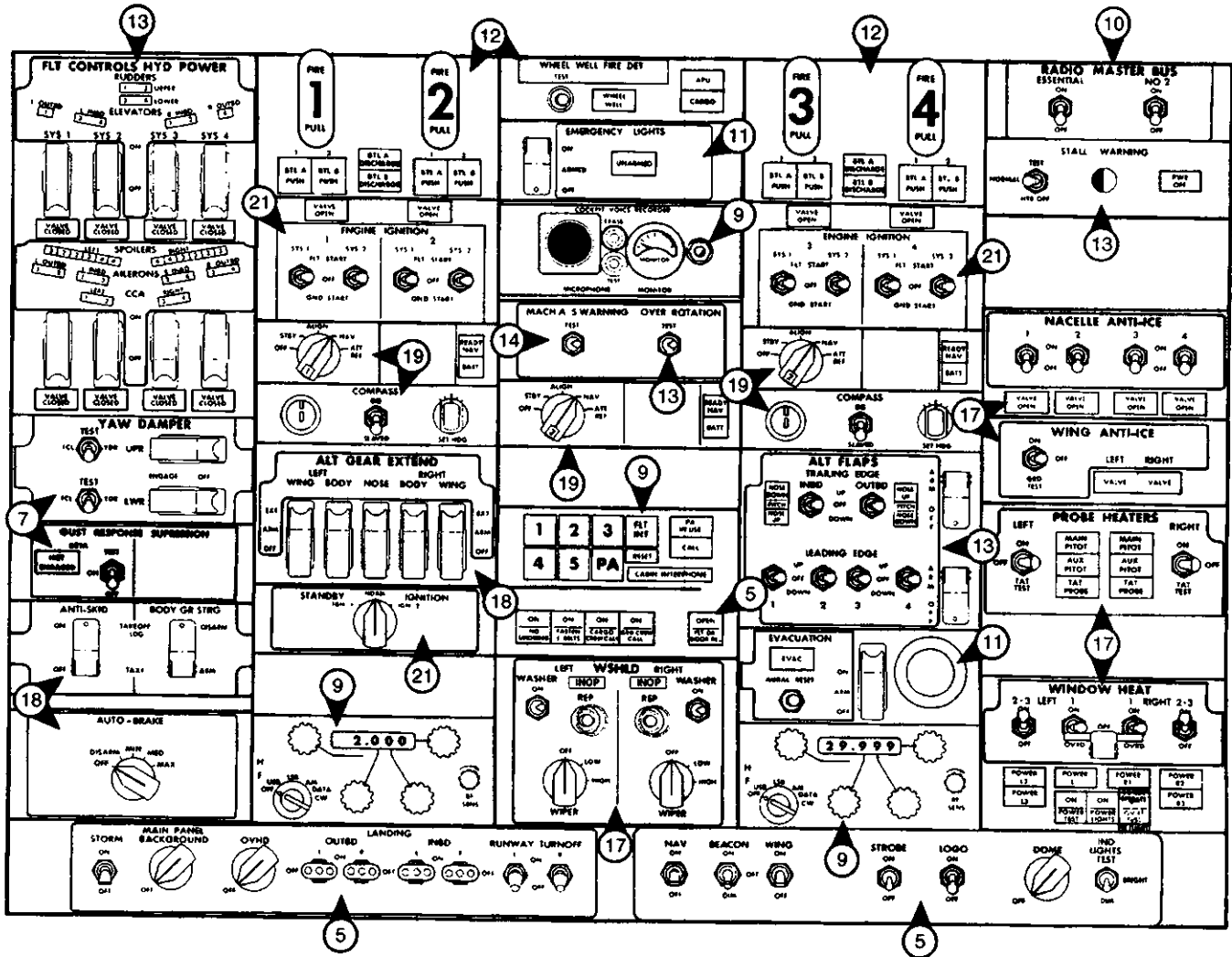

**PILOT'S OVERHEAD PANEL
(-240BC)**

C

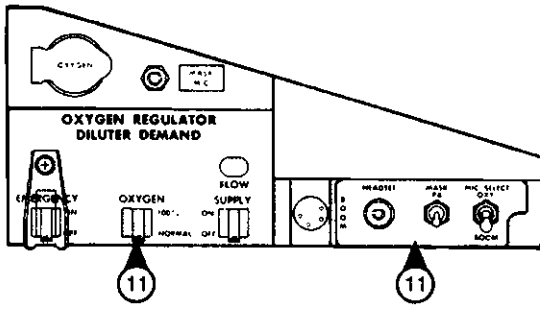

D

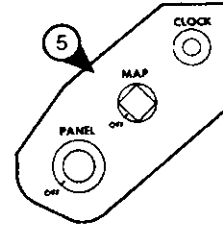

B

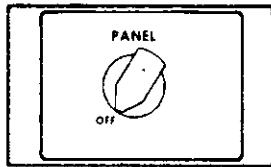

E

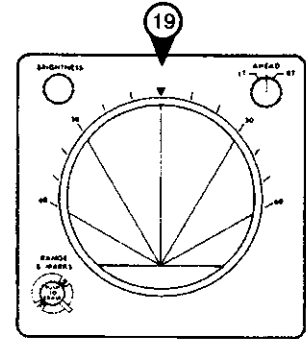

A

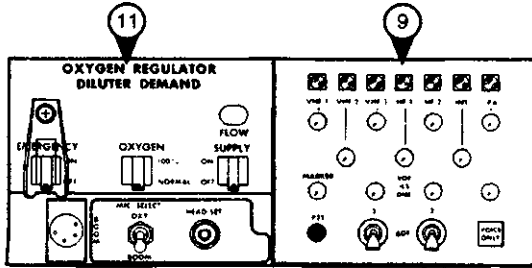

F

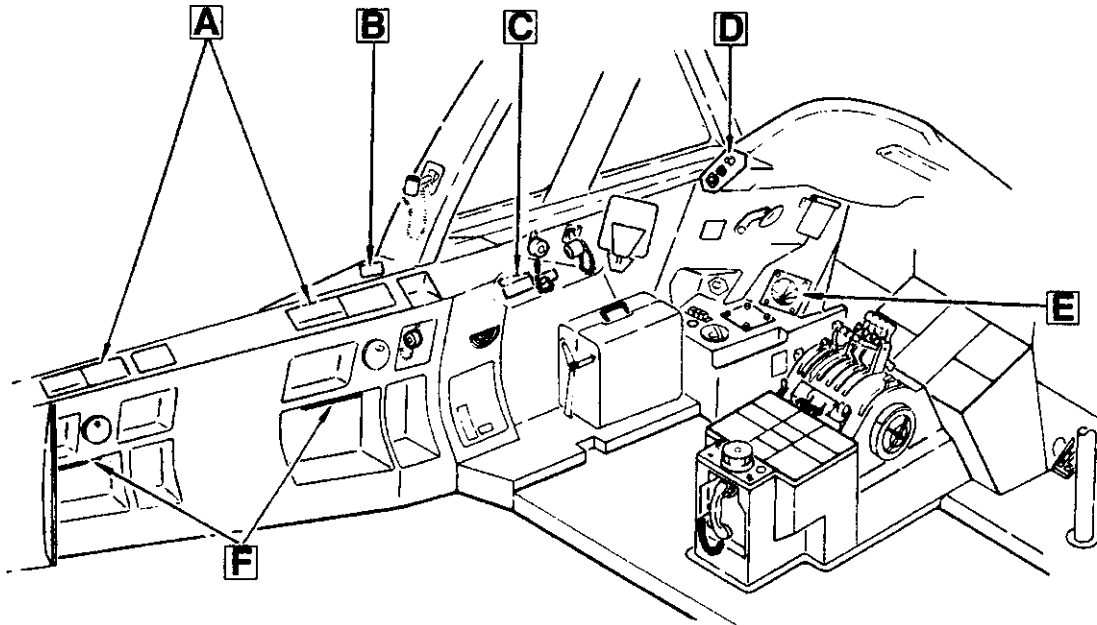
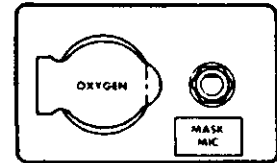

**CAPTAIN'S & FIRST OFFICER'S AUXILIARY PANELS
(-240BC)**

1376329

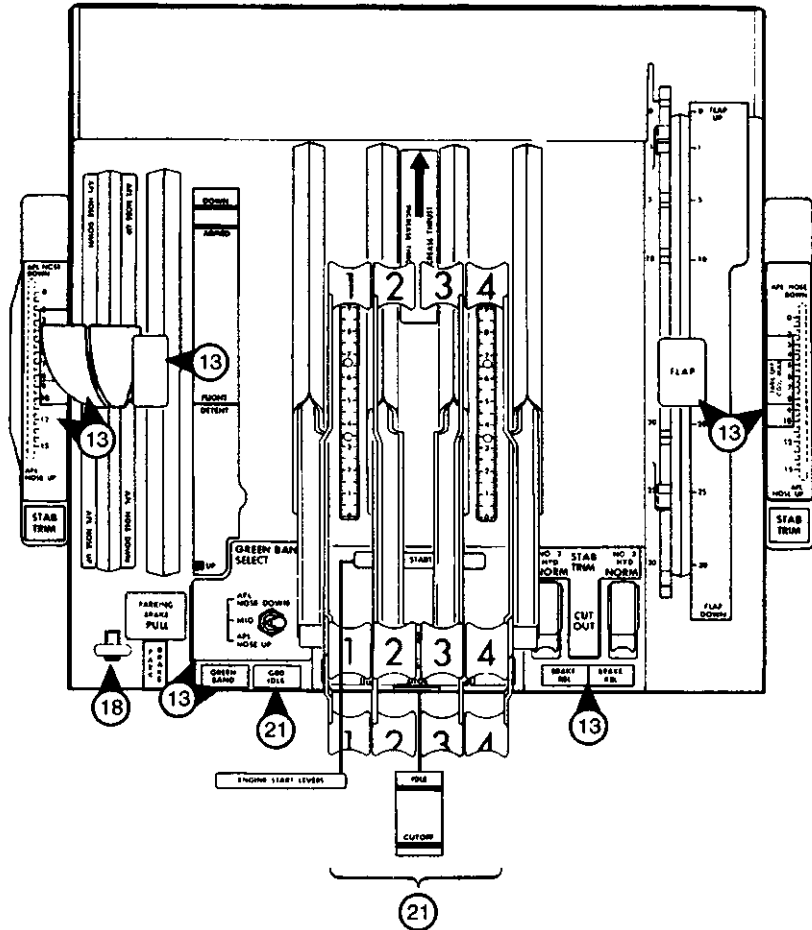
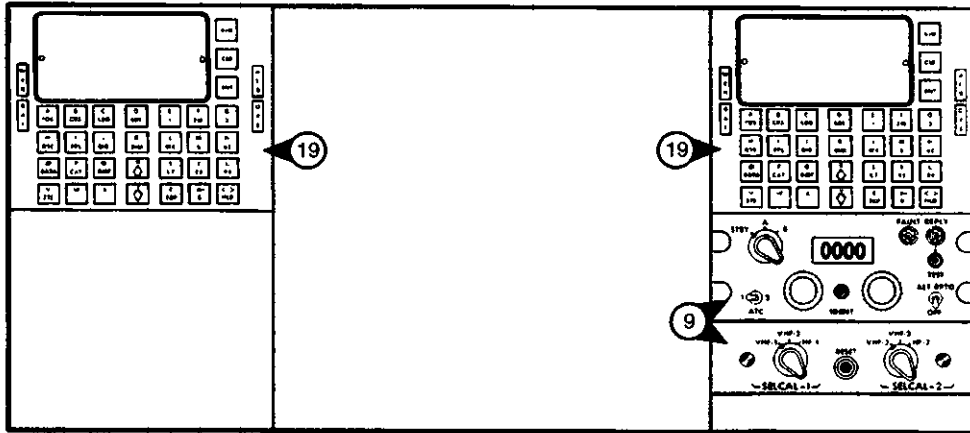

**PILOT'S CONTROL STAND (UPPER HALF)
(-240BC)**

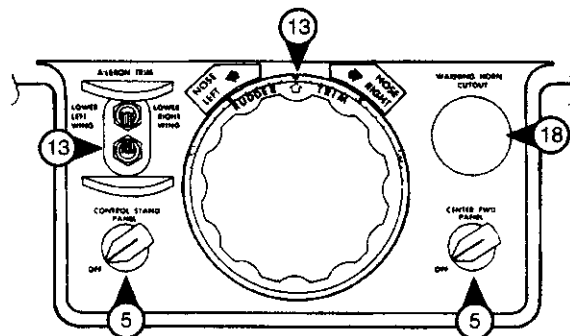
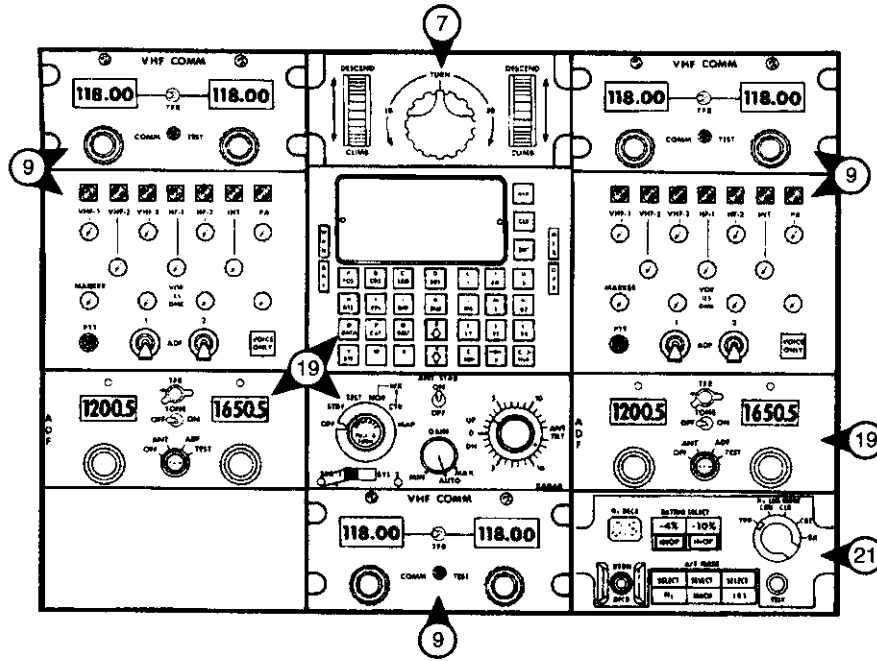

**PILOTS' CONTROL STAND (LOWER HALF)
 (-240BC)**

Copyright © The Boeing Company. See title page for details.

1376574

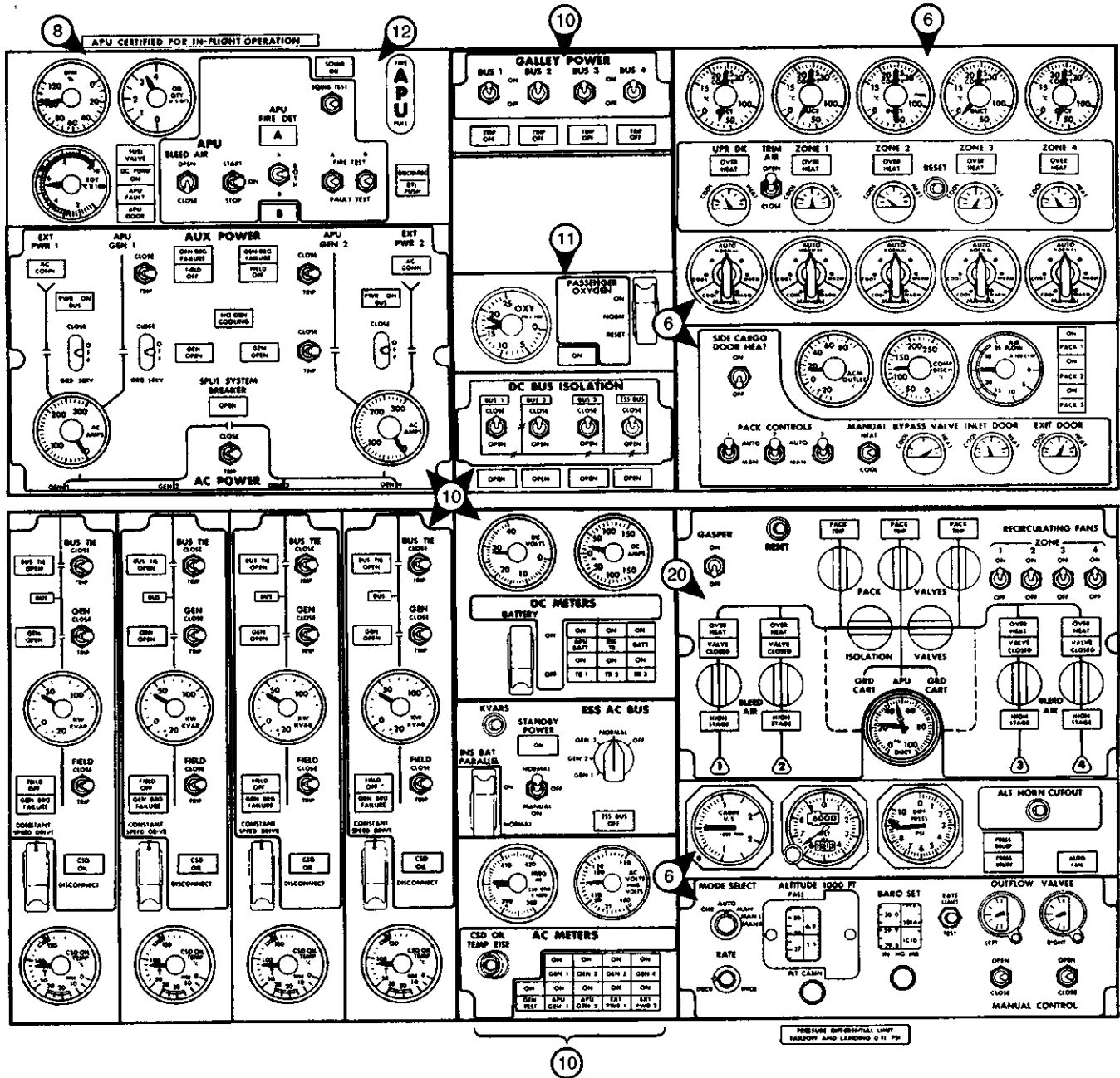

FLIGHT ENGINEER'S INSTRUMENT PANEL - UPPER PANEL - LEFT

BOEING 747 OPERATIONS MANUAL

AIRPLANE GENERAL COCKPIT PANELS

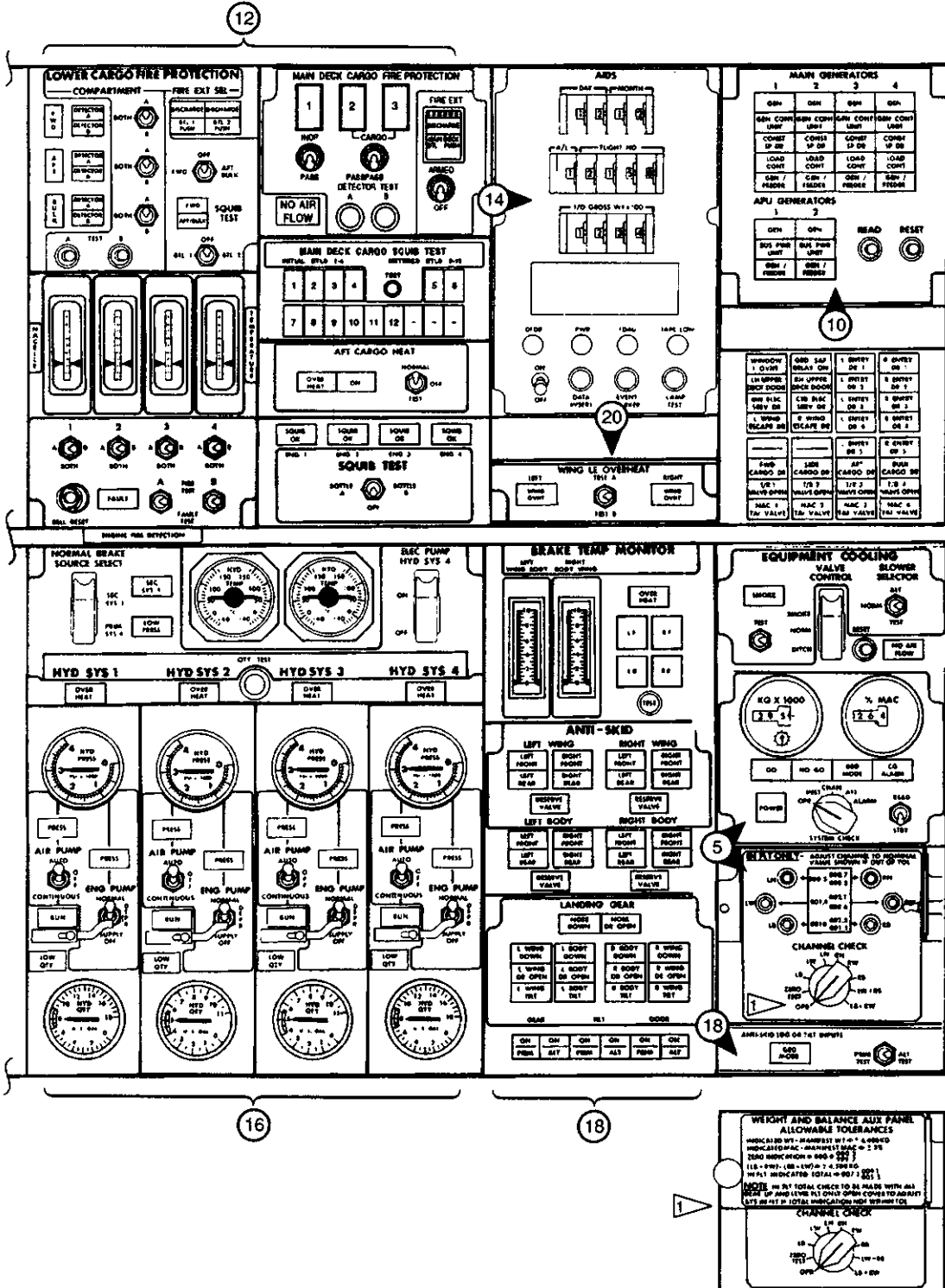

1 View with door closed

FLIGHT ENGINEER'S INSTRUMENT PANEL - UPPER PANEL - RIGHT (-240BC)

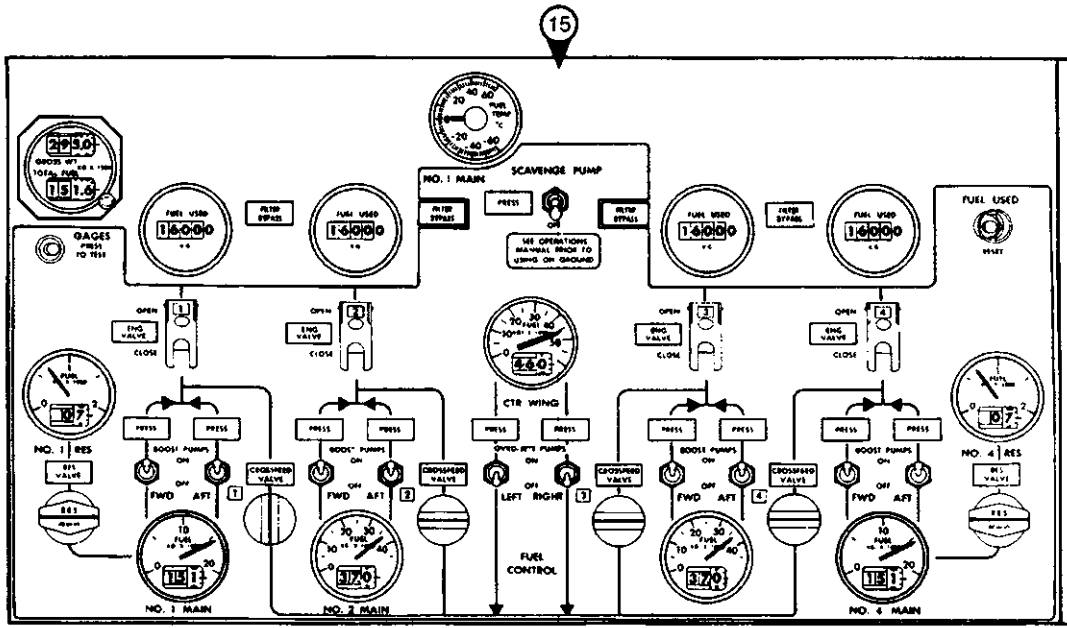
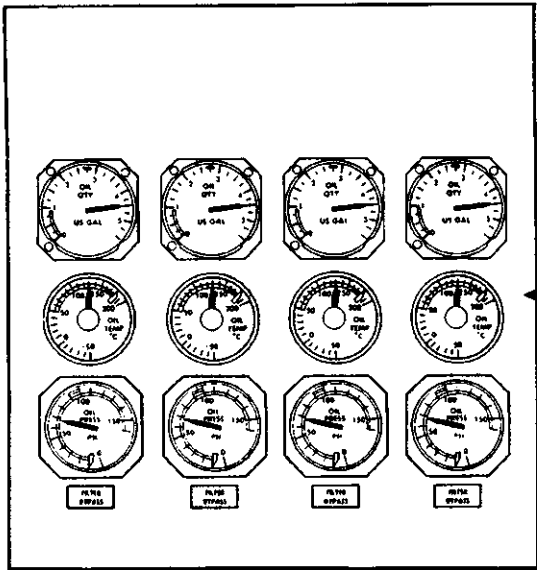

**FLIGHT ENGINEER'S LOWER INSTRUMENT PANELS
(-240BC)**

1376617

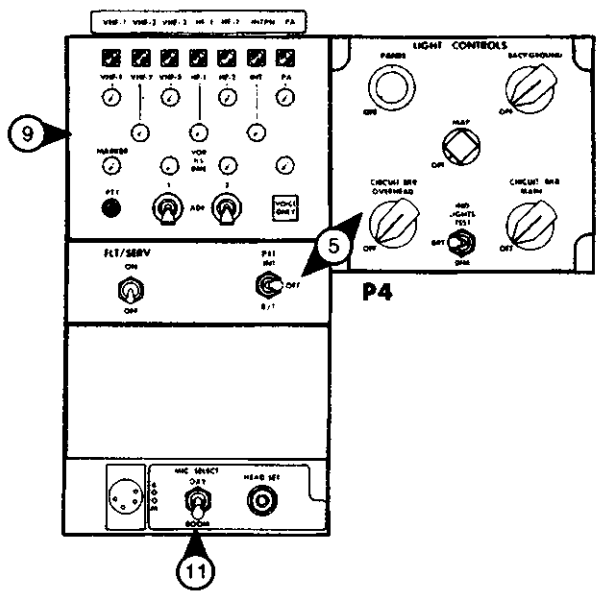
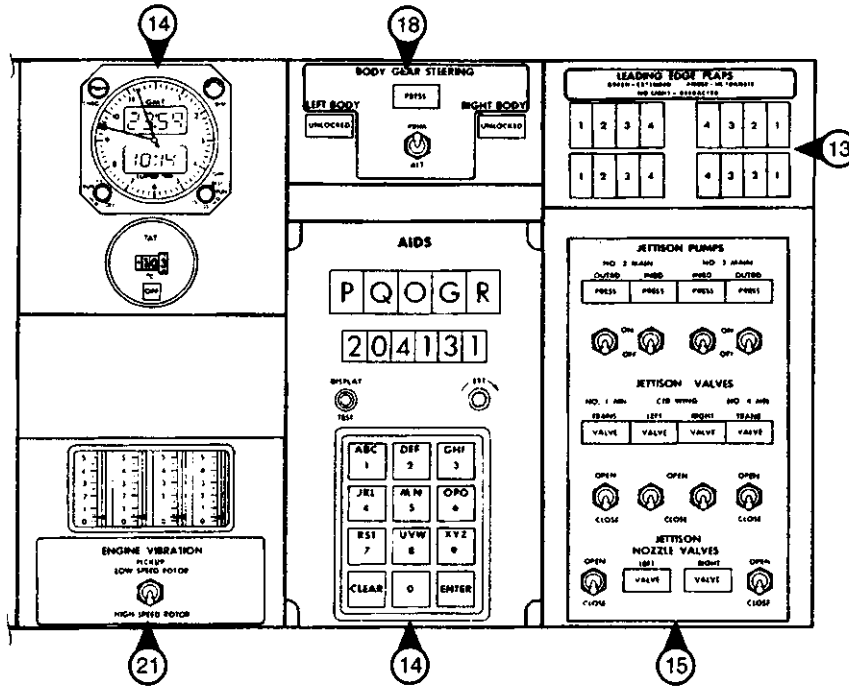

**FLIGHT ENGINEER'S LOWER INSTRUMENT PANELS (CONT)
(-240BC)**

1376620

40P
Jun 01/07