



# Backwoods Solar



## **Backwoods Solar** Planning Guide & Catalog

# OUR STAFF



SHAWN



JOHN



AARON



JEFF



BRIAN



TRACEY



ALAN



BRANDON



ERIKA



DAVE



JULIE

For over 40 years, we have specialized in independent electric power for the remote off-grid or grid-tied home. We offer personal attention for owner-builders who design and construct their own homes and power systems as well as work with smaller installers across the globe. We also specialize in remote power for telecom systems, water pumping, and rural villages around the world.

















We live what we sell. Many of our technical salespeople live in homes that get their power from the wind, water or sun using the products we sell in our catalog. Tracey's post and beam home is powered by a Harris hydro system with Schneider Electric and Morningstar products. Shawn uses a Bergey wind turbine and Kyocera modules as well as Outback & Schneider Electric power components. Alan will be using an array of REC modules on his new home with utility power as a back-up source. He currently provides backup power to a grid-connected deep well pump with a Schneider Electric inverter and transformer. Brian has 24V solar modules working in combination with a Hydro-Induction Power micro-hydro system along with a Magnum MiniPanel system. John powers his family's log cabin with 24V solar modules as well as Outback/Schneider Electric power components. Brandon has a solar array using 60-cell modules and AP Systems micro-inverters set up for net-metering and to power his grid-tied home.

**FRONT COVER:** This off-grid adventure facility, owned by Frederick Dure, is located on the Nizina River in Wrangell-St. Elias National Park, Alaska. Their off-grid system involves 4.4kW of solar panels on 2 azimuth trackers, a 5.5 kW Trace/Xantrex (now Schneider Electric) inverter, Outback charge controller and Surrrette batteries.

**BACK COVER:** Sunset at the Hedges off-grid guest house in Dubois, Wyoming is a simple system made up of two 100W panels, a 1200W inverter and two 12V batteries powering DC lighting circuits and a 110V AC outlet. A larger, separate system powers their main home.

Visit **BACKWOODS SOLAR!** Interact with our knowledgeable staff. Test products on display. We're open weekdays for visitors from 1 PM to 4 PM, Pacific Time. If you are distant, phone, mail or email your questions and dreams. Our office is open for your calls and email Monday through Friday from 8:30 AM to 4:30 PM, Pacific. And you may also visit our website: [www.backwoodssolar.com](http://www.backwoodssolar.com).

# CONTENTS

<b>INTRODUCTION</b> .....	2 - 5
OFF-GRID SYSTEMS .....	6 - 23
GRID-CONNECTED .....	24 - 29
 SOLAR MODULES .....	30 - 35
 SOLAR MOUNTS .....	36 - 47
 SOLAR WIRING AND CABLING .....	48 - 55
 WIND POWER .....	56 - 58
 HYDRO POWER .....	59 - 61
 POWER PANELS .....	62 - 67
 CHARGE CONTROLLERS .....	68 - 80
 BATTERIES, BATTERY CHARGERS and ACCESSORIES .....	81 - 92
 ENGINE GENERATORS .....	93 - 94
 INVERTERS .....	95 - 113
 METERS and BATTERY MONITOR .....	114 - 116
 HARDWARE, BREAKERS & FUSES, TIMERS, DC CONVERTERS .....	117 - 126
 DC LIGHTS - BULBS & FIXTURES .....	127 - 131
 WATER PUMPS .....	132 - 143
 DC APPLIANCES .....	144 - 146
 REFRIGERATORS & FREEZERS - Electric .....	147 - 151
 EDUCATIONAL BOOKS .....	152
ORDER BLANKS and SHIPPING INFO .....	153 - 155
REFERENCE .....	156 - 160



# GETTING STARTED - OFF GRID

## STATE OF THE ART SOLAR ELECTRIC HOMES TODAY

Forty years ago, independent home power meant designing and building your own equipment. Today, it doesn't have to be a full time hobby, though it still can be fun. Home power system designs and components are standardized. Common problems have been solved by the experience of thousands of solar-, wind-, or hydro- powered home owners. All the equipment is readily available, from a basic starter setup for lights and TV in a small cabin, to a full AC powered home and business. A good power system may consist of just 3 or 4 integrated components.

**STILL** — Independent electrical power is not quite a 'turnkey' appliance like a central heating system with sales and service people knocking at your door. Many independent homes are in remote places, where the owner is the prime decision maker, meter reader, and service person. A practical solar electric system requires some owner participation in planning, management, and maintenance. The owner-builder who understands batteries and equipment will have a better working system, save money, and become more self-reliant.

**YOUR OWN INDEPENDENT POWER SYSTEM** can provide most electric conveniences at a remote home site, where bringing in utility lines would be impossible or prohibitively expensive. Extending utility power just 1/4 mile or more to reach a home site can cost \$15,000 and up, and that's before you get any power. Equipment to produce your own solar electric power is not only a clean and renewable energy source, it may cost less. Boats and recreational vehicles can use the same solar powered equipment on a smaller scale.

**NATURAL AND FREE ENERGY** already on your site in sunlight, wind, or falling water can be converted to electricity. We specialize in designing systems that make power entirely from solar, wind, or hydro.

**WE USE IT!** Since 1979, Backwoods has specialized in off-grid power for the remote home. Not only was Backwoods Solar entirely powered by equipment from this catalog for years, additionally most Backwoods Solar employees power a home or a portion of their home with our products. At Backwoods Solar you are talking to people who use the equipment every day.

**THIS BOOKLET INTRODUCES BEGINNERS** to the joy of making your own power.

The first 29 pages explain the set up of an alternative energy system including: what the parts of a system are, what they do, and how they work together. Also covered is how to prepare a house to use solar electricity, and the approximate cost for several examples. All of this information will help you select a solar electric system for your home or RV.

The second section of the catalog contains all of our equipment and prices, along with a more detailed explanation on each class of product. Towards the back of the catalog, you will find educational books for purchase followed by order blanks and technical charts for wire sizing, battery sizing and light levels.

There really is no limit to the size of your power system. However, taking steps to conserve energy and reducing your electrical use will lower the cost of your renewable energy system.

The team at Backwoods Solar is happy to help answer any questions you have about your renewable energy system.



## THE PROCESS & THE HARDWARE

**SOLAR MODULES**, sometimes referred to as panels, are installed in groups on solar mounts, which in turn, attach to a building, the roof of an RV, or atop a metal post in the yard. Each solar module is wired to the other modules in that string by sunlight tolerant solar interconnect wiring, either in series, parallel or series-parallel depending on the application and needs of the system. Together this is called a solar array. Several strings may be wired to a solar combiner box where they are all connected to heavier wires taking the power to the battery and equipment room. Solar modules last well over 25 years with little maintenance. Most modules carry a 25 year power production warranty, and most now carry additional manufacturers' warranties on workmanship.

A **CHARGE CONTROLLER** receives the power from solar, wind, or micro-hydro generators, and controls the flow of power to the battery. To prevent battery damage from overcharging, the charge control automatically cuts back, stops, or diverts the charge when batteries become full. A charge control may have manual control switches and may have meters or lights to show the status of the charging process. MPPT charge controllers can step down high voltage arrays to a lower voltage for your battery bank, allowing you to use larger wattage/higher voltage modules.

**BATTERIES (DEEP CYCLE)** receive and store Direct Current (DC) electrical energy, and give back the electricity as needed, even when no power is being produced. Think of your system batteries like a bank account, power put into batteries over a period of time can be taken out more quickly if a lot is needed. And the total amount of power you withdraw cannot be more than you put in, or the account will be depleted.

Batteries can instantly supply large surges of stored electricity, as needed, to start or run heavy power appliances that the solar panels or hydro electric generator alone could not power. This large power capability can be a fire hazard just like utility company power, so fuses and/or circuit breakers on every circuit connected to a battery are essential. Battery size is chosen for both surge power requirements and for the amount of reserve power needed. Typically, 2 to 12 square feet of batteries weighing 150 to 5000 pounds are enclosed in a battery box with a vent pipe to the outside. Wind generators and micro-hydro generators in this catalog also produce DC for charging batteries.

The **INVERTER** is a major component of your system that converts the 12, 24, or 48 volt DC current from the battery into 120/240 volt AC current, the same as utility power for standard household lights, outlets, and appliances. Most solar homes use primarily 120/240 volt AC produced by the inverter. Short, heavy cables with a large fuse or circuit breaker carry battery power to the inverter. After conversion to AC, power from the inverter usually connects into the circuit breaker box of the house in place of utility lines. The house breaker box routes power to lights, appliances, and outlets of the house.

## THE PROCESS & THE HARDWARE, continued

**AN INVERTER/CHARGER** is an inverter that also has a battery charger and transfer relay built in. When the input terminals of an inverter/charger receive power from an outside source of AC (a generator or utility power) the inverter stops producing AC power from the batteries, and instead passes generator or utility AC power straight through to the house. At the same time it uses the generator or utility power to recharge the batteries. Some inverters can even auto-start the generator when batteries need charging. A separate battery charger can be used instead of (or in addition to) an inverter/charger.

A **BACK-UP STANDBY GENERATOR** produces 120 or 240 volt AC power. It is a second source of AC power and a backup for charging the battery bank when there is a shortfall in solar or wind power, or a temporary need for additional power. Starting the generator begins the inverter charging process. The best generators start automatically or by push-button from the house. A generator is located outside, usually in its own shed at least 30 feet away from living space to avoid noise. For reasons of health and safety, it is not recommended for installation in a basement or garage. 120/240 volt AC power from the generator goes through a circuit breaker, and then is wired into the power room to run battery charger(s) as well as supply the AC power to the house whenever the generator runs. Since both battery charger and AC transfer relay are usually part of a standby inverter, the generator power usually connects only to the AC INPUT terminals of the inverter, not to the house breaker box. Many inverter systems that Backwoods sells can include automatic generator start modules, which will start a generator when battery voltage falls to a certain point without interaction from the homeowner, if the generator has an auto-start feature.

**FUSES** or **CIRCUIT BREAKERS** are necessary in all DC wiring between the batteries and other power system components described (these components are not shown in the following drawing). They prevent fire and equipment damage in event of a malfunction. Breakers may be separate components in their own box, or might be built into a power panel. In contrast, the AC breaker box for household wiring is part of the house wiring, not usually included with power generating equipment.

**METERS**, used to monitor battery systems, show if everything is working properly. Solar charge indicating meters are often built into the charge controller to confirm the charging process instantly. Other meters show how much power is being consumed, and confirm how much power is available. These battery system monitors can be located in the power room, or at a convenient spot in the home for easier checking.

A **POWER PANEL** includes system meters, DC circuit breakers, and wiring connections for batteries, inverter, solar and other charging sources. Power panels are easier to install and to pass building code than it would be to select, buy, and install all those parts separately. The power room is simplified, with just a few main components: power panel with charge control attached, a standby inverter-charger, and a battery box on the floor.



# TYPICAL OFF-GRID SYSTEM WITH GENERATOR

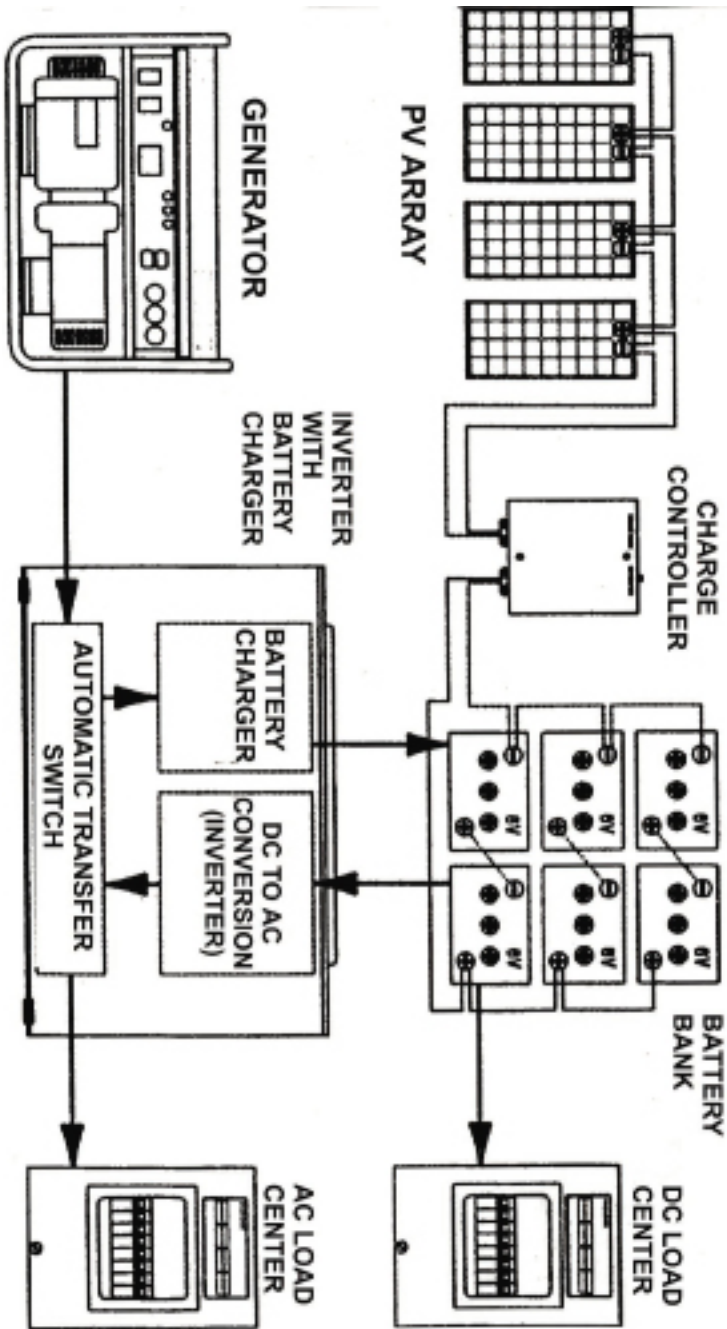

# WHAT WILL REMOTE POWER COST?



Because lifestyles and power usage vary so widely between individuals, a rural off-grid solar electric home set up cost can vary widely, from \$1,200 to more than \$50,000. Most often our customers spend between \$6,500 and \$18,000. Cost varies with amount of power needed, and also with the average daily sunshine hours for your location and climate. Northern areas with overcast snowy winters need a lot more solar modules and batteries than homes in New Mexico or Arizona, though both may use the same amount of power. The quantity of power you need relates to the “loads” or usage, more than to the square footage of the home.

Wind generators can be used together with solar to generate power in more varieties of weather. On a site with wind speeds measured and confirmed, wind generation used together with solar can reduce the total cost of the power system.

Micro-Hydro power can be the best choice and lowest cost power source for those few sites with the required water resource. If there is a small stream dropping 20 feet or more in elevation across your land, or a larger stream dropping 5 feet, water power may be possible. You might generate all the power you need from a micro-hydro turbine for as little as \$7,000 complete, or as much as \$16,000, plus the cost of the pipe line.

The above estimates do not include a backup generator which can range from \$3,500 to \$10,000 or more depending on size and quality.

Backwoods Solar can help you choose and estimate the cost of the right equipment for you with the following information:

- Number of people in the home
- Lifestyle & energy consumption habits
- Appliances
- Whether there is home-business activity
- Anything else affecting power usage





## WHERE TO PUT IT?

- Batteries, inverter, and electronic controls should be installed in a utility room inside or near the residence.
- Electronic equipment mounts on 4 to 5 feet of wall within 8 to 10 foot (max) cable length from the batteries.
- Equipment could be installed on the other side of a wall from the battery closet.
- Batteries take 2 to 15 square feet of floor space within the cable length from wall mounted equipment, and should be beside, rather than directly in front of wall mounted equipment.
- Allow ample working room to check batteries, and avoid cramming everything in a tiny closet.
- Electronic components need the same environment as a computer, TV, or stereo: a place that is clean, and away from moisture condensation.
- Batteries should not be accessible to children or others unfamiliar with their hazards.

Flooded lead acid batteries emit minimal amounts of flammable, hydrogen and oxygen gas when charging, so should be enclosed in a box vented to outside by plastic pipe. They should stay above freezing but avoid temperatures over 80 degrees Fahrenheit, if possible. An outside battery and equipment shed may be used in moderate climates, but avoid putting batteries on a wood floor vibrated by the generator engine.

Distance from the power room to generator and to the house AC circuit breaker panel is not critical. We highly recommend a generator be in its own shed some distance away, to avoid the noise.

Distance from power room to solar module location is limited, as explained in the section on mounting solar modules. Modules are best pole mounted, or can be roof mounted if trees and buildings prevent good sunlight at ground level.

# EFFICIENCY IN OFF-GRID HOMES

The amount of power your system generates depends on the natural energy resources at your location and on how much equipment you install to gather that energy. How much benefit you receive from that energy depends on careful selection of lights and appliances for maximum energy efficiency and on your conservation habits.

Rather than major life-style changes, we keep most advantages electricity offers while consuming only a small percentage of the power others use. Here's how:

1. Design the whole house (water, heat, power) for low energy use.
2. Carefully select low energy lights and appliances.
3. Eliminate energy waste in appliances, and from human carelessness.

That means:

- Using lights, refrigerators, and freezers that use about 1/4 as much power.
- Using natural gas or propane for major heat production in cooking, water heating, clothes drying, and home heating. (Try to include passive solar home design and perhaps some wood heat).
- Installing extra switches to cut power from phantom electric loads to electronics which consume power even when not turned on.
- For small 12V systems, wire doorbells, wireless phones, and motion sensor lights to DC power direct from the house battery bank, to use no power when idling.
- Use motion sensor and timer switches for outdoor lights.
- Use heating systems that distribute heat without pumps or blowers.
- Cooling should be evaporative instead of air conditioning.



OFF-GRID homes are usually in remote locations where utilities are not available. Pictured left is the Lewis Cooper home and below is the home of Kip Drobish.



# APPLIANCE SELECTION IN OFF GRID HOMES

Due to the higher efficiency standards of most current home appliances (from TVs to refrigerators), the difference between items used in an off-grid home and a utility connected one is not dramatic. But, understanding the following information before shopping for appliances will help you make the best decision for your individual setup. Your electrician should understand these points when planning the wiring. If you have questions or need clarifications call Backwoods Solar.

## NO MAJOR ELECTRIC HEATING/COOLING APPLIANCES

Electric heat, electric hot water, electric cook stove, electric heated clothes dryer, and air conditioner account for 80 percent of typical monthly utility bills. It is absolutely NOT practical to operate these major appliances with renewable electricity. Instead use wood or propane fueled furnaces, propane cook stoves and water heaters, gas fired clothes dryers (or just a rope in the sun). Build homes with passive solar heat design to save heating fuel for the rest of your life.

## HEATER - FURNACE - HOT WATER FLOOR HEAT

Use propane, natural gas, oil, or wood heaters and furnaces, never electric heat. Beware of ducted forced air and blowers (common in manufactured homes), the blower takes much more power than can be justified. Propane direct-vent (through the wall) heaters save fuel because each room can have its own heater and wall thermostat. No circulation blowers are needed so they work with no electric power. This is the easiest and lowest cost heating installation. Wood or gas furnaces located on bottom floor or basement in a multistory home allow heated air to rise by convection from lower to higher floors without powered fans or ducted blowers. Larger ducts for natural convection circulation can work with no power blower needed, or a very low power quiet DC fan from our DC appliance section to boost output.

No power or low power fans can also increase efficiency of gas heaters or wood stoves by moving air over the surface. Some home designs add a space alongside a masonry chimney as a hot air duct to the upper floors, and perhaps also run water pipes through it. Each stairway should have a door to control rise of heated air.

Floor heating by hot water circulation requires power to circulate water. Remember floor circulation heating puts added demands on your power supply at the season when you have the least power.

- Use of 1/2 inch or larger floor pipes allows for a lower power pump.
- Use separate DC circulating pumps and control each by a thermostat for its zone, rather than zone valves.
- Special boiler systems & zone valves can be problematic.
- Use tank gas hot water heaters or the wood fired boilers that heat water directly in the storage tank.
- Warm waterbeds and compost toilets by circulating hot water from the tank through coiled pipes under them and back again.

## AIR CONDITIONING

Air conditioning is too energy intensive to be practical other than a window unit in a very large solar power system. A small window A/C unit that can cool several hundred square feet can run for about 6 hours on a sunny day with 1000 watts of solar modules. Make sure to choose an Energy Star rated appliance and a true sine wave inverter. For those with smaller systems evaporative cooling (swamp coolers) works, except where very humid.

## WATER HEATING

Electric water heaters are out. Use a natural gas or propane heater from plumbing and hardware stores. Get one with a pilot light or electronic ignition, not glow-bar ignition. Vent all gas appliances straight out through the roof. Tankless instant water heaters are an option and they save on gas, too. A wood fired hot tub heater is also in the non-electric appliance section.

## WATER PUMPS

DC pumps use very little power and can pump to well depths of 200 to 800+ feet. Avoid higher horsepower than you actually need. See our “Water Pump” section and give us a call, with your well log, for help in sizing your pump.

## LIGHTING

Lighting uses less power, if you have lots of local area “task” lights rather than a big central light. Several small lights save energy by giving more flexibility than one large central light. Use LED spotlights under cabinets close to the kitchen counter. Use a separate wall switch for each wall/ceiling light so you can turn on lighting precisely where needed.

- Screw in light bulbs should be LED lights which use significantly less power compared to regular bulbs while giving the same brightness and color.
- Light dimmers should not be used unless you have a sine wave inverter and the bulb specifically states it is dimmable.
- Motion sensing lights outdoors are great for arrival and departure. A 12 volt DC powered motion sensor is on duty all night with almost no power use.

## REFRIGERATOR / FREEZER

Older refrigerators and freezers use so much power that battery charge is depleted very quickly. Many refrigerators have poor insulation and run long hours every day. Avoid most large refrigerators and freezers with the exception of more efficient Energy Star models using less than 450 kWh/year (listed on the Energy Star tag).

DC-electric refrigerators and freezers designed for solar powered homes can use much less power, and are shown in this catalog. These highly insulated units’ can save at least 50% of the energy consumed by ordinary refrigerators. Propane refrigerators are also available in the ‘Refrigerators & Freezers’ section of this catalog.

## KITCHEN STOVE

Electric stoves are out. Propane or natural gas stoves with gas pilot light need no power at all. Pick one of two types of pilot light ovens:

- One that has a regular gas flame pilot light.
- One that lights a burner by electric spark only when the oven is started, and then the burner goes off when finished heating. Optional spark ignition burners use very little power and work fine with inverters. Avoid a range with a glow-bar in the oven.

Range hoods with light and vent fan work fine with inverters. Be sure to put an LED bulb in it.

## DISHWASHER

Dishwashers work with one caution. There might be two high power heaters, one to dry the dishes and sometimes one to superheat incoming water. To save power, disconnect or use a switch to turn off these heaters.

## CLOTHES WASHER & DRYER

Modern horizontal axis, Energy Star washing machines are reasonably efficient with water and electricity but do require a good quality true sine wave inverter to run. These are the best style to use for full time off-grid living. Top loading washing machines also work with some modified sine inverters but use more water and electricity than a horizontal-axis. Due to the use of more sophisticated motor controls used in today's machines, Backwoods Solar recommends true sine wave inverters.

Gas heated clothes dryers work fine for off-grid use. They use a little electricity to spin the drum and ignite the gas. 240 volt AC electric dryers are not usually used for off-grid since they use massive amounts of power.



# COMPUTERS & PRINTERS

Most computers run on any inverter and we believe that they do not require a “true sine wave” inverter. However, we recommend a true sine-wave inverter anytime a component has an internal circuit board. Laptop/notebook computers use internal batteries, and recharge from any small inverter using just 40 to 70 watts AC power. Most manufacturers offer an optional car cord to operate from a 12VDC output port.

Laser printers (and most photocopy machines) can be damaged by modified wave (not true sine wave) inverters. Inkjet printers are not a problem, and use very little power. HP Laserjet printers automatically idle to just a few watts between printings, or a switch can be used to shut the printer off.

An outlet strip should be used to switch off all computer equipment after shut-down to prevent phantom load leakage.

For best results, we recommend that the entire home/office be powered by a large true sine wave inverter. Alternatively, one of the smaller true sine wave inverters may be added for your sensitive electronics, and a separate circuit runs from it in the battery room to an outlet by those devices.

# STEREO, TV, DVD, SATELLITE TV

LCD and LED televisions are very efficient but do require a sine wave inverter. VCR/DVD and some satellite units use only 20 watts. SATELLITE TV works great on inverter power. A Direct Satellite System (DSS) uses about 15 watts and a DVR would use about 45 watts. A STEREO of good quality usually works with any inverter. TVs, DVD/VCRs and stereos with remote control are phantom loads, and still consume power when switched off. It is important to use a wall switch, or a switched outlet strip to cut all power from this equipment when not in use. A few large screen TVs and sensitive audio gear require true sine wave power.

# SHOP & POWER TOOLS

Most hand-held power tools operate on 800 to 1500 watt inverters. Larger power equipment like table and radial saws usually work with 2500 watt inverters, though sometimes the motor belt needs to be slipped for easier starting on the largest equipment. Sine wave inverters work best for really large equipment. Wire feed welders and air compressors usually require a 3500-4000 watt inverter. Select small wattage tool motors or use a generator to power larger ones. Cordless tool rechargers without a wall cube transformer plug must have true sine wave inverter power, and may be ruined on modified waveform inverters.



# WIRING AN OFF-GRID HOUSE FOR ENERGY EFFICIENCY

**AC BREAKER BOX:** An inverter produces 120V or 120/240 volt AC. 120V only systems CANNOT utilize multi-branch circuit wiring.

**GENERATOR AC WIRING:** Power from the generator should go into the power equipment area on a separate wire, (never fed back through the same wire that carries inverter power out to the generator location). Mark this wire generator direct. This will supply generator power to battery chargers and/or the AC input connection of the inverter/charger. Do NOT connect the generator output directly to the house circuit breaker box because inverter power is connected there. The generator direct wire goes only to the AC IN terminals of the inverter and to any special generator direct outlets put in the power room for other battery chargers. Standby option on the inverter will automatically switch generator power through to house circuits when the generator runs. When the generator is shut down, household circuits automatically switch back to inverter power.

You may also want to run a generator direct wire to its own outlet in the garage, shop, or elsewhere, to plug in automobile battery chargers and block heaters, welder, air compressor, or any item run only on generator power. Also run a generator direct line for any 240 volt power needed from the generator, like a very deep well pump. No need for separate generator and inverter wiring elsewhere in the home, because generator power automatically comes through the regular wiring when the generator runs.

**METERING WIRES** in the home should be kept away from AC wires because all inverters can create some level of interference. Make sure to use shielded, twisted pair for telephone and meter wiring to minimize the effect of cross talk and noise.

**SMOKE DETECTORS** should be battery powered only, if possible. They are available with 10-year lithium batteries. Hard wired smoke detectors are constant loads and should be included in any load calculations.

**FOR SMALL HOMES, CABINS or RVs:** Consider using a few DC circuits in the house for those items that can save energy by using DC power directly from the battery. Items such as: rechargeable flashlights, cordless tools, standard doorbell, motion sensing lights at entrances, 2-way radio, and portable stereo. DC-powered energy-saving refrigerators, water pumps, fans and ceiling fans as well as DC hot water circulating pumps used for floor heating systems also need their own DC circuit.

**24 OR 48 VOLT SYSTEMS CAN GIVE 12 VOLT POWER** by using a voltage converter.

**DC OUTLETS** are not standardized. Beware of the old RV cigarette lighter plug. They are poor quality and don't meet building code in houses. Use standard 240 volt 20 amp AC outlets (like 120 volt except one prong is turned sideways). These may pass code inspection used as DC outlets if there are no actual 240 volt outlets in the same house. They fit the same outlet boxes and cover plates as regular 120 volt AC outlets, and easily attach to wire with a screwdriver.

To figure the correct wire size for 12 and 24 volt DC circuits, use the wire size chart in this catalog. (Stranded wire or solid wire of the same gauge carry the same amperes, AC or DC).



The Hatcher Family

Larger gauge wires may be needed from the solar module area to the battery room. A battery monitor meter like the M-TRIMETRIC can be located remotely in the living area by running 4-conductor twisted pair intercom wire. A 4-conductor 14 to 18 gauge cable for a control to start and stop the generator from the house or shop is also adequate. Also, wire a generator start control to the battery room because some inverters can start the generator automatically when battery charge is low. Remember, all the usual extras are more difficult to add after the house is built: TV cables, telephone wires and outlets, speaker wires for stereo, doorbells, intercom, alarm or any other special wiring.

## THE IMPORTANCE OF BATTERY MAINTENANCE

IN ORDER TO MAINTAIN PROPER FUNCTION, BATTERIES REQUIRE MANAGING. Most battery types MUST get fully recharged each week, and never get discharged below 50 percent.

If there is a shortfall in power due to extended no-sun weather the generator can be run to supplement them. Flooded batteries require regular maintenance. Every month or two, all battery cells should be checked with a hydrometer, a glass tube and rubber bulb device with a float, that reads the condition of battery fluid. At the same time, the battery tops should be wiped clean and dry with a paper towel. Several times a year, check every cell, and add distilled water to the battery cells to maintain the correct fluid level. An extra charge process called “equalizing” is sometimes required to restore weak battery cells to normal.

Sealed batteries, such as AGM, Gel and Lithium-Ion do not require the same maintenance as flooded batteries and should never be equalized. Routine and strict monitoring of equipment that measures state-of-charge and battery health should be done continually.

Batteries have limited life, and need to be replaced every 5 to 17 years (depending on type) no matter how well the batteries are treated.



# IMPORTANT DECISIONS

## 12 VOLTS, 24 VOLTS, or 48 VOLTS?

Battery voltage is difficult to change after your system is built. Choose carefully. Many times the size of the system will dictate system voltage based on component configuration.

### **12 volt battery systems**

- Simple and standard in most vehicles, RVs, and boats
- For small, simple power systems
- Can be used directly in very small systems or add 120 volt AC with an inverter

### **24 volt battery systems**

- Use with systems of more than 720 watts of solar modules
- Wires can run longer distances, use to accommodate:
  - Solar modules over 75 feet from your home
  - Wind generator or hydro turbines over 300 feet
- Most power will be changed to 120 volt AC power. Voltage converters are available to run 12 volt DC equipment from 24 volt batteries

### **48 volt battery systems**

- Use with systems where wire runs of up to 400 feet are necessary
- 48 volt inverters have higher wattage output; and well-suited for larger power systems
- Converters are available to get 12 volts DC from a 48 volt battery

MPPT type charge controllers can allow higher voltage solar arrays to transmit their power more efficiently and from longer distances. This allows the array to be placed in the best location producing the most power possible. These controllers maximize the system's output, saves wiring costs and properly charges the lower voltage battery system (12, 24 or 48V).

## SEPARATE COMPONENTS vs POWER PANELS

Whether to purchase SEPARATE COMPONENTS or a PREFABRICATED POWER PANEL (sometimes called a POWER CENTER) is the other decision that needs to be made at the outset. The power centers may cost a little more than separate hardware components of equal quality but they can save as much in cost of design and installation and may extend any product warranty. Either way, UL listed components are necessary to pass electrical code inspections. Separate components are suitable for small systems but expansion when your power needs increase is neater, safer and easier with a prefab power center. With a prefabricated power center your power room will consist of just 3 components:

- Inverter/charger
- Power center with charge controller
- Batteries

# SIZING OFF-GRID SOLAR POWER



**LET'S BEGIN** by finding the right size and cost for your power system. There is flexibility in design because the power you receive varies with seasonal changes in weather. Your own flexibility in energy usage, plus use of a backup generator allows you to adapt to temporary shortages, and the automatic charge control manages any overproduction.

**CALCULATE** how many watt hours you will need. Then find the number of solar modules to produce that much power in your climate. See the worksheet on page 18 to get an idea of the equipment you need. We also offer books at the end of this catalog which may help guide you through this calculation more easily.

**SIX EXAMPLES** from smallest to largest power systems are described and priced on the pages ahead. Identifying with one of these expandable designs is the **FASTEST** way to start. We will customize each example to fit your needs!

**VISIT INDEPENDENTLY POWERED HOMES** in your area. Notice what works for folks with a lifestyle, family size, home, and climate like your own. The amount of electricity needed depends on the number of people in the house, their hobbies, business activities and conservation habits. Ask about their use of special energy-saving appliances.

**CALL/EMAIL US AT BACKWOODS SOLAR.** We will be glad to personally help you estimate your power and solar equipment needs. Write, call, or visit with us to discuss your lifestyle needs and let us suggest a power system.

Phone (208) 263-4290 / Monday thru Friday - 8am-5pm (Pacific)  
Email: [info@backwoodssolar.com](mailto:info@backwoodssolar.com) / Website: [www.backwoodssolar.com](http://www.backwoodssolar.com)

# SIZING OFF-GRID SOLAR POWER

## STEP I: CALCULATE HOW MUCH POWER YOU WILL USE

Start by finding how many watts each appliance will consume. Do not add appliances that should be propane fueled, such as cooktops, hot water heaters and electric heat.

Then multiply rated wattage of each appliance by the number of hours per day, on average, that appliance runs. This gives the total watt-hours per day for each light or appliance. Do this for each and every appliance. The total for all appliance loads is the total watt-hours needed each day.

Figures below show some appliances commonly used in independent solar homes. Substitute your own daily hours for each and add other appliances not listed. Refrigerators come on and off on demand by thermostat, so running time per day is not known. Our M-KILLAWATT meter (page 116) will accurately test watt-hours used per day for any AC appliance up to 1875 watts.

APPLIANCE EXAMPLES	WATTS	RUN TIME (HOURS/DAY)	WATTHOURS USED/DAY
Microwave oven average size	1260	1/4	315
Microwave, small, with timer knob	900	1/4	225
Food blender or processor	200	1/20	10
Toaster	1200	1/10	120
Coffee Maker	300	1	300
Clothes washer standard	700	3/4	525
Clothes washer	200	3/4	150
Vacuum Cleaner	550	1/4	138
Electric blanket	180	4	720
Refrigerator/freezer, Energy-Star			1000
Small apartment refrigerator 4 cu. ft.			945
12/24V NovaKool 4CF w/ added insulation			300
10 cu. ft. freezer, standard			1000
Window air conditioner, small	660	6	4000
Ceiling fan, AC	60	6	360
Ceiling fan, 12/24V DC	5-20	6	30-120
Well pump 120V AC (100 gal/day)	1000	1/3	350
Water well pump DC, 100 gal/day	100	1	100
Incand. 60 watt light (not recommended)	60	4	240
CF bulbs equal to 60 watt bulb	15	4	60
LED bulbs equal to 60 watt bulb	5	4	20
Computer	100	4	400
Laser jet printer, in operation	90	1/4	23
19" color TV	85	3	255
32" LCD TV	140	3	420
Satellite receiver	20	3	60
Quality stereo	40	4	160

# OFF-GRID SIZING WORKSHEET

AC Loads	Watts	X	Hours/Day	=	Watt hours/day
		X		=	
		X		=	
		X		=	
		X		=	
		X		=	
		X		=	
		X		=	
		X		=	
		X		=	
		X		=	
		X		=	
<b>Total AC watt hours per day (A)</b>				=	

DC Loads	Watts	X	Hours/Day	=	Watt hours/day
		X		=	
		X		=	
		X		=	
		X		=	
		X		=	
		X		=	
		X		=	
		X		=	
		X		=	
		X		=	
		X		=	
<b>Total DC watt hours per day (B)</b>				=	

**Add (A) total and (B) total together to get TOTAL WATT HOURS PER DAY.**

# SIZING OFF-GRID SOLAR POWER

## STEP 2: CALCULATE THE ARRAY SIZE

Once you've determined watt-hours, there are many methods used for calculating your systems solar array size. Traditionally off-grid systems are sized using a worst case scenario of sun hours for December 21st, the shortest day of the year. This insures that the system will give the power needed on the lowest sun production day and any other day will exceed this output. We have found many instances with our customers where this doesn't always fit the need of the system's load usage or budgetary constraints that someone might have (i.e: winter homes, summer homes, acceptance of longer generator run time, etc).

What we have found is that we can get a good idea of system size using the following thought process and modify from here for special circumstances.

On a fully sunny day, each solar module produces the equivalent of, on average, 5 hours of its maximum charging ability. Theoretically, this calculation tells us how many rated watts of solar modules are needed to produce a day's energy from a day's sunshine. Additionally, multiply this figure for the module derating and losses throughout the system (temperature losses, wire loss, inefficiencies in components, etc.). We recommend using a multiplier of 1.5.

Since all locations have different amounts of sunny days we must add a percentage to make up for cloudy, short winter days. The percentage to add for areas in the 48 states is shown on the U.S. map below.

This final number is the total rated solar watts needed to meet your level of energy consumption on average in your climate. Because weather changes year to year, and because seasons vary more in some areas than in others, this estimate is a rough figure, but close enough to work. This process is explained in more detail, with work sheets, and in books listed in back of this catalog. If sizing a system for a home with utility power, please reference page 24.

For battery sizing, please review page 81 and the worksheet on page 158.

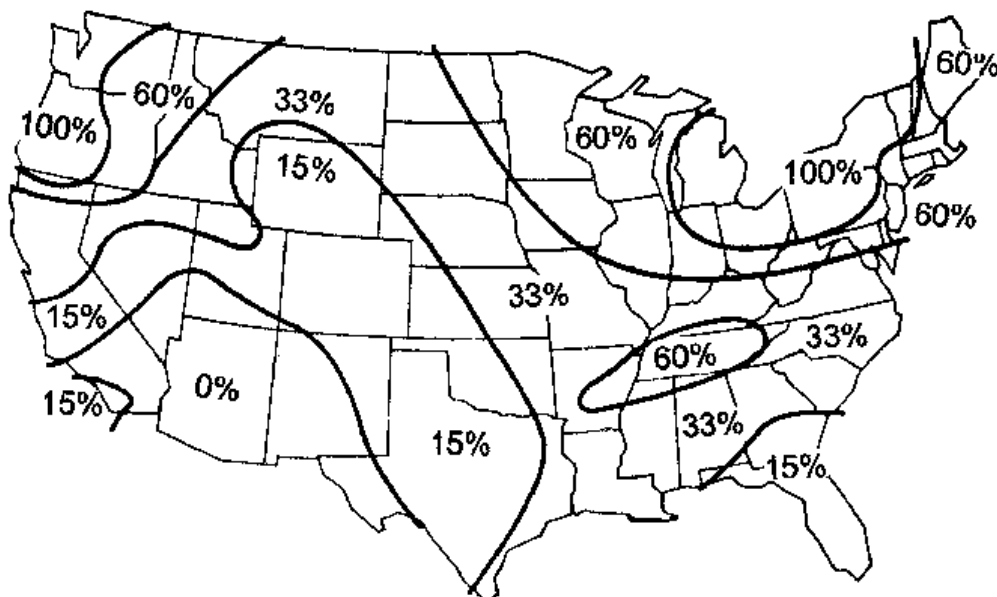

# SIX OFF-GRID EXAMPLES

These six examples are not packaged kits, but suggestions of well-balanced power systems to fit several levels of life-style and budget. Each is flexible in equipment choices. It's easy to start from one of the examples and make changes for your specific needs. Most people shopping at Backwoods Solar fit the middle examples #2 through #5.

There is a lot of wiggle room, based on either budget or what components you want to adopt at a certain time. Solar modules can be added any time, and a backup generator can supplement charging when there is a shortfall. You can start with a small system for a weekend cabin or a beginning family budget. When the family grows or the cabin becomes a full time home, more solar modules can be added. Smaller systems may start with a less expensive battery bank that will last for four to five years; and then upgrade to a more expensive high-capacity battery bank for a long term 10 – 15 year storage application.

Given how affordable solar modules have become, we always recommend including PV when designing/purchasing a system. Even partial solar charging avoids battery problems and saves generator time by adding many hours of slow and easy charging.

EXAMPLES 1 THROUGH 6 ARE EACH DEFINED BY THE DAILY AMOUNT OF POWER THEY WILL SUPPORT. Kilowatt-hours per day listed for each is a calculation of usable power produced on a sunny day in an average U.S. location. Summers will be higher & winters will be lower, depending on climate. The description of life-style and benefits with each example is based on experience with customers in the northwest U.S. climate. That same solar array will produce much more energy if located in the desert Southwest with more hours of sunshine.

COST for each example varies between the low and high shown, depending on specific choices among the equipment suggested.

- Included are the cost of battery cables, inverter cables and other incidentals that you will need in the power room that we can provide.
- Also included in the solar cost amount are required post mounts, which could be lower if roof mounts are used. Piping for post mounts is not included.
- Shipping and tax (where applicable) are not included in the total.
- Backup generators cost varies widely from \$3,500 to \$10,000. Many of our customers already own a generator. That cost is NOT added to the total in the examples, and you may need to allow for purchase of a backup generator.

# EXAMPLES

## #1 TINY/MOBILE HOME POWER SYSTEM

**\$1,200 - \$4,800**

**Produces about .25-1.0 usable kilowatt-hours on a sunny day**

Minimum solar power for a small cabin, motor home, boat, or weekend retreat. A very conserving person can start with 60 - 125 watts of solar to power a few 12V lights and stereo. Closer to 250 watts of solar allows a lot more lighting, a 12V TV, 12V water pressure system and a small modified wave inverter for some power tools and non-sensitive electronics. Northern winters will require backup charging with a generator. One or two pairs of 6V deep cycle golf cart batteries make a 12V set.

SOLAR ARRAY SIZE: 60 - 200 Watts - Using smaller 60W to 100W, 12V module(s)

CHARGE CONTROL: 12-35 Amp PWM Controller

METERS: Trimetric Battery Meter, optional but recommended

HARDWARE: QO DC Breaker box or MidNite Inverter disconnect, solar and inverter fuses and connecting wires, as needed

BATTERIES: 2 - 4 Trojan T-105s and cables

INVERTER/CHARGER: None or a mid-range inverter like the Samlex 1200W 12V EVO-F SineWave Inverter

Recommended Generator: Honda EU3000

## #2 CONSERVING COTTAGE

**\$4,000 - \$10,000**

**Produces about 1.5 - 3.0 usable kilowatt-hours on a sunny day**

This conserving cottage power system runs high efficiency lighting, TV, stereo & DC water pumping. The AC power inverter runs TV, DVD or satellite receiver, stereo, and limited use of vacuum, hand held power tools, computer, blender and DC powered well pump. An AC generator is used for large appliances like clothes washer, AC deep well pump, and gives extra charge to the battery at the same time. Battery can be 12V but should be 24V if expansion is intended. If you have high end electronics that are sensitive to modified wave inverters make sure to choose a sinewave option.

SOLAR ARRAY SIZE: 300-600 Watts: Using 60 cell modules in excess of 250W each

CHARGE CONTROL: 30A or 60A MPPT Controller w/ Temp Sensor

METERS: Trimetric Battery Meter

HARDWARE: MidNite inverter disconnect, solar and inverter fuses and connecting wires as needed, MidNite lightning protection

BATTERIES: 12V or 24V battery bank consisting of (6) T105s or up to (8) L-16RE-Bs, cables and venting

INVERTER/CHARGER: Magnum MS2812, 2800W 12V Sinewave Inverter with RC50 Digital Display Remote or MS4024 24V Sinewave Inverter

Recommended Generator: Honda EU3000 or larger

# EXAMPLES

## #3 CONSERVING FAMILY HOME \$9,000 - \$15,000

**Produces about 4-6 usable kilowatt-hours on a sunny day**

Year round home for 1 to 3 people. Provides 120V AC power for lighting, vacuum, washer, kitchen appliances & microwaves, DC or 120V AC well pump, color TV, DVD, satellite receiver, stereo, computer and hand-held power tools. There can be enough power for a small DC refrigerator in sunny climates. In northern winters, the generator supplements battery charging while using high load appliances, such as a washing machine. We would recommend that this system should be set up with a 24V or 48V battery bank and an automatic generator start for battery charging should be considered.

SOLAR ARRAY SIZE: 800-1200 Watts: Using larger 60 or 72 cell modules in excess of 250W each

POWERCENTER: Magnum Mini-Panel system (240V) with 4000W, 24V or 48V sinewave inverter, 60-80 Amp MPPT charge controller, RC50 Digital Display Remote (or ARC50, if you want auto-gen start), string combiner, MidNite lightning protection and all cabling

METERS: Trimetric Battery Meter (or an integrated BMK with the inverter)

BATTERIES: Eight to sixteen L-16s and cables

Recommended Generator: Honda EU7000 or larger

## #4 ACTIVE FAMILY SOLAR HOME \$13,000 - \$25,000

**Produces about 6-10 usable kilowatt-hours on a sunny day**

More power for a family of 3 to 4, or a home office. Includes the loads in Example #3 plus power for a high efficiency refrigerator or energy efficient chest freezer as well as extensive computer use. Washing machine and 120V well pump run from inverter AC, but uses generator back-up if weather remains overcast. 48V battery is recommended, especially if future expansion is planned. Systems of this size typically utilize industrial class batteries.

SOLAR ARRAY SIZE: 1200-2000 Watts: Using larger 60 or 72 cell modules in excess of 250W each

POWERCENTER: Magnum Mini-Panel system w/ 4400W, 48V sinewave inverter, 60-80 Amp MPPT charge controller, RC50 Digital Display Remote (or ARC50, if you want auto-gen start), string combiner, MidNite lightning protection and all cabling

METERS: Trimetric Battery Meter

BATTERIES: Eight to sixteen L-16s or Rolls/Surrettes and cables

Recommended Generator: Honda EU7000 or larger



# EXAMPLES

## #5 LARGE HOME / SMALL BUSINESS \$28,000 - \$40,000

**Produces about 12-18 usable kilowatt-hours on a sunny day**

This system can run a small home business with office and computers all day, work bench and shop tools. Plus all the usual residential power described in Example #4. 48V is recommended for battery voltage. Includes automatic generator start as batteries or loads require. A 48 volt system requires 6-volt batteries in multiples of 8. This example is simplified by factory assembled equipment.

SOLAR ARRAY SIZE: 2400-3600 Watts: Using larger 60 or 72 cell modules in excess of 250W each

MAGNUM PANEL or an integrated power system with 1 or 2 inverters and MPPT charge controllers, MidNite lightning protection, meters, etc.

BATTERIES: Surrette 4KS2IPS

Recommended Generator: Honda EU7000 or larger

## #6 HIGHER POWER SYSTEM \$45,000 - \$53,000

**Produces about 16-24 usable kilowatt-hours on a sunny day**

This example provides for substantially more power for a large family home and business, cottage industry, art studio, or shop. Backwoods Solar, when owned by the Willey's, eventually upgraded to 3000 watts of solar to relieve their sun-less winter power shortage and reduce generator running time. Resulting summer surplus allowed a small window air conditioner during peak sun hours. True sine wave 7000 watts of AC power with both 120 and 240 volts. Choose a 48 volt battery bank.

SOLAR ARRAY SIZE: 3200-4800 Watts: Using larger 60 or 72 cell modules in excess of 250W each

MAGNUM PANEL or an integrated power system with 1 or 2 inverters and MPPT charge controllers, lightning protection, meters, etc.

BATTERIES: Surrette 4KS25PS

Recommended Generator: Honda EU7000 or larger

# CRITICAL LOAD SYSTEMS

## HOMES WITH UTILITY POWER THAT ALSO WANT BACK-UP FOR OUTAGES

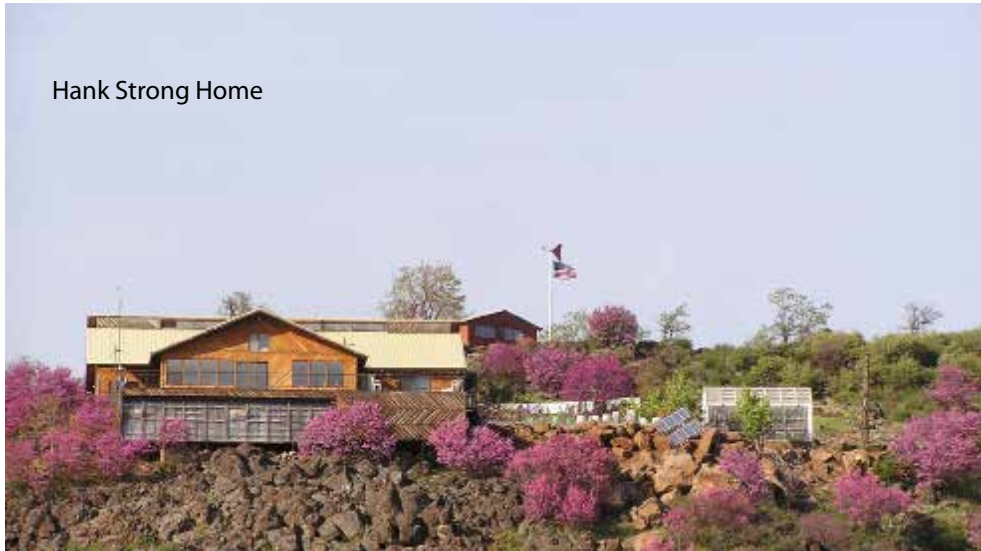

Backwoods gets more and more calls each year from folks that have homes with utility power, but are also searching for a solution to seasonal or emergency power outages. It may only be called upon a couple times per year, but they want the peace of mind that a few key critical loads in their household (such as refrigerator, lighting, well pump, or an outlet to charge cellphones) will keep running until utility power is restored. Critical load systems are typically NOT used for net-metering, or selling extra power back to the grid. The arrays are typically sized smaller for the application, and would not justify the additional cost of components to implement the net-metering.

Honestly, a good generator is a great solution. A simple Honda generator and a 5 gallon gas can can really serve well in these cases. Most people have realized that, but some want a more robust solution, so call us to see what we can recommend.

Critical load systems are essentially battery based solar electric systems, sized only to support the designated loads that the homeowner chooses. This keeps the cost and size of the system much more manageable versus sizing a system to support the entire household. The circuits for the critical loads are isolated to a secondary breaker panel separate from the main house panel. This secondary panel is then the tie-in point for the new Critical Load System.

The system would have all the components of an off-grid system; solar panels charging a battery bank, with an inverter drawing power off the batteries to run the critical loads. By using an inverter with a built-in battery charger, the critical load system itself can be backed up by a generator, or even utility power when present. There are a number of options to choose from on how to balance and operate such a system depending on the application.

# CRITICAL LOAD SYSTEMS

Several options exist in a Critical Load system's design and operation. One of the simplest configurations would consist of a properly sized inverter/charger operating with a set of sealed batteries. Utility power is provided to the inverter which then holds the battery bank in a float state, only to be called upon during outages. The inverter also passes through the utility power to run the loads on a day to day basis. During a utility outage the inverter switches automatically to the battery power to run the loads. The battery bank can be sized to support however many days of reserve capacity are desired. Sealed batteries are a good choice for this type of stand-by application where the batteries are held at float most of the year, only to be called upon occasionally. A configuration like this doesn't necessarily even need solar panels. You avoid the extra cost, but are limited to the back-up capacity of the battery bank. Or, add the solar panel component in the future as budget allows.

Another option would be to configure the system operation to run just like an off-grid system. Solar panels and battery power would be used on a daily basis, cycling the batteries a bit each day. Utility power, or a generator, would only be called upon during extended periods of overcast weather. This type of configuration is well served with flooded lead acid batteries that like to see a bit of daily exercising, and have a lower cost than their sealed counterparts.



Give us a call at Backwoods to discuss system sizing and options for your critical load application.

# GRID-CONNECTED SYSTEMS

## HOMES WITH UTILITY POWER

### LOWER OR ELIMINATE YOUR UTILITY BILL

Many people ask about switching their home to independent power to get rid of their utility bill.

In parts of the country where electricity prices are high, installing a grid-connected solar system is actually a good financial investment. Determining the kilowatt-hours consumed for a full year by looking at utility bills will make it easy to determine the cost of a solar power system that will eliminate or reduce the utility bill. Every kilowatt of grid-connected solar will deliver 1,000 to 1,500 kilowatt-hours of electricity per year.

Often our customers want their lives and their homes to demonstrate clean, renewable energy use, even where utility lines are easily available. The use of clean energy sources in places where conventional energy is available, educates our society about the reality of clean energy.

- Most states allow net metering, which means the electric meter will run backwards when more power is being produced than consumed. A credit for surplus electricity from sunny days can be used on cloudy days or at night when power is not being produced from solar.
- Many states offer rebates for installing solar power and the federal government offers grants and tax credits of up to 30% of the cost of the system. If the system is installed on a business there are more tax advantages.
- State incentives can be found by logging onto [www.dsireusa.org](http://www.dsireusa.org). This website has the most up to date information as well as links to many state and local organizations.
- Net metering can vary by each utility and in each state. Many of these programs and incentives require that a certified electrician sign off on the final installation and actually commission or turn on the system.
- Most utilities require an interconnection agreement that outlines specific requirements that utility has in regards to safety measures, power quality, permitting, insurance, net metering credits and billing.
- When installing a grid-connected system, it will need to be inspected and all components should be UL listed.
- Not having UL products can void a homeowner's insurance policy.
- All of the products that Backwoods carries for grid-tie installation are approved for this purpose and have UL or ETL listings.

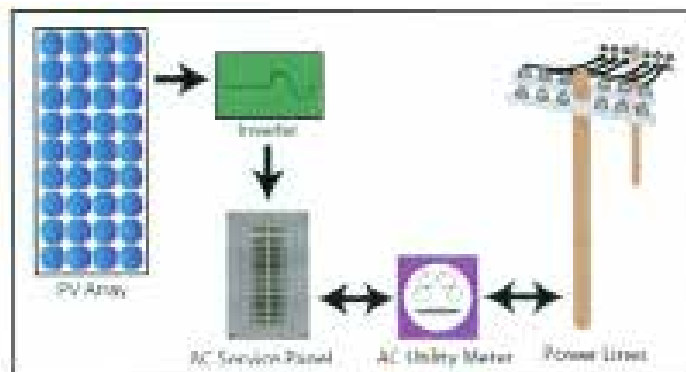

# GRID-CONNECTED SYSTEMS

## GRID-CONNECTED SOLAR SYSTEMS ARE VERY DIFFERENT THAN OFF-GRID SYSTEMS

- Most grid-connected systems do not use batteries, which is normally the part of an off-grid system that requires maintenance and eventually wears out.
- The utility serves the function of the system battery. Without a battery, costs are much less and operation is simple. However, a battery-less system does lose power anytime the utility has an outage.

## BACKUP FOR UTILITY POWER OUTAGE

- Usually solar modules are not needed in utility backup systems, because sunshine tends to be scarce when weather knocks out utility lines.
- Systems with standby inverter and battery system can automatically support a few selected emergency needs during short utility outages. Batteries are kept at full charge by utility power until an outage, at which time the inverter automatically takes over the selected emergency needs.
- A quiet, durable propane fueled generator set with a manual or automatic transfer switch can power the whole house during hours, days or even weeks of power outage emergency.
- No major conservation or wiring changes in the home will be required (but it is wise to add several propane fuel direct-vent room heaters).
- A local licensed electrician should install the transfer switch between a generator and the utility served circuits.
- Our Schneider Conext XW+, Outback VFXR/FXR systems and a battery bank are a complete package for backup power. When solar modules are added to the design it also offers you the opportunity to sell power to the grid.

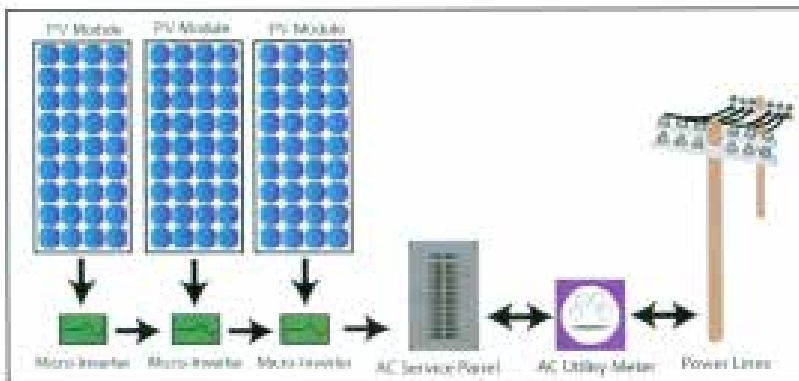

GRID TIE SYSTEM w/ MICROINVERTERS & WITHOUT BATTERIES

# SAFETY AND LOCAL HELP

Building codes differ throughout the world but a safe and neat job is paramount. The reputation of renewable energy and the resale value of the home are at stake. Learn about battery safety, fusing and grounding for your home. The owner-builder ultimately takes responsibility for the safety of the home by following building/electrical codes as well as individual responsibility and competence.

## FUSING, at a MINIMUM, is ESSENTIAL FOR FIRE SAFETY

- A fuse or circuit breaker is required for every single wire, large or small, connected to the positive of the battery. Un-fused wiring can start fires.
- Rework existing wiring that is unsafe or not properly fused. We can supply circuit breakers and power centers that are UL listed, as well as low priced separate fuses and holders (which will not pass code inspection unless installed in metal enclosures).

## BUILDING INSPECTORS

- Photovoltaic powered homes are included in the National Electric Code.
- Smaller homes in remote areas are often ignored by building inspectors where there may be no local codes. In other areas, electrical inspectors do enforce wiring codes on every house with wires in it, no matter what the power source or voltage.
- It is a good idea to find out how 'off grid' homes are treated in a specific area. Cost of rewiring is much higher than the cost of doing it right the first time.
- Some off-grid items in this catalog may not pass building inspection in some areas.
- Where strict electric codes are required, the easiest way is to follow the inspector's advice and use UL listed power centers and breaker boxes.

## GET HELP AS NEEDED

- Some electricians may not be familiar with low voltage equipment, but they can certainly help with installation of conduit, underground cable, and wiring the home safely.
- See website <http://www.dsireusa.org/> for information on state loans, financial incentives, and tax breaks for solar installations throughout the United States.
- Classes: Solar Energy Int'l in Paonia, CO offers hands-on training in several locations. Phone (970) 963-8855 / Email [sei@solarenergy.org](mailto:sei@solarenergy.org) / Internet at <https://solarenergytraining.org/>.

# SIZING A GRID-TIE SYSTEM

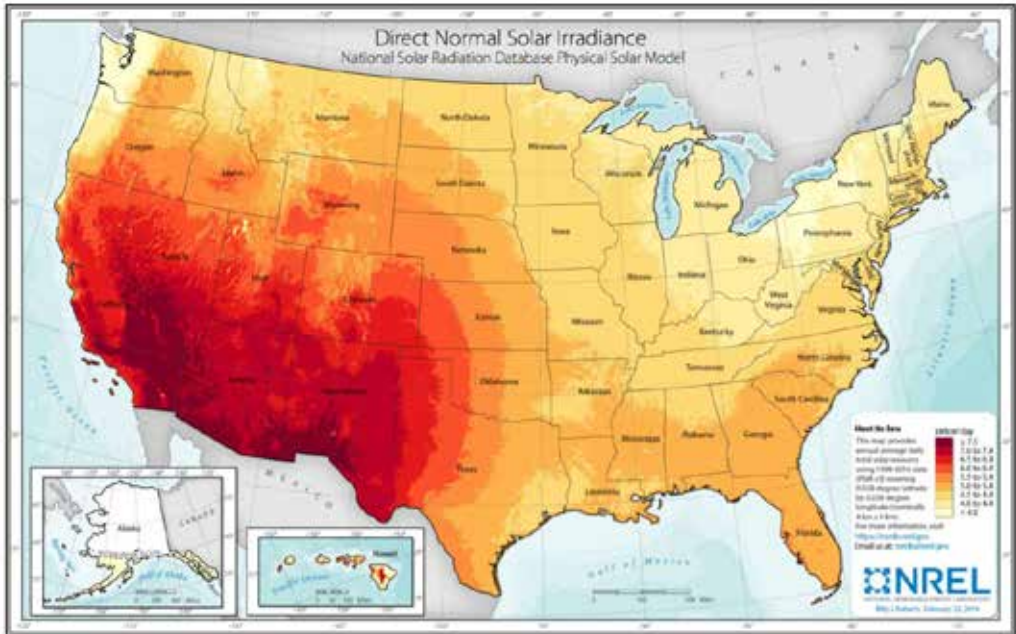

Determining the size of a grid-tie system is much easier than an off-grid system as the utility company has kept all of the records. Start by finding out how many kWh are used, on average, per month, and creating a system that would cover the entire electricity bill. Once completed, this can be surprising on how large a system is needed. Ground and roof space may not support the solar array. There may be ways to cut down on electric use. Changing out appliances may also help. If the utility has a tiered billing structure where there is a billed rate for baseline usage, and then higher rates for a percentage of power used above the baseline, a solar system may be built to eliminate the overages.

The following steps will help determine the size of system needed:

1. Find a monthly average electrical usage from the electricity bill.  
This will be listed in kilowatt hours (kWh). \_\_\_\_\_
2. Find the daily average electric use.  
This will be your monthly average kWh divided by 30. \_\_\_\_\_
3. Find the sites average peak sun hours per day  
The above map has rough figures. \_\_\_\_\_
4. Calculate the system size (kW) to cover 100% of the electric bill  
Divide your daily average electric use in #2 by the figure in #3. \_\_\_\_\_
5. Divide the result in #4 by .7 to get a derate factor for the components  
in the system. This takes into consideration temperature, wire loss,  
component inefficiencies, etc. \_\_\_\_\_
6. Multiply thr result in #5 by 1000 to get watts of system. Divide the  
wattage of the module that will be used into this number to determine  
the number of modules needed. \_\_\_\_\_



A SOLAR MODULE WORKS LIKE A CAR BATTERY CHARGER, EXCEPT INSTEAD OF PLUGGING IT INTO THE WALL, IT IS PUT IN THE SUN.

PHOTOVOLTAIC or solar cells convert sunlight directly to electricity within wafer thin cells. Light “particles” called photons actually bounce electrons across a barrier, creating an electrical current. 36, 60 or 72 cells are built into a 4 to 23 square foot solar module. Solar cells are sealed within a tough resin between a tempered glass front and plastic or foil backing, then framed in aluminum rail. Considering cost and long lifetime of modules, we stock the most proven and reliable brands.

DIRECT SUNSHINE with no shadows is absolutely necessary for full power. Partial power is produced on overcast days, but any shadows falling directly on a solar module will reduce power, regardless of what some advertisements claim.

DURABILITY: First used over 50 years ago for space satellites, modules of that vintage still operate unless the glass has been broken or water has entered the seal. Life expectancy of solar modules is over 30 years. Most photovoltaic modules come with a 20 to 25 year warranty on power output and may last a lifetime.

THE AMOUNT OF POWER a solar array produces depends on the number of modules used and the number of daily sunshine hours in the area. Overcast days with only half normal brightness give half of normal power. Some climates allow much more power in summer than winter. Solar modules can be easily added to an array to increase power as needs grow. Modules are rated by volts, watts, and amps. The WATT rating is the best indicator of the charging during ideal sun conditions.

***Module availability and pricing can change quickly. We've listed our most reliable module options with current pricing (at time of printing). For current pricing see our website or give us a call.***





# HELIENE MONO

## 300-310 Watt\*

Heliene modules are US-made in Minnesota. Standard industry size and electrical specs for a 60-cell module make them highly compatible with similar, existing panels or ideal for a brand new array.

All Heliene panels carry UL and CE certification making them viable for installations just about anywhere.

Module surface area is 17.60sf.

Minimum Requirements for battery charging:  
MPPT Charge Controller plus:

- 1 module for 12V systems
- 2 modules for 24V systems
- 3 modules for 48V systems



ITEM#	S-HELI-300	S-HELI-310
WATTS	300	310
CELLS	60	60
VOLTS (Vmp)	33.40V	33.44V
AMPS (Imp)	9.13A	9.66
OPEN CIRCUIT VOLTAGE (Voc)	39.83V	40.13
SHORT CIRCUIT CURRENT (Isc)	9.59A	10.22
SIZE	65" x 39" x 1.6"	65.5" x 39.4" x 1.6"
WEIGHT	43.9 lbs	48.5 lbs
WARRANTY	10 yr product / 25 years performance	
CELL TYPE	Mono	
FRAME	Anodized Aluminum (Black)	
BACKSHEET	Black	
CABLE TYPE	MC4 Connectors	
MODULE SIZE CATEGORY	"C"	
PRICE	\$240	\$256

\*Wattage classes and pricing are subject to change based on availability.

Discounts available for full pallet and truckload quantities. Just ask!  
THESE SHIP BY TRUCK FREIGHT ONLY. Call for freight quote.

# 24 VOLT MODULES



## HELIENE 370 Watt, 24V

Heliene Inc. is a premier solar module manufacturer, servicing the growing solar energy markets of North America. Now manufactured in Minnesota, Heliene modules combine proven European technology with North American ingenuity that allows Heliene to make a real commitment in providing smarter energy choices for the future.

Module surface area is 19.5sf.

ITEM#	S-HELI-370
WATTS	370
VOLTS (Vmp)	40.23V
AMPS (Imp)	9.26A
OPEN CIRCUIT VOLTAGE (Voc)	48.66V
SHORT CIRCUIT CURRENT (Isc)	9.77A
CELLS	72
SIZE	77" x 39" x 1.6"
WEIGHT	48.28 lbs
WARRANTY	10 yr workmanship / 25 yr power output
CELL TYPE	Mono
FRAME	Clear Anodized Aluminum
CABLE TYPE	MC4
MODULE SIZE CATEGORY	"D"
<b>PRICE</b>	<b>\$293</b>

# 24 VOLT MODULES

## SUN7SOLAR 190 Watt, 24V

The Sun7Solar 72-cell solar panels are built using highly reliable mono-crystalline solar cells to ensure peak efficiency and output.

Module surface area is 13.72sf.



ITEM#	S-GP-SOL190
WATTS	190
VOLTS (Vmp)	36V
AMPS (Imp)	5.28A
OPEN CIRCUIT VOLTAGE (Voc)	43.2V
SHORT CIRCUIT CURRENT (Isc)	5.88A
CELLS	72
SIZE	62.25" x 31.73" x 1.38"
WEIGHT	35.27 lbs
WARRANTY	10 yr workmanship / 25 yr power output
CELL TYPE	Mono
FRAME	Clear Anodized Aluminum
CABLE TYPE	MC4
MODULE SIZE CATEGORY	"B"
PRICE	\$190

THESE SHIP BY TRUCK FREIGHT ONLY. Call for freight quote.

# 12 VOLT MODULES

## VIKRAM 100 Watt

Vikram Solar offers a very reliable high quality 12V module at a very good price. The modules are manufactured with tempered glass and twin-walled anodized aluminum frames. A power rating tolerance of +5WP ensures a high return on the investment.



S-VK-100-PV4



ITEM#	S-VK-100-PV4
WATTS	100
VOLTS (Vmp)	17.99
AMPS (Imp)	5.57
OPEN CIRCUIT VOLTAGE (Voc)	21.84
SHORT CIRCUIT CURRENT (Isc)	6.11
SIZE	45.3" x 26.2" x 1.34"
WEIGHT	17.6 lbs
WARRANTY	5/25 years limited
COUNTRY	India
CELL TYPE	Poly
FRAME	Anodized Aluminum
CABLETYPE	PV4 Connectors
MODULE SIZE CATEGORY	"A"
PRICE	\$135

# SMALL PV MODULES

30 and 60 Watt, 12V



S-VK-30



S-VK-60

The Vikram 30 and 60 watt modules are tempered glass laminated and polycrystalline silicon based with a sturdy aluminum frame. Ideal for directly powering small DC fans, fountain pumps, and fence chargers. These modules have a junction box with attachment points. Warranty: 10 year limited.

ITEM#	S-VK-30	S-VK-60
WATTS	30	60
VOLTS (Vmp)	17.34V	18.04V
AMPS (Imp)	1.74A	3.33A
OPEN CIRCUIT VOLTAGE (Voc)	21.62V	21.66V
SHORT CIRCUIT CURRENT (Isc)	1.88A	3.67A
SIZE	25.6" x 15.8" x .7"	27.6" x 26.2" x 1.34"
WEIGHT	7 lbs	11.7 lbs
CELLS	36	
WARRANTY	5/25 year limited	
COUNTRY	India	
CELL TYPE	Polycrystalline Silicon	
FRAME	Anodized Aluminum	
CABLE TYPE	Junction Box	
MODULE SIZE CATEGORY	N/A	"A"
PRICE	\$44	\$85

These modules can ship via UPS in SMALL quantities. Larger quantities will ship via TRUCK FREIGHT. Call for freight quote.

# SOLAR MODULE LOCATION

Solar modules must be outdoors in open, direct sunshine facing the noon sun direction. Exposure to sunshine must be free of all shadows from trees, wires, buildings, etc. A shadow cast on a photovoltaic module will cut off much of its power (no matter what some advertisements claim).

Precise aim is not necessary. 95% of full power is produced within 20 degrees of the sun. As the sun rises and sets, modules aimed at the noon sun give full power from 10 a.m. to 2 p.m. Morning sun and late afternoon sun is less direct so less power is generated during these time periods. This means on a full sunny day, on average across the country, you can count on about 5 hours at a module's rated amperes.

Tilting to face the noon sun's elevation twice a year, spring and fall, produces more charging than fixed mounts. To shed snow, set winter tilt near vertical facing south. For fixed mounts, splitting the difference between summer and winter tilt angles will give the best average solar production from the modules.

As the solar industry has grown and changed, additional concerns surrounding the proper mounting of solar modules, especially in roof mount applications, have risen. Roof mounted solar arrays are the most common and many roofing companies have expressed concerns regarding how weatherproofing of installations is being handled. Maintaining the integrity of the roof, protecting all penetrations with proper sealants and flashing, and making sure that the roof itself is built to handle the load will assure the homeowner that the roof will not leak and will last the lifetime of the array. Some of the roof mounts we sell come with their own flashing and sealants. We highly recommend that if the modules will be mounted to a roof that has a warranty put in place by the roofing company, check to make sure the warranty will not be voided if modules are attached. Always use materials that will properly seal the roof penetrations and protect against leaks.



# TYPES OF SOLAR MOUNTS



Top-of-Pole Mount



Ground Mount



Roof Mount



Side-of-Pole Mount

POLE or POST MOUNTS in the yard can be adjusted seasonally. They more easily pass electric code than mounts attached to buildings. Avoid the very largest mounts in high wind areas.

FIXED GROUND MOUNTS are usually larger arrays that cannot be seasonally tilted (see previous page). We can help custom design large ground mount arrays. If the property is clear of shading and roof space is lacking room for a larger array, a ground mount might be the right direction to go. Some inspectors may require a fence to encompass the installation to protect people and animals from coming in contact with high voltage wiring.

ROOF TOP OR WALL MOUNTS can place modules high enough to avoid tree shadows. Chances of theft are less. Seasonal adjustment may be more difficult, and the electrical code may require a ground fault interrupter when installed on a dwelling.

RV MOUNTS - S-RVI mounts attach individual modules flat to the vehicle roof, or the S-RV RAILS hold 2 to 3 modules on a single rack attached to the roof only at 4 points. Tilting is not necessary if the RV follows sunny weather, but S-UNI-RV40 allows tilt-up on an RV.

# UNIVERSAL POST MOUNTS GENERAL SPECIALTIES



Made by General Specialties, the Universal Post Mount incorporates welded and galvanized steel framework with 6061 aluminum rails. Grade 5 and 8 stainless steel hardware is included for mounting PV modules. Adjusts easily to seasonal sun angle. Designed for 100+ mph wind load (35+ lbs/sq. ft.). Vertical steel base pipe is not supplied but is available at most hardware/lumber supply stores.



To use this chart, find the “UPM Size” on the module you’re interested in on pages 31-35 to determine the proper column. Follow the column down to find the number of modules you will be mounting on each post mount.

ITEM CODE & POST SIZE INFO	SIZE “A” Smaller 12V& 24V 26.5” x 59.5” (10.94 sqft MAX)	SIZE “B” Midsize 12V & 24V 32.5” x 62.5” (14.10 sqft MAX)	SIZE “C” Larger 60cell 39.5” x 65.5” (17.96 sqft MAX)	Size “D” Larger 72cell 39.2” x 77.1” (20.98 sqft MAX)
<b>UPM2X</b> For 3” post Sched 80 only	<b>\$408</b> 3 modules	<b>\$408</b> 2 modules	<b>\$408</b> 2 modules	<b>\$408</b> 1 module
<b>UPM3X</b> For 4” post Sched 40/80	<b>\$417</b> 3 modules	<b>\$417</b> 2 modules	<b>\$417</b> 2 modules	<b>\$417</b> 1 module
<b>UPM4X</b> For 4” post Sched 40/80	<b>\$594</b> 4 modules	<b>\$594</b> 3 modules	N/A	<b>\$594</b> 2 modules
<b>UPM6X</b> For 5” post Sched 40/80	<b>\$860</b> 6 modules	<b>\$860</b> 4 modules	<b>\$860</b> 4 modules	N/A
<b>UPM6X-CUSTOM</b> For 5” post Sched 40/80	N/A	N/A	<b>\$860</b> 3 modules	<b>\$860</b> 3 modules
<b>UPM8X</b> For 6” post Sched 40/80	<b>\$1089</b> 8 modules	<b>\$1089</b> 6 modules	N/A	N/A
<b>UPM10X</b> For 6” post Sched 40/80	<b>\$1374</b> 10 modules	<b>\$1374</b> 8 modules	<b>\$1374</b> 6 modules	<b>\$1506</b> 4 modules
<b>UPM10X-HD</b> For 6” post Sched 40/80	<b>\$1763</b> 12 modules	<b>\$1763</b> 10 modules	<b>\$1763</b> 8 modules	<b>\$1894</b> 6 modules

UPM6X and larger must ship via FREIGHT TRUCK.  
Please call for a quote.



# UPMs FOR LARGE ARRAYS GENERAL SPECIALTIES



**Absolutely the strongest mounts available for our full size modules**

**Built to last a lifetime**

**Includes easy to follow instructions**



ITEM CODE & POST SIZE INFO	SIZE "C" Larger 60cell 39.5" x 65.5" (17.96 sqft MAX)	Size "D" Larger 72cell 39.2" x 77.1" (20.98 sqft MAX)
<b>UPMI2X-HD</b> 9 modules use 8" post Sched 40/80, 10 modules use 8" post Sched 80 only.	<b>\$3515</b> 9-10 modules	N/A
<b>UPMI2X-HD-D</b> For 8" post Sched 80 only	N/A	<b>\$3869</b> Call to confirm fit
<b>UPM 15X</b> For 8" post Sched 80 only	<b>\$3958</b> 12 modules	<b>\$4136</b> Call to confirm fit
<b>UPM 18X</b> For 8" post Sched 80 only	<b>\$5269</b> 15 modules	<b>\$5446</b> Call to confirm fit

All of the UPMs on this page must ship via FREIGHT TRUCK. Please call for a quote.

Some installations may require a larger diameter pipe than listed above for any mount sized 10XHD or larger. An upgraded gimbal will need to be purchased to accommodate the larger pipe. Must be ordered with mount.	Price
Upgrade 6" pipe gimbal to 8" pipe gimbal	<b>\$264</b>
Upgrade 8" pipe gimbal to 10" pipe gimbal	<b>\$456</b>

**INSTALLATION RECOMMENDATIONS:** The diameter and schedule of pipe required will depend on the height of the pipe above and below ground and the model number of the mount. Your local building department may require the foundation for a PV array to be designed by a locally licensed structural engineer. Please contact us for more information or a copy of the manufacturer's pole and foundation instructions. A professional installer and your local building department should be consulted for the safest and most effective installation.

# TAMARACK TOP-OF-POLE

Tamarack Solar Pole Mounts are designed to install quickly and provide a secure mounting structure for PV modules. The intuitive design is easy to learn and provides for a fast and easy installation.



Using pre-galvanized steel and heavy-duty corrosion-resistant 5000 series aluminum components, these top-of-pole mounts are built to last. Most are wind-rated up to 150MPH and can withstand snow loads up to 50 lb/sq.ft, depending on tilt angle. In addition, seasonal adjustability for maximizing energy production is provided by several tilt-angle settings. A wet stamp engineering packet is available upon request.

Tamarack’s “Universal” Large Top-of-Pole mounts can easily hold any larger 60-cell or 72-cell module with dimensions less than 79.5” x 39.5”. Using a single 4” or 6”, Sch 40 steel pipe, modules less than 79.5” x 39.5” can be mounted without complex sizing calculations.

For a fast and easy way to determine which Tamarack Solar pole mount product is best suited for a particular application, please give us a call. Vertical steel base pipe is not supplied but available at most hardware/lumber supply stores.

ITEM #	Pole Size	Most “C” modules	Most “D” modules
<b>S-TSP-STP045</b>	4”	<b>\$452</b> - 1 module Landscape	<b>\$452</b> - 1 module Landscape*
<b>S-TSP-STP060</b>	4”	<b>\$465</b> - 1 module Portrait	<b>\$465</b> - 1 module Portrait
<b>S-TSP-STP082</b>	4”	<b>\$518</b> - 2 modules Landscape	<b>\$518</b> - 2 modules Landscape
<b>S-TSP-STP120</b>	4”	<b>\$663</b> - 3 modules Landscape	<b>\$663</b> - 3 modules Landscape
<b>S-TSP-LTP082</b>	6”	<b>\$1425</b> - 4 modules Landscape; 2 columns	<b>\$1425</b> - 4 modules Landscape; 2 columns
<b>HIGH WIND MODELS</b>			
<b>S-TSP-STP082-HW</b>	4”	<b>\$802</b> - 2 modules Landscape; 1 column	<b>\$802</b> - 2 modules Landscape; 1 column
<b>S-TSP-STP124-HW</b>	4”	<b>\$1005</b> - 3 modules Portrait; 1 column	<b>\$1005</b> - 3 modules Portrait; 1 column
<b>S-TSP-LTP082-HW</b>	6”	<b>\$1725</b> - 4 modules Landscape; 2 columns	<b>\$1725</b> - 4 modules Landscape; 2 columns
<b>S-TSP-LTP124-HW</b>	6”	<b>\$1985</b> - 6 modules Portrait; 2 columns	<b>\$1985</b> - 6 modules Portrait; 2 columns

HIGH LOAD ADDER KITS are available for LTP082 (\$462) and LTP124 (\$609) mounts.  
\* Center to center holes on frame must be less than 47”

# TOP-OF-POLE MOUNTS FOR SMALLER ARRAYS



Tamarack Solar's Top-of-Pole mounts for smaller arrays are a heavy duty mounting system ideal for single pole, multi-panel arrays. Mounted atop either 4" or 6" poles, this system supports modules from most manufacturers with ease. These mounts are manufactured using powder coated steel and heavy-duty corrosion-resistant 5000 series aluminum. Schedule 40 pipe not included.

ITEM CODE & POST SIZE INFO	Vikram 60W & 100W SIZE "A"	Sun7Solar 190W SIZE "B"	Most 60 cell modules SIZE "C"	Most 72 cell modules SIZE "D"
<b>S-UNI-TP/02A</b> For 4" Sched 40 pipe. Single columns 55"	\$325 2 modules	\$325 1 module	\$325 1* module	\$325 1* module
<b>S-UNI-TP/04</b> For 4" Sched 40 pipe. Single columns 90"	\$362 3 modules	\$362 2 modules	NA	NA
<b>S-UNI-TP/04A</b> For 4" Sched 40 pipe. Single columns 110"	\$407 4 modules	NA	NA	NA
<b>S-UNI-TP/08</b> For 6" Sched 40 pipe. Dual columns 90"	\$790 6 modules	\$790 4 modules	NA	NA
<b>S-UNI-TP/10LL</b> For 6" Sched 40 pipe. Dual columns 115"	\$1122 8 modules	\$1122 6 modules	NA	NA

\* Modules are mounted in **PORTRAIT** orientation where denoted by asterisk, otherwise modules are mounted in **LANDSCAPE** orientation.

In the chart above, "NA" denotes a failure to fit.

# SIDE-OF-POLE MOUNTS BY TAMARACK SOLAR



Tamarack's Side-of-Pole Mount is a simple and universal pole mounting solution for small area solar panel needs. With its user-adjustable angle settings, the Side-of-Pole Mount can support installations in a wide range of locations. These mounts support pole diameters of 2-3/8" to 4.5" and modules with center-center distribution of 19" to 39". Manufactured using heavy-duty corrosion-resistant 5000 series aluminum. Pipe not included.

ITEM #	Vikram 30W Modules	Vikram 60W Modules	Vikram 100W Modules	Most 60-cell modules
S-UNI-SP/01A	\$73 1 module	NA	NA	NA
S-UNI-SP/02	\$163 2 modules	\$163 1* module	\$163 1 module	NA
S-UNI-SP/02A	\$168 3 modules	NA	NA	NA
S-UNI-SP/02X	NA	NA	NA	\$187 1 module
S-UNI-SP/03	\$243 4 modules	\$243 2* modules	\$243 1 module	NA

\* Modules are mounted in **PORTRAIT** orientation where denoted by asterisk, otherwise modules are mounted in **LANDSCAPE** orientation.

# SIDE-OF-POLE MOUNTS FOR TWO LARGER MODULES



These Side-of-pole (SOP) mounts by General Specialties are built for use on 4" Sched 40 steel posts (not included). Panel inclination is controlled through a range of 20 to 90 degrees just by changing the attachment to the brace. Rated for up to 100 MPH winds. Zinc-plated U-bolts and stainless steel mounting hardware for all panel attachments are included.



ITEM #	SIZE "B" MODULES	SIZE "C" MODULES	SIZE "D" MODULES	Rail Length	Price
S-SOP-Y	2	2	NA	81"	\$400
S-SOP-Y-D	NA	NA	2	81.5"	\$494

# SINGLE ARM MOUNTS BY TAMARACK SOLAR



Tamarack Solar's Single Arm Mount is a simple mounting solution for poles, walls and other flat surfaces. This incredibly versatile mount has been used on the sides of shipping containers, buildings, as an awning, and mounted to just about any flat surface. This system also mounts to poles of 2" to 4" diameter, and module widths between 5.26 and 26 inches. Single Arm Mounts are manufactured using heavy-duty corrosion-resistant 5000 series aluminum. Schedule 40 pipe not included.

The Single-Arm mount sizing is a little bit different than the other pole mounts because it does not attach through the mounting holes on the module frame. Instead it clamps down to the inside of the module frame (this is what is referred to as the "inside extrusion dimension"). The UNI-SA mounts are sized as follows:

The extrusion dimension is the inside distance between two sides of the module frames. This is where the clips of the UNI-SA mounts will attach.

## Inside Extrusion Dimension

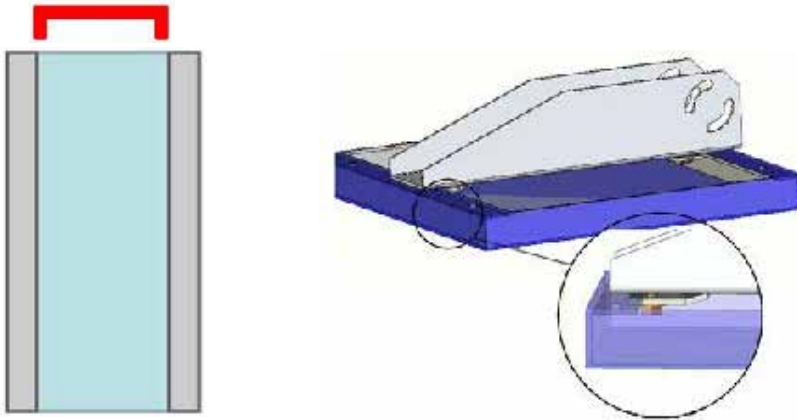

ITEM #	Description	Inside Extrusion Dimension	Price
<b>S-UNI-SA/14.0</b>	Single Arm Mount, 14"	5.26" - 12.6"	<b>\$47</b>
<b>S-UNI-SA/21.5</b>	Single Arm Mount, 21.5"	12.66" - 20.1"	<b>\$52</b>
<b>S-UNI-SA/26</b>	Single Arm Mount, 26"	20.11" - 25.5"	<b>\$58</b>

# ROOF, GROUND & WALL MOUNTS



## Seasonally Adjustable Solar Mounts for Roof, Deck, Wall or Ground

Tamarack offers a simple solution to mounting several smaller panels, up to 3 larger panels on a tilt-up rail mount. Appropriate for roof, ground, or wall mounting, the mounts feature telescoping legs to easily adjust the seasonal angle for optimum solar exposure.

Panels can be attached in Landscape orientation (long dimension runs left to right) or Portrait orientation (long dimension runs up and down). Compare the width of the panel for Landscape, or the length of the panel for portrait to the overall length of the rail, 70" in the case of UNI-GR70CV. For example, a 70" rail can accommodate two modules in Landscape orientation, with each panel measuring 62" long x 32" wide.

Larger installations using multiple mounts in a row can be tied together using Tamarack's Mount Intertie Kit (S-UNI-GR-INTRTI, \$40), sold separately, for greater structural stability.

Rails, legs, and feet are made of anodized aluminum. Nut and bolt hardware is stainless steel. 10 year warranty.

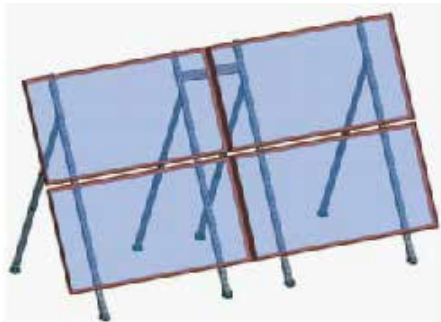

TWO MOUNTS SHOWN w/ INTERTIE KIT

ITEM #	Vikram 30W Modules	Vikram 60W Modules	Vikram 100W Modules	Most 60-cell Modules	Most 72-cell Modules
S-UNI-GR70CV 70" channel	\$203 4 modules	\$203 2* modules		\$203 1* module	\$203 1* module
S-UNI-GR90CV 90" channel	\$247 5 modules	\$247 3 modules	\$247 2 modules	\$247 2 modules	\$247 2 modules
S-UNI-GR110CV 110" channel	\$298 6 modules	\$298 4 modules			
S-UNI-GR125CV 125" channel				\$318 3 modules	\$318 3 modules

\* Modules are mounted in **PORTRAIT** orientation where denoted by asterisk, otherwise modules are mounted in **LANDSCAPE** orientation.

# ROOF & WALL MOUNTS



General Specialties sturdy, 2" x 1-1/2" x 1/8" extruded Aluminum Rails (A) securely attach to the back of solar module(s). The Back Legs (B) adjust to multiple tilt angles (most folks adjust just twice a year, for summer and winter sun). L-Feet (C) anchor the assembly to the mounting surface - a south facing roof or wall, deck or railing, or even an RV roof where tilt-up legs aren't normally desired.

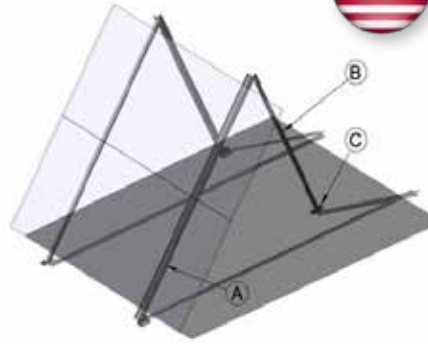

Mounts include all stainless steel nuts & bolts required to mount modules to the slotted rails and to attach support legs and L-feet to rails. Customer provides appropriate anchor bolts/screws to attach the feet to the structure. With illustrated instructions.

S-RV RAILS: Mount for 2 solar modules is 68.5" long, without tilt-up legs. Rails lay flat on roof with 4 feet.

ITEM #	Module Size Compatibility*	# of Modules	Rail length	Price
<b>S-RAILS</b>	"A"	2	68.5"	<b>\$116</b>
<b>S-RAILS-SINGLE</b>	"A"	1	36"	<b>\$102</b>
<b>S-RAILS-LRG</b>	"B" or "C"	2	83.5"	<b>\$152</b>
<b>S-RAILS-LRG-72</b>	"D"	2	83.5"	<b>\$182</b>
<b>S-RAILS-SNG-LRG</b>	"B", "C" or "D"	1	44"	<b>\$128</b>
<b>S-RVRAILS</b>	"A"	2	68.5"	<b>\$78</b>
<b>S-RVRAILS-LRG</b>	"B", "C" or "D"	2	83.5"	<b>\$102</b>

\* See Solar Module section for the "Module Size Category" listed for each module.

## SIMPLE RV MOUNTS

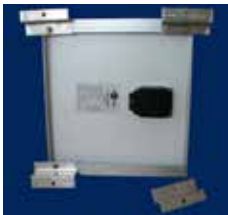

Four aluminum Z-strip brackets mount a panel flat to a wall, or on the roof of an RV or van. Module is elevated 3/4 inch for air and wire clearance. New design works with any module on the market that has back mounted holes drilled in the frame.

ITEM #	Description	Price
<b>S-RV1</b>	Single module RV roof mount	<b>\$38</b>

Install one solar module on top of an RV, shed or other flat surface. Use as a portable device to place a solar module in the sun when your RV is in the shade. It has adjustable angle settings from 0-40 degrees to provide better solar exposure.

ITEM #	Description	Price
<b>S-UNI-RV40</b>	Single module, adjustable RV mount Designed for 90mph winds	<b>\$102</b>



# SNAPNRACK



## Ultra Rail Roof Mounting System

SnapNRack is a top-down clamp, roof mounting solution, load-tested and engineered for up to 150 mph wind loads. The rail is a lightweight anodized aluminum extrusion that is easy to transport, handle, and install. It is compatible with modules from virtually any manufacturer. Snap-in sliding channel nuts ensure quick and easy installation and precise alignment of module clamps. Every bolt in the system uses the same size wrench, making installation simple and minimizes the amount of tools needed. Standoffs and L-feet connect to the rails using the same snap-in channel nuts as the module clamps—no drilling required. Channels in the rail can be used for clean, simplified wire management. SnapNRack is engineered for excellent seismic, wind, and snow loading protection on all components. Tilt-up can be achieved with pieces of cut rail and the tilt leg kit.



There are many components and configurations available to suit almost any situation. We suggest giving us a call to discuss specific needs and let us design a SnapNRack system. Covered by a 10-year warranty.

There are many components and configurations available to suit almost any situation. We suggest giving us a call to discuss specific needs and let us design a SnapNRack system. Covered by a 10-year warranty.

**SnapNRack Rail Sets** - SnapNRack Ultra Rail Sets include black or clear, anodized aluminum rail in 168” lengths. They’re available in packs of 4.

ITEM #	# of rails	Rail Length	Color	Price
S-SNR-015-10199	4	168”	Black	\$221
S-SNR-015-10200	4	168”	Silver	\$178
S-SNR-242-01214	Rail Splice Assembly, UL		Black	\$6.75
S-SNR-242-01213	Rail Splice Assembly, UL		Silver	\$6.50

**SnapNRack Module Attachment Clamps** - Mid Clamps & End Clamps are used to attach modules to rails. No drilling necessary! All clamps listed below are UL.

ITEM #	Description	Clear	Black
S-SNR-MC-SM-(CLR)	Mid Clamp Kit (for panels 1.20-1.48” thick), UL	\$3.25	\$3.75
S-SNR-MC-MED-(CLR)	Mid Clamp Kit (for panels 1.31-1.77” thick), UL	\$3.25	\$3.75
S-SNR-MC-LRG-(CLR)	Mid Clamp Kit (for panels 1.50-2.00” thick), UL	\$3.25	\$3.75
S-SNR-END-CU	Universal End Clamp Kit, UL	\$5	NA

Please specify frame color (C for clear anodized aluminum or B for black) as well as the thickness of the module frame when ordering.

**Please note:** In addition to the wide variety of roof attachment options, SnapNRack manufactures many more accessories that we can special order. Some of these include: Stand-off attachment options, Array Edge Screens to eliminate debris and critters from getting under the modules, Wind Screens for tilt up arrays, Micro-Inverter Attachment Kits, and Rail Covers for wire enclosure.

ALL SNAPNRACK ROOF MOUNT RAILS SHIP VIA TRUCK FREIGHT. CALL FOR A QUOTE.



# TAMARACK FLUSH MOUNT RAIL SYSTEM



Save time and money with Tamarack's Flush Mount Rail System. It's a low-cost rail-based mounting system that provides quick, easy installation, simple wire management, great aesthetics and the best feature-set on the market.

**Use Any Roof Attachments** - Rails mount to QuickBolt, QuickMount, Ironridge FlashFoot or any specialty flashing that can be used with a 5/16 inch bolt.

**Wire Management** - PV Cables and Module Level Electronics wiring can be run in rails to avoid time consuming wire clips.

**Push-In Bonding Rail Splice** - Quickly splice and bond rail sections with no tools or fasteners. Top Clamps and Rail Mounts can be co-located with splice.

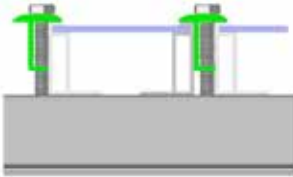

**Patent-Pending 50-50 Bonding Clamp** - One clamp size can be used for mid or end clamp on modules from 30 mm to 40 mm frame height.

**UL 2703 Listed** - All components meet the latest UL standards and have a Class A Fire Rating for Type 1 and 2 modules. Stamped engineering for most states is available.



**Rail Mount and L-Foot** - Quickly and securely mount the rail from either side, to any L-Foot, Tile Hook or specialty flashing with a hole or slot for 5/16" bolt.

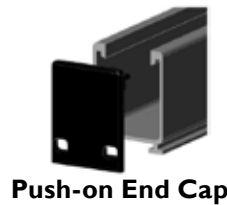

**Push-on End Cap**



**Wire Mgmt Clip**

ITEM #	Description	Price
<b>S-TSP-FMRAILKT4</b>	For 4 modules - includes (4) 1.6" Mill Finish Rails 84" long, (4) splices, (8) rail mounts, (10) 50/50 clamps, (4) end caps, (12) wire clips & (2) ground clamps	<b>\$219</b>
<b>S-TSP-FMRAILKT8</b>	For 8 modules - includes (8) 1.6" Mill Finish Rails 84" long, (8) splices, (16) rail mounts, (20) 50/50 clamps, (4) end caps, (24) wire clips and (4) ground clamps	<b>\$332</b>

For larger arrays, 126" rails in 1.6" and 2.3" height (for heavier loads) are also available in boxes of 8. Splices, rail mounts, clamps, end caps, wire clips and ground clamps can also be purchased separately in multiple quantities. Please give us a call for more information.

TAMARACK FLUSH MOUNT KITS ARE SHIPPED VIA UPS!

# WIRING SOLAR MODULES



**WIRING INDIVIDUAL SOLAR MODULES** Once the panels are mounted, wires must be connected from each solar module to receive the power generated. Sunlight resistant flexible 10 gauge wires connect from each solar module junction box to a combiner box. You will find bulk wire and pre-cut wires with terminal tips or MC cables and weather tight box seals in the following pages. A single panel is usually rated for 12 volt charging, but several of the larger ones are 24 volts. 12 volt panels can be wired in series, two for 24 volt battery charging or four in series for 48 volt battery charging. Likewise 24 volt panels can be series wired in pairs for 48 volt battery charging. Larger modules that are outside the 12 & 24V models, can still be used for battery charging by incorporating a MPPT charge controller.

**COMBINER BOX** The combiner box mounts on the post of a pole mount, or under the eaves for a roof mount. Wires from the solar modules connect together in the combiner box. National Electric Code requires each panel or each series string of panels to be wired to its own circuit breaker or fuse if there are more than two strings in parallel. The MidNite or Magnum combiner box with breakers makes wiring easier, provides a "switch" for separately testing each solar module, and isolates any faulty module or blown diode from the power of the whole solar array. Unfused combiner boxes with just a junction block for connecting the wires together are still available at low cost for arrays with two strings of modules in parallel.

**GROUNDING THE ARRAY** The aluminum frame of each solar module is required to be grounded to a ground rod below the array. This can be accomplished by using a lay-in-lug on each module and a single continuous copper wire that is also bonded to the rails. This rod should also be connected by heavy wire to any other ground rod in the system.

**WIRE SIZE & DISTANCE: ARRAY TO BATTERY ROOM** Much larger wires for positive, negative, (and sometimes the ground rod) are run from the combiner box/s to the battery room. These run in conduit from the box to underground, and often also in conduit the full distance underground. The wires are larger, and are limited in permissible length, because any voltage drop would reduce the solar charging. A wire sizing chart to guide selection of wire gauge for each array voltage and distance is on the next page. When a given array is wired for double the voltage, current is reduced to half, making much longer wire runs acceptable.

**VOLTAGE CONVERTING CHARGE CONTROLS** Breakthroughs in solar equipment have given us charge controllers that have the ability to accept power from a solar array wired for higher voltage, up to 250VDC, open circuit, and once it reaches the power room, convert it down to 12, 24, or 48 volts for the battery. This allows higher voltage and lower current in solar module wires, which allows longer wires of much smaller size between the array and battery room.

# Solar To Battery Wire Size Tables

TO FIND SIZE REQUIRED FOR LESS THAN 2% POWER LOSS:

Read down the left-hand edge to the number showing solar amps or watts the selected wire will carry. Follow that line across to the right to find the wire length in feet from solar to batteries (one way distance). At the top of the column above the wire length is the minimum wire size (gauge) required. Smaller gauge = larger wire. Twice the listed distance is permissible where a 4% drop is acceptable. A 4-5% drop is acceptable between batteries and lighting circuits in most cases. Buried DC cables must be copper, wet aluminum with DC corrodes quickly.

**For more specific wiring calculations, see page 157 in the back of this book.**

Copper Wire Size and Length Table, 2% loss for 12 Volt Wiring										
AMPS	WATTS	12ga	10ga	8ga	6ga	4ga	2ga	1/0	2/0	4/0
4	48	17.5	27.5	45	72.5	114	180	290	360	580
6	72	12	17.5	30	47.5	75	120	193	243	380
8	96	8.5	15	22.5	35.5	57	90	145	180	290
10	120	7	12	18	28.5	45.5	72.5	115	145	230
15	180	4.5	7	12	19	30	48	76.5	96	150
20	240	3.5	5.5	9	14.5	22.5	36	57.5	72.5	116
25	300	2.8	4.5	7	11.5	18	29	46	58	92
30	360	2.4	3.5	6	9.5	15	24	38.5	48.5	77
40	480	---	2.8	4.5	7	11.5	18	29	36	56
50	600	---	2.3	3.6	5.5	9	14.5	23	29	46

Copper Wire Size and Length Table, 2% loss for 24 Volt Wiring										
AMPS	WATTS	12ga	10ga	8ga	6ga	4ga	2ga	1/0	2/0	4/0
4	96	35	55	90	145	228	360	580	720	1160
6	144	24	35	60	95	150	240	386	486	760
8	192	17	30	45	71	114	180	290	360	580
10	240	14	24	36	57	91	145	230	290	460
15	360	9	14	24	38	60	96	153	192	300
20	480	7	11	18	29	45	72	115	145	232
25	600	5.6	9	14	23	36	58	92	116	184
30	720	4.8	7	12	19	30	48	77	97	154
40	960	---	5.6	9	14	23	36	58	72	112
50	1200	---	4.6	7.2	11	18	29	46	58	92

Copper Wire Size and Length Table, 2% loss for 48 Volt Wiring										
AMPS	WATTS	12ga	10ga	8ga	6ga	4ga	2ga	1/0	2/0	4/0
4	192	70	110	180	290	456	720	1160	1440	2320
6	288	48	70	120	190	300	480	772	972	1520
8	384	34	60	90	142	228	360	580	720	1160
10	480	28	48	72	114	182	290	460	580	920
15	720	18	28	48	76	120	192	306	384	600
20	960	14	22	36	58	90	144	230	290	464
25	1200	11.2	18	28	46	72	116	184	232	368
30	1440	9.6	14	24	38	60	96	154	194	308
40	1920	---	11.2	18	28	46	72	116	144	224
50	2400	---	9.2	14.4	22	36	58	92	116	184

Copper Wire Size and Length Table, 2% loss for 120 Volt Wiring										
AMPS	WATTS	12ga	10ga	8ga	6ga	4ga	2ga	1/0	2/0	4/0
8	960	85	150	225	355	570	900	1450	1800	2900
15	1800	45	70	120	190	300	480	765	960	1500
25	3000	28	45	70	115	180	290	460	580	920
50	6000	---	23	36	55	90	145	230	290	460
100	12000	---	---	18	29	46	72	115	145	230

# WIRING SOLAR MODULES



## READY-TO-USE SOLAR MODULE INTERCONNECTS

The MC4, PV4 & T4 cables are a single 10 gauge conductor which get cut in half. 30 feet long. Each cable has one female end and one male end. Order one cable for each string of panels.

ITEM #	Description	Price
<b>O-MC4-CABLE</b>	MC4 cable - 30 feet long	<b>\$27</b>
<b>O-PV4-CABLE</b>	PV4 cable - 30 feet long	<b>\$27</b>
<b>O-T4-CABLE</b>	T4 cable - 30 feet long	<b>\$27</b>

## BRANCH CONNECTORS for parallel connections.

ITEM #	Description	Price
<b>O-MC4-Y-MALE</b>	2 Male, 1 Female	<b>\$8</b>
<b>O-MC4-Y-FEMALE</b>	2 Female, 1 Male	<b>\$8</b>



## WIRE BY THE FOOT

### TWO CONDUCTOR JACKETED

10 gauge pair of stranded copper, one red, one black, in a sunlight resistant jacket. Allow about 30 inches per module, plus length to combiner box. For modules with junction boxes.

ITEM #	Length	Price
<b>O-SOLAR-2</b>	1 foot	<b>\$2.50</b>

### SINGLE CONDUCTOR WIRE

Single 10 gauge or 12 gauge stranded copper wire type XLP-USE, tough sunlight resistant insulation. Simplified connection between modules wired in series to make higher voltage strings. Red insulating sheath for positive and Black sheath for negative. 12 gauge is available in black only. Order by the foot.

ITEM #	Length	Price
<b>O-SOLAR10-RED</b>	1 foot	<b>\$.60</b>
<b>O-SOLAR10-BLK</b>	1 foot	<b>\$.60</b>
<b>O-SOLAR12-BLK</b>	1 foot	<b>\$.55</b>

# WIRING SOLAR MODULES

## PV GROUNDING LUGS

Grounding lug for PV frames; accepts 4-14 awg. With stainless steel screws and locking washers. You will need one lug per module within your system. UL listed.



ITEM #	UOM	Price
O-PVLUG-SGB4	EA	\$4

**STRAIN RELIEF** - Thread size - 1/2" NPT,  
Cable Outer Diameter .394" to .551"

ITEM #	UOM	Price
O-WIRE-FIT	EA	\$4



## CABLE CLIPS

These stainless steel clips keep cables neatly secured to the frame of module so that they do not hang below the array. Holds one or two USE-2 cable(s) or one PV cable to module.



ITEM #	Quantity	Price
O-WILEY-CLIP	Each	\$.75

# SOLAR COMBINER BOXES

## MidNite Combiners



Combiner boxes made from powder-coated aluminum, NEMA 3R rainproof combiners will accept DIN-rail mounted fuse holders for 600VDC arrays, or 150VDC and 300 VDC DIN-rail mounted breakers for low-voltage arrays. Plastic cover provides a dead front for safety. ETL listed, negative busbar and ground bar are included. Can be mounted at angles from 14 to 90 degrees. The MidNite Combiner and Disconnect is for use with 150 & 300VDC breakers. The 250 versions are for use with 200 - 250VDC charge controllers. The MNPV6-250 can also be used with up to three 150VDC breakers.

### COMBINER BOXES

ITEM #	Price
S-MNPV3	\$94
S-MNPV6	\$118
S-MNPV12	\$202

ITEM #	Price
S-MNPV6-250	\$94
S-MNPV12-250	\$210



### DISCONNECTING COMBINER

The MidNite Combiner and Disconnect is for use with 150 & 300VDC breakers.



ITEM #	Price
S-MNPV6-DISCO	\$204

### BREAKERS & FUSES

ITEM #	Description	Price
S-MNEPV-XX	Breaker for 6, 9, 10, 15, 20, 30, 40, 50, 60, 63 Amps	\$17
S-MNEPV-XX	80A and 100A dual slot breakers	\$54
S-MNEPV-GFP63	63A GFP Breaker	\$74
S-MN-FH	Fuse holder for KLKD fuse	\$6.25
S-MN-FUSEXX	1A, 15A or 20A KLKD 600VDC fuse	\$4.25
S-MNEPV-HV	10, 15, 20, 30 or 50A High Voltage Breaker, 300V	\$38
S-MNEPV-H6V	16A or 20A High Voltage Breaker, 600V	\$125

FULL LINE OF MIDNITE PRODUCTS ARE AVAILABLE.

# INTRODUCTION TO RAPID SHUTDOWN

In 2014, the NEC instituted code 690.12 in regards to rapid shutdown of PV systems. The code was implemented in order to protect first responders from the dangers of an energized PV system, even after the AC service has been shutoff. More than half of all states have adopted the code change, and further changes and amendments were implemented in 2018.

Backwoods is here to offer solutions and support to meet the changing requirements of the electrical code. Many inverters that we carry now have proprietary RSD accessories available. We have also outlined a third-party option offered by MidNite Solar which has additional features that will enable inverters with onboard AC outlets designed to work during power outages. Keep in touch via our website as more solutions become available.

These code requirements affect both grid-connected and off-grid homes and states that all PV System Circuits installed on or in buildings shall include a rapid shutdown function that controls specific conductors that meet the following conditions:

1. Applies to PV System conductors (wires) of more than 5 feet inside a building or 10 feet from a PV array.
2. Controlled conductors shall be limited to not more than 30 volts and 240 volt-amperes within 10 SECONDS of shutdown.
3. Voltage and power shall be measured between any two conductors and between any conductor and ground.
4. The rapid shutdown methods shall be labeled as such: PHOTOVOLTAIC SYSTEM EQUIPPED WITH RAPID SHUTDOWN (in white, capitalized, reflective letters on a red background). – Backwoods has labels available for this purpose. See next page.
5. Equipment that performs the rapid shutdown shall be listed and identified.

The following page shows the third party offerings from MidNite Solar. As we design systems for individuals that require rapid shutdown, we will include the appropriate solution for the situation and the inverter choice that was made.

**Note: Code-compliant installations may require additional items to satisfy local electrical inspection.**

# MIDNITE RAPID SHUTDOWN BOXES



The MidNite Solar “Birdhouse” Rapid Shutdown, box is a firefighter and homeowner’s safety control system that is designed to disconnect and isolate power from the PV panels, batteries, inverters and generators. In case of an emergency, or for routine maintenance, pushing the large red button of the Birdhouse sends a signal to all disconnection modules and then returns feedback that they actually are disconnected. MidNite’s Rapid Shutdown is the only system that provides visual and audible confirmation that power has been disconnected.

ITEM #	Price
S-MNBIRDHOUSE-R	\$349

The MNPV4-HV series of combiners are manufactured for indoor / outdoor use and designed for combining high voltage strings using fuses. The use of touch-safe din rail mount fuse holders and fuses allow operation up to 600 volts. Lockable in the OFF position. This model includes Power Supply board, factory-installed, for Plug and Play compatibility with the MidNite Solar Birdhouse Rapid System Shut Down Controller.



ITEM #	Price
S-MNPV4-HV3RD-P	\$619

## RAPID SHUTDOWN LABELS

These pre-printed, reflective labels are designed to meet the requirements of the 2014 National Electrical Code. Labels are made with durable UV stable materials and adhesives that are designed to stick to both baked enamel and powder coat surfaces. 5.5” x 1.75”, Red. Reflective.



ITEM #	Price
S-LBL-RSD	\$4.50ea



# SOLADECK COMBINER BOXES



Combine flashed roof penetration protection with the ability to transition, pass through, or combine solar PV strings with one weather tight enclosure. Combiners make installation faster and easier with a simple design and clear instructions.

Pass-thru enclosures for simple residential pass thru from exterior wiring to interior attic space. Din rails and grounding blocks for wire transition. Combiners/pass thru boxes are used when you combining multiple strings and pass them through to interior wiring. 3" and 6" din rails to accommodate fuse holders. Negative and Positive bus bars available.

ITEM #	Description	Price
<b>S-SD-PASSTHRU</b>	Passthru Enclosure, AC/DC	<b>\$90</b>
<b>S-SD-COMBINER</b>	Combiner Enclosure, AC/DC	<b>\$128</b>
<b>S-SD-2STRING</b>	2 String Passthru Term Kit	<b>\$21</b>
<b>S-SD-FUSEHLDR</b>	Fuseholder KLKD DIN Mount	<b>\$10</b>



S-SD-PASSTHRU is commonly used to pass thru or transition outdoor system wiring to interior house wiring with a weather-tight enclosure.



S-SD-COMBINER is used when combining strings.

# WIND POWER



At a *good* site, a wind turbine can generate more power for its cost than solar modules. Both together can give steadier input since a wind turbine charges the batteries in storms when there is no sun, and at night. a

But beware of erecting a wind turbine where the wind is not strong and steady. An area's wind-speed, as well as the immediate terrain, will determine how well the wind turbine performs. If in doubt, we suggest starting with solar modules, and checking the wind for a year. This will show whether to add a wind turbine or more solar modules. Twelve to fifteen mph average year-round winds are necessary for an optimal installation, and these sites are not common.

Wind turbines must mount at least 30 feet above trees and obstructions for 300 feet around. They need non-turbulent air where a weather vane holds a steady direction. Charge controls for wind turbines are different than for solar. A spinning turbine produces "wild AC" power which must be rectified to DC power to properly charge a battery bank. In the case of the Primus turbines listed on the next page, this rectifying is done in the turbine with no additional equipment necessary.





# PRIMUS TURBINES

**primus**windpower

- **Maximize Power in Winter**
- **Night Time Power Production**
- **Ideal for Hybrid combinations with Solar PV.**



The AIR Wind Turbine product line, acquired by Primus Windpower in 2013, is recognized across the industry as the standard for small, residential, off-grid wind power. Primus advocates a practical approach to the application of wind power. The “Air” line is ideally suited to compliment solar PV systems during the least sunny, winter months of the year.

For Backwoods customers this can mean a significant reduction in generator run-time IF living in an area of moderate or greater winter season winds. The smaller turbines, on a reasonably sized tower offer a cost effective approach to complimenting the shorter collection window that a solar array sees during the winter time.

The Air30 and Air X Marine models are intended for industrial applications of higher wind speeds where turbine noise is not an issue. A narrower blade design allows for peak production in higher wind speeds of 25-30 mph. More wind and power does mean more noise as well.

The Air40 and Air Breeze are quieter, more efficient and precision engineered to deliver more energy at lower wind speeds than any other wind generator in its class. It uses a new microprocessor based technology that results in an increase in performance, battery charging capability, and reliability. Additionally, “flutter” noise from the machine has been reduced.

Power is rectified to DC in the turbine. The DC voltage setpoint is field adjustable on the side of the turbine. Normal operating mode uses built-in electromagnetic regulation feedback to internally brake the turbine when voltage set-point is achieved. A simple control switch down the line sets the turbine to operate in normal charging mode, or in a slow-braking mode when extreme winds and storms are expected. Switch can be changed at a moments notice from one mode to the other.

Rotor diameter: 46”

Energy: Approx. 30kWh/mo at 12 mph

Startup windspeed: 8 mph

Factory specified voltage: 12, 24 or 48 volts

Permanent magnet brushless alternator

Turbine weight: 13 lbs

5 year limited warranty

# PRIMUS TURBINES



## TURBINES

ITEM #	Description	Price
<b>W-PR-AIR30</b>	Primus Air 30 Turbine	<b>\$952</b>
<b>W-PR-AIR40</b>	Primus Air 40 Turbine	<b>\$952</b>
<b>W-PR-AIRBREZ</b>	Primus Air Breeze Turbine	<b>\$1190</b>
<b>W-PR-AIRX-M</b>	Primus Air X Marine Turbine	<b>\$1190</b>
All turbines are available in 12V, 24V or 48V. Please specify when ordering.		
<b>W-PR-STOP</b>	Stop Switch	<b>\$45</b>

## TOWERS

Continuing with their affordable and practical approach, Primus offers several tower options for their turbines.

The 27' and 45' tower kits use a simple cross-piece as a base and guy wires for structure. The steel pipe needs to be purchased locally as it is NOT included with the kit.

The 29' EZ Tower is a guy-wire supported tower which uses lightweight tubing (included) while providing plenty of strength. Two people can easily erect this tower in about an hour. Because the wind turbine and EZ Tower are lightweight, no winches or vehicles are needed to erect the tower.

Depending on soil conditions, a cement pad may or may not be necessary for proper anchoring. It is best to understand the soil conditions before beginning construction.



ITEM #	Description	Price
<b>W-PR-TWR-27</b>	Primus 27' Guyed Tower Kit (pipe not included)	<b>\$275</b>
<b>W-PR-TWR-45</b>	Primus 45' Guyed Tower Kit (pipe not included)	<b>\$460</b>
<b>W-PR-TWR-29EZ</b>	Primus 29' EZ Tower Kit (includes pipe)	<b>\$829</b>

# HYDROPOWER

WATER GENERATORS steadily charge 12, 24, or 48 volt batteries, working 24 hours a day every day. Compare this with solar modules that are in sunshine only 6 full power hours a day, and that's just on sunny days. A hydro generator producing 10 amperes around the clock matches the usable power generated by over 50 amps of solar modules. So cost is a lot lower with hydro. The rest of the power system is the same as for solar, except only diversion type charge controls are used with hydro. Pelton wheel generators (pictured, right) use a small volume of water raised to high pressure by running downhill in a penstock (pipeline). Pressurized water shoots from nozzles to strike and spin the cupped wheel on an alternator. Other types of wheels and propellers handle water sites with less pressure (head) and more flow volume.



PERFORMANCE depends on the site more than on the cost. Greater water pressure at the nozzle, produced by more head (elevation change top end of pipe to bottom), brings more power. Greater water volume (gallons per minute) onto the wheel also brings more power. Sites with higher head are most desirable because they need less water, smaller pipe, fewer nozzles, cost less to install, and fare better in low water years.



Pipe size, number and size of nozzles, and choice of alternator depend on measurements of the site. There are many combinations of water volume and head, so best to contact us and describe the creek's characteristics. Tell us specifically:

1. What elevation change and across what distance of creek length?
2. How many gallons per minute flows minimum and maximum seasons?
3. What size, type, and length of pipe (if already installed)?
4. Wire distance from hydro plant (lower end of creek) to the home?

**COST:** A complete system with hydro generator, charge control, batteries and inverter costs \$7000+. Pipeline and installation, additional.

# HYDRO INDUCTION POWER

## Low-Voltage Hydroelectric Generators

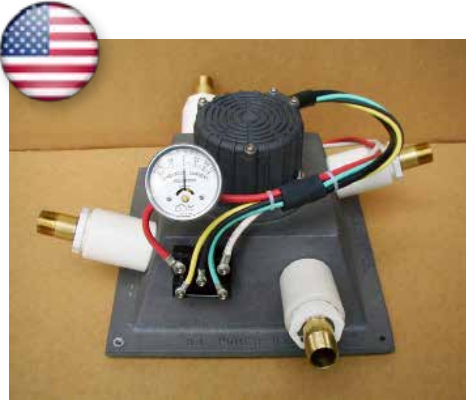

Hydro Induction Power is introducing a new unit, now the LV1500 (LV750 for low head, below 60'), with a larger motor. The LV800 is ideal for sites with 2" pipe, and the new LV1500 for sites with 3" or 4" pipe. The new ratings for the LV800 are for direct battery hookup. At higher pressures (>150'), they can produce more when connected to an MPPT controller or a high-frequency transformer box, which is available upon request.

All models are available in DC for direct battery hookup and grid-intertie. They are also available in 3-phase AC for use with their transformer box.

**LV800 (LV400** is available for sites with low head below 60'): for Pipes 2" diameter  
 Head range: 70 to 600 feet  
 Flow range: 5 to 100gpm  
 Maximum power: 800W (LV400 max power: 400W)  
 Efficiency: 30% to 70%  
 Battery voltage options: 12-, 24-, 48-, 120VDC or AC

**LV1500 (LV750** is available for sites with low head below 60'): for Pipes > 2" diameter  
 Head range: 70 to 600 feet  
 Flow range: 5 to 100gpm  
 Maximum power: 1500W (LV750 max power: 750W)  
 Efficiency: 30% to 70%  
 Battery voltage options: 12-, 24-, 48-, 120VDC or AC

The sealed permanent magnet alternator is mounted on an anodized aluminum turgo housing with the 4-inch stainless steel Hartvigsen Turgo Runner. The external rectifier is water-cooled and all fasteners are stainless steel. It comes with an induction meter and 3 feet of 1-inch flexible hose per nozzle. Order multiple nozzles for convenient adjustment to varying flows. Alternator has two enclosed 6203 bearings which should be changed every 4-10 years, depending on use. Pictured with 3/4-inch brass nozzle holders. 1/2-inch plastic nozzle holders also available. Also available with Harris Pelton Runner by request. Base dimensions: 12" x 12". Skirt fits in 10.25". When ordering, specify battery voltage, transmission line length and size, flow, pressure, pipe size and length.

THESE ARE CUSTOM BUILT - OUR 30 DAY RETURN POLICY DOES NOT APPLY

**Hydro Induction Power, continued from previous page**

ITEM #	Description	Price
W-LV800-1	Low Voltage 800 Hydro with one nozzle	\$1350
W-LV800-2	Low Voltage 800 Hydro with two nozzles	\$1400
W-LV800-3	Low Voltage 800 Hydro with three nozzles	\$1450
W-LV800-4	Low Voltage 800 Hydro with four nozzles	\$1500
W-LV1500-1	Low Voltage 1500 Hydro with one nozzle	\$1850
W-LV-1500-2	Low Voltage 1500 Hydro with two nozzles	\$1900
W-LV-1500-3	Low Voltage 1500 Hydro with three nozzles	\$1950
W-LV-1500-4	Low Voltage 1500 Hydro with four nozzles	\$2000
W-LVHYDRO-NOZZ	Replacement Nozzles	\$15

When ordering, specify battery voltage, transmission line length and size, flow, pressure, pipe size and length. Pipe not included.



## SCOTT HYDROELECTRIC Cross Flow Turbine Generators

FOR LOWER HEAD; HIGHER VOLUMES OF WATER. Backwoods Solar is excited to introduce a new offering to our hydroelectric product line. The Scott Cross-Flow turbine is capable of 1500+ watts of output with only 35' or more of head. A minimum of 15 feet of head is recommended and a 6" penstock although a 4" penstock could be used for higher head, lower flow applications. This is a high flow turbine so the creek must have a minimum of 300 gallons per minute. The Scott turbine sends 3-phase AC to a rectifier located near the battery bank. After the recitifier, a MidNite Classic 250 charge control charges the battery bank. No diversion load is necessary unless the head is over 40 feet. A MidNite Clipper or a stop switch is not recommended with this unit. This high output turbine would be great for a lodge or off-grid home or shop requiring larger amounts of power. The Scott Turbine is industrial grade with cast aluminum and stainless steel runner and shaft.



ITEM #	Description	Price
W-SC-HYDRO	Scott Cross-Flow Hydro Turbine Only	\$3900

# POWER ROOM EQUIPMENT



THE HEART OF THE SYSTEM LIES IN THE POWER ROOM, electricity flows from solar and/or wind through a charge controller and into the battery (hydro goes through a fuse or breaker directly to the battery and is regulated independently). From the battery, power goes out to any DC house circuits, and the inverter/charger producing 120/240 volts AC. The hub of the system is often a DC rated circuit panel (or a set of fuses) housing charge controller, inverter, and AC circuit breakers. Meters show power produced, power used, and battery condition. This equipment mounts on the wall near the battery bank. The installer wires everything together into a functioning power system one of three ways:

**INDIVIDUAL COMPONENTS:** Smaller power systems for cabins and recreational vehicles like examples #1 and #2 at the front of this catalog, use a few components custom assembled by the installer. These components are shown in this catalog.

**POWER PANEL/POWER CENTER:** A single box contains all DC (and often AC as well) circuit breakers, shunts, and easy connection points for the cables from the solar modules, hydro and/or windmill, DC loads, remote meters, batteries, and inverter. The charge controller and inverter often attach to the power panel forming a single integrated unit. This approach eliminates the need to find, buy, and assemble all the hardware separately. Some manufactured power panels can come mostly pre-assembled, with as many pieces as possible already in place and the connection points for the rest of the system ready to go. It is a simplified standard design which saves labor and installation time. The result is a safe, clean looking battery room. Power panel components typically meet National Electric Code and pass electrical inspection.

**INTEGRATED POWER SYSTEM:** The closest option to plug and play that is available. Standardized configurations that vendors/manufacturers make available, can often fit many applications. Call and speak with us to find out what is available to best suit the potential needs. These systems ship in one piece, assembled on a single mounting plate, ready to hang on the wall of the power room. Finish the installation by connecting the battery bank, solar panel wiring, generator, and the household AC breaker panel. Options for minor configuration tweaks are available in some cases. Call Backwoods to see what we can offer.



# MIDNITE E-PANELS

The MidNite Solar E-Panel is a quick and easy way to install most battery-based inverters. They are pre-wired to save time, money and complexity. All field wiring connections are clearly labeled. ETL listed to UL and CSA standards for US and Canada. These do not include inverter, charge controller, Tri-Metric battery monitor (page 115) or surge protection (page 126). Full pre-wired systems (including the inverter) are also available to order. Call for details.

## E-PANELS FOR SCHNEIDER ELECTRIC CONEXT

The **XWPLUS** inverter is mounted directly above the E-panel and comes with a 250A inverter/battery breaker, AC inputs for generator and utility, knockouts for up to 7 DIN rail breakers and 12 panel mount breakers as well as a 500A shunt. Charge controllers mount to either side or both sides at once for dual controller systems. Additional busbars for AC inputs, AC output, neutral, ground, PV+ in, PV- in, Bat +, and Bat-, covered by a metal deadfront.



E-Panel for a single **Conext SW** inverter/charger, the inverter is mounted directly to the right of the E-Panel. Available with the 175 amp breaker (MNE175SW) for the SW2524 or with the 250 amp breaker (MNE250SW) for the SW4024. Save some money over the price of the Schneider Electric distribution panel and get additional features.

ITEM #	Description	Price
<b>C-MNE175SW</b>	Schneider Conext SW 175A E-Panel	<b>\$427</b>
<b>C-MNE250SW</b>	Schneider Conext SW 250A E-Panel	<b>\$427</b>
<b>C-MNE250XW-SINGLE</b>	Schneider Conext XW+ 250A E-Panel	<b>\$780</b>



## E-PANELS FOR MAGNUM PAE INVERTERS

Main breakers, inverter cables, a 500A shunt, busbars, an AC power distribution block, a 50A AC-inout disconnect for generator or utility, and a 50A AC bypass switch are all included and pre-wired. Cutouts for mounting up to 6 additional 13mm-wide DIN rail breakers are provided, as are cut-outs for a GFCI-style AC outlet, and 3 panel mount DC breaker slots. The STM model is made from white steel for **Magnum PAE** inverters.

ITEM #	Description	Price
<b>C-MNE175STM-240</b>	Magnum PAE 175A E-panel, White Steel	<b>\$616</b>
<b>C-MNE250STM-240</b>	Magnum PAE 250A E-Panel, White Steel	<b>\$616</b>

*Other models are available for Magnum, Outback and dual Schneider XW+ inverters.*

# MAGNUM MINI PANEL SYSTEMS

The Mini Magnum Panel is an inclusive, easy-to-install panel designed to work with one Magnum MS-PAE, MS, or RD or other non-Magnum inverter/charger. It comes pre-wired for fast installation with easy access front-mounted breakers and a knockout for the digital remote display. It can be wired for 120VAC or 120/240VAC output. SEE THE NEXT PAGE FOR LARGER PANEL SYSTEMS. PAE units come with a 5-year warranty.



Includes:

- One DC 175A or 250A breaker
- One AC bypass breaker 30A dual pole or 60A single pole
- One AC input breaker 30A dual pole or 60A single pole
- One AC output breaker 30A dual pole or 60A single pole
- One 500A/50mv DC shunt
- DC buss bars for battery positive and negative
- A din rail for optional DC mini breakers (will hold up to eight breakers).



ITEM #	AC Voltage	Compatible Inverters
I-ME-MMP250-30D	120/240	MS2012, MS4024, MS4024PAE, RD2212, RD3924
I-ME-MMP250-60S	120	MS2012, MS2812, MS4024, RD2212, RD3924
I-ME-MMP175-30D	120/240	MS4448PAE, RD2824
I-ME-MMP175-60S	120	RD2824, MS2024

ITEM #	Description	Price
I-ME-MMP250-30D	Magnum Mini Panel 250A DC, 30A AC Dual Pole	\$621
I-ME-MMP250-60S	Magnum Mini Panel 250A DC, 60A AC Single Pole	\$621
I-ME-MMP175-30D	Magnum Mini Panel 175A DC, 30A AC Dual Pole	\$621
I-ME-MMP175-60S	Magnum Mini Panel 175A DC, 60A AC Single Pole	\$621
I-ME-MMP-BP	Back Plate for wall mount	\$91
S-MNEPVXX	6, 9, 10, 15, 20, 30, 40, 50, 60 or 63 amp PV Breakers	\$17
S-MNEPV80 or 100	80 or 100A PV Breaker	\$54
S-MNEPV-GFP63	63A, Single Pole Ground Fault DC Breaker	\$74
I-ME-ARC50	Advanced Remote Display with Cable	\$266

# MAGNUM PANEL SYSTEMS

## For Larger Magnum Systems



The Magnum Panel (MP) enclosures, for multiple inverter applications, have been designed to combine all of the major components required for a high power renewable energy system — inverter/battery disconnect, AC overcurrent protection, grounding connections, and a full system inverter bypass switch as a convenient way to isolate the inverters for battery maintenance — into easy to install pre-wired enclosures. PAE systems come with 5-year warranty.

The MP Series enclosures feature convenient front panel operation, and with the Router (**ME-RTR**), will allow easy set up, monitor, and operate up to four MS-PAE inverter/chargers together (must be identical models to parallel stack). In addition to saving time and money by providing a simple and convenient inverter installation, the MP enclosures ensure safety and reliability by providing a UL and CSA certified and code compliant system.



ITEM #	Description	Price
I-ME-MPSL250-30D	Single Enclosure, Low Power w/250A DC breaker, 30A dual pole AC breaker, <b>24V inverters</b>	\$843
I-ME-MPSL175-30D	Single Enclosure, Low Power w/175A DC breaker, 30A dual pole AC breaker, <b>48V inverters</b>	\$839
I-ME-MPSL250-60S	Single Enclosure, Low Capacity, 250A DC breaker, 60A single pole AC input breaker, <b>24V inverters</b>	\$850
I-ME-MPSH175-30D	Single Enclosure, High Power w/175A DC breaker, 30A dual pole AC input breaker, <b>48V inverters</b>	\$1400
I-ME-MPSH250-30D	Single Enclosure, High Power w/250A DC breaker, 30A dual pole AC input breaker, <b>24V inverters</b>	\$1464
I-ME-MPDH250-30D	Dual Enclosure, High Power w/250A DC breaker, 30A dual pole AC breaker, <b>24V inverters</b>	\$1954
I-ME-MPDH175-30D	Dual Enclosure, High Power w/250A DC breaker, 30A dual pole AC breaker, <b>48V inverters</b>	\$1958
I-ME-MP-BPD	Back Plate Double for Dual Inverters	\$158
I-ME-MPXS-30D	Extension Box for MPSL & MPSH enclosures (specify Left or Right & 175A or 250A breaker)	\$371
I-ME-MPXD-30D	Extension Box for MPDH enclosures (specify Left or Right & 175A or 250A breaker)	\$379
I-ME-ARTR	Advanced Router	\$374

# PRE-WIRED SYSTEMS

Backwoods now offers several choices of pre-wired solutions for some of the more common system configurations. Pre-wired systems deliver the primary power room components; inverter(s), charge controller(s), meters, and controls, all assembled and tested, ready to be hung on the wall of your power room. Installation time and complexity is drastically reduced with the core of your system arriving ready for commissioning.

Final connections must still be completed. Incoming power from the solar array must be connected. The battery bank, battery box, and power vent fan (if used) must be built and connected as well. Also the programming of the inverter and charge controller, and any accessories will be running on factory default settings and should be updated for the specifics of your system. Quick Start Guides and Set-Up Wizards are available with many devices, in addition to owner’s manuals. Backwoods is also happy to help our customers with the initial commissioning of their system.

## MAGNUM/CLASSIC

This configuration built by Midnite Solar combines a Magnum Energy MS-PAE inverter with a Midnite Classic150 charge controller. Dual systems include 2 inverters and 2 charge controllers. Choose between the 24 volt MS4024PAE inverter or the 48 volt MS4448PAE inverter. The inverter is front-mounted on a Midnite Magnum E-Panel, with the charge controller and Magnum ARC50 mounted on the side. Battery bank monitoring is covered with a Midnite Whizbang Jr with the relevant information displayed via the Classic150.



Other features of the build include: charge controller(s), inverter(s) and AC breaker sets, 3 Midnite Surge Protectors, Arc and Ground Fault protection via the Classic150(s), and both Midnite and Magnum temp sensors. The Magnum inverter is a 120/240VAC capable inverter. RSS versions are Rapid Shutdown compliant.

ITEM #	Description	Price
<b>C-MNMS4024-150</b>	Midnite Pre-Wired Magnum MS4024PAE Inverter & Classic 150 Charge Controller	<b>\$4859</b> <b>\$5084 w/RSS</b>
<b>C-MNMS4448-150</b>	Midnite Pre-Wired Magnum MS4448PAE Inverter & Classic 150 Charge Controller	<b>\$4900</b> <b>\$5125 w/RSS</b>
<b>C-MNMS4024D215</b>	Midnite Pre-Wired 2 Magnum MS4024PAE Inverters & 2 Classic 150 Charge Controllers	<b>\$9604</b> <b>\$10054 w/RSS</b>
<b>C-MNMS4448D215</b>	Midnite Pre-Wired 2 Magnum MS4448PAE Inverters & 2 Classic 150 Charge Controllers	<b>\$9687</b> <b>\$10137 w/RSS</b>

All Midnite Solar Pre-Wired Systems ship via freight carrier. Please give us a call for a quote.

# PRE-WIRED SYSTEMS

## SCHNEIDER CONEXT SW & XW+/CLASSIC

This build by Midnite Solar combines a Schneider Conext SW inverter with a Midnite Classic150 charge controller. Choose between the 24 volt Conext SW4024 inverter or the 48 volt Conext SW4048 inverter. The inverter is side-mounted to the Midnite SW E-Panel, with the charge controller on the opposite side. The Schneider SCP is panel mounted in the front of the E-Panel. Battery bank monitoring is covered with a Midnite WhizbangJr with the relevant information displayed via the Classic150.

Other features of the configuration include: charge controller, inverter and AC breaker sets, three Midnite Surge Protectors, Arc and Ground Fault protection via the Classic150, and both Midnite and Schneider temperature sensors. The Schneider inverter is a 120/240 VAC capable inverter. RSS versions are Rapid Shutdown compliant.



Midnite Solar's pre-wired systems are listed by ETL for US & Canada. The warranties for these panels are covered by the manufacturer's warranties for each individual product.. All Midnite components have a 5 year warranty.

Pre-Wired systems featuring Outback products are available by request.

ITEM #	Description	Price
<b>C-MNSW4024C150</b>	Midnite Pre-wired Schneider SW4024 & Classic 150 Charge Controller	<b>\$4593</b> <b>\$4818 w/RSS</b>
<b>C-MNSW4048C150</b>	Midnite Pre-wired Schneider SW4048 & Classic 150 Charge Controller	<b>\$4778</b> <b>\$5000 w/RSS</b>
<b>C-MNXW5548C150</b>	Midnite Pre-Wired Schneider XW5548 Inverter & Classic 150 Charge Controller	<b>\$6965</b> <b>\$7190 w/RSS</b>
<b>C-MNXW6848C150</b>	Midnite Pre-Wired Schneider XW6848 Inverter & Classic 150 Charge Controller	<b>\$7601</b> <b>\$7826 w/RSS</b>
<b>C-MNXW5548D215</b>	Midnite Pre-Wired 2 Schneider XW5548 Inverters & 2 Classic 150 Charge Controllers	<b>\$13491</b> <b>\$13941 w/RSS</b>
<b>C-MNXW6848D215</b>	Midnite Pre-Wired 2 Schneider XW6848 Inverters & 2 Classic 150 Charge Controllers	<b>\$14760</b> <b>\$15210 w/RSS</b>

All Midnite Solar Pre-Wired Systems ship via freight carrier. Please give us a call for a quote.

# HOW A CHARGE CONTROLLER WORKS

**PWM CHARGE CONTROLLERS** are connected between the charging source and the battery. Pulse width modulation (PWM), used in all modern charge controllers uses 3-stages of operation to give the most charging possible for the day.

**BULK** charge is the first stage, where the maximum power available from the charging source is fed to the battery until it reaches a preset voltage.

**ABSORPTION** is the second stage charge where the maximum battery voltage is held by reducing the charge current just enough to never exceed the target voltage. Reduced current is done by high speed on and off pulsing, where the controlling "on" time versus the "off" time of each pulse determines the average charge current. During this stage of charging there will be some bubbling, or gassing of the battery electrolyte. This is necessary to maintain the health of flooded batteries.

**FLOAT** is a third stage where battery voltage is reduced after charge is complete. This avoids excessive evaporating of battery water and benefits battery life. When sealed, maintenance-free, AGM or gel type batteries are used, voltage set-points are lower to prevent gassing of the battery.

**DIVERSION CHARGE CONTROLS** are connected between a battery & dump load. They are typically used when the charging source cannot be disconnected from the battery, such as wind generators or hydroelectric chargers.

Diversion controllers do not cut off current from the charging source at all. When the battery charges to the maximum set voltage, the diversion controller connects a "dump load" such as ceramic air heating resistors or water heating elements to the battery to dissipate the energy coming from the charging source. The controller adjusts its consumption rate to offset the excess charging exactly, and keep the battery voltage at, and never exceeding, the preset maximum voltage. If a windmill without its own charge controller is used, or a hydroelectric generator, a diversion control must be used, since those generators can be damaged if their charge is not absorbed in the batteries at all times. One diversion control handles a combination of solar, hydro and wind, so long as the total amps charge from all of them taken together is within its amp capacity.

**MPPT CHARGE CONTROLLERS** employ DC to DC conversion, which allows the solar array voltage to be higher than the voltage required to charge the batteries. Many years ago solar modules were designed to charge 12 volt batteries. These solar modules were built with 36 cells in series to have a peak power voltage of 16- 18 volts. Two of these modules could be wired in series to charge a 24 volt battery and four could be wired in series for a 48 volt battery. Modules with 72 cells were also available for 24 volt charging. When all modules were made this way, the simple PWM charge controllers described on the previous page worked fine. As grid connected solar became the prominent use for solar modules, cost became the most important factor in module design. This led to larger 60 cell modules, manufactured in a convenient size that could be carried by one person. These modules have a voltage too high for 12 volt battery charging and too low for 24 volt battery charging and are usually wired in series to get higher voltage. The MPPT charge control makes use of this higher voltage.

36-cell modules are available with power outputs up to 100 watts and 72 cell modules are available with power outputs up to 370 watts. These modules cost more per watt, but can be used with lower cost PWM charge controllers. It makes economic sense to use these modules on systems that required less than 700 watts. If the power required is greater than 700 watts, the cost savings on the solar modules and the wire between the modules and the batteries to pay the added cost of a MPPT charge controller.

## MPPT CHARGE CONTROLLERS cont'd:

MPPT charge controllers from Schneider Electric, Magnum, Outback, Morningstar and MidNite Solar can operate with a maximum input voltage from a solar array of 150 volts, which can be used with three 60 cell modules in series. Other models from MidNite Solar can be used with arrays up to 250 volts allowing the use of six 60 cell modules in series and Schneider offers a model that can be used with arrays up to 600 volts.

An added advantage to using a higher voltage solar array made from modules wired in series is that much smaller wire can be used between the solar array and the charge controller without significant power loss. Every time voltage is doubled in a wire, four times as much wattage is carried with the same loss. This saving increases tremendously when going from 15 volts in a wire to 150 volts.

When choosing an MPPT charge controller, the amp rating of the controller is the maximum amperage that it can supply to the battery being charged. To find this amperage, add the wattage of all modules in the array and divide by the battery voltage. For example, six 240 watt modules have a total wattage of 1440 watts. If charging a 12 volt battery, the charge controller amps required is 120 amps ( $1440 / 12 = 120$ ). In this case, two controllers with 60 amp or greater rating are necessary. If charging a 24 volt battery, only one 60 amp charge controller would be required. If you are using a 48 volt battery, an array of 2800 watts can use a single 60 amp charge controller.

**SELECTING A CHARGE CONTROL** - Charge controllers regulate the output of solar modules, wind generators and hydroelectric generators to prevent overcharging of the battery. When battery voltage rises to a preset maximum, where the battery is completely charged, the control automatically reduces or stops the solar charge. Some charge controllers are that simple, but most include some other features like volt and amp meters, voltage conversion, low battery load disconnect or night light timer.

**VOLT & AMPERE RATING OF THE CONTROL** - Select a control able to handle a little more than the amperes the solar modules are rated to generate. Though solar modules do not usually produce more than their rated amperes, they can momentarily produce 15% more on cold bright days. The electric code recommends leaving a 25% margin. For example, a 47 amp solar array would use a 60 amp control rather than a 50 amp control. And if future expansion of your solar array is planned, allow a lot more headroom to accommodate the added panels. Be sure the model chosen is designed for the correct battery voltage: 12, 24 or 48 volts. A given control will handle twice as many solar modules watts in a 24 volt system as in a 12 volt. Maximum power point tracking "Boost" and voltage converting controllers are rated for the boosted output to the battery, not the slightly lower solar input amperes.

**FEATURES TO LOOK FOR** - A **battery voltmeter** and **solar amp meter** are needed to show that the battery is really getting charged. Most controllers have those meters built in or optional. We always recommend a control with built-in amp meters and volt meters.

**User-adjustable battery voltage set points** is a feature of most controllers, so voltage can be set exactly for the battery type, temperature and age.

**Battery Temperature Sensor** is available for some to automatically adjust charge voltage for batteries exposed to large temperature changes.

**Automatic or Manual Equalization**, when used properly with flooded batteries, gives an occasional overcharge to ensure all cells achieve 100% charge. The equalization feature is not used on sealed AGM and Gel batteries.

# CHARGE CONTROLLER SELECTION

MPPT Charge Controllers					
MODEL	Amps	Digital Display	Web Enabled	Page	PRICE
Magnum PT-100	100	Yes	Yes	74	\$1014
Outback FM80	80	Yes	Yes	72	\$528
Schneider XWMPPT80	80	Yes	Yes	73	\$1344
MidNite Classic 150	76-96	Yes	Yes	71	\$727
MidNite Classic 200	63-79	Yes	Yes	71	\$727
MidNite Classic 250	53-62	Yes	Yes	71	\$825
Outback FM60	60	Yes	Yes	72	\$456
Schneider XWMPPT60	60	Yes	Yes	73	\$601
MidNite Kid	30	Yes	No	75	\$360
PWM Charge Controllers					
MODEL	Amps	Digital Display	Voltages	Page	PRICE
Morningstar Tristar 60	60	Optional	12, 24, 48	76	\$232
Schneider C60	60	Yes	12, 24	77	\$169
Morningstar Tristar 45	45	Optional	12, 24, 48	76	\$176
Schneider C40	40	Yes	12, 24, 48	77	\$147
Schneider C35	35	Yes	12, 24	77	\$104
Morningstar Prostar 15	15	No	12, 24	79	\$96
Morningstar Prostar 15M	15	Yes	12, 24	79	\$152
Morningstar Prostar 30	30	No	12, 24	79	\$128
Morningstar Prostar 30M	30	Yes	12, 24	79	\$186
Morningstar SunSaver 20	20	No	12	78	\$96
Morningstar SunSaver 20	20	No	24	78	\$103
Morningstar SunLight 20	20	No	12	78	\$115
Morningstar SunLight 20	20	No	24	78	\$122
Morningstar SunSaver 10	10	No	12	78	\$68
Morningstar SunSaver 10	10	No	24	78	\$76
Morningstar SunLight 10	10	No	12	78	\$90
Morningstar SunLight 10	10	No	24	78	\$96
Morningstar SunGuard	4.5	No	12	79	\$33





# MIDNITE CLASSIC

The MidNite Classic charge controller with arc fault detection maximizes the flexibility and features available in a charge controller. These controllers also feature ground fault protection so that a separate GFP breaker assembly is not necessary. This allows for more breaker space in the DC box. There are three models available that accommodate solar arrays up to 150, 200, or 250VDC of operating voltage.

MPPT modes with user adjustable power curves for solar, wind or hydro are built in, along with a learning mode for self-optimization. No hub is required for stacking multiple units. They have two auxiliary outputs, a dry contact relay and a 12V output.

The Classic has the ability to be sealed for protection from salt air or dust by installing optional plastic covers (sold separately). Note that the charge controller will be slightly de-rated (will put out less power) by sealing it.

MidNite Solar offers an industry first; an extended warranty for all the Classic MPPT charge controllers. Six months prior to the end of the warranty period customers can ship their Classic back to MidNite Solar with a check for \$147 dollars plus shipping and they will replace any wearable parts and do a general tune-up. This will extend the warranty by 2 additional years, another good reason to purchase a Classic. **Note:** Max 4awg wire for battery +/- and PV +/-.



Dimensions: 14.9" x 6" x 4" / Weight: 12 lbs / Five year warranty / ETL Listed

ITEM #	Description	Price
<b>C-MID-MPPT150</b>	150V MidNite MPPT Charge Controller	<b>\$727</b>
<b>C-MID-MPPT200</b>	200V MidNite MPPT Charge Controller	<b>\$727</b>
<b>C-MID-MPPT250</b>	250V MidNite MPPT Charge Controller	<b>\$825</b>
<b>C-MID-BTS</b>	MidNite Battery Temperature Sensor	<b>\$27</b>

# OUTBACK FLEXMAX 60 AND 80



The FLEXmax family of charge controllers is the latest innovation in Maximum Power Point Tracking (MPPT) charge controllers from OutBack Power Technologies. The innovative FLEXmax MPPT software algorithm is both continuous and active, increasing the photovoltaic array power yield up to 30% compared to non-MPPT controllers. Active cooling and intelligent thermal management cooling, both FLEXmax charge controllers can operate at their full maximum current rating, 60 Amps or 80 Amps respectively, in ambient temperatures as high as 104°F (40°C). Since the control can boost output current, solar input equal to 48 amps for the FM60 and 64 amps for the FM80 is maximum recommended. Includes Multi-stage charging plus equalize: Bulk, Absorption, Float, and Equalize. On board 200 ma auxiliary output terminals.

The four-line 80 character, backlit LCD display, standard on both Outbacks displays the PV system's performance. It is also used for easy programming and monitoring of the system's operation. Terminals accept up to 4 gauge wire.

OUTBACK FM60 - Dimensions: 13.75" x 5.75" x 4.5" / Weight: 11.65 lbs

OUTBACK FM80 - Dimensions: 16.25" x 5.75" x 4.5" / Weight: 12.20 lbs

Five year warranty / ETL Listed

ITEM #	Description	Price
C-OB-FM60	FLEXmax FM60 OutBack Charge Controller	\$456
C-OB-FM80	FLEXmax FM80 OutBack Charge Controller	\$528
C-OB-TEMP	15" sensor compensates charge voltage to battery temp	\$44

# SCHNEIDER ELECTRIC

## XW MPPT



XW MPPT60

THE SCHNEIDER XW MPPT60 has a two or three-stage charging process, with manual equalization to maximize system performance and maintain expected battery life.

Maximum Power Point Tracking (MPPT) delivers the maximum available power from a PV array to a battery bank. Controller has a configurable auxiliary power output

Easy to read, two-line, 16-character liquid crystal display (LCD) and four buttons for configuration and system monitoring in stand-alone applications.

Battery Temperature Sensor (BTS) provides automatic temperature-compensated battery charging. The charge controller is able to communicate its settings and activity to other Xanbus-enabled devices which may require an RS-232 to USB connector, available at most electronic stores such as Radio Shack.

THE SCHNEIDER XWMPPT80 was the first PV battery charger to use DC input voltages up to 600V. This significantly decreases the current needed in the array. This allows for reduced wire gauges and costs, increased string sizing of the array, and placement of the array farther from the battery bank. A PV array combiner is not required for many installations, please check with us. It can be used with PV arrays with voltages ranging from 195 to 550 VDC and can support an output of up to 80 amps into the battery for battery voltages of 24 or 48 VDC. The PV open circuit voltage must not exceed 600 VDC.



XW MPPT80

It has a configurable auxiliary output to drive a relay for load control or to turn on devices such as a vent fan or indicator alarm. Auxiliary output can be configured to perform only one function at a time. Built in PV ground fault protection allows code-compliant installation without the need for additional ground fault protection. The XWMPPT80 requires the XW System Control Panel (SCP) to operate. See page 100-102.

Standby and night-time power draws less than one watt.

XWMPPT60 - Dimensions: 14.5" x 5.75" x 5.5" / Weight: 10.75 lbs

XWMPPT80 - Dimensions: 30" x 8.6" x 8.6" / Weight: 29.80 lbs

Five year warranty / ETL Listed to UL 1741

ITEM #	Description	Price
<b>C-XWMPPT60</b>	60A, 150VDC MPPT PV Charge Controller	<b>\$601</b>
<b>C-XWMPPT80</b>	80A, 600VDC MPPT PV Charge Controller HIGH VOLTAGE	<b>\$1344</b>



# MAGNUM PT-100



The PT-100 MPPT Controller is Magnum Energy's first offering to the solar charge controller market. Added to their proven inverter and power panel product lines; Magnum now offers a complete solution to the core of off-grid solar electric system design.

The PT-100 is an MPPT controller rated for an impressive 100 amp output to the battery bank. This means flexibility of panel selection, array configuration, and transmission distance, as well as the ability to accommodate some of the largest array sizes with the use of a single controller.

The input voltage rating of up to 187 volts allows the panel configuration to be designed using fewer, high voltage strings of panels; offering savings in cabling, circuit breakers, combiner box selection, and transmission wire sizing over modest distance of 50 feet and up. Small incremental savings like this can quickly

add up to hundreds of dollars or more and are a practical consideration of any medium or larger system design. The 100 amp output rating means the PT-100 has a impressive maximum array size of 6,600 watts.

Features include: Front panel display for array and battery bank status, charge state and fault indicators, operational Select and Reset buttons, traditional 3-stage charging with manual equalization, on-board configuration DIP switch for "stand-alone" applications, integrated PV Ground Fault and Arc Fault detection/interruption, over temperature protection and de-rating in hot temperatures (room temperatures of 104 F and greater), output over current protection, 255 days of PV harvest and battery amp-hour data logging, programmable dry contact auxiliary relay, easy set-up and integration with Magnum inverters and Advanced Router remote control supports on-site software upgrades. The PT-100 is NOT protected against reverse polarity wiring on the PV or battery side. A voltmeter must be used to ensure proper wiring polarity during installation.

ITEM #	Description	Price
C-ME-PT100	Magnum PT-100 Charge Controller	\$1014

# MIDNITE KID



The MidNite Kid is a versatile, mid-size, MPPT charge controller suitable for use with a wide selection of solar panels. The Kid is capable of charging 12, 24 and 48 volt battery banks, delivering up to 30 amps, allowing array sizes of 420, 840, and 1680 watts, respectively. With an input Voc rating of 150 volts along with MidNite's standard HyperVoc design, the Kid can handle input voltages as high as 162 volts.

Two Kids can be stacked for parallel operation. Adjustable charging setpoints for bulk, absorb, float, and equalization charging. No cooling fan (not necessary) and sealed for harsh environments. Order temperature sensor separately.

AGS (Auto Generator Start) - The Kid is the first charge controller in the industry to feature a two wire Automatic Generator Start (AGS) as standard equipment. The KID detects when the generator is running by simply watching battery voltage over time. No extra wires or voltage sensing is required making installation a snap.

Lighting Controller - The Kid has a fully adjustable intelligent lighting controller built in. It can turn lighting on at dusk for a select number of hours, turn it off for a length of time and then back on for a programmable number of hours before dawn. All time functions are fully adjustable, allowing users to save valuable energy.

Dimensions: 9.25" x 5" x 3.3" / Weight: 6 lbs / Two year warranty / ETL Listed



ITEM #	Description	Price
C-MID-KID-B	MidNite 30A MPPT Charge Controller	\$360
C-MID-BTS	MidNite Battery Temperature Sensor	\$27

# MORNINGSTAR TRISTAR 45 OR 60

12, 24, or 48 Volts

*Three function controller for solar battery charging, diversion regulation, or load control*

**CONSTANT CHARGE VOLTAGE:** 3-Stage control method plus Equalization for up to 60 amps of regulation for 12 to 48 volt systems. Dip switches allow the user to accurately select **Bulk, Float, and Equalization Voltage** set points from 7 preconfigured options. Or a RS232 port allows connection to a PC for custom settings, data logging, and remote monitoring. Extensive self protecting electronic features.



\*Shown with optional display

**LIGHTING CONTROL MODE:** may be custom set to turn lights on and off for loads up to 60 amps.

**90 DAYS OF DATA LOGGING:** record daily min/max voltages, amps, amp-hours, kWhrs, faults, alarms and many other parameters. Logged data can be viewed on a TriStar Meter2 (C-TRISTARDD below) or downloaded and graphed in MSView.

**NETWORKING CAPABILITY with METERHUB**

**BATTERY EQUALIZING:** automatically equalizes batteries once a month, or can be started manually anytime or disabled for sealed battery.

**OPTIONAL DIGITAL DISPLAY:** shows both charge amps and battery volts plus a count of amp-hours of charge since last reset. Also records high and low battery voltages since last reset. New screenshots have been added for logged data. **Highly recommended.**

**AS A DIVERSION CONTROL:** TriStar 45 or 60 can be used as diversion control for wind or hydro. To set up as diversion control, order air or water heat diversion resistors found at the end of this charge control section.

Built-in terminals accept wire size up to 2 gauge.

Dimensions: 10.3" x 5.0" x 2.8" / Weight: 3.5 lbs / Five year warranty / UL Listed

ITEM #	Description	Price
C-MS-TRISTAR45	TriStar 45 Charge Control	\$176
C-MS-TRISTAR60	TriStar 60 Charge Control	\$232
C-MS-TRISTARDD	Digital Display (for either controller)	\$100
C-MS-TRISTARRD	Remote Digital Display with 98' cable	\$125
C-MS-TRISTARRT	30' plug-in Battery Temperature Sensor	\$29
C-MS-TSHUB1	TriStar MeterHub	\$99

# SCHNEIDER CHARGE CONTROL

## C-35, C-40, C-60

**C35 is 35 Amps, 12 or 24 volt**

**C40 is 40 Amps, 12, 24, or 48 volt**

**C60 is 60 Amps, 12 or 24 volt**

**3-stage voltage control for Solar; or  
Diversion control for Hydro or Wind; or  
Load Control**



Constant Charge Voltage: 3-Stage control method: full solar charge to the maximum Bulk Voltage selected; then tapers off charge in Absorption mode, just enough to keep batteries at, but not exceeding, the selected bulk voltage. After one hour at bulk voltage, a lower Float Voltage takes effect to prevent overcharge.

**BATTERY EQUALIZING:** Higher voltage automatically equalizes batteries once a month, or can be started manually anytime, or disabled for sealed batteries. Lights will flash from green to red to show equalization is in progress.

**AS A DIVERSION CONTROL:** C35, C40 & C60 can be used as diversion control for wind or hydro. To set up as diversion control, order air or water heat diversion resistors found at the end of this charge control section.

Built-in terminals accept wire size up to 2 gauge. For home or RV use.

C35 - Dimensions: 8" x 5" x 2.5" / Weight: 2.7 lbs

C40 & C60 - Dimensions: 10" x 5" x 2.5" / Weight: 3.1 lbs

Two year warranty / UL Listed

ITEM #	Description	Price
C-35-ONLY	35 Amp Charge Control	\$104
C-40-ONLY	40 Amp Charge Control	\$147
C-60-ONLY	60 Amp Charge Control	\$169
I-TEMP	Optional 15' plug in Battery Temperature Sensor	\$35
C-CM-R50	Remote Digital Display with 50' cable	\$100

# MORNINGSTAR SUNSAVER



The SunSaver is a very reliable small charge controller. Constant voltage pulse width modulation charging is a proven advance compared to the common on/off PV regulators. SunSavers are modifiable for sealed or flooded batteries. A rugged anodized aluminum case and epoxy encapsulated electronics enhance durability and longevity. A temperature compensation sensor in the charge controller varies full charge voltage with temperature. May be used in parallel for higher current. LED charging and load control indicators in Low Voltage Disconnect (LVD) models. Settings are non-adjustable. Sealed setting is 14.1V, flooded setting is 14.4V. Low voltage disconnect happens at 11.6V, and reconnects when voltage gets to 12.6V. Must be connected to batteries to see output.

Dimensions: 6" x 2.2" x 1.3" / Weight: 8 oz / Five year warranty / ETL Listed

ITEM #	Description	Price
C-MS-SS-10L-12	12 Volt, 10 Amp charging and LVD	\$68
C-MS-SS-10L-24	24 Volt, 10 Amp charging and LVD	\$76
C-MS-SS-20L-12	12 Volt, 20 Amp charging and LVD	\$96
C-MS-SS-20L-24	24 Volt, 20 Amp charging and LVD	\$103

MPPT VERSIONS ARE AVAILABLE FOR SPECIAL ORDER

# MORNINGSTAR SUNLIGHT



- 10 adjustable lighting control options
- Special on/off/on lighting functions
- Low Voltage Disconnect protection
- Detects day and night using the PV array

Morningstar's SunLight solar lighting controller combines the SunSaver design with an advanced controller for automatic lighting control functions. Four Versions Available. 12V or 24V and 10A or 20A.

Dimensions: 6" x 2.2" x 1.3" / Weight: 9 oz / Five year warranty / ETL Listed

ITEM #	Description	Price
C-MS-SL-10L-12	12 Volt, 10 Amp charging and LVD	\$90
C-MS-SL-10L-24	24 Volt, 10 Amp charging and LVD	\$96
C-MS-SL-20L-12	12 Volt, 20 Amp charging and LVD	\$115
C-MS-SL-20L-24	24 Volt, 20 Amp charging and LVD	\$122



# MORNINGSTAR PROSTAR



The Morningstar ProStar controller is a very reliable mid-range PWM controller. It has an estimated 15-year life. With a 3 position battery select: gel, sealed or flooded. The ProStar Controller has 4 stages of charging to provide increased battery capacity and life. It has built in temperature compensation or a remote temperature sensor can be added, if desired. LED's indicate battery status and faults. Capable of 25% overloads. Many electronic protections are built-in such as reverse polarity, short-circuit,

overload, reverse current at night, high temperature and voltage disconnection, lightning and transient surge protection, voltage spike protection and auto recovery. It uses a bulk voltage set point of 14.4 volts for flooded , lead-acid batteries. Terminals accept 14-6ga wire.

Dimensions: 6" x 4.1" x 2.3" / Weight: 12 oz / Five year warranty / CE Certified

ITEM #	Description	Price
<b>C-MS-PS-15</b>	12 or 24 Volt, 15 Amp charging with LVD	<b>\$96</b>
<b>C-MS-PS-15M</b>	12 or 24 Volt, 15 Amp charging with LVD & Digital Meter	<b>\$152</b>
<b>C-MS-PS-30</b>	12 or 24 Volt, 30 Amp charging with LVD	<b>\$128</b>
<b>C-MS-PS-30M</b>	12 or 24 Volt, 30 Amp charging with LVD & Digital Meter	<b>\$186</b>

# MORNINGSTAR SUNGUARD

4.5 amp, 12V Constant Voltage Charge Control

Very small charge control for single 60W, 36 cell panel (or smaller) and small battery. Constant voltage pulse width modulation. Regulates to constant 14.1 volts with temperature compensation. Six milliampere internal power consumption. No meters included, so these are best for fence chargers, small boats, radio repeater sites and other small unattended projects. Has wire leads, 2 solar, 2 battery. Not recommended for residential power system, because adding appropriate meters brings total cost higher than other small residential controls. Epoxy potted and sealed.



Dimensions: 2.5" x 2" x 1.5" / Weight: 3 oz / Five year warranty

ITEM #	Description	Price
<b>C-MS-SUNGUARD</b>	12 Volt only, factory set to 14.1 voltage	<b>\$33</b>

# LOADS FOR DIVERSION



When diversion control is needed for hydro, wind, or a combination with solar, use these heater loads with a diversion regulator. Charge controls that can operate in diversion mode are Schneider C series & Morningstar TriStar.

DIVERSION never disconnects the charge source from the battery. The charge control connects to the battery and absorbs or "burns off" exactly enough power to offset any excess charging. These loads dissipate the surplus power into heating air. Diversion heat loads should be selected for at least as many amps as all charging sources combined, but must be within the maximum ampere rating of the charge control to be used.

ITEM #	Description	Price
<b>AIR HEATER DIVERSION LOAD box as pictured with connection terminals</b>		
<b>C-HL-12V</b>	Diversion Heat Load - 50A - 12V - 750W 8" x 12" x 4"	<b>\$177</b>
<b>C-HL-24V</b>	Diversion Heat Load - 35A - 24V - 1000W 8" x 12" x 4"	<b>\$175</b>
<b>C-HL-48V</b>	Diversion Heat Load - 36A - 48V - 2160W 12" x 16" x 4"	<b>\$245</b>

# BATTERIES

Battery care is the main responsibility with home made electricity. This is the one part of the power system likely to be harmed by neglect or misuse. Lead-acid batteries, the standard for off-grid, should not be discharged more than 50% and then ideally are recharged to 100% promptly. They can be damaged by undercharging, continued overcharging, or contamination.

Sizing of 1000 to 2000 amp-hour 12 volt (or 1/2 that in 24 volt or 1/4 that in 48 volt) battery bank is desirable because a larger bank can accept faster charging by generator and give high power discharge for inverter surge without strain. In northern areas short on winter sunshine, more reserve before running down to the 50% level is also a benefit. Use our 6 examples in the introduction of this catalog as a guide to battery size, or call for advice. In sunny southwest, a smaller battery bank is acceptable. Keep in mind that mixing new and old batteries is not recommended. No two batteries should be more than a year apart in age in the same battery bank. A smaller scale, "starter" battery bank can be implemented for a lower cost that can be operated for 4-5 years. Then a larger capacity set of batteries with a lifespan of 10-15 years and higher cost would be suitable for long term planning. A battery sizing worksheet can be found at the end of the catalog on page 158.

**DEEP CYCLE LEAD-ACID** batteries have thicker plates and lead-antimony support grids for years of over 50% deep cycle charge and discharge. Golf cart batteries and the larger L-16RE style batteries from Trojan and Crown are some of the most common, along with the industrial batteries from Surrrette and Deka's Maintenance Saver. Auto style batteries are for shallow cycling only. CAT, automobile, and truck batteries are NOT deep cycle and will not last long in home power. These have thinner plates and lead-calcium grids designed for less than 20% discharge and immediate recharge.

**RV/MARINE:** This common 12V battery is designed about half way between a deep cycle and a shallow cycle, and has a medium length of life.

**SEALED BATTERIES** Gel or AGM (absorbed glass matt) types damage easily from overcharge, and so should be used with a 3 stage charge control. Sealed batteries can be excellent deep cycle alternative energy batteries, cleaner and safer, but only if charging is precisely controlled. Since water cannot be replaced and hydrometer testing is not possible, they are considered special purpose batteries.

**NICKEL CADMIUM (ALKALINE) BATTERIES:** Unlike lead acid batteries, deep discharging and failure to recharge does not shorten battery life. However, used ones are often overpriced and defective. Cost is much higher than lead acid. Voltage swings higher when charging and lower when using. Charge efficiency (energy charged in versus energy returned) is low. Disposal and recycling can be difficult and costly. Be cautious of alkaline batteries.

**LITHIUM BATTERIES:** Lithium-Ion batteries are still relatively new to off-grid energy systems but they are becoming main stream. There are several advantages for the Lithium/Iron battery. Among these advantages are longer cycle life, no off-gassing, higher efficiency and they don't have to be fully charged. This can mean much less required charging in the winter. Be aware the Lithium batteries are not intended for cold weather operation; below 32°F.

# ROLLS/SURRETTE BATTERIES



This generation of industrial, deep cycle, flooded lead acid battery offers high capacity and heavy duty plate grids which resist positive plate breakdown.

The plates are double insulated with glass mat and polyethylene envelope, eliminating the possibility of cracked or misaligned separators, and shorting.

Each 2 volt cell (in the KS/CS/YS product line) is built into its own lightweight container made of durable polypropylene. The cells are then assembled into a tough outer container with a removable lid. Even if this outer container cracked, acid spills are prevented and the battery still operates. The individual cells are bolted together allowing the battery to be disassembled and the cells individually removed for easy on-site installation. FREE Battery book with order.

KS/CS/YS series rated at 4300 cycles at a 50% Depth of Discharge; 7200 cycles at 20% Depth of Discharge, 5 year full replacement warranty.

Models B-S2-L16 and B-S6-L16-HC, 1900 cycles at a 50% depth of discharge, 3700 cycles at a 20% Depth of Discharge. 3 year full replacement warranty.

MODEL	VOLTS	AMP-HRS (20 hr)	L	W	H	LBs	PRICE
B-S2-L16	2	1169	12 1/2"	7 1/8"	16 3/4"	120	\$342
B-S6-L16-HC	6	445	12 1/2"	7 1/8"	16 3/4"	123	\$345
B-2-KS-33PS	2	1766	15 7/16"	8 5/16"	24 13/16"	208	\$766
B-2-YS-31PS	2	2430	15 1/2"	9"	31 5/8"	285	\$983
B-4-KS-21PS	4	1104	15 3/4"	9 3/8"	24 3/4"	267	\$947
B-4-KS-25PS	4	1350	15 3/4"	10 5/8"	24 3/4"	315	\$1114
B-6-CS-21PS	6	683	22"	9 3/4"	18 1/4"	271	\$986
B-6-CS-25PS	6	820	22"	11 1/4"	18 1/4"	318	\$1145
B-8-CS-17PS	8	546	28 1/4"	8 1/4"	18 1/4"	294	\$1084
B-8-CS-25PS	8	820	28 1/4"	11 1/4"	18 1/4"	424	\$1546

**19", 4/0 BATTERY INTERCONNECT CABLES INCLUDED (KS,YS and CS series only)**

Allow 4-6 weeks for delivery

**Due to the global lead market, prices may vary across the country and are subject to change without notice**

These batteries via truck freight. Give us a call for freight quote.

# CROWN BATTERIES

Crown Battery has been a player in the world battery market for more than 80 years; focusing on customers, quality, and value. Crown is now leveraging their existing dealer distribution network to make the Renewable Power line more readily available to a wider market of off-grid customers.

The CR-D06235 is a battery that falls into the typical “golfcart” size category. Golfcart batteries are best suited for smaller 12 volt based household systems; or small single purpose applications. The CR-D06390 & 430 batteries fall into the typical L-16 size category. L-16s are a common choice for medium sized residential systems. Each battery is 6 volts, made of three 2-volt cells in one unit. 2 year warranty.



B-CR-D06235



B-CR-D06390 & 430

MODEL	VOLTS	AMP-HRS (20 hr)	L	W	H	LBs	PRICE
B-CR-D06235	6	235	10.25"	7"	11.6"	63	<b>\$157</b>
B-CR-D06390	6	390	12.4"	7.2"	16.1"	115	<b>\$296</b>
B-CR-D06430	6	430	12.4"	7.2"	16.1"	122	<b>\$336</b>

REMEMBER TO ORDER BATTERY INTERCONNECT CABLES..

**Due to the global lead market, prices may vary across the country and are subject to change without notice.**

These batteries via truck freight. Give us a call for freight quote.

# TROJAN BATTERIES



**SPRE 06 225 (T-105)**



**SPRE 06 415 (L16-RE)**

Trojan has the best price per amp-hour of any quality mass produced consumer battery. Trojan suggests 1200 cycles to 50% DoD.

Each battery is 6 volts, made of three 2-volt cells in one unit. Six volt batteries are series connected in pairs for 12 volts, or in a strings of four batteries for 24 volts or eight to make 48 volts. Then several of these series strings may be parallel connected to add more ampere-hour capacity. Interconnect diagrams are supplied. Life expectancy is 5+ years for the T-105; and 8 years for the B-SPRE06415 (L16-RE). 1 year warranty.

MODEL	Volts	Amp Hr (20 hr)	L	W	H	LBs	PRICE
B-SPRE06255	6	225	10"	7"	11"	65	\$199
B-SPRE06415	6	370	12"	7"	18"	118	\$397

**REMEMBER TO ORDER BATTERY INTERCONNECT CABLES**

**There are many pick up locations around the U.S. to avoid freight charges.  
Give us a call to find out if there's one near you!**

# DISCOVER LITHIUM-ION BATTERIES



B-DI-LI-42-48



Using drastically different chemistry and architecture than traditional battery types, lithium ion batteries provide for a deeper depth of discharge and longer lifespan, all in a smaller package. Unlike previous battery types, where a set of batteries is charged and discharged as a single unit, lithium ion batteries require management on a per cell basis, often managed by an integrated Battery Management System that is built into the battery. With lower internal resistance than traditional batteries, Li-Ion batteries can be charged and discharged at much higher rates (higher amperages) than normal. Lithium batteries can also be operated at a partial stage of charge for

extended periods without suffering any ill effects. The fast charging and operation at a partial state of charge can allow for shorter generator run times, and convenient charging as getting the battery back to fully charged is not necessary.



The on board Battery Management System (BMS) monitors cell and battery voltage, battery current, temperature, and state of charge. The BMS also performs balancing of the individual cells, micro-managing the charging of each cell individually. The BMS sounds a buzzer when fault limits are reached, reports a fault, and then will shut the battery down after a delay of 120 seconds.

B-DI-LI-44-24

MODEL	Volts	Capacity	L	W	H	LBs	PRICE
<b>B-DI-LI-44-24</b>	24	2800 watt-hours	13"	13.3"	10.8"	88	<b>\$3550</b>
<b>B-DI-LI-42-48</b>	48	6650 watt-hours	18.5"	13.7"	14.7"	192	<b>\$7200</b>

These batteries ship via truck freight. Please call for a quote.

# CONCORDE SEALED BATTERIES



Completely sealed valve regulated Absorbed Glass Mat (AGM) battery. Non-spillable and maintenance free, never requires watering. No gas, it is all recombined within the battery. Exterior stays clean and safe. AGM has no problems like gel batteries separating from plates. Can be transported safely by air or any other means,

and are exempt from D.O.T. hazardous material category. No UN labels required for international air shipping. Recycle anywhere that processes automobile batteries. See a report on these in Home Power Magazine, issue 75, page 88. Sealed batteries require 3 stage charge control set exactly to manufacturer's instruction, and NO equalize charging. 12 month warranty after install, or 18 mo. from date of purchase. Expected life is 5 years at 30% depth of discharge.

ITEM #	Volts	Amp Hr (20 hr)	L	W	H	LBs	Ship Via	Price
<b>B-CO-2580L</b>	12	258	20.76"	10.8"	9.73"	165	Freight	<b>\$773</b>
<b>B-CO-2120L</b>	12	212	20.76"	8.7"	9.76"	138	Freight	<b>\$648</b>
<b>B-CO-1080</b>	12	108	12.9"	6.75"	8.96"	70	UPS*	<b>\$353</b>
<b>B-CO-890</b>	12	89	12.9"	6.75"	8.96"	62	UPS*	<b>\$320</b>
<b>B-CO-2240</b>	6	224	10.28"	7.06"	9.99"	67	UPS*	<b>\$361</b>
<b>B-CO-3050T</b>	6	305	10.28"	7.06"	12.94"	91	Freight	<b>\$455</b>
<b>B-CO-4050HT</b>	6	405	11.64"	6.95"	15.73"	120	Freight	<b>\$690</b>
<b>B-CO-9150</b>	2	915	10.28"	7.06"	13"	94	Freight	<b>\$482</b>

\* Large quantities ship via FREIGHT TRUCK. Call us for a quote.

REMEMBER TO ORDER BATTERY INTERCONNECT CABLES



# DEKA GEL BATTERIES



The Deka Solar series of batteries is designed to offer reliable, maintenance-free back-up power for grid-tied backup or remote access renewable energy applications where minimum maintenance is desirable. Deka gel batteries are the industry standard in grid-tied back-up power, with reliable performance. The quality of their products is recognized worldwide and has met the global requirements of ISO 9001 and ISO/TS 16949 certification standards. Deka is also a leader in innovative recycling and has met global environmental requirements of ISO 14001 certification standards. Deka makes recycling the battery convenient with a network of factory warehouses located throughout the United States and Canada.



2 year full replacement on monobloc GEL.

**Industrial UNIGY & UNIGY II lines are also available by special order.**

ITEM #	Type	Volts	Amp Hrs	L	W	H	LBs	Price
<b>B-DK-8G30H</b>	GEL	12	97.6	12.94"	6.75"	9.75"	70	<b>\$294</b>
<b>B-DK-8G4DLTP</b>	GEL	12	183	20.75"	8.5"	10"	127	<b>\$572</b>
<b>B-DK-8G8DLTP</b>	GEL	12	225	20.75"	11"	10"	157	<b>\$700</b>
<b>B-DK-8GGC2</b>	GEL	6	180	10.25"	7.13"	10.88"	69	<b>\$317</b>

Shipping: Call for freight quote or batteries may be available for pick-up in limited locations. Free/reduced shipping on large orders to a commercial address w/ dock.

Due to the global lead market, prices may vary across the country and are subject to change without notice. REMEMBER TO ORDER BATTERY INTERCONNECT CABLES.

# BATTERY INTERCONNECT CABLES

To connect individual batteries together. Total load divides equally among battery strings in parallel so 2 gauge may be adequate within each series string. Heavier 2/0 is for connections between ends of series strings. Heaviest 4/0 Shunt Cable connects battery negative to meter shunt. Eyelet lug on each end as pictured. Custom lengths are also available.



ITEM #	Description	Price
O-BIC-2G-UL	2 gauge copper, 15", 5/16" bolt holes, UL	\$10
O-BIC-2/0-UL	Heavier 2/0 gauge copper, 15", 3/8" bolt holes, UL	\$14
O-BIC-4/0-UL	Heavier 4/0 gauge copper, 15", 3/8" bolt holes, UL	\$20
O-SHUNT2G-24UL	2 gauge copper, 24", 3/8" bolt holes, UL	\$12
O-SHUNT2/0-24UL	2/0 Copper, 24", 3/8" bolt holes, UL	\$18
O-SHUNT4/0-24UL	4/0 Copper, 24", 3/8" bolt holes, UL	\$25
O-SHUNT4/0-36UL	4/0 Copper, 36", 3/8" bolt holes, UL	\$32

**BATTERY LUGS** fit up to 3/8" battery or shunt bolts. Allen screw clamps wires up to 2/0 or 4/0 in size, or many smaller wires down to 14 gauge. Allen wrench included with either lug. Not code compliant with finely stranded wire.



O-AU2/0

ITEM #	Description	Price
O-AU2/0	Dual	\$5
O-AU4/0	Single	\$5.50



O-AU4/0

**WATER MISER BATTERY CAPS** Condensing pellets within the flip top lid capture and return electrolyte into each cell. Reduces electrolyte mist and watering needs but distilled water levels must be monitored and adjusted accordingly. One cap per cell required. Considered flame arresting.

ITEM #	Description	Price
B-MISER	Water Miser Cap	\$6 ea



**BATTERY TERMINAL COATING** Keeps vapors, atomized battery acid, and air off battery terminals, bolts, and wire ends. 3-ounce bottle with applicator does the entire battery bank and auto batteries too. ESSENTIAL for battery care.

ITEM #	Description	Price
O-BATCOAT	Battery Coating	\$17

# BATTERY HYDROMETERS

**HYDROMETERS** are the most accurate, direct and reliable indicators of battery state of charge.

**O-HYDRO-VOLT:** Durable, accurate, and easy to read; this German made hydrometer is the best offering we have ever had. A heavy duty plastic body resists breaking more than glass body units. The softer rubber ball stays flexible at a greater range of temperatures, and the built-in temperature compensation makes the reading more accurate and speeds up the testing exercise. **NOTE:** Do not let this unit freeze if you rinse it after use, as instructed.



O-HYDRO-VOLT

**O-HYDROMETER-2:** This glass hydrometer is also temperature compensated for an even better indicator of a battery's state of charge. Flared barrel makes it easier to take readings quickly without the float sticking to the barrel.



O-HYDROMETER-2

ITEM #	Description	Price
O-HYDRO-VOLT	Plastic, German-made	\$25*
O-HYDROMETER-2	Glass, American-made	\$64**

\* The O-HYDRO-VOLT is just \$10 when purchased w/ any of our flooded batteries.

\*\* The O-HYDROMETER-2 is \$30 when purchased w/ any of our flooded batteries.

# BATTERY BOX VENT FANS

Ready made 12, 24, or 48 volt fan in pipe section with back-draft damper for easy installation in the battery vent pipe. The automatic switch below will control a 12 or 24 volt fan. 12 and 24 volt models go in 2 inch PVC pipe. 48 volt model has a 2 inch pipe inlet and 3 inch outlet. Two year warranty.



ITEM #	Description	Price
O-PVENT-12	12 Volt, draws 3 Watts	\$84
O-PVENT-24	24 Volt, draws 3 Watts	\$84
O-PVENT-48	48 Volt, draws 6 Watts	\$116

With charge controllers with auxillary output, such as the OutBack FlexMax, use our O-MINIRELAY rather than the O-VENTCONTROL.

ITEM #	Description	Price
O-MINIRELAY	12V Relay for Aux Output Terminal	\$20



# BATTERY CHARGERS

A battery charger converts AC power from the generator or from the power company into low voltage DC to charge a battery. During poor solar weather this avoids battery damage caused by extended periods without a full charge or deeper discharges due to heavy loads or colder battery temperature.

Some AC generators have a built-in DC battery charge feature of only 3 to 10 amps. To be effective, one or more 30 to 100 ampere battery chargers should be connected to the AC generator to rapidly recharge the battery bank. The generator runs a washing machine, well pump etc., making best use of more costly generator time.

**CHARGER SIZE AND TYPE:** Compatibility of generator and charger can be a big problem. Battery chargers of 30 to 150 amperes built into True Sinewave "standby" inverter chargers, and the separate electronic chargers in this catalog work well with most generators. *Honda generators work well with nearly any charger.*

Maximum charging amps should be about 10-20% of the total battery amp hour rating. Charging too fast can damage batteries. A 440 amp hour battery works well with a 40-80 ampere charger. Charge rate should taper to a much lower rate as the battery becomes fully charged. Several chargers can be used together to increase charge rate and reduce charge time, if battery size and rating of the generator allow. NOTE: Many automotive chargers list a high "boost" 200 amp or higher short term engine start surge, but this setting CANNOT function for charging home power batteries.

NOTE: Lithium batteries will have different recharging parameters. Please call for additional info.



# BATTERY CHARGERS

## IOTA 12V-55A, 24V-25A and 24V-40A Chargers

**Works better with generator power than most chargers. Accepts 2awg conductors.**

The DLS series converter efficiently charges batteries with the full rated output. It then maintains the batteries by only putting into the battery bank what is required to maintain the selected voltage set point. Short circuit, overload, and thermally protected. These chargers are not a 3 stage charger. They do not have a float voltage function. They will achieve a bulk voltage set-point and maintain it until the AC input source is removed.



Users of flooded lead acid batteries should order and use the IOTA IQ4- Turbo Smart Controller to raise voltages and provide 3 stage charging with equalization. Owners of sealed batteries can use the IOTA charger as is. Lithium battery owners should call Backwoods for detailed information about charging with IOTA chargers.

When an IQ Smart Controller is not connected, these chargers do not have a float feature so they work great when using a generator to charge batteries. Will also work with grid power but will need to be disconnected when the battery is recharged to avoid damaging the battery bank.

Historically, low and transient AC line voltage was a major cause of battery charger failure. The DLS series has basic protection against low transient line voltage, spikes (up to 132VAC) coming from your AC power source and thermal protection. There is also fused short circuit and current overload protection. It meets FCC criteria for minimizing radio and television equipment interference.

Iota chargers can tolerate input voltages up to 132 VAC; however, damage may occur with higher input voltages. Always avoid input surges from generators by starting generator first and allowing it to warm up before connecting power. Conversely, disconnect power to Iota charger before turning generator off. Never let the generator run out of fuel, as the loss of fuel can cause a generator to momentarily produce very high voltages. Two year warranty.

ITEM #	Description	Price
BC-IOTA5512	IOTA 5512 Battery Charger - 6.7" x 9.7" x 3.4" 740 watt, "55 amp" 12V fully automatic electronic charger	\$213
BC-IOTA2524	IOTA 2524 Battery Charger - 6.7" x 9.7" x 3.4" 675 watt, "25 amp" 24V fully automatic electronic charger	\$303
BC-IOTA4024	IOTA 4024 Battery Charger - 11.2" x 6.5" x 3.4" 1100 watt "40 amp" 24V fully automatic electronic charger (Special 120v AC 20 amp outlet is required)	\$373
BC-IOTA-IQ4-TUR	IOTA Plugin "Turbo" Controller for DLS Chargers	\$26

# GENERATORS

***Our GENERATOR PHILOSOPHY: It's important to have a GOOD engine driven generator and then use it as LITTLE as possible.***

**ADVANTAGE: LOW INITIAL COST:** During the dark snowy winters of many northern areas, 100% of the power needs could never be met even with 10 times more solar and batteries. For these situations, we design our power systems so 80 to 90% of the home's annual power needs come from solar generation and use other generation sources to make up the seasonal shortfall. Wind power and seasonal flow water power can help but most often folks use an engine generator and an inverter with a built-in battery charger.

**DISADVANTAGES: HIGHEST LONG TERM COST:** Fuel, maintenance, and limited engine life plus pollution and noise make a generator the highest cost of all energy sources over time. So we want to shorten the hours a generator is used. Larger battery banks accept a charge faster than small ones, so with a large battery bank and high rate battery charger more energy is stored with less generator time.

**ALL THE EXTRA POWER EVER WANTED,** when needed: There will be times when more power is wanted than the system is designed to produce. The solar array may initially be sized conservatively knowing more modules can be added any time. The inverter can be undersized with the knowledge that it could be traded in for a larger one in the future. In the meantime, high power demands for guests, or laundry, or building projects, or pumping a deep well can be met by a generator.

**PROPANE, THE FUEL OF CHOICE:** Propane fuel typically fits residential use better than gasoline or diesel. An alternatively powered home usually uses propane for water and space heating, cooking, clothes drying, etc. A propane generator is conveniently connected to the same propane tank as the home. A large tank filled with propane usually means no more running out of gas, handling fuel, or getting dirt or water into the fuel. Propane keeps longer than gasoline or diesel. The generator's engine runs cleaner and its oil stays cleaner, longer. Exhaust is also cleaner and produces less odor. Propane generators should start easily even in winter's cold without a choke, so starting and stopping remotely from inside the house year round is simple. As a result, propane generators tend to be the easiest to connect to an inverter-based, automatic start system.

**STATIONARY, QUIET, AND DURABLE:** A generator dedicated to a home need not be portable; should run quietly; and should last a decade or two.

---

At this point in time, Backwoods does not sell generators but can recommend the Honda EU7000iS as a great model to use IF LP fuel use is not required and auto start is not important. If those are important requirements for your application a Honda can be modified to be LP fueled and auto start but it will void the warranty of a new unit.

Backwoods employees use a variety of generators for backup when needed but we all try not to use them as a primary energy source, only for backup when energy use exceeds what is available from the renewable sources. Tom uses an older Kohler 10KW unit with a Honda EU5000iS as a backup and as a mobile power source around the homestead. Shawn and Tracey both use Honda EU6500iS's. Brian has a hydro system, rarely has to run a backup generator so he can get by with smaller lower quality Porter Cable portable generator. John uses a Honda EM5000. Feel free to contact any one of us to discuss our experiences and recommendations!

# GENERATORS

## HOW TO SWITCH BETWEEN INVERTER AND GENERATOR

AC produced by an inverter is wired into the standard AC house wiring breaker box to distribute power to lights and outlets throughout the home. Sometimes an AC generator might be connected to the same house wiring. **DON'T DO IT!** Inverter and generator **must never be connected to the same wiring at the same time** or both can be damaged. Wire generator power to one circuit or outlet in the battery room and tag it "generator direct". This is where the battery chargers plug in, or the charger of the inverter wires in. The inverter will automatically switch generator power thru to the house wiring when you start the generator, then switch it back to inverter power when generator stops.

If the inverter lacks the standby transfer option, plug the battery charger into the direct generator outlet, then use the transfer relay below to do the automatic switching between inverter and generator.



## TRANSFER RELAYS

TRANSFER RELAYS switches 120 volt AC house wiring between generator and inverter power sources automatically. Starting the generator causes transfer of home wiring from inverter to generator after a 20 second delay for warm-up. When the generator is disconnected, the relay transfers back to inverter power in 30 milliseconds. This prevents damage from accidental cross connection between inverter and generator. 2 year warranty.

30 amps at 120 volt AC or 50 amps at 120/240 volt AC.

Both models measures 8.625"W x 8"H x 3.875"D

ITEM #	Description	Price
O-TS30	120V, 30Amp Transfer Relay	\$71
O-TS50	120/240V, 50Amp Transfer Relay	\$142



# FROM BATTERY POWER TO HOUSEHOLD AC POWER

A POWER INVERTER converts DC from the battery to 120 volt AC for lights, outlets and most appliances, without starting a generator.

DC OR AC APPLIANCES? Folks with the smallest solar power systems and few, simple appliances may have no inverter, and use low voltage DC for all lights, radio, TV, and water pump. People using the largest solar power systems sometimes use AC power from an inverter for everything. Usually it is most practical to use both inverter AC and some direct battery DC loads. AC is most practical for regular household outlets and lights, because most AC appliances are better quality, easier to find, and lower priced than 12 volt DC versions. But a few special DC appliances can save a great deal of energy. Items that drain a small amount of power over long hours can use far less if DC powered. These are ceiling fans, phone message machine, motion sensing lights, intercom, and alarms. See the House and Appliance section earlier in the catalog on selection of AC appliances that work best with inverters. This catalog features refrigerators, freezers, lights, and 120 volt well pumps specially selected to work with inverters, to avoid excessively draining battery power. Also see the introductions to our Refrigerator section, DC Appliance section, Pump section and Lighting section for discussion of DC vs. AC applications.

GENERATOR POWER systems even without solar modules, benefit from inverters too. A large battery bank can be fast charged a few hours while the generator runs the water pump, clothes washer, shop tools etc. Later, when only a few watts are needed for lights or TV, the battery and inverter supply power without the generator. This way, power is available 24 hours a day at the turn of a switch but the generator runs only a few hours a day. This saves on generator maintenance, and life gets better! (But it is difficult to get batteries fully charged with just a generator, and serious battery problems are common with just a generator. Backwoods Solar advocates using primarily solar charging).

USED INVERTERS are occasionally available. Call to inquire, or see the listings on the Backwoods Bargains page of our web site at [www.backwoodssolar.com](http://www.backwoodssolar.com).

# TRUE SINEWAVE OR MODIFIED SINEWAVE?

TRUE SINEWAVE inverters typically supply power of better quality than the power company, and work correctly with almost any standard AC appliance. Battery chargers in sinewave inverters work well with most generators. Schneider Electric XW/SW series, Magnum RD/MS series and Outback FXR/VFXR inverters can automatically start and stop a generator when extra battery charge is needed. A lower cost Morningstar or Samlex true sinewave inverter might be used for smaller systems that requires true sinewave power.

MODIFIED SINEWAVE or “modified square wave” is a type of AC power which is not as good as power company electricity. Modified wave inverters are lower cost, slightly more efficient, and most appliances work fine with them, though some may hum louder. However, a few sewing machine speed controls, all front loading washing machines, some of the newer refrigerators and some dishwashers have difficulty on the modified sinewave. It can also damage photocopy machines, laser printers, and some cordless tool rechargers. Recently we found the first TV that would not run on any modified wave inverter.

---

Backwoods Solar recommends **sinewave** inverters for most system designs.

SIZE of inverters range from under 100 to over 8000 watts with stacked inverters. This rating indicates the largest wattage appliance or combination of appliances the inverter can operate continuously and at the same time. Surge power rating is well above the normal power rating, to run larger appliances a short time, or start heavy motors. Determine the highest total wattage needed to run without starting a generator.



INVERTER/CHARGER means the inverter becomes a battery charger when power is supplied to it from a generator or utility source. An automatic transfer switch within the inverter connects generator power thru to the house circuits to power appliances while also using it to recharge the batteries.

EFFICIENCY of most inverters is 85 to 95%. Though 5 to 15 % of battery power is lost in converting DC to 110 volt AC, the cost savings in AC wiring and appliances over the cost of DC equipment often makes AC the better choice.

SEARCH MODE is a useful feature in some inverters to automatically reduce power use by the inverter whenever all appliances and lights are off.

# INVERTER SELECTION

MODEL	Watts	Battery Charger	Battery Volts	Page	PRICE
<b>True Sinewave Inverters</b>					
Schneider Conext XW+ 6848 PRO	6800	Yes	48	102	\$3913
Schneider Conext XW+ 6848	6800	Yes	48	102	\$3645
Schneider Conext XW+ 5548	5500	Yes	48	102	\$3165
Magnum MS4448-PAE (parallel stackable)	4400	Yes	48	99	\$2008
Magnum MS4024-PAE (parallel stackable)	4000	Yes	24	99	\$1954
Schneider Conext SW4024	4000	Yes	24	104	\$1604
Schneider Conext SW4048	4000	Yes	48	104	\$1721
Magnum MS4024	4000	Yes	24	99	\$1824
Magnum MS2812	2800	Yes	12	99	\$1772
Schneider SW2524	2500	Yes	24	104	\$1482
Magnum MS2012	2000	Yes	12	99	\$1524
Magnum MS2024	2000	Yes	24	99	\$1568
Samlex 1500-12	1500	No	12	105	\$569
Samlex 1500-24	1500	No	24	105	\$587
Samlex EVO 12XX	1200	Yes	12/24	106	\$783
Samlex 1000-12	1000	No	12	105	\$450
Samlex 1000-24	1000	No	24	105	\$453
Samlex 600	600	No	12	107	\$247
Morningstar Sure Sine 300	300	No	12	107	\$266
<b>Modified Wave Inverters</b>					
Magnum RD3924	3900	Yes	24	108	\$1390
Magnum RD2824	2800	Yes	24	108	\$1208
Magnum RD2212	2200	Yes	12	108	\$1047
<b>Grid Tied Inverters</b>					
Fronius	1.5-6kW	No	Page 110		Various
SMA	2 - 7kW	No	Page 111		Various
<b>Micro Inverters</b>					
APsystems - YC600	548	No	24/48	112-13	\$215
APsystems - QS1	1200	No	24/48	112-13	\$343

Backwoods can special order almost any brand of inverter, however our in-house tech support is limited to those featured in our catalog and on our website at [www.backwoodssolar.com](http://www.backwoodssolar.com).



# MAGNUM ENERGY



The **MS Series Inverter/Charger** (not pictured) is a pure sine wave inverter designed specifically for the most demanding mobile and off grid applications. The MS Series is powerful, easy-to-use, and best of all, cost effective. Install the MS Series in four easy steps: simply connect the inverter's output to the distribution circuits or electrical panel, connect the shore power cable (AC) to the inverter's easy-to-reach terminal block, connect the batteries, and switch on the power. The lightweight aluminum base and cover provide noise reduction and

corrosion resistance. The MS Series has an RS-485 communication port for network connection and a remote control port. The extra large AC-access cover with terminal screw block and 360 degree DC connection terminals with covers make the inverter wiring accessible when it needs to be. It has an on/off switch with an easy to read LED indicator. All models have a 50 A transfer relay. MS4024 inverters (without PAE) can be series stacked, using the ME-SSI (special order \$63).

The **MS-PAE Series Inverter/Charger** is a pure sinewave inverter designed specifically for the most demanding renewable energy applications. The design of the MS-PAE Series provides 120/240 split-phase AC output in a smaller, single inverter. A 120/240VAC backup generator can be connected for easy integration using the internal 120/240. 30A transfer relay.

When the power requirements of the system are beyond the capacity of a single MS-PAE Series inverter or the system is expanded as more loads are added, up to four MS-PAE Series inverters can be connected together in a parallel configuration. When connecting inverters in parallel, the overall inverter power and surge capacity is increased to power a large single load or more smaller loads. Battery temperature sensor included.



# MAGNUM ENERGY



*Note: If you are planning on connecting the MS-PAE Series inverter in parallel with another MS-PAE Series inverter, ensure they all have Firmware revision 5.1 or higher.*

Inverter Dimensions: 13.75" x 12.65" x 8" / Weight: 43 - 58 lbs / Three year warranty (five years when installed on MMP or MP system). / ETL Listed

***The full line of Magnum products (including Export and Mobile models) are available to order. Give us a call to discuss.***

ITEM #	Input Voltage	Continuous Power	AC Surge Amps (1 msec)	Battery Charging Maximum	Price
I-ME-MS2012	12	2000W	50	100	\$1524
I-ME-MS2812	12	2800W	70	125	\$1772
I-ME-MS2024	24	2000W	75	60	\$1568
I-ME-MS4024	24	4000W	120	105	\$1824
I-ME-MS4024PAE	24	4000W	120	105	\$1954
I-ME-MS4448PAE	48	4400W	120	60	\$2008

## OPTIONAL EXTRAS

ITEM #	Description	Price
I-ME-AGS-N	Auto Generator Start allows operation w/ RC50 Remote	\$254
I-ME-RC50	Required for programming of critical settings on inverter	\$199
I-ME-ARC50	Advanced Remote recommended for use with AGS/BMK	\$266
I-ME-BMK	Magnum Battery Monitoring Kit	\$169
I-ME-BMK-NS	BMK w/o shunt (for use in Magnum Panel & Mini Panel systems)	\$161
I-ME-ARTR	Magnum control for integrated inverter / PT100 systems	\$374
C-ME-PT100	Magnum MPPT Charge Controller	\$1014

**Remember: Each inverter requires battery/inverter cables with lug ends**

# SCHNEIDER CONEXT XW+ SERIES

A Battery Based Backup Power System  
- for both off-grid or grid-tied use



The XW+ series from Schneider Electric features a power upgrade to the inverters, a robust solution to stacked systems, a new suite of products for large systems and internet connectivity. The XW+ will sell excess solar energy to the grid like a typical grid-tie solar system but with the added benefit of being able to provide uninterrupted backup power during utility outages. If adding a grid-tie solar power system to the home or business, incorporating a back-up power system, as well, is a sensible decision.

The XW+ grid-interactive features are highly configurable; allowing for full net-metering based functionality, with the battery bank held in reserve for utility outages, or run the battery-based solar electric system as if off-the-grid, using utility power as the world's biggest back-up generator, or any combination of functionality in between. The secondary AC input allows for use of a generator as well, resulting in one of the most robust system designs possible. Schneider's XANBUS communicates with DISCOVER Lithium-Ion batteries (see page 85) for a seamless solution. All in one package!

**XW+5548 and XW+6848 INVERTER:** Inverter output ranges from 5500 to 6800 watts and features two 240 volt AC inputs for grid and generator, with 120/240 split phase AC output. 75% of the inverter's rated output can continuously support a 120V AC leg. Built-in transfer relay is rated for 60 amps. Peak efficiency is 95%; power draw in search mode is 8 watts and averages 28 watts when on without a load (<8W and 24W for 24V version). Up to three inverters can be stacked together for increased continuous wattage capacity of a system.

Surge Wattage and Battery Charging Capability:  
 XW+6848 = 12,000W for 1 minute, 140A Charger  
 XW+5548 = 7,000W for 1 minute, 110A Charger

**System Control Panel (SCP):** The SCP is the control interface, enabling communication via the proprietary Xanbus™ to all XW+/SW inverters, charge controllers, and Automated Generated Start modules installed on the system. Features a graphical, backlit LCD screen that displays system configuration and diagnostic information. When installed as an XW+ system accessory, the Conext SCP eliminates the need for separate control panels for each device and gives a single point of control to set up and monitor an entire Conext system.



The **Connection Kit (CONNKIT)** for each additional inverter. It includes a conduit box, dual pole 60 amp AC input/output/bypass breaker assembly, wire harness, power distribution bars, 250 amp inverter breaker, positive bus bar, 4/0 battery shunt cables, and Xanbus™ & AC Synch cables.

# SCHNEIDER CONEXT XW+ SERIES

**Power Distribution Panel (PDP):** The XW series wall mounted design is easy to install. Its PDP includes double pole 60-amp AC input/output/bypass breaker assembly, inverter disconnect breaker, internal wiring components, one ground and one AC neutral bus bar, and DC positive and DC negative bus bars. Shunt for battery monitor is NOT included. Breaker space for up to two additional inverters is available. Conduit cover and shunt cables included for first inverter. Knockout space for installation of charge controller breakers is also available (8 spaces total available).



**Mini Power Distribution Panel (MINI-PDP):** Schneider Electric's smaller AC/DC breaker box for the XW Plus system. The Mini Power Distribution Panel offers a lower cost alternative to the full size PDP. While the full size PDP can be expanded upon to support multiple inverters and charge controllers, the Mini PDP is designed to support a single XWPlus inverter and charge controller.



**Automatic Generator Start (AGS):** The Conext AGS is a Xanbus™-enabled device that can automatically activate a generator to provide an XW+/SW Series Inverter/Charger with power to recharge depleted batteries or assist with heavy loads. Compatible with popular generators, the Conext AGS adds intelligence to power management and eliminates time spent monitoring batteries and inverter loads.

The AGS can be configured to start the generator in response to low battery voltage, thermostat operation, or load size on the inverter battery. A quiet-time setting prevents the generator from starting at inconvenient times. The LED display shows the status of the AGS, while all user-defined settings are programmed through the Conext SCP/Combox.

**Battery Monitor Kit (BMK):** The Conext Battery Monitor tracks state of charge of the system's battery bank; much like a gas gauge on a car. Other information from the display includes: battery bank voltage, amperage flow, amp-hours removed, time remaining (at current load levels), battery temperature, and mid-point voltage. The Monitor communicates with other XWPlus devices over the proprietary Xanbus™ network. Configuration and monitoring can also be handled by other Xanbus™ devices such as the SCP or ComBox.



**60A & 80A MPPT Charge Controllers** (see page 73 for full specifications): The XW+ series can be purchased with or without the XW-MPPT PV charge controllers. These controllers have integrated ground fault protection and they also offer a configurable 12v 200mA auxiliary output for load control via an external relay. Its front panel features a 2-line display and four buttons for configuration and system monitoring. Battery Temp sensor included.

# SCHNEIDER CONEXT XW+ SERIES

**Communications Box (COMBOX):** Powerful communications and monitoring device that features an integrated web server, enabling graphical displays of system daily, monthly and lifetime energy data to be viewed using a simple web browser or Android™ tablet device. Installers can change or configure the settings of Conext devices through the user-interface on the ComBox and respond to system email alerts promptly.



**System Configuration Box (GATEWAY):** The Gateway is a comprehensive monitoring and configuration interface. As a whole system manager the Gateway communicates over the Xanbus communication network to monitor and control other Conext devices including: XWPlus/SW inverters, XWMPPT60 and 80 charge controllers, Schneider Automated Generator Start (AGS) module, Battery Monitor Kit (BMK) and System Control Panel (SCP). Also compatible with the new Context XW Pro inverter/charger.

ITEM #	Description	Price
I-SC-XW5548	XW+5548 - 5500 Watt, 48VDC, 120/240V AC Inverter, 110A Charger	\$3165
I-SC-XW6848	XW+6848 - 6800 Watt, 48VDC, 120/240V AC Inverter, 140A Charger	\$3645
I-SC-XWPRO6848	XWPRO - 6800 Watt, 48VDC, 120/240V AC Inverter Features more robust control of net metering (Rule 21 compliant in California and Hawaii)	\$3913
I-SC-SCP	System Control Panel	\$251
I-SC-XW-PDP	Power Distribution Panel	\$1018
I-SC-XWPDP-MINI	MIni Power Distribution Panel	\$652
I-SC-AGS	Automatic Generator Start Control	\$160
I-SC-BMK	Battery Monitor Kit	\$529
I-SC-GATEWAY	System Configuration Gateway	\$598
I-SC-COMBOX	Communications and monitoring device	\$306
I-SC-XWCONNKIT	Connection Kit for 2nd Inverter with cables & breakers (Requires I-SC-XW-BRKRKIT1 (120/240VAC, \$185) or I-SC-XW-BRKRKIT3 (3 Phase, \$265))	\$882
C-XWMPPT60	60A, 150VDC MPPT PV Charge Controller	\$601
C-XWMPPT80	80A, 600VDC High Voltage MPPT PV Charge Controller	\$1344

The XW is the inverter Shawn at Backwoods uses to power his full-time off-grid residence. It's also what Backwoods uses to provide a battery backup to the grid power we use to power daily operations at our office. Feel free to call Alan or Shawn to discuss their experiences with the XW inverters and accessories.



# SCHNEIDER CONEXT SW SERIES



- High surge capability starts the toughest loads
- Scalable to stack 2 in parallel
- Dead battery charging to recover
- Lithium-ion battery ready

The Conext SW is the perfect go-to solution for off-grid, residential power. It is a pure sine wave inverter loaded with features that keeps power on 24 hours a day, 7 days a week. The flexible design allows it to be configured for any battery-based inverter application and the included installation bracket makes the Conext SW and the distribution components easy to install by a single installer. Several key features include:

- Generator support; allows power to be drawn off batteries to assist smaller generators at powering larger loads.
- “Dead” battery charging; charge batteries starting at voltage levels as low as 12 VDC. (Note: inverter will not resume full operation until voltage is higher than 20 VDC)
- Frequency shifting for AC Coupling (adding battery capacity to grid-tie systems).
- Load shaving and time of use configurations, for critical load backup applications.
- Battery charging from generator works with 120V or 240V output: half charging amps on only one leg, full charging amps on both legs.
- Integrated Xanbus™ communication to Discover (lithium-ion) batteries for auto configuration and monitoring.

Inverter - Dimensions: 16.5” x 13.4” x 7.6” / Weight: 62 lbs

System Control Panel Dimensions: 6.5” x 4.5” x 2” / Weight: 2 lbs

Automatic Generator Start Dimensions: 5.5” x 3.5” x 1.5” / Weight: .5 lb

Battery Monitor Kit: Dimensions: 3.3” x 3.3” x 3.5” / Weight: .5 lb

ComBox: Dimensions: 4.5” x 6.7” x 2.1” / Weight: .5 lb

Five year warranty (in USA) / CSA & UL Listed

\* Brian and his family use the SW inverter to power their off-grid hydro/solar homestead. Give Brian a call to discuss his experience with the SW inverter and accessories.

# SCHNEIDER CONEXT SW SERIES

Inverters: Off-Grid - Schneider Electric - Conext SW



ITEM #	Description	Price
<b>I-SC-SW2524</b>	2500 Watt, 24VDC, 120/240V AC Inverter, 65 Amp Charger	<b>\$1482</b>
<b>I-SC-SW4024</b>	4000 Watt, 24VDC, 120/240V AC Inverter, 90 Amp Charger	<b>\$1604</b>
<b>I-SC-SW4048</b>	4000 Watt, 48VDC, 120/240V AC Inverter, 45 Amp Charger	<b>\$1721</b>
<b>I-SC-SCP</b>	System Control Panel	<b>\$251</b>
<b>C-MNE250SW</b>	MidNite Solar 250A E-Panel for Conext SW (see page 63)	<b>\$427</b>
<b>I-SC-AGS</b>	Automatic Generator Start Control	<b>\$160</b>
<b>I-SC-BMK</b>	Battery Monitor Kit	<b>\$529</b>
<b>I-SC-COMBOX</b>	Communications and monitoring device. Integrated web server, graphical display, and data monitoring.	<b>\$306</b>
<b>C-XWMPPT60</b>	60A, 150VDC MPPT PV Charge Controller	<b>\$601</b>
<b>C-XWMPPT80</b>	80A, 600VDC High Voltage MPPT PV Charge Controller	<b>\$1344</b>

# SAMLEX SMALL INVERTERS



PST-1000



PST-1500

True sinewave voltage inverters provide clean, stable power for computers, radio equipment, home theater, stereo, marine equipment and other applications that are sensitive to AC voltage irregularity. These inverters do not include an automatic transfer switch.

The PST-1000 watt models use GFCI outlets for the AC output, which cannot be wired to a breaker panel with a bonded neutral and ground. Typical applications would plug devices in directly to the inverter or would use power strips/extension cords.

The PST-1500 watt models have both the GFCI outlets as described, and connection terminals for a hard-wired AC connection. The hard-wire connection allows for wiring to a breaker panel with bonded neutral and ground.

## Design Features

- LED indicators for Power, Overload & Over Temperature
- DC input voltage range: 10.7-16.5VDC (12 volt models); 21.4-33VDC (24 volt models)
- Protections: Low input DC alarm/shutdown, High DC input shutdown, Short circuit shutdown, Overload shutdown, Ground Fault (via GFCI outlets), Over temperature shutdown, Reverse polarity on DC input via internal fuses
- Temperature controlled cooling fan(s)
- Remote controlled switch available, sold separately. RC-300, with 25' cable for 1500 watt models; and RC-15A, with 15' cable for 1000 watt models
- Power draw, no loads: less than 1 amp
- Peak efficiency: greater than 85%

Two year warranty

ITEM #	Description	Price
I-SAM1000-12	Output 110VAC, 1000 Watts, 3W idle draw (Specify 12VDC or 24VDC)	\$450
I-SAM1000-24	Dimensions: 9.37" x 15.63" x 3.23" / Weight: 8.8 lbs	\$453
I-SAM1500-12	Output 120VAC, 1500 Watts, 1.5W idle draw (Specify 12VDC or 24VDC)	\$569
I-SAM1500-24	Dimensions: 10.35" x 18.43" x 4.16" / Weight: 15.6 lbs	\$587

# SAMLEX EVO INVERTERS



The **Samlex EVO** inverter offers 1200 watts of high quality pure sine AC power, with a built in battery charger for use with a generator at an affordable price. The charging circuit has several charging profiles to choose from, including full 3 stage charging with equalization. The inverter itself also has positive and negative connection points to tie in a solar charge controller to help simplify overall system wiring.

Other features include two variable speed fans for cooling, a zero interrupt transfer time to AC generator power, and a robust surge capacity. The unit uses a remote control, essentially required for full functionality. See **I-SAMEVRC-PLUS** below. Built-in protections include: Low voltage alarm, Low/High voltage shutdown, output overload and output short. Two year warranty.

Operating voltage range: 12V: 9.1 - 17.0 VDC / 24V: 18.1 - 34.0 VDC

Surge capacity for 1 msec: 300%, surge for 30 seconds: 150%

Maximum battery charging: 12V: 60 Amps / 24V: 40 Amps

Temperature controlled cooling fans

Hard wire direct to utility panel

Operating temperature: -4F to 140F

Connection for solar charge controller input rated at 50 amps max.

ITEM #	Description	Price
<b>I-SAMEV1212FHW</b>	12V, Output 120VAC, 1200 Watts Less than 5W idle draw Dimensions: 12.76" x 16.34" x 5.83" Weight: 38.8lbs	<b>\$783</b>
<b>I-SAMEV1224FHW</b>	24V, Output 120VAC, 1200 Watts Less than 5W idle draw Dimensions: 12.76" x 16.34" x 5.83" Weight: 38.8lbs	<b>\$783</b>
<b>I-SAMEVRC-PLUS</b>	This EVO remote is used to configure and monitor the EVO 12XXF line of inverters. Plugs into inverter using 10 meter cable that is included.	<b>\$152</b>

# SMALLER TRUE SINE WAVE INVERTERS

## SAMLEX



SA-600R-112

## MORNINGSTAR



SURESINE 300

**A Small True Sine Wave Inverter** can solve the problem of a few low-wattage appliances that require only true sine wave power, without upgrading the whole-house inverter to true sine wave. A small inverter can be dedicated to just the computers, a computerized sewing machine or recording equipment. Newly designed for heavy-duty industrial and commercial applications, the Samlex 600 has two, on board, GFCI protected outlets. Equally robust, the SureSine 300 must be hard-wired. Both models offer extensive electronic protection against reverse polarity, overload, short circuit, over/under input voltage, and over temp. These smaller sinewave inverters are perfect additions for smaller cabin, tiny home or RV applications!

Samlex600 - Dimensions: 12" x 7" x 3" / Weight: 5.4 lbs

Morningstar SureSine300 - Dimensions: 8.4" x 6" x 4" / Weight: 10 lbs

Two year warranty / UL Listed

ITEM #	Description	Price
I-SAMLEX600  600 Watts 12V	<b>600 watts continuous, 680 watts for 3 minutes, and an 800 watt surge.</b> Includes battery terminal lugs that are crimped to 4 gauge copper wire. Use a 100 amp fuse in the (+) battery cable. No load current consumed is 0.87 amps. <b>Do not connect to an AC breaker panel.</b> On board load controlled cooling fan. Rated operating range: 0° to +30° C (+/-10%). Input voltage: 10.5-15.0	<b>\$247</b>
I-SURESINE300  300 Watts 12V	<b>300 watts continuous and a 15 minute 600 watt surge.</b> Battery terminals accept 2 gauge copper wire. Use a 100 amp fuse in the (+) battery cable. Current consumed while powering a load is 0.45 amps. With no load, a standby mode is entered which reduces current draw to 0.055 amps. OK to connect to an AC breaker panel. Designed such that an onboard cooling fan is not required. Rated operating range: -40° to +45° C. Input voltage: 10.0-15.5	<b>\$266</b>

# MAGNUM ENERGY



RC50 - REMOTE DISPLAY

RD SERIES

The **RD series** inverter/chargers are designed specifically for off-grid use. The PFC battery charger efficiently charges batteries even at low AC voltage from low-cost generators, which the modified sine wave inverter keeps the costs down. Additionally the included battery temperature sensor works with the charger for optimum battery charging. Install the RD Series in four easy steps: Simply connect the inverter's output to the distribution circuits or electrical panel, connect the power cable (AC) to the inverter's easy-to-reach terminal block, connect the batteries, and switch on the power. The ME-RC50 controller is required for inverter programming. Dimensions: 13.75" x 12.65" x 8" / Weight: 38-45 lbs / Two year warranty.

ITEM #	Input Voltage	Continuous Power	AC Surge Amps (1 msec)	Battery Charging Maximum	Price
I-ME-RD2212	12	2200 Watts	60A	110A	<b>\$1047</b>
I-ME-RD2824	24	2800 Watts	100A	80A	<b>\$1208</b>
I-ME-RD3924	24	3900 Watts	150A	105A	<b>\$1390</b>

## OPTIONAL EXTRAS

ITEM #	Description	Price
I-ME-AGS-N	Magnum Auto Gen Start. Allows operation with either the RC50 or ARC50 remote	<b>\$254</b>
I-ME-RC50	Allows access & programming of critical inverter settings	<b>\$199</b>
I-ME-ARC50	Magnum Advanced Remote recommended for use w/ AGS	<b>\$266</b>
I-ME-BMK	Magnum Battery Monitoring Kit	<b>\$169</b>
I-ME-BMK-NS	Above without shunt (for use in panel systems)	<b>\$161</b>

# INVERTER BATTERY CABLES



Inverter performance and safety depend on using cables sized for very high battery currents, in lengths no longer than 10 feet. The cable end terminals and inverter bolt connections must be tight or enough heat can be generated to melt the cables and inverter input bolts, and start fires.

These large cables are finely stranded copper for flexibility, with lug ends industrially pressed on to fit terminal bolts on inverters. Always use a circuit breaker or fuse, in the positive battery cable between the battery bank and inverter.

Power panels use one set of DC cables between the battery bank and each inverter in the system.

Some Samlex inverters include cable connector studs on their inverters. A single BC10-2 or BC10-2/0 cable can be cut in half to make a pair of battery cables having terminals only at battery end, to fit these inverters.

ITEM #	Description	Price
Cable sets include one positive and one negative (except single BC 10-2)		
<b>FOR MANY INVERTERS THAT ARE SMALLER THAN 1000 WATTS</b>		
<b>I-BC10-2-UL</b>	Copper, 2 gauge 10' pair, lugs on all ends	<b>\$60</b>
<b>I-BC2-SINGLE</b>	Single cable: cut it in half for inverter with clamps	<b>\$40</b>
<b>FOR INVERTERS THAT ARE 12V 1000-1500 WATTS; 24V 2000-3000 WATTS; 48V 3600-4400 WATTS</b>		
<b>I-BC10-2/0-UL</b>	Copper, 2/0 gauge, 10' pair, lugs on all ends	<b>\$100</b>
<b>I-BC2/0-SINGLE</b>	Single cable: cut it in half for inverter with clamps	<b>\$60</b>
<b>FOR INVERTERS THAT ARE 12V OVER 1500 WATTS; 24V OVER 3000 WATTS; 48V OVER 4400 WATTS</b>		
<b>I-BC10-4/0-UL</b>	Copper, 4/0 gauge, 10' pair, lugs on all ends	<b>\$150</b>
<b>I-BC4/0-SINGLE</b>	Single cable: cut in half for inverter with clamps	<b>\$90</b>

# FRONIUS PRIMO

## Grid-Connected Inverters



The **Fronius Primo** line features mid-range residential grid-tie inverters incorporating dual MPPT DC connections. The flexibility of the Primo line is a great choice when plans call for starting small with the intent to grow the array over time. A minimum input voltage rating starting at 80 volts allows for starting string sizes as small as three 60 cell(nominal 30 volt) panels in series. The result is the option for a lower cost, entry level system with plenty of room to grow the array over time.

10-year warranty, which is extendable to 15 or 20 years.

ITEM #	Description	Price
I-FR-PRIMO3.8-1	3800W Single Phase Fronius Primo Inverter	\$1574
I-FR-PRIMO5.0-1	5000W Single Phase Fronius Primo Inverter	\$1796
I-FR-PRIMO6.0-1	6000W Single Phase Fronius Primo Inverter	\$1997
I-FR-PRIMO7.6-1	7600W Single Phase Fronius Primo Inverter	\$2359
I-FR-PRIMO8.2-1	8200W Single Phase Fronius Primo Inverter	\$2501
I-FR-PRIMO10.0-1	10,00W Single Phase Fronius Primo Inverter	\$3154
I-FR-PRIMO11.4-1	11,400W Single Phase Fronius Primo Inverter	\$3533
I-FR-PRIMO12.5-1	12,500W Single Phase Fronius Primo Inverter	\$3820
I-FR-PRIMO15.0-1	13,750W Single Phase Fronius Primo Inverter	\$5080

## RAPID SHUTDOWN BOXES

The **Fronius Rapid Shutdown Box** is the Fronius solutions to 2014 NEC requirements. Call to discuss applications in states that require 2017 code. The DUO box is used for arrays consisting of one or two DC strings, while the QUATTRO box can accommodate two, three or four DC strings. Box is NEMA 4X rated.



ITEM #	Description	Price
I-FR-SHUTDOWN	Fronius Rapid Shutdown Box - Duo	\$182
I-FR-SHUTDOWNQ	Fronius Rapid Shutdown Box - Quattro	\$307



# SMA-SUNNY BOY



SMA Sunny Boy string inverters are available in sizes from 3kW – 7.7kW for residential applications. The Sunny Boy-US series features a wealth of improvements to their previous transformerless inverters. They have released six new, streamlined inverters with integrated DC Disconnects and the world’s first Secure Power Supply has been improved to deliver up to 2,000W of opportunity power when the grid goes down and the sun is shining. Installation has never been easier thanks to SMA’s Installation Assistant, direct access via smartphone, and integrated fused DC disconnect. All communication peripherals are included in the unit, removing the need to buy additional hardware.

The Sunny Boy’s multiple independent input channels, each with SMA’s OptiTrac™ Global Peak, mean hundreds of stringing configurations for flexible system design while solving the challenges of complex roofs and shading.

SMA’s Transformerless inverters feature high efficiency and reduced weight, and include ground and arc fault detection. They have an input voltage range of 100 – 550VDC and feature dual MPPT input on the 3.0 and 3.8, and triple MPPT input for the 5.0 and up, which allows for greater flexibility for module string sizing and orientation. Not all strings have to be the same length, and East/West orientations become possible. All models can run at either 208V or 240V and 50 or 60 Hz.

Inverter dimensions: 21.1” x 28.5” x 7.8” / Weight: 57 pounds. 10-year warranty.

ITEM #	Description	Price
I-SB3.0-US	Sunny Boy 3000W 208/240V Inverter	\$1337
I-SB3.8-US	Sunny Boy 3800W 208/240V Inverter	\$1374
I-SB5.0-US	Sunny Boy 5000W 208/240V Inverter	\$1460
I-SB6.0-US	Sunny Boy 6000W 208/240V Inverter	\$1572
I-SB7.0-US	Sunny Boy 7000W 208/240V Inverter	\$1797
I-SB7.7-US	Sunny Boy 7700W 208/240V Inverter	\$1923

# AP SYSTEMS

## Grid-Tie Microinverters

Microinverters are used in grid-tie systems. They are mounted behind the solar modules on the rail system or on the frame itself. DC power is converted to AC power at the module and fed into a common branch circuit trunk cable which is then fed to the household utility panel. Converting power at the solar module allows for "per module" power management. If a single module in an array is shadowed or compromised, it will not affect the performance of other modules in the array; a distinct advantage over traditional string inverters.



The **APsystems YC600** is a dual module microinverter, meaning a single unit can accommodate two modules. Each module is connected via independent MPPT inputs. AP Systems boasts a wider MPPT voltage range than most competitors, meaning greater energy harvest in low light conditions. Wireless communication reports operational data to the AP Systems Energy Communication Unit (ECU, sold separately) located in your home. 10 year warranty\*.

The **APsystems QSI** is a quad module microinverter, meaning a single unit can accommodate four modules, reducing cost and speeding install time. 10 year warranty\*.



\* A 25-year extended warranty is available for purchase. Call for details.

Brandon uses six of the YC600 microinverters, one ECU-R and 12 Heliene 300W modules on his 3.6kW system at home. Give him a call to discuss grid-tie microinverters!

# AP SYSTEMS

## Grid-Tie Microinverters

ITEM#	I-AP-INV600	I-AP-INVQS1
Module Compatability	60 or 72 cell	60 or 72 cell
MPPT Voltage Range	22V-48V	22V-48V
Operation Voltage Range	16V-55V	16V-55V
Max Continuous Output	548W	1200W
Nominal Output Voltage	240VAC	240VAC
Max Inverters per Branch Circuit	7 (14 modules)	3 (12 modules)
Operating Temp Range	-40F to 149F	-40F to 149F
Measurements	10.24"x7.4"x1.24"	11.1"x9.1"x1.6"
Weight	5.7 lbs	9.9 lbs
Price	<b>\$215</b>	<b>\$343</b>

The **ECU-R** is the communication gateway for AP microinverter systems. Data from the microinverters is received wirelessly by the ECU-R, which collects and transfers module performance data giving you comprehensive monitoring and control over each individual module, optimizing the performance of your solar array. 3 year warranty.



ITEM #	Description	Price
<b>I-AP-ECU-R</b>	APsystems Energy Communication Unit	<b>\$266</b>
<b>I-AP-BUSCBL</b>	APsystems AC Bus Trunk Cable - 2M	<b>\$27</b>
<b>I-AP-EXTEN</b>	APsystems DC Extension Cable - 2M	<b>\$9</b>
<b>I-AP-ENDCAP</b>	APsystems AC Bus End Cap	<b>\$9</b>
<b>I-AP-MC4CC-F</b>	APsystems MC4 Cap - Female	<b>\$2</b>
<b>I-AP-MC4CC-M</b>	APsystems MC4 Cap - Male	<b>\$2</b>

# METER BASICS

Some people say they can't understand electricity because they can't see it. But we can't see into our car's gas tank either. We use a gas gauge to learn the fuel level. Likewise, meters take the mystery out of power systems. Here are the basics.

VOLT METERS show electrical pressure, to verify when batteries are fully charged or are very discharged, but they are less precise at indicating mid-levels of charge.

AMP (short for ampere) METERS show current flowing at the present time. Amperes is a rate of flow, like gallons per minute. Turn on a light and 2 amps begin to flow. Turn on a second and the flow increases to 4 amps so long as both are on. We use a digital ammeter to show total amperes being used. If it reads higher than expected, we can look for lights or appliances accidentally left on to reduce power usage.

Ammeters can also be connected to show NET BATTERY AMPS — balance of power going into or out of a battery. If solar is charging at 20 amps, and the TV is using 5 amps, the battery receives the difference, 15 amps. A net battery current meter shows +15 amps charge going to the battery. At night with just the TV on, this same meter shows negative 5 amps flow out of the battery.

AMP-HOURS is the total energy used over a period of time, just like total gallons of gasoline available in the tank (or used on a trip). Amp-Hours consumed are figured by the number of amps flowing multiplied by the number of hours it flows. A light using 2 amps, lit for 6 hours uses 12 amp hours. If lit for 30 minutes, it uses 1 amp hour. Batteries holds a certain number of amp-hours.

A BATTERY NET AMP-HOUR METER starts at a full battery and counts amp hours passing into and out of the battery. It keeps track of the running total, monitoring how much power is left in the battery. This is the closest thing to a fuel gauge yet to be invented for batteries. Batteries, like leaky gas tanks, lose a little power internally, which the meter cannot measure. To compensate, Battery Amp-Hour meters “fudge” the count lower by a certain percentage to match actual battery operation. These meters must be carefully programmed to match the specific battery. Use integrated battery monitor kits (BMK) that utilize the inverter control panel or consider the TriMetric Battery Meter on the next page.

A METER SHUNT is a calibrated brass block for measuring very large currents, up to 500 amperes. The shunt sends a small signal to an Amp-Hour meter. The signal can be sent on small wires, so the meter may be located some distance from the shunt, often in the living quarters for more convenient checking. All current going into or out of the battery passes through the shunt and is counted.

# TRIMETRIC BATTERY METER

## Model 2030 for 12, 24 or 48 Volt Systems

The Trimetric meter keeps a running total of power into or out of the battery and displays the present level of charge.

The meter head mounts anywhere in the house for easy checking. Small wires run from the meter to a shunt near the battery. These wires should not be run near AC wires.

The Trimetric meter reads:

**VOLTS:** this feature only can monitor 2 battery banks, accurate to 1/10 volt. For 12, 24, or 48 volts.

**AMPS or WATTS:** display measures the rate of energy going in or out of the batteries for monitoring charging and energy consumption of each appliance.

**AMP-HOURS:** displays the state of charge in amp-hours. % Full: display will give you a quick indication of battery state-of-charge.

Also shows advanced functions: Flashing alarm reminds that battery needs charging or needs equalizing. Shows days elapsed since last full charge; amp hours cycled since last full charge; total amp hours cycled since battery was new; highest voltage since reset. New Data logging feature records daily maximum battery voltage level, and minimum charging amps to check for proper charging levels for the last 5 days. One year warranty.



ITEM #	Description	Price
M-TRIMETRICKT30	Kit includes <b>2030A Trimetric Meter</b> & parts needed to set up the meter -500 amp 50 millivolt shunt -24", 2/0 lug cable to connect the battery to the shunt -Terminal lug to attach charge and load wires to the shunt -Surface wall mount box for the meter head -22awg cable, 25 feet (or specify length) with 3 amp fuse connects meter to shunt & power	<b>\$230</b>
M-TRIMETRICKTRV	Kit includes <b>2030-RV Trimetric Meter</b> & parts needed to set up the meter (See above)	<b>\$230</b>
M-TRIONLY-2030A	Trimetric 2030 Meter head alone, <b>Shunt and parts kit not included, 5" x 4.5"</b>	<b>\$170</b>
M-TRI-2030-RV	Trimetric 2030 RV Meter comes with its own enclosure to be surface mounted. No additional mounting enclosure is needed. <b>Shunt and parts kit not included 5" x 4.5"</b>	<b>\$170</b>
M-SHUNT-500	500A Shunt	<b>\$31</b>
M-TRI-WIRE-18	18awg thermostat wire for longer runs	<b>.50/ft</b>

# PORTABLE DIGITAL TEST METER



VOLTS shows 2 decimal places up to 20 volts DC, and one decimal place up to 200 volts DC. This is important for checking battery condition, with tiny variations between some cells. Also shows 0-600v AC. Reads up to 10 AMPS DC. Test the current of a solar module or many DC appliances.

OHMS and milliampere scales, audible continuity beep, diode test etc. This meter costs more than hobby types, and is very reliable. We send a brochure about using a test meter with each order. Or just ask for the Backwoods test meter instructions for free. Exact model may differ from this picture. Includes 9V battery.

Three year warranty

ITEM #	Description	Price
M-DMM	Portable Digital Test Meter	\$39

# AC WATT-HOUR METER COMPARES POWER USAGE OF APPLIANCES



Plug this meter into 120 volt AC power and plug appliance into the meter. It registers how much power the appliance is using, and keeps total of kilowatt hours used since start of test. It will measure exactly how much power a freezer uses each day, or any other appliance up to 1875 watts. Once unplugged, the data stored is lost. Shows voltage, frequency, and power factor of power being used too. 0.2% accuracy. Max surge amps: 29; alarm sounds above 15 amps. LCD not backlit.

6 month warranty / ETL approved

ITEM #	Description	Price
M-KILLAWATT	AC Watt Hour Meter	\$31

# ONE WEEK 12 / 24 VOLT TIMER SWITCH



A programmable timer makes a stereo into a wake up clock radio, or can turn on a fax, 2 way radio, heating system or a light during scheduled hours. It can cut off phone bells at night, operate grow lights, or start up a refrigerator for a weekend cabin, control a two-wire-start generator to pump water or charge batteries. Ordinary AC timers will not operate if an inverter is not constantly on. This timer runs on DC so it is always on duty even where there is no inverter. Or it can switch on an AC appliance which in turn starts up the inverter from search mode. Operating range to avoid LCD damage: +14° to 131° F.

Program is set by push buttons, with digital display screen also showing time of day. Eight different “on” times can be programmed each day. Each “on” time can operate any one day, all days of the week, Monday through Friday, Monday through Saturday, or just weekends. Has easy manual on-off switch.

Controls up to 10 amps AC, but only about 2 amps DC. We can supply a 30 amp external relay in order to control much higher current appliances. Order O-RELAY. This is not a plug in appliance. It must be wired like a switch, in series with power to appliance. Wiring diagrams also available.

This timer uses negligible battery power to run, 5-10 milliamps idle, 30 milliamps during “on” time. An internal watch battery maintains time and program if DC power is disconnected for weeks.

Free diagram with purchase.

Timer dimensions: 3” x 3” x 2” / One year warranty

ITEM #	Description	Price
<b>A-DIGTIME12</b>	12 Volt Digital Programmable Timer	<b>\$83</b>
<b>A-DIGTIME24</b>	24 Volt Digital Programmable Timer	<b>\$83</b>
<b>O-12VRELAY</b>	12V, 30A DPDT Screw Term Relay (210ma coil)	<b>\$53</b>
<b>O-24VRELAY</b>	24V, 30A DPDT Screw Term Relay (210ma coil)	<b>\$55</b>
<b>O-INLINE</b>	Inline 3 Amp Fuse & Holder	<b>\$6</b>

# VOLTAGE CONVERTERS

Voltage converters are often used in off-grid homes where the voltage of a DC appliance does not match voltage of the system's battery bank. A voltage converter taps the voltage of the battery bank, and "steps-up" or "steps-down" to the appropriate output voltage. The output can be used to energize a small DC breaker panel, or can be wired directly to a circuit to support an appliance. In step-down applications with long wire runs, the step-down converter can be placed at the end of the wire run for a more efficient, higher voltage transmission.

Two year warranty.



SDC-23



IDC100C12



STEP7

## CONVERT a 12V circuit to run a 24V load

ITEM #	Description	Price
A-SAM-STEP7	Converts 12V input to 24V output, 7 Amps max output	\$115

## CONVERT a 24(or 48v) circuit to run a 12(or 24v) load

ITEM #	Description	Price
A-SAM-SDC-23	Converts 24V input to 12V output, 20 Amps max output	\$93
A-SAM-IDC200C24	Converts 48V input to 12V output, 8 Amps max output	\$189
A-SAM-IDC100C12	Converts 48V input to 24V output, 8 Amps max output	\$155



# MIDNITE SOLAR INVERTER DISCONNECT



## Main Battery Disconnect



DC Rated Circuit Breaker designed for connecting inverter to battery safely. All of the DC Disconnects come with either a 125, 175 or 250A/125VDC breaker and room for either 5 additional din rail mounted DC breakers, or 3 panel mount breakers. These can be used for many different DC loads, like charge controller disconnect battery status monitor feed, Includes a grounding bus bar, 5/16" bonding battery minus stud. Mounting holes for a 500A shunt are built in. Box measures 17" x 9" x 4". ETL listed for US and Canada.

**Consider making your own power panel.  
See kits using MidNite E-Panels & Magnum  
Mini Panels in the Power Panel section.**

ITEM #	Description	Price
O-MNDC125	125A DC Disconnect Box & Breaker	\$196
O-MNDC175	175A DC Disconnect Box & Breaker	\$223
O-MNDC250	250A DC Disconnect Box & Breaker	\$223
O-SHUNT2/0-24-UL	24in 2/0 Battery Cable for inverter connections	\$18
O-SHUNT4/0-24-UL	24in 4/0 Battery Cable for inverter connections	\$25
<b>Breakers: Use S-MNEPV and O-MNEDC breakers. See pages 119-120</b>		



# BREAKER BOXES



## MIDNITE BABY BOXES



MidNite Solar's "Baby Box" is a general use powder coated aluminum enclosure for retrofits, small inverter disconnect, PV disconnect or AC or DC distribution. 3/4" & 1" knockouts on each end. The Baby Box accepts up to four Din mount breakers from 1A to 63A or two larger 80/100A dual slot breakers.

The "Big Baby Box" is about twice as wide as the Baby Box allowing more room for wiring. It also includes a ground box lug and mounting provisions for a short insulated bus bar as well as a ground bus bar. Holds up to four 13mm wide din rail breakers from 1A to 63A or two larger 80/100A dual slot breakers.



ITEM #	Description	Size	Weight	Price
O-MNE-BABY	Baby Breaker Box	7" x 3" x 2.5"	2lbs	\$36
O-MNE-BIGBABY	Big Baby Breaker Box	8" x 5" x 3"	3lbs	\$44

**Breakers: Use S-MNEPV breakers. See page 122**



## MIDNITE DC QUAD BOX



This MidNite general use enclosure has room for 4 panel mount type breakers from 5 - 100A. We recommend using the DC Quad Box with the Magnum Mini Panel when an 80A or larger charge controller is used. This allows for a 100A panel mount breaker to be wired into the system.

Size: 8"(L) x 5" (W) x 4" (D)

ITEM #	Description	Price
O-MNEDCQUAD	MidNite DC Quad Box	\$56

**Breakers: Use O-MNEDC breakers. See page 121**

**MidNite Solar offers many enclosure options, some with din rails and breakers included. We are happy to special order what is needed.**

# SQUARE-D BREAKER BOX



Square-D circuit breakers in their “QO” line are UL listed for 12 and 24 volt DC circuits or for 120/240 volt AC home or generator circuits, but use a separate unit, for DC and for AC. Do not mix voltages in a single box.

We stock model QO612LI00S, a six-circuit load center. We ship it with two 20-amp QO-120 breakers included. The remaining four empty breaker-slots may be filled with breakers of choice from 15 to 60 amp maximum QO breaker size. The QO612 load center can be used for most DC lighting or appliance circuits, and even small inverters.

Breakers can also be dedicated to the PV array as a convenient disconnect between array and controller or controller and battery bank as well as between hydro input and battery bank. 60 amps is maximum breaker size. Box measures 13” x 9” x 4”.



ITEM #	Description	Price
O-QO612KIT	Load center with two 20A breakers	\$76
O-QOBRKR	15, 20, 30 or 60A (Specify when ordering)	\$24
O-QOU-BRKR260	60A, 2-Pole, QOU Breaker	\$140

## BREAKERS

**DC BREAKERS** - Panel mount breakers are rated to break the full rated load at the rated voltage repeatedly, with **NO DAMAGE**. Always use a properly sized breaker for disconnecting. Comes with mounting screws. 150VDC.



We use MNEDC breakers in the MidNite Disconnect and Quad boxes. Use the CD breakers with the Schneider Power Distribution Panel (PDP).

ITEM #	Description	Price
O-CD60	60A DC Breaker	\$43
O-CD80	80A DC Breaker	\$45
O-CD100	100A DC Breaker	\$70
O-MNEDC175	175A DC Breaker	\$119
O-MNEDC250	250A DC Breaker	\$119
O-MNEDC(Amp)	5, 10, 20, 30, 40, 50, 60, 80 or 100A DC Breakers	\$22
O-MNDC-GFP80	MidNite GFP 80A 150VDC Breaker	\$61
O-MNEDC-HV(Amp)	30, 60 or 80A DC Breaker - 300VDC	\$44

# BREAKERS



PV Breaker



GFP63



Dual Slot

**PV BREAKERS** - 150VDC din rail mount breaker (13mm wide). MNEPV breakers are the same as CBI QY breakers available elsewhere except MidNite Solar breakers are 150VDC. Typically used in combiner boxes; and for charge controller input and output breakers. 2ga max wire size.

ITEM #	Description	Price
<b>S-MNEPVXX</b>	6, 9, 10, 15, 20, 30, 40, 50, 60 or 63 amp PV Breakers	<b>\$17</b>
<b>S-MNEPV80 or 100</b>	80 or 100A PV Dual Slot Breaker	<b>\$54</b>
<b>S-MNEPV-GFP63</b>	63A, Single Pole Ground Fault DC Breaker	<b>\$74</b>
<b>S-MNEPV-HV</b>	10, 15, 20, 30, 50A High Voltage Breakers 300VDC	<b>\$38</b>



AC Breaker

**AC BREAKERS** MidNite din rail mount AC breakers are branch circuit rated 489A for continuous duty. They hold 100% rated current independent of ambient temperature.



Dual Slot

ITEM #	Description	Price
<b>O-MNEAC(Amp)</b>	15, 20, 30, 50, 60 AC Single Pole Breakers	<b>\$19</b>
<b>O-MNEAC(Amp)-D</b>	15, 20, 30, 50 AC DOUBLE Pole Breakers	<b>\$38</b>

# DC RATED FUSES

## WITH FUSE HOLDER FOR INVERTERS

Fuse blocks directly accept large inverter battery cables. A fuse and holder is basic protection against electrical fires from over-current in wiring. (Fuses and holders by themselves are not accepted by National Fire Code unless installed in an approved metal box.) Replacement fuses available from Backwoods if they cannot be found locally.



**400 Amp Class T Fuse in plastic enclosure** For 1800-3000 watt 12 volt inverter or 3500-4000 watt 24 volt or 5500 watt 48 volt inverter. Accepts 4/0 cables. Mounts on wall or inline on inverter cable.

ITEM #	Description	Price
O-FB400T	400A Inline fuse holder and fuse	\$65
O-T400	400A Class T Fuse only	\$34

**200 Amp Class T Fuse in plastic enclosure** For 1000-1500 watt 12 volt inverter or 2000-3000 watt 24 volt inverter or 4000 watt 48 volt inverter. Accepts 4/0 cable. Mounts on wall or inline on inverter cable.

ITEM #	Description	Price
O-FB200T	200A Inline fuse holder and fuse	\$53
O-T200	200A Class T Fuse only	\$24

**110 Amp Class T Fuse** in plastic enclosure for 600-800 watt 12 volt inverter or up to 1800 watt 24 volt inverter. Accepts 2AWG wire. Mounts on wall or inline on inverter cable.

ITEM #	Description	Price
O-FB110T	110A Inline fuse holder and fuse	\$53
O-T110	110A Class T Fuse only	\$24

# SMALLER DC FUSES

**15,30,40, and 60AMP** Fuses for solar controllers, DC pumps, refrigerators, lights. Every wire from the battery positive must be fused for safety. Select a fuse rated 125% to 150% over normal amps expected, and no higher than amp capability of smallest wire in circuit. These fuse holders have clamps for wire sizes up to 2 gauge. Also for inverters 400 watts & smaller.



ITEM #	Description	Price
O-FB60	40-60A Holder & Two 60A Class R Fuses	\$47
O-FB40	40-60A Holder & Two 40A Class R Fuses	\$47
O-FB30	30A Holder & Two 30A Class R Fuses	\$36
O-FB15	15A Holder & Two 15A Class R Fuses	\$36
O-FUSE-XX	R15 or R30 / R40 or R60 Fuse Only	\$9/\$18

## 3 AMP IN-LINE FUSE & HOLDER

with wires. For meters and small items.



ITEM #	Description	Price
O-INLINE	Inline 3A Fuse & Holder	\$6

**BATTERY LUGS** fit up to 3/8" battery terminal bolts. Connects many wires to battery. Also fits meter shunt. Connects wires 2/0 or 4/0 to 14 gauge in one or two set screw wiring clamps. Includes allen wrench.

**SPLICE BARREL** joins wires up to 2 gauge. Set screws anchor each side.



SPLICE BARREL

ITEM #	Price
O-AU2/0	\$5
O-AU4/0	\$5.50
O-BARREL	\$5.50

# WIRE JUNCTION DEVICES



**BAR CONNECTOR** joins wires, 4 to 14 gauge. Set screws hold each wire. All metal, not insulated. Connects all wires together. Made for multiple ground wire terminal in equipment boxes. 12 terminals.

ITEM #	Description	Price
O-PK	Bar Connector for 12 Wires	\$19

**INSULATED DOUBLE TERMINAL BLOCK** for large wires. Screw clamp for each wire. A single large cable up to #2/0 fits in one side. The other side holds four wires up to 4 gauge each, or 8 smaller wires. + and - combined in one. Includes allen wrench.



ITEM #	Description	Price
O-16220-2	Double Terminal Block	\$48



# MIDNITE SOLAR SURGE PROTECTOR



*Now the industry standard!*



The MidNite Solar Surge Protector Device (MNSPD) is a Type I device, designed for indoor and outdoor applications. Engineered for both AC and DC electric systems, it provides protection to service panels, load centers or where the SPD is directly connected to the electronic device requiring protection. Maximum protection will only be achieved if the SPD is properly installed.

The MidNite Solar SPD is offered in three different voltages to maximize the required protection level. Protection is achieved by reducing the clamping voltage to a safe voltage that the system can sustain without damaging any electronics in the system. By

using the chart below, select the SPD's that provides the protection required.

The MidNite SPD is a welcome replacement for less sophisticated arrestors that have been the mainstay of the industry for many years. Other din rail SPD's are physically small and typically can only provide 1/8th the protection of the MidNite product. When exposed to transients above their capability, permanent damage occurs. Other din rail SPD's are always mounted inside of a box such as a PV combiner. When the din rail SPD fails from a near lightning strike, it just quits working. This means that it also quits protecting. Since it is locked away inside of a box, there is no way of knowing it has failed until the next lightning storm! However, the MidNite SPD is mounted on the outside and has blue LED's viewable from a distance that the system is still protected. They are also built to last, in the case that the MidNite SPD does eventually wear out, they can easily be repaired.

The MidNite Solar SPD voltage rating should be chosen according to the nominal voltage of the system. Do not install an SPD with Maximum Continuous Operating Voltage (MCOV) below the nominal voltage of the system; this will deteriorate the SPD and makes it unavailable when most needed. The 115V SPD provides protection for battery circuits, the 300V SPD provides protection for the Classic & other charge controllers as well as off-grid PV combiners and 120/240VAC circuits. The 600V SPD is available as a special order item for Grid-Tie PV combiners and inverter input circuits.

ITEM #	Description	Price
LA-MID-SPD115	115V Surge Protector Device	\$103
LA-MID-SPD300	300V Surge Protector Device	\$103
LA-MID-SPD300AC	300V AC Surge Protector Device	\$103
LA-MID-SPD600	600V Surge Protector Device	\$103



# LIGHT WITH LESS POWER

Photovoltaics convert around 16-18% of sunlight's energy into electricity. Ordinary light bulbs convert only 10% of that electricity back into light (the rest becomes heat in the bulb). Because lighting is a major part of power used in solar homes, special high-efficiency bulbs saving 75% of the power are well justified.

ORDINARY INCANDESCENT BULBS are 10% efficient, wasting 90%.

QUARTZ HALOGENS are brighter incandescents, some have reflectors.

STANDARD FLUORESCENT TUBES give a lot more light for the power.

COMPACT FLUORESCENT BULBS (CF) make less heat and more light making them more efficient, using one fourth the power of ordinary bulbs. Most cannot be used with dimmer switches.

LED (light emitting diode) lamps are the newest lamp type. They have a much longer lifetime, rated 50,000 hours, and a ruggedness that exceeds all others. As little as half a watt can power them. The price and light color of LED bulbs is improving.

Bulbs used the most can save the most energy. Put efficient LED bulbs in lamps used 20 minutes at a time or more every day. Lights seldom used save only a little energy, so ordinary low cost bulbs are fine for closets and other rarely used fixtures. For best results, our DC CF bulbs must run a minimum of 20 minutes when turned on to properly heat up and due to start up surge, only install one light per switch.

Numerous wall switches controlling multiple low-watt lamps close to each work area give more choice in lighting so you can use less power. This is better than one switch that turns on all lights in a room, or one big light in the middle of a room. Lighter paint colors, with skylights and windows placed for day lighting greatly reduce lighting energy. Timer switches save energy for lights outdoors, in basements, and in children's rooms.

120 volt AC or 12 volt DC: 120 volt AC compact fluorescents are the best choice overall for a house. They are available in more sizes and shapes. AC wiring is easier and very standard. Even a 300 watt inverter will run lots of 15 watt lights (which give light equal to 60 watts).

But very small homes and cabins or recreational vehicles with total of 6 or less lights might best use 12 volt DC CF and LED lights. DC lights don't require an inverter, so use slightly less power.

12 VOLT DC MOTION SENSOR LIGHTS are always on duty to work whether inverter is running or not, and will not be accidentally left on.

Tip: DC socket wiring for Edison base bulbs: Pos (+) = center pole; Neg (-) = side

See the LIGHTING CHART on page 159 of this catalog for more information about LUMENS.

# ULTIMATE DC LED BULBS

Our ULTIMATE bulb is now better than ever. This is the brightest most omnidirectional bulb that we have found on the market for 12V/24V use. It even outperforms many AC LED bulbs made by major manufacturers. This A19 size lamp is the perfect replacement for 12 or 24 volt incandescent and compact fluorescent bulbs in table lamps and ceiling fixtures. Light is evenly distributed in all directions and the light is warm and even. Power consumption is only 5 watts and light output is 500 lumens. Color temperature is 3000 Kelvin, which is a warm soft white like most incandescent bulbs. Voltage range is 10 to 30 volts. Standard medium Edison base. Light output from this lamp is constant, even in low battery conditions, unlike incandescent bulbs. It will remain bright when battery voltage drops. 3 year warranty.



ITEM #	Description	Price
L-LED-ULT-3K	5W Ultimate LED Bulb, 12V/24V, 500 lumens, 4-3/4" long	\$22



# 12VOLT DC LED THIN LITE



The **LED ST130WP** features a 48 LED bulb, powder coated aluminum housing and non-yellowing, acrylic diffuser lens. Delivers even, non-glare, lighting to ensure a stress free work environment. No hot-spots or eye strain. One Touch switch with 2 dimming levels. LED life of 100,000 hours and voltage input of 8-30 VDC. Uses 2.88W on low and 9.6W on high. Amp draw at 12VDC is .24A/.8A. Lumen rating of 480 on low and 1600 on high.

Dimensions: 12" x 5.375" x 1.75" / Three year warranty

ITEM #	Description	Price
L-LED-130WP	LED ST130WP Light Fixture	\$74



The **LED 116P** mimics the original dual surface mount/low profile fixtures from Thin-Lite. Non-yellowing, acrylic diffuser lens and white powder coated aluminum housing. Features 72 super bright LEDs with One Touch switch and 2 dimming levels. LED life of 100,000 hours and voltage input of 8-30 VDC. Uses 4.32W (.4A @ 12V) on low and 14.4W (1.25A @ 12V) on high. Lumen rating of 720 on low and 2400 on high. Dimensions: 18" x 5.625" x 1.375" / Three year warranty

ITEM #	Description	Price
L-LED-116P	LED 116P Light Fixture	\$97

# 12 VOLT DC LED THIN LITE



Thin-Lite's LED 180 Industrial and Commercial surface mount fixtures provide efficiency for use in commercial, industrial, and residential applications. Very easy to install. Clear acrylic diffuser lens with One Touch switch and two dimming levels. LED life of 100,000 hours and voltage input of 8 -30 VDC.

The **LED 186P** has 72 super bright LEDs and draws 4.32W(.24A) on low and 14.4W(.8A) on high. Equivalent lumens are 480 and 1600 respectively.

Dimensions: 18.125" x 3.625" x 3.5" / Weight: 2 lbs / Three year warranty.

ITEM #	Description	Price
L-LED-186P	LED 186P Light Fixture	\$107

# 12V DC LED CIRCULAR FIXTURE

Thin-Lite's Circuline series offers years of reliable, virtually maintenance free service. Minimum draw, utilizing 48 super bright high efficiency LEDs. Opaque white diffuser lens, white powder coated aluminum housing, and wood grain accent. One Touch switch with 2 dimming levels, LED life of 100,000 hrs, voltage input of 8 - 30 VDC. Uses 2.88W on low and 9.6W on high, draws .24A/.8A on 12VDC. Lumen output is 480 on low and 1600 on high setting.



Dimensions: 9.5" diameter x 1.75" / Three year warranty

ITEM #	Description	Price
L-LED-CIRCLE	LED Circular Light Fixture	\$75

# I2 VOLT DC MOTION SENSING LIGHT SWITCH WITH TIMER



**RAB** motion and heat sensing switch is 12 volt DC powered so it works full time even if the inverter is in standby or off. Turns light on at approach, and holds for adjustable time, 5 seconds to 12 minutes after motion stops. Sensitivity distance is adjustable, up to about 50 feet out, farther in colder weather. 70' wide zone. Connect directly to any 12 volt light, or use a 12 volt relay to switch 120 volt lights. Set for

night only operation, or use as security alarm, by setting for day/night operation. Switches 8 amps DC; uses only 7 milliamp at idle and 40 milliamps when active. Simple 3 wire hookup. Blue is (-); Brown is battery (+); and Black is load (+). **Caution: Do not use with DC Compact Fluorescents.** Excellent quality & performance. Ten year warranty.

ITEM #	Description	Price
L-RAB	12V DC Motion Sensing Light Switch	\$121



# WATER SYSTEMS

A GRAVITY FLOW TANK, where possible, is the best domestic supply. Water is pumped to, and flows back from, a large tank uphill from the house. The tank should be at least 22 feet higher than the point of use, to get 10 pounds or more water pressure (2.3 feet elevation per pound of pressure). It should be buried to keep cool and avoid freezing. At the Willey's home there was no hill above them to site a tank so they put four 100 gallon tanks at the highest heated level (4th floor) of their tall home. Pressure is only 7 pounds at their 2nd-floor kitchen, but with 3/4" and larger pipes, and no small restrictive couplings to the faucets they get good flow and fine showers on 1st and 2nd floors. NOTE: Instant (tankless) gas water heaters require at least 15 to 30 pounds of pressure to operate properly.

A PRESSURE TANK stores pressurized water without an uphill or elevated tank. A pump pushes water into the tank, and that compresses captive air in the tank. The air provides continuous pressure for water delivery. The pump recharges water to the tank as needed. Since pressure tanks are small, they need refilling often. An inverter-powered, 120 volt AC deep well pump or DC powered surface pump can refill the tank as frequently as needed. Pressure tanks in sizes from 20 to over 80 gallons are sold at hardware and plumbing stores. A larger pressure tank reduces the on-off cycling of the pressurizing pump. Larger is better!

LARGER WATER STORAGE. What if the AC pump must be high powered and perhaps 240 volt so it can run only on generator power? A larger water storage tank is needed so the generator is started only once a day or once a week to refill it, rather than starting it each time water is used. Large volume water storage, when no uphill tank is possible, can be done two ways:

1. Use several pressure tanks, enough for a day's water from one fill; or
2. Use a large buried tank near the house (or on a tower in non-freezing climates). This tank is filled by the well pump once a week or less, often using either a slow DC or fast AC pump. A second DC powered pump uses this tank to refill a small pressure tank in the house as often as needed as you consume water. This eliminates starting an AC pump often, or waiting for a slower DC submersible well pump to refill the pressure tank.

NOTE: DC Diaphragm pumps should never push water directly to a faucet without a pressure storage tank. It works, but more energy is used, and the pump and switch wear out quickly. Our EZ-SET-UP kit includes instructions for both plumbing and electrical connections for DC pumps with pressure tanks.

***Backwoods Solar welcomes all new product ideas. Many of the products you find in our catalog are here as a result of our customers telling us about a product they've discovered that they think we should offer. Please let us know of any ideas for new products.***

# WATER PUMP SELECTION

Depth of the well or water source determines the type of pump.

**SHALLOW WELL**, spring, creek, or storage tank where water surface is within 10' of ground level, can use the Flowlight DC or Aquatec AC or DC powered booster pumps located at the surface to suck the water up to the pump, and then push it as much as 100' higher than the source and great horizontal distances. These pumps can pressurize a tank in the house for better delivery of water to fixtures. Each rated pound of pressurizing ability equals 2.3 feet vertical lift. Surface pumps must be protected from freezing. They can often be a hassle to keep primed.

**DEEP WELLS** 15 feet or more down to the water level cannot have the water sucked from the top of the well. Suction can lift water only about 15-20 feet. For deeper distance to water, a submersible pump must **PUSH** the water up.

**DC POWERED** submersible deep well pumps may be the best choice because they do not require large bursts of power or use the inverter at all. DC submersible pumps use only 20% as much energy per gallon pumped as an AC centrifugal pump. Most pump very slowly so do not deplete the water level in a slow recovery well. They can be powered direct by solar modules, without batteries. Or they can be powered by house batteries like any DC appliance, if the well is within about 200 feet distance from the house. The submersible pump will not freeze or lose its prime.

**AC POWERED** centrifugal pumps are faster and last many years with no repairs. But they use 4 to 8 times more power per gallon pumped than slow DC pumps. AC pumps use much of the full capacity of the inverter, and come on at unpredictable times. Pumping and running a washer at the same time may require a relay to pause the washer and give the pump priority when it runs. A submersible deep well pump with a 1/2 horsepower, 120 volt AC motor can pump a 300 foot well and be powered by a 2500 watt or larger inverter. If an AC pump with external start box is used, get 120 volt AC, 1/2 horsepower maximum. The start box must be relay start control, not solid state control, if used with a modified wave inverter. Solid state start works ok with true sine wave inverters. No-surge pumps are best, if depth to water in the well is within their range.

**VERY DEEP WELLS** with a water level down the hole more than 230' need a higher power pump. Grundfos SQFlex submersible pumps lift up to 820'. Or a 240 volt AC pump might be used to fill a large tank once a week operating on generator power, or a large inverter and transformer, or two large inverters.



# WATER PUMP SELECTION

Backwoods Solar designs and sells hundreds of deep well submersible pumping systems each year and with every system, we ask the same questions. In order to properly satisfy pumping needs, we need the following information:

- 1) How deep is the well or alternative water source
- 2) What is the static water level in the well (the static level is that height in the well to which the water rises under it's own pressure)
- 3) How many gallons per minute does the well produce
- 4) How many gallons per day is needed
- 5) Will water be pumped to a non-pressurized holding tank or to a pressure tank
- 6) In either situation, how many feet above the well head is the tank located
- 7) If a pressure tank is used, how many pounds of pressure is desired
- 8) Will pump be powered directly from a PV array implying water is only needed when the sun shines or
- 9) Will the pump be powered by a battery bank either DC-direct or AC from an inverter
- 10) If PV direct, how many feet from the array to the well head
- 11) If battery based, how many feet from the battery system to the well head

Given this information, we can quickly and successfully build an appropriate water delivery system. For those developing a well, or a spring, or other submersible situation, take a moment to ponder the above questions; and then give us a call. We'll happily walk through the details!



Joe and Sally Smith's home



# GRUNDFOS SQFLEX SUBMERSIBLE

This is the ultimate submersible pump for water lifts of up to 820 feet. They can be directly powered by solar or run on an inverter, a generator, a battery, the utility grid, or any combination of these sources. 48-300v DC and 90-240v AC can be used to run these pumps. (max draw: 8.4 amps). These pumps will operate at 230V, 50 Hz.

Eleven pump models can deliver from 4.5 GPM at 820 feet to 80 GPM at 10 feet of head with a 1.4 kilowatt solar array or less. Helical rotor pumps for high head applications will fit in a 3" or larger well and centrifugal pumps for low head applications fit in a 4" or larger well. The SQFlex has built-in protection from dry-running, overload and overheating. PLEASE request spec sheets.

The SQFlex pump can run on a solar array starting at 129 watts and 30 volts however 120 volts required for full output at any given array wattage. 2 wire + ground connections with no AC or DC polarity issues. Two year warranty.

### Optional Controls

The CU200 interface box communicates with the pump and monitors operating conditions. 5 watts. Built-in diagnostics indicate faults and dry-run conditions as well as a display of operating status and power consumption. Input terminals for Reverse logic float level switch. On board on/off switch.

The IO50 is a simple control box with cable terminations and a manual on/off switch. It is a great interface between a solar array and the pump to allow turning off the high voltage array when working on the pump.

The IO101 is an interface for using AC backup or a solar array. A 120v AC automatic transfer switch disconnects the solar array when AC power from a generator, utility connection, or inverter is present. When AC power stops, it automatically reconnects the array. Has on-off switch.

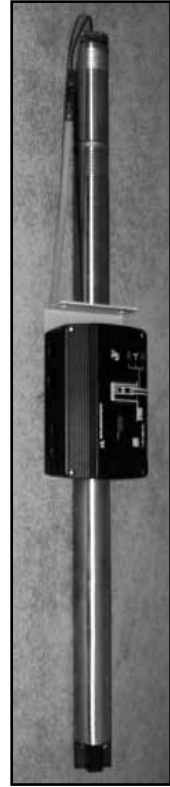

ITEM	Description	Price
<b>P-SQFLEX</b>	Grundfos SQFlex Pump & Kit	<b>\$2287</b>
<b>P-IO50</b>	SQFlex/PV On-Off Control Box	<b>\$71</b>
<b>P-IO101</b>	SQFlex AC/PV Interface Box	<b>\$515</b>
<b>P-CU200</b>	SQFlex Multi Purpose Interface	<b>\$432</b>

**Do not use these pumps with ground fault breakers.**

# GRUNDFOS SQ PUMP

## 120V AC Submersible Well Pump

### No Start Surge

### Deep well up to 260 feet depth to water



31.5"-39"  
long

The SQ Grundfos pumps have a SOFT-START electronic control built into the motor. Start-up is slow and gentle over 2 seconds, requiring NO POWER SURGE. This pump runs from much smaller generators or modified sinewave inverters, and can have longer wire to the pump. Soft start also eliminates start-up twisting strain on plastic pipe.

Thermal protection and over/under voltage for motor protection are built in. Two-wire plus ground operation, no control box required. The pump body is smaller 2.68 inch diameter so it fits down a 3" or larger well pipe. It can operate in any position from horizontal to vertical and can pump from a storage tank.

Total lift of any pump is height between water surface down the well to the elevation where water is delivered to a non-pressurized tank. Reduce maximum lift by 92', if the pump is used to pressurize a bladder tank to 40 pounds.

5S models have 1" discharge port; 10S & 15S models have 1.25" port. Ask for a complete performance chart to aid in selection. Does not tolerate sandy water, voids warranty. Max temperature is 104 degrees Farenheit.

Two year warranty.

ITEM #	HP & Amp Draw	GPM at Feet of Lift	Price
<b>P-5SQ05A180</b>	1/2, 9.8A	5 at 180'	<b>\$970</b>
MAX CAPABILITY OF ABOVE		1.1 at 260'	
<b>P-10SQ05A160</b>	1/2, 9.8A	10 at 160'	<b>\$877</b>
MAX CAPABILITY OF ABOVE		5 at 200'	
<b>P-15SQ05A110</b>	1/2, 9.8A	15 at 110'	<b>\$935</b>
MAX CAPABILITY OF ABOVE		7.5 at 160'	

240V models are also available.

Do not use these pumps with ground fault breakers.

# DC SUBMERSIBLE PUMP

## AQUATEC 4000



The Aquatec SWP-4000 is a submersible pump ideal for many off-grid applications. The DC motor can be driven by 12 or 24 volts from a battery bank or solar panel direct (considered 15 and 30 volt applications). As a lower volume pump it is ideally suited for filling livestock troughs or holding tanks.

It's rugged design includes a stainless steel casing, a double O-ring seal against leaks into the motor, a factory installed electrical wiring harness (with 36" leads), and a stainless steel water intake. The pump is field servicable a with a typical service cycle of two to seven years depending on use.

Solar direct applications should use a nominal panel size of ~110 watts at 24 volts for standard applications, but larger 60 cell panels can be used for peak performance and a wider window of operation. Aquatec recommends a maximum submersion depth of 75', meaning the pump should not be positioned any deeper than 75' below the static water level. Maximum total lift of 230'.

0.43 gallon per minute flow rate at 230' of lift (3.5 amp draw), 0.62 gpm at 20' of lift (1.1 amp draw), for 12 volt configurations.

1.25 gallon per minute flow rate at 230' of lift (3.7 amp draw), 1.70 gpm at 20' of lift (1.4 amp draw), for 30 volt configurations.

Dual-Size Stainless Steel Outlet Nipple Fits 0.5" Hose Barb Tubing (0.50 Inch ID) or 0.5" Poly Pipe (0.62 Inch ID).

Made in the U.S.A. Warranty of 12 months from date of purchase or 18 months from date of manufacture.

ITEM	Description	Price
<b>P-AQUA-4000</b>	Aquatec SWP-4000 Pump 12.5" long x 3.75" diameter	<b>\$789</b>
<b>Accessories &amp; Replacement Parts</b>		
<b>P-AQ-APC30-250</b>	Aquatec DC Solar LCB Pump Controller	<b>\$292</b>
<b>P-AQUA-4000-EBK</b>	End Bell Kit	<b>\$43</b>
<b>P-AQUA-4000-LHA</b>	Lower Housing Assembly	<b>\$84</b>
<b>P-AQUA-4000-MTR</b>	Replacement Motor Kit	<b>\$136</b>
<b>P-AQUA-4000-VHA</b>	Valve Housing Kit	<b>\$40</b>
<b>P-PUMP-WIRE</b>	Flat jacketed, 10awg 2-conductor wire. Order enough to get to an above water level splice, or to wellhead.	<b>\$1.50/ft</b>
<b>P-HOSE-250</b>	250' 1/2" drinking quality hose (also available by the foot for \$1 per foot)	<b>\$204</b>

# DC SUBMERSIBLE PUMP AQUATEC 6000



The Aquatec SWP-6000 is a submersible pump ideal for many off-grid applications. The DC motor can be driven by 12 or 24 volts from a battery bank or solar panel direct (considered 15 and 30 volt applications). As a lower volume pump it is well suited for filling livestock troughs or holding tanks.

The “6000” model is the sister pump to the Aquatec SWP-4000 model. The 6000 offers higher volume (up to 5 gpm) at lower maximum lift (120’). The 4000 offers lower volume (up to 1.7 gpm) at higher maximum lift (230’).

It’s rugged design includes a stainless steel casing, a double O-ring seal against leaks into the motor; a factory installed electrical wiring harness (with 36”, 12 gauge leads), and a stainless steel water intake. The pump is field servicable a with a typical service cycle of two to seven years depending on use.



Solar direct applications should use a nominal panel size of ~150 watts at 24 volts for standard applications, but larger 60 cell panels can be used for peak performance and a wider window of operation.

Maximum total lift of 120’. Aquatec recommends a maximum submersion depth of 100’, meaning the pump should not be positioned any deeper than 100’ below the static water level.

12 volt configurations: 1.10 gallon per minute flow rate at 120’ of lift (4.4 amp draw), 2.10 gpm at 0’ of lift (0.80 amp draw)

30 volt configurations: 3.30 gallon per minute flow rate at 120’ of lift (5.0 amp draw), 5.00 gpm at 0’ of lift (2.0 amp draw)

Warranty of 12 months from date of purchase or 18 months from date of manufacture.

ITEM	Description	Price
<b>P-AQUA-6000</b>	Aquatec SWP-6000 Pump, 5.75" diameter	<b>\$965</b>
<b>Accessories &amp; Replacement Parts</b>		
<b>P-SFWIRE</b>	Flat jacketed, 10awg 2-conductor wire. Order enough to get to an above water level splice, or to wellhead.	<b>\$1.50/ft</b>
<b>P-HOSE-250</b>	250' 1/2" drinking quality hose (also available by the foot for \$1 per foot)	<b>\$204</b>
<b>P-AQUA-6000-EBK</b>	End Bell Kit	<b>\$56</b>
<b>P-AQUA-6000-LHA</b>	Lower Housing Assembly	<b>\$109</b>
<b>P-AQUA-6000-MTR</b>	Replacement Motor Kit	<b>\$177</b>
<b>P-AQUA-6000-VHA</b>	Valve Housing Kit	<b>\$52</b>
<b>P-AQ-APC30-250</b>	Aquatec DC Solar LCB Pump Controller	<b>\$292</b>

# SOLAR SLOWPUMP

Slowpump is not submersible, but can draw water from shallow wells, springs, cisterns, tanks, ponds, rivers and streams, and push it as high as 450 vertical feet and through miles (kilometers) of pipeline. Slow pumping minimizes the size and cost of the solar array, wire and piping. Slowpump is less expensive than submersible DC pumps, and made in a much wider range of sizes. Wearing parts typically last 5 to 10 years. Overall life expectancy is 15 to 20 years.



## Suction Capacity

20 vertical feet (6 m) at sea level – subtract 1 ft. for every 1,000 ft. altitude (1 m for every 1,000 m). Pump should be placed as low as possible and gravity fed water is best.

## Filtration Requirement

This pump cannot tolerate dirt. Water must be filtered clear. If water is very dirty, improve the source.

## PV-Direct (non-battery) Requirements

The rated power of the PV array must exceed pump watts by 20% or more. Our table specifies actual PV watts needed. Performance specs in our table are at 15 and 30V DC. It's okay to power by a battery bank, but performance will be 20% less than our table specifies.

A linear current booster (controller) is required to start and run in low light.

## Fittings

1300 Series: 1/2" female; 2500 Series: 3/4" male

Dimensions: 5.7 x 15.5" / Weight: 16 lbs / One year warranty against defects in materials and workmanship.

ITEM #	Lift (ft)	GPM	PV Watts	Max Lift (ft)	GPM	PV Watts	Price
<b>P-1322</b>	20	.51	40	560	.20	340	<b>\$660</b>
<b>P-1308</b>	20	1.25	40	400	1.0	250	<b>\$660</b>
<b>P-1303</b>	20	2.5	65	240	1.96	235	<b>\$660</b>
<b>P-2507</b>	20	4.0	80	140	3.65	245	<b>\$690</b>
ACCESSORIES							
<b>P-FLOWFLTRKIT</b>	10" Inline Filter with Cartridge					<b>\$105</b>	
<b>P-10FILTERS</b>	Quantity 2, 10" Filters					<b>\$14</b>	
<b>P-DRSWITCH</b>	Works with 2500 series					<b>\$90</b>	
<b>P-DRSWITCH-1300</b>	For 1300 & 1400 series					<b>\$90</b>	

***Pumps have a nominal operating voltage of 12V or 24V. Please specify when ordering.***

# FLOWLIGHT BOOSTER PUMP

This rotary vane pressure pump uses one third to one half the energy of a conventional AC pump, and eliminates the high starting surges that push inverters to the limit. The Standard Flowlight Model 2920 is available in 12, 24 or 48V and the 2920-AC is 120V AC. There is an additional 2930-48V unit available. Max suction: 10'. The Low Speed Flowlight Model 2910 is available in 12, 24, & 48V DC only. Max suction: 20'. (Suction decreases 1'/1000' of elevation on both models).

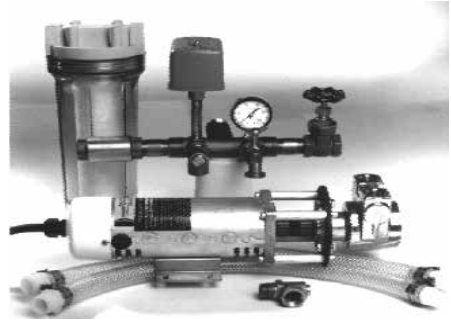

**Shown with EZ Flow Kit & Filter**

These 16.5" pumps are more powerful and much more durable than the less expensive Aquatec 550 diaphragm pumps. Wearing parts are replaceable, and typically last 5 to 10 years. Overall life expectancy is 15 to 20 years. This pump is the best choice for pressurizing a full-time off-grid residence. A large pressure tank, locally available, must be used. If possible, avoid sucking water & do not let this pump run dry!

The Standard model can generate a maximum of 4.5 gpm while the Low Speed model will deliver up to 3.4 gpm. Each model can produce 65 psi if needed with maximum power draws of 170-260 watts.

The Easy Installation Kit and Inline Filter are considered essential equipment and will make this pump simple for anyone to install and service. The Installation Kit includes pressure switch, pressure gauge, check valve, drain valve, T fitting, shut-off valve and pipe nipples.

Dimensions: 16" x 5" / Weight: 15 lbs / One Year Warranty

ITEM	Description	Price
P-2910	Specify 12, 24, or 48V DC	\$694
P-2920	Specify 12, 24, or 48V DC	\$767
P-2920-AC	120V AC	\$1027
P-2930-48V	48V DC	\$1441
P-EZFLOWKIT	EZ Flow Kit	\$168
P-FLOWFLTRKIT	10" Inline Filter with Cartridge	\$105
P-10FILTERS	Quantity 2, 10" Filters	\$14
P-DRSWITCH	Dry Run Switch	\$90

# AQUATEC 550 PRESSURE PUMP

The AQUATEC 550 pump is commonly used either to pressurize water from an atmospheric tank, to deliver purified water to a specific point of use, or simply to increase pressure when required.

Backwoods features a model that includes a standard 5 chamber diaphragm pump head, a permanent magnet motor, quick disconnect inlet/outlet ports, and a built-in pressure switch (cut-in at ~45 psi, shut-off at 60 psi). We include 1/2" barbed intake and outlet port fittings, which are ideal for connection to flexible hose to act as a shock absorber for pump vibrations. Order our P-EZ kit (page 143), if desired. The built-in pressure switch is NOT adjustable. Backwoods has an external Square D pressure switch that can be used instead, to operate the pump at lower, adjustable pressure settings for lower power consumption.



The 550 is a higher volume booster pump, capable of 5.3 gallons per minute at no head/pressure; and a maximum pressure capability of 70 psi (the equivalent of 161' of lift) with a delivery of 3 gallons per minute. At half power, the pumps can run for extended periods of at least a couple of hours with no heat concerns; BUT running at higher pressures than ~25 psi should be limited to runs of 25 minutes at a time to avoid overheating. This is a possible issue to consider with very large pressure tanks that take a long time to fill, but easily avoided with a small to medium pressure tank that can be charged to full in 10 minutes or less. This pump is capable of being run dry. MUST use pressure tank!

Power draw at no head is 5.5 amps, up to 18 amps at 70 psi.

Dimensions: 10" x 4.5" x 5" / Weight: 7 lbs / Warranty of 12 months from date of purchase or 18 months from date of manufacture.

ITEM	Description	Price
<b>P-AQUA-550-12</b>	Aquatec 550 Series 12V Pump & Fittings	<b>\$99</b>
<b>P-AQUA-550-24</b>	Aquatec 550 Series 24V Pump & Fittings	<b>\$106</b>
<b>P-AQUA-550-AC</b>	Aquatec 120V AC Pump & Fittings	<b>\$125</b>
<b>EASY SET-UP KIT</b> of hose, clamps, and water system diagrams; as well as <b>Pressure Tank Switches</b> are available in ACCESSORIES on page 143		
<b>REPLACEMENT PARTS FOR AQUATEC 550 SERIES</b>		
<b>P-AQUA-550-LHA</b>	Aquatec 550 Lower Housing Assembly	<b>\$34</b>
<b>P-AQUA-550-VHA</b>	Aquatec 550 Valve Housing Assembly	<b>\$24</b>
<b>P-AQUA-QBS554</b>	Aquatec Straight 1/2" Male Barbed Fitting	<b>\$4</b>
<b>P-AQUA-550-FILT</b>	Aquatec 550 Pump Strainer	<b>\$18</b>

# SOLAR FORCE LONG LIFE PISTON PUMP

Pumps more water with less power. Out lasts 10 small diaphragm pumps. Tolerates dirty water. Life expectancy is 20 years with 2-6 year owner performed maintenance schedule. Cast iron body, brass cylinder and valve seats, oil bath crankcase, and pressure relief valve.

Lifts water from shallow wells. Foot valve is required for suction lift. Maximum 22 feet suction, and push to 230 feet (100 psi) or to standard pressure tank.

Critical minimum inlet size: 1.25"; outlet 1" female NPT.

Permanent magnet DC motor models available for battery or direct solar power. 12, 24, 48, or 90 volt DC, or 120 or 240 volt AC. Use battery models for home system. Use solar direct with panels and with 15 amp LCB for pumping with no home battery system nearby. Dimensions: 23" x 13" x 16" / Two year warranty.

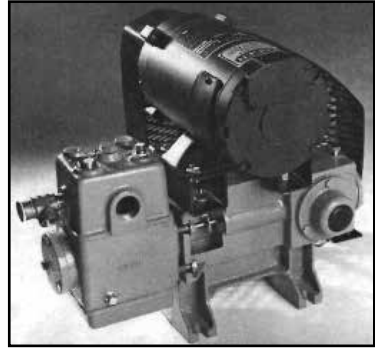

ITEM	Description	Price
<b>P-3010-B</b>	Solar Force: 5 GPM, 60 PSI, 1/4 HP - Battery	<b>\$1863</b>
<b>P-3020-B</b>	Solar Force: 5 GPM, 100 PSI, 1/2 HP - Battery	<b>12V - \$2514</b>
		<b>24V - \$2464</b>
		<b>48V - \$2444</b>
<b>P-3020-AC</b>	Solar Force: 5 GPM, 100 PSI, 1/2 HP - 115VAC	<b>\$2493</b>
<b>P-3040-B</b>	Solar Force: 9 GPM, 60 PSI, 1/2 HP - Battery	<b>12V - \$2617</b>
		<b>24V - \$2569</b>
		<b>48V - \$2547</b>
<b>P-3040-AC</b>	Solar Force: 9 GPM, 60 PSI, 1/2 HP - 115VAC	<b>\$2597</b>
<b>P-HDPRSWITCH</b>	Heavy Duty Pressure Switch for 3020 & 3040	<b>\$135</b>
<b>P-FOOTVALVE</b>	1.25" valve, required for suction lift	<b>\$60</b>

**SPECIFY MOTOR VOLTAGE: 3010 available in 12, 24 or 48V DC, battery operation only. 3020 & 3040 available in 12, 24, 48V DC, or 120 AC.**



# PUMP ACCESSORIES



## FLOAT SWITCH: Use with AC or DC pumps

Floating ball switch. Cord is tethered or weighted inside tank so that it comes tight, inverts the switch, when tank is full. We have one single pole double throw float switch which either turns pump off when tank is full, or turns pump off when source tank is empty. (If used to control LCB above, consult us for correct wiring because LCB reverses action of a float switch.) 2000' wire run with 18 gauge wire possible w/ LCB. Use white and red wires to turn pump off when a tank is full. Use white and black wires to turn pump off before water source is dry.

ITEM	Description	Price
P-FLOAT	Float switch SPDT up/down	\$55

**EASY SET UP KIT** Recommended for Aquatec 550 pumps. Four hose clamps and 15 feet of 1/2 inch hose for connecting pump to your plumbing. Hose reduces pump noise and prevents breakage of pump-head. Ten pages of wiring, plumbing, and repair instructions tell how to use pumps with pressure tanks and pressure switch.

ITEM	Description	Price
P-EZ	EZ Pump Kit for Aquatec 550	\$30

**HOSE:** Drinking quality nylon cord reinforced hose will not flavor or poison water. 1/2 inch inside diameter fits Aquatec Booster Pumps and Aquatec 4000/6000. Flexibility absorbs impulses from diaphragm pumps and quiets them.

ITEM	Description	Price
P-HOSE-250	250 Foot Roll (also available by the foot for \$1.25 per foot)	\$204

**PRESSURE TANK SWITCH:** adjustable pressure, cleanable contacts. Mounts in plumbing near pressure tank. More durable than built-in Aquatec switches. Works with any AC or DC pump. Does not come with a wiring diagram.

ITEM	Description	Price
P-PS-SQD	20/40 psi default settings; 65 psi max	\$34

# WHEN TO USE DC APPLIANCES

The smallest power system, such as a cabin with a few lights, water pump and radio, might use only low voltage DC. Though most larger power systems use an inverter for 120 volt AC power for appliances, there are exceptions where special DC appliances save lots of energy and money, and avoid technical problems. Check our introductory chapter on selecting appliances for independent power.

**BOTH AC and DC appliances**, each where most appropriate, make a better working and less costly power system. Most AC inverters automatically turn off and save battery power at night or whenever no AC power is being used.

**SOME DEVICES MUST BE ON DUTY 24 HOURS A DAY.** DC from the main battery is better suited for those few items that need a trickle of power 24 hours a day. Examples are motion sensing outdoor light or alarm systems, cord-less, cell phone and message machines, clock-radio timers, a doorbell, aquarium/pond bubble aerators and smoke alarms. Turning those appliances off at night and when the house is vacant to save power defeats their purpose.

**SOME DC APPLIANCES USE MUCH LESS POWER:** Special DC model evaporator coolers, refrigerators, water pumps, fans, bed-warmers, rechargers for shavers, flashlights, and cordless tools use much less power with DC. AC models consume excessive power as they must keep an inverter on full time.

**HOW DC CIRCUITS ARE SET UP:** Most power centers have extra circuit breakers for safely connecting DC power from the battery. A circuit breaker or fuse on each wire is as important for DC as for AC. Our Square D "QO" series circuit breaker boxes are rated for low voltage DC. One DC outlet in each room of an otherwise AC home will cover most future needs. DC appliances are mostly low wattage, so most DC circuits can be installed with 10 gauge standard romex house wire. AC appliances must not be plugged into DC by mistake, or vice versa. The outlets for AC and DC must be different types. Don't use cigarette lighter plugs and sockets which are poor quality and do not meet building codes.

**CONVERT BETWEEN 12, 24, or 48 VOLTS:** Our Samlex voltage converters allow 12 volts to be obtained from a 24 or 48 volt battery, or 24 volts from a 48 volt battery. We also offer step up DC converters for similar, low-power applications.

# LARGE DC FANS



Sugar Mountain fans are ideal for greenhouses or attic venting. We currently just have battery based fans available. These fans are not to be used solar direct. Because of the brushless motor design they do not behave like regular motors. They cannot be reversed and they will not work well off solar panels. The battery fans can be run off 12v or 24v battery banks. If you use the optional speed control the output is 0-2300cfm for the 16" model. Output for the 20" model can be 0-3100cfm. Output on the 24" model is 0-3900cfm. On a 12v battery bank the 16" fan output would be 1200 cfm and the fan would consume 23 watts. The 20" fan on a

12v battery bank will output 2000 cfm and consume 34 watts. The 24" fan on a 12v battery bank will output 2700 cfm and consume 44 watts.

New this year is a 24v battery bank only fan. The speed control does not work with these budget oriented fans. We are also offering them without the full frame or shroud. You can build your own. These "frameless" fans have the following outputs. 16"-1300cfm, 20"-2220cfm, 24" 2780cfm. Maximum power draw is about 50 watts. A 2 year warranty is offered on all of the models.

16" Fans - Dimensions: 20.125" X 20.125" X 5.5". Weight: 16 lbs.

20" Fans - Dimensions: 24.125" X 24.125" X 5.5" - Weight 20 lbs.

24" Fans - Dimensions: 26" x 26" x 6" - Weight: 24 lbs.

ITEM	Description	Price
<b>A-F16-B</b>	16 inch DC Fan	<b>\$315</b>
<b>A-F20-B</b>	20 inch DC Fan	<b>\$377</b>
<b>A-F24-B</b>	24 inch DC Fan	<b>\$515</b>
<b>A-F16-B-NF</b>	16 inch DC Fan - No Frame	<b>\$215</b>
<b>A-F20-B-NF</b>	20 inch DC Fan - No Frame	<b>\$238</b>
<b>A-F24-B-NF</b>	24 inch DC Fan - No Frame	<b>\$315</b>
<b>A-FAN-CONTROL</b>	Fan Controller	<b>\$10</b>
<b>A-FANTHERM</b>	Thermostat for Attic Fan	<b>\$49</b>

# PORTABLE 12V DC FANS

Manufactured in the USA by the Amish folks of Arthur, IL to their demanding standards, these rugged, plastic housed fan are quiet, powerful, and efficient. Model 124 pictured at right.



FREEDOM FAN Model 124 has a 12" blade, 2 speeds, draws 1 amp at 12v on low and 3 amps on high. It has a metal adjustable tilting base that can also be wall mounted. Our version ships with a 6' cord that has battery clamps. We would recommend removing these clamps and hard-wiring to your 12v system with a fuse in the (+) leg. 500-1500 cfm.

ITEM	Description	Price
A-FREEFAN	Model 124: 12V, 12 inch blade diameter	\$168

## 12/24 VOLT DC CEILING FAN REMOTE-CONTROLLED, 4-Blade Fan



Fans are available with brass housing and oak laminate blades or white housing and white blades or satin nickel plated housing and white blades. The three speed reversible motor is controlled by infrared remote control. The 12V draws 1.2 amps at high speed, 0.75 amps at medium speed, and 0.5 amps at low speed. It is designed for surface mounting on a flat ceiling.

A swivel mount for pitched ceilings is available as an option. It includes a white 6" downrod extension. This 1/2" rod can easily be replaced with conduit and length of your choice purchased locally. 12mA phantom load. One year warranty.

ITEM	Description	Price
A-CEILFAN12	40" 12V Ceiling Fan (specify Brass/Oak or All White)	\$154
A-CEILFAN12NW	40" 12V Ceiling Fan - Satin Nickel/White	\$170
A-CEILFAN24	40" 24V Ceiling Fan (specify Brass/Oak or All White)	\$159
A-CEILFAN24NW	40" 24V Ceiling Fan - Satin Nickel/White	\$176
A-SWIVELKIT-WH	Required w/ any downrod installation (6" white downrod included)	\$20
A-CEIL-REMOTE	Additional Replacement Remote (specify voltage)	12V \$42
		24V \$46
A-CFMOTOR	Replacement motor for these fans (specify voltage)	12V: \$55
		24V: \$71

# EFFICIENT REFRIGERATORS

Refrigerators for solar electricity should be the most efficient, lowest energy consumption available. Super efficient electric refrigerators and freezers designed with 3 to 5 inches of insulation use only one third the energy of most standard units. This catalog shows the best of those solar designed refrigerators. They are the very best choice for smaller power systems.

Check website [www.energystar.gov/products/refrigerators/](http://www.energystar.gov/products/refrigerators/). Standard freezers and refrigerators use up to 3000 watt hours each day. But many of the 19-24cf Energy Star refrigerators use 1.3 to 1.5 kWh per day and retail around \$1000. You would need to add two larger 260-280W modules in the best year round sunny locations to power them; more modules in less sunny areas. Approximate cost for the sunniest locations: \$1000 for the refrigerator plus \$500 for the solar modules equals \$1500 or so to use the best, Energy Star rated, conventional units.

Refrigerators that are specially designed for solar require fewer solar modules and less generator time. All our refrigerators are energy rated in watt-hours used per day. Watt-hours compare equally whether 12, 24, 48, or 120 volt units. Divide watt-hours per day by your battery voltage, 12, 24, or 48 to get amp-hours per day consumed.

**GAS versus ELECTRIC:** A refrigerator's need for power typically matches solar electric production: more energy in summer and less in winter. Added solar modules for electric refrigeration raise the up-front cost, whereas you pay for propane gas for 15+ years. Long term comparison is close either way (if gas prices don't rise). **WARNING: COMBINATION GAS-ELECTRIC** refrigerators are usable only as gas powered, not as electric. These combination models use an electric heater that runs nearly full time to replace the gas flame. They use more power than any electric compressor, so they are not practical as electric units.

**NOVAKOOL** products are smaller DC powered refrigerators made for RV & marine markets. Adding 2 extra inches foam insulation to all surfaces except the door cuts that power use in half. A very practical choice for a small refrigerator IF you add the insulation.

**SUNDANZER** DC powered chest freezers are as well insulated and efficient as any available, 200 to 800 watt hours/day, at better prices.

## EXTERNAL THERMOSTAT

Plug your freezer into the thermostat and the thermostat into the wall. Has a built-in temperature probe that is placed into the freezer/refrigerator compartment and a dial for fine-tuning the temperature. Backwoods has been using one with a Sundanzer F-165(AC/DC model), running it as a refrigerator but maintaining a temperature of 36 F with a daily power consumption of 167 watt hours per day. Note: The unit functions by disconnecting power to the freezer when the compressor is not running, therefore any compartment lights will NOT come on when the compressor is not running. Attached 8 foot cord included.



ITEM	Description	Price
R-4E047	120VAC External Thermostat	\$117

# SUNDANZER

## DC CHEST FRIDGES AND FREEZERS

### *12 or 24 volt DC Operation*

Thick insulation, top opening, and a refrigeration system optimized for solar makes SunDanzer refrigerators and freezers the ultimate low energy user. SunDanzer cabinets are commercially produced by Electrolux of Sweden, one of the world's leading refrigeration unit manufacturers. SunDanzer chest-style refrigerators and freezers are easy to clean using the drain hole at the bottom. Interior light in all models. 6' 2 wire 12awg wire lead. Can be hardwired to battery bank using a 15A inline fuse, or a DC plug can be added and will be code compliant as long as no 240V wiring exists within the home. 4.3 inches of insulation. Maximum 10-12 amp draw at 12V. Instantaneous surge: 2x max draw.



Exceptional low energy consumption direct from the house battery. Danfoss brushless DC compressor operates on 12 or 24 VDC. Power used is at +38 and +10 degrees. 3" clearance all on sides required.

If an AC/DC model is ordered, the unit will have 120V AC cord and plug wired into it and it will have the same DC cord without plug wired into it. Both AC and DC cords can be plugged in at the same time and the AC power is primary and it will automatically switch to DC if the AC power is taken away. Once AC power returns, it will return to powering the unit.

Interior capacity: R165 - 5.6 cubic feet (28"L x 25"H x 16"D)  
 R225 - 7.9 cubic feet (38"L x 25"H x 16"D)

Two year warranty

Item	Description	Exterior Size (WxDxH) Weight	Energy Used 90 Degrees	Price
R-R165	5.6 Cu. Ft. Fridge with 3 baskets	36.8" x26.2" x 34.5" 130 lbs	168 watt hours/day	<b>\$1106</b>
R-F165	5.6 Cu. Ft. Freezer with 3 baskets	36.8" x26.2" x 34.5" 130 lbs	441 watt hours/day	<b>\$1106</b>
R-R225	7.9 Cu. Ft. Fridge with 4 baskets	46.9" x 26.2" x 34.5" 150 lbs	198 watt hours/day	<b>\$1236</b>
R-F225	7.9 Cu. Ft. Freezer with 4 baskets	46.9" x 26.2" x 34.5" 150 lbs	532 watt hours/day	<b>\$1236</b>
R-SUNDNZR-ACDC	AC/DC Option - Allows unit to be operated AC or DC (must be ordered at same time as unit above)			<b>\$138</b>
R-THERMOST-F2R	Turns an existing freezer unit into a refrigerator			<b>\$30</b>
R-THERMOST-R2F	Turns an existing refrigerator unit into a freezer			<b>\$30</b>

# SUNDANZER DC FREEZER

Save on costs with the SunDanzer 390 DC freezer. This new larger capacity freezer has exceptionally low energy consumption requiring smaller, less expensive power systems and low operating expense.

With the added insulation and a refrigeration system optimized for off-grid applications, this newest addition to the SunDanzer family of Energy Efficient refrigeration appliances will provide the same outstanding economical and reliable operation as their smaller chest style units.

Low energy consumption allows SunDanzer refrigerators and freezers to be the most cost effective for use with power from solar, wind, fuel cells or batteries. This technology allows refrigeration in remote locations where it was previously unavailable or prohibitively expensive. 6' 2 wire 12awg wire lead. Can be hardwired to battery bank using a 15A inline fuse for 12V operation (7.5A fuse for 24V operation), or our DC plug can be added and will be code compliant as long as no 240V wiring exists within the home. Voltage: 10-31VDC



## FEATURES:

- Low Frost System
- Environmentally friendly CFC-free refrigerant (R-134a)
- Easy to clean aluminum interior
- Rugged scratch resistant galvanized steel exterior
- Automatic control with adjustable thermostat

Interior Capacity: 13.3 cubic feet

Two year warranty

Item	Description	Exterior Size (WxDxH) Weight	Energy Used 90 Degrees	Price
R-F390	13.3 Cu.Ft. DC Freezer	63.4" x 28.7" x 34.3" 175 lbs	800 watt-hours/day	\$1394
R-SUNDNZR- ACDC	This model is not available with the AC/DC option			NA

BACKWOODS IS AN AUTHORIZED RESELLER OF REPAIR AND REPLACEMENT PARTS FOR SUNDANZER APPLIANCES. LET US KNOW IF WE CAN HELP YOU WITH YOUR EXISTING UNIT

ALL SUNDANZERS SHIP TRUCK FREIGHT; CALL FOR FREIGHT QUOTE DUE TO SIZE, 30 DAY RETURN PRIVILEGE DOES NOT APPLY TO THIS ITEM

# SUNDANZER DC UPRIGHT REFRIGERATOR



**DCRF290**

- Gray exterior
- No inverter required
- Low voltage disconnect for battery protection
- Right hinge only

Sundanzer is now offering two upright refrigerator/freezers, DC power only for 12 or 24 volts.

The **DCRF290** features a 1.8 cuft freezer and 8.4 cuft refrigerator compartment. DC power only for 12/24V.

The **DCRF450** has a 5 cuft freezer and 10 cuft refrigerator. 12/24V or 48V available. Please specify when ordering.

Both units use a Tecumseh/Cascade compressor that Sundanzer has been using successfully in their F390 freezers. An efficient compressor together with thick, insulated walls, reduces power consumption below levels typically seen in comparable EnergyStar products.

Temperature is controlled by a single thermostat. Defrosting is manual, to save on power consumption. Condensation will accumulate in the refrigeration compartment (in any refrigerator without auto-defrost) and should be wiped up periodically.

Two year limited warranty.

Item	Description	Exterior Size (WxDxH)	Energy Used 70/90 Degrees	Price
<b>R-RF290</b>	10.2 Cu.Ft. DC Fridge & Freezer	25.3" x 29.9" x 68.5"	500/800 watt-hours/day	<b>\$1009</b>
<b>R-RF450</b>	15 Cu.Ft. DC Fridge & Freezer	30.75" x 28.5" x 74.75"	550/950 watt-hours/day	<b>\$1373</b>

ALL SUNDANZERS SHIP TRUCK FREIGHT; CALL FOR FREIGHT QUOTE  
DUE TO SIZE, 30 DAY RETURN PRIVILEGE DOES NOT APPLY TO THIS ITEM



# NOVAKOOL REFRIGERATORS



**R5810**

**Interchangeable  
12V or 24V DC**

**Very Reliable**

**26 DC Models &  
24 AC/DC Models  
Available**

Best buy in a small refrigerator for solar power, favored in our catalog for over 20 years. NOVAKOOL offers 26 DC models and another 24 AC/DC models. Made to build into RV or marine cabinets. Exterior is galvanized sheet metal. The door comes with a white (black by special request) ABS panel but you can slide in paneling or Formica, or use a square of carpet on the door for durability and insulation. Interior is well finished with 2 shelves, vegetable crisper, and a top freezer box, 2 ice cube trays included. Call for color brochure! Hinge side must be determined.

Running power on all models has been reduced with new dual voltage Danfoss compressors and new refrigerant. Single door models consume 35 watts when compressor runs: under 3 amps 12 volt, or 1.5 amps 24 volt. Two door models will consume up to 60 watts. Running time varies with temperature but is about 30% duty cycle on a 70 degree day. Owner can glue foam board insulation to the entire outside of box to cut daily run time roughly in half. As supplied the R4500 uses 480 watt hours/day, but with added insulation, just 240 watt hours on a 70 degree day. The new Danfoss compressors use R134A (CF3-CH2F) refrigerant gas for atmospheric protection. Interchangeable use on 12 or 24 volt DC.

One year warranty on parts and labor; Two years on parts.

ITEM	Description	Price
<b>R-4500</b>	4.3 cu. ft. refrigerator with freezer box	<b>\$1117</b>
<b>R-5810</b>	5.7 cu. ft. refrigerator with freezer box	<b>\$1403</b>
<b>R-FU-9000</b>	9.1 cu. ft. two door upright fridge/freezer	<b>\$1914</b>
<b>R-RFS7501</b>	7.5 cu. ft two door side by side fridge/freezer	<b>\$1566</b>

NOVAKOOLS TYPICALLY SHIP VIA FREIGHT TRUCK. CALL FOR A QUOTE. DUE TO SIZE, 30 DAY RETURN PRIVILEGE DOES NOT APPLY TO THIS ITEM.

# EDUCATIONAL BOOKS

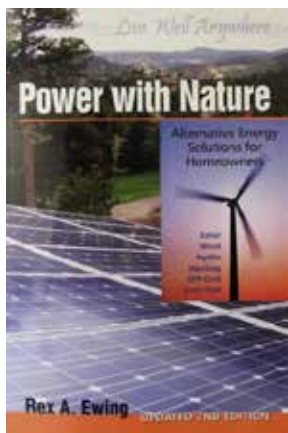

## **POWER WITH NATURE** by Rex A Ewing (3rd Edition)

A comprehensive book by an off-grid homesteader explaining independent power in plain language. Covers solar, wind, and hydro power planning, also hot water, home heating, and water systems. Revised in 2012 with latest equipment explained. Our **best selection** for overall system review. Lots of diagrams and pics. 240 pages.

## **MICROHYDRO CLEAN POWER FROM WATER** by Scott Davis

ESSENTIAL READING!

Highly illustrated and practical, this book covers both AC and DC systems, principles, design, site considerations, equipment options and more. 157 pages.

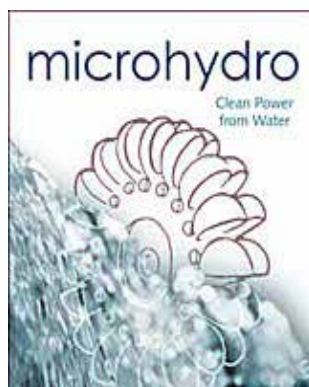

ITEM	Description	Price
<b>E-POWER</b>	Power with Nature, Solar & Wind Demystified	<b>\$18</b>
<b>E-HYDROBK</b>	MicroHydro Clean Power from Water	<b>\$21</b>

# ORDERING INFORMATION

**BACKWOODS SOLAR ELECTRIC SYSTEMS**  
1589 RAPID LIGHTNING ROAD  
SANDPOINT, IDAHO 83864

**Phone: (208) 263-4290 / Fax: (208) 265-4788**

**Email: [info@backwoodssolar.com](mailto:info@backwoodssolar.com)**

**OFFICE HOURS** are Monday thru Friday, 8:30 AM to 4:30 PM, PACIFIC.

Nights, weekends, and when phones are busy, some calls may go to our message machine. Leave a message. **We will call you back!!**

**PLACING ORDERS:** The quickest way to order is to give us a call. **Phone** orders with a credit card are processed immediately. You may also **fax** or **email** your orders. Please include a phone number so that, should the need arise, we can call you. Orders may also be placed thru our **website** at [www.backwoodssolar.com](http://www.backwoodssolar.com).

And finally, we can also accept orders by **mail** using the order blank forms on page 155. This is the method with the slowest processing time. It's best to give us a call ahead of time, if possible, so that we may give you a shipping total for your items.

**ALL ORDERS MUST BE PREPAID** by cash, money order, good check or credit card. We accept Visa, MasterCard, American Express or Discover card. We can also accept checks by phone or Paypal.

**Check out our website for the most  
current news, products, and bargains.**

**[www.backwoodssolar.com](http://www.backwoodssolar.com)**

**PRICES** may change between printings. **We try to stay with the best prices, and match or better most sale prices that you find. If you see a lower, currently advertised price, call us before you order and ask.**

## **RETURNS, EXCHANGES, WARRANTY**

Manufacturers warranty and return address are included with each product. PLEASE contact them first. If they don't help you, please let us know.

Additionally, you can return or exchange unsatisfactory items to Backwoods Solar within 30 days of purchase, **if in original unaltered new condition** with box and instructions. (This does **not** apply to heavy large appliances, custom built items, special order items or where ever stated in catalog). Be sure to enclose a note telling us the trouble and what you would like done: exchange, repair, or refund. Include your name & address. If you call first we may resolve it better by phone.

**SPECIAL REQUESTED ITEMS** not in this catalog are not returnable.

# SHIPPING & ORDERING INFO

**Actual shipping charges will apply based on the weight, dimensions and destination of the shipment.  
\$12 MINIMUM SHIPPING PER ORDER.**

## ***UPS or US POSTAL SERVICE?***

Backwoods Solar will ship small orders via UPS or the US Postal Service at our discretion unless you specify a preferred method. Large/bulky orders will ship via LTL freight. Orders ship Monday through Friday. We can ship via Fed Ex if you have a Fed Ex account.

## ***FASTER DELIVERY WITHIN 48 STATES***

**UPS 3 DAY SELECT** minimum \$20 per order; or actual amount, if more.

**UPS 2ND DAY AIR** minimum \$30 per order; or actual amount, if more.

## ***ALASKA, HAWAII, and PUERTO RICO***

Orders ship via UPS Ground or US Postal Service Priority; the actual freight amount to be determined. Some items cannot ship via USPS.

**CANADA** Orders ship via US Postal Service Priority whenever possible. The actual freight service and amount to be determined. In some cases, a customs broker (provided by you) is required to get your shipment through customs.

***ALL ORDERS: Solar Modules must go UPS or truck freight.***

---

**Your shipment is fully insured against damage but damage must be IMMEDIATELY reported to the carrier or the insurance is lost. Damage **MUST** be noted on delivery receipt in the case of freight shipments.**

---

## ***TO FIND US***

Directions to Backwoods Solar are available over the phone or by mail/email from us.

## ***NEED HELP?***

Visit us between 1pm and 4pm PST M-F or Call between 8am and 5pm M-F (PST)  
or Write or Email anytime.

## ***INSTALLATION***

We help diagnose problems, but **we do not do installations**. Installation can take from 4 to 20+ hours. We can sometimes refer you to a local installer that you can contract with independently. Several installers are licensed electricians, living in their own solar powered homes.

Phone (208) 263-4290 \* 8-5 Pacific Time \* Weekdays \* FAX (208) 265-4788

Email: [info@backwoodssolar.com](mailto:info@backwoodssolar.com) \* Website: [www.backwoodssolar.com](http://www.backwoodssolar.com)

# BACKWOODS SOLAR ORDER BLANK

CUSTOMER NUMBER FROM CATALOG LABEL \_\_\_\_\_

PHONE # (\_\_\_\_\_) \_\_\_\_\_ - \_\_\_\_\_ DATE \_\_\_\_\_

NAME \_\_\_\_\_

BILLING ADDRESS \_\_\_\_\_

CITY \_\_\_\_\_ STATE \_\_\_\_\_ ZIP \_\_\_\_\_

SHIPPING ADDRESS \_\_\_\_\_

CITY \_\_\_\_\_ STATE \_\_\_\_\_ ZIP \_\_\_\_\_

FOR POST OFFICE PARCEL POST SHIPPING ONLY  
CHECK THIS BOX IF UPS WILL NOT DELIVER TO YOUR  
LOCATION, OR IF YOU ONLY HAVE A POST OFFICE BOX

**CREDIT CARD #**

**EXPIRES (MM/YY)**

\_\_\_\_\_ / \_\_\_\_\_

Last 3 digits on back of card: \_\_\_\_\_

We accept Visa / Master Card / Discover / American Express

Item #	Qty	Description	Price Each	Total

Shipping: We charge actual charges (MIN. \$12) based on the weight, dimensions and destination of the items being shipped. Please give us a call for a quote.

**TOTAL COST OF ITEMS ORDERED \$** \_\_\_\_\_

in Idaho add 6% sales tax to total before shipping fee: \$ \_\_\_\_\_



**PLUS TOTAL SHIPPING (Minimum \$12) \$** \_\_\_\_\_

**TOTAL AMOUNT OF ORDER \$** \_\_\_\_\_

Your shipment is fully insured against damage but damage must be **IMMEDIATELY** reported to the carrier or the insurance is lost.

# WIRING SIZING USING VDI CALCULATION

Using a Voltage Drop Index calculation will allow you to figure the correct size wire for the percentage of voltage drop you would like to stay within on your systems wiring.

$$VDI = \frac{\text{Amp} \times \text{Feet}}{\% \text{ Voltage Drop (2 - 3\%)} \times \text{Voltage}}$$

where:

- amps = maximum number of amps through circuit
- feet = one way wire distance
- % voltage drop = percentage of voltage drop desired, use 2 for 2%
- voltage = voltage running through the wire

## Voltage Drop Index Chart

Wire Size (AWG)	Copper Wire		Aluminum Wire	
	VDI	Ampacity	VDI	Ampacity
4/0	99	230	62	180
3/0	78	200	49	155
2/0	62	175	39	135
1/0	49	150	31	120
2	31	115	20	94
4	20	85	12	65
6	12	65		
8	8	50		
10	5	30		
12	3	20		
14	2	15		

**AMPACITY** (in free air at ambient temps of 30°C) The ampacity of wire is affected by the temperature rating of the insulation. The chart above reflects wire with an insulation rating of 75°C. Higher temp ratings such as 90°C & 105°C will result in higher ampacity ratings. For example, the 4/0 inverter cabling that Backwoods stocks has insulation with a 105°C rating; resulting in an ampacity rating of 454 Amps. 2/0 cable with a 105°C rating has an ampacity of 336 Amps.

# BATTERY WIRING DIAGRAMS

All wiring diagrams are in series parallel to get to the proper voltage based on the voltage of each battery.

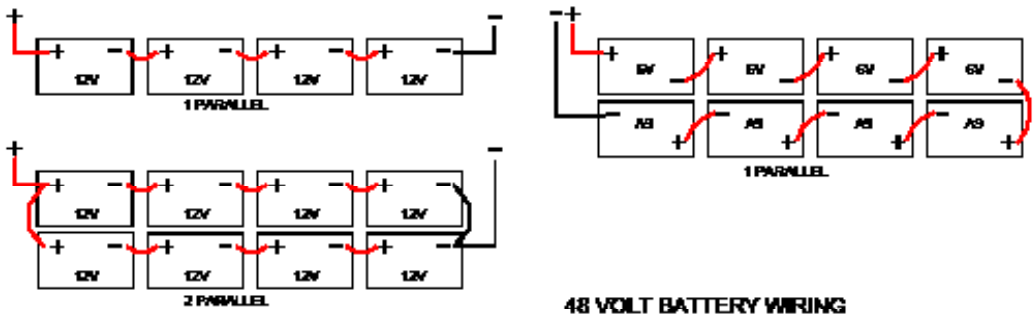
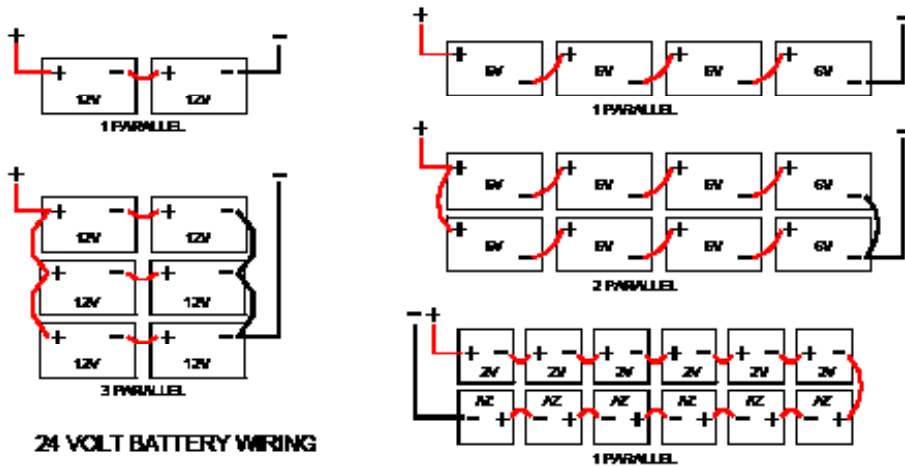
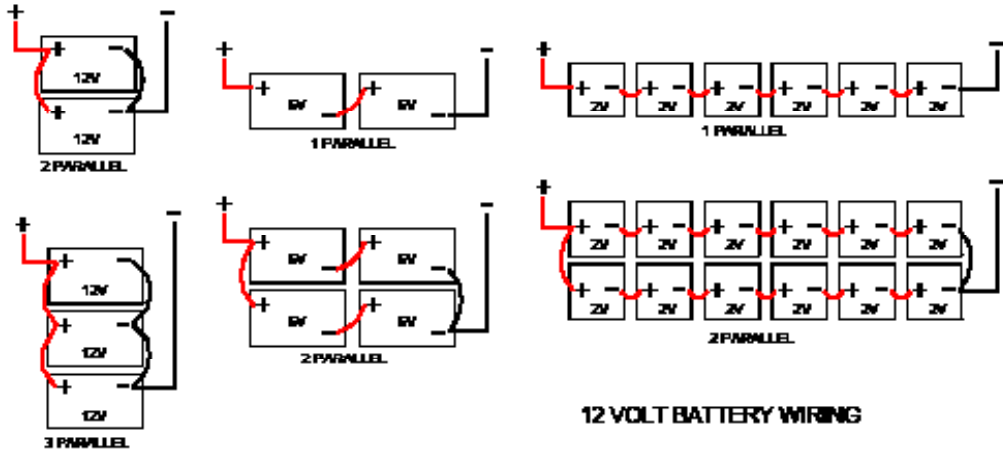

# OFF-GRID BATTERY SIZING WORKSHEET

We suggest a battery bank sized to provide enough energy for three days of energy consumption without any charging (solar, hydro, wind, generator) and that will not deplete the battery bank's capacity by more than 50% and that will compensate for a battery manufacturer's over-rating of their batteries. Follow these steps to determine your battery bank's size.

**Step 1:** Determine the watt-hours per day you need (**the total from the Off-Grid Load Worksheet on page 18**) and enter that number on Line 1.

**Line 1:** \_\_\_\_\_

**Step 2:** Multiply Line 1 by 6 and enter on Line 2

**Line 2:** \_\_\_\_\_

**Step 3:** Divide Line 2 by your system's nominal voltage (12, 24 or 48) to arrive at a battery bank's **amp-hour** rating, which is the typical rating used by manufacturers and enter on Line 3.

**Line 3:** \_\_\_\_\_

**Step 4:** Multiply line 3 by 1.2 to compensate for what we believe is "over-rating" of capacity by manufacturers. This is the battery bank size you need. Enter on Line 4.

**Line 4:** \_\_\_\_\_



# LIGHT LEVELS & LUMENS

Lumens represent the amount of light emitted by a light source, such as a light bulb. Following are typical lumens levels for various light (CFL) bulbs. Realize that recommended light levels will vary based on the person and the task. When purchasing light bulbs don't assume that more watts means more light, more lumens means more light.

Light Output	LED Bulb	CFL Bulb	Incandescent Bulb
Lumens	Watts	Watts	Watts
122-125	.5-1.5	3	15
210 (ambient)	2-3	4-8	25
450-500 (general room lighting)	4-5	9-13	40
800-900	6-8	13-15	60
1100-1400 (suitable for reading)	9-13	18-25	75
1600-2600	16-20	23-30	100
2600-2780	25-28	30-55	150

Light on a surface (such as a tabletop) is referred to as illuminance, which is typically represented by footcandles (lumens per square foot, equal to 10.76 lux) or lux (lumens per square meter, equal to 0.092903 footcandles)

# NOTES