

BOEING 747 OPERATIONS MANUAL

AIRPLANE GENERAL COCKPIT PANELS

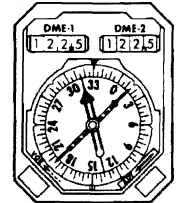
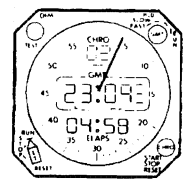
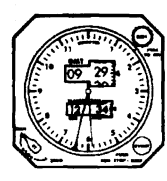
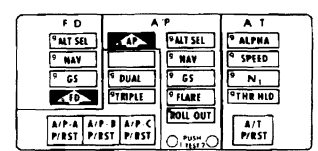
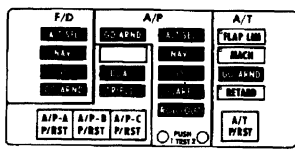
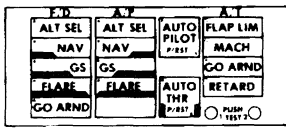
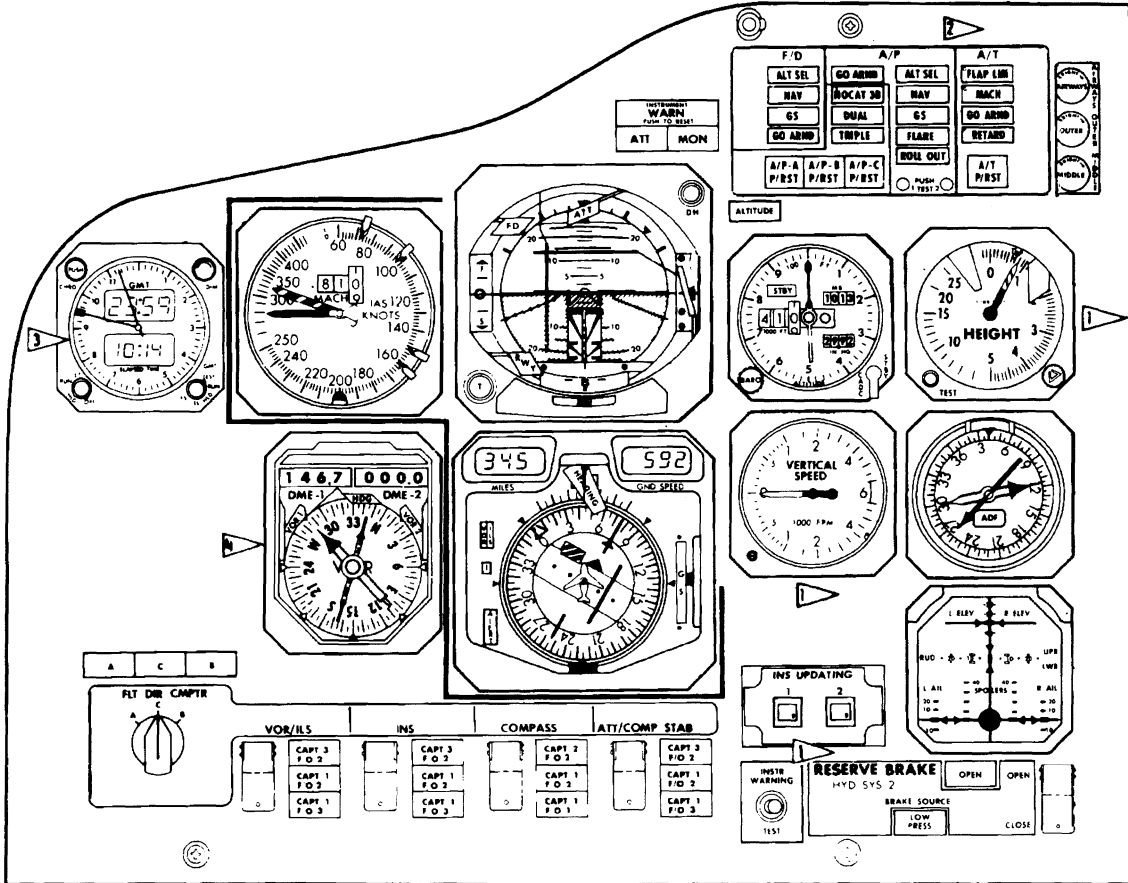

1 ▷ Indicators reversed on some airplanes

2 ▷ thru 5 ▷ As installed

CAPTAIN'S INSTRUMENT PANEL

B90677

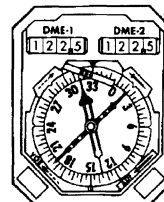
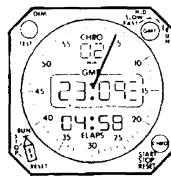
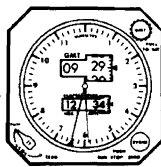
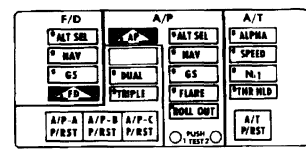
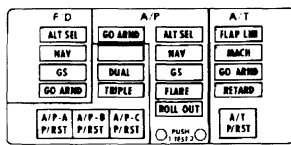
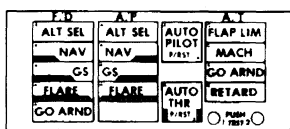
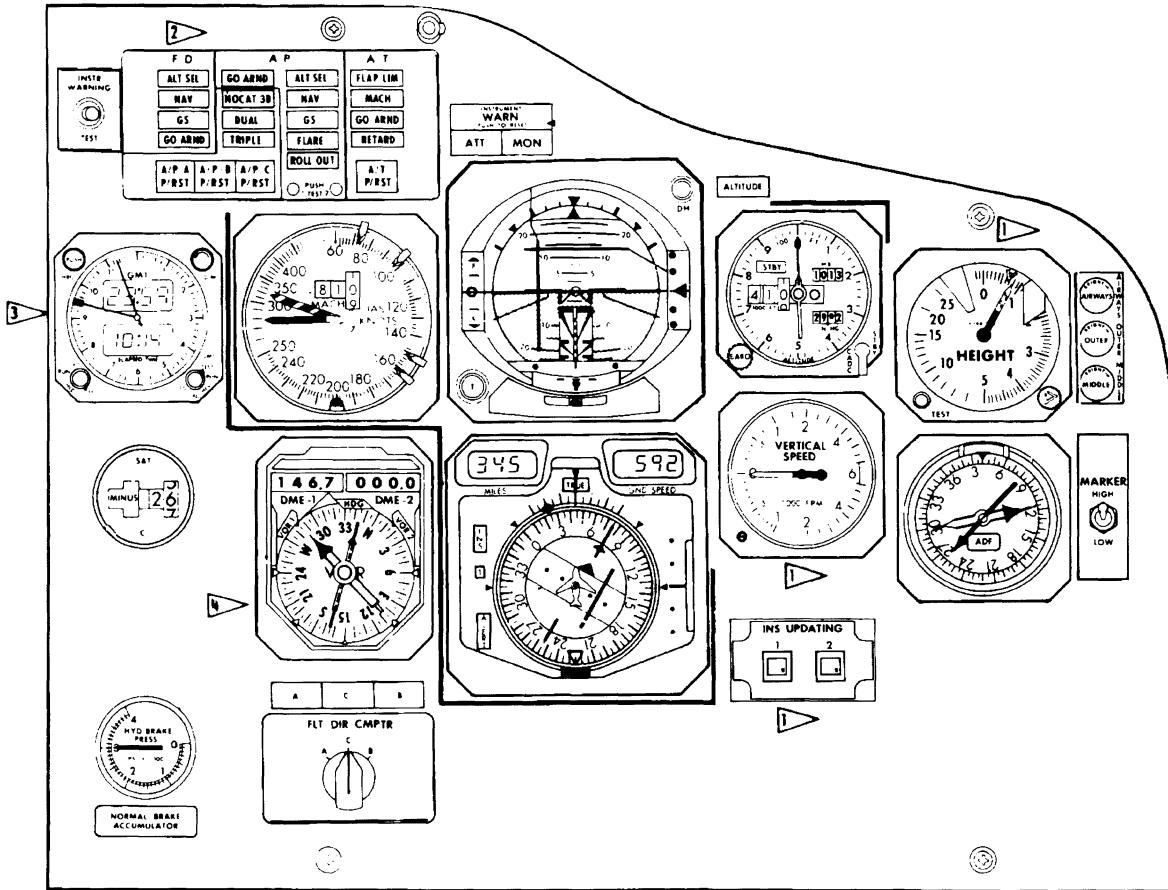

1 Indicators reversed on some airplanes

2 thru 4 As Installed

FIRST OFFICER'S INSTRUMENT PANEL

BOEING 747 OPERATIONS MANUAL

AIRPLANE GENERAL COCKPIT PANELS

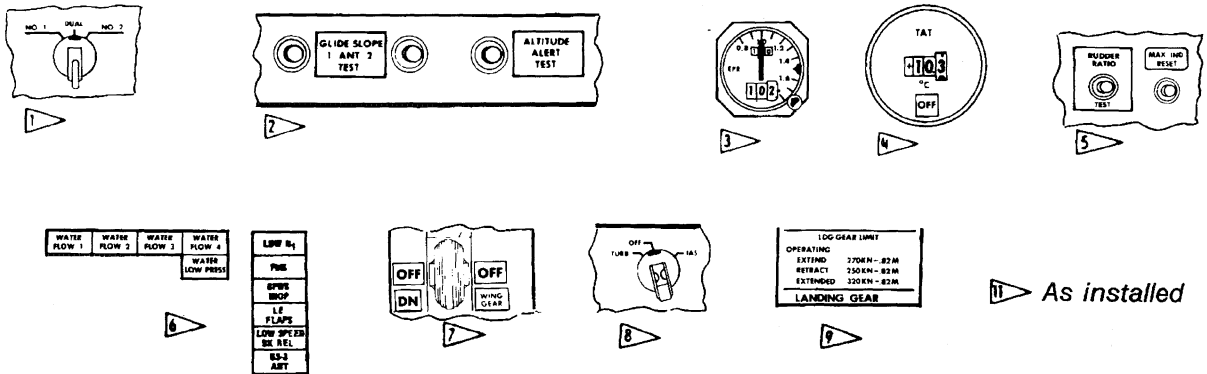
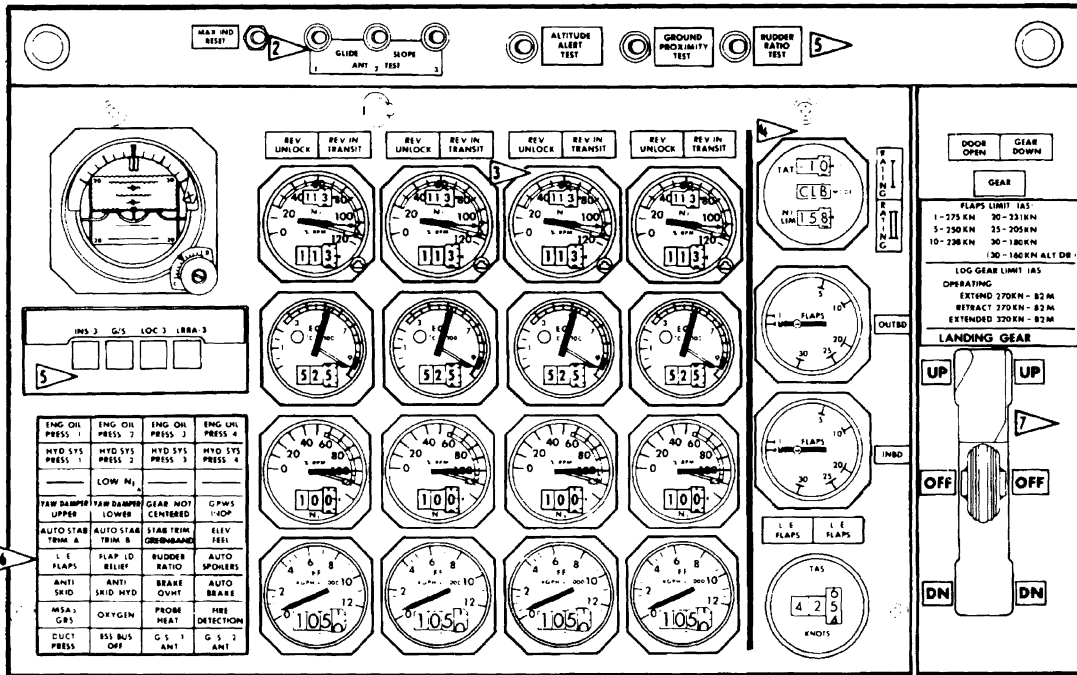
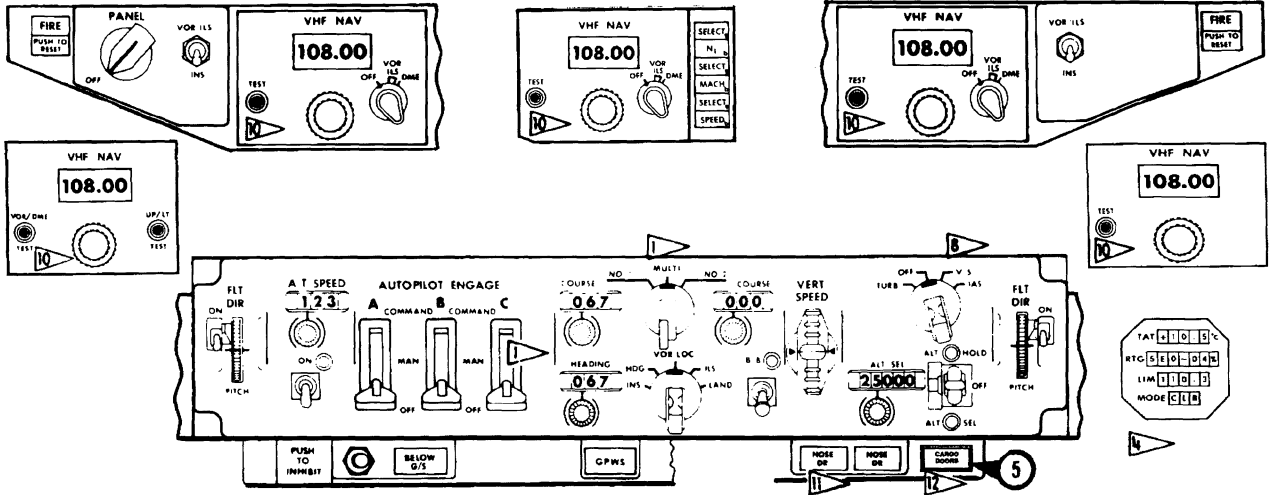

As installed

1 thru 12 As installed

PILOTS' CENTER INSTRUMENT PANEL & LIGHTSHIELD

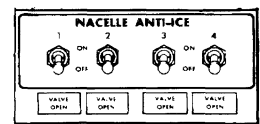
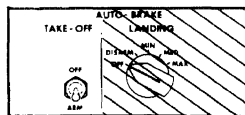
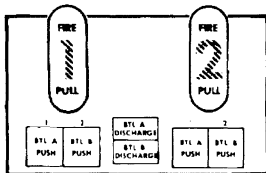
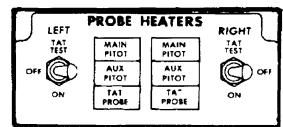
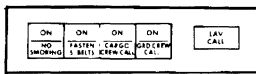
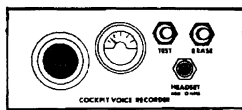
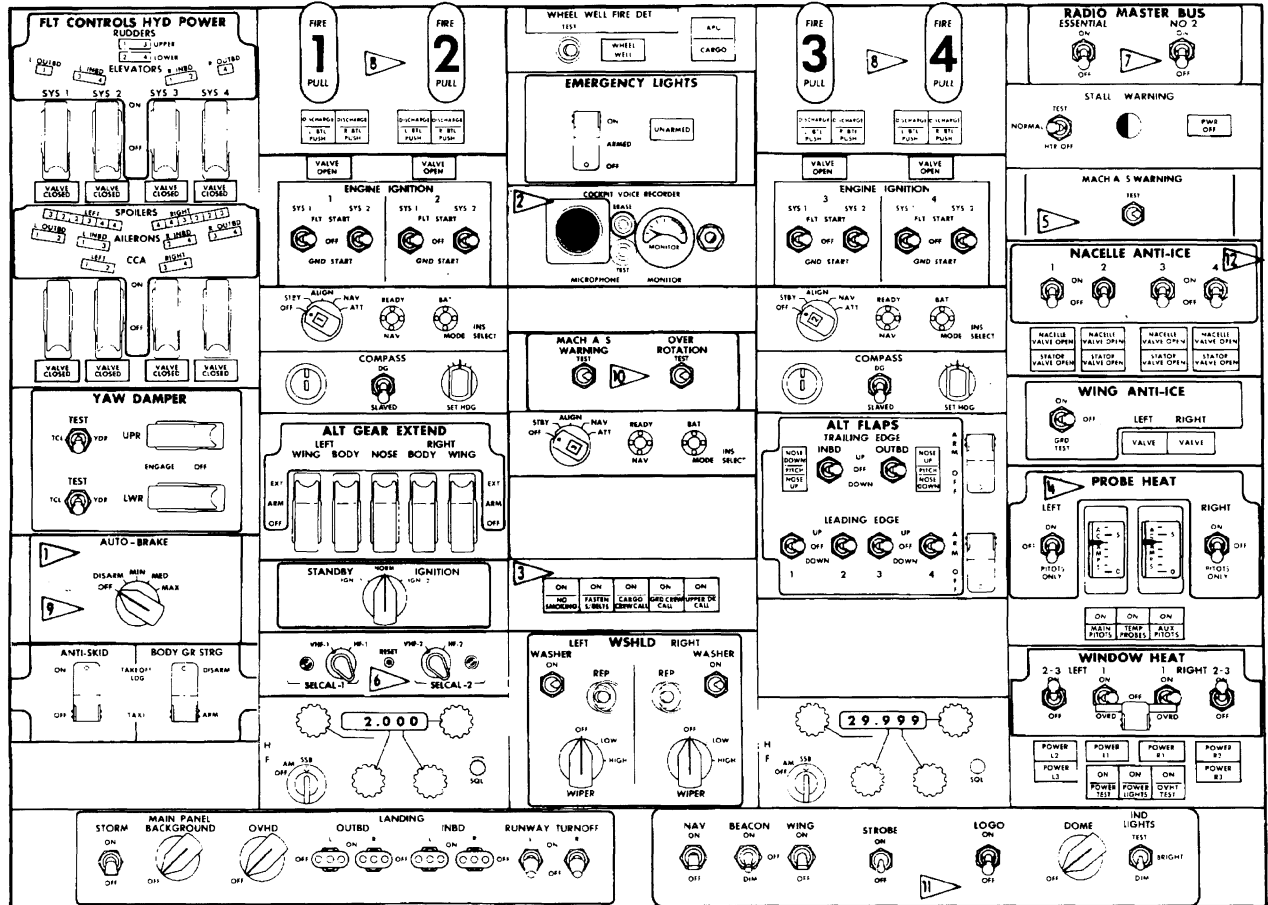

1 thru 12 As Installed

PILOTS' OVERHEAD PANEL

BOEING 747 OPERATIONS MANUAL

AIRPLANE GENERAL COCKPIT PANELS

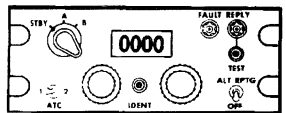
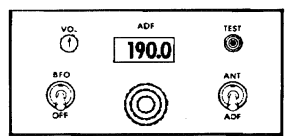
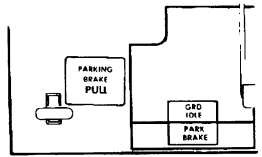
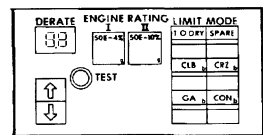
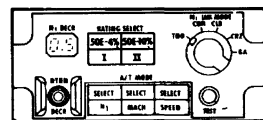
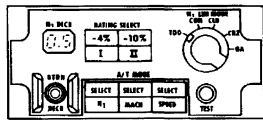
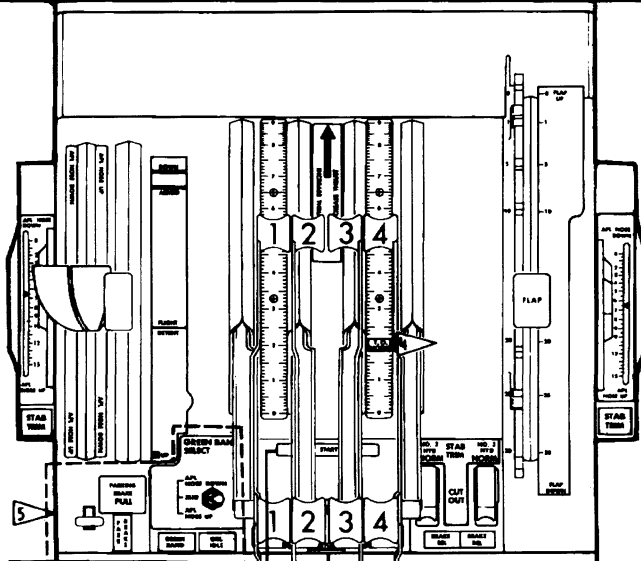
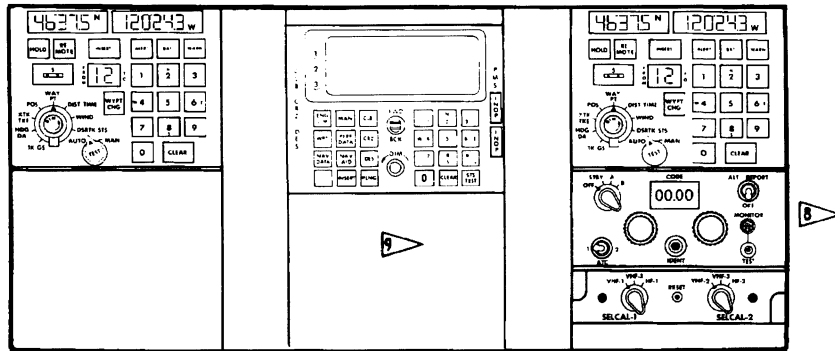

4 T.O. HORN decal

8 As installed

9 As installed

1 thru 9 As installed

PILOTS' CONTROL STAND

B92045

79T
Oct 05/89

05.20.05

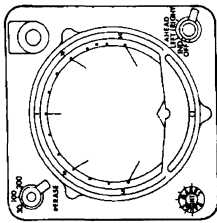

AFA

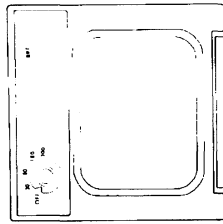

ALI

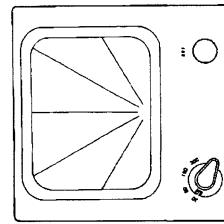

DLH

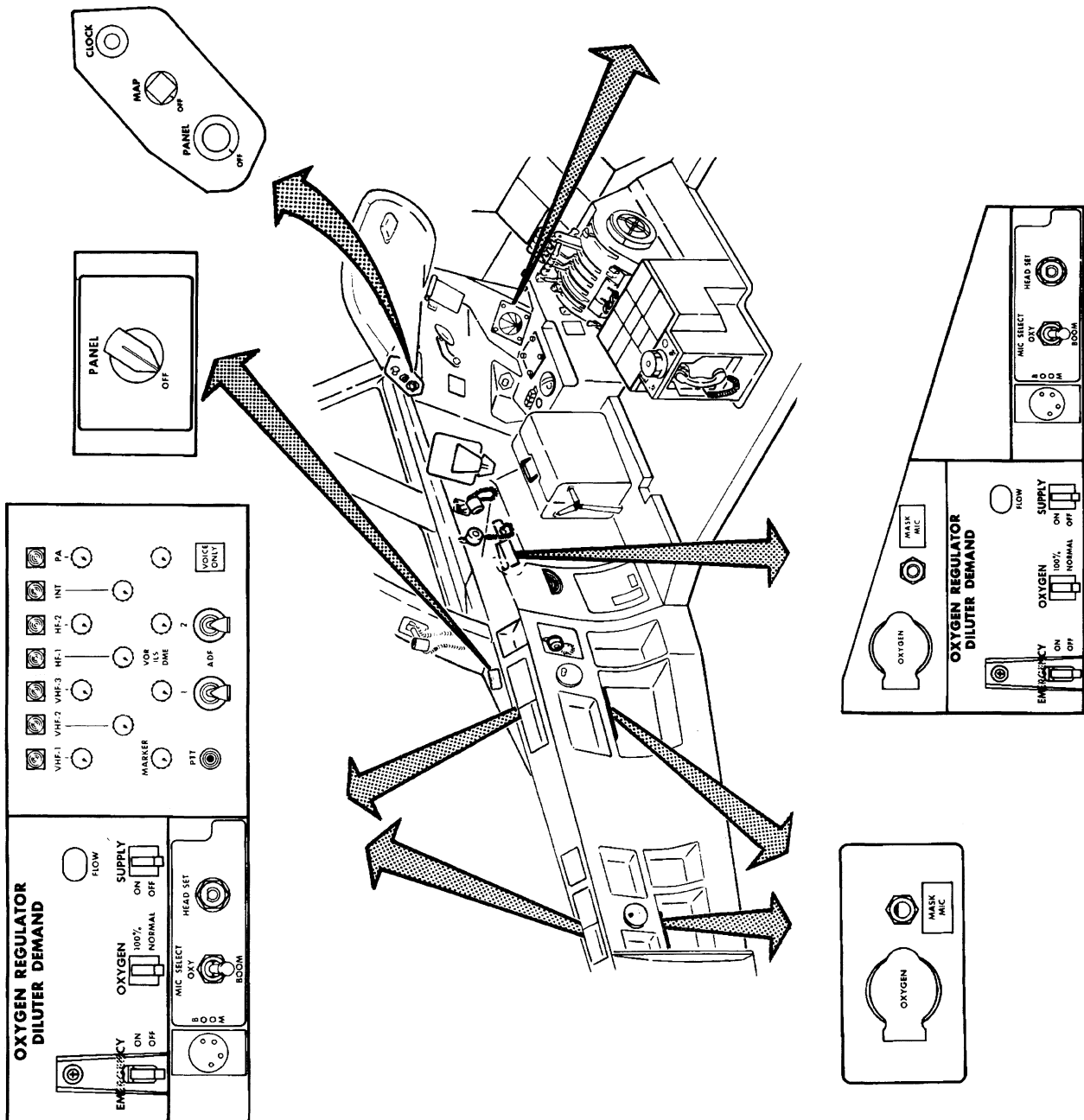

PILOTS' AUXILIARY AND OBSERVERS' PANELS

BOEING 747

OPERATIONS MANUAL

**AIRPLANE GENERAL
 COCKPIT PANELS**

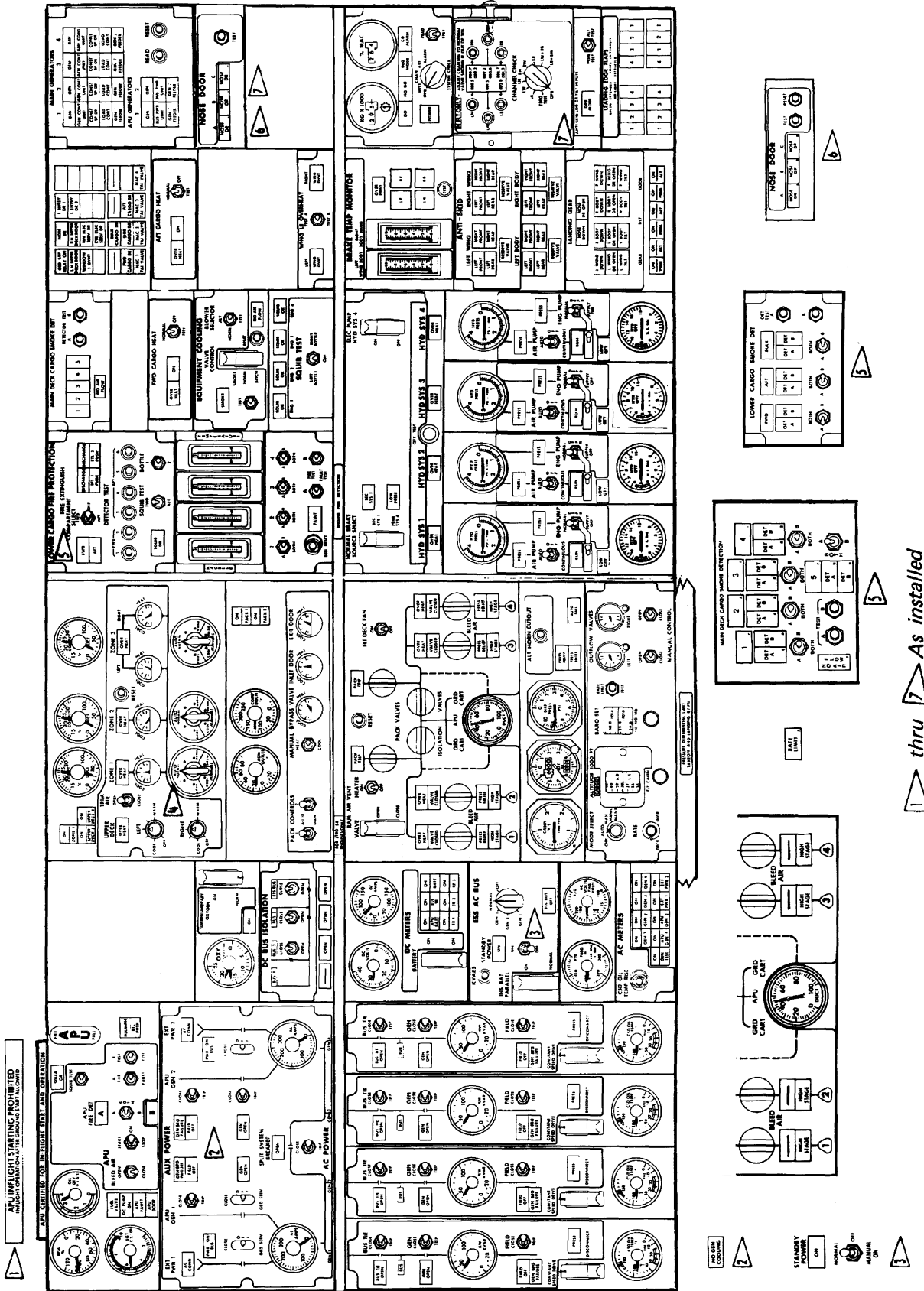

**FLIGHT ENGINEER'S INSTRUMENT PANELS - UPPER
 AFA**

B92995

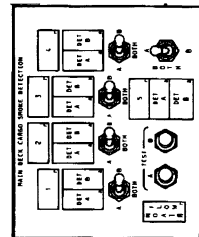
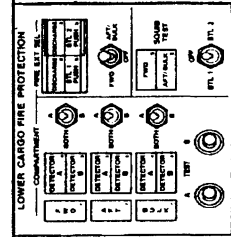
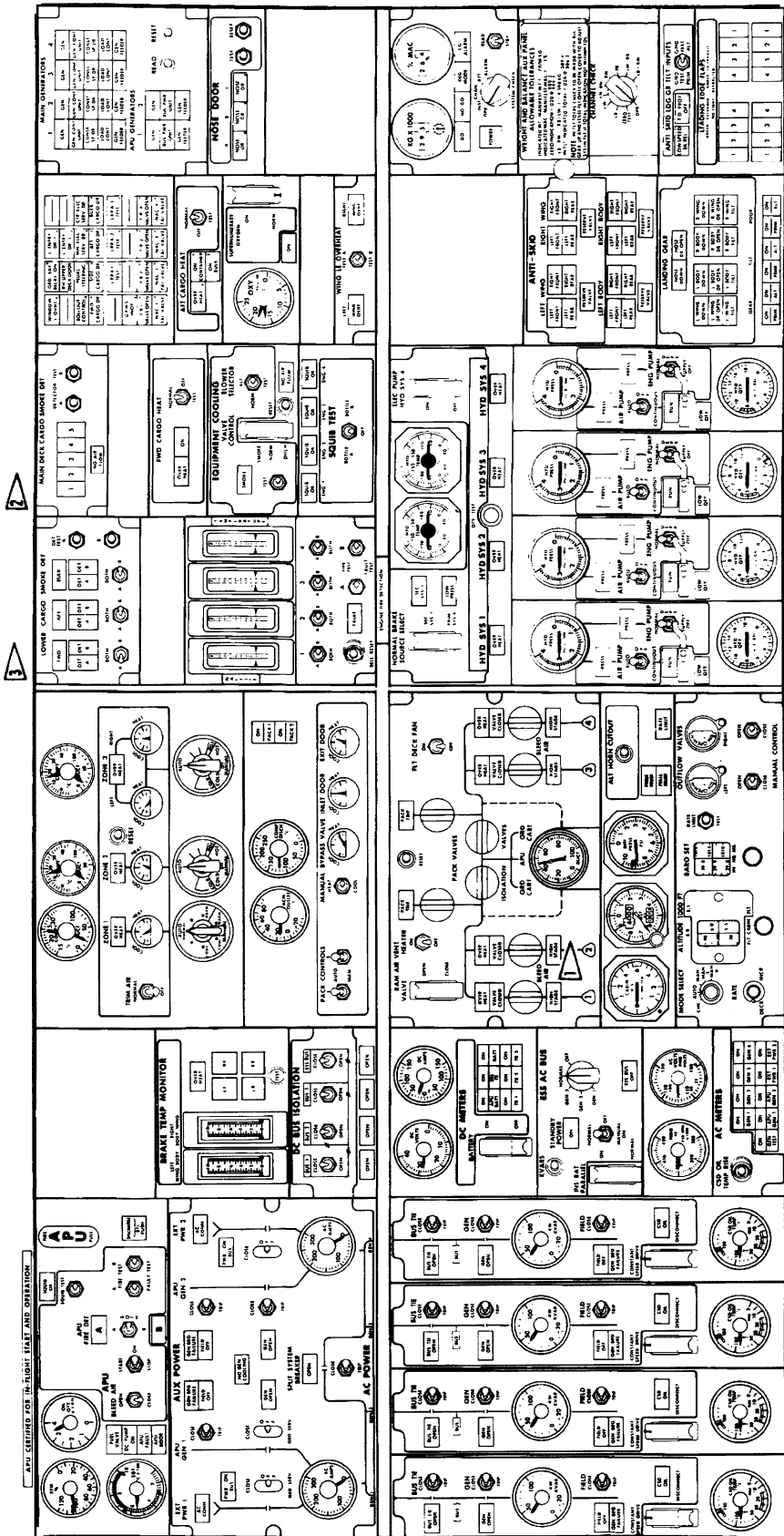

1 thru 3 As installed

C65379

05.20.08

FLIGHT ENGINEER'S INSTRUMENT PANELS - UPPER

ALI

79
Nov 24/93

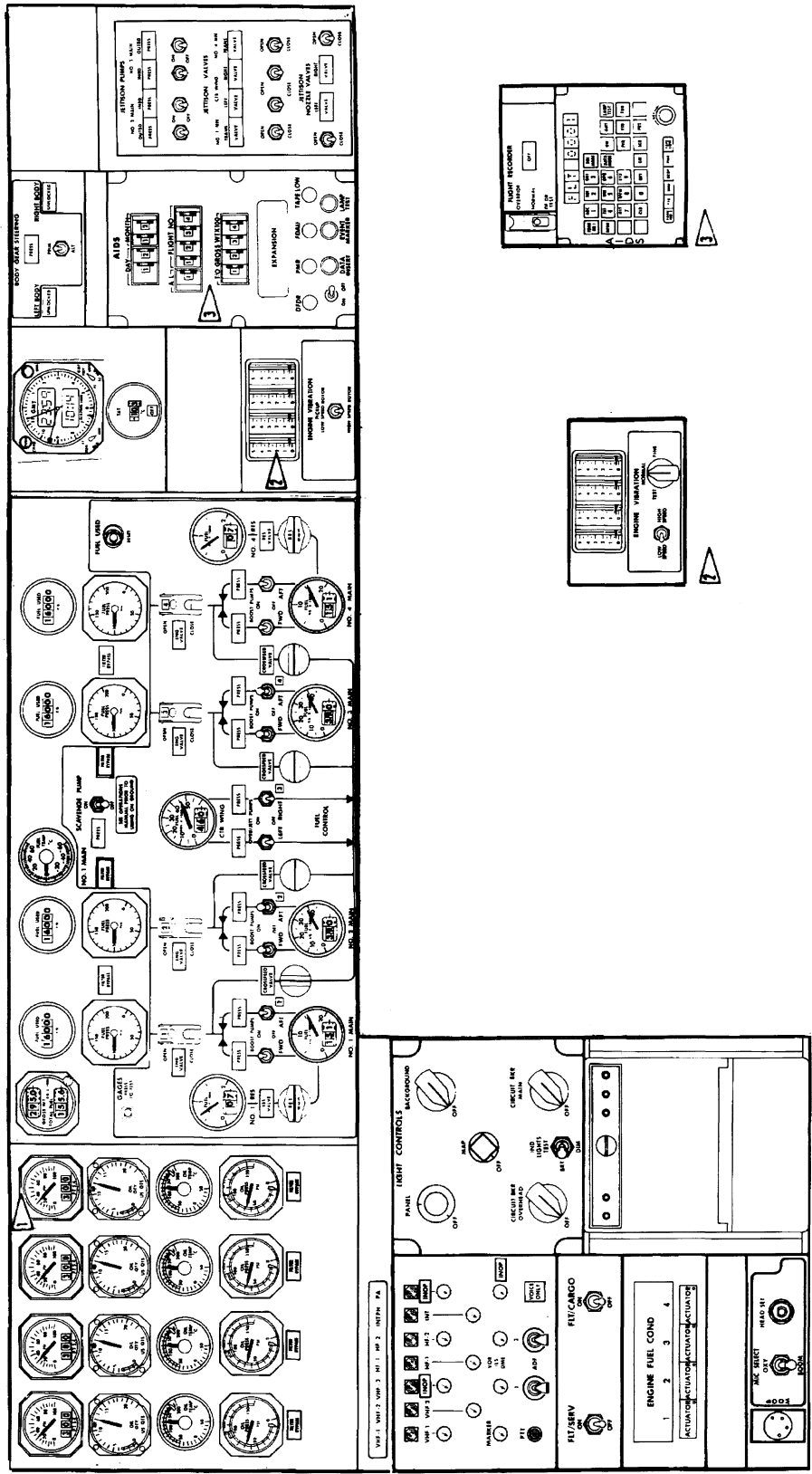

1 thru 3 As Installed

FLIGHT ENGINEER'S INSTRUMENT PANELS – LOWER (GE ENGINES)

BOEING 747 OPERATIONS MANUAL

AIRPLANE GENERAL COCKPIT PANELS

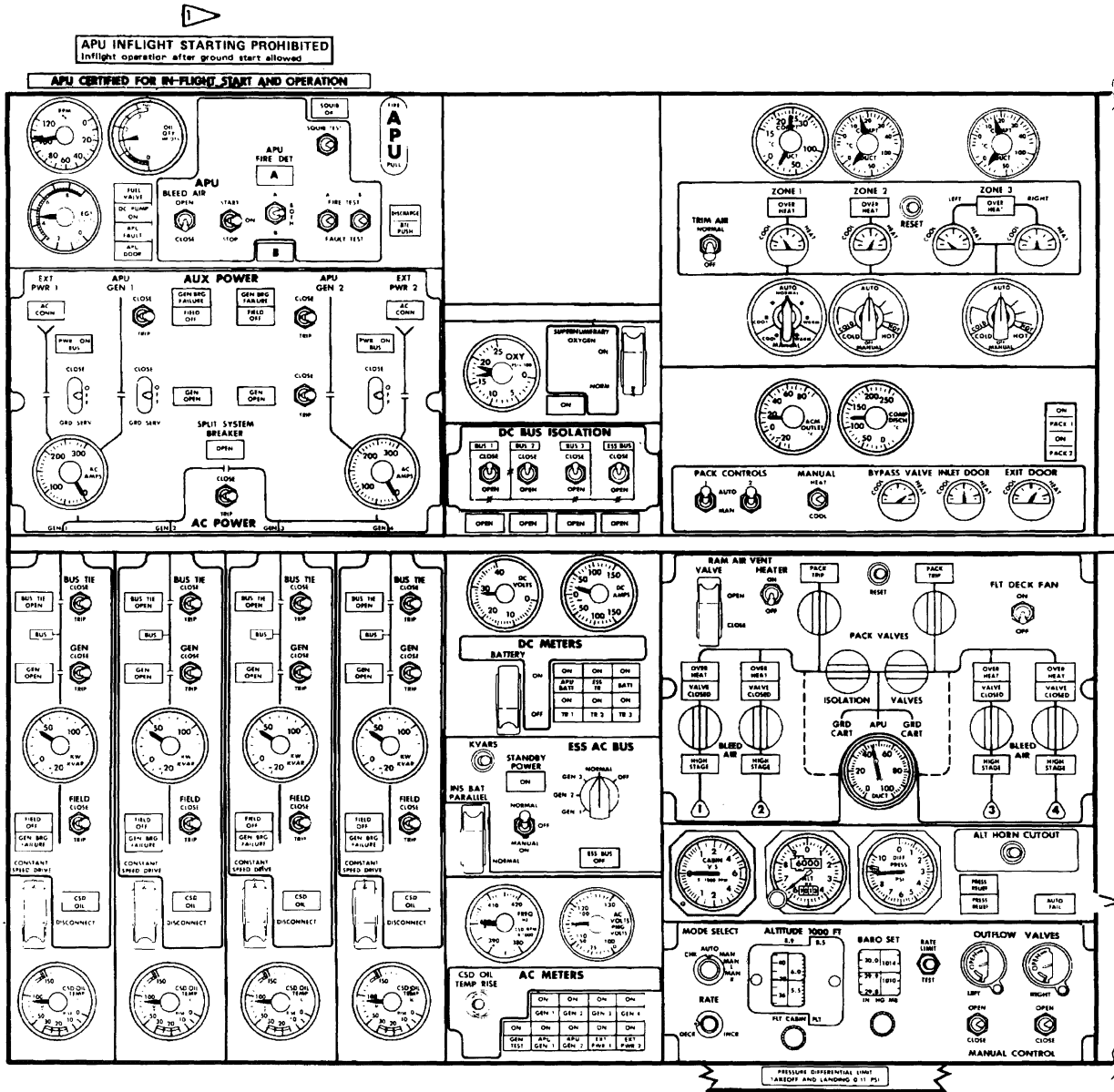

1 RATE LIMIT
2

▶ & ◀ As Installed

FLIGHT ENGINEER'S INSTRUMENT PANEL - UPPER PANELS - LEFT (DLH)

B94427

79L
Oct 01/86

05.20.11

| | | | |
|--------------------|-----------------------|---------------------|---------------------|
| WINDOW 1 (OVHT) | GRD SAP RELAY ON | L ENTRY DR 1 | |
| | EN UPPIA DECK DOOR | L ENTRY DR 3 | |
| ROLLOUT CONTROL | PEDAL STEERING | MIN ELEC SERV DR | CTR ELEC SERV DR |
| FWD CARGO DR | SIDE CARGO DR | AFT CARGO DR | BULK 1 CARGO DR |
| NORM DR | LRRA 1 TEST | LRRA 2 TEST | LRRA 3 TEST |
| GPM'S PROF | CRITICAL CA TRIP | | |
| 1/8 1 | 1/8 2 | 1/8 3 | 1/8 4 |
| VALVE OPEN | VALVE OPEN | VALVE OPEN | VALVE OPEN |
| NAC 1 | NAC 2 | NAC 3 | NAC 4 |
| TAI VALVE | TAI VALVE | TAI VALVE | TAI VALVE |

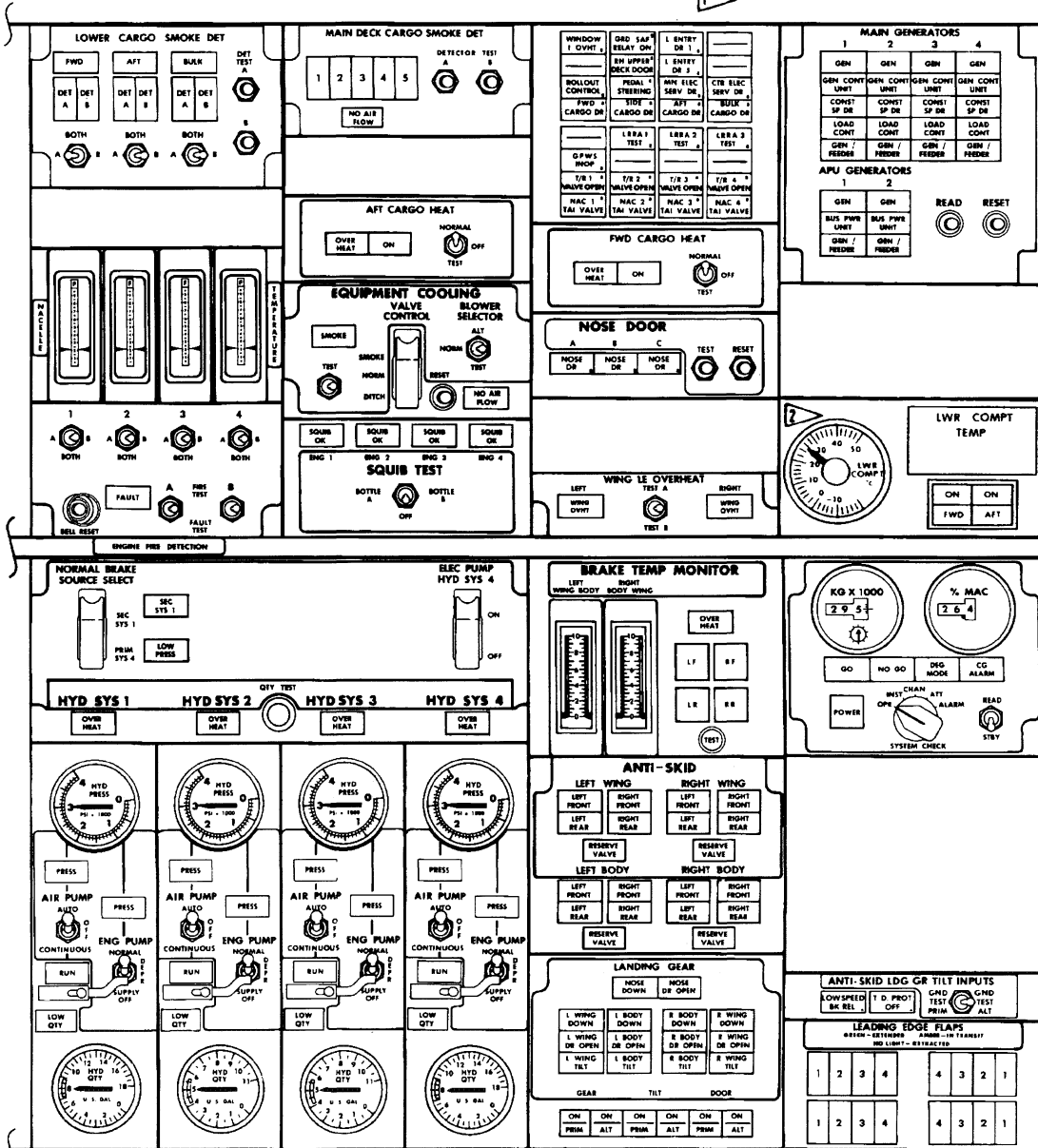

▶ & ▶ As installed

FLIGHT ENGINEERS' INSTRUMENT PANEL – UPPER PANELS – RIGHT
DLH

BOEING 747 OPERATIONS MANUAL

AIRPLANE GENERAL COCKPIT PANELS

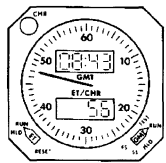
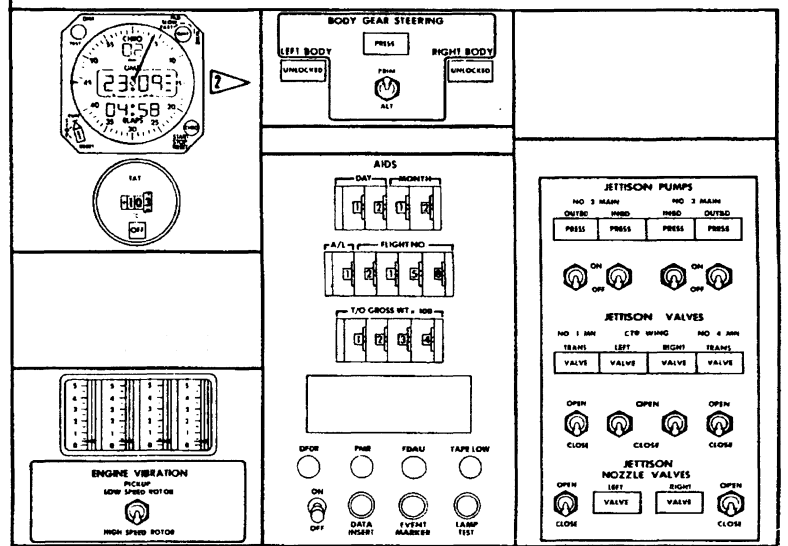
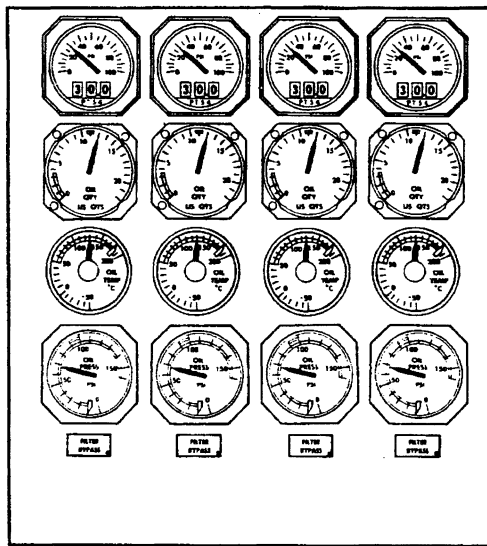
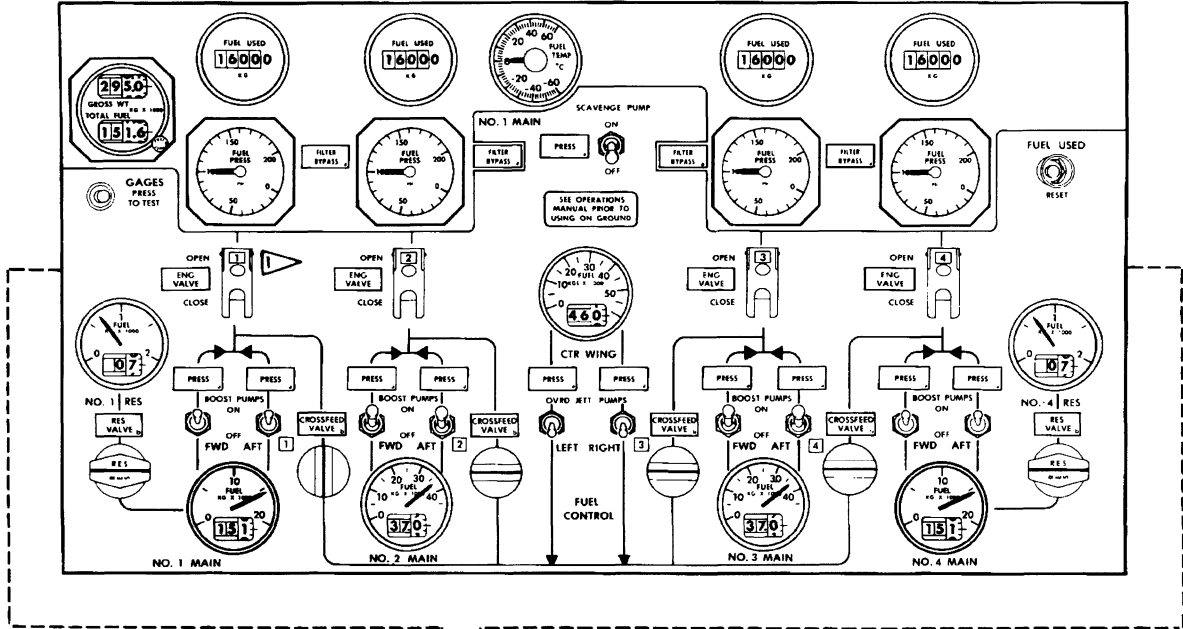

1 & 2 As installed

FLIGHT ENGINEERS' INSTRUMENT PANEL – LOWER PANELS DLH

79L
Oct 01/86

05.20.13

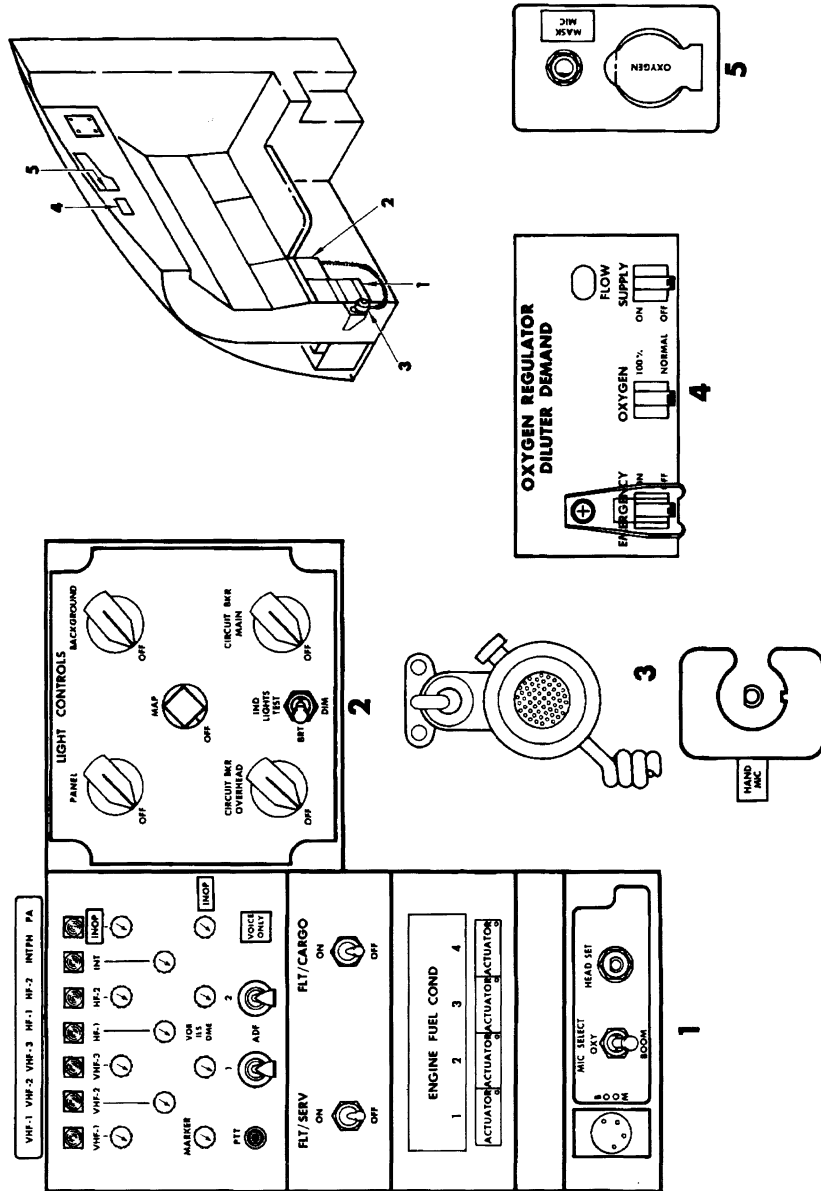

B94834

05.20.14

**FLIGHT ENGINEER'S AUXILIARY PANELS
LUFTHANSA, AS INSTALLED**

79J
Oct 01/85