



PREMIER
COPPER PRODUCTS

MODEL NUMBER: BSP5_BR16EN2-B

- * Description: 16" Round Hammered Copper Bar Sink with 2" Drain Opening
- * Outer Dimension: 16" x 7"
- * Inner Dimension: 14" x 7"
- * Rim: 1"
- * Drain Opening: 2"
- * Finish: Nickel

CODE/STANDARD COMPLIANCE

* IAPMO/cUPC LISTED

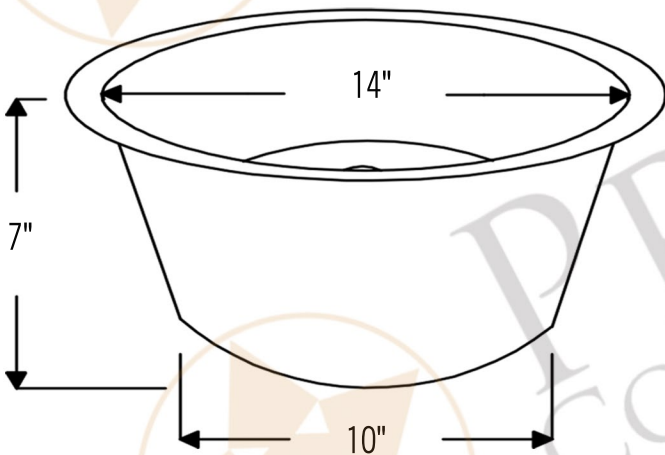
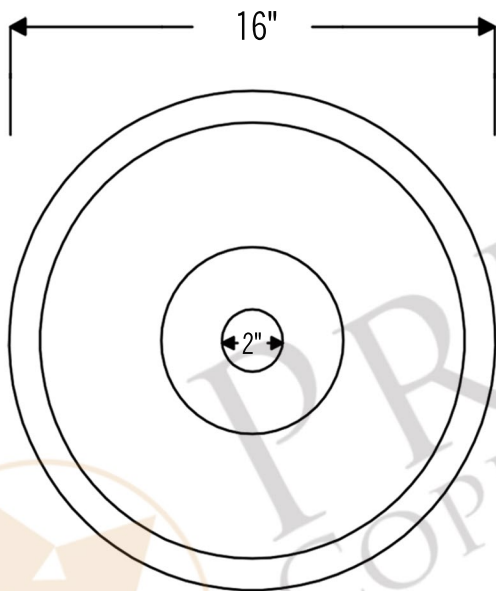

THIS PRODUCT IS HAND CRAFTED, SMALL VARIANCES IN COLOR AND SIZE MAY OCCUR.
DO NOT MAKE ANY INSTALLATION CUTS UNTIL YOU RECEIVE YOUR ITEM(S).

PACKAGE INCLUDES THE FOLLOWING ACCESSORIES:

- * 2" Basket Strainer Drain / BN Finish (Model# D-133BN)
- * Copper Sink Wax (Model# W900-WAX)

* BN: Brushed Nickel

DRAIN DETAILS (Model# D-133BN)

- * Description: 2" Bar Basket Sink Drain
- * Upper Flange Dimension: 2.75"
- * Material: Solid Brass
- * Prop 65 Compliant

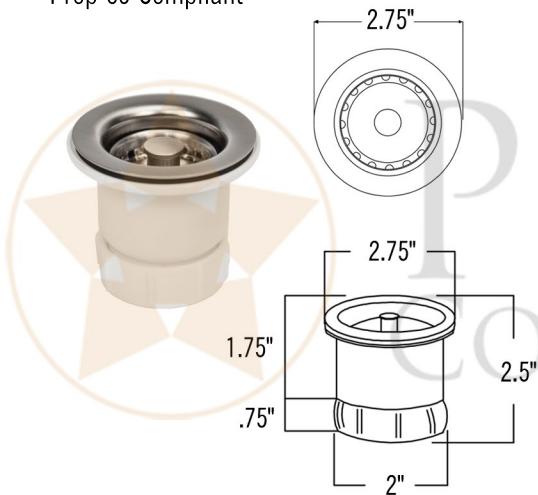

WAX DETAILS (Model# W900-WAX)

- * Description: Copper Sink Wax Protectant
- * Made From Natural Bee's Wax
- * No Wax Build Up Ever!
- * Hard Water Protection
- * Works Great on a Variety of Different Surfaces:

<i>Copper Sinks & Tubs</i>	<i>Kitchen Cabinets</i>
<i>Marble</i>	<i>Faucets</i>
<i>Granite</i>	<i>Wrought Iron</i>
<i>Countertops</i>	<i>Glass</i>
<i>Door Knobs</i>	<i>Aluminum</i>
<i>Shower Glass</i>	<i>Chrome</i>
<i>Mirrors</i>	<i>Appliances</i>
<i>Fine Furniture</i>	<i>Leather</i>

