

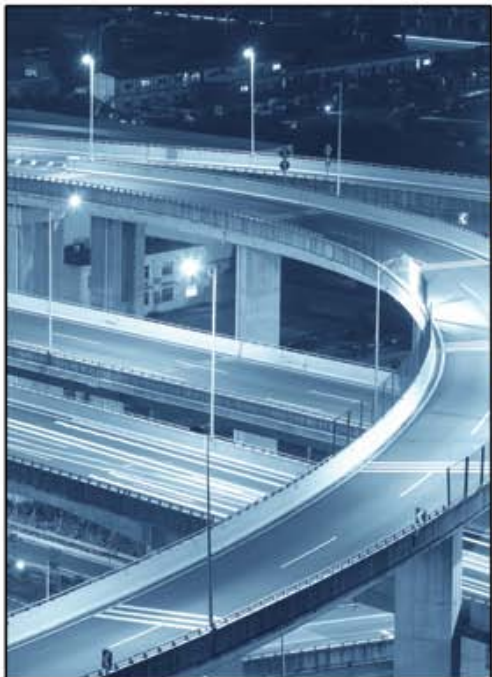

Innovative Vehicle Solutions
www.haldex.com

Suspension Controls Catalog

L00096W - 6/14



Important Notice

The products described within this literature, including without limitation, product features, specifications, designs, availability and pricing are subject to change by Haldex and its subsidiaries at any time without notice.

This document and other information from Haldex, its subsidiaries and authorized distributors provide product and/or system options for further investigation by users having technical expertise. It is important that you analyze all aspects of your application and review the information concerning the product or system, in the current literature or catalog. Due to the variety of operating conditions and applications for these products or systems, the user, through their own analysis and testing, is solely responsible for making the final selection of the products and systems and assuring that all performance, safety and warning requirements are met.

17 – Suspension Controls

Table of Contents	17-1
Part Number Index	17-3
General Information	
Foreword	17-6
General Information	17-7
Height Control Valve	
PR Plus Height Control Valve	17-8
PR Height Control Valve	17-11
IR Height Control Valves	17-12
IR w/2nd Ride Height HCV	17-13
CR Height Control Valve	17-14
Dump Valves for CR Height Control Valve	17-15
Linkages	
Adjustable	17-16
Fixed Loop	17-17
Fixed Rod	17-20
For EGP Valve	17-22
Repair Kits	17-23
Valves	
Lift Axle Valves	
ILAS® III	17-24
ILAS® E	17-25
Hand Control Valves	
Colas Hand Valve	17-26
Heavy Duty Hand Valve	17-27
Pressure Protection Valve	17-28
Pilot Valve	17-29
Manually Operated Valve	17-30
Pressure Regulator Valve	17-31
Check Valve	17-32
Electric Solenoid Valve	17-33
Proportioning Valve	17-34
Air Valve Accessories	
Pressure Gauges	17-35
Scale-O-Matics	17-36
AC Boxes	17-37
Mounting Brackets	17-38
Waterproof Enclosures	17-39

17–SUSPENSION CONTROLS

Table of Contents

Air Control Kits

AC-3800 Series Air Control Kits	17-40
AC-6100 Series Air Control Kits	17-41
AC-6000 Series Air Control Kits	17-42
AC-84-M/S-3 Series Air Control Kits	17-43
AC-84-M/S-1 Series Air Control Kits	17-44
AC-5500 Series Air Control Kits	17-45
AC-5600 Series Air Control Kits	17-46
AC-78-1 Series Air Control Kits	17-47
AC-77-1 Series Air Control Kits	17-48
AC-78-4 Series Air Control Kits	17-49
AC-78-5 Series Air Control Kits	17-50

Maintenance

Air Control Kit Application Guide	17-51
Notes	17-52
Notes	17-53
Notes	17-54

Part Number Index

17-SUSPENSION CONTROLS

Part Number	Type	Page #	Part Number	Type	Page #	Part Number	Type	Page #	Part Number	Type	Page #
90555300	O	17-8	90555398	O	17-28	RN21BA	S	17-24			
90555301	O	17-8	90555398	O	17-28						
90555301	O	17-8	90555400	O	17-28						
90555301	O	17-8	90555400	O	17-28						
90555301	O	17-8	90555401	O	17-28						
90555302	O	17-8	90555401	O	17-28						
90555302	O	17-8	90555406	O	17-28						
90555303	S	17-8	90555406	O	17-28						
90555304	O	17-8	90555407	O	17-28						
90555304	O	17-8	90555407	O	17-28						
90555305	O	17-8	90555408	O	17-28						
90555305	O	17-8	90555408	O	17-28						
90555306	O	17-8	90555409	O	17-28						
90555306	S	17-8	90555409	O	17-28						
90555306	O	17-8	90555409	S	17-28						
90555307	O	17-8	90555410	S	17-28						
90555307	O	17-8	90555410	O	17-28						
90555308	O	17-8	90555410	O	17-28						
90555308	O	17-8	90555411	S	17-28						
90555309	S	17-8	90555411	O	17-28						
90555318	O	17-8	90555411	O	17-28						
90555318	S	17-8	90555425	O	17-24						
90555318	O	17-8	90555425	O	17-24						
90555325	S	17-25	90555425	S	17-24						
90555325	O	17-25	90555426	S	17-24						
90555325	O	17-25	90555426	O	17-24						
90555326	S	17-25	90555426	O	17-24						
90555326	O	17-25	93800358	S	17-24						
90555326	O	17-25	93800358	O	17-24						
90555331	S	17-11	93800358	O	17-24						
90555331	O	17-11	950602008	S	17-23						
90555331	O	17-11	950602008	O	17-23						
90555332	S	17-11	950602008	O	17-23						
90555332	O	17-11	KN27000	S	17-12						
90555332	O	17-11	KN27010	S	17-12						
90555335	S	17-11	KN27013	S	17-12						
90555335	O	17-11	KN27201	S	17-12						
90555335	O	17-11	N15844BA	O	17-12						
90555336	S	17-8	N15844BA	O	17-12						
90555336	O	17-8	N15844BD	O	17-12						
90555336	O	17-8	N15844BD	O	17-12						
90555346	O	17-24	N15902B	O	17-28						
90555346	O	17-24	N15902B	O	17-28						
90555353	S	17-8	N20404AA	O	17-12						
90555353	O	17-8	N20404AA	O	17-12						
90555353	O	17-8	N20404AH	O	17-12						
90555355	O	17-8	N20404AH	O	17-12						
90555355	O	17-8	N20404AJ	O	17-12						
90555356	O	17-8	N20404AJ	O	17-12						
90555356	O	17-8	N20404AK	O	17-12						
90555357	O	17-8	N20404AK	O	17-12						
90555357	O	17-8	N20404BC	O	17-12						
90555360	O	17-8	N20404BC	O	17-12						
90555360	O	17-8	N20404BD	O	17-12						
90555365	S	17-11	N20404BD	O	17-12						
90555365	O	17-11	N20404BE	O	17-12						
90555365	O	17-11	N20404BE	O	17-12						
90555374	S	17-8	N20404BK	O	17-12						
90555374	O	17-8	N20404BK	O	17-12						
90555374	O	17-8	N20404BW	O	17-12						
90555375	S	17-8	N20404BW	O	17-12						
90555375	O	17-8	N20404BY	O	17-12						
90555375	O	17-8	N20404BY	O	17-12						
90555376	S	17-8	N20404CA	O	17-12						
90555376	O	17-8	N20404CA	O	17-12						
90555376	O	17-8	N20404CG	O	17-12						
90555377	S	17-8	N20404CG	O	17-12						
90555377	O	17-8	N20404E	O	17-12						
90555377	O	17-8	N20404E	O	17-12						
90555382	S	17-8	N20404FA	O	17-12						
90555382	O	17-8	N20404FA	O	17-12						
90555382	O	17-8	N20404T	O	17-12						
90555389	O	17-8	N20404T	O	17-12						
90555389	O	17-8	N20976	O	17-29						
90555396	S	17-28	N20976	O	17-29						
90555396	O	17-28	N20976A	O	17-29						
90555396	O	17-28	N20976A	O	17-29						
90555397	S	17-28	RN10JC	S	17-23						
90555397	O	17-28	RN10JE	S	17-23						
90555397	O	17-28	RN10JH	S	17-22						
90555398	S	17-28	RN10JJ	S	17-22						

Type "O" = OEM P/N, Type "S" = Service P/N

If OEM part # is not found on page listed, refer to the MCR for applicable cross reference.

PURPOSE OF THIS SECTION

This section is designed as a reference for Haldex new and remanufactured air brake system components and accessories, sold under the Haldex and Midland product names. Products described include all pertinent information needed to replace an OEM installed component or to help design an original installation. If there is a service number for a given part, it is noted in the product number table.

DESIGN FLEXIBILITY

The products presented in this section are described by function and usage. Technical data and mounting configurations are also provided. Throughout this section, reference is made to numerous specific OEM applications. This section is not, however, intended to be a mutually exclusive listing of all part numbers and designs available. Should the need for a design not presented occur, contact your Haldex sales representative for additional information.

WARRANTY INFORMATION

Proper service and repair are important to the safe, reliable operation of any motor vehicle. To prevent personal injury and/or vehicle damage, careful and cautious service procedures recommended by the vehicle manufacturer should be followed by anyone servicing a motor vehicle. For details on warranty of Haldex air brake system components and accessories, refer to L20221 Aftermarket Warranty Policy. For warranty returns, use L90005 Warranty Adjustment Form. To obtain further information, visit the www.haldex.com website, select **North America/English** in drop down box then search for **Warranty**.

ORDERING PROCEDURE

Most customers can place electronic orders on the www.haldex.com website by obtaining a username and password or by using EDI. For additional information about electronic orders or to place an order by phone or fax, contact Customer Service in U.S. or Canada at numbers listed below:

U.S. Customer Service:

Phone: 800-643-2374
 Fax: 800-533-1941
 Mail: Haldex Brake Products Corporation
 Attn: Customer Service Department
 10930 N. Pomona Ave.
 Kansas City, MO 64153

Canada Customer Service:

Phone: 800-267-9247
 Fax: 519-621-3924
 Mail: Haldex Limited
 Canadian Distribution Centre
 Attn: Customer Service Department
 500 Pinebush Road, Unit 1
 Cambridge, Ontario N1T 0A5

IMPORTANT NOTICE

The data listed herein is correct to the best of Haldex's knowledge and belief, having been compiled from reliable and official sources of information. However, HALDEX CANNOT ASSUME ANY RESPONSIBILITY for possible error or misapplication of the product. Final determination of the suitability of the products for the use contemplated by the Buyer is the sole responsibility of the Buyer. Haldex shall have no responsibility in connection with this suitability. It is not our intention to imply that any of the components in this catalog in connection with an engine make or model are made by any engine manufacturer.

Copyright 2014
 Haldex Brake Products Corporation
 10930 N. Pomona Ave.
 Kansas City, MO 64153

All rights reserved.
 Materials may only be reproduced with written permission of Haldex.

**USE ONLY GENUINE HALDEX
TYPE CR HEIGHT CONTROL VALVES –
ACCEPT NO COUNTERFEIT!**

- ▶ FIVE times longer life than counterfeit valves.*
- ▶ Time Delay is precise – not inconsistent like counterfeit valves.
- ▶ Quality Assured – unlike counterfeits, which are not individually calibrated and tested.
- ▶ Minimum deadband to maintain proper ride height – counterfeit deadband is THREE times wider which decreases trailer life.*
- ▶ Full One Year Warranty (unlike counterfeit valves which have none).

BEWARE OF COUNTERFEITS.

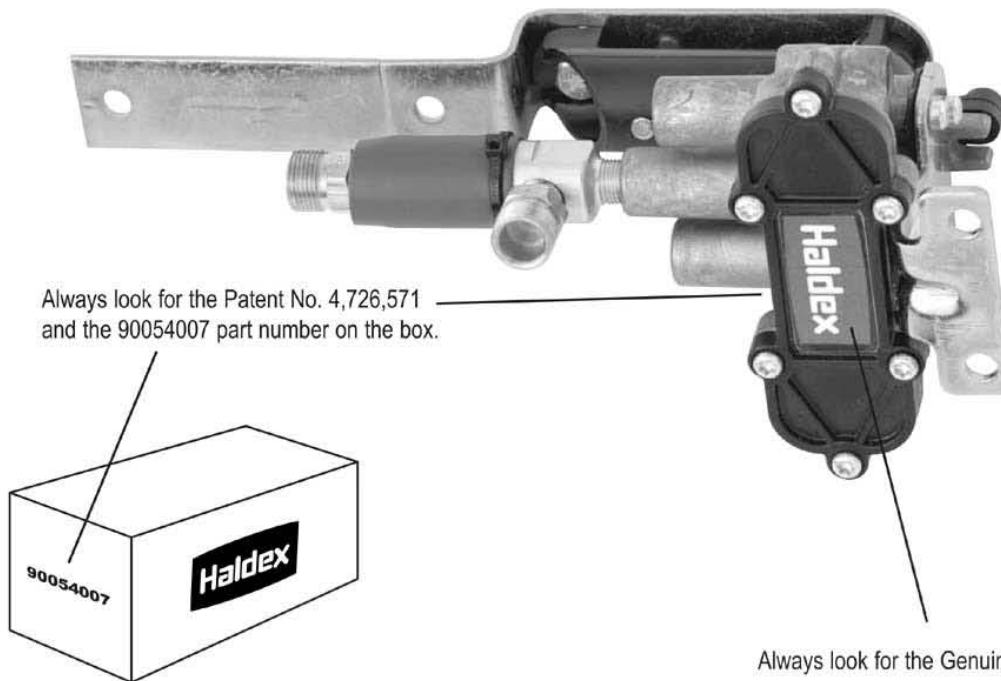

* Test results available on request.

PR Plus Height Control Valve



Use of ceramic seal technology allows the PR Plus Valve to be very reliable and highly durable in the most extreme conditions.

SKU#	Product Description	Arm	Ports
90554945	PR Plus Height Control Valve	7" Adjustable	1/4" NPT
90554950	PR Plus HCV with Normally Open Dump Valve	7" Adjustable	Pilot Port 1/4" PTC All Other Ports 1/4" NPT
90555085	PR Plus Height Control Valve (Metric)	7" Adjustable	M12 x 1.5
90555086	PR Plus HCV with (Metric) Normally Open Dump Valve	7" Adjustable	Pilot Port 6mm PTC All Other Ports M12 x 1.5
90555099	PR Plus HCV with Normally Closed Dump Valve	5.5" Adjustable	Pilot Port 1/4" PTC All Other Ports 1/4" NPT
90555100	PR Plus HCV with Normally Closed-Low Flow Dump Valve, SAF Holland Suspension Replacement	5.5" Adjustable	3-Port Same Side Manifold Pilot Port 1/4" PTC All Other Ports 3/8" PTC
90555101	PR Plus HCV, SAF Holland Suspension Replacement	5.5" Adjustable	3-Port Same Side Manifold All Ports 3/8" PTC
90555108	PR Plus HCV with Normally Closed Dump Valve	7" Adjustable	

Height Control Valve

17-SUSPENSION CONTROLS

			Pilot Port 1/4" PTC All Other Ports 1/4" NPT
90555116	PR Plus HCV with Normally Closed Dump Valve, SAF Holland Suspension Replacement	5.5" Adjustable	3-Port Same Side Manifold Pilot Port 1/4" PTC All Other Ports 3/8" PTC
90555263	PR Plus HCV with Normally Open Dump Valve, Volvo Replacement 90555356	7" Fixed	3-Port Side Manifold Pilot Port 1/4" PTC All Other Ports 3/8" PTC
90555273	PR Plus Height Control Valve	7" Adjustable	3/8" PTC
90555274	PR Plus HCV with Normally Open Dump Valve	7" Adjustable	Pilot Port 1/4" PTC All Other Ports 3/8" PTC
90555300	PR Plus HCV, SAF Holland Suspension Replacement	9" Adjustable	3-Port Same Side Manifold All Ports 3/8" PTC
90555303	PR Plus HCV with Normally Closed Dump Valve	9.5" Adjustable	3-Port Same Side Manifold All Ports 3/8" PTC
90555306	PR Plus HCV, SAF Holland Suspension Replacement	7" Adjustable	3-Port Same Side Manifold All Ports 3/8" PTC
90555309	PR Plus HCV with Normally Closed Dump Valve	7" Fixed	3-Port Same Side Manifold All Ports 3/8" PTC
90555318	PR Plus HCV with Normally Open Dump Valve, Volvo Replacement 90555357 and 90555289	7" Fixed	3-Port Same Side Manifold Pilot Port 1/4" PTC All Other Ports 3/8" PTC
90555336	PR Plus HCV, Hendrickson Suspension Replacement	7" Adjustable	1/4" NPT
90555353	PR Plus HCV with Normally Open Dump Valve, Volvo Replacement 90555355	7" Fixed	5-Port Side Manifold Pilot Port 1/4" PTC All Other Ports 3/8" PTC
90555374	PR Plus HCV with Normally Open Dump Valve, Freightliner Replacement	7" Adjustable	2-Port Side Manifold Pilot Port 1/4" PTC All Other Ports 1/4" NPT
90555375	PR Plus HCV with Normally Open Dump Valve, Kenworth Replacement 90555141	7" Adjustable	3-Port Side Manifold Pilot Port 1/4" PTC All Other Ports 3/8" PTC
90555376	PR Plus HCV with Normally Open Dump Valve, Kenworth Replacement 90555143	7" Adjustable	

17-SUSPENSION CONTROLS

Height Control Valve

			2-Port Straight Manifold Pilot Port 1/4" PTC All Other Ports 3/8" PTC
90555377	PR Plus HCV with Normally Open Dump Valve, Kenworth Replacement 90555145	7" Adjustable	3-Port Straight Manifold Pilot Port 1/4" PTC All Other Ports 3/8" PTC
90555382	PR Plus HCV with Normally Open Dump Valve, Peterbilt Replacement	7" Adjustable	3-Port Straight Manifold Pilot Port 1/4" PTC All Other Ports 1/4" NPT

PR Height Control Valve



Features:

- Economical design for Cab/Trailer Applications

Notes:

- 1) Use of ceramic seal technology allows the PR Plus Valve to be very reliable and highly durable in the most extreme conditions.

SKU#	Product Description	Arm	Ports
90555331	PR Height Control Valve – Cab/Front Air Ride	5" Adjustable	Integrated 2-Port All Ports 1/4" PTC
90555332	PR Height Control Valve – Cab/Front Air Ride	5" Adjustable	Integrated 2-Port All Ports 1/4" NPT
90555335	PR Height Control Valve – Truck/Trailer Air Ride	7" Fixed	Integrated 2-Port All Ports 1/4" NPT
90555365	PR Height Control Valve – Truck/Trailer Air Ride	7" Adjustable	Integrated 2-Port All Ports 3/8" PTC

IR Height Control Valves



Features:

- A non-time delay valve used under a wide variety of climatic and payload conditions.
- Heavy duty Height Control Valve inflates or exhausts air springs to maintain suspension ride height.

Specifications:

All Ports 1/4" NPT

SKU#	Product Description	Horizontal Arm Length	Vertical Arm Length	Axle Bracket Linkage	Notes	Core Group
9055105	Type EGP – An Immediate Response Height Control Valve	-	-	-	Without Dump	-
9055106	Type EGP – An Immediate Response Height Control Valve with Dump Valve	-	-	-	With Dump	-
KN27000	EGP Standard Flow Leveling Valve Kit	12" (Max)	14"	Vertical	Adjust and cut arms to desired length for application.	-
KN27010	EGP High Flow Leveling Valve Kit	8.2" (Max)	-	-	No vertical link arm, special Navistar. Adjust and cut arms to desired length for application.	-
KN27013	EGP High Flow Leveling Valve Kit	12" (Max)	14"	Vertical	Adjust and cut arms to desired length for application.	-
KN27201	EGP Low Flow Leveling Valve	-	-	-	Valve Only	-

IR w/2nd Ride Height HCV

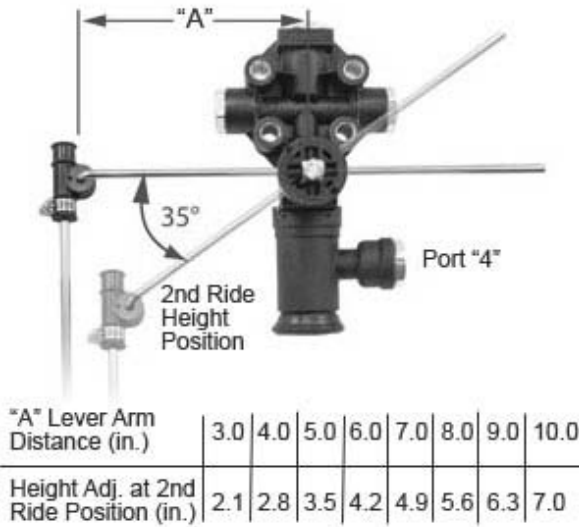

Features:

- Provides a second ride height that is pre-set and is not variable to the weight of the vehicle
- Minimum number of components to provide the second alternative height
- Air pressure is never completely exhausted from the air bellows, saving wear on the suspension components
- On buses, this operation can be tied to the door opening operation, so no additional motion is required by the operator

Notes:

- 1) This valve provides the ability of raising or lowering the vehicle to a controlled second height position.
- 2) When air pressure is applied to port "4" of the valve, the valve goes to a set second ride position. The lever will appear at 35° in the 2nd ride position in neutral.
- 3) Setting of the 2nd ride position is accomplished by the lever arm length according to the table provided.

SKU#	Product Description	All Ports	Horizontal Arm Length	Vertical Arm Length
42150003	Type EGP - An Immediate Response Height Control Valve with 2nd Ride Height	1/4" NPT	12"	20"

CR Height Control Valve

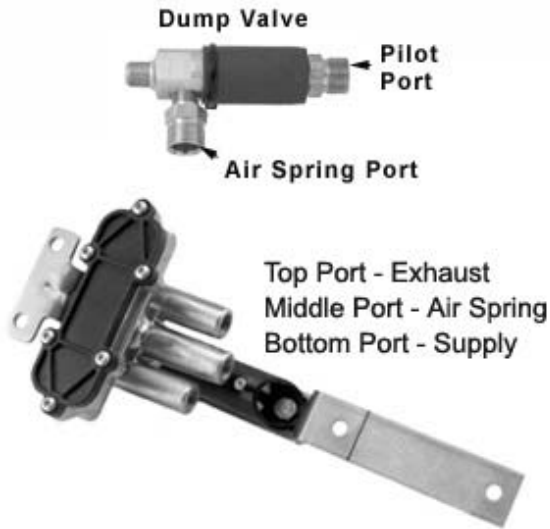

Features:

- Automatically adds air to, or exhausts air from the air suspension to maintain constant static design height.
- Does not respond to short duration dynamic changes in axle position, thus reducing air consumption life and saves fuel.

Specifications:

- All Ports** 1/8" NPT
90554335 Normally Open Dump Valve, Gold Body
90554902 Normally Closed Dump Valve, Silver Body

Notes:

- 1) Dump control can be operated from the cab or plumbed to function when the emergency brake is set.

SKU#	Product Description	Dump Valve Included	Fittings Provided	Notes
90054007	Type CR – Controlled Response Height Control Valve	No	1/4"	Individually Packaged
90554114	Type CR – Controlled Response Height Control Valve	No	No Fittings	Individually Packaged
90554147	Type CR – Controlled Response Height Control Valve	No	Metric Adapter (1/8" NPT to M10 x 1)	Individually Packaged
90554183	Type CR – Controlled Response Height Control Valve	No	3/8"	Individually Packaged
90554334	Type CR – Controlled Response Height Control Valve with Dump Valve	Yes	1/4" & 3/8"	Dump normally open; needs air pressure to dump.
90554648	Type CR – Controlled Response Height Control Valve with Dump Valve	Yes	1/4" & 3/8"	Dump normally closed; dumps if air pressure is removed.

Dump Valves for CR Height Control Valve



Features:

- Normally open and normally closed dump valves install easily to the Controlled Response Height Control Valve.

Specifications:

- Normally Open** Gold Body
Normally Closed Silver Body

SKU#	Product Description	All Ports	Fittings Provided	Dump Feature	Application
90554335	Height Control Valve Dump Valve	1/8" NPT	1/4" & 3/8"	Normally open; needs air pressure to dump.	Type CR Height Control Valve
90554902	Height Control Valve Dump Valve	1/8" NPT	1/4" & 3/8"	Normally closed; dumps if air pressure removed.	Type CR Height Control Valve

Linkages

Adjustable

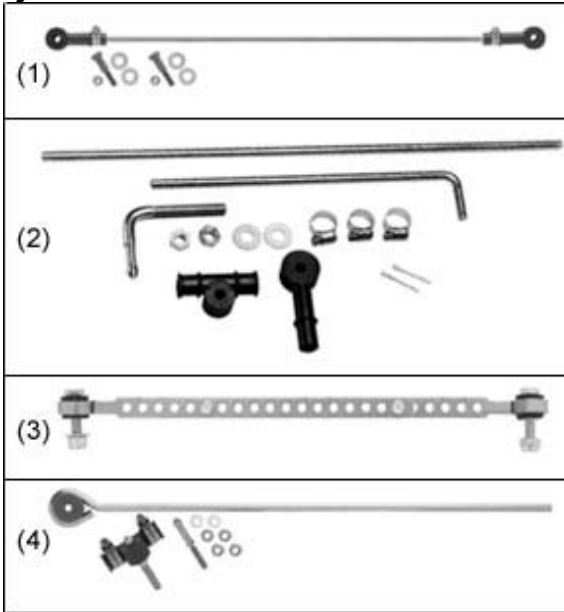

SKU#	Product Description	Model	Length	Notes	Pic. #
48100225	Adjustable Linkage	SRK 168	19-5/8" Maximum	A common trailer suspension linkage used by several OE manufacturers. Linkage can be cut to obtain desired linkage length. Simple to assemble and install.	1
48100267	Adjustable Linkage	SRK 205	13-1/2" Maximum	Use with Type IR Height Control Valve applications and for service and repair of linkages on many older model trucks. Kit provides the components needed to replace the entire linkage.	2
48100367	Adjustable Strap Linkage	SRK 503	14" Maximum	A common trailer suspension linkage used by several OE manufacturers. Linkage can be welded at desired length to avoid field adjustment issues. Simple to assemble and install.	3
48100374	Adjustable Looped Linkage	SRK 510	16" Maximum	Common truck/trailer suspension used by several OE manufacturers. Adjustable link end allows for easy installation. Fixed looped end provides durability.	4
48100375	Adjustable Looped Linkage	SRK 511	22" Maximum	Common truck/trailer suspension used by several OE manufacturers. Adjustable link end allows for easy installation. Fixed looped end provides durability.	4

Linkages

Fixed Loop

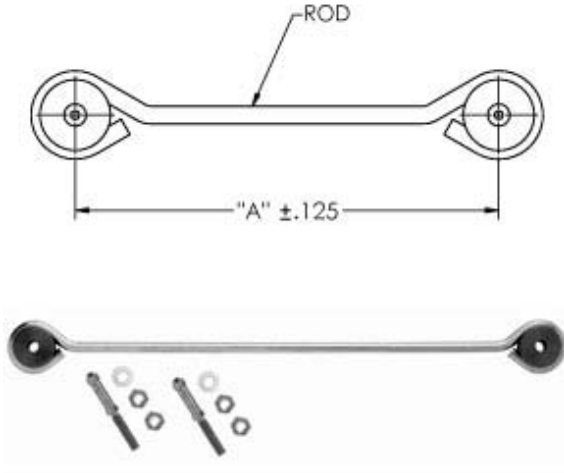

Features:

- Common truck/tractor suspension linkage used by several OE manufacturers
- Robust, easy to install and reduce suspension height modifications
- Uses easily detachable push-over pins
- Must be ordered at correct length, available in 0.25" increments from 4.0" to 25"

Notes:

- 1) Package bag contains rubber grommet assembled into linkage and all remaining components unassembled.

SKU#	Product Description	"A" Dimension
90554729	Fixed Loop Linkage	4.50"/114mm
90554730	Fixed Loop Linkage	4.75"/121mm
90554731	Fixed Loop Linkage	5.00"/127mm
90554732	Fixed Loop Linkage	5.25"/133mm
90554733	Fixed Loop Linkage	5.50"/140mm
90554734	Fixed Loop Linkage	5.75"/146mm
90554735	Fixed Loop Linkage	6.00"/152mm
90554736	Fixed Loop Linkage	6.25"/158mm
90554737	Fixed Loop Linkage	6.50"/165mm
90554738	Fixed Loop Linkage	6.75"/171mm
90554739	Fixed Loop Linkage	7.00"/178mm
90554740	Fixed Loop Linkage	7.25"/184mm
90554741	Fixed Loop Linkage	7.50"/191mm
90554742	Fixed Loop Linkage	7.75"/197mm
90554743	Fixed Loop Linkage	8.00"/203mm
90554744	Fixed Loop Linkage	8.25"/210mm
90554745	Fixed Loop Linkage	8.50"/216mm
90554746	Fixed Loop Linkage	8.75"/222mm
90554747	Fixed Loop Linkage	9.00"/229mm
90554748	Fixed Loop Linkage	9.25"/235mm
90554749	Fixed Loop Linkage	9.50"/241mm
90554750	Fixed Loop Linkage	9.75"/248mm
90554751	Fixed Loop Linkage	10.00"/254mm
90554752	Fixed Loop Linkage	10.25"/260mm

17-SUSPENSION CONTROLS

Height Control Valve

90554753	Fixed Loop Linkage	10.50"/267mm
90554754	Fixed Loop Linkage	10.75"/273mm
90554755	Fixed Loop Linkage	11.00"/279mm
90554756	Fixed Loop Linkage	11.25"/286mm
90554757	Fixed Loop Linkage	11.50"/292mm
90554758	Fixed Loop Linkage	11.75"/298mm
90554759	Fixed Loop Linkage	12.00"/305mm
90554760	Fixed Loop Linkage	12.25"/311mm
90554761	Fixed Loop Linkage	12.50"/318mm
90554762	Fixed Loop Linkage	12.75"/324mm
90554763	Fixed Loop Linkage	13.00"/330mm
90554764	Fixed Loop Linkage	13.25"/337mm
90554765	Fixed Loop Linkage	13.50"/343mm
90554766	Fixed Loop Linkage	13.75"/349mm
90554767	Fixed Loop Linkage	14.00"/356mm
90554768	Fixed Loop Linkage	14.25"/362mm
90554769	Fixed Loop Linkage	14.50"/368mm
90554770	Fixed Loop Linkage	14.75"/375mm
90554771	Fixed Loop Linkage	15.00"/381mm
90554772	Fixed Loop Linkage	15.25"/387mm
90554773	Fixed Loop Linkage	15.50"/394mm
90554774	Fixed Loop Linkage	15.75"/400mm
90554775	Fixed Loop Linkage	16.00"/406mm
90554776	Fixed Loop Linkage	16.25"/413mm
90554777	Fixed Loop Linkage	16.50"/419mm
90554778	Fixed Loop Linkage	16.75"/425mm
90554779	Fixed Loop Linkage	17.00"/432mm
90554780	Fixed Loop Linkage	17.25"/438mm
90554781	Fixed Loop Linkage	17.50"/445mm
90554782	Fixed Loop Linkage	17.75"/451mm
90554783	Fixed Loop Linkage	18.00"/457mm
90554784	Fixed Loop Linkage	18.25"/464mm
90554785	Fixed Loop Linkage	18.50"/470mm
90554786	Fixed Loop Linkage	18.75"/476mm
90554787	Fixed Loop Linkage	19.00"/483mm
90554788	Fixed Loop Linkage	19.25"/489mm
90554789	Fixed Loop Linkage	19.50"/495mm
90554790	Fixed Loop Linkage	19.75"/502mm
90554791	Fixed Loop Linkage	20.00"/508mm
90554792	Fixed Loop Linkage	20.25"/514mm
90554793	Fixed Loop Linkage	20.50"/521mm
90554794	Fixed Loop Linkage	20.75"/527mm
90554795	Fixed Loop Linkage	21.00"/533mm
90554796	Fixed Loop Linkage	21.25"/540mm

Height Control Valve

17-SUSPENSION CONTROLS

90554797	Fixed Loop Linkage	21.50"/546mm
90554798	Fixed Loop Linkage	21.75"/552mm
90554799	Fixed Loop Linkage	22.00"/559mm
90554800	Fixed Loop Linkage	22.25"/565mm
90554801	Fixed Loop Linkage	22.50"/572mm
90554802	Fixed Loop Linkage	22.75"/578mm
90554803	Fixed Loop Linkage	23.00"/584mm
90554804	Fixed Loop Linkage	23.25"/591mm
90554805	Fixed Loop Linkage	23.50"/597mm
90554806	Fixed Loop Linkage	23.75"/603mm
90554807	Fixed Loop Linkage	24.00"/610mm
90554808	Fixed Loop Linkage	24.25"/616mm
90554809	Fixed Loop Linkage	24.50"/622mm
90554810	Fixed Loop Linkage	24.75"/629mm
90554811	Fixed Loop Linkage	25.00"/635mm
90554991	Fixed Loop Linkage	4.00"/102mm

Linkages

Fixed Rod

Features:

- Common fixed length linkage used by several truck and trailer OE manufacturers
- Robust, easy to install and reduce suspension height modifications
- Use shoulder bolts and lock nuts to insure tamper resistant stout connections
- Must be ordered at correct length, available in 0.25" increments from 4.5" to 25"

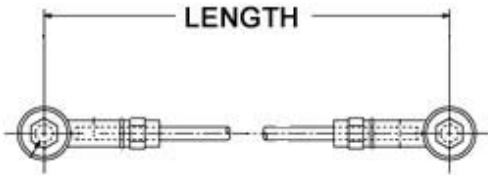

SKU#	Product Description	Length
90554123	Fixed Rod Linkage	4.50"/114mm
90554124	Fixed Rod Linkage	5.00"/127mm
90554125	Fixed Rod Linkage	5.20"/132mm
90554126	Fixed Rod Linkage	5.60"/147mm
90554127	Fixed Rod Linkage	6.00"/152mm
90554128	Fixed Rod Linkage	6.50"/165mm
90554129	Fixed Rod Linkage	8.00"/203mm
90554130	Fixed Rod Linkage	8.80"/224mm
90554131	Fixed Rod Linkage	9.00"/229mm
90554132	Fixed Rod Linkage	9.50"/241mm
90554133	Fixed Rod Linkage	9.80"/249mm
90554134	Fixed Rod Linkage	10.00"/254mm
90554135	Fixed Rod Linkage	10.40"/264mm
90554136	Fixed Rod Linkage	10.80"/274mm
90554137	Fixed Rod Linkage	11.00"/279mm
90554138	Fixed Rod Linkage	11.20"/284mm
90554139	Fixed Rod Linkage	11.50"/292mm
90554140	Fixed Rod Linkage	12.00"/305mm
90554141	Fixed Rod Linkage	12.20"/310mm
90554142	Fixed Rod Linkage	13.00"/330mm
90554143	Fixed Rod Linkage	14.50"/368mm
90554144	Fixed Rod Linkage	15.00"/381mm
90554145	Fixed Rod Linkage	16.80"/427mm
90554150	Fixed Rod Linkage	18.25"/464mm

Height Control Valve

17-SUSPENSION CONTROLS

90554176	Fixed Rod Linkage	11.80"/300mm
90554177	Fixed Rod Linkage	16.25"/413mm
90554180	Fixed Rod Linkage	7.00"/178mm
90554181	Fixed Rod Linkage	17.62"/448mm
90554182	Fixed Rod Linkage	18.50"/470mm
90554184	Fixed Rod Linkage	4.70"/119mm
90554195	Fixed Rod Linkage	18.00"/457.2mm
90554198	Fixed Rod Linkage	16.50"/419.1mm
90554205	Fixed Rod Linkage	14.00"/355.6mm
90554206	Fixed Rod Linkage	17.00"/431.8mm
90554211	Fixed Rod Linkage	7.25"/184mm
90554219	Fixed Rod Linkage	5.75"/146mm
90554220	Fixed Rod Linkage	6.62"/168.1mm
90554221	Fixed Rod Linkage	8.50"/216mm
90554222	Fixed Rod Linkage	24.60"/625mm
90554231	Fixed Rod Linkage	15.80"/401mm
90554242	Fixed Rod Linkage	15.25"/387.4mm
90554246	Fixed Rod Linkage	9.25"/235mm
90554270	Fixed Rod Linkage	16.00"/406mm
90554278	Fixed Rod Linkage	18.38"/466.9mm
90554441	Fixed Rod Linkage	19.41"/493mm
90554618	Fixed Rod Linkage	10.50"/266.7mm
90554627	Fixed Rod Linkage	8.90"/226mm
90554629	Fixed Rod Linkage	10.25"/260.4mm

Linkages

For EGP Valve



SKU#	Product Description
RN10JH	Horizontal Linkage Kit for EGP Height Control Valve
RN10JJ	Vertical Linkage Kit for EGP Height Control Valve

Repair Kits



RN10JC



950602008

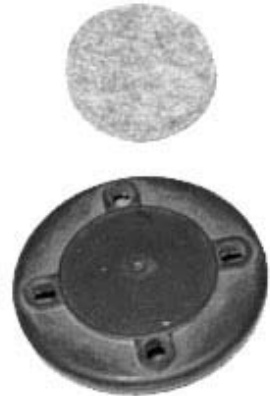

RN10JE

SKU#	Product Description
950602008	Seal Kit for Load Sensing Valve
RN10JC	Linkage Repair Kit
RN10JE	Exhaust Cover Kit

Lift Axle Valves

ILAS® III



Features:

- Integrated lift axle system; Responds to pressure in air suspension and automatically lowers the lift axle when loaded. Error proof valve lowers lift axle when unit is loaded.
- Manual or automatic raise option available
- One component reduces assembly time and complicated plumbing
- Solid structure allows for easy and external mounting

Notes:

- 1) 90555425 lift axle is manually raised by pushing button in.
- 2) 90555426 automatically lifts axle when load is removed.
- 3) PTC fittings should not be used in Canada due to extreme cold.

SKU#	Product Description	Adjusting Pressure	Notes
62101008	Adjustment Kit for ILAS® III – Fully Automatic Lift Axle Control Valve	-	-
62101009	Manual Over Ride Kit for ILAS® III – Fully Automatic Lift Axle Control Valve	-	Kit contains: Automatic ILAS® III Valve and Over Ride Parts
90555425	ILAS® III – Manual Lift Axle Control Valve (Automatic Lower)	43.50 psi – 76.85 psi (3.0–5.3 bar)	1/4" – 18 NPT Threaded Ports
90555426	ILAS® III – Fully Automatic Lift Axle Control Valve	43.50 psi – 76.85 psi (3.0–5.3 bar)	1/4" – 18 NPT Threaded Ports
93800358	Adapter Fitting for ILAS® III – Fully Automatic Lift Axle Control Valve	-	-
RN21BA	Fitting Kit for ILAS® III Valve	-	Kit contains: (5) 1/4" – 18 NPT, 3/8" Tube Push-To-Connect (PTC) Fittings

Lift Axle Valves

ILAS® E



Features:

- Works in conjunction with TRS system for Trailers; Programmable settings for operation of the valve.
- Integrated Lift Axle System; Responds to air pressure changes in the suspension system to lift or drop 1 or 2 axles on the trailer as load changes. With loss of electrical power, the axle(s) will drop automatically.
- One Component reduces installation time.
- Solid construction allows for easy, external mounting.
- PTC Fittings for easy tube connections.

SKU#	Product Description	Notes
62101005	ILAS® E Lift Axle Valve Kit	3/8" PTC Fittings
62101006	ILAS® E Lift Axle Valve Kit	1/4" PTC Fittings
90555325	ILAS® E Lift Axle Valve	1/4" PTC Fittings
90555326	ILAS® E Lift Axle Valve	3/8" PTC Fittings

Hand Control Valves

Colas Hand Valve



Features:

- Manual raise/lowering hand valve for commercial vehicles and trailers
Works with Single or Dual Height Control Valve systems
- Solid Structure
Allows for horizontal or vertical installation
Also allows for external mounting
- Manual or Automatic return to ride height
Automatic return to ride height option makes valve error proof
- Eliminates the need for extra valves and components
One component and fewer fittings compared to four components and nine fittings of past kits like the AC-78 MS

SKU#	Product Description	Ports
90555270	Colas Hand Valve - Manually or Automatically Operated	3/8" PTC
90555292	Colas Hand Valve - Manually or Automatically Operated	1/4" PTC

Hand Control Valves

Heavy Duty Hand Valve



Features:

- Heavy duty, durable valve with a lever handle for manually reducing incoming pressure (50-120 PSIG) to desired output pressure.
- Locking feature for the handle adjustments allows operator to set desired output pressure.
- Used in auxiliary axle applications and raising/lowering of vehicle.

Specifications:

- 90054083 Replacement Handle
- 90054123 Replacement Bracket

SKU#	Product Description	All Ports
90054082	Hand Control Valve	1/4" NPT

Pressure Protection Valve



Features:

- Protects the air brake system in the event of a leak or failure within the air suspension system.
- Premium Valve has a serviceable replacement filter that minimizes contaminants and other debris from entering other air system accessories.

Specifications:

48100200 Replacement Filter Kit for Premium Valve

SKU#	Product Description	All Ports	Closing Pressure	Opening Pressure
90554107	Pressure Protection Valve – Premium	1/4" NPT	70 PSIG	75 PSIG minimum
90554151	Pressure Protection Valve – Premium	M12 x 1.5	5.2 BAR minimum	6.1 BAR minimum
90555396	Pressure Protection Valve	1/4" NPT	65 PSI	70 PSI
90555397	Pressure Protection Valve	1/4" NPT	80 PSI	85 PSI
90555398	Pressure Protection Valve	1/4" NPT	90 PSI	95 PSI
90555409	Pressure Protection Valve with One-Way Check	1/4" NPT	65 PSI	70 PSI
90555410	Pressure Protection Valve with One-Way Check	1/4" NPT	80 PSI	85 PSI
90555411	Pressure Protection Valve with One-Way Check	1/4" NPT	90 PSI	95 PSI

Pilot Valve

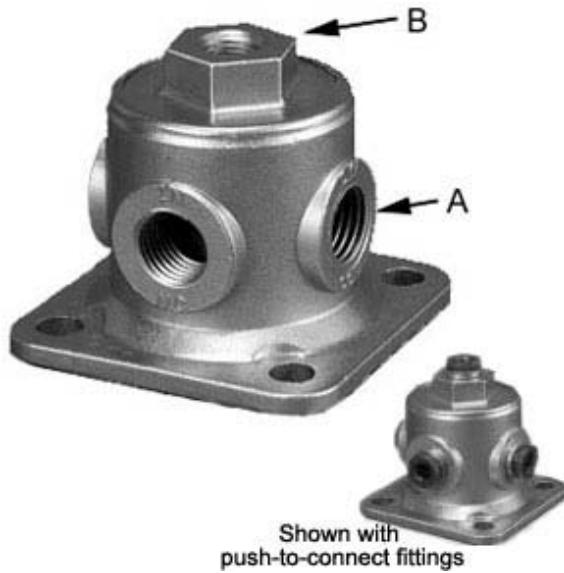

Features:

- Activated by applying pilot pressure.
- Remote mounted valve suited for any chassis location.
- Typically used on auxiliary axle applications or to rapidly exhaust air suspensions.

Notes:

- 1) Can be operated using a manual switch, such as **90054088**.
- 2) When connected to the galldhand or parking brake line, automatically exhausts the air suspension.

SKU#	Product Description	Ports A	Port B
90554615	Pilot Valve	1/4" NPT	1/8" NPT
90554616	Pilot Valve	1/4" Push In	1/4" Push In
90554990	Pilot Valve	3/8" Push In	3/8" Push In

Manually Operated Valve



Features:

- Small, Self-Relieving Manual Switch

Notes:

- 1) Supplies pilot pressure to dump valves, pilot valves or other basic accessories.

SKU#	Product Description	Application/Notes
90018410	Mounting Bracket	Manually Operated Valve (part number 90054088)
90054088	Manually Operated Valve	Ports – 1/8" NPT

Pressure Regulator Valve



Features:

- Manually reduces incoming pressure to desired output pressure.
- For applications where regulated output pressure is required.
- Can be mounted on a bracket, control panel or inside a weatherproof enclosure.

Notes:

- 1) Typically used with Haldex **90054786** silicone filled air gauge for air springs on auxiliary axles.

SKU#	Product Description	Port A	Port B	Notes
90054831	Pressure Regulator Valve	1/8" NPT	1/4" NPT	-
90054882	Pressure Regulator Valve	1/8" NPT	1/4" NPT	Non-adjustable, factory preset to 85 PSIG

Check Valve

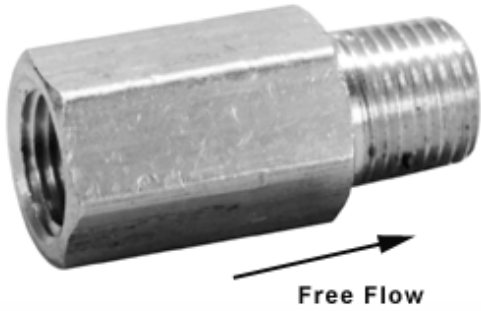

Features:

- Economic low pressure in-line check valve, allows air to flow in only one direction.

Notes:

- 1) When installed in the supply line of a height control valve it will eliminate air suspension back feed if system pressure is lost.

SKU#	Product Description	All Ports	Approximate Opening Pressure
90554078	Check Valve	1/8" NPT	2 - 4 PSI

Electric Solenoid Valve



Features:

- Connected with an electrical switch, this self-relieving two position solenoid valve supplies pilot pressure to dump valves, pilot valves or other basic accessories.

Specifications:

- 90024087** Mounting Bracket
- 90054793** Weldable Mounting Bracket

Notes:

- IMPORTANT:** This valve is not intended to be used as a dump valve.

SKU#	Product Description	All Ports	Volt	Position
90054074	Electric Solenoid Valve	1/4" NPT	12	Normally Closed
90054075	Electric Solenoid Valve	1/4" NPT	12	Normally Open
90054610	Electric Solenoid Valve	1/4" NPT	24	Normally Closed

Proportioning Valve



Features:

- Allows a single Height Control Valve to operate two suspensions requiring different air pressures.

Notes:

- 1) Typically used in conjunction with a smaller capacity tag/pusher system in specialty vehicles or coil spring lift which require additional pressure to overcome coil.

SKU#	Product Description	All Ports	Output
90054170	Proportioning Valve	1/4" NPT	Adjustable $\hat{A}\pm 30\%$ around a separate control signal.

Pressure Gauges



AIR GAUGE



SILICONE FILLED GAUGE

SKU#	Product Description	All Ports	Notes
90054700	Air Gauge	1/4" NPT	Often used to monitor accessory system operating pressure in protected environments.
90054786	Silicone Filled Gauge	1/4" NPT	Often used on accessory systems to monitor operating pressures. Replacement gauge for SM-130, SM-140, SM-115, SMD-111, AC-9014 and AC-9003.

Scale-O-Matics

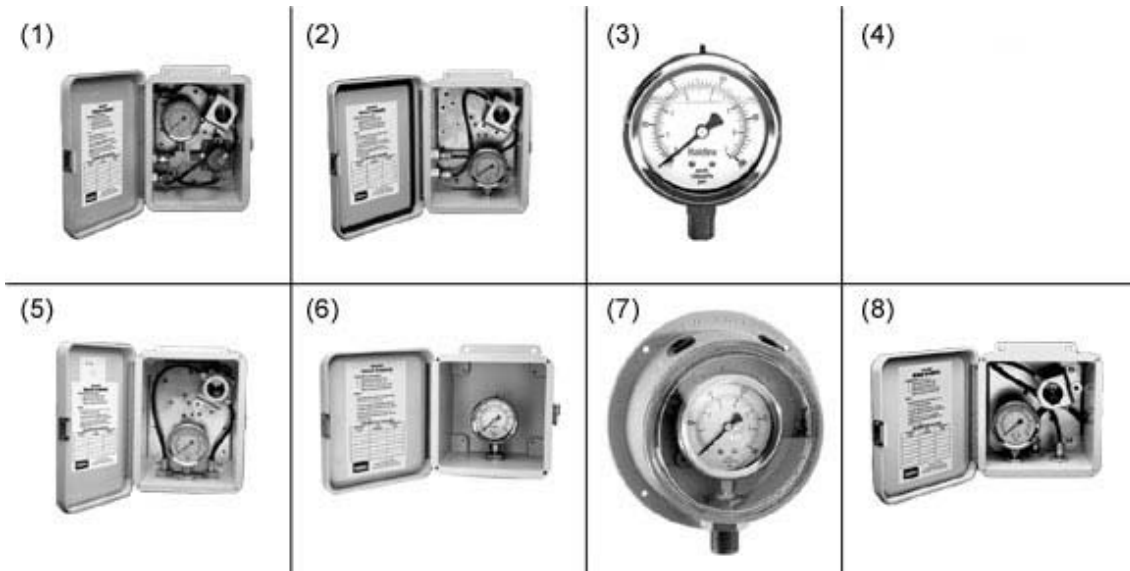

For determining vehicle load in remote areas away from scales.

SKU#	Product Description	Contains	All Ports	Application/Notes	Pic. #
42123026	Model SMD-111	Enclosed Manual Switch, Pilot Valve and Silicone Filled Gauge	1/4" NPT	One Height Control Valve Systems Manual lowering of trailers or trucks.	1
42123031	Model SM-115	Enclosed Manual Switch and Silicone Filled Gauge	1/4" NPT	One Height Control Valve System Switch plumbed out left side of enclosure. Switch controls accessory systems such as manual lowering of trailer or truck, control of lift axle systems or air assisted release of slider pins.	2
42123039	Model SM-130	Silicone Filled Gauge and Calibration Decal	1/4" NPT	One Height Control Valve System Includes calibration decal to record certified loads when precision operation is of utmost importance.	3
42123040	Model SM-140	Enclosed Silicone Filled Gauge and Calibration Decal	1/4" NPT	One Height Control Valve System Plumbing out bottom.	6
42123042	Model SM-115-1	Enclosed Manual Switch and Silicone Filled Gauge	1/4" NPT	One Height Control Valve System Switch plumbed out bottom of large enclosure. Switch controls accessory systems such as manual lowering of trailer or truck, control of lift axle systems, or air assisted release of slider pins.	5
42123043	Model SM-140-1	Enclosed Silicone Filled Gauge and Calibration Decal	1/4" NPT	One Height Control Valve System Plumbing out back.	6
42123044	Model SM-140-2	Enclosed Silicone Filled Gauge and Calibration Decal	1/4" NPT	One Height Control Valve System Plumbing out bottom, economical round enclosure.	7
42123045	Model SM-115-2	Enclosed Manual Switch and Silicone Filled Gauge	1/4" NPT	One Height Control Valve System Switch plumbed out bottom of small enclosure. Switch controls accessory systems such as manual lowering of trailer or truck, control of lift axle systems, or air assisted release of slider pins.	8

AC Boxes



42130040



42140128

SKU#	Product Description	Contains	All Ports	Application/Notes
42130040	Model AC-9014	Air Control Box with Enclosed Regulator and Gauge	1/4" NPT	Typical application is for air springs on Auxiliary Axles. Used in applications where regulated output air pressure is required. A combination of an adjustable regulator and silicone filled gauge mounted inside a durable weatherproof enclosure.
42140128	Model AC-9088	Air Control Box with Enclosed Manual Switch	1/4" NPT	Use to activate dump valves or Haldex pilot valves. Self Relieving Manual Switch (90054088) mounted inside a durable, weatherproof enclosure.

Mounting Brackets



All dimensions shown in inches.

SKU#	Product Description	Application/Notes
90018410	Mounting Bracket	Manually Operated Valve (part number 90054088)
90024087	Mounting Bracket	Electric Solenoid Valve (part numbers 90054074, 90054075, 90054610)
90031425	Linkage Tab	All Linkage Products Heavy Duty
90054791	Scale-O-Matic Bracket	Small Enclosures Only Heavy duty, weldable brackets provide mounting for products containing weatherproof enclosures, such as Scale-O-Matics.
90054793	Weldable Mounting Bracket	Electric Solenoid Valve (part numbers 90054074, 90054075, 90054610)

Waterproof Enclosures

90554346

SM-240 Hole Pattern and Enclosure Size

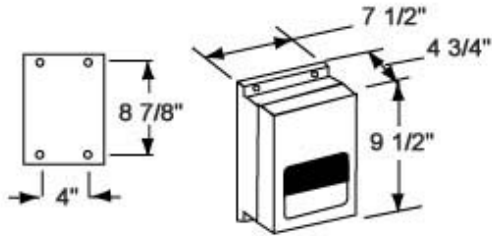

90554628

SM-140 Hole Pattern and Enclosure Size

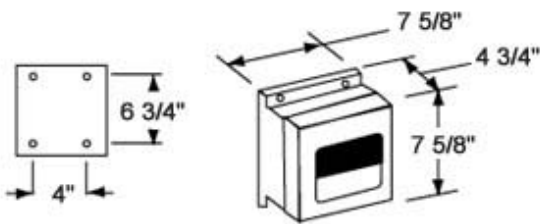

Protects contents and provide easy installation.

SKU#	Product Description	Application
90554346	Large Weatherproof Enclosure	Model Numbers SM-115, SM-115-1, AC-9003, SMD-111 and SM-240
90554628	Small Weatherproof Enclosure	Model Numbers SM-140, SM-115-2, AC-9014 and AC-9088

AC-3800 Series Air Control Kits

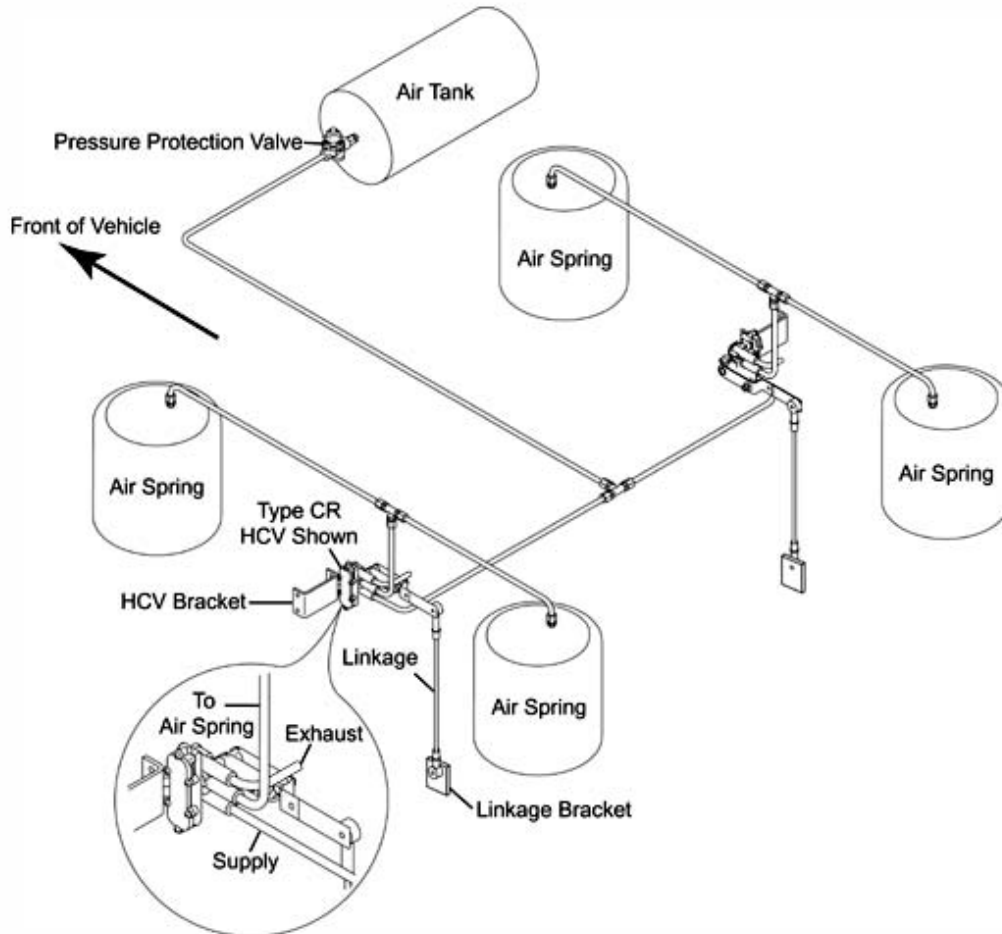

Function: Maintains Constant Ride Height

Application: Truck with Two Height Control Valves

Piping diagrams represent typical installations, for reference only.

SKU#	Product Description	Kit Components	Kit Components
42140022	Model AC-3800	(2) Type CR HCV w/std. 7" Control Arm (2) Adj. Linkage Kits w/14.5" Rod (1) Pressure Protection Valve (2) Parts Bags w/Fittings for 1/4" Tubing	(2) Parts Bags w/Nuts & Bolts for mounting HCV (2) HCV Mounting Brackets (2) Linkage Mounting Brackets for ea. Linkage
42140111	Model AC-3800	(2) Type CR HCV w/std. 7" Control Arm (2) Adj. Linkage Kits w/14.5" Rod (1) Pressure Protection Valve (2) Parts Bags w/Fittings for 3/8" Tubing	(2) Parts Bags w/Nuts & Bolts for mounting HCV (2) HCV Mounting Brackets (2) Linkage Mounting Brackets for ea. Linkage
42140118	Model AC-3800-IR-WD	(2) Type IR HCV w/Dump (2) Fixed Length Linkage Kits w/16" Center to Center	(2) Linkage Mounting Brackets for ea. Linkage (2) Exhaust Tubes w/Fittings
42140119	Model AC-3800-IR	(2) Type IR HCV (2) Adj. Linkage Kits w/14" Rod (1) Pressure Protection Valve	(2) Linkage Mounting Brackets for ea. Linkage (1) Parts Bag w/Nuts & Bolts for mounting HCV

AC-6100 Series Air Control Kits

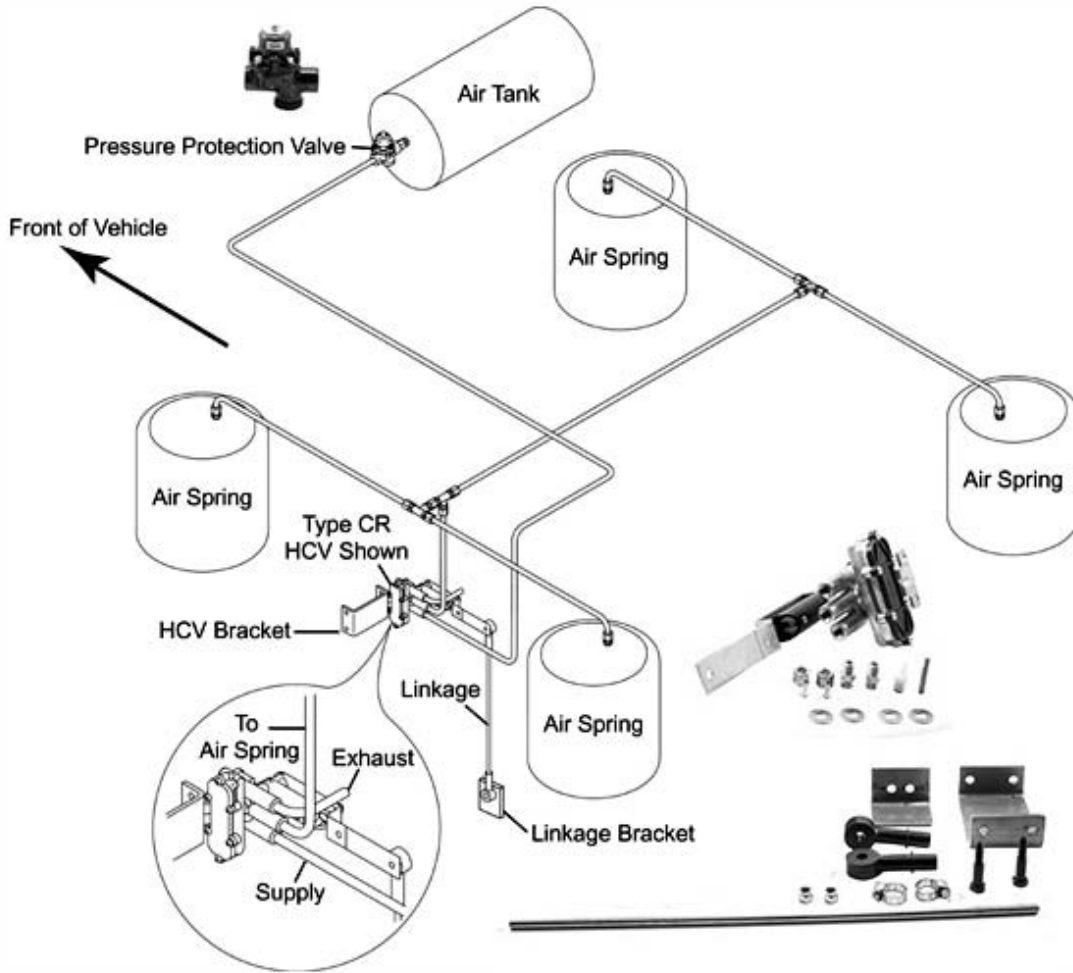

Function: Maintains Constant Ride Height
Application: Truck or Trailer with One Height Control Valve
Piping diagrams represent typical installations, for reference only.

SKU#	Product Description	Kit Components	Kit Components
42110042	Model AC-6100	(1) Type CR HCV w/std. 7" Control Arm (1) Adj. Linkage Kit w/14.5" Rod (1) Pressure Protection Valve	(1) Parts Bag w/Fittings for 1/4" Tubing (1) Parts Bag w/Nuts & Bolts for mounting HCV (1) HCV Mounting Bracket (1) Linkage Mounting Bracket
42110051	Model AC-6100	(1) Type CR HCV w/std. 7" Control Arm (1) Adj. Linkage Kit w/14.5" Rod (1) Pressure Protection Valve	(1) Parts Bag w/Fittings for 3/8" Tubing (1) Parts Bag w/Nuts & Bolts for mounting HCV (1) HCV Mounting Bracket (1) Linkage Mounting Bracket

AC-6000 Series Air Control Kits

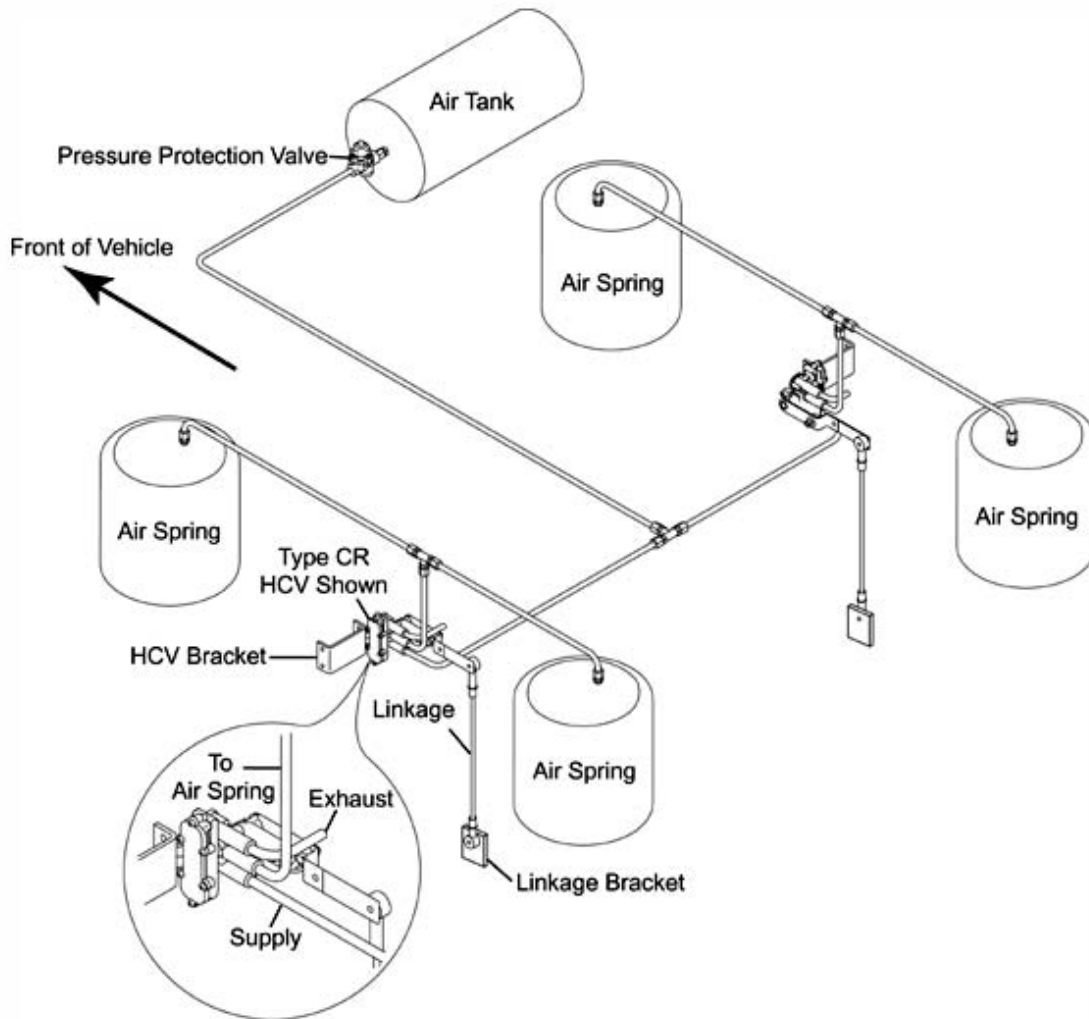

Function: Maintains Constant Ride Height

Application: Trailer with Two Height Control Valves

Piping diagrams represent typical installations, for reference only.

SKU#	Product Description	Kit Components	Kit Components
42110008	Model AC-6000	(2) Type CR HCV w/std. 7" Control Arm (2) Adj. Linkage Kits w/14.5" Rod (1) Pressure Protection Valve	(2) Parts Bags w/Fittings for 1/4" Tubing (2) Parts Bags w/Nuts & Bolts for mounting HCV (2) Linkage Mounting Brackets

AC-84-M/S-3 Series Air Control Kits

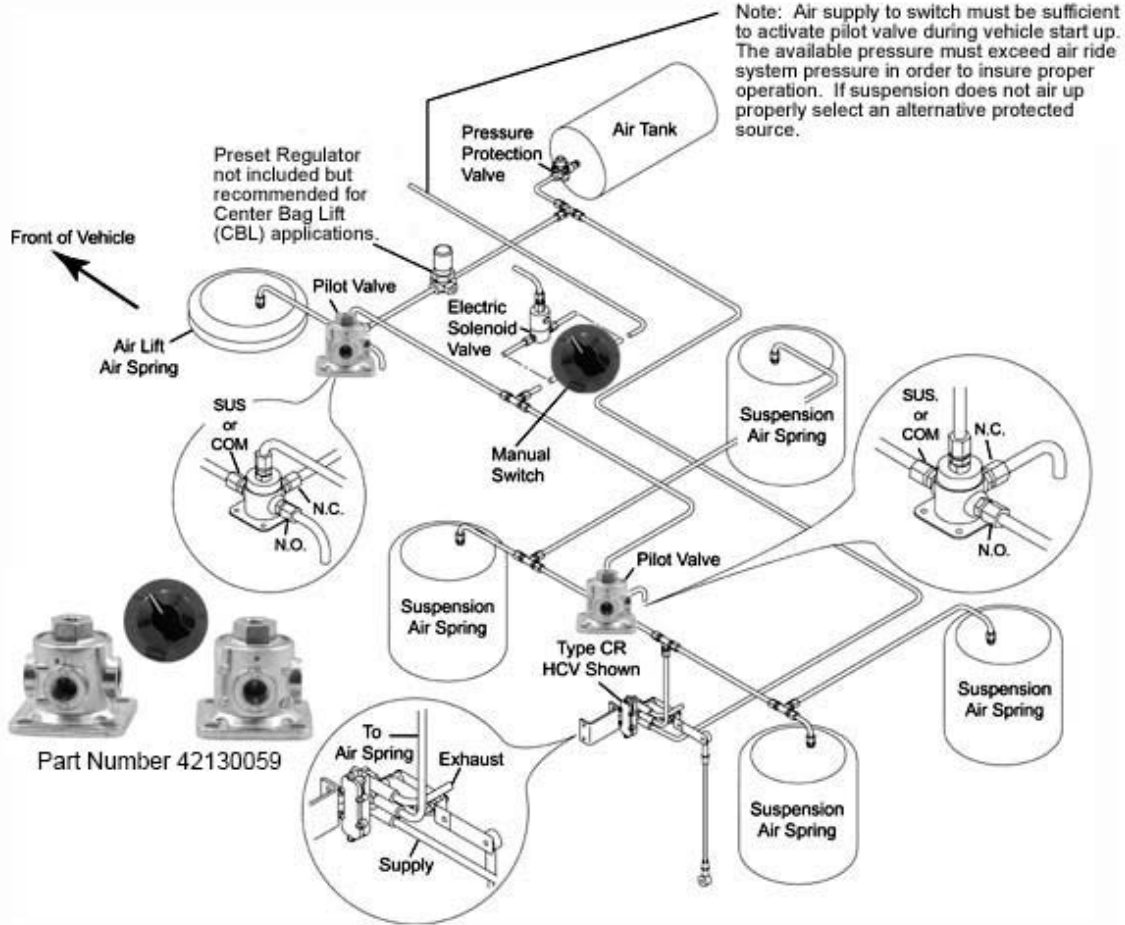

Function: Axle Lift Kits by Air

Application: Truck or Trailer Air Suspension with One Height Control Valve

Piping diagrams represent typical installations, for reference only.

SKU#	Product Description	Kit Components
42130059	Model AC-84-M-3 (Manually Operated System)	(2) Pilot Valves (1) Manually Operated On/Off Valve

AC-84-M/S-1 Series Air Control Kits

Note: For auxiliary lift axle only. Primary suspension not shown. Air supply to switch must be sufficient to activate pilot valve during vehicle start up. The available pressure must exceed air ride system pressure in order to insure proper operation. If suspension does not air up properly select an alternative protected source.

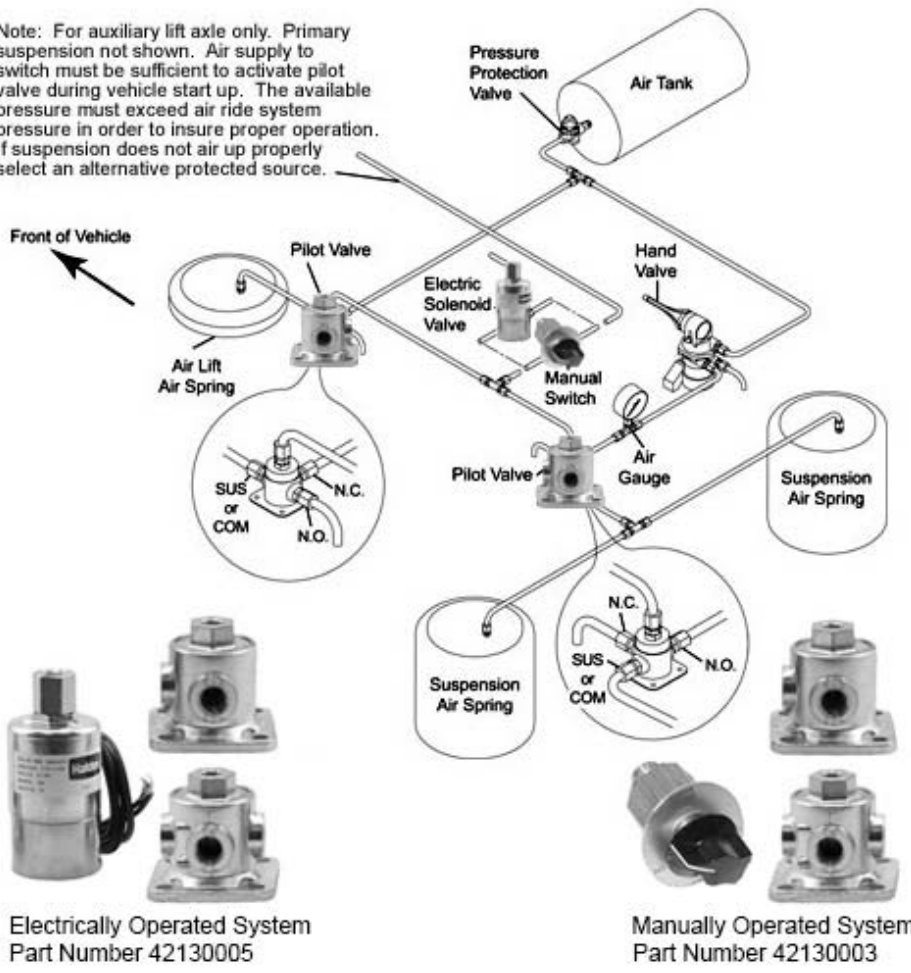

Function: Axle Lift Kits by Air

Application: Truck or Trailer Auxiliary Spring Suspension

Piping diagrams represent typical installations, for reference only.

SKU#	Product Description	Kit Components
42130003	Model AC-84-M-1 (Manually Operated System)	(2) Pilot Valves (1) Manually Operated On/Off Valve
42130005	Model AC-84-S-1 (Electrically Operated System)	(2) Pilot Valves (1) Electric Solenoid Valve (1) Parts Bag w/Nuts & Bolts for mounting Solenoid Valve

AC-5500 Series Air Control Kits

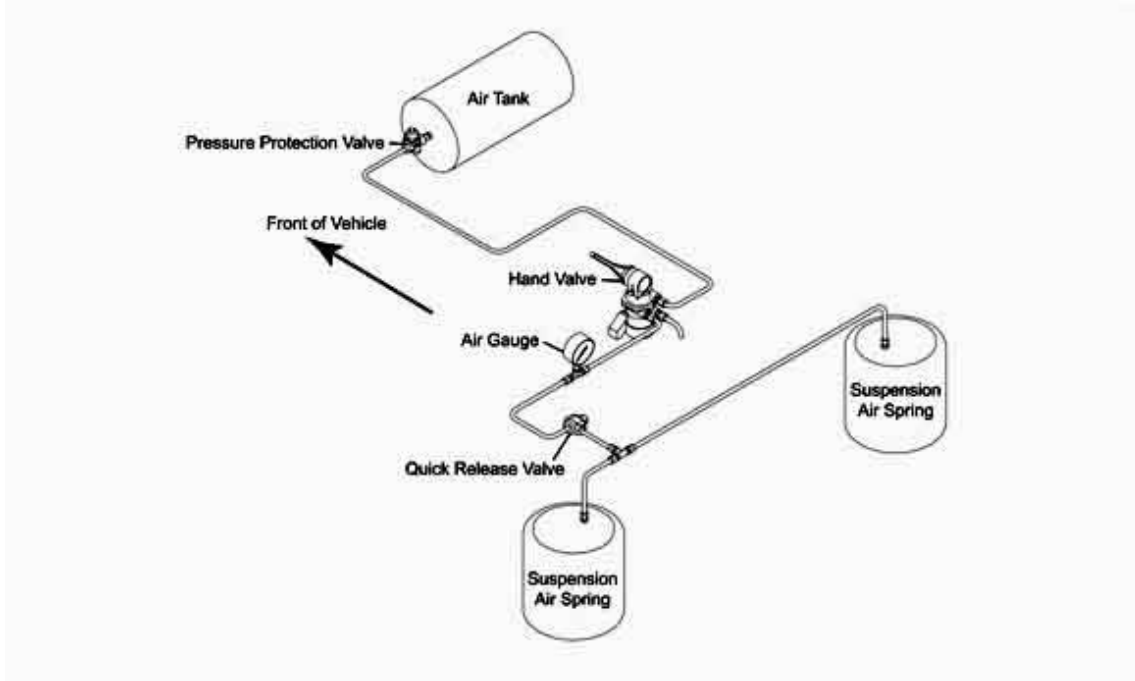

Function: Axle Lift Kits for Add-On Axle Units
Application: Truck or Trailer Air Suspension with Coil Spring Lift
used with Primary Mechanical Suspensions
Piping diagrams represent typical installations, for reference only.

SKU#	Product Description	Kit Components
42130018	Model AC-5500	(1) Pressure Protection Valve (1) Hand Control Valve (1) Quick Release Valve (1) Air Gauge

AC-5600 Series Air Control Kits

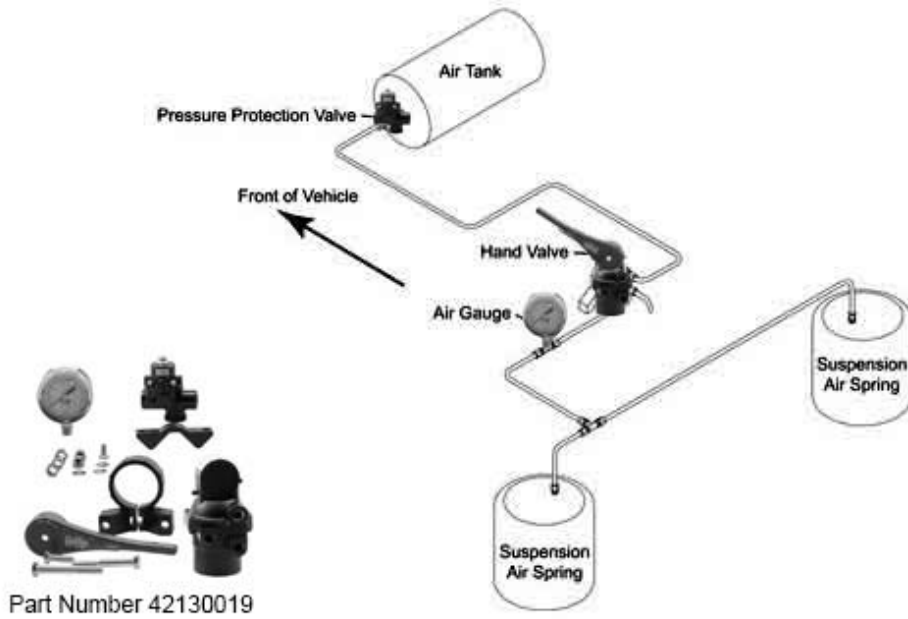

Function: Add-On Axle Units
Application: Truck or Trailer Air Suspension used with Primary Mechanical Suspensions
Piping diagrams represent typical installations, for reference only.

SKU#	Product Description	Kit Components
42130019	Model AC-5600	(1) Pressure Protection Valve (1) Hand Control Valve (1) Air Gauge

AC-78-1 Series Air Control Kits

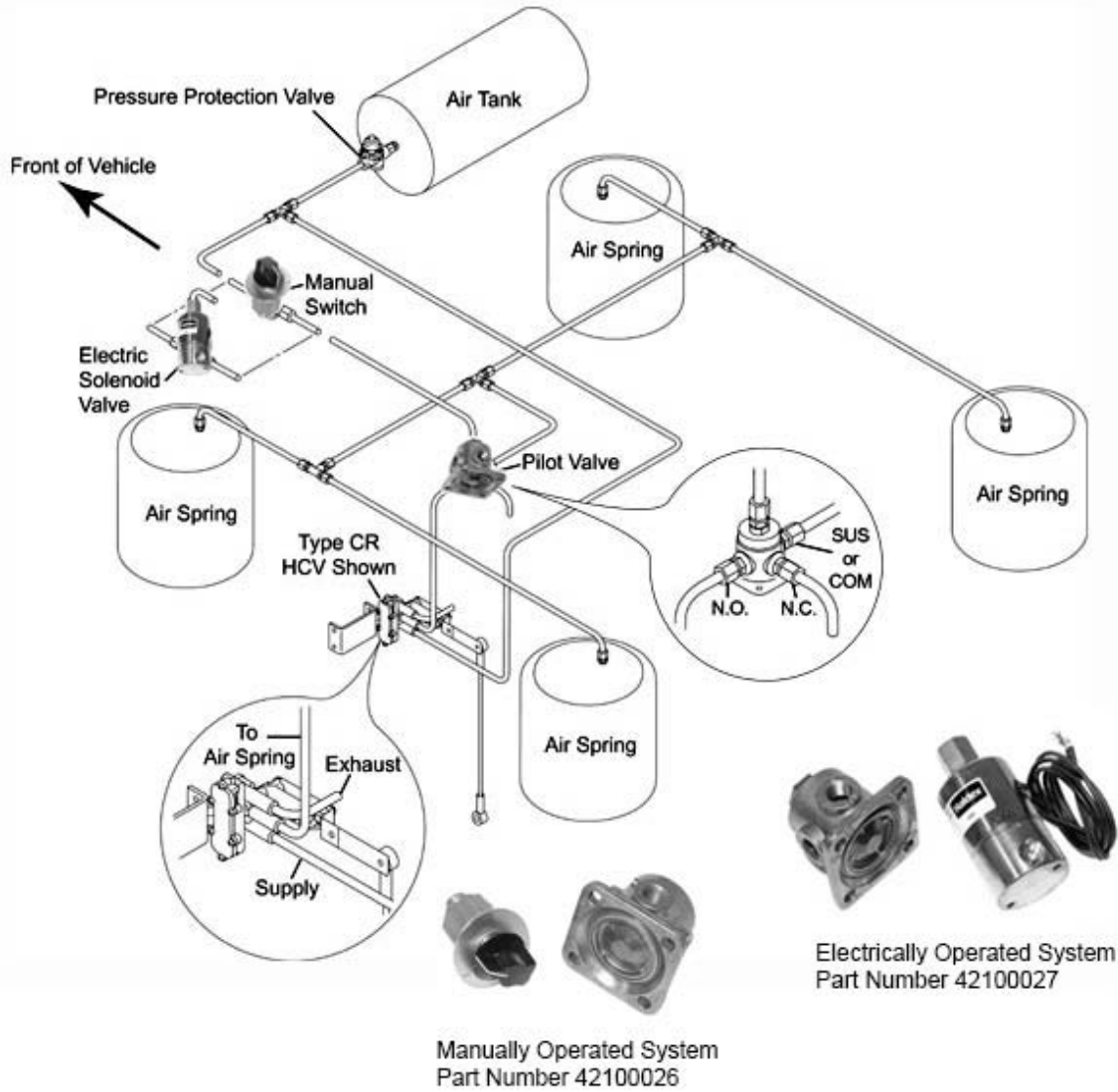

Function: Lowering (Exhausting) System from Ride Height
Application: Truck or Trailer with One Height Control Valve
 Piping diagrams represent typical installations, for reference only.

SKU#	Product Description	Kit Components
42100026	Model AC-78-M-1 (Manually Operated System)	(1) Pilot Valve (1) Manual Operated On/Off Valve
42100027	Model AC-78-S-1 (Electrically Operated System)	(1) Pilot Valve (1) Electric Solenoid Valve (1) Parts Bag w/Nuts & Bolts for mounting Solenoid Valve

AC-77-1 Series Air Control Kits

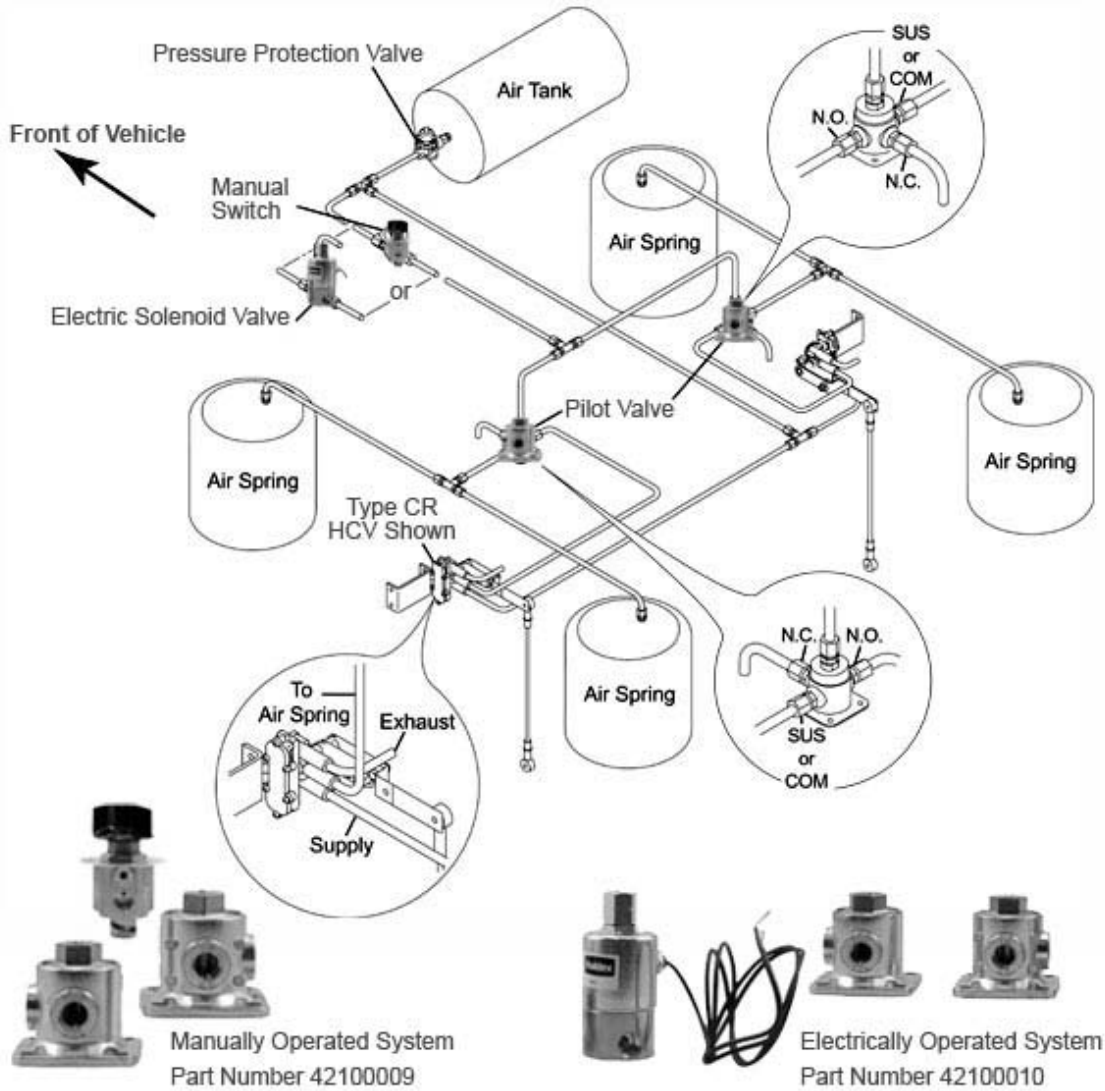

Function: Lowering (Exhausting) Systems from Ride Height
Application: Truck or Trailer with Two Height Control Valves
 Piping diagrams represent typical installations, for reference only.

SKU#	Product Description	Kit Components
42100009	Model AC-77-M-1 (Manually Operated System)	(2) Pilot Valves (1) Manual Operated On/Off Valve
42100010	Model AC-77-S-1 (Electrically Operated System)	(2) Pilot Valves (1) Electric Solenoid Valve (1) Parts Bag w/Nuts & Bolts for mounting Solenoid Valve

AC-78-4 Series Air Control Kits

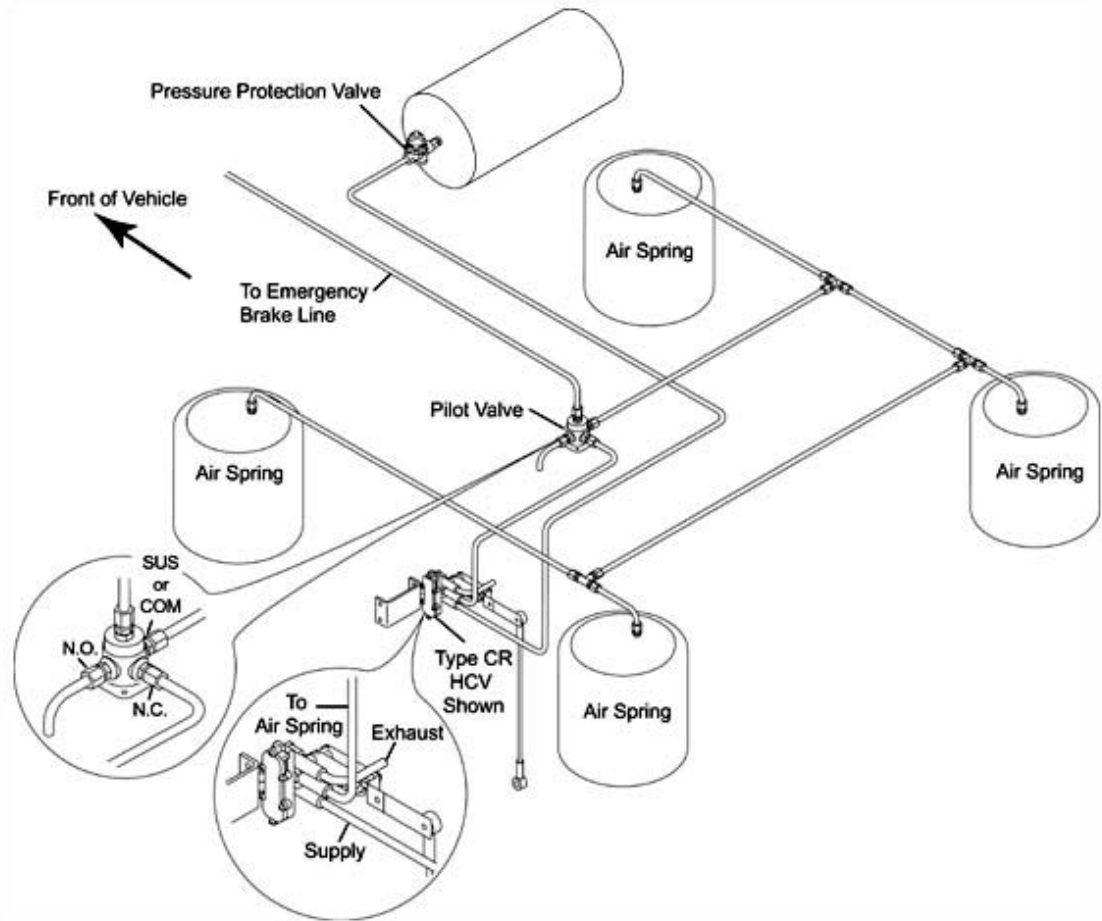

Function: Lowering (Exhausting) Systems from Ride Height when Emergency Brake is Engaged
Application: Truck or Trailer with One Height Control Valve
 Piping diagrams represent typical installations, for reference only.

SKU#	Product Description	Kit Components
42100029	Model AC-78-M-4	(1) Pilot Valve

AC-78-5 Series Air Control Kits

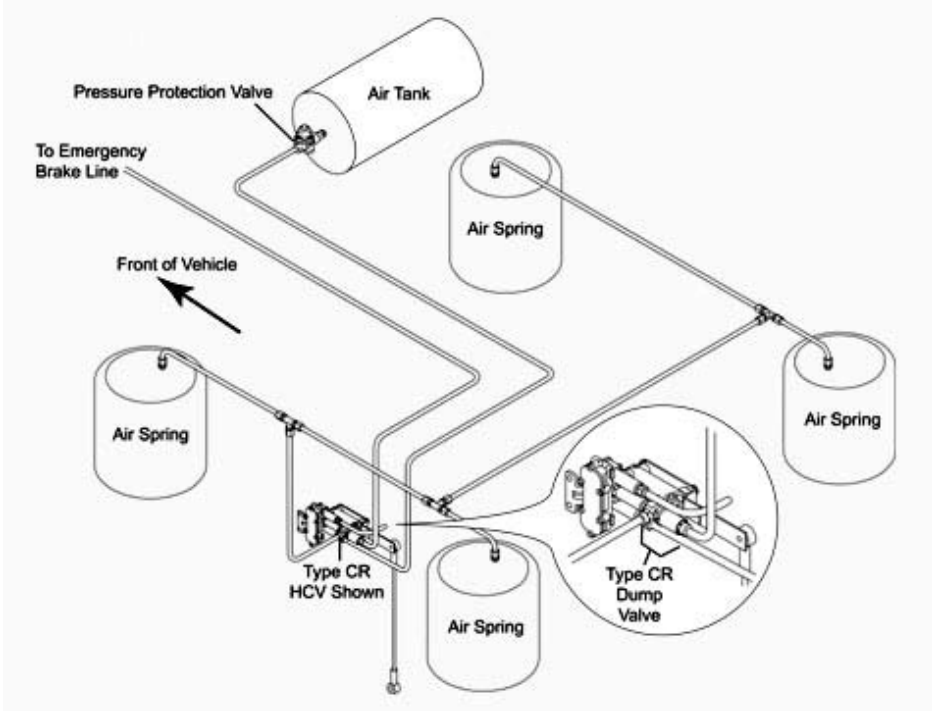

Function: Lowering (Exhausting) Systems from Ride Height when Emergency Brake is Engaged

Application: Truck or Trailer with One Height Control Valve

Piping diagrams represent typical installations, for reference only.

SKU#	Product Description	Kit Components
42100051	Model AC-78-M-5	(1) Normally Closed Dump Valve

Air Control Kit Application Guide 17–SUSPENSION CONTROLS

Function	Application	AC Kit
Truck		
Maintains Constant Ride Height	1 Height Control Valve	AC-6100
	2 Height Control Valves	AC-3800
Manual Electric Raise/Lower and Automatic Lift in Reverse	V-Steer Suspensions	AC-V-22
Manual Electric Raise/Lower and Automatic Lift and Lock in Reverse	V-Steer Suspensions	AC-V-23
Trailer		
Maintains Constant Ride Height	1 Height Control Valve	AC-6100
	2 Height Control Valves	AC-6000
Truck or Trailer		
Axle Lift Kit	Pressure Regulator Controls	
	Air Suspension Drive Axle	AC-84-4
Axle Lift Kit	Air Suspension Drive Axle	AC-84-M-5
	1 Height Control Valve	AC-84-M/S-3
Axle Lift Kit	Air Suspension Drive Axle	
	2 Height Control Valves	AC-84-M/S-2
Axle Lift Kit	Lift Axle by air with auxiliary Spring Suspension	AC-84-M/S-1
Axle Lift Kit for Add-On Axle Units	Air Suspension with Coil Spring Lift used with Primary Mechanical Suspensions	AC-5500
Axle Lift Kit for Add-On Axle Units	Air Suspension used with Primary Mech. Suspension	AC-5600
Raising and Lowering of Systems from Ride Height	1 Height Control Valve	AC-78-M/S
	2 Height Control Valves	AC-77-M/S
Lowering (Exhausting) Systems from Ride Height	1 Height Control Valve	AC-78-M/S-1
	2 Height Control Valves	AC-77-M/S-1
Lowering (Exhausting) Systems from Ride Height when Emergency Brake is Engaged	1 Height Control Valve	AC-78-M-4
	1 Height Control Valve	AC-78-M-5
	2 Height Control Valves	AC-77-M-4

Note: The piping diagrams depicted on the following pages represent typical installations and are for reference only. Air control component configurations could vary. Please contact Haldex Technical Service with any questions at 1-800-643-2374.

Notes

Notes

Notes

This page left blank intentionally.

Haldex develops and provides reliable and innovative solutions with focus on brake and air suspension products to the global commercial vehicle industry.

Listed on the Stockholm Stock Exchange, Haldex has annual sales of approximately 3.9 billion SEK and employs about 2,200 people.

Disclaimer: The products described within this literature, including without limitation, product features, specifications, designs, availability and pricing are subject to change by Haldex and its subsidiaries at any time without notice.

This document and other information from Haldex, its subsidiaries and authorized distributors provide product and/or system options for further investigation by users having technical expertise. It is important that you analyze all aspects of your application and review the information concerning the product or system, in the current literature or catalog. Due to the variety of operating conditions and applications for these products or systems, the user, through their own analysis and testing, is solely responsible for making the final selection of the products and systems and assuring that all performance, safety and warning requirements are met.

©2014, Haldex AB - This material may contain Haldex trademarks and third party trademarks, trade names, corporate logos, graphics and emblems which are the property of their respective companies. The contents of this document may not be copied, distributed, adapted or displayed for commercial purposes or otherwise without prior written consent from Haldex.

Innovative Vehicle Solutions

Austria

Haldex Wien Ges.m.b.H.
Vienna
Tel.: +43 1 8 69 27 97
Fax: +43 1 8 69 27 97 27
E-Mail: info.at@haldex.com

Belgium

Haldex N.V.
Balegem
Tel.: +32 9 363 90 00
Fax: +32 9 363 90 09
E-Mail: info.be@haldex.com

Brazil

Haldex do Brasil Ind. E Com. Ltda.
São José dos Campos
Tel.: +55 12 3935 4000
Fax: +55 12 3935 4018
E-Mail: info.brasil@haldex.com

Canada

Haldex Ltd.
Cambridge, Ontario
Tel.: +1 519 621 6722
Fax: +1 519 621 3924
E-Mail: info.ca@haldex.com

China

Haldex Vehicle Products Co. Ltd.
Suzhou
Tel.: +86 512 8885 5301
Fax: +86 512 8765 6066
E-Mail: info.cn@haldex.com

France

Haldex Europe SAS
Weyersheim
Tel.: +33 3 88 68 22 00
Fax: +33 3 88 68 22 09
E-Mail: info.eur@haldex.com

Germany

Haldex Brake Products GmbH
Heidelberg
Tel.: +49 6 221 7030
Fax: +49 6 221 703400
E-Mail: info.de@haldex.com

Hungary

Haldex Hungary Kft.
Szentlőrincskáta
Tel.: +36 29 631 400
Fax: +36 29 631 401
E-Mail: info.hu.eu@haldex.com

India

Haldex India Limited
Nasik
Tel.: +91 253 6699501
Fax: +91 253 2380729

Italy

Haldex Italia Srl.
Biassono
Tel.: +39 039 47 17 02
Fax: +39 039 27 54 309
E-Mail: info.it@haldex.com

Korea

Haldex Korea Ltd.
Seoul
Tel.: +82 2 2636 7545
Fax: +82 2 2636 7548
E-Mail: info.hkr@haldex.com

Mexico

Haldex de Mexico S.A. De C.V.
Monterrey
Tel.: +52 81 8156 9500
Fax: +52 81 8313 7090

Poland

Haldex Sp. z.o.o.
Praszka
Tel.: +48 34 350 11 00
Fax: +48 34 350 11 11
E-Mail: info.pl@haldex.com

Russia

OOO "Haldex RUS"
Moscow
Tel.: +7 495 747 59 56
Fax: +7 495 786 39 70
E-Mail: info.ru@haldex.com

Spain

Haldex España S.A.
Granollers
Tel.: +34 93 84 07 239
Fax: +34 93 84 91 218
E-Mail: info.es@haldex.com

Sweden

Haldex Brake Products AB
Landskrona
Tel.: +46 418 47 60 00
Fax: +46 418 47 60 01
E-Mail: info.se@haldex.com

United Kingdom

Haldex Ltd.
Newton Aycliffe
Tel.: +44 1325 310 110
Fax: +44 1325 311 834
E-Mail: info.gb@haldex.com

Haldex Brake Products Ltd.
MIRA Technology Park
Tel.: +44 2476 400 300
Fax: +44 2476 400 301
E-Mail: info.gbre@haldex.com

USA

Haldex Brake Products Corp.
Kansas City
Tel.: +1 816 891 2470
Fax: +1 816 891 9447
E-Mail: info.us@haldex.com



www.haldex.com

L00096W US 6/14 WEB ONLY