

BERNARDI BTS 24

FREESTANDING 24KG HEAVY DUTY DOUBLE ARM MIXER

BT2440059



BERNARDI BTS24

Let yourself be conquered by BTs Range. The BTs range represents the top of line double arm mixer range from Bernardi.

Capable of every kind of dough, the BTs-24 will perfectly knead and oxygenates 3kg to 24kg of dough to a standard that praises the highest tradition. The patented compact system enables the double arms to adapt to minimal space requirements and offer exceptional performance.

Ideal for preparing large quantities of yeast in confectionaries, bread of high hydration, dough for pizza, focaccia, croissants, short pastry, flaky pastry, egg pasta, brioches, panettone and more.

It strings dough with high hydration to perfection, even until 100%.

TRY IT
AND FALL IN LOVE 



MAIN CHARACTERISTICS

- Five-speed inverter-controlled arm moving system (from 35 to 65 strokes per minute)
- Small-sized double-arm compact system
- Completely extractable arms to ensure emptying and cleaning operations are easier.
- Double-channel emergency stop system ("Safety Torque Off")
- Touch-system control board
- High Torque efficiency induction engine
- Bluetooth communication system to use proprietary application "MixDrive" on iOS and Android smartphones
- Reinforced Bowl Heavy Gauge Bowl and plates
- 400V three-phase operation

DIMENSIONS

Kneading machine dimensions LxWxH (mm)	450 x 710 x 910
Dimensions with packaging LxWxH (mm)	550 X 810 X 1100

SPECIFICATIONS

Flour capacity	2kg - 15kg
Kneading capacity	3kg - 24 kg
Bowl capacity	35 litres
Dimensions of bowl	Ø 43 - h 30
Voltage	400 V three-phase, supplied with a lead only
Power	1500 W
Speed of the arms	5 speed from 35 to 65 strokes/min
Extractable arms	Yes
Extractable bowl	No
Net weight/packing	140 kg / 165 kg
Color	White/Stainless Steel
Warranty	2 years parts and labour



Phone: 1800 183 818 Email: support@thegoodlady.com.au
Website: www.thegoodlady.com.au

BERNARDI BTS 24

FREESTANDING 24KG HEAVY DUTY DOUBLE ARM MIXER

BT2440059

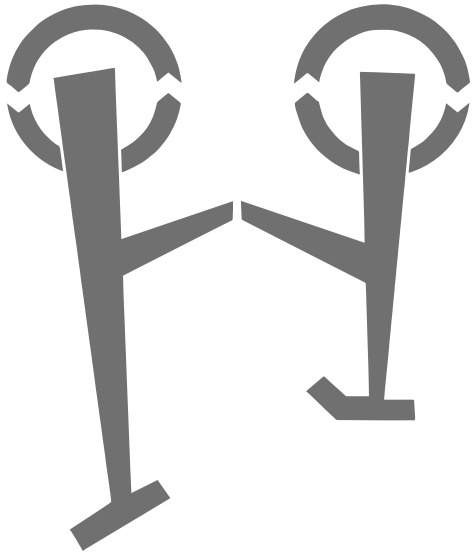

Bernardi patent

- The exclusive compact kneading arm system is a patent of Bernardi.
- This compact system can even make the most difficult recipes such as large leavened kneading and high-hydration dough.

DOUGH	BERNARDI BTS 24
BREAD	●●●
PIZZA	●●●
EGG PASTA	●●●
PIZZA NAPOLETANA	●●●
FROLLA PASTA	●●●
BRIOCHEs/VIENNOISERIES	●●●
SHORT PASTA	●●●
CROISSANTS	●●●
PANETTONE	●●●
HIGH HYDRATION DOUGH	●●●

- The maximum kneading capacity refers to a flour/liquid ratio of 1:0.6 and may vary according to the recipe
- The minimum kneading capacity is approximately the 20% of the maximum capacity
- For tough dough - less than 55% hydration - like egg pasta and mother yeast, reduce the maximum capacity of flour by 50%

FRONT

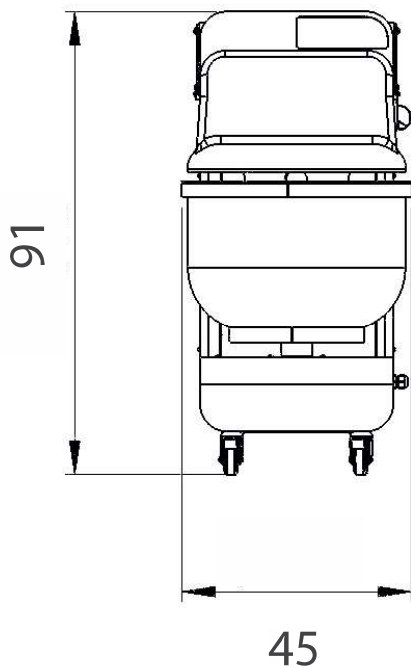

SIDE

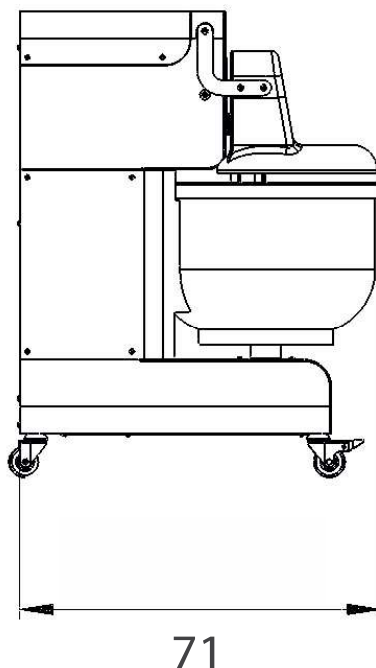

Phone: 1800 183 818 Email: support@thegoodlady.com.au
Website: www.thegoodlady.com.au