

DESCRIPTION

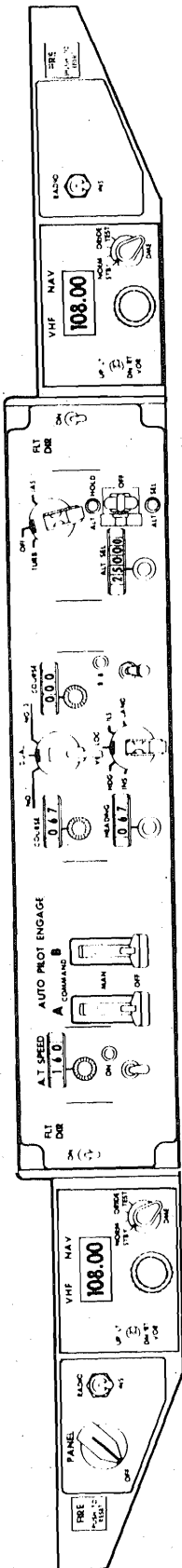

PILOTS' LIGHT SHIELD

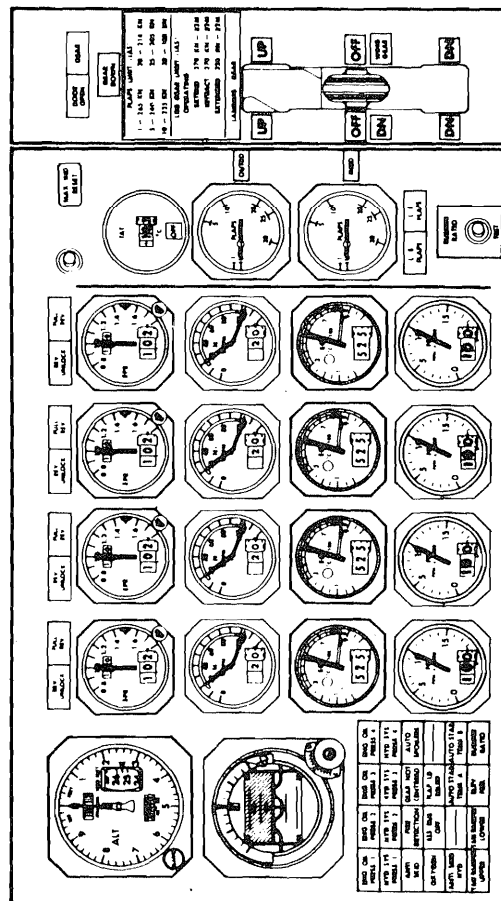

CENTER INSTRUMENT PANEL

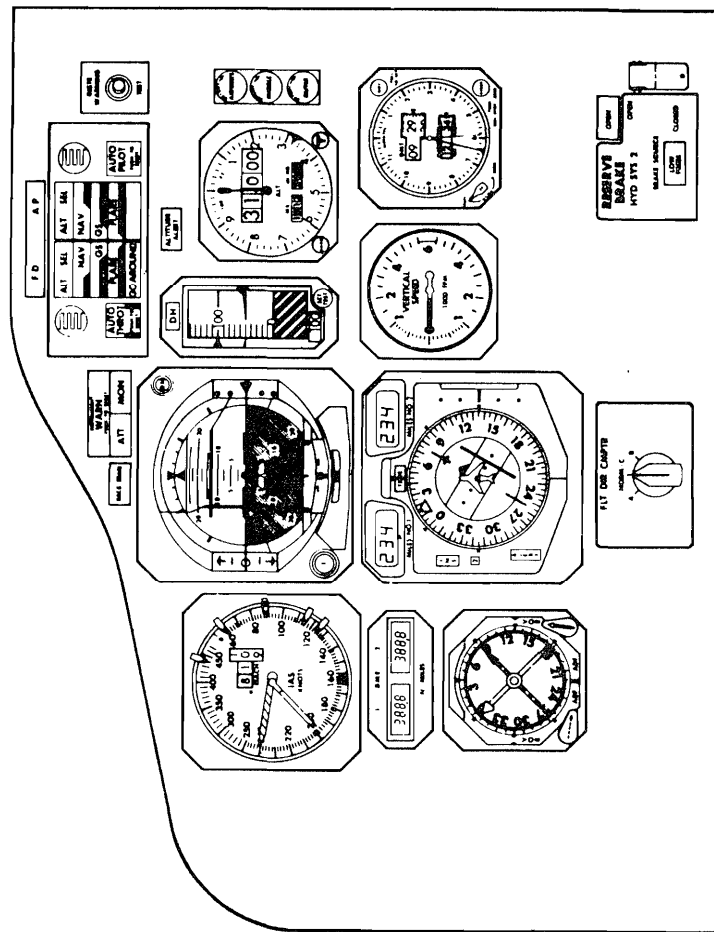

CAPTAIN'S INSTRUMENT PANEL

DESCRIPTION

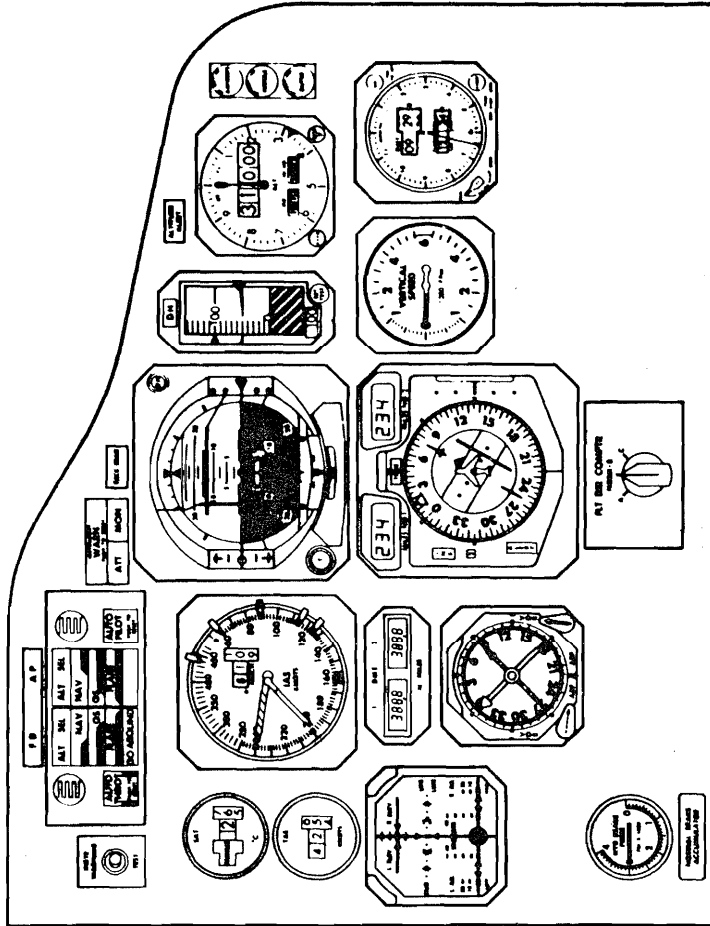

FIRST OFFICER'S INSTRUMENT PANEL

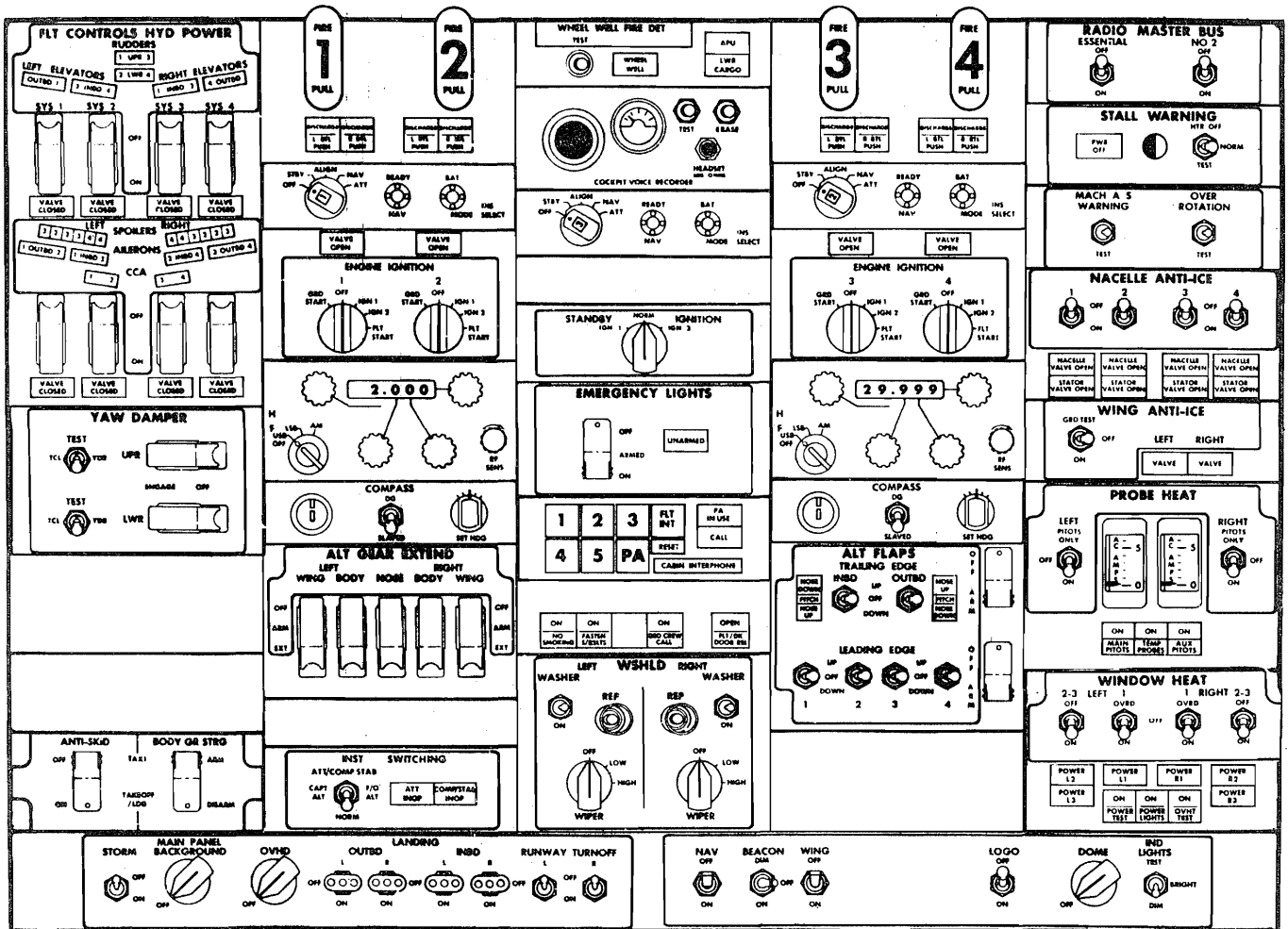

PILOT'S OVERHEAD PANEL

DESCRIPTION

FORWARD PORTION
PILOT'S CONTROL STAND

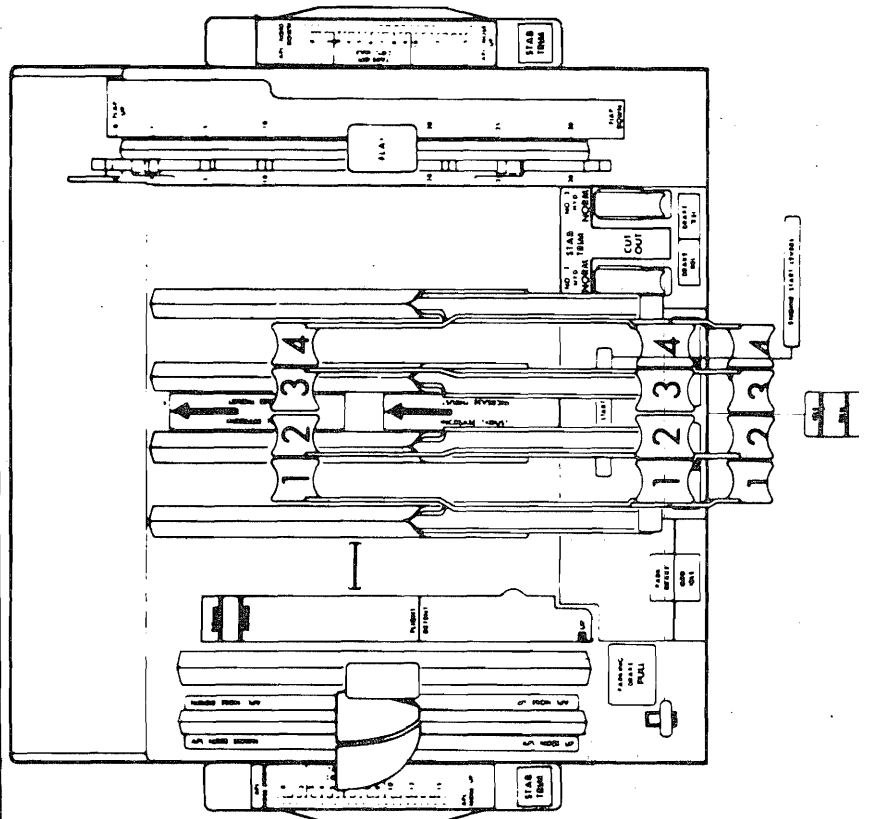
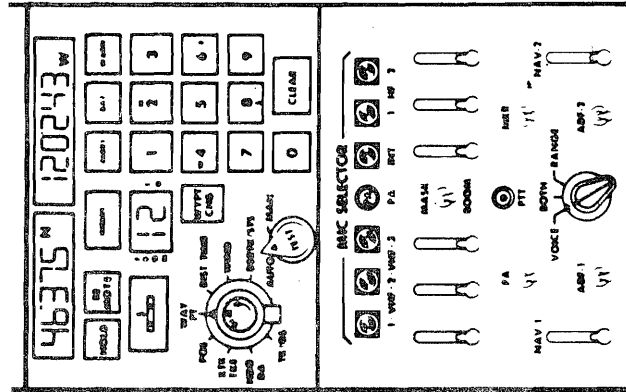
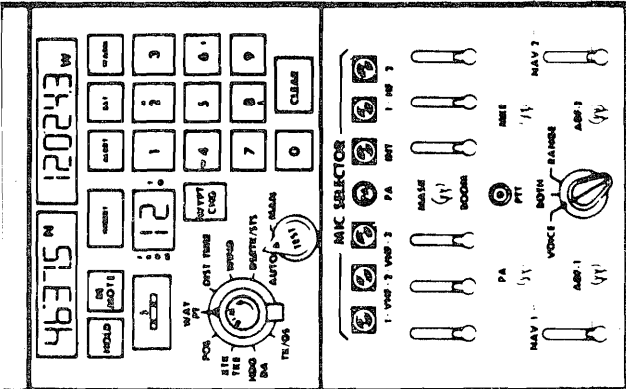

INVERTIBLE
SWITCH
PRESS TO
REVERSE

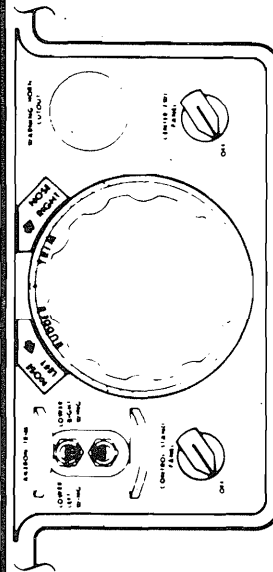
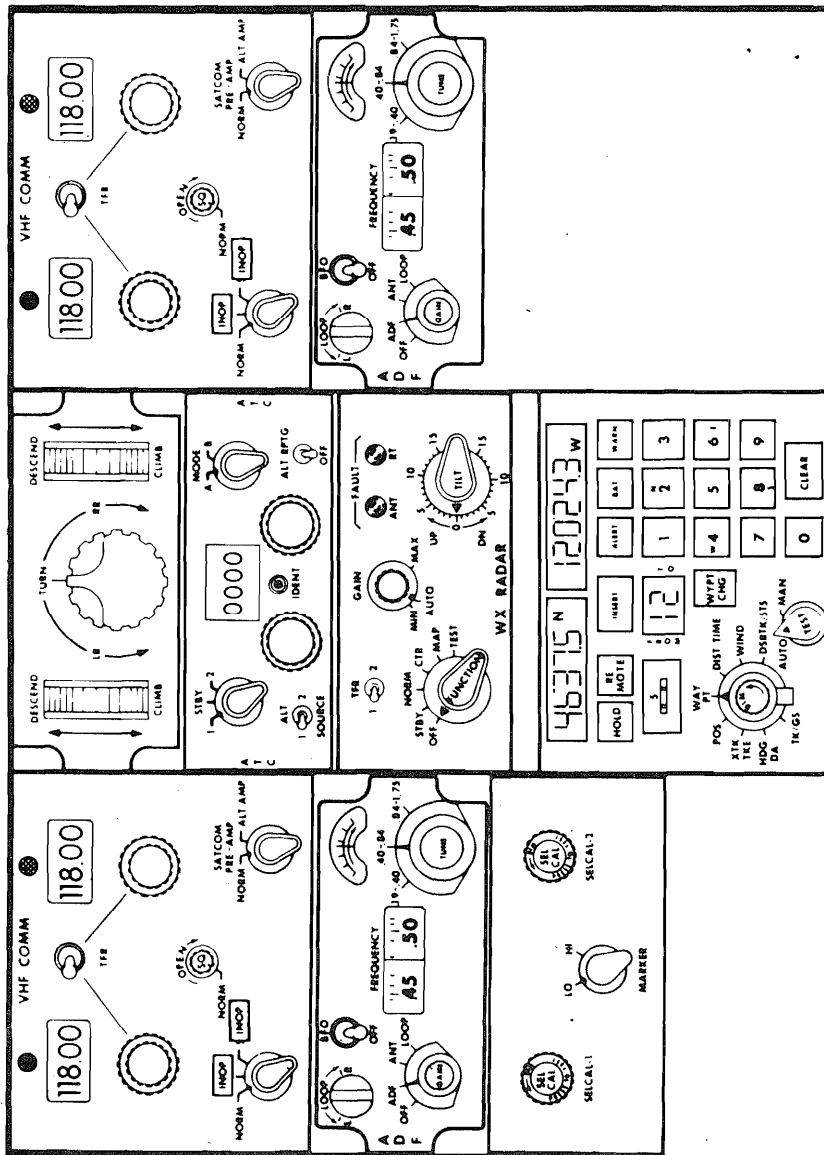

PILOTS' CONTROL STAND

DESCRIPTION

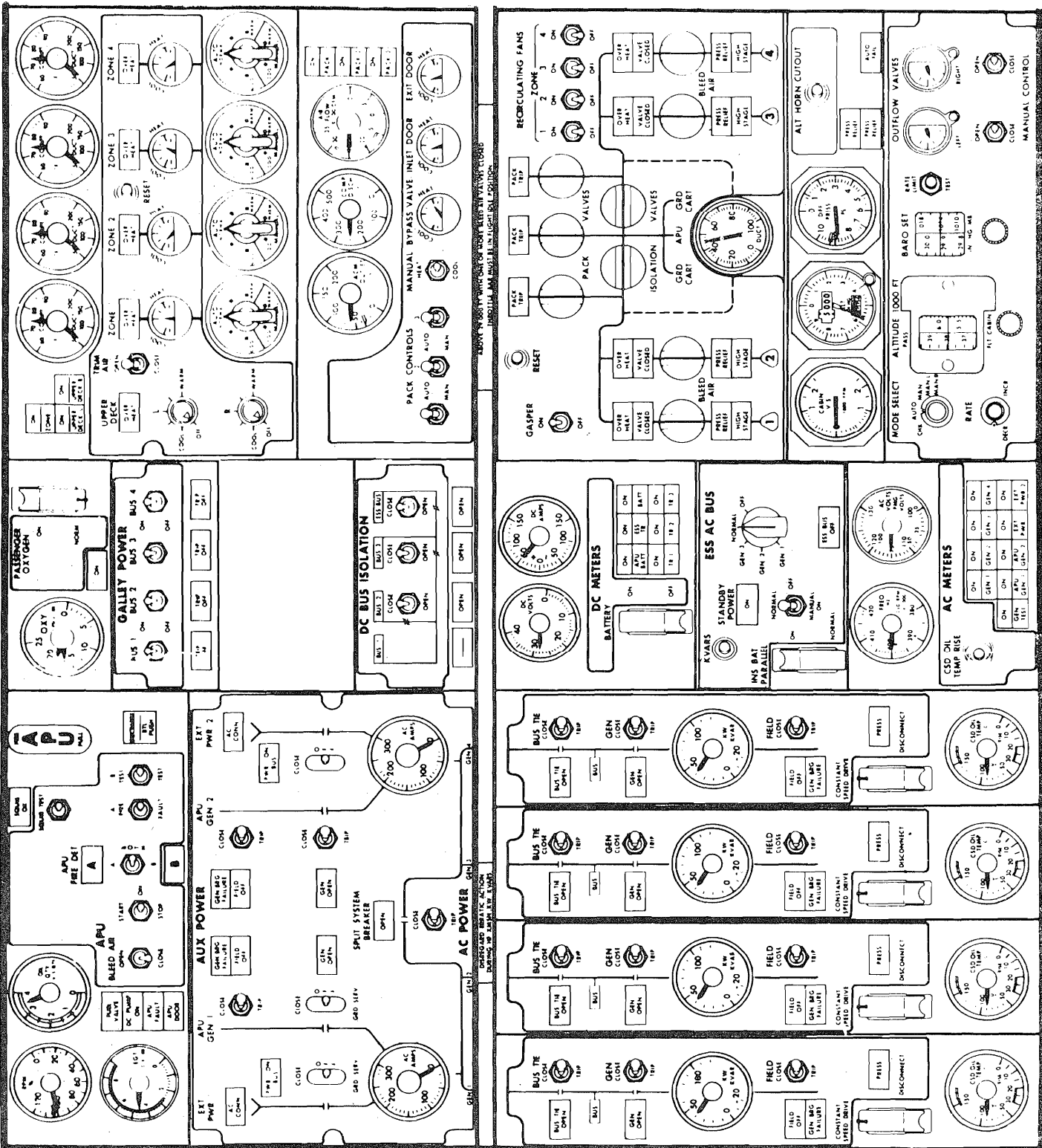

LEFT HALF

FLIGHT ENGINEER'S INSTRUMENT PANELS – UPPER

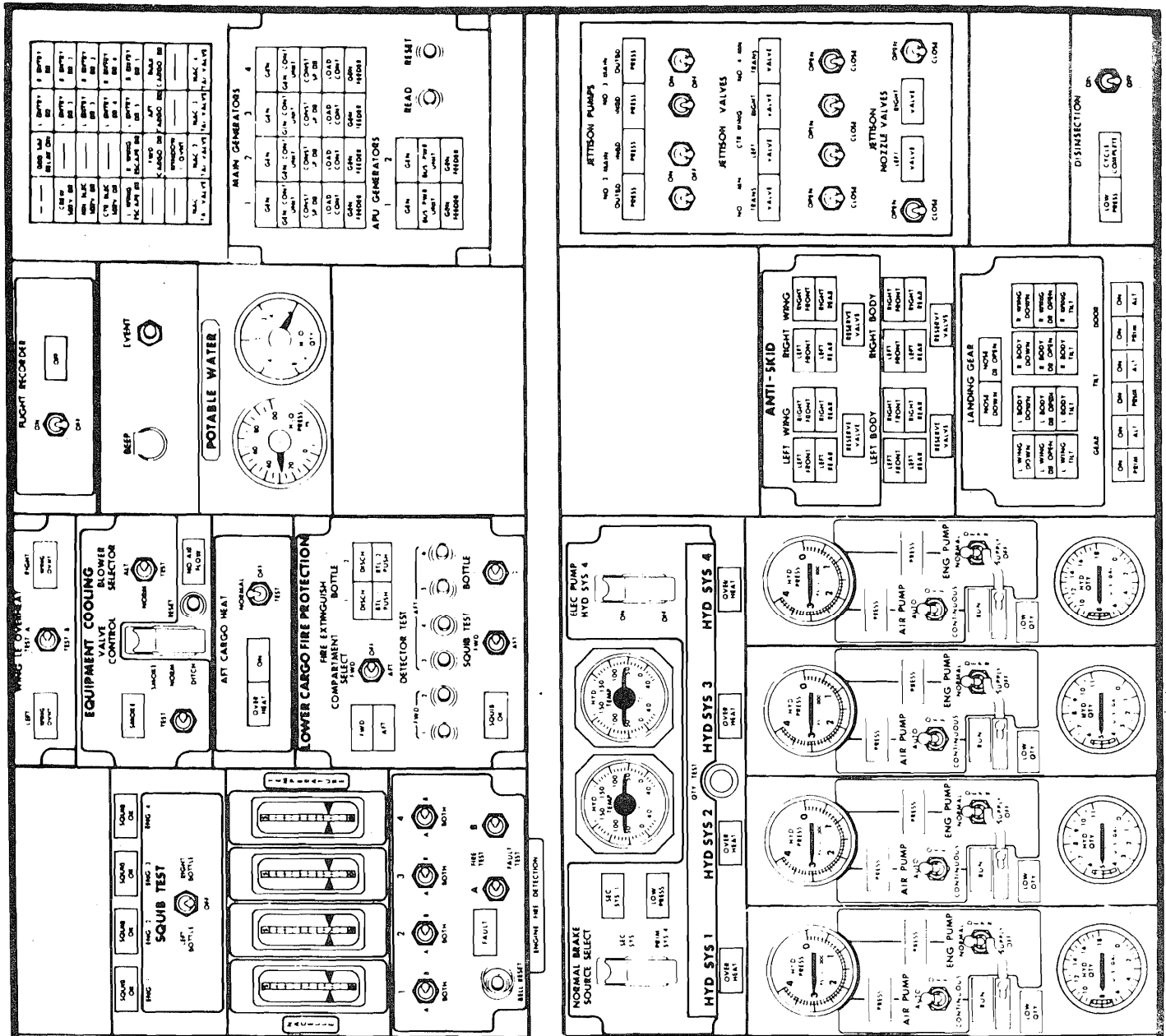

FLIGHT ENGINEER'S INSTRUMENT PANELS - UPPER

RIGHT HALF

DESCRIPTION

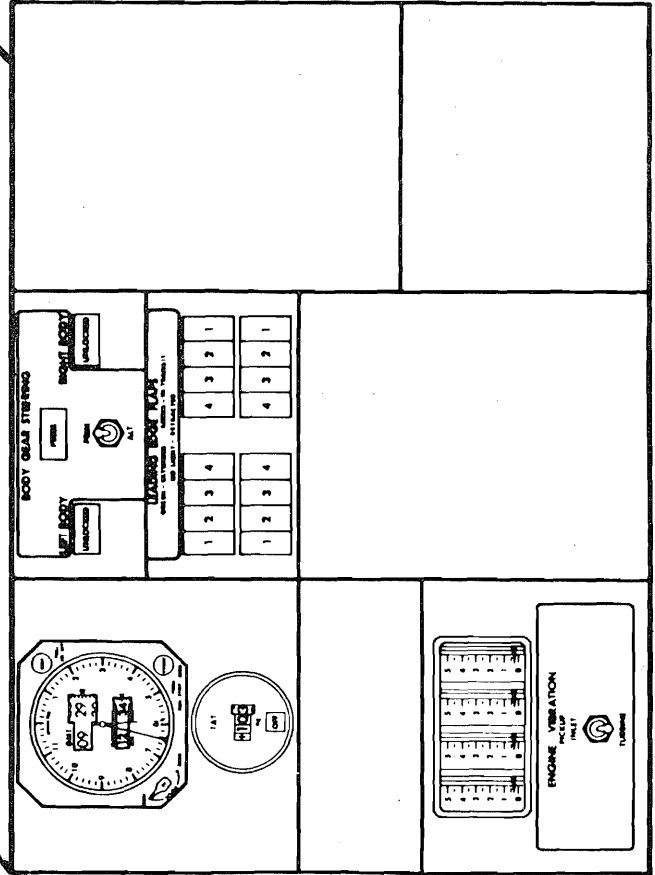
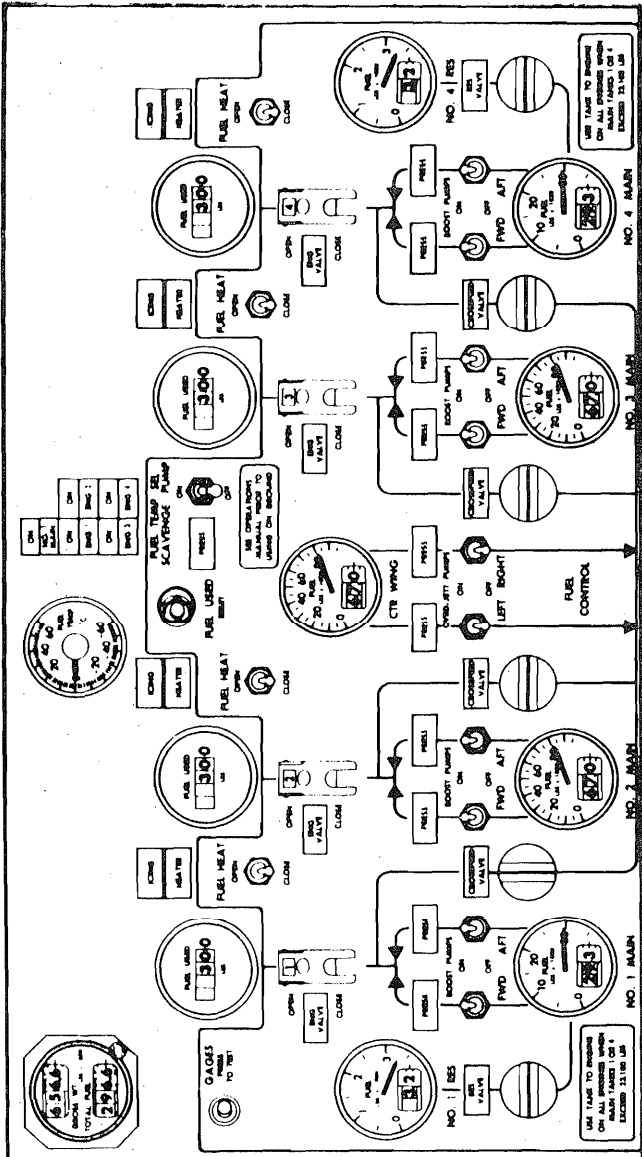

**FLIGHT ENGINEER'S
INSTRUMENT PANELS —
LOWER**

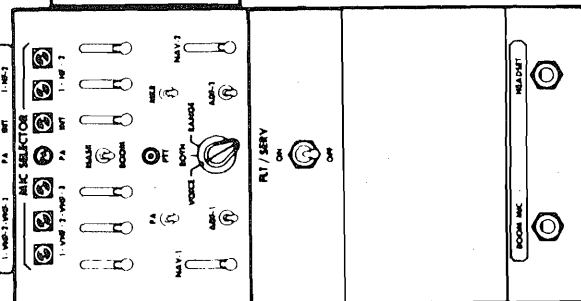
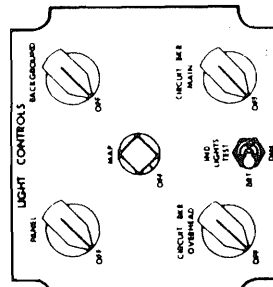
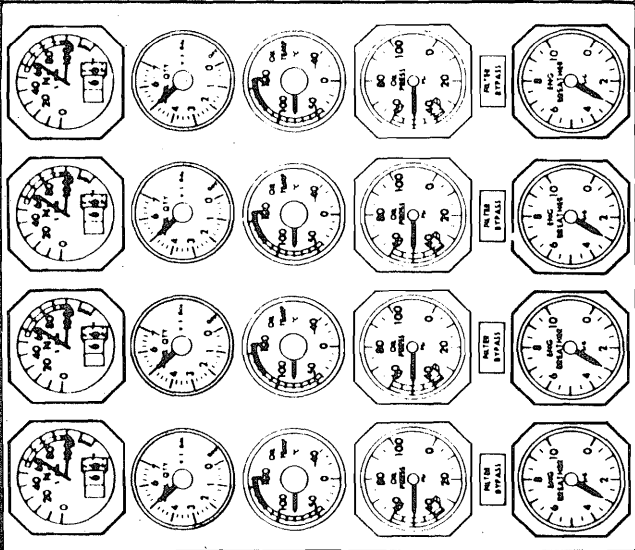

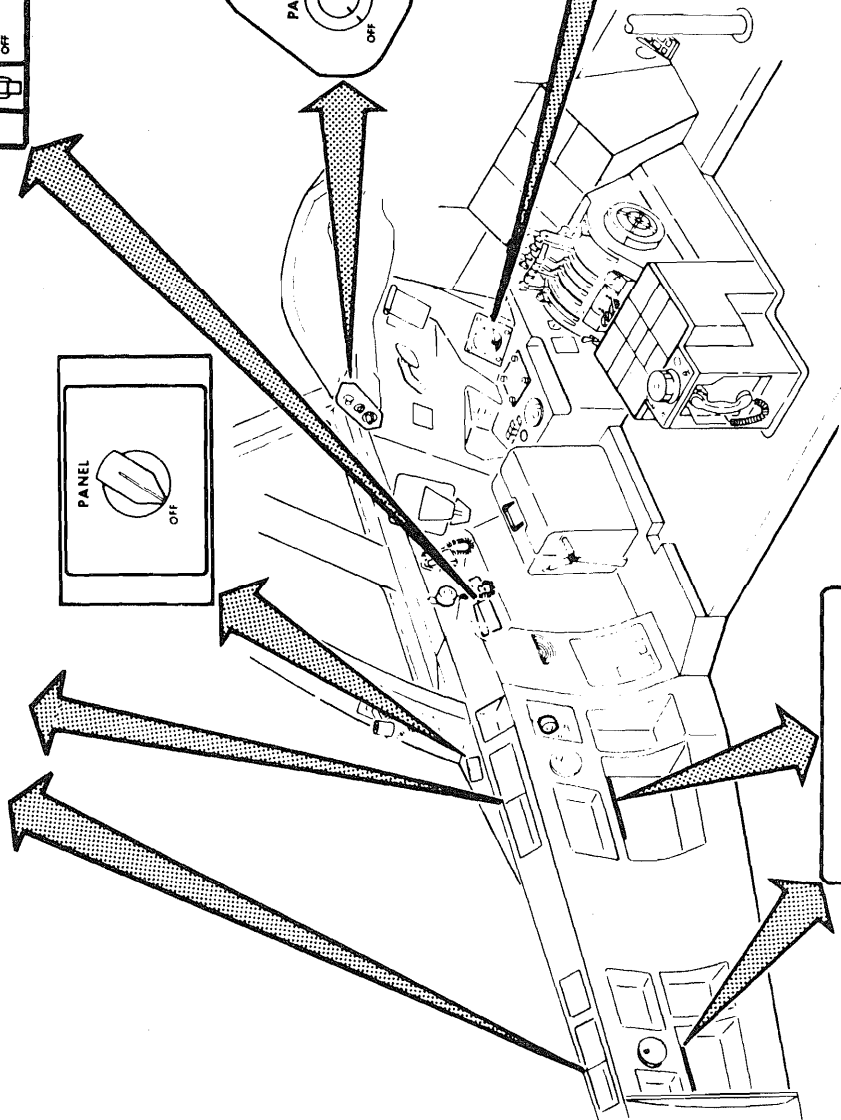
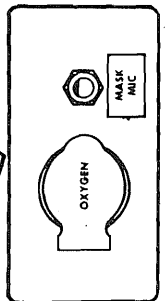
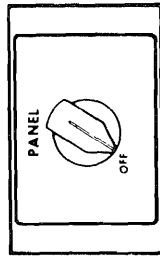
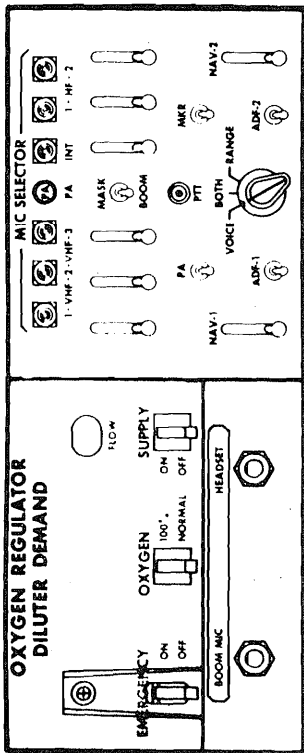
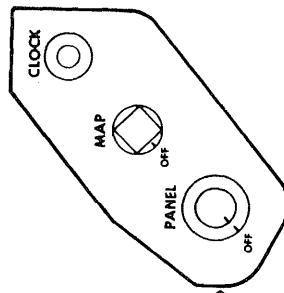
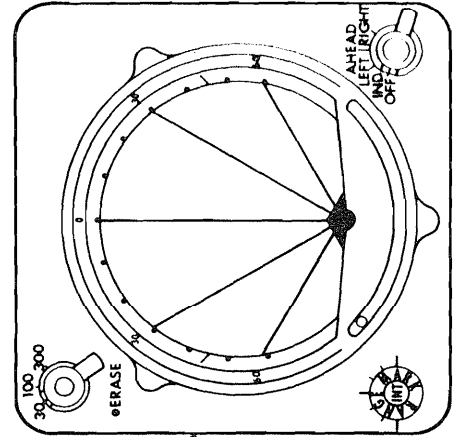
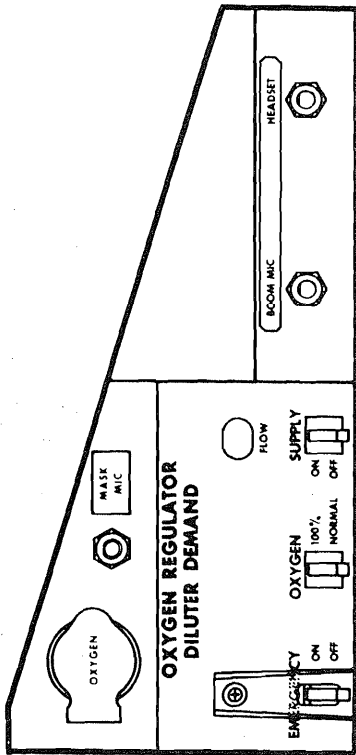

PILOTS' AUXILIARY AND OBSERVERS' PANELS

DESCRIPTION

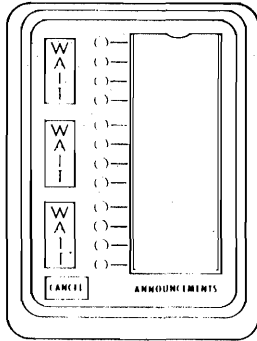

STATION 1R

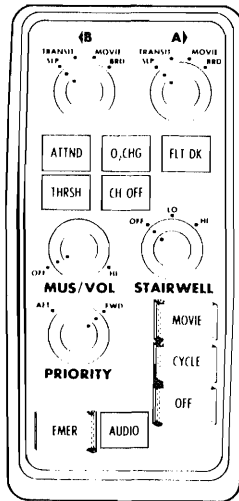

STATION 1L

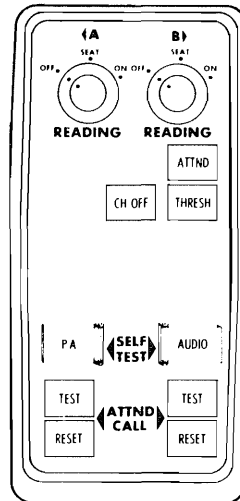

STATION 1R

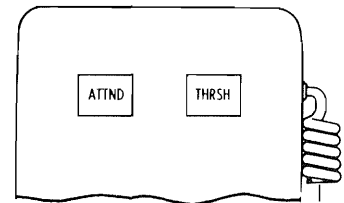

STATION 5R

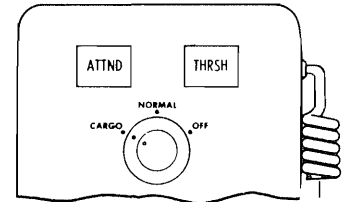

STATION 5L

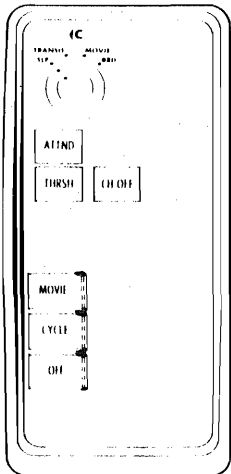

STATION 2L

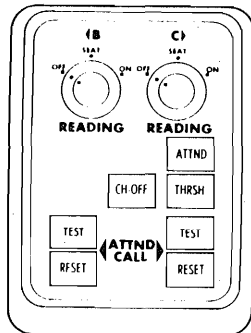

STATION 2R

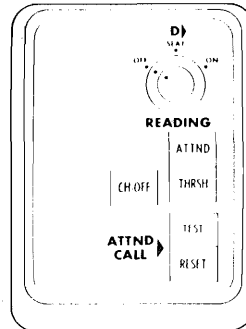

STATION 3R

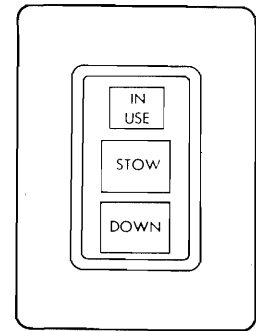

DUMBWAITER

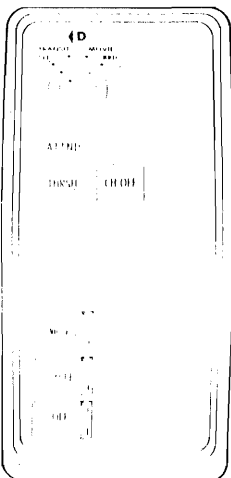

STATION 3L

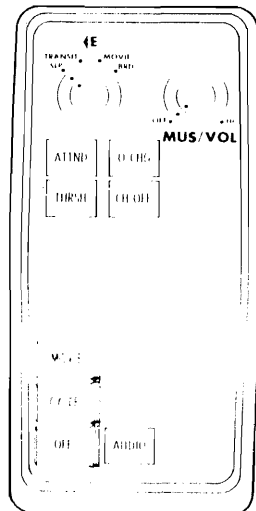

STATION 4L

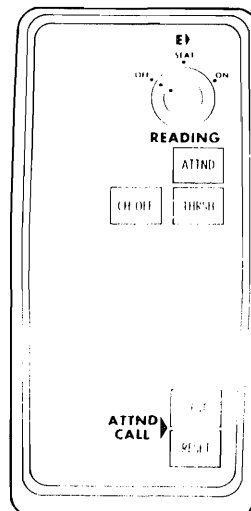

STATION 4R

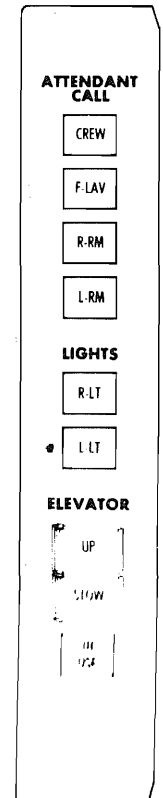

STAIRWELL

FLIGHT ATTENDANTS' PANELS