

ASSEMBLY INSTRUCTIONS

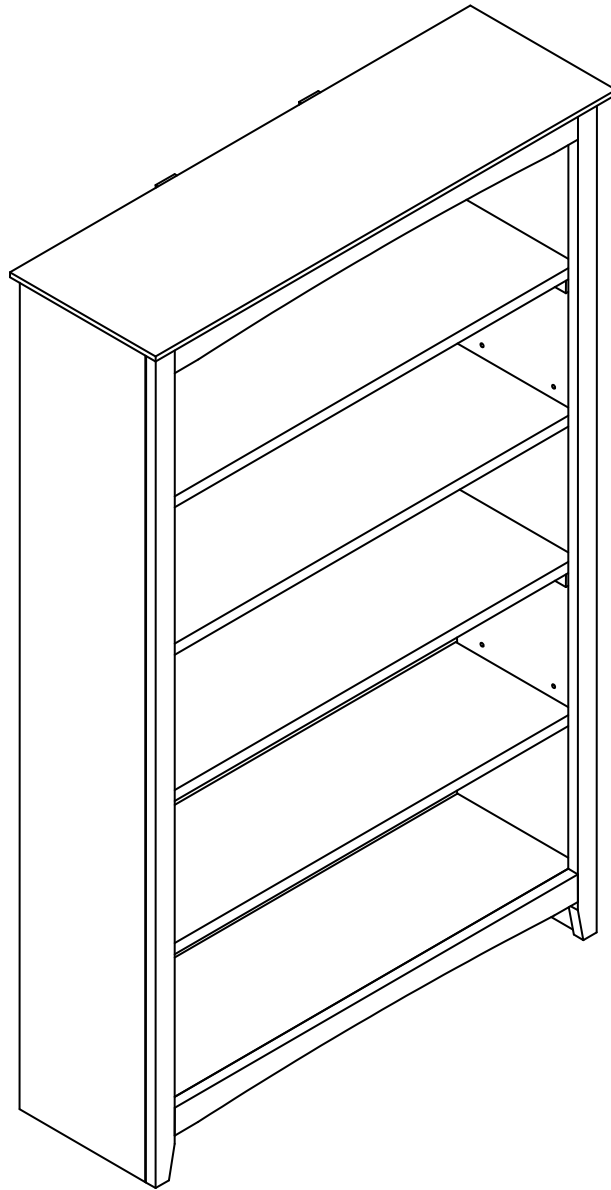

WARNING!

Serious or fatal injuries can occur from furniture tip over. Use tip over restraint (provided) to secure this product to the wall.

Description : 38 X 12 X 60 HIGH BOOK CASE
Item No. : SH-38260A

ITEM NO.: SH-38260A
ISSUED DEC 23, 2020

Printed in Vietnam

BEFORE ASSEMBLY

Thank you for purchasing this quality product. This product has been designed for easy assembly and constructed for durability. All parts were checked prior to packaging to insure quality. Prior to beginning assembly, however, make sure all parts and hardware are included and free of obvious defect. If a part is missing or defective, please contact the store where purchased. If hardware is missing, or you need help with assembly, please call toll free 888-944-8396.

IMPORTANT NOTE:

- Place all wooden parts on a clean and smooth surface such as a rug or carpet to avoid the parts from being scratched.
- Remove all wrapping material, including staples & packing straps before you start to assemble.
- DO NOT tighten all screws and bolts until completely assembled.
- Keep all hardware parts out of reach of children.

WARNING:

Long exposure to rubber or soft plastic may cause a chemical reaction and damage the finish of your product. Protect the surface of the product with cloth if you are using any product with rubber feet or base.

ASSEMBLY TOOLS REQUIRED NOT INCLUDED





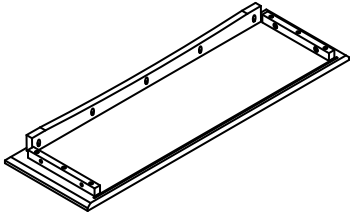
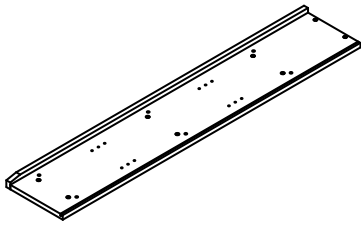
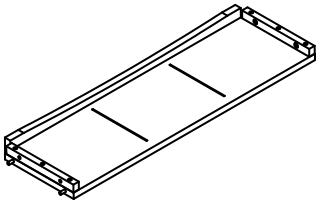
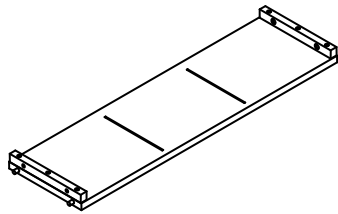
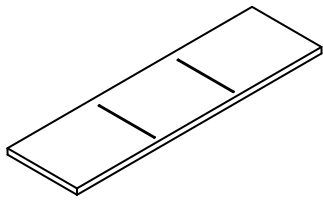
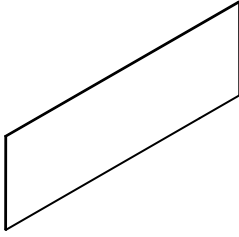
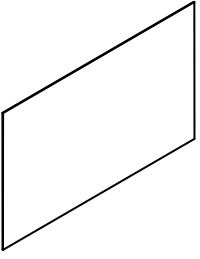
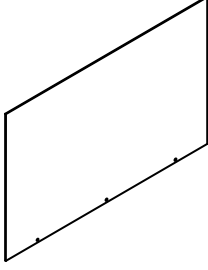
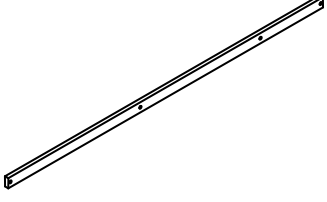

PART LIST

When unpacking, please be careful not to discard any parts with the packaging. Before continuing, please make sure you have all of the following parts:

NO	Description	Q'ty	Sketch	NO	Description	Q'ty	Sketch
A	Top	1		B	Side panel (L-R)	2	
C	Bottom panel	1		D	Shelf panel	2	
E	Adjustable Shelf	2		F	Back Upper (Smaller)	1	
G	Back Center	1		H	Back Lower	1	
I	Connector	2					

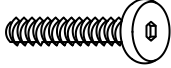
HARDWARE LIST

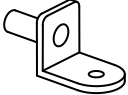
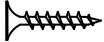
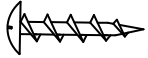
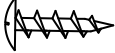
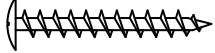
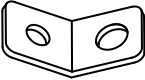
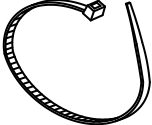
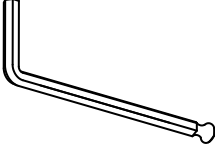
When unpacking, please be careful not to discard any parts with the packaging. Before continuing, please make sure you have all of the following hardware:

NO	Description	Qty	Sketch	NO	Description	Qty	Sketch
1	Bolt (M6 x 30mm)	16		2	Spring Washer ($\Phi 6.5 \times 11\text{mm}$)	16	
3	Small Flat Washer ($\Phi 6.5 \times 13\text{mm}$)	16		4	Shelf support bracket	8	
5	Short Screw (M3.5 x 15mm)	8		6	Medium Pan head Screw (M4 x 20mm)	17	
7	Short Pan head Screw (M4 x 15mm)	2		8	Long Pan head Screw (M4 x 50mm)	2	
9	Steel Tip Bracket	4		10	Flat Nylon Tie	2	
11	Allen Key (M4 x 30mm x 110mm)	1		12	Large Flat Washer ($\Phi 6.5 \times 19\text{mm}$)	6	

STEP 1

Attach side panels (B) to the top (A), and shelf panels (D) and bottom panel (C) with bolts (1), and washers (2) and (3) as shown below. Tighten with Allen key (11).

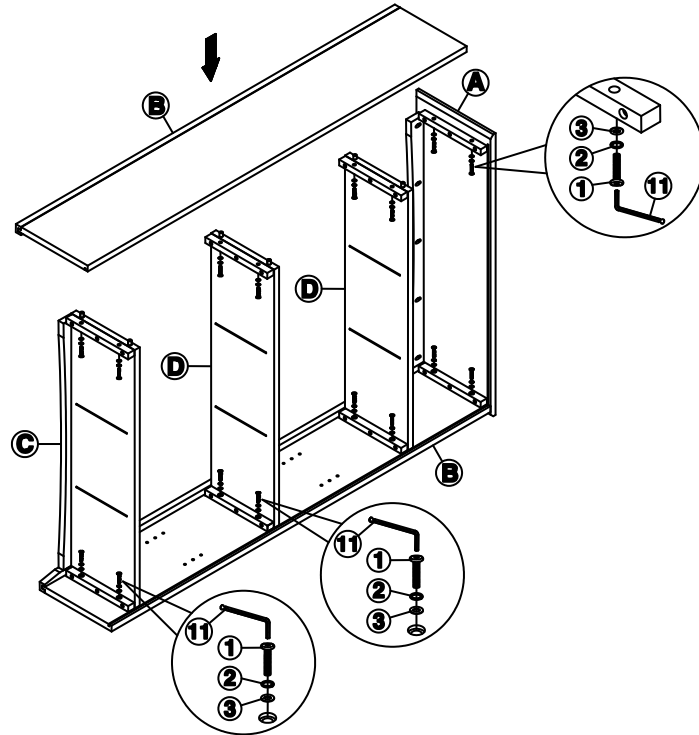

STEP 2

Slide back panels (F), and (G) and (H) into the grooves as shown below.

Attach back panels (F), and (G) and (H) to the unit with pan head screws (6) and washers (12). Tighten with a screwdriver.

Attach connectors (I) to the unit with pan head screws (6) as shown below. Tighten with a screwdriver.

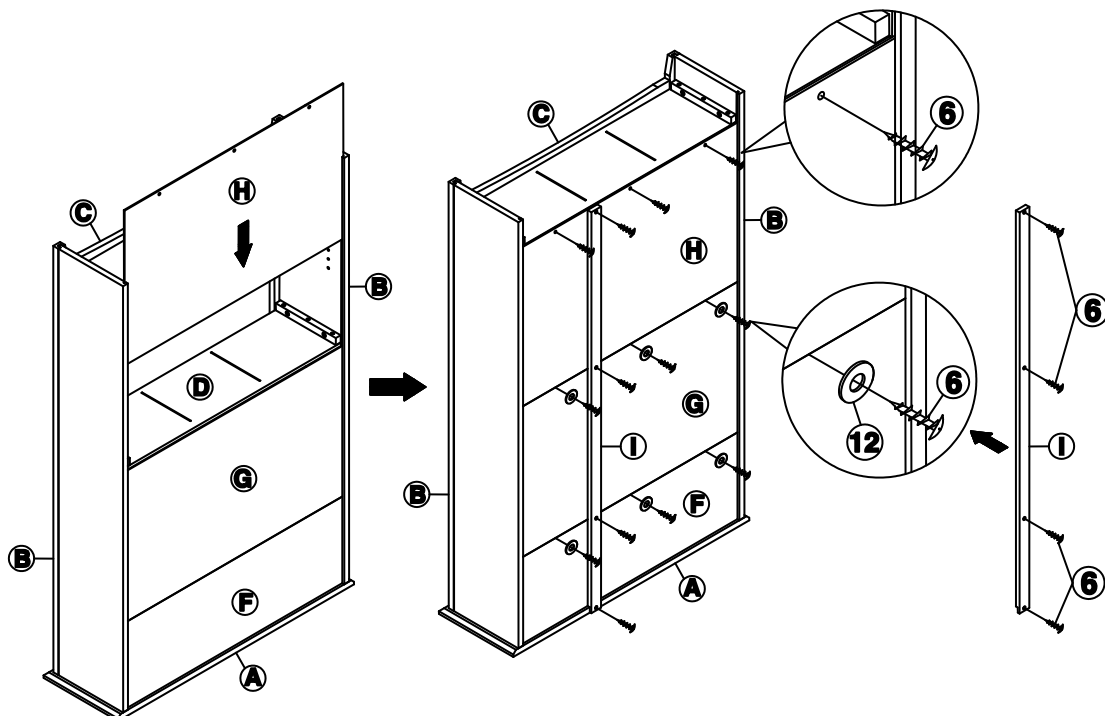

STEP 3

Attach brackets (4) to the unit as shown below. Then place shelves (E) on the brackets and attach with screws (5). Tighten with the screwdriver.

Attach brackets (9) to the back of the unit with screws (7) through the smaller holes in the brackets as shown below.

Important!

Properly attach the other brackets (9) to the wall in an area of ***drywall or plaster with a wood stud***: Mark the attachment point(s) with a pencil at the appropriate height **positioned over the wood stud(s) in the wall**.

Place the unit into position so both mounting brackets are vertically in line.

Properly attach the other brackets (9) to the wall stud with screws (8) through the smaller holes as shown below.

Lace the end of flat nylon ties (10) through the larger holes in each mounting bracket. Bring both ends together and slide the flat ends through the locking ends and draw it through until all slack is removed.

Confirm that the strap is securely laced and locked.

