

BUSTER + PUNCH

BUSTER BULB / TEARDROP

TECH SPEC



BUSTER BULB

The World's first designer LED bulb. This bulb consumes just 1/20th of the energy of traditional bulbs with a life span of 30,000 hours. Available in CRYSTAL, GOLD or SMOKED finish. The resin light pipe at the centre of the bulb is where all the magic happens, allowing the bulb to create a subtle ambient light whilst at the same time throw focused spot light onto tables & surfaces below. The bulb fits in any B22 screw light fitting, but looks especially great when teamed up with our HEAVY METAL or HOOKED lighting ranges.



busterandpunch.com
info@busterandpunch.com

BUSTER + PUNCH

BUSTER BULB / B22 SOCKET / NON-DIMMABLE

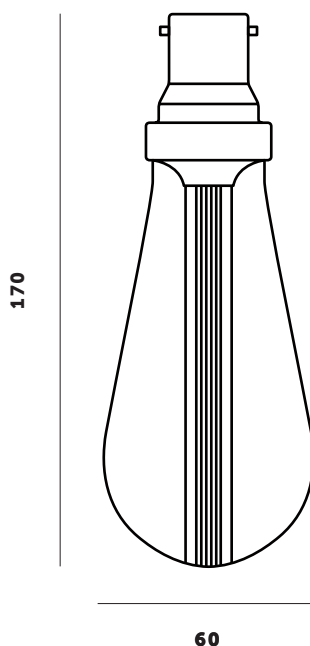
TECH SPEC



<p>FINISH</p>	<p>SKU</p>
<p> Crystal / Non-Dimmable</p> <p> Gold / Non-Dimmable</p> <p> Smoked / Non-Dimmable</p>	<p>BB-TD-B22-ND-CR-B</p> <p>BB-TD-B22-ND-GO-B</p> <p>BB-TD-B22-ND-SM-B</p>
<p>SPECIFICATIONS</p>	
<p>Power: 2W Type: Non-Dimmable LED Screw fitting: B22 Supply: 120-240 VAC Life: 30 000 hrs Lumen: crystal 125, gold 100, smoked 75. Light appearance: crystal 2700k, gold 2500k, smoked 2600k. CRI: 80</p>	<p>Power factor: 0.5 CE certified. For indoor use only.</p>

CARE INSTRUCTIONS

Wipe with damp cloth with no loose hairs, avoid using any chemicals. Please note all finishes are prone to aging.

* Official data doc can be supplied upon request.

SPECTRAL IRRADIANCE AT 3M

2W NON-DIMMABLE

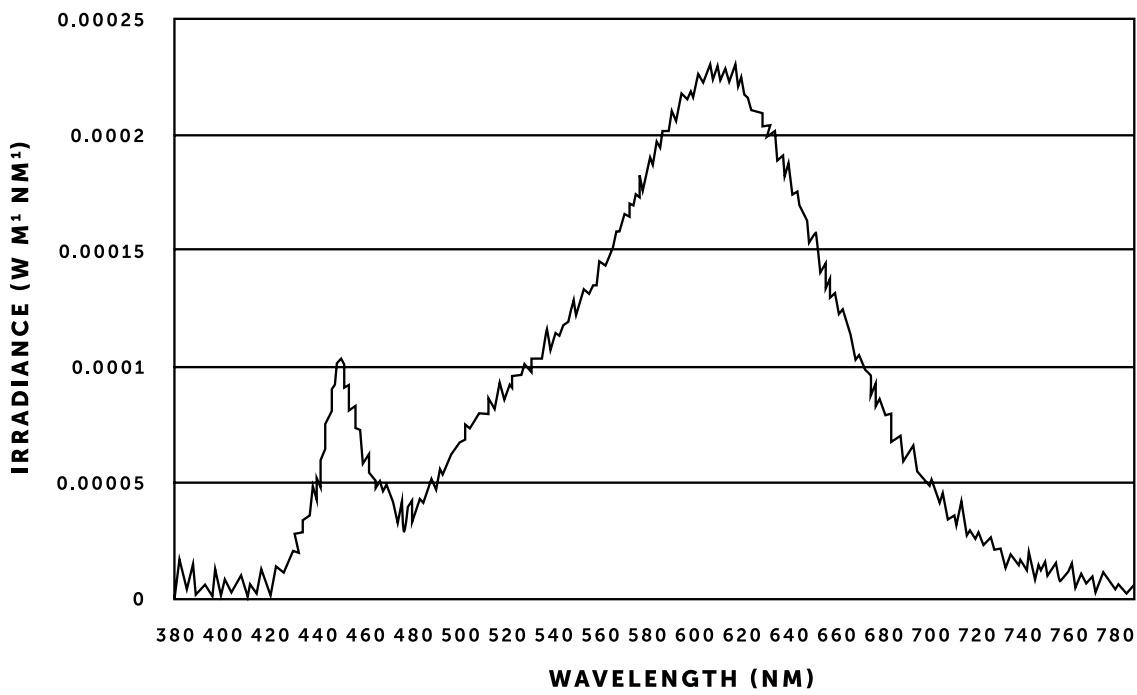

busterandpunch.com
info@busterandpunch.com

POLAR CANDELA DISTRIBUTION

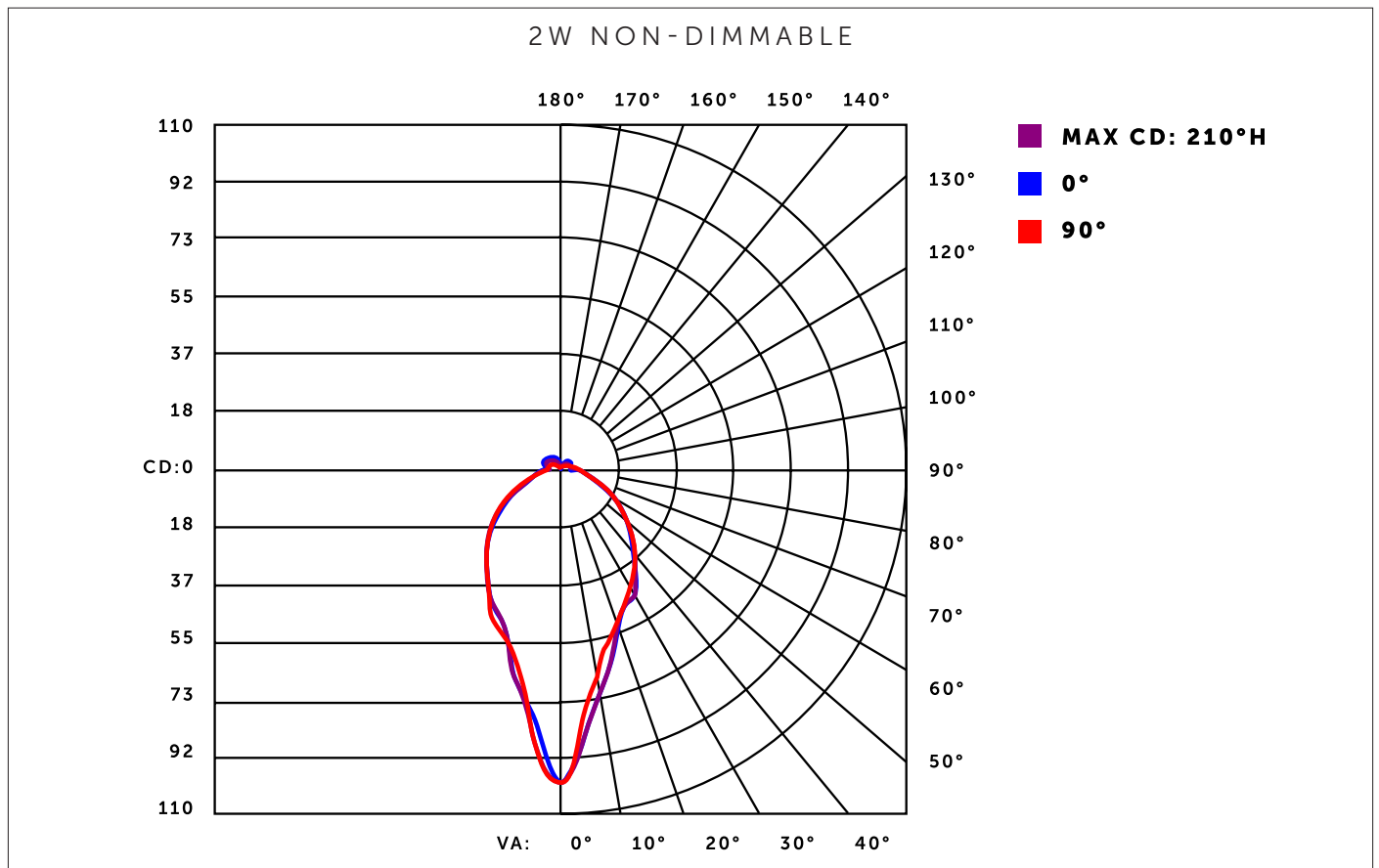

busterandpunch.com
info@busterandpunch.com

CRI 1931

2W NON-DIMMABLE

CIE 1931 Chromaticity Cx: 0.4668
CIE 1931 Chromaticity Cy: 0.4179

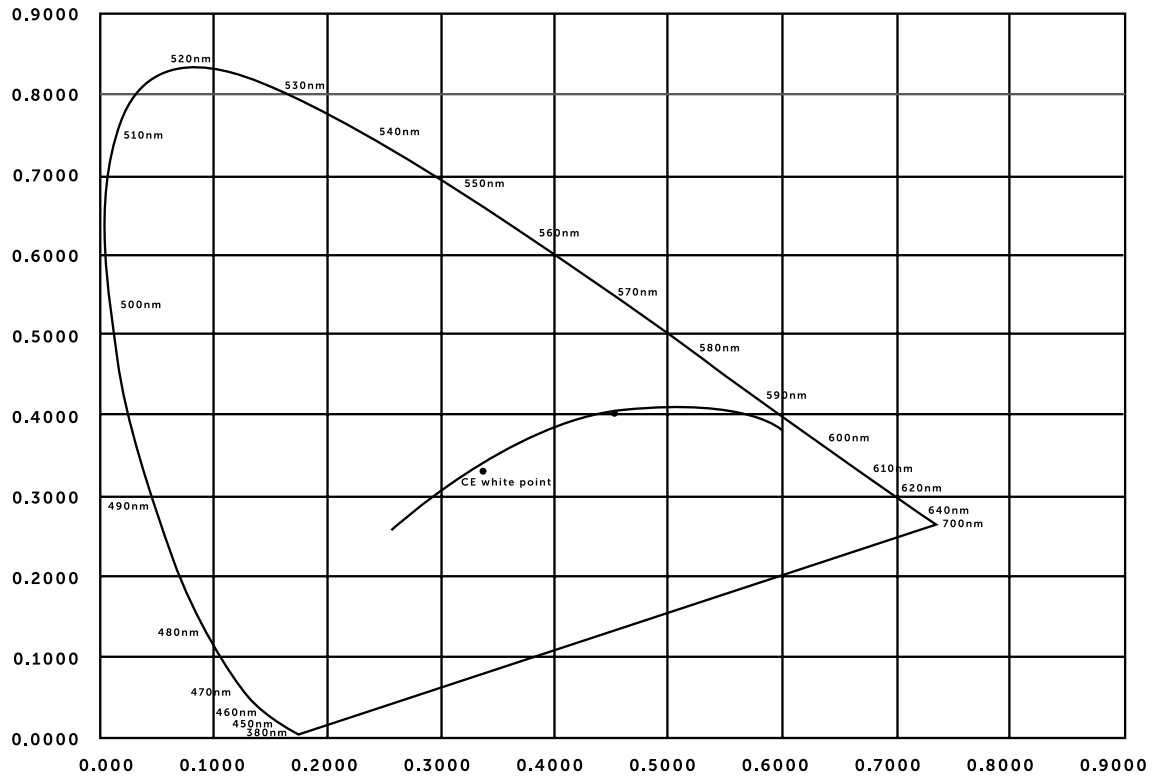

busterandpunch.com
info@busterandpunch.com