

# RVH8110

TOPMOUNT KITCHEN SINK

**RUVATI**<sup>®</sup>  
SPECIFICATION SHEET

## MATERIAL

True 16 Gauge Thickness  
Premium T304 Grade Stainless Steel  
18/10 Chromium/Nickel Content  
Commercial Brushed Finish

## FEATURES

- Heavy duty sound guard padding and undercoating
- Slanted bottom with elegant drain grooves for easy draining
- Small size sink for wet bar

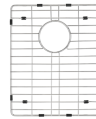

## IN THE BOX



Basket Strainer  
[RVA1025]



Mounting Clips  
[RVA11042]

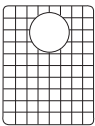

Rinse Grid  
[RVA68110]



Cut-out  
Template

## NOMINAL DIMENSIONS

**Exterior:** 15" (wide) x 20" (front-to-back)  
**Interior Bowl:** 13" (wide) x 16" (front-to-back)  
**Bowl Depth:** 10"  
**Minimum Cabinet Size:** 18" wide  
**Drain Hole Size:** 3½"

## Installation Type:

Topmount

## Inside Corners:

Zero Radius

## Drain Location:

Rear Center

**RUVATI USA**  
www.ruvati.com

Phone: 1.855.478.8284  
Email: support@ruvati.com

# OPTIONAL ACCESSORIES (SOLD SEPARATELY)



Deep Basket  
Disposal Flange  
[RVA1049ST]



Drain Cover  
[RVA1035]

## DIMENSIONS

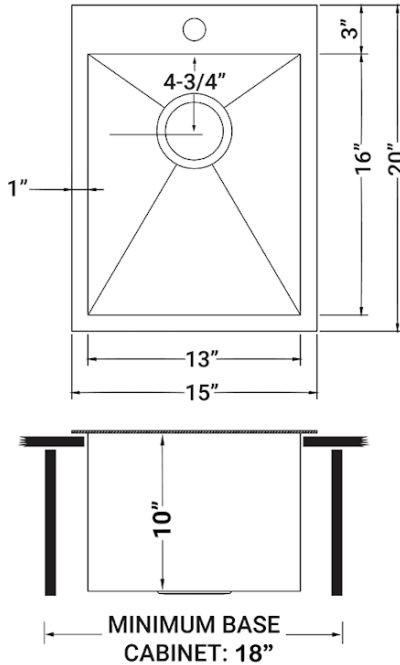

Register your product at [www.ruvati.com/register](http://www.ruvati.com/register).