



# SC - 78 4 Channel Valve USB Playback Audio Interface



Operation manuel



# Sc78 -Features:

- 24bit 192kHz \*audio with twin valve output stages shock proof.
- New unbreakable mini valves from the 60's.\*\*
- Long valve life with around 3-5 years of operation before changing.\*\*\*
- Audiophile grade USB interface found in the world best converters.
- 4 Channels of high quality playback. Great for Ableton/Traktor/Dex/DJ Pro
- High quality Burr Brown converters with 112db SNR & Dynamic range.
- Ultra Low noise/distortion pre-amps @0.001% with 22dBu headroom.
- Audiophile grade Jantzen output capacitors.
- High channel separation @135db giving superb spacial imagery.
- Powerful HiFi headphone amp with 480 mw into 32ohm, with select switch.
- Twin analogue VU meters, showing output level.
- Twin mini-jack aux input to use the valves stage as a pre-amp.
- Convenient portable 1U half rack case.

\* 24bit @ 192K for PC & Mac, higher sample rates available for the Mac

\*\* Valve guaranteed against breakage, from accidental dropping

\*\*\*Based on regular usage of 2-3 hours per day, 3-5 days per week.

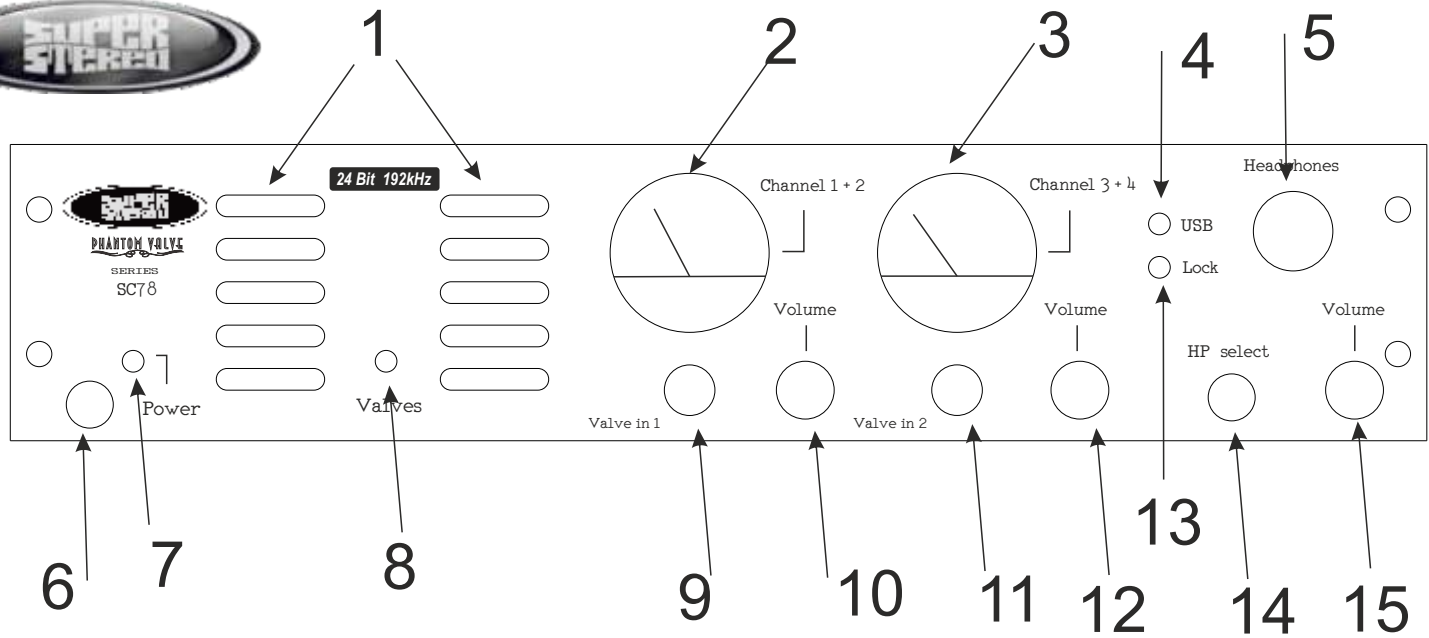

1. Air vents.

2. Channel 1 & 2 VU meter.

3. Channel 3 & 4 VU meter.

4. USB plugged LED.

5. 1/4" Headphone jack.

6. Power switch.

7. Power LED.

8. Valves warm up LED.

9. 3.5mm aux input jack.

10. Channel 1&2 level control.

11. 3.5mm aux input jack.

12. Channel 3&4 level control.

13. Sample rate lock LED.

14. Headphone monitor select.

15. Headphone volume control.



1. USB input plug.
2. Channel 1 & 2 RCA outputs
3. Channel 3 & 4 RCA outputs
4. 12 v AC input. 2.5mm connector.



# Sc78 -Quick start.

- Plug in the mains PSU and connect to the AC input on the rear panel.
- Ensure the volume controls are at zero.
- Plug in the USB cable ensure the USB light is on, for Mac no drivers are needed.
- For PC, download from [www.superstereo.co.uk](http://www.superstereo.co.uk) and follow install procedures.
- Switch on the Sc78 and ensure the power light is on.
- Wait around 1 minute for the valves light to go out, while the valves warm up.
- Once drivers are loaded, the lock light will come on, see setup for sample rate indication.
- Connect the RCA outputs 1 & 2, 3 & 4 to your mixer or speakers as required.
- Default playback will be on channels 1 & 2.
- Adjust output levels as required, the VU meters show the level of output.
- Connect headphones as required, and select monitoring channels with the select switch.
- Your sound card is now ready to use.



# USB Setup for Mac OSX

1. Plug in the soundcard with USB cable to available port.
2. No extra drivers required. Plug and play for OSX
3. Go to system preferences, Sound. Select Superstereo as output.
4. To setup sample rates and outputs:  
goto Applications - Additional settings  
- Select Audio Midi setup.
5. Select Superstereo.
6. To change output levels, adjust master level.
7. To change L & R of output 1, adjust 1 or 2.
8. Output 3 & 4 appears as Front centre and Low or sub output. These named outputs can vary depending on OS version. Their levels are adjusted by master level.

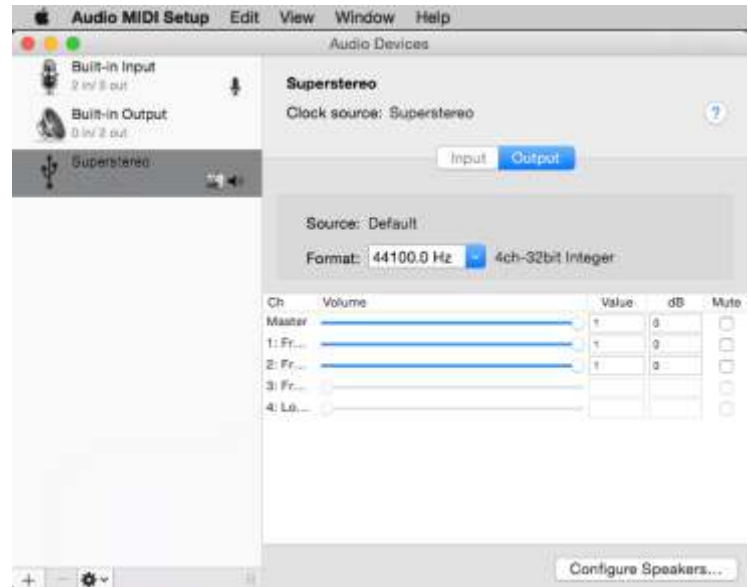



# USB Setup for Mac OSX

9. To adjust sample rates, select drop down box, and select the sample rate you require.

frequencies are indicated by the Lock LED:

- 44.1khz - Blue
- 48khz - Green
- 88.2khz - Turquoise.
- 96khz - Red
- 176.4khz - Orange
- 192Khz - Purple

44.1 khz is compatible with all systems and playback, which is the standard CD quality frequency.

96khz is recommended for most DJ and music software.

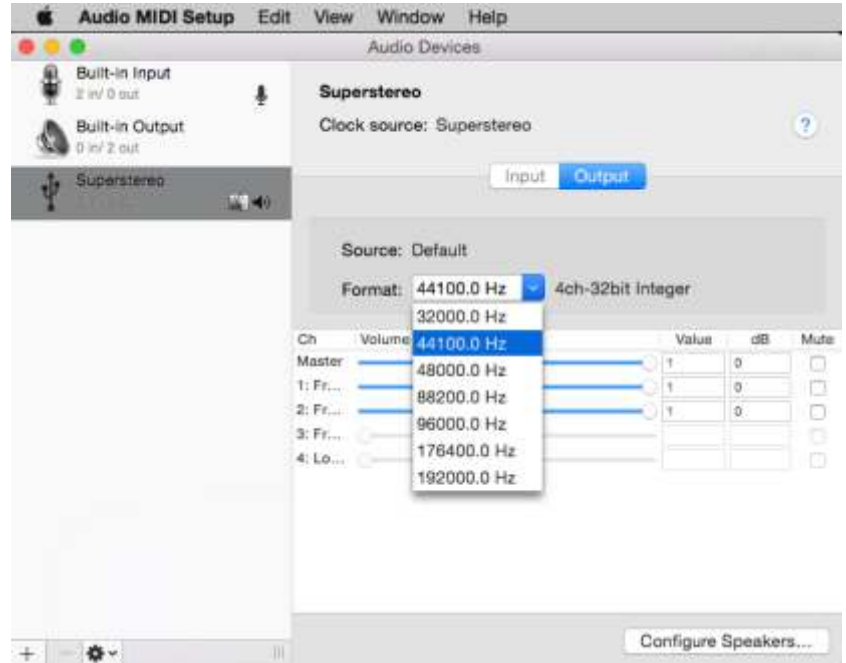



# USB Setup for Mac OSX

10. For 2 & 4 channel operation Select-configure speakers
11. For 2 channel operation select stereo, then select required outputs .
12. For four channel operation select quadraphonic.
13. Any output can be selected. Once set, click apply and done.
14. Your Sc78 is now ready to use.
15. Go to your playback software and select outputs as required.







# USB Setup for Windows

1. Goto [www.superstereo.co.uk](http://www.superstereo.co.uk) and download windows drivers.
2. Extract ZIP files to a folder.
3. Open folder Superstereo windows driver
4. Run Setup32.exe for 32 bit systems
5. Run Setup64.exe for 64bit systems

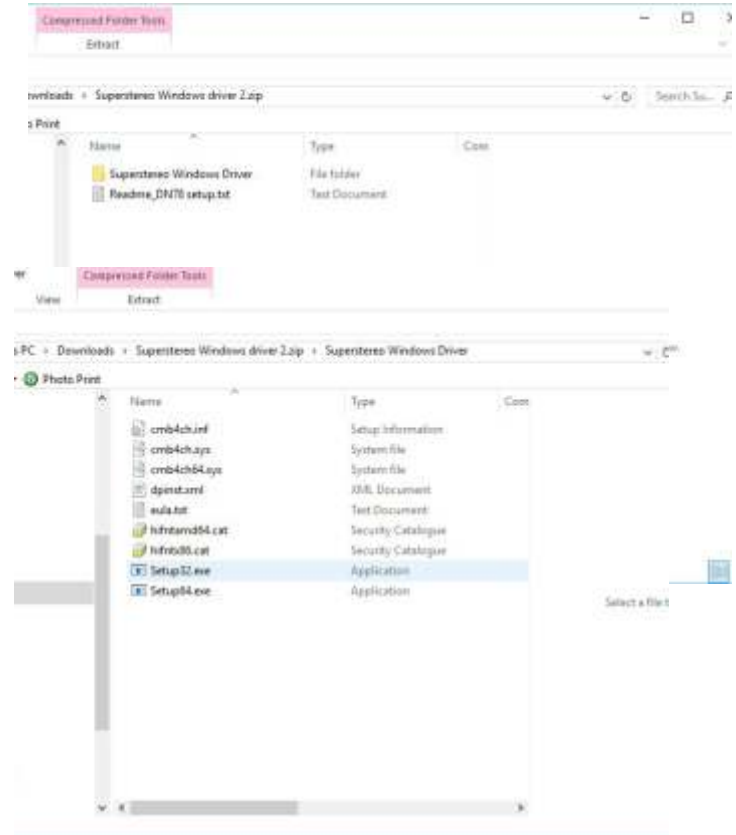



# USB Setup for Windows

6. Click Yes to run driver setup wizard.
7. Click finish once the setup has finished.
8. Plug the sound card into any available port on your computer.
9. Ensure the USB light and Lock lights are
10. Your Sc78 is now ready to use.

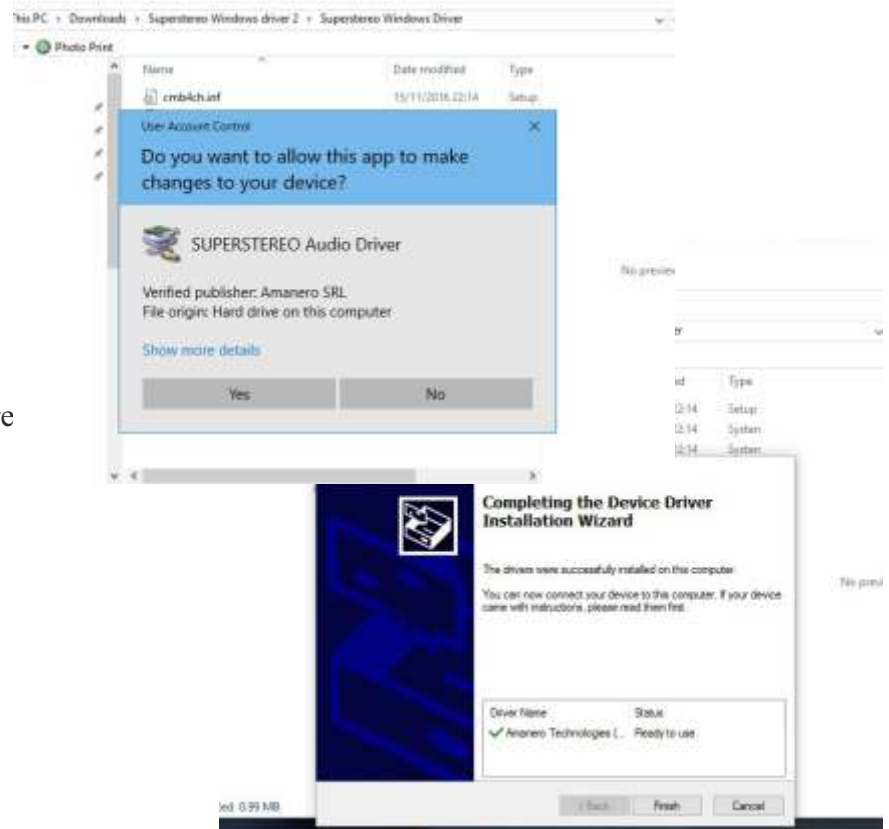



# USB Setup for Windows

1. To change sample rates and outputs.
2. Go to Hardware and sound. Select Sound.
3. Select Superstereo and click on Configure.
4. For stereo operation, select stereo.
5. For four channel operation, select quadraphonic.
6. Click next, then select Full-range speakers Front L&R
7. Click box surround. Click next. Then finish.

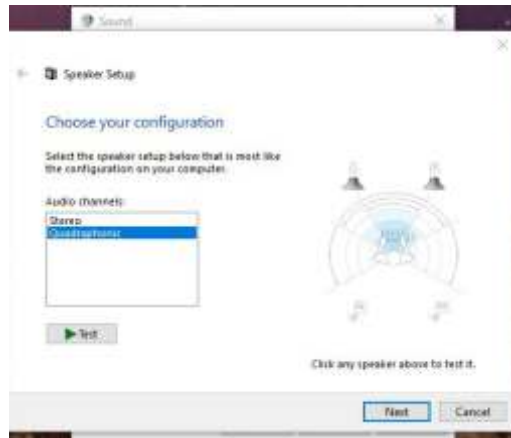



# USB Setup for Windows

8. Then click properties. Click advanced.
9. Select the desired sample rate from the drop down box the click ok
10. For most software that uses multiple outputs, select Windows WASAPI mode, for best results.

Frequencies are indicated by the Lock LED:

- 44.1khz - Blue
- 48khz - Green
- 88.2khz - Turquoise.
- 96khz - Red

44.1 khz is compatible with all systems and playback, which is the standard CD quality frequency.

96khz is recommended for most DJ and music software.

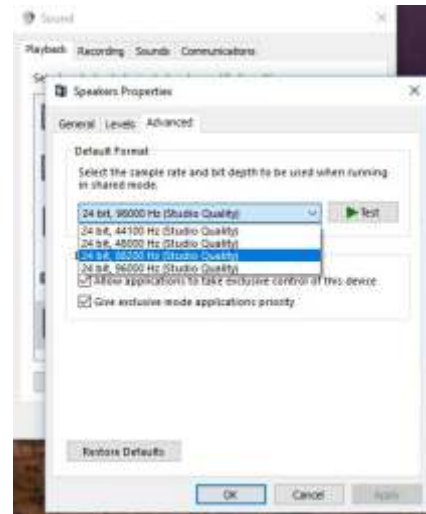



# SC 78 Block diagram.

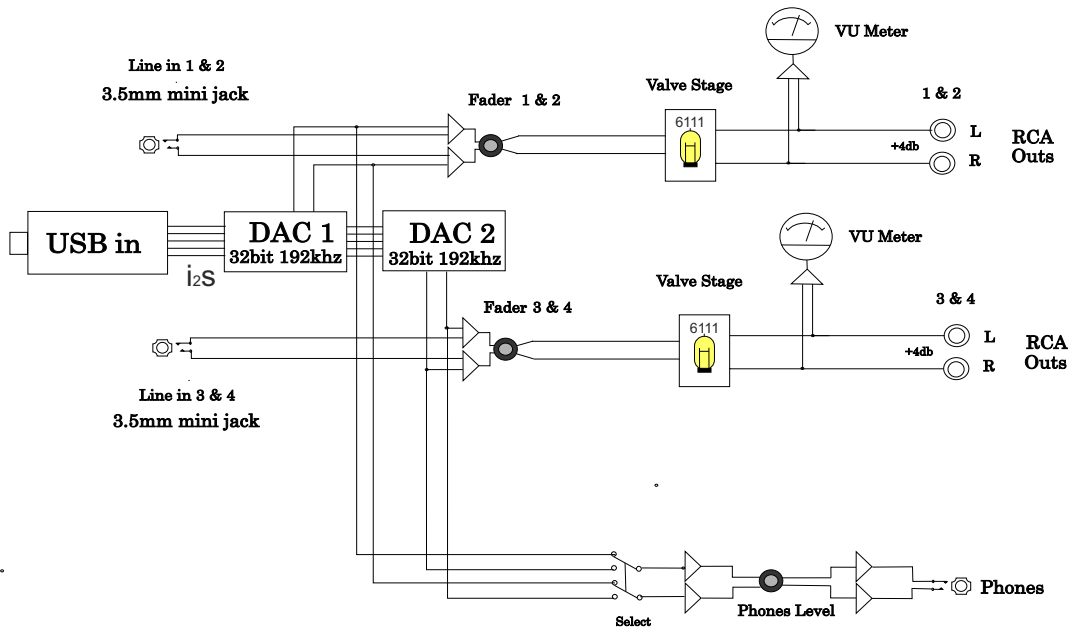



# Technical specifications.

## USB & DACS:

24bit 192kHz Burr brown DACs x 2 . Dynamic range 112db  
SNR 112db. THD+N @ -1dBfs -93 db. Low latency 3.5f/s - 8 x oversampling  
Sample rates 8khz to 384khz (capped @ 192khz) Bit rate upto 32bit.  
Channel separation 48Khz - 192Khz - @110 db. SNR - 116db

## Valves & Pre-amps

Valve THD 0.01 % average, shock rating @ 450G. Ave plate Voltage 70V. Low vibration with damping rings.  
Warm up time 80 seconds Ave. Maximum output level +15db x 4, RCA outputs x 4 @ 470k impedance.  
Burr-brown pre-amps, Low noise @ 0.0001%, headroom +23db, Channel separation 135db  
Valve life 8000 - 140000 hours. Ave 3500 on/off cycles.

Headphone amp- 16 ohm to 300 ohm. Max output 650mw into 16 ohm to 110mw into 300 ohm.  
Crosstalk -112db. SNR 128db -32ohm. THD @ 32ohm, f=1k @ 150mw - 101 db.

Twin analogue VU meters, showing summed L&R output level @ -0db. Output @ +4db over reading.  
Twin mini-jack aux input impedance @ 1K ohm. Gain from -20db to +10db.

Power: 12V ac from supplied wall adapter. 18 watts @ 240v. Universal adapter 110v / 240v switchable 20VA.  
Weight: 750 grams.(ex adapter) Dimensions: 200 mm x 46 mm x 100 mm



# Operational usage & troubleshooting.

Average operating times should be at least 1 hour after switch on and no longer 6 hours at one time. This will ensure the best valve life.

Please ensure good ventilation, do not place your Sc78 on other hot equipment or place other equipment on top of it. The unit will get warm and can get hot to touch depending on the environment temperature. This is normal. It can run up +60 degrees centigrade with out damage.

Long valve life with around 3-5 years of operation before changing. Using our special circuit design and military grade valves, they will last a long time. Once they start to fail, the sound will become quieter and there will be a noticeable change in sound. We can change the valves, simply return the Sc78 to us.

## Troubleshooting:

No power.

Check PSU is plugged in correctly. Check Power connector is pushed in. Try power switch on and off. If no power, the internal fuse may have failed so contact [support@superstereo.co.uk](mailto:support@superstereo.co.uk)

No signal from USB.

1 - Ensure USB cable is pushed in at either end. 2 - try a different cable.

3 - Check both USB and Lock lights are on. 4 - If Lock light is not lit, refer to driver install or re-boot your computer.

If both lock light and USB light is lit, music is playing and no signal is showing: 4 - Check RCA cables are connected and have no internal shorting. 5 - Try headphones and select each channel. 6 - Ensure correct outputs are selected on your computer. 7 - Ensure level on your computer is turned on.

8 - If your computer is showing output levels are on, both lights on the Sc78 are lit, levels are up and still no sound - unplug the USB, Switch off the Sc78 and stop playback. Then re-plug USB, power up Sc78, wait for warm up, ensure both lights are on. This should now re-set the USB interface, now start the playback.

If you still get no sound, repeat procedure after re-booting your computer.